

# Standard indication with Control Panel Convenience



More space saved through compact design

*Multi-input function enables process variety*



*Expandable in accordance with your needs*

Easily mountable

## Model

DCL-3	3	A-□□□□□□□□	Series name: DCL-300 (W22.5 x H75 x D100 mm)
Control action	3		PID
Alarm	A		Alarm type can be selected by keypad. (*1)
Control output (OUT)	R		Relay contact: 1a
	S		Non-contact voltage (for SSR drive): 12 V DC ±15%
	A		Direct current: 4 to 20 mA DC
Input	M		Multi-range (*2)
Power supply			100 to 240 V AC (Standard)
	1		24 V AC/DC (*3)
Option	W(5A)		Heater burnout alarm output (5A) (*4)
	W(10A)		Heater burnout alarm output (10A) (*4)
	W(20A)		Heater burnout alarm output (20A) (*4)
	W(50A)		Heater burnout alarm output (50A) (*4)
	DC		Heating/Cooling control output OUT2
	C5		Serial communication EIA RS-485
	EA		External setting input
	EI		Set value memory external selection

(\*1) Alarm type (12 types and No alarm action) and status Energized/De-energized can be selected by keypad.

(\*2) Thermocouple, RTD, direct current and DC voltage can be selected by keypad.

(\*3) Standard supply voltage is 100 to 240 V AC. Enter "1" after the input code only when ordering 24 V AC/DC.

(\*4) For direct current output type, Heater burnout alarm output cannot be ordered.

### Option Combination (○: Can be used together.)

Option Code	W	DC	C5	EA	EI
W	○	○	○	—	—
DC	○	○	○	○	○
C5	○	○	○	○	○
EA	—	○	○	○	—
EI	—	○	○	—	○

W, EA and EI options cannot be used together.

## Rated Range

Input Type		Input Range	
Thermocouple	K	-200 to 1370 °C	-320 to 2500 °F
	J	-199.9 to 400.0 °C	-199.9 to 750.0 °F
	R	-200 to 1000 °C	-320 to 1800 °F
	S	0 to 1760 °C	0 to 3200 °F
	B	0 to 1760 °C	0 to 3200 °F
	E	0 to 1820 °C	0 to 3300 °F
	T	-200 to 800 °C	-320 to 1500 °F
	N	-199.9 to 400.0 °C	-199.9 to 750.0 °F
	PL-II	-200 to 1300 °C	-320 to 2300 °F
	C(W/Re5-26)	0 to 1390 °C	0 to 2500 °F
RTD	Pt100	-199.9 to 850.0 °C	-199.9 to 999.9 °F
	JPt100	-200 to 850 °C	-300 to 1500 °F
		-199.9 to 500.0 °C	-199.9 to 900.0 °F
		-200 to 500 °C	-300 to 900 °F
Direct current	4 to 20 mA DC [Externally mounted 50Ω shunt resistor]	-1999 to 9999 (*1)(*2)	
	0 to 20 mA DC [Externally mounted 50Ω shunt resistor]	-1999 to 9999 (*1)(*2)	
	4 to 20 mA DC [Built-in 50Ω shunt resistor]	-1999 to 9999 (*1)(*3)	
	0 to 20 mA DC [Built-in 50Ω shunt resistor]	-1999 to 9999 (*1)(*3)	
DC voltage	0 to 1 V DC	-1999 to 9999 (*1)	
	0 to 5 V DC	-1999 to 9999 (*1)	
	1 to 5 V DC	-1999 to 9999 (*1)	
	0 to 10 V DC	-1999 to 9999 (*1)	

(\*1) Scaling and decimal point place change are possible.

(\*2) Connect a 50Ω shunt resistor (sold separately) between input terminals.

(\*3) This input type has a built-in shunt resistor (50Ω).

## Standard Specifications

Display	PV: Red 4-digits, character size; 7.4 x 4.0 mm (H x W)    SV: Green 4-digits, character size; 7.4 x 4.0 mm (H x W)
Input	Thermocouple: K, J, R, S, B, E, T, N, PL-II, C (W/Re5-26) External resistance: 100Ω max. (For B input: 40Ω max.)
	RTD : Pt100, JPt100 3-wire type (Allowable input lead wire resistance, 10Ω max. per wire)
	Direct current : 0 to 20 mA DC, 4 to 20 mA DC 50Ω shunt resistor [If direct current input (Externally mounted 50Ω shunt resistor) is selected, connect a 50Ω shunt resistor between input terminals.] Allowable input current: 100 mA max.
	DC voltage : 0 to 1 V DC: Input impedance: 1 MΩ min. Allowable input voltage: 5 V max. Allowable signal source resistance: 2 kΩ max. 0 to 5 V DC, 1 to 5 V DC, 0 to 10 V DC: Input impedance: 100 kΩ min. Allowable input voltage: 15 V max. Allowable signal source resistance: 100 Ω max.
Accuracy (Setting, Indication)	Thermocouple: Within ±0.2% of each input span ±1 digit, or within ±2°C(4°F), whichever is greater However, R or S input, 0 to 200°C(32 to 392°F): Within 6°C(12°F) B input, 0 to 300°C(32 to 572°F): Accuracy is not guaranteed. K, J, E, T, N input, less than 0°C(32°F): Within ±0.4% of input span ±1 digit RTD : Within ±0.1% of each input span ±1 digit, or within ±1°C(2°F), whichever is greater Direct current, voltage: Within ±0.2% of each input span ±1 digit
Input sampling period	125 ms
Control output (OUT)	Relay contact 1a: Control capacity: 3 A 250 V AC (resistive load), 1 A 250 V AC (inductive load cos φ=0.4), Electrical life: 100,000 cycles
	Non-contact voltage (for SSR drive): 12 V DC ±15%, Max. 40 mA DC (short circuit protected) Direct current : 4 to 20 mA DC, Load resistance: Max. 550 Ω Output accuracy: Within ±0.3% of output span, Resolution: 12000
Event output (EVT)	Alarm output : Alarm, Loop break alarm and Heater burnout alarm (W option) utilize common output terminals. Output: Open collector, Control capacity: 0.1 A 24 V DC
	Loop break alarm output : Detects heater burnout, sensor burnout and actuator trouble. Loop break alarm time : 0 to 200 minutes Loop break alarm span: Thermocouple, RTD input: 0 to 150°C(°F) or 0.0 to 150.0°C(°F) Direct current, voltage input: 0 to 1500 (The placement of the decimal point follows the selection.) Output: Open collector, Control capacity: 0.1 A 24 V DC
Safety standards	UL: Power input rating 100 – 240 V AC, 24 V AC/DC    File No. E159038
Environmental spec	RoHS directive compliant

## ■ Optional Specifications When ordering, designate an option code.

Heater burnout alarm (W option)	Monitors heater current with current transformer (CT), and detects burnout. Rated current: 5A [W (5A)], 10A [W (10A)], 20A [W (20A)], 50A [W (50A)] (Please specify one.) Output: Open collector, Control capacity: 0.1 A 24 V DC																				
Serial communication (C5 option)	Communication line : EIA RS-485 Communication method : Half-duplex communication Synchronization method: Start-stop synchronization Communication speed : 2400/4800/9600/19200/38400 bps (Factory default: 9600 bps) (Selectable by keypad) Data bit : 7, 8 (Factory default: 7 bits) (Selectable by keypad) Parity : Even/Odd/No parity (Factory default: Even) (Selectable by keypad) Stop bit : 1, 2 (Factory default: 1 bit) (Selectable by keypad) Data format: <table border="1"> <tr> <td>Communication protocol</td> <td>Shinko protocol</td> <td>Modbus ASCII</td> <td>Modbus RTU</td> </tr> <tr> <td>Start bit</td> <td>1</td> <td>1</td> <td>1</td> </tr> <tr> <td>Data bit</td> <td>7</td> <td>7</td> <td>8</td> </tr> <tr> <td>Parity</td> <td>Even</td> <td>Even (No parity, Odd)</td> <td>No parity (Even, Odd)</td> </tr> <tr> <td>Stop bit</td> <td>1</td> <td>1 or 2</td> <td>1 or 2</td> </tr> </table>	Communication protocol	Shinko protocol	Modbus ASCII	Modbus RTU	Start bit	1	1	1	Data bit	7	7	8	Parity	Even	Even (No parity, Odd)	No parity (Even, Odd)	Stop bit	1	1 or 2	1 or 2
Communication protocol	Shinko protocol	Modbus ASCII	Modbus RTU																		
Start bit	1	1	1																		
Data bit	7	7	8																		
Parity	Even	Even (No parity, Odd)	No parity (Even, Odd)																		
Stop bit	1	1 or 2	1 or 2																		
Heating/Cooling control output (DC option)	Select one cooling action from the following: Air cooling (Linear characteristics), Oil cooling (1.5th power of the linear characteristics), Water cooling (2nd power of the linear characteristics) Output: Open collector, Control capacity: 0.1 A 24 V DC																				
Set value memory external selection (EI option)	SV1 or SV2 can be selected by the external contact. Circuit current when closed: Approx. 2 mA																				
External setting input (EA option)	Setting signal : Direct current 4 to 20 mA Allowable input : 50 mA DC max. Input impedance : 50 Ω max. Input sampling period: 125 ms																				

## ■ External Dimensions (Scale : mm)

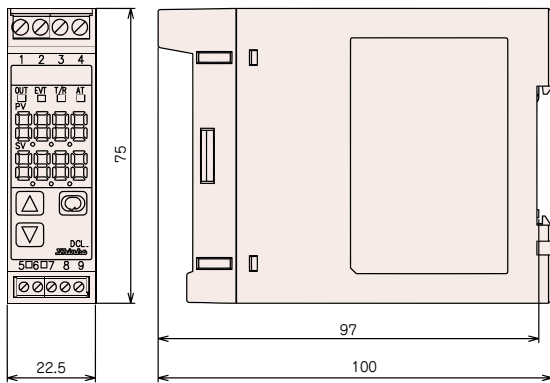

## ■ CT Dimensions (Scale : mm)

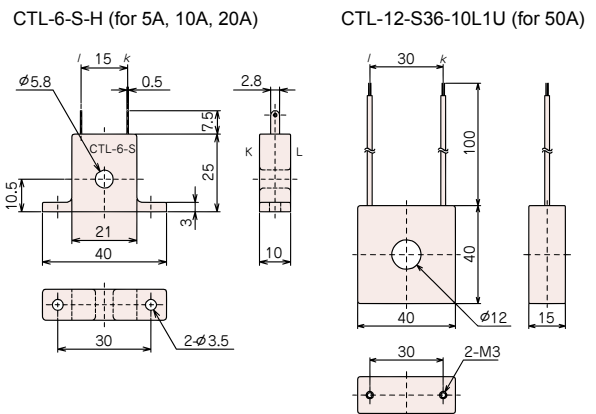

## ■ Terminal Arrangement

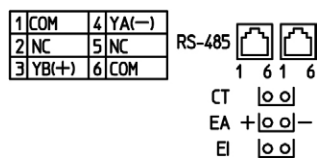
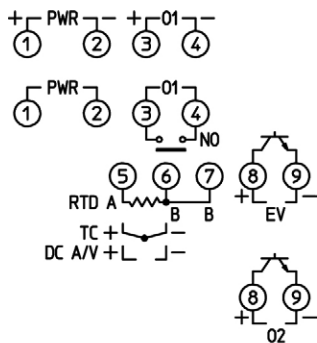

Bottom of the unit

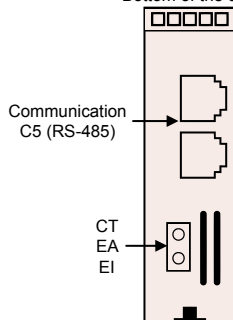

PWR	Power supply: 100 to 240 V AC or 24 V AC/DC <b>For 24 V DC, ensure polarity is correct.</b>
O1	Control output OUT1
TC	Thermocouple input
RTD	Resistance temperature detector input
DC	Direct current input, DC voltage input (*)
EV	Event output Outputs when Alarm, Loop break alarm or Heater burnout alarm output (W option) is ON.
O2	Control output OUT2 [Heating/Cooling control output (DC option)]
RS-485	Serial communication (C5 option)
CT	Current transformer input [Heater burnout alarm output (W option)]
EA	External setting input (EA option)
EI	Event input DI [Set value memory external selection (EI option)]

(\*): If direct current input (Externally mounted 50 Ω shunt resistor) is designated, connect a 50 Ω shunt resistor (sold separately) between input terminals.

## ■ Recommended Ferrules and Tightening Torque

Terminal number	Terminal screw	Ferrules with insulation sleeve	Conductor cross sections	Tightening torque	Crimping pliers
1 to 4	M2.6	Al 0.25-8 YE	0.2 to 0.25 mm <sup>2</sup>	0.5 to 0.6 N·m	CRIMPFOX ZA 3 CRIMPFOX UD 6
		Al 0.34-8 TQ	0.25 to 0.34 mm <sup>2</sup>		
		Al 0.5-8 WH	0.34 to 0.5 mm <sup>2</sup>		
		Al 0.75-8 GY	0.5 to 0.75 mm <sup>2</sup>		
		Al 1.0-8 RD	0.75 to 1.0 mm <sup>2</sup>		
5 to 9	M2.0	Al 1.5-8 BK	1.0 to 1.5 mm <sup>2</sup>	0.22 to 0.25 N·m	
		Al 0.25-8 YE	0.2 to 0.25 mm <sup>2</sup>		
		Al 0.34-8 TQ	0.25 to 0.34 mm <sup>2</sup>		
		Al 0.5-8 WH	0.34 to 0.5 mm <sup>2</sup>		

The ferrules and crimping pliers made by Phoenix Contact GMBH & CO are recommended.

## ■ Communication Cable

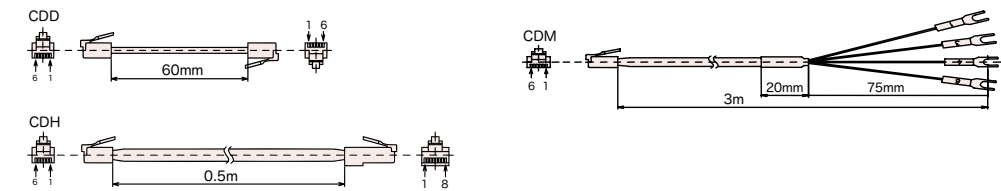
Model	<p>CDD: Communication cable to connect the DCL-33A to the DCL-33A. Cable length: Approx. 60 mm</p> <p>CDH: Communication cable to connect the DCL-33A to Hakko touch screen unit. Cable length: Approx. 0.5 m (standard) (Can be extended by 0.5 m each time.)</p> <p>CDM: Communication cable to connect the DCL-33A to a touch screen unit / programmable controller. Cable length: Approx. 3 m (standard) (Can be extended by 1 m each time.)</p>
Dimensions (Scale: mm)	

## ● Configuration Example

### ■ When a PC monitors multiple DCL-33A units

By connecting to the PC, up to 31 points of temperature control can be monitored using a Shinko communication converter.  
(If PC's communication specification is RS-485, it is not necessary to use a communication converter.)  
SWM-JC001M is available as monitoring software.

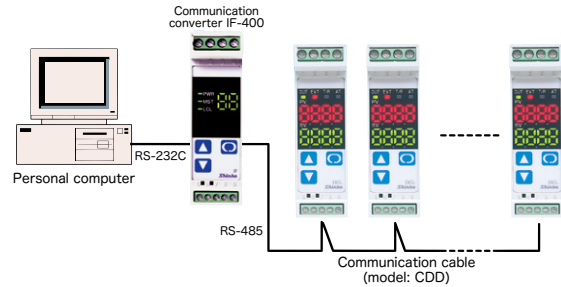

### ■ When a touch screen unit monitors multiple DCL-33A units

A maximum of 31 points of temperature control and monitoring can be carried out by connecting DCL-33A to the touch screen unit.  
The following touch screen units are available.  
Digital Electronics Corp. : SP series, GP series, LT series  
Hakko Electronics Co., Ltd.: V9 series, V8 series, TS series  
(For the communication cable, Shinko's specific cable is used.)

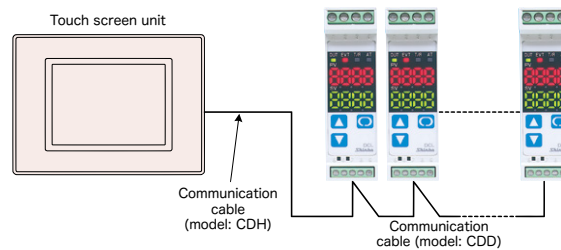

### ■ When using DCL-33A units as a programmable controller

By using Shinko programmable controller PCA1 or PCB1 (with C5 option) as a program setter in combination with DCL-33A (with C5 option), DCL-33A can also be used as a programmable controller for a maximum of 31 positions. (Set value digital transmission is possible.)

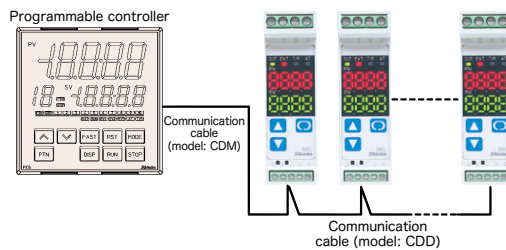

### ■ When using max. 32 DCL-33A units with the PLC

By connecting to the PLC via PLC interface unit SIF-600, a maximum of 32 DCL-33A units can be connected.  
Please make inquiries concerning the PLC compatible with SIF-400 to us or our agency.

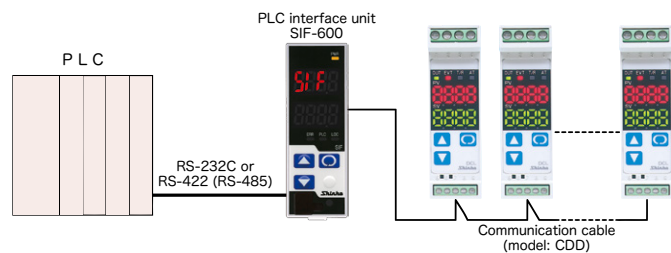

**SAFETY PRECAUTIONS**

- To ensure safe and correct use, thoroughly read and understand the manual before using this instrument.
- This instrument is intended to be used for industrial machinery, machine tools and measuring equipment. Verify correct usage after purpose-of-use consultation with our agency or main office.  
(Never use this instrument for medical purposes with which human lives are involved.)
- External protection devices such as protective equipment against excessive temperature rise, etc. must be installed, as malfunction of this product could result in serious damage to the system or injury to personnel. Also proper periodic maintenance is required.
- This instrument must be used under the conditions and environment described in the manual. Shinko Technos Co., Ltd. does not accept liability for any injury, loss of life or damage occurring due to the instrument being used under conditions not otherwise stated in this manual.

**Caution with respect to Export Trade Control Ordinance**

To avoid this instrument from being used as a component in, or as being utilized in the manufacture of weapons of mass destruction (i.e. military applications, military equipment, etc.), please investigate the end users and the final use of this instrument.  
In the case of resale, ensure that this instrument is not illegally exported.

- This catalog is as of December 2017 and its contents are subject to change without notice.
- Photos used in this catalog do not show unit in operating status.
- If you have any inquiries, please consult us or our agency.

## SHINKO TECHNOS CO., LTD. OVERSEAS DIVISION

**Fastron**  
Electronics

9B Lakewood Blvd  
Braeside VIC 3195 Australia

- Power Semiconductors
- Electrical Measurement
- Process Control

Web: [www.fastron.com.au](http://www.fastron.com.au)  
Email: [sales@fastron.com.au](mailto:sales@fastron.com.au)  
Telephone: + 61- 3 - 97635155  
Facsimile: + 61- 3 - 97635206