

APPLICATIONS

- Variable speed A.C. motor drive inverters (VSD-AC).
- Uninterruptable Power Supplies
- High Voltage Converters.
- Choppers.
- Welding.
- Induction Heating.
- DC/DC Converters.

KEY PARAMETERS

I_{TCM}	1000A
V_{DRM}	2500V
$I_{T(AV)}$	400A
dV_D/dt	1000V/μs
di_T/dt	300A/μs

FEATURES

- Double Side Cooling.
- High Reliability In Service.
- High Voltage Capability.
- Fault Protection Without Fuses.
- High Surge Current Capability.
- Turn-off Capability Allows Reduction In Equipment Size And Weight. Low Noise Emission Reduces Acoustic Cladding Necessary For Environmental Requirements.

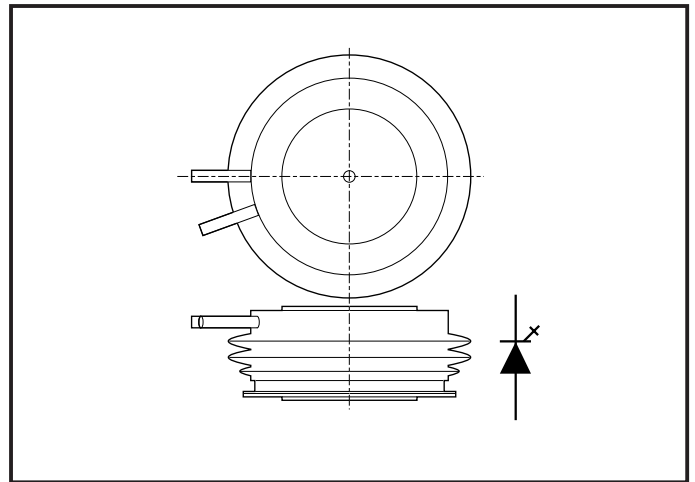

Outline type code: P.
See Package Details for further information.

VOLTAGE RATINGS

Type Number	Repetitive Peak Off-state Voltage V_{DRM} V	Repetitive Peak Reverse Voltage V_{RRM} V	Conditions
DG406BP25	2500	16	$T_{vj} = 125^{\circ}C, I_{DM} = 50mA,$ $I_{RRM} = 50mA$

CURRENT RATINGS

Symbol	Parameter	Conditions	Max.	Units
I_{TCM}	Repetitive peak controllable on-state current	$V_D = V_{DRM}, T_j = 125^{\circ}C, di_{GQ}/dt = 30A/\mu s, C_s = 1.0\mu F$	1000	A
$I_{T(AV)}$	Mean on-state current	$T_{HS} = 80^{\circ}C$. Double side cooled. Half sine 50Hz.	400	A
$I_{T(RMS)}$	RMS on-state current	$T_{HS} = 80^{\circ}C$. Double side cooled. Half sine 50Hz.	630	A

DG406BP25

SURGE RATINGS

Symbol	Parameter	Conditions	Max.	Units
I_{TSM}	Surge (non-repetitive) on-state current	10ms half sine. $T_j = 125^\circ\text{C}$	8.0	kA
I^2t	I^2t for fusing	10ms half sine. $T_j = 125^\circ\text{C}$	0.32×10^6	A^2s
di_T/dt	Critical rate of rise of on-state current	$V_D = 2000\text{V}$, $I_T = 1000\text{A}$, $T_j = 125^\circ\text{C}$, $I_{FG} \geq 30\text{A}$, Rise time $> 1.0\mu\text{s}$	300	$\text{A}/\mu\text{s}$
dV_D/dt	Rate of rise of off-state voltage	To 66% V_{DRM} ; $R_{GK} \leq 1.5\Omega$, $T_j = 125^\circ\text{C}$	500	$\text{V}/\mu\text{s}$
		To 66% V_{DRM} ; $V_{RG} = -2\text{V}$, $T_j = 125^\circ\text{C}$	1000	$\text{V}/\mu\text{s}$
L_S	Peak stray inductance in snubber circuit	$I_T = 1000\text{A}$, $V_D = V_{DRM}$, $T_j = 125^\circ\text{C}$, $di_{GQ}/dt = 30\text{A}/\mu\text{s}$, $C_s = 1.0\mu\text{F}$	200	nH

GATE RATINGS

Symbol	Parameter	Conditions	Min.	Max.	Units
V_{RGM}	Peak reverse gate voltage	This value maybe exceeded during turn-off	-	16	V
I_{FGM}	Peak forward gate current		20	70	A
$P_{FG(AV)}$	Average forward gate power		-	10	W
P_{RGM}	Peak reverse gate power		-	15	kW
di_{GQ}/dt	Rate of rise of reverse gate current		15	60	$\text{A}/\mu\text{s}$
$t_{ON(min)}$	Minimum permissible on time		20	-	μs
$t_{OFF(min)}$	Minimum permissible off time		100	-	μs

THERMAL RATINGS AND MECHANICAL DATA

Symbol	Parameter	Conditions	Min.	Max.	Units
$R_{th(j-hs)}$	DC thermal resistance - junction to heatsink surface	Double side cooled	-	0.041	$^\circ\text{C}/\text{W}$
		Anode side cooled	-	0.07	$^\circ\text{C}/\text{W}$
		Cathode side cooled	-	0.1	$^\circ\text{C}/\text{W}$
$R_{th(c-hs)}$	Contact thermal resistance	Clamping force 12.0kN With mounting compound	-	0.009	$^\circ\text{C}/\text{W}$
T_{vj}	Virtual junction temperature		-	125	$^\circ\text{C}$
T_{OP}/T_{stg}	Operating junction/storage temperature range		-40	125	$^\circ\text{C}$
-	Clamping force		11.0	15.0	kN

CHARACTERISTICS

$T_j = 125^\circ\text{C}$ unless stated otherwise					
Symbol	Parameter	Conditions	Min.	Max.	Units
V_{TM}	On-state voltage	At 1000A peak, $I_{G(ON)} = 4\text{A d.c.}$	-	2.5	V
I_{DM}	Peak off-state current	$V_{DRM} = 2500\text{V}$, $V_{RG} = 0\text{V}$	-	50	mA
I_{RRM}	Peak reverse current	At V_{RRM}	-	50	mA
V_{GT}	Gate trigger voltage	$V_D = 24\text{V}$, $I_T = 100\text{A}$, $T_j = 25^\circ\text{C}$	-	1.0	V
I_{GT}	Gate trigger current	$V_D = 24\text{V}$, $I_T = 100\text{A}$, $T_j = 25^\circ\text{C}$	-	1.5	A
I_{RGM}	Reverse gate cathode current	$V_{RGM} = 16\text{V}$, No gate/cathode resistor	-	50	mA
E_{ON}	Turn-on energy	$V_D = 2000\text{V}$	-	1040	mJ
t_d	Delay time	$I_T = 1000\text{A}$, $di_T/dt = 300\text{A}/\mu\text{s}$	-	1.5	μs
t_r	Rise time	$I_{FG} = 30\text{A}$, rise time $\leq 1.0\mu\text{s}$	-	3.0	μs
E_{OFF}	Turn-off energy		-	2300	mJ
t_{gs}	Storage time		-	14.0	μs
t_{gf}	Fall time	$I_T = 1000\text{A}$, $V_{DM} = 2500\text{V}$	-	1.5	μs
t_{gq}	Gate controlled turn-off time	Snubber Cap $C_s = 1.0\mu\text{F}$,	-	15.5	μs
Q_{GQ}	Turn-off gate charge	$di_{GQ}/dt = 30\text{A}/\mu\text{s}$	-	3000	μC
Q_{GQT}	Total turn-off gate charge		-	6000	μC
I_{GQM}	Peak reverse gate current		-	420	A

CURVES

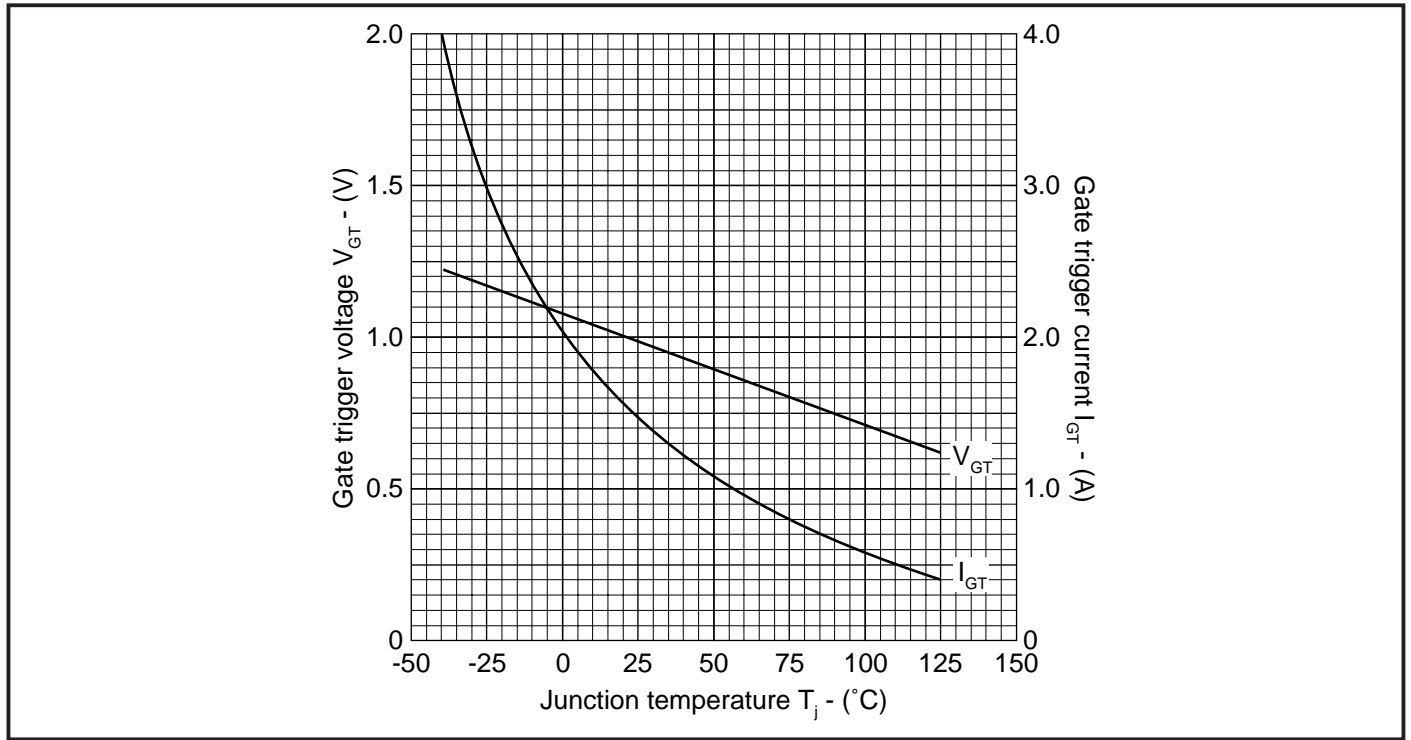

Fig.1 Maximum gate trigger voltage/current vs junction temperature

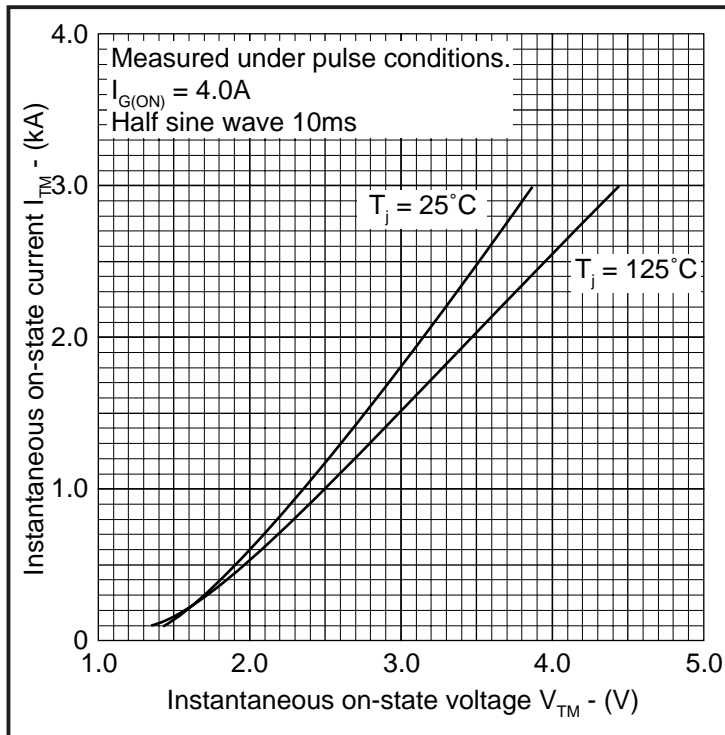

Fig.2 On-state characteristics

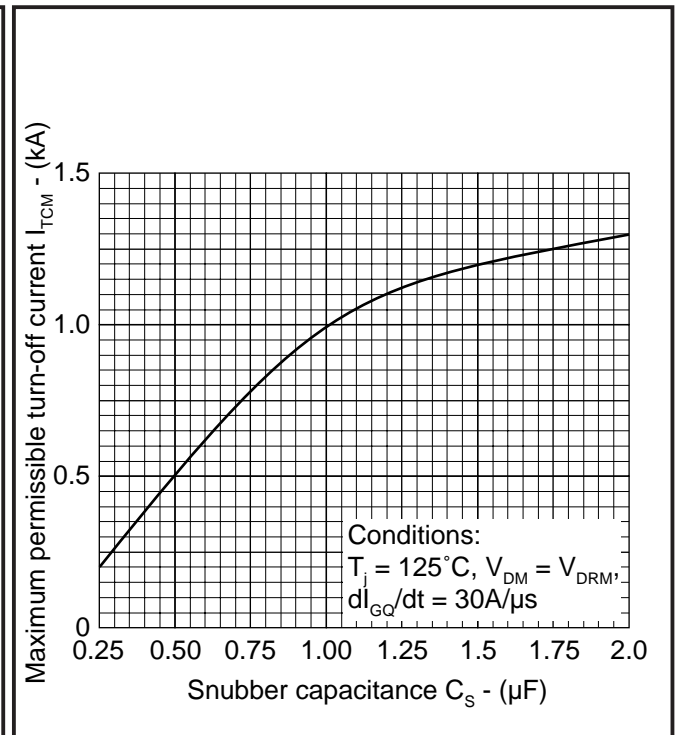

Fig.3 Maximum dependence of I_{TCM} on C_S

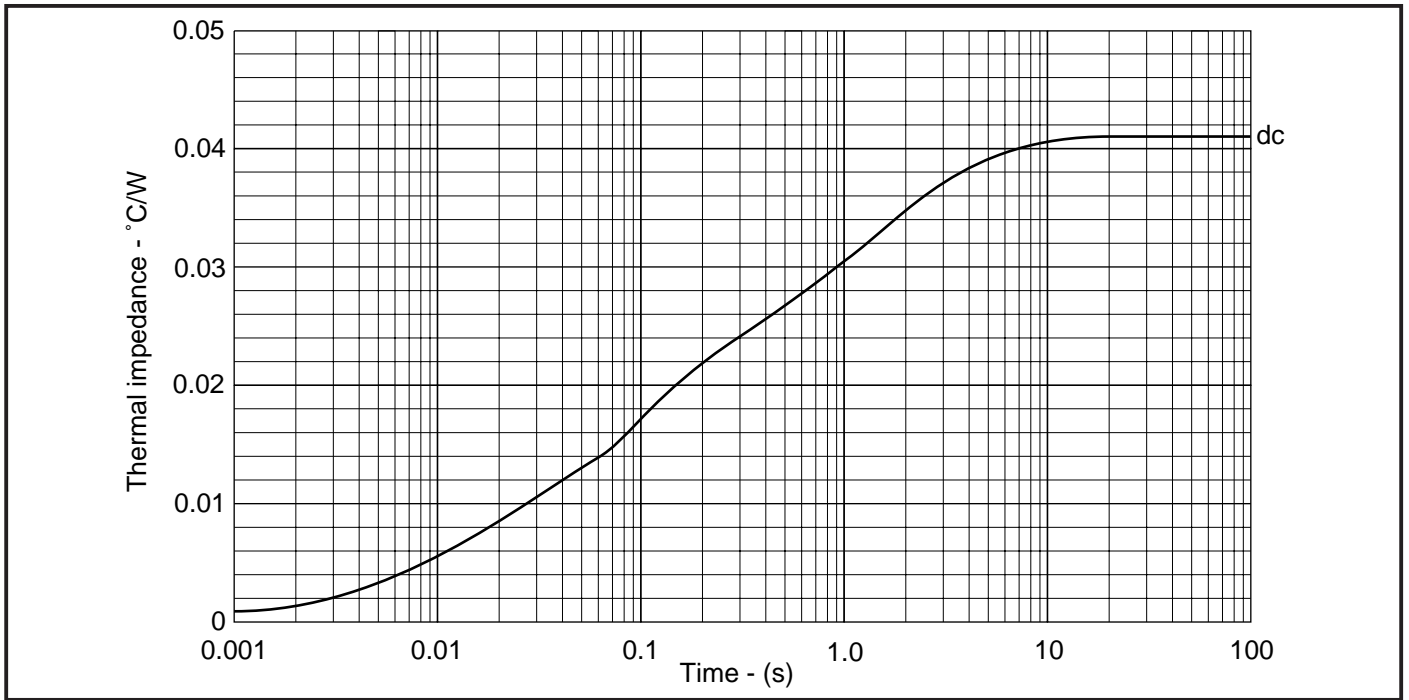

Fig.4 Maximum (limit) transient thermal impedance - double side cooled

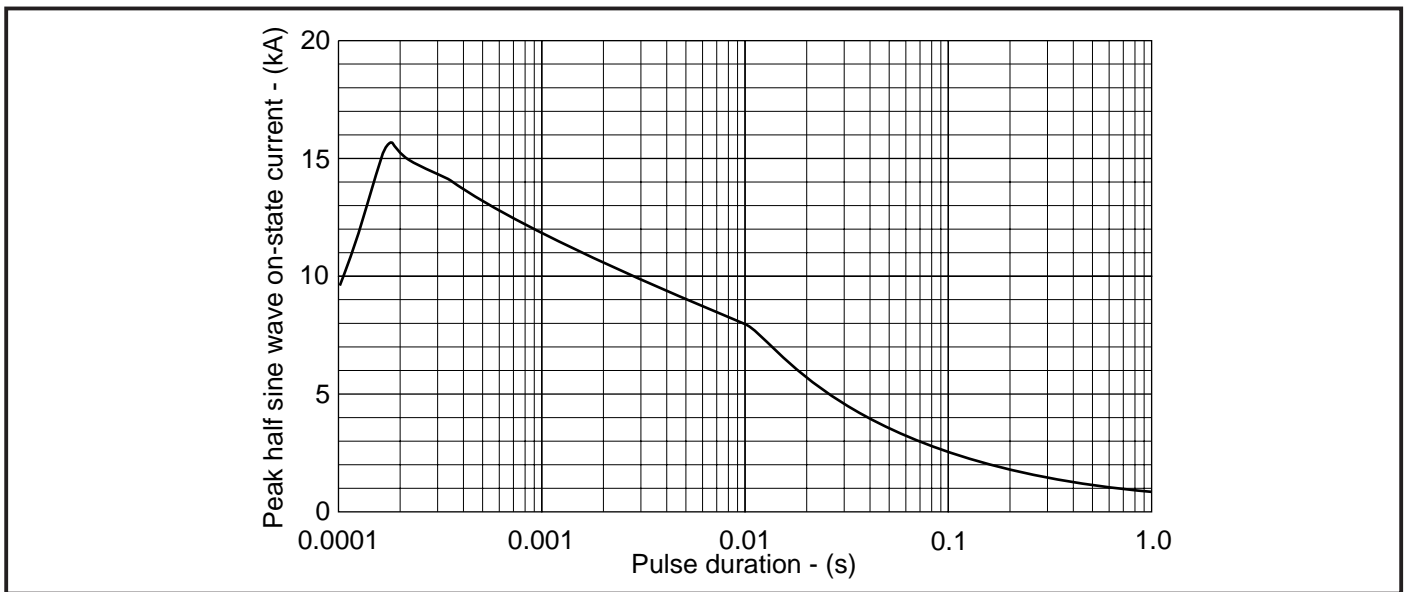

Fig.5 Surge (non-repetitive) on-state current vs time

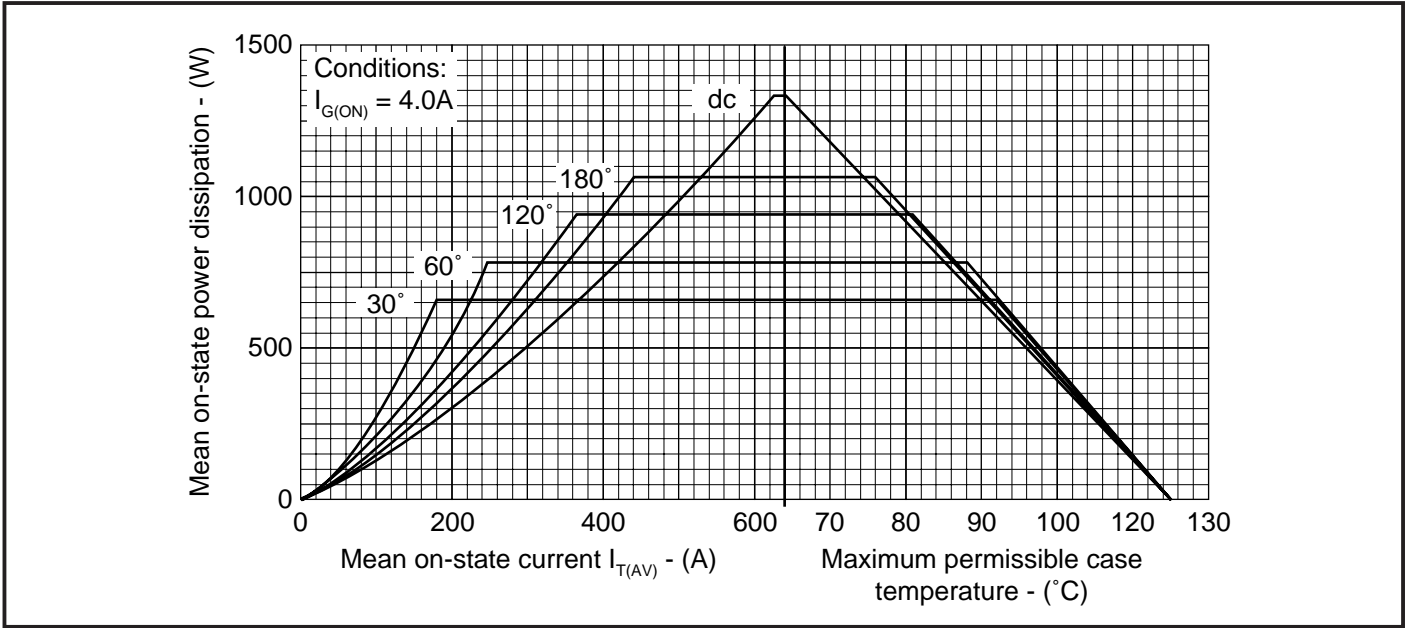

Fig.6 Steady state rectangular wave conduction loss - double side cooled

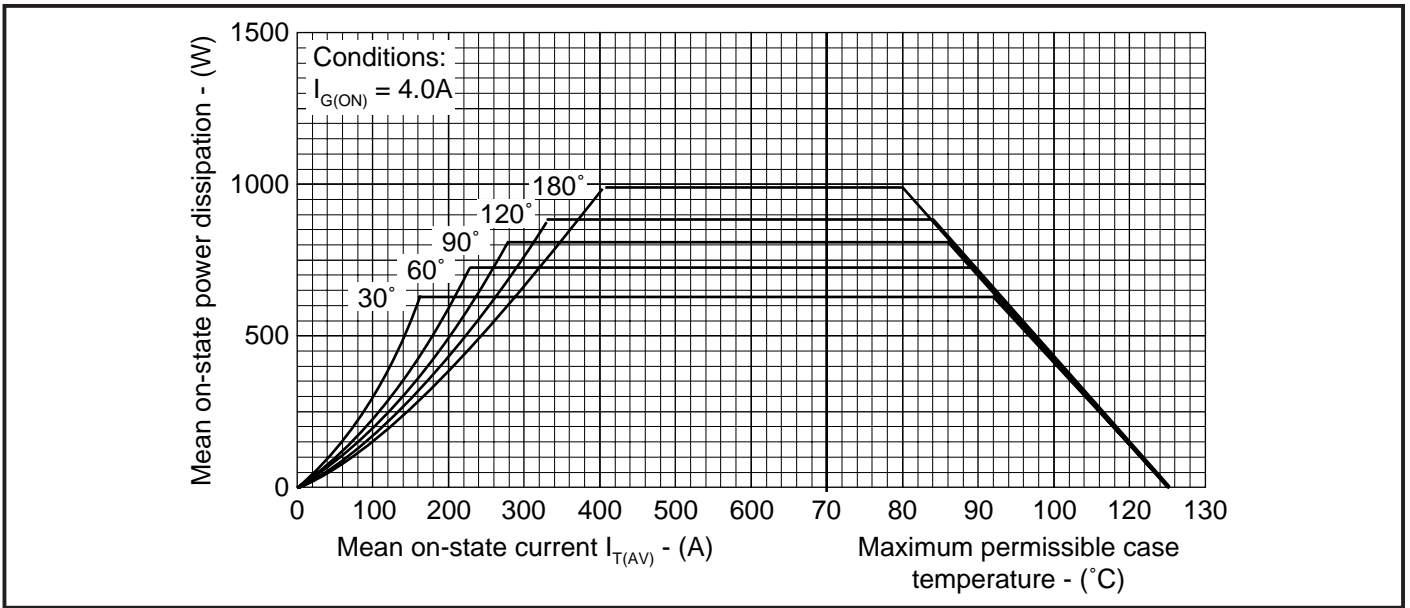

Fig.7 Steady state sinusoidal wave conduction loss - double side cooled

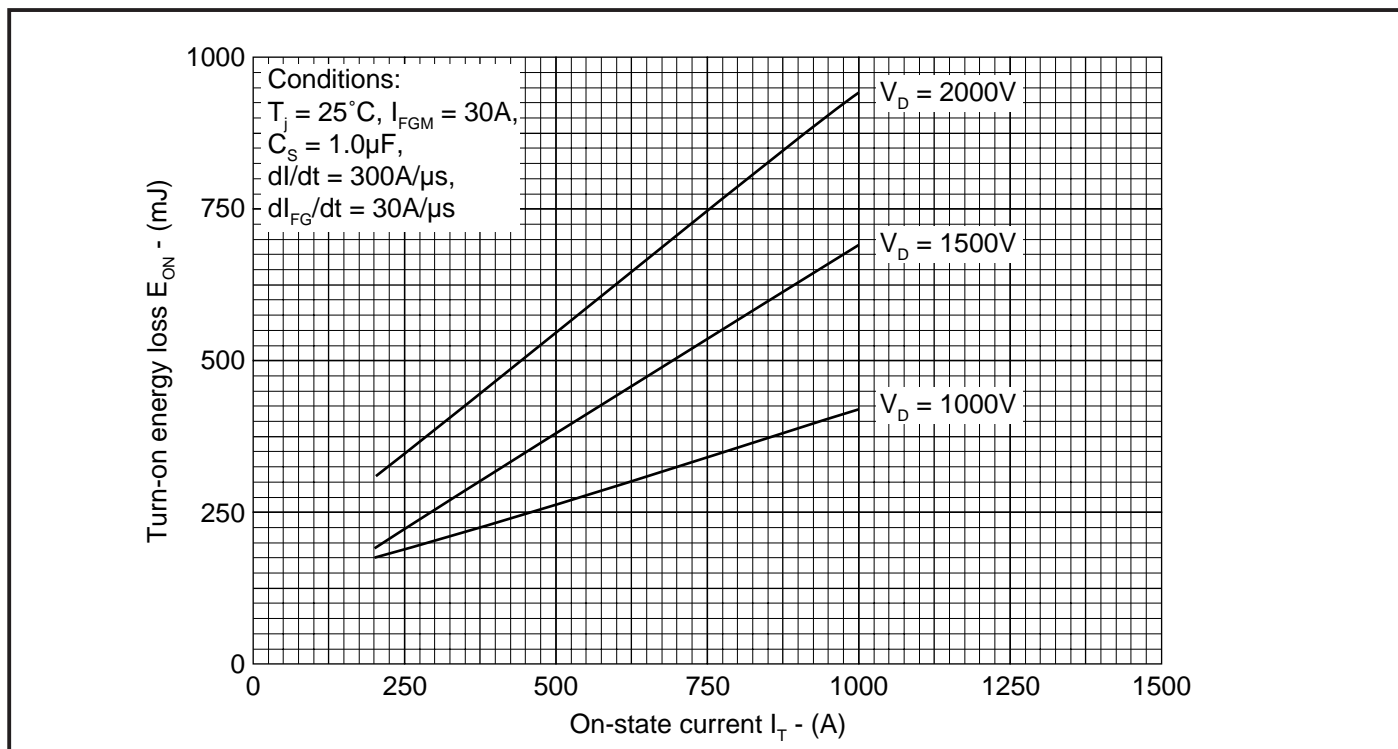

Fig.8 Turn-on energy vs on-state current

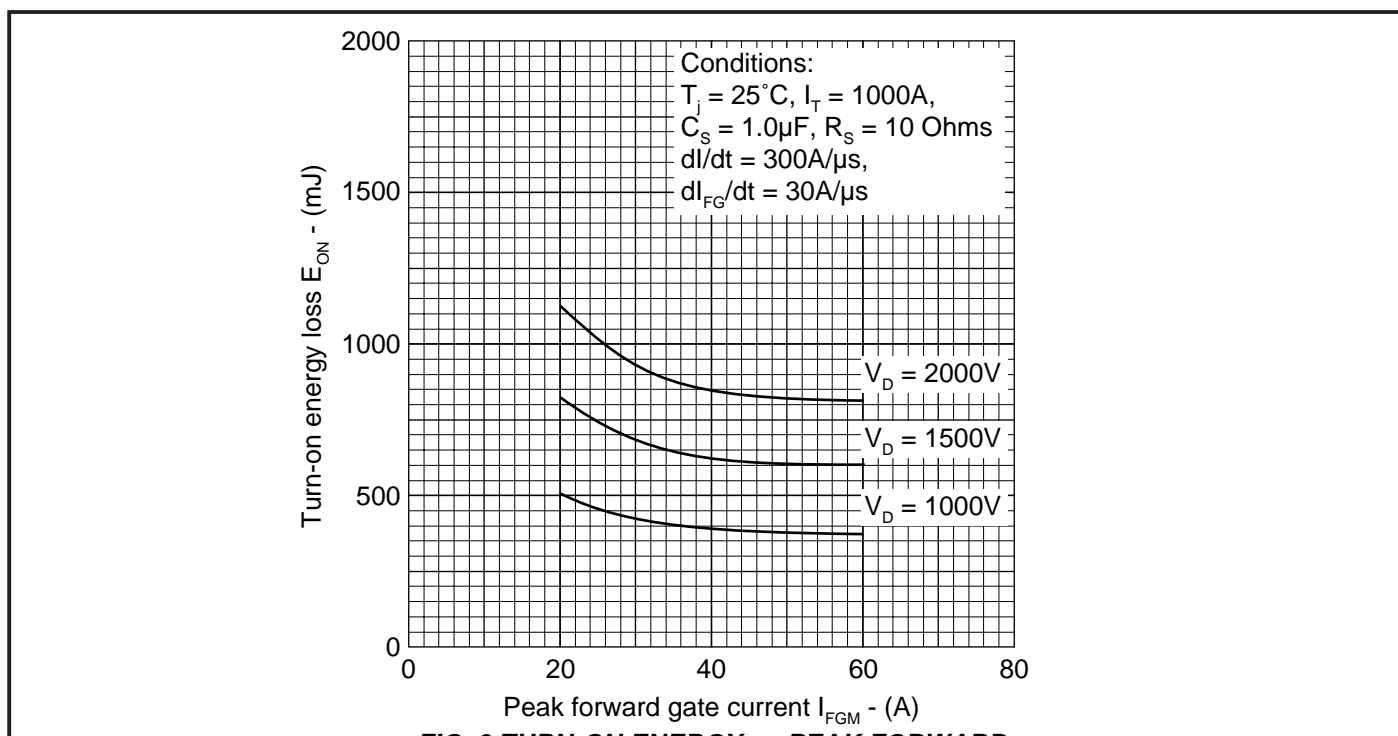

Fig.9 Turn-on energy vs peak forward gate current

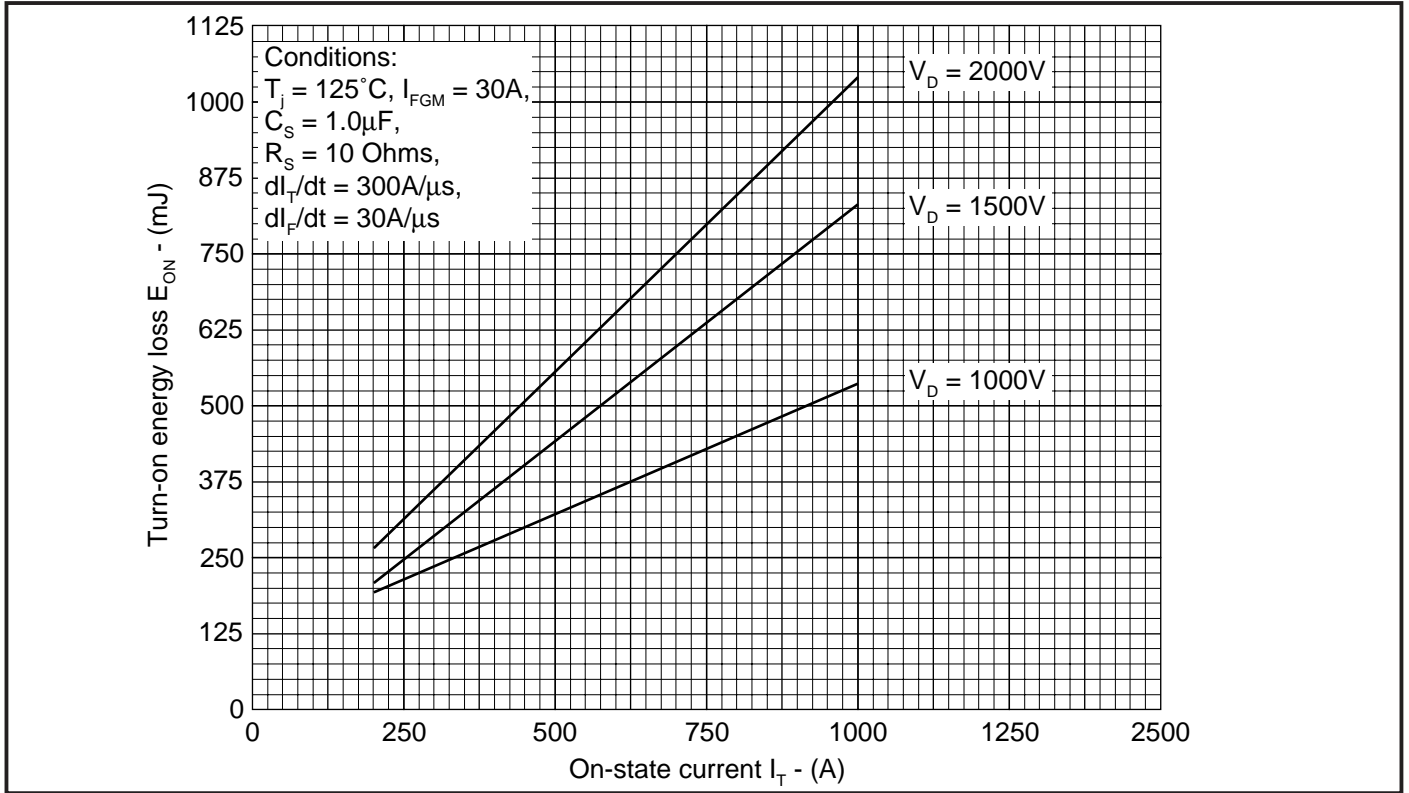

Fig.10 Turn-on energy vs on-state current

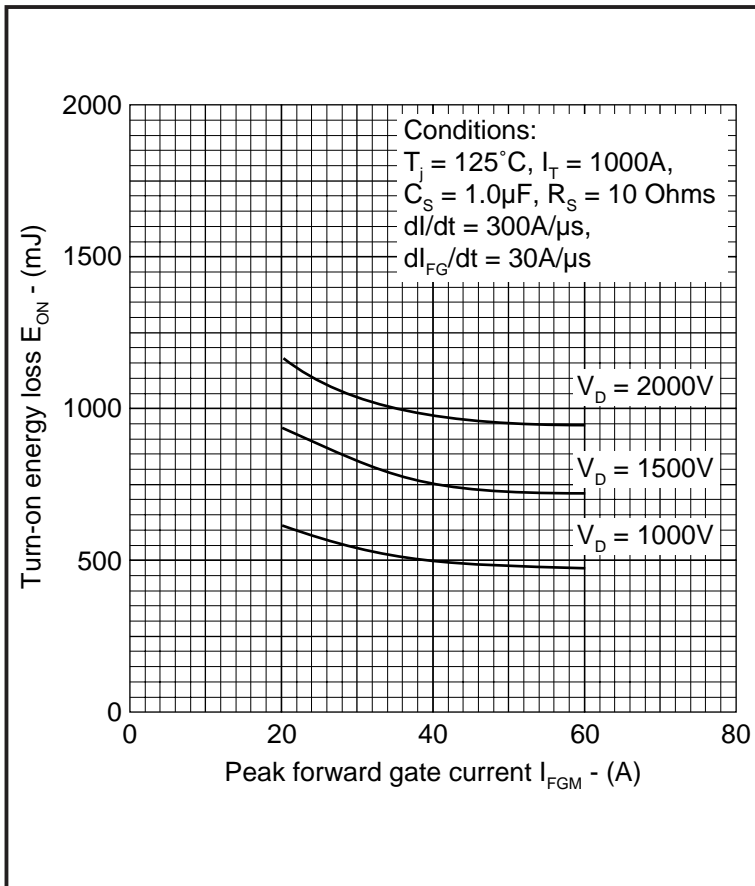

Fig.11 Turn-on energy vs peak forward gate current

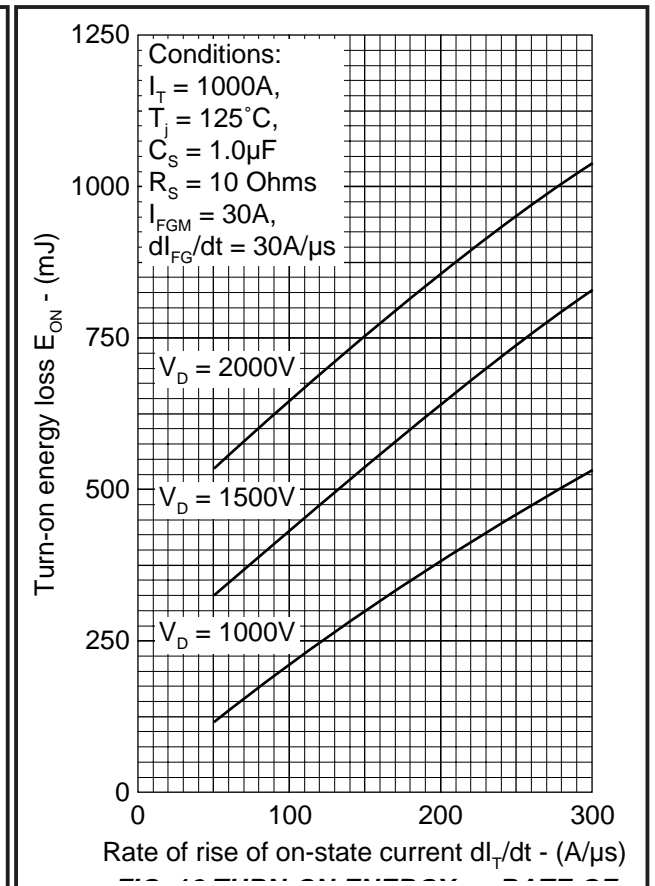

Fig.12 Turn-on energy vs rate of rise of on-state current

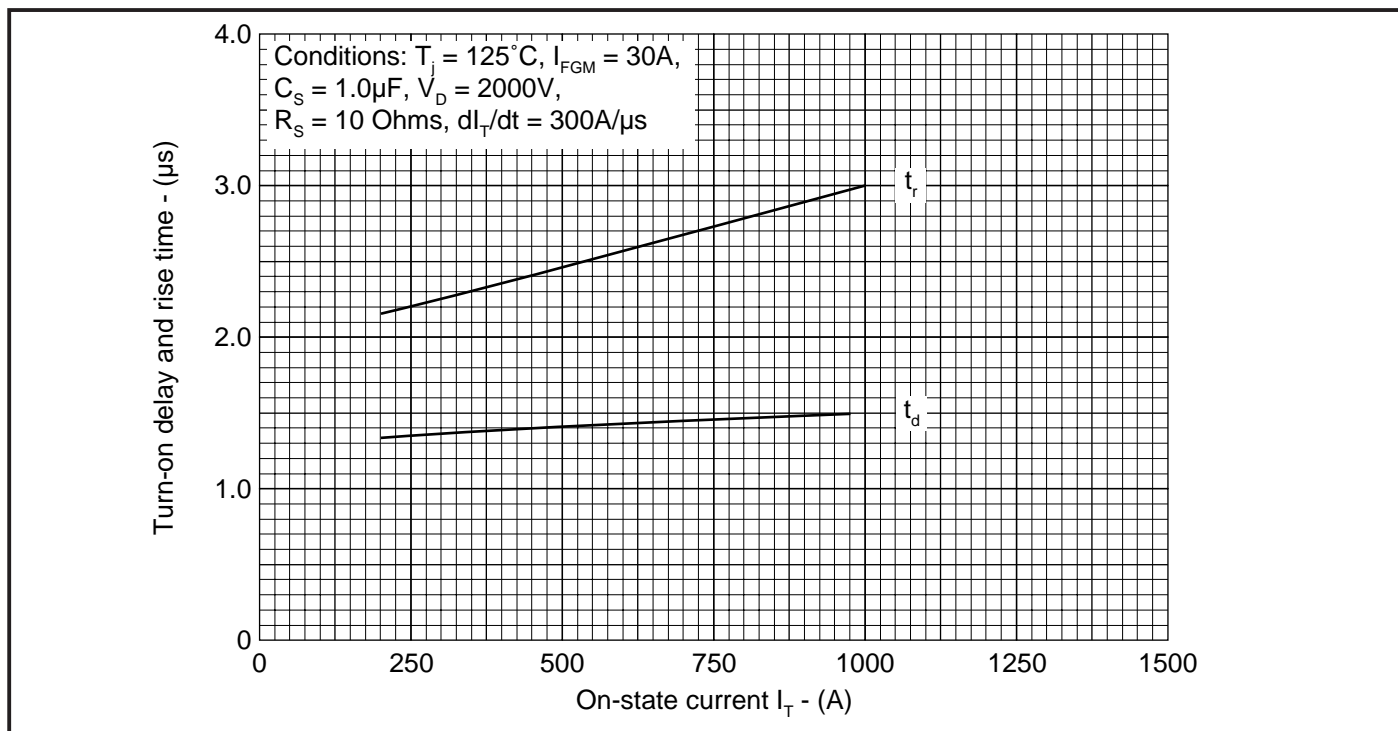

Fig.13 Delay time & rise time vs turn-on current

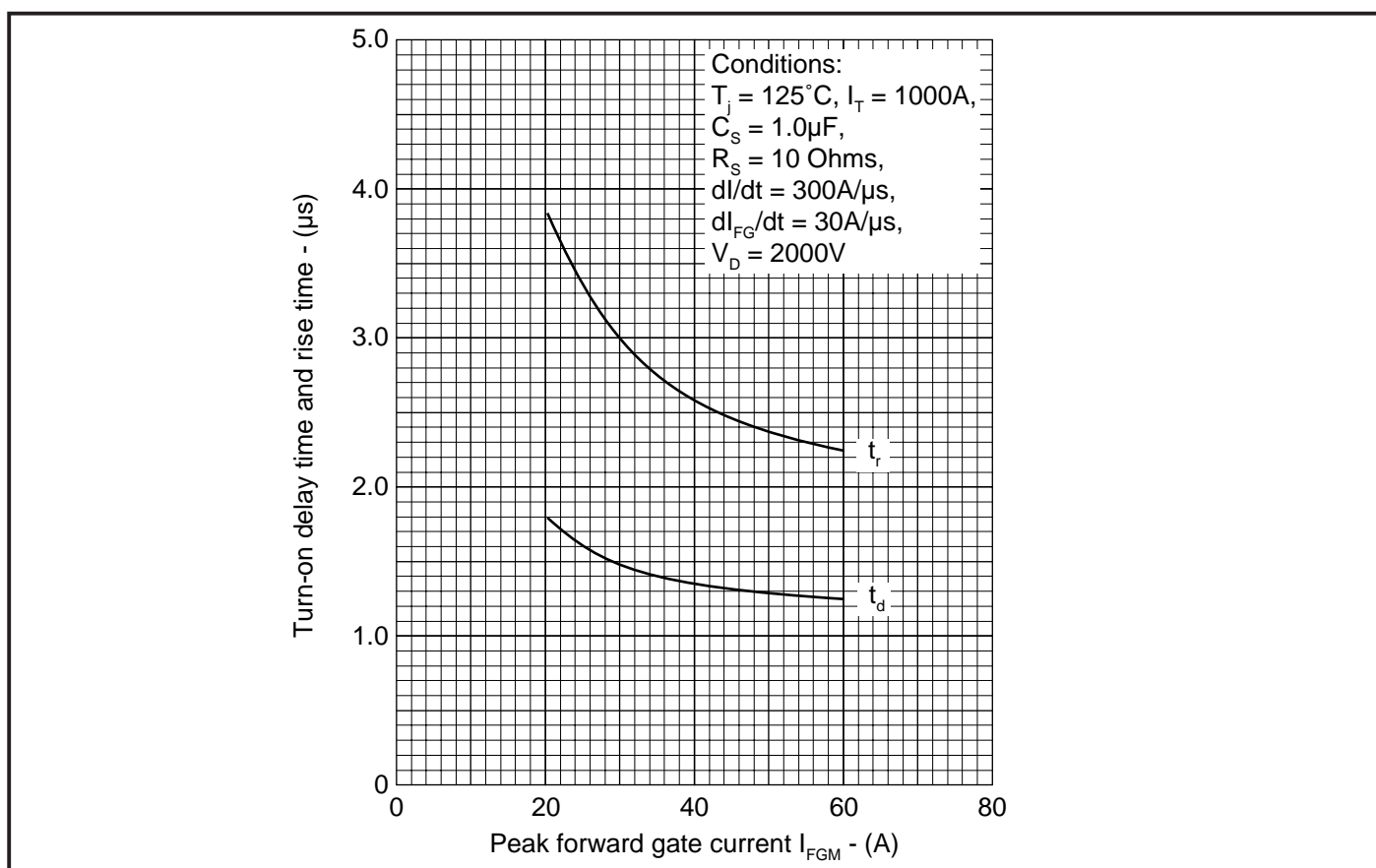

Fig.14 Delay time & rise time vs peak forward gate current

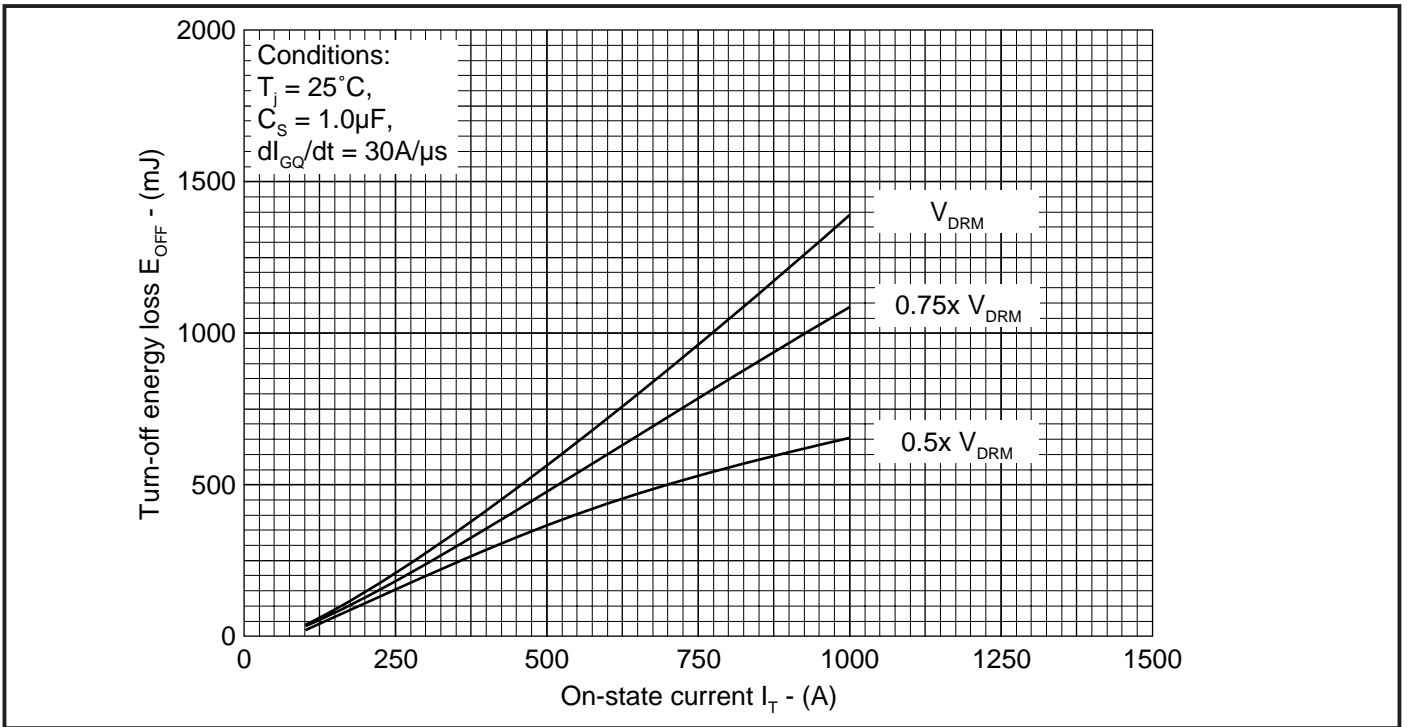

Fig.15 Turn-off energy vs on-state current

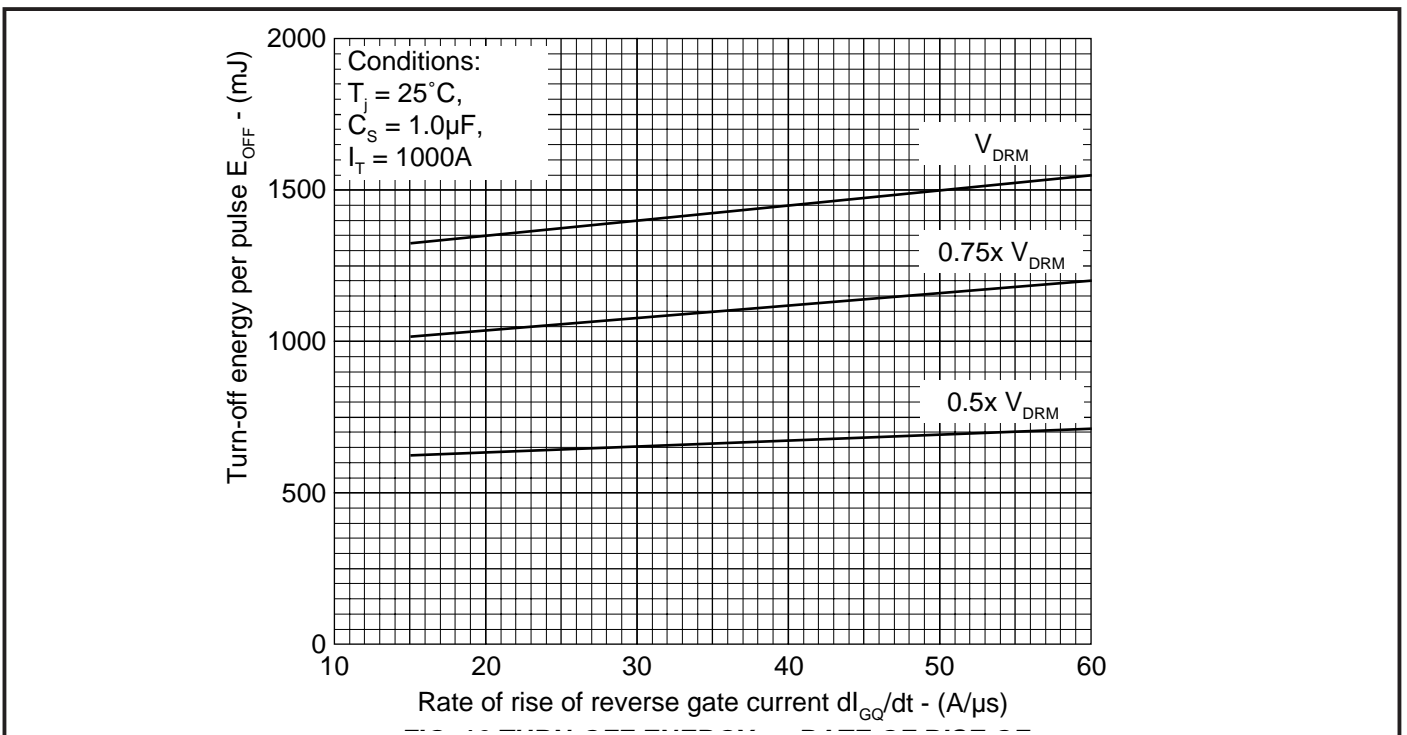

Fig.16 Turn-off energy vs rate of rise of reverse gate current

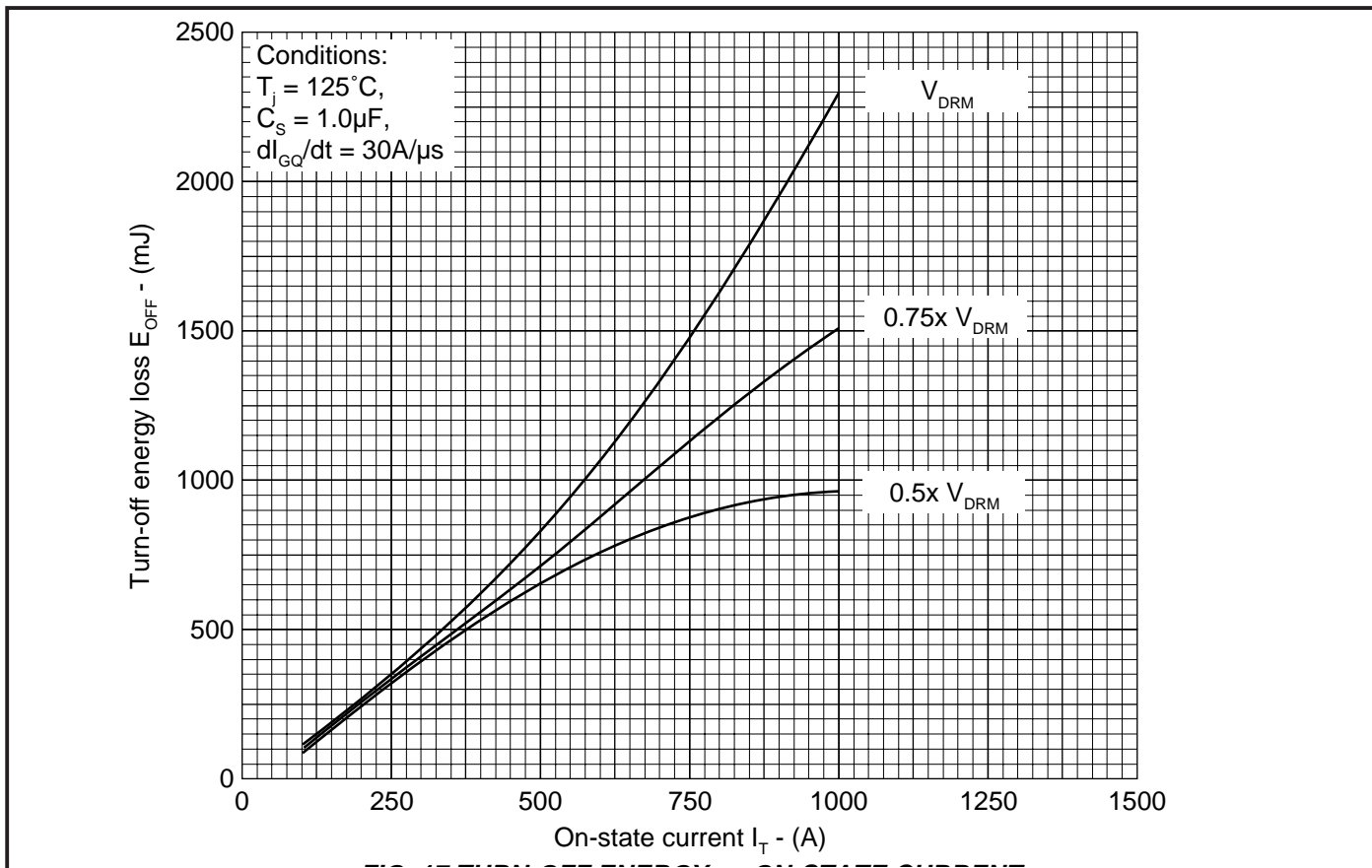

Fig.17 Turn-off energy vs on-state current

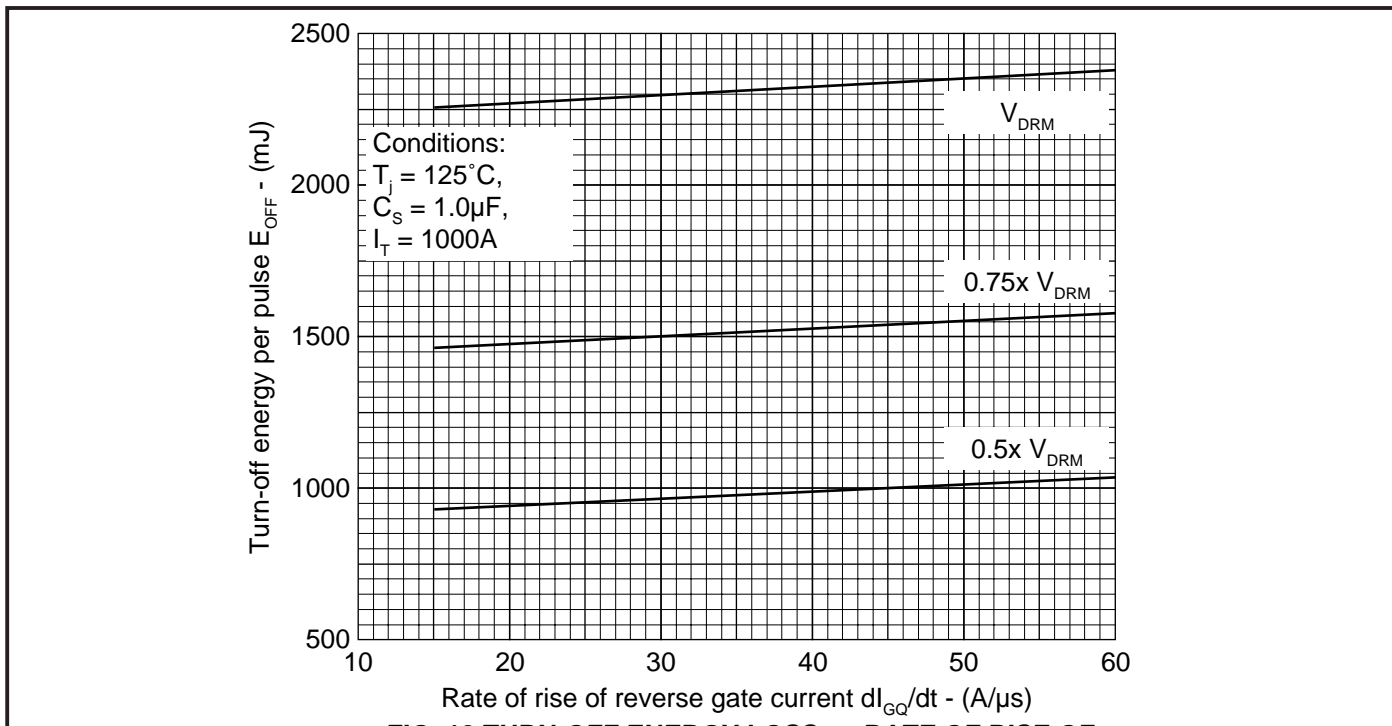

Fig.18 Turn-off energy loss vs rate of rise of reverse gate current

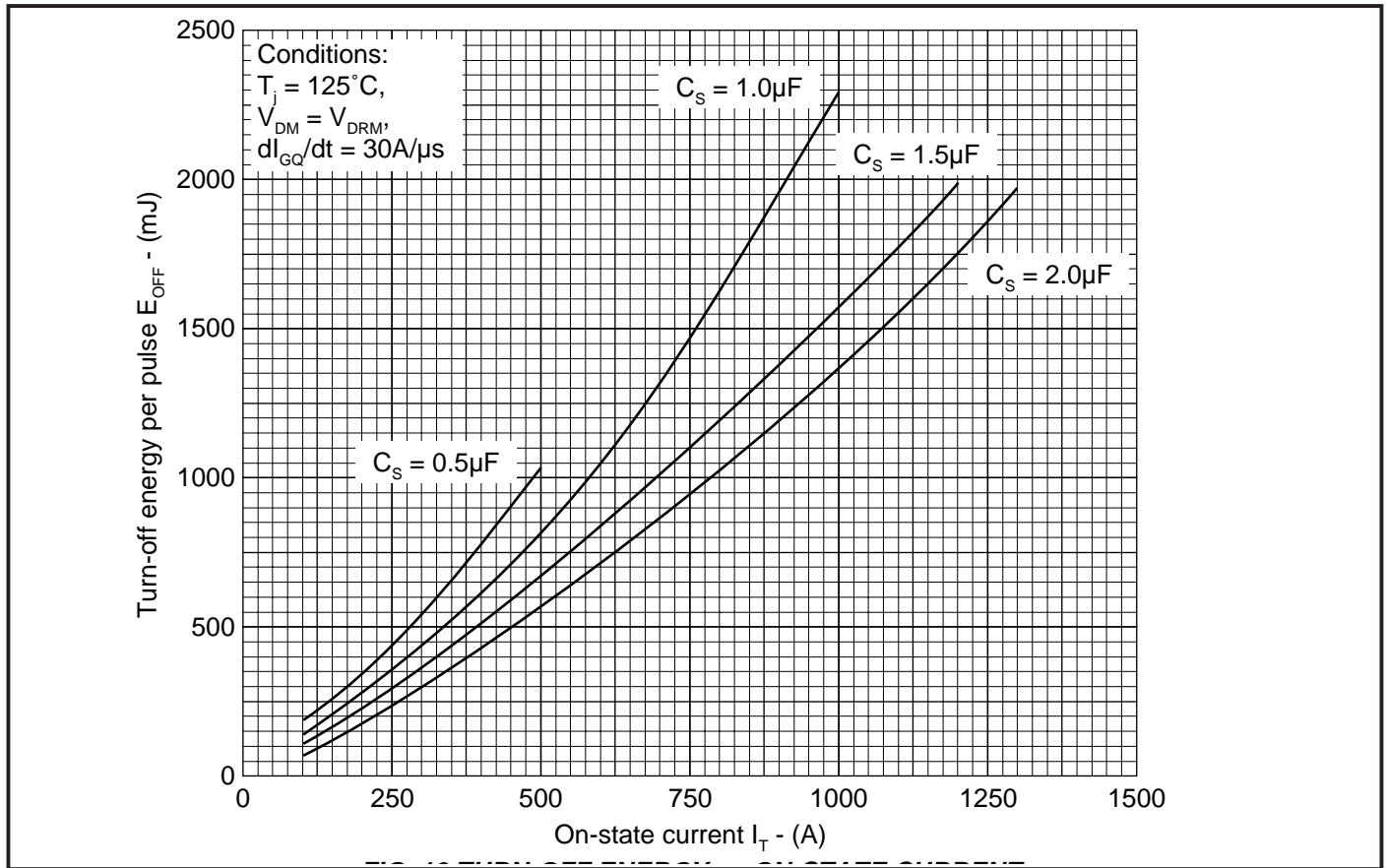

Fig.19 Turn-off energy vs on-state current

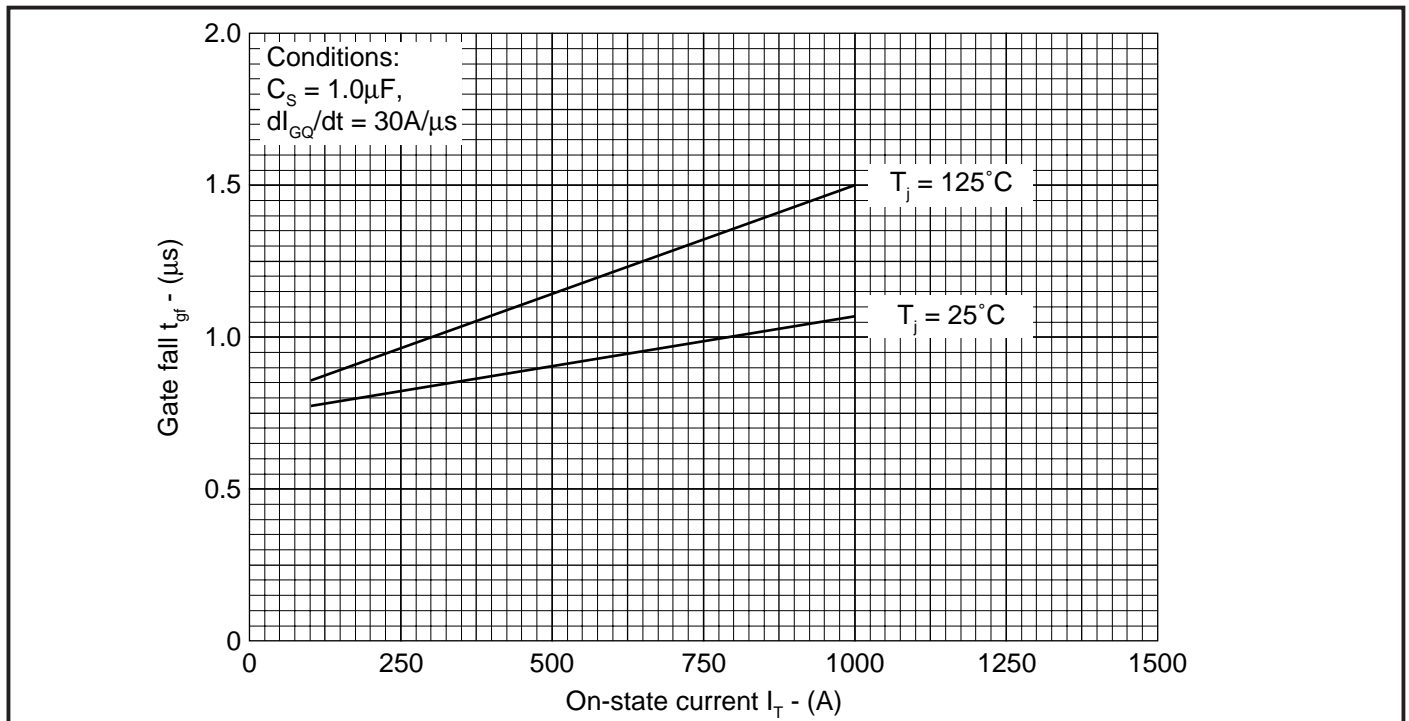

Fig.20 Gate fall time vs on-state current

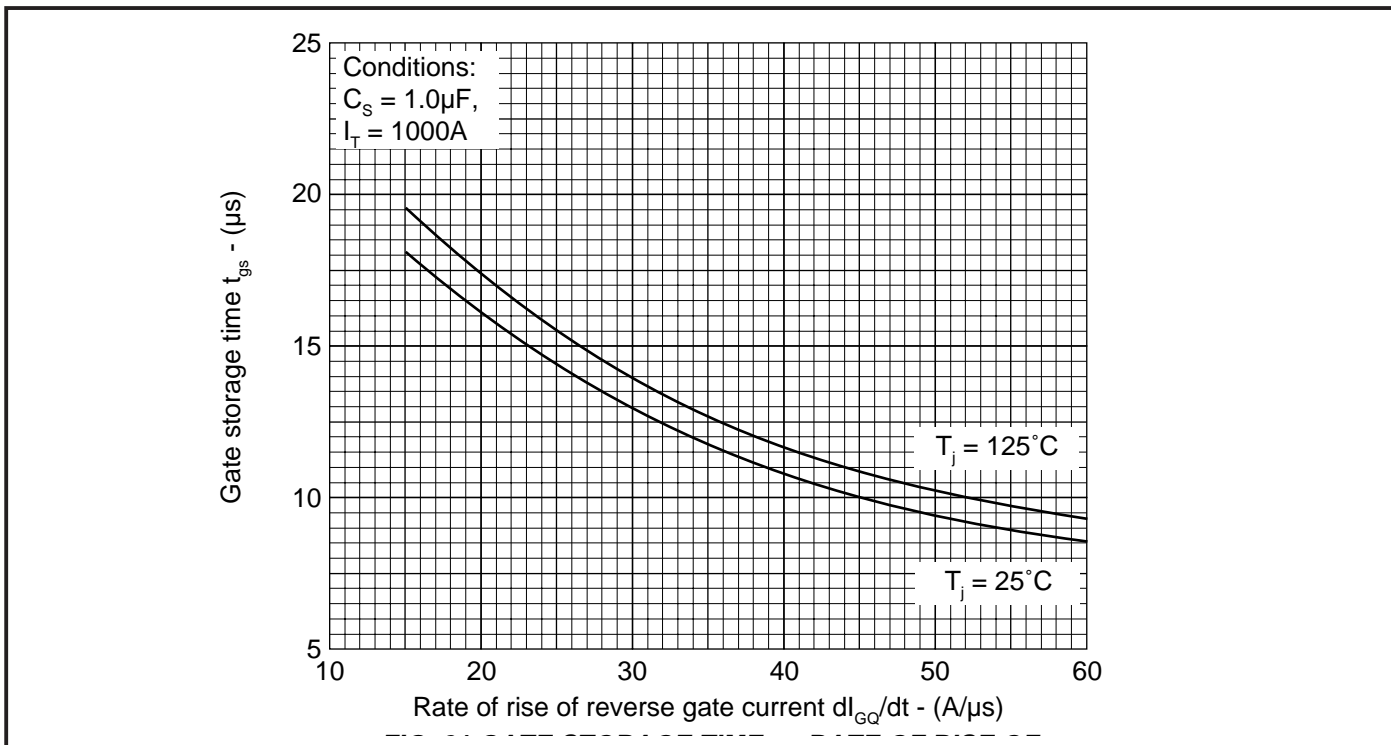

Fig.21 Gate storage time vs rate of rise of reverse gate current

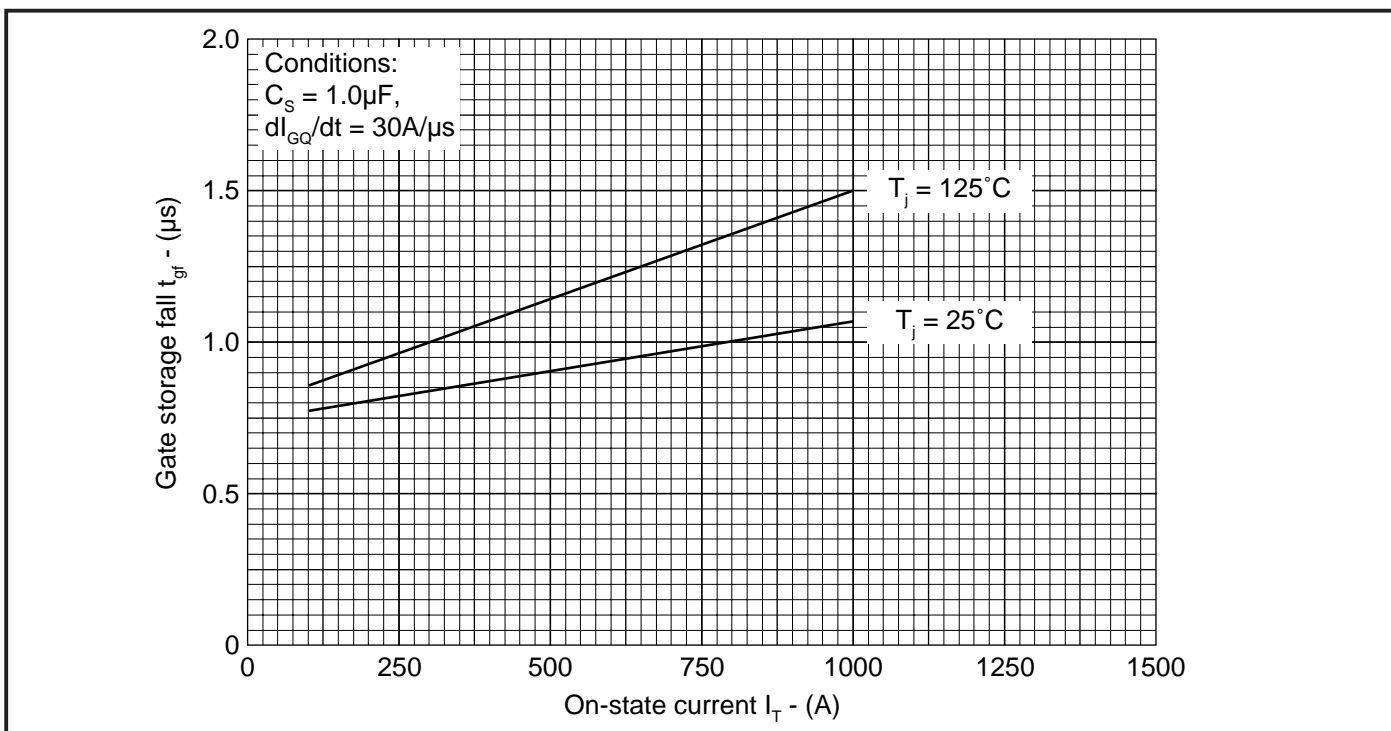

Fig.22 Gate fall time vs on-state current

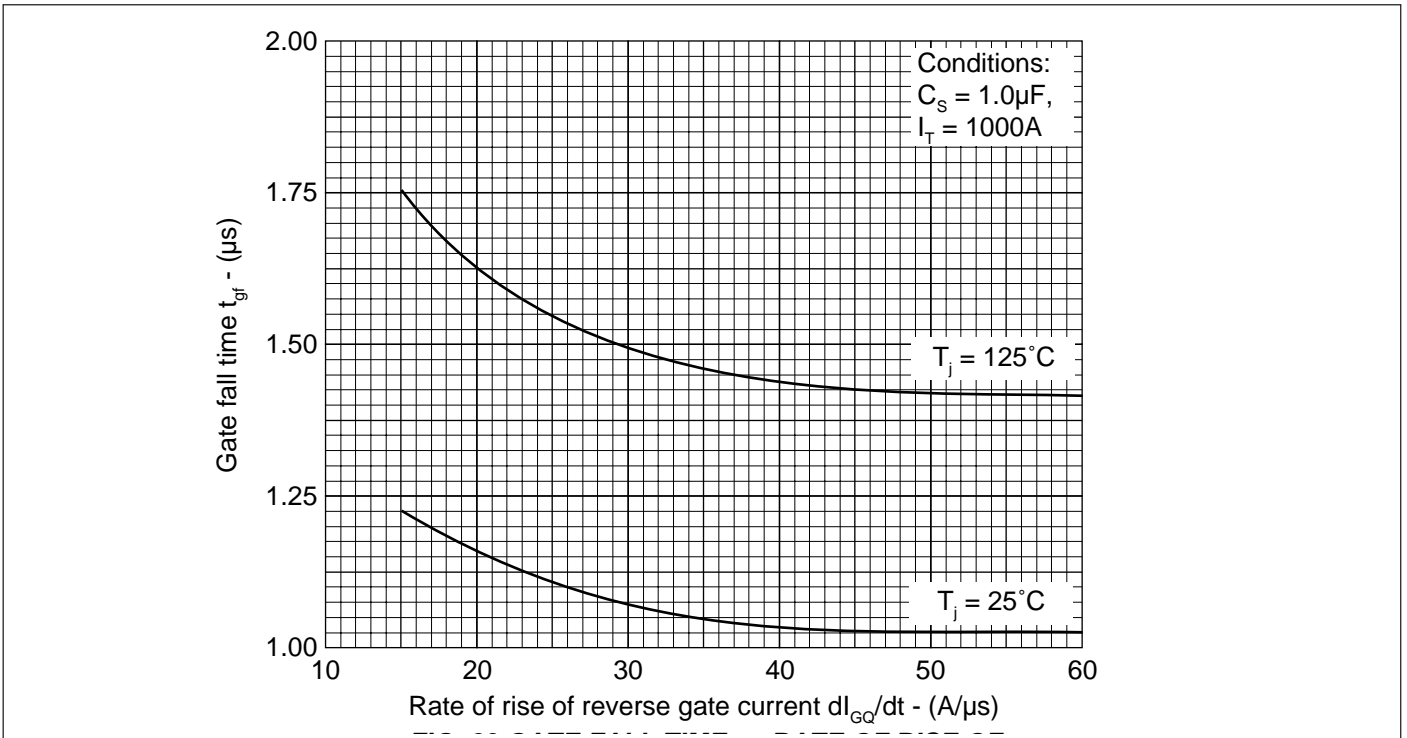

Fig.23 Gate fall time vs rate of rise of reverse gate current

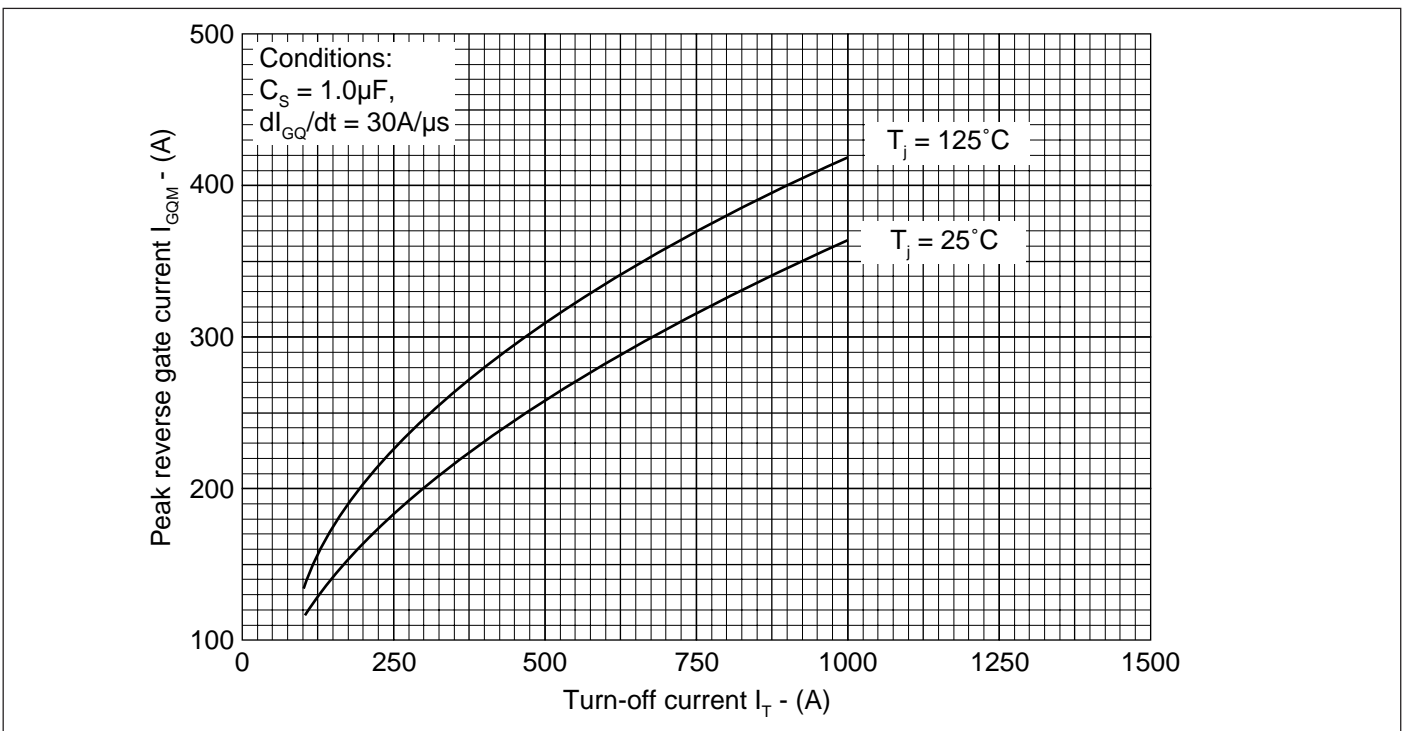

Fig.24 Peak reverse gate current vs turn-off current

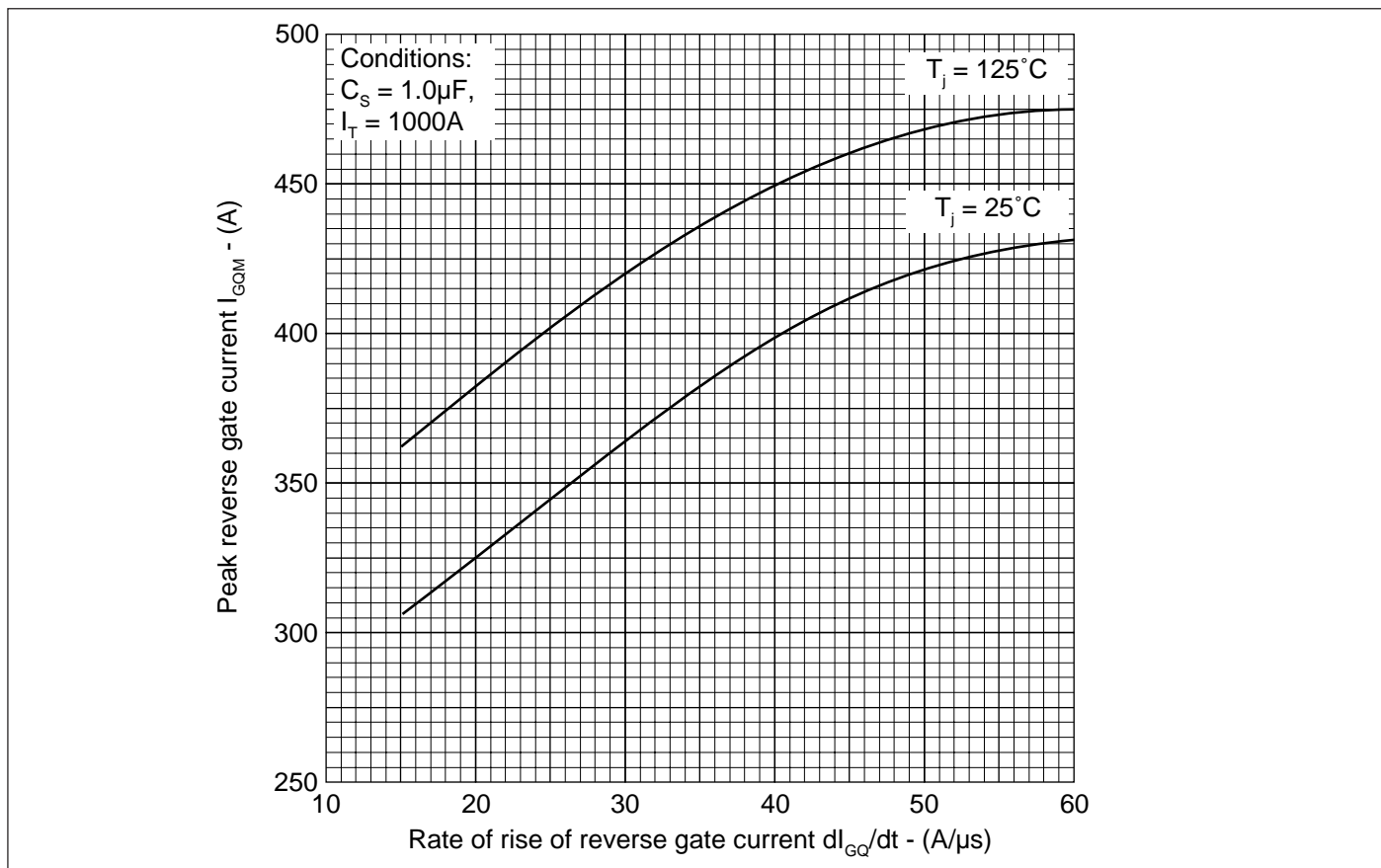

Fig.25 Peak reverse gate current vs rate of rise of reverse gate current

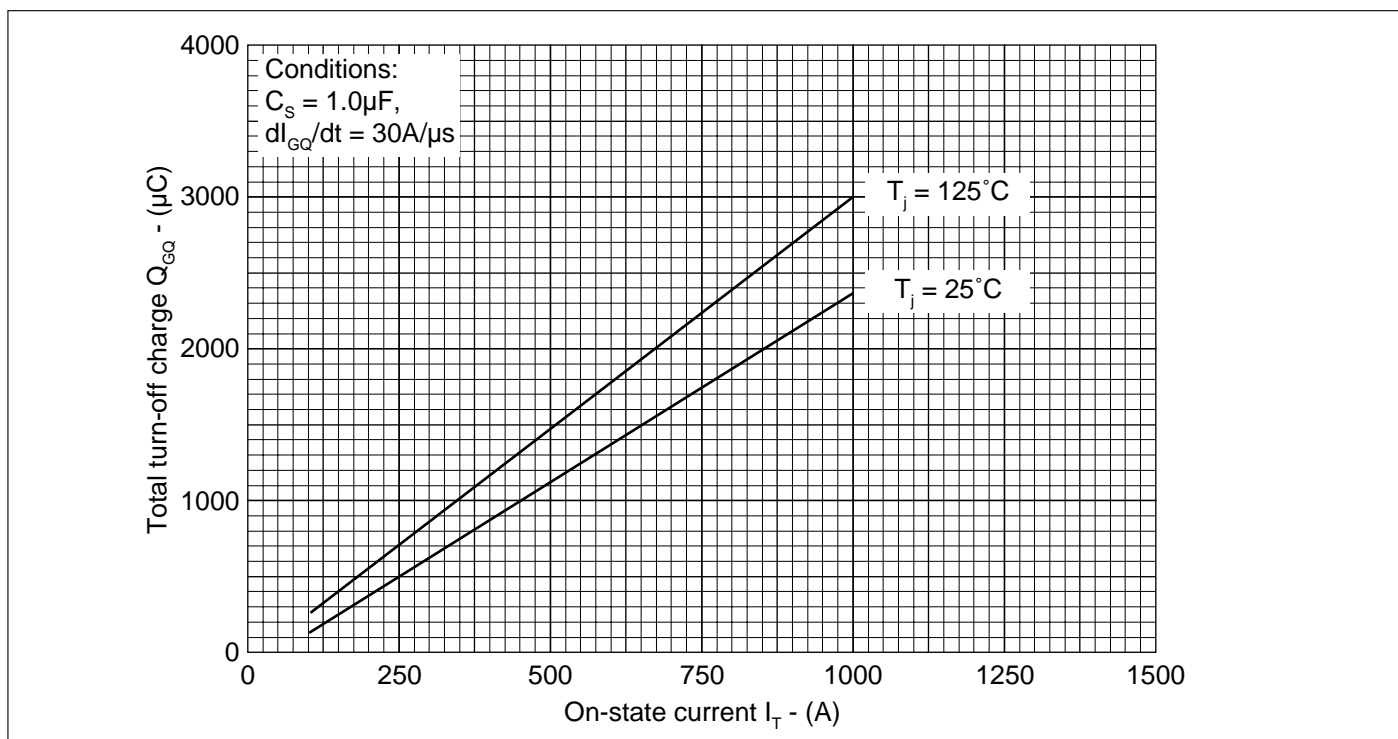

Fig.26 Turn-off gate charge vs on-state current

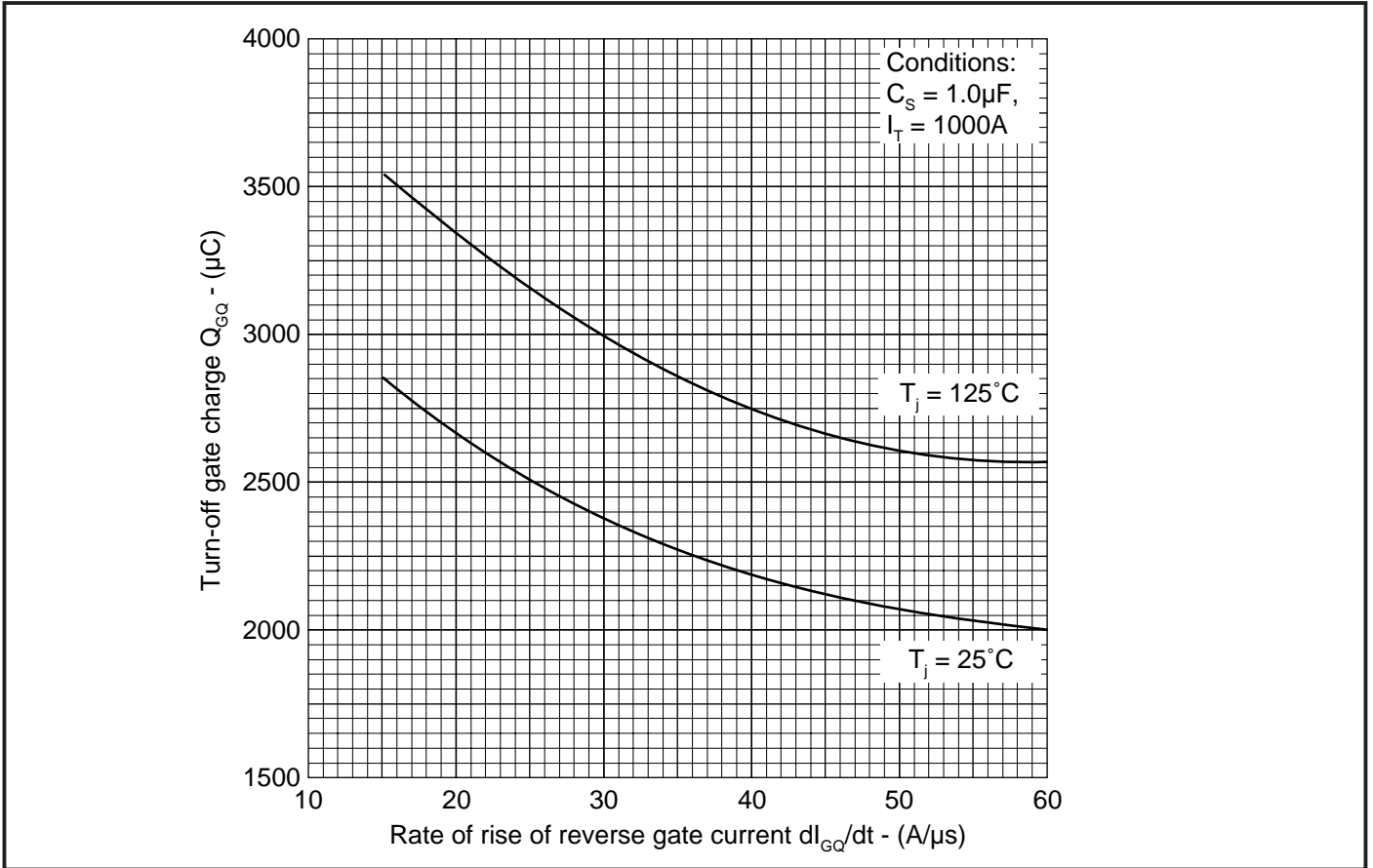

Fig.27 Turn-off gate charge vs rate of rise of reverse gate current

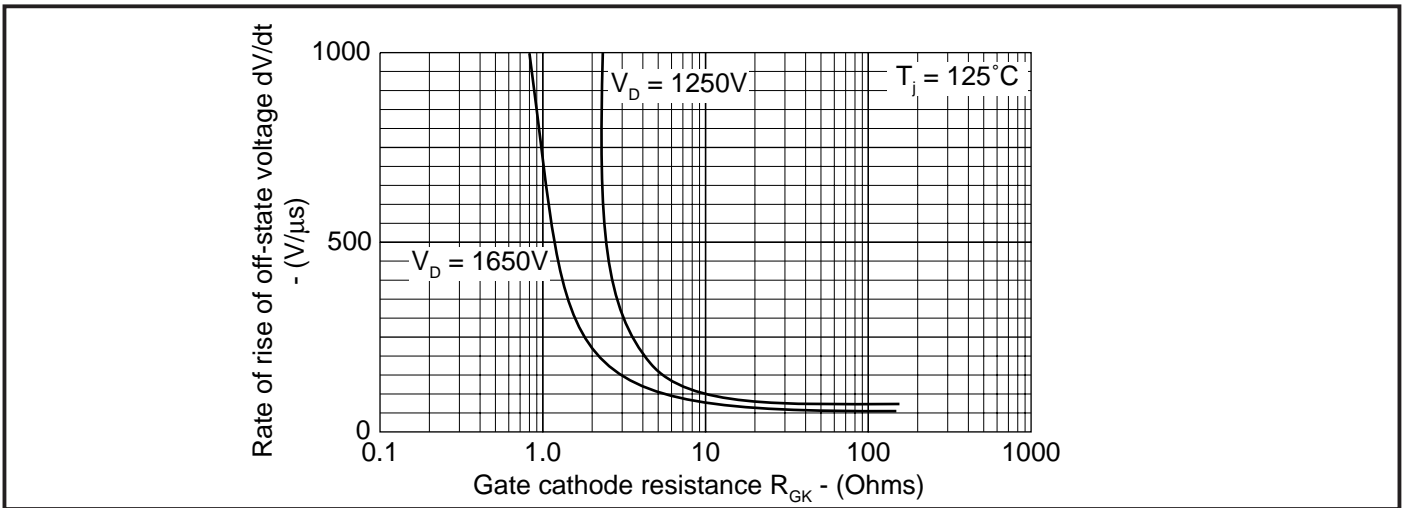
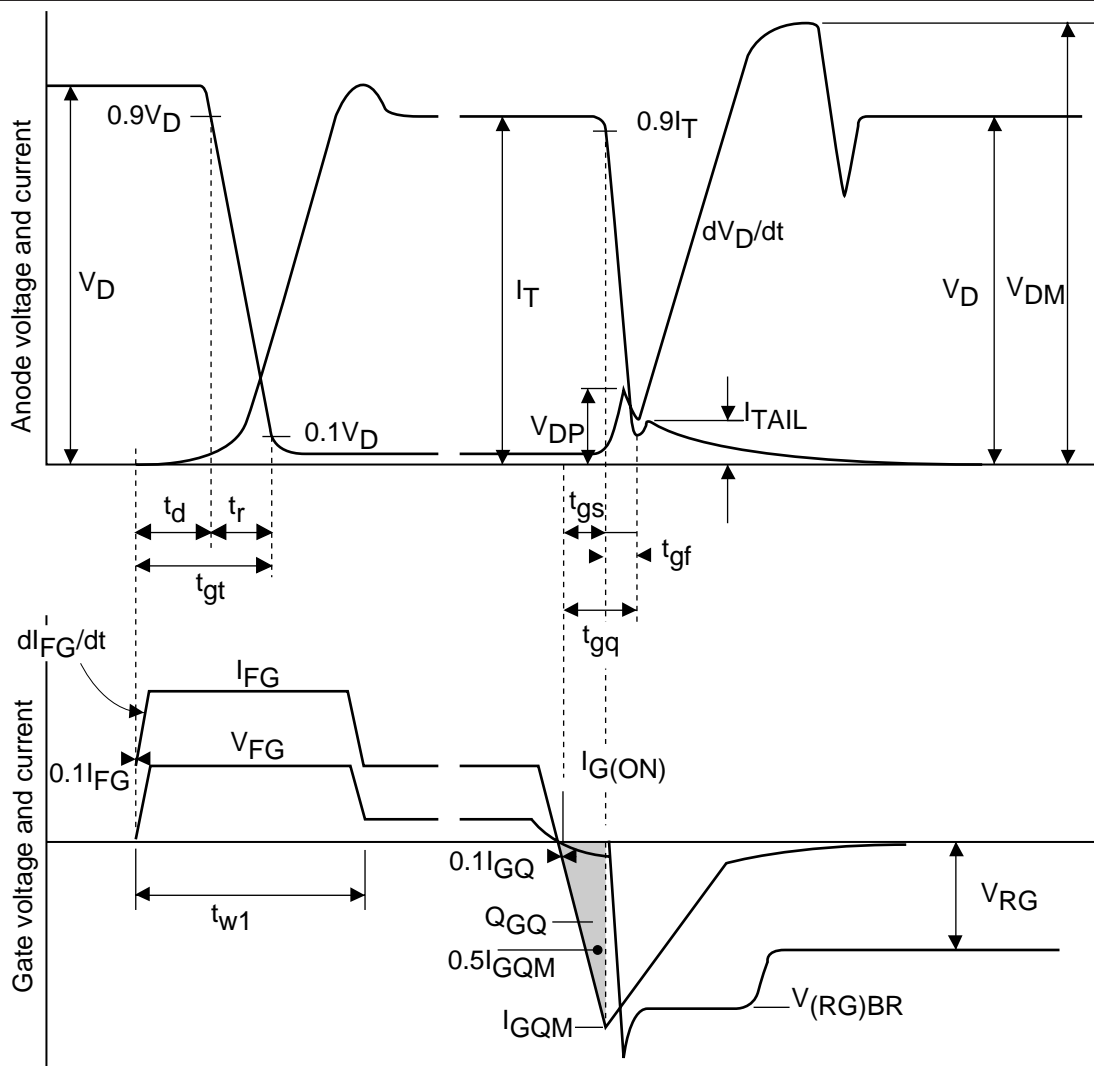

Fig.28 Rate of rise of off-state voltage vs gate cathode resistance



Recommended gate conditions:

- $I_{TCM} = 1000A$
- $I_{FG} = 30A$
- $I_{G(ON)} = 4A$ d.c.
- $t_{w1(min)} = 10\mu s$
- $I_{GQM} = 420A$
- $di_{GQ}/dt = 30A/\mu s$
- $Q_{GQ} = 3000\mu C$
- $V_{RG(min)} = 2V$
- $V_{RG(max)} = 16V$

These are recommended Dynex Semiconductor conditions. Other conditions are permitted according to users gate drive specifications.

Fig.29 General switching waveforms

DG406BP25

PACKAGE DETAILS

For further package information, please contact your local Customer Service Centre. All dimensions in mm, unless stated otherwise. DO NOT SCALE.

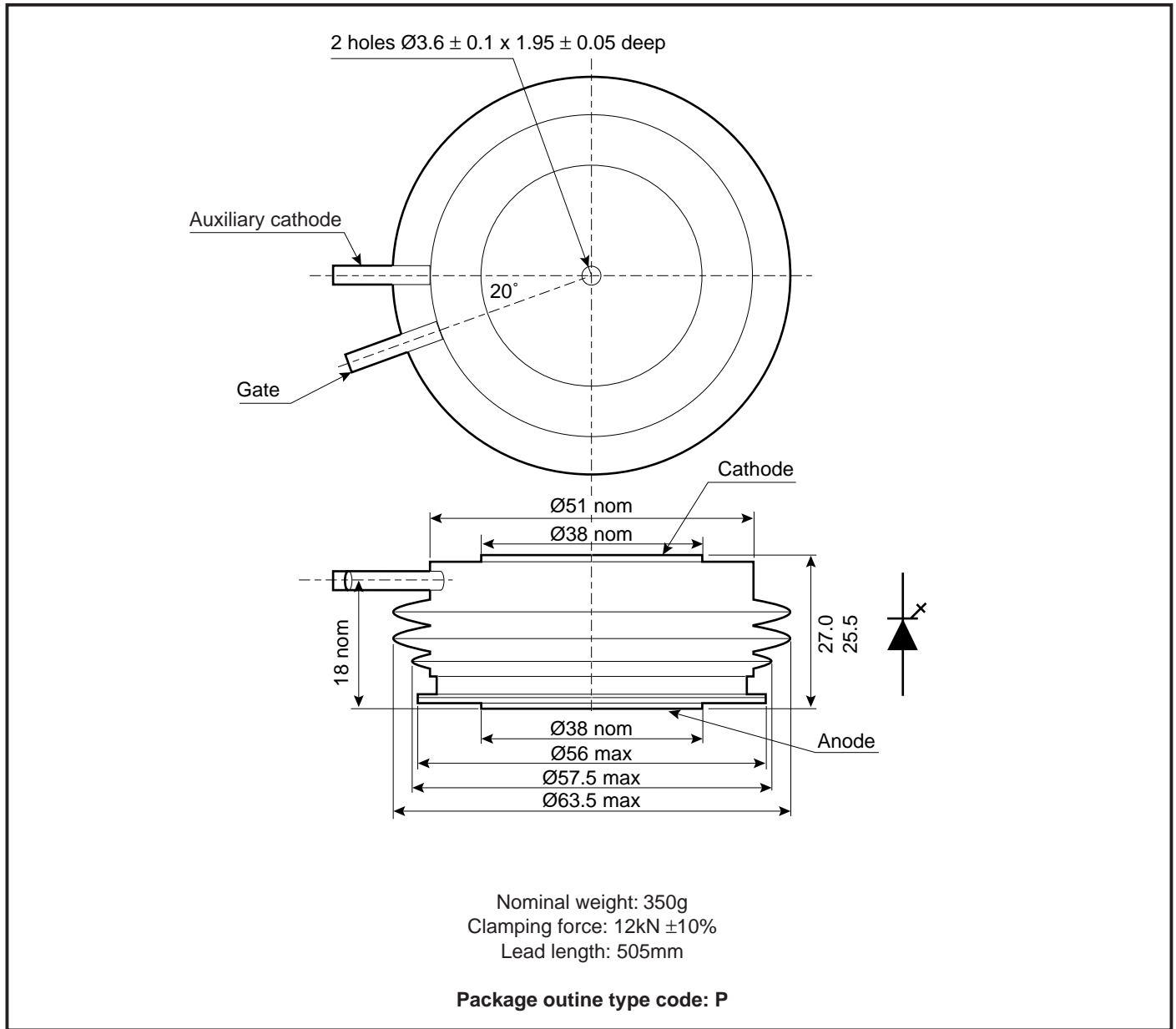

ASSOCIATED PUBLICATIONS

Title	Application Note
	Number
Calculating the junction temperature or power semiconductors	AN4506
GTO gate drive units	AN4571
Recommendations for clamping power semiconductors	AN4839
Use of V_{TO} , r_T on-state characteristic	AN5001
Improved gate drive for GTO series connections	AN5177

POWER ASSEMBLY CAPABILITY

The Power Assembly group was set up to provide a support service for those customers requiring more than the basic semiconductor, and has developed a flexible range of heatsink / clamping systems in line with advances in device types and the voltage and current capability of our semiconductors.

We offer an extensive range of air and liquid cooled assemblies covering the full range of circuit designs in general use today. The Assembly group continues to offer high quality engineering support dedicated to designing new units to satisfy the growing needs of our customers.

Using the up to date CAD methods our team of design and applications engineers aim to provide the Power Assembly Complete solution (PACs).

DEVICE CLAMPS

Disc devices require the correct clamping force to ensure their safe operation. The PACs range offers a varied selection of pre-loaded clamps to suit all of our manufactured devices. This include cube clamps for single side cooling of 'T' 22mm

Clamps are available for single or double side cooling, with high insulation versions for high voltage assemblies.

Please refer to our application note on device clamping, AN4839

HEATSINKS

Power Assembly has it's own proprietary range of extruded aluminium heatsinks. They have been designed to optimise the performance of our semiconductors. Data with respect to air natural, forced air and liquid cooling (with flow rates) is available on request.

For further information on device clamps, heatsinks and assemblies, please contact your nearest Sales Representative or the factory.



<http://www.dynexsemi.com>

e-mail: power_solutions@dynexsemi.com

HEADQUARTERS OPERATIONS
DYNEX SEMICONDUCTOR LTD
 Doddington Road, Lincoln.
 Lincolnshire. LN6 3LF. United Kingdom.
 Tel: 00-44-(0)1522-500500
 Fax: 00-44-(0)1522-500550

DYNEX POWER INC.
 Unit 7 - 58 Antares Drive,
 Nepean, Ontario, Canada K2E 7W6.
 Tel: 613.723.7035
 Fax: 613.723.1518
 Toll Free: 1.888.33.DYNEX (39639)

CUSTOMER SERVICE CENTRES
France, Benelux, Italy and Spain Tel: +33 (0)1 69 18 90 00. Fax: +33 (0)1 64 46 54 50
North America Tel: 011-800-5554-5554. Fax: 011-800-5444-5444
UK, Germany, Scandinavia & Rest Of World Tel: +44 (0)1522 500500. Fax: +44 (0)1522 500020

SALES OFFICES
France, Benelux, Italy and Spain Tel: +33 (0)1 69 18 90 00. Fax: +33 (0)1 64 46 54 50
Germany Tel: 07351 827723
North America Tel: (613) 723-7035. Fax: (613) 723-1518. Toll Free: 1.888.33.DYNEX (39639) /
 Tel: (831) 440-1988. Fax: (831) 440-1989 / Tel: (949) 733-3005. Fax: (949) 733-2986.
UK, Germany, Scandinavia & Rest Of World Tel: +44 (0)1522 500500. Fax: +44 (0)1522 500020
 These offices are supported by Representatives and Distributors in many countries world-wide.
 © Dynex Semiconductor 2000 Publication No. DS4090-3 Issue No. 3.0 January 2000
 TECHNICAL DOCUMENTATION – NOT FOR RESALE. PRINTED IN UNITED KINGDOM

Datasheet Annotations:

Dynex Semiconductor annotate datasheets in the top right hand corner of the front page, to indicate product status. The annotations are as follows:-

Target Information: This is the most tentative form of information and represents a very preliminary specification. No actual design work on the product has been started.

Preliminary Information: The product is in design and development. The datasheet represents the product as it is understood but details may change.

Advance Information: The product design is complete and final characterisation for volume production is well in hand.

No Annotation: The product parameters are fixed and the product is available to datasheet specification.

This publication is issued to provide information only which (unless agreed by the Company in writing) may not be used, applied or reproduced for any purpose nor form part of any order or contract nor to be regarded as a representation relating to the products or services concerned. No warranty or guarantee express or implied is made regarding the capability, performance or suitability of any product or service. The Company reserves the right to alter without prior notice the specification, design or price of any product or service. Information concerning possible methods of use is provided as a guide only and does not constitute any guarantee that such methods of use will be satisfactory in a specific piece of equipment. It is the user's responsibility to fully determine the performance and suitability of any equipment using such information and to ensure that any publication or data used is up to date and has not been superseded. These products are not suitable for use in any medical products whose failure to perform may result in significant injury or death to the user. All products and materials are sold and services provided subject to the Company's conditions of sale, which are available on request.

All brand names and product names used in this publication are trademarks, registered trademarks or trade names of their respective owners.