



DUAL GN SERIES

PANEL MOUNT



Features

- Current rating 25 and 40 Amps
- Output voltage 24-280 VAC and 48-660 VAC
- Direct bond copper substrate
- Back to back dual SCR output
- 4000 VAC optical isolation
- Zero Voltage and Instantaneous Turn-On
- UL/cUL Recognized, CE Compliant



SPECIFICATIONS

Product Selection

	1/4" Quick Connect 280 VAC		1/4" Quick Connect 660 VAC		Locking Connector 280 VAC	
Control Voltage	25 A	40 A	25 A	40 A	25 A	40 A
4-15 VDC	84140000	84140200	84140500	84140600	84140800	84140900
17-32 VDC	84140410	84134210	84140510	84140610	84140810	84140910

Output Specifications ⁽¹⁾

Description	280 VAC	660 VAC
Operating Voltage [Vrms]	24-280	48-600
Transient Voltage(t=1 min.) [Vpk]	550	1000
Maximum Off-State Leakage Current @ Rated Voltage (@ max. line voltage) [mArms]	0.1	0.25

Output Specifications ⁽¹⁾

Description	25 A	40 A
Maximum Load Current [Arms]	25	40
Minimum Load Current [mArms]	100	100
Maximum 1 Cycle Surge Current (50/60Hz) [Apk]	275/300	710/750
1 Second surge current (50/60 Hz @ Ta=25°C) [Apk]	85	150
Maximum On-State Voltage Drop @ Rated Current [Vpk]	1.4	1.3
Thermal Resistance Junction to Case (Rjc) [°C/W]	0.6	0.4
Maximum 1/2 Cycle I ² t for Fusing (50/60Hz) [A ² sec]	380/370	2520/2320
Maximum Off-State dv/dt @ Maximum Rated Voltage [V/μsec]	500	500

Input Specifications ⁽¹⁾

Description	84140x0x	84140x1x
Control Voltage Range [Vdc]	4-15	17-32
Minimum Turn-On Voltage [Vdc]	4	17
Must Turn-Off Voltage [Vdc]	1	1
Minimum Input Current (for on-state) [mA]	7.5	13
Maximum Input Current [mA]	34	24
Nominal Input Impedance [Ohms]	500	1500
Maximum Turn-On Time [msec] ⁽²⁾	1/2 Cycle	
Maximum Turn-Off Time [msec]	1/2 Cycle	

General Specifications ⁽¹⁾

Description	Parameters
Ambient Operating Temperature Range	-40 to 80°C
Ambient Storage Temperature Range	-40 to 100 °C
Input to Output Isolation	4000 Vrms
Input/Output to Ground Isolation	2500 Vrms
Input to Output Capacitance	8 pF
Operation Frequency	47 to 63 Hz
Housing Material	UL94 V-0 (self extinguishing)
Weight (typical)	3.2 oz (91.5g)



MECHANICAL SPECIFICATIONS ⁽¹⁾

Tolerance: ±0.02 in / 0.5 mm

All dimensions are in: inches [millimeters]

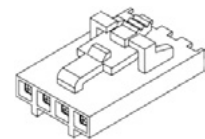
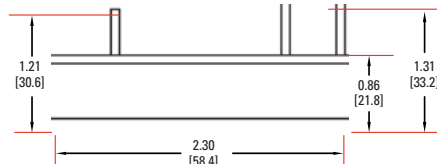
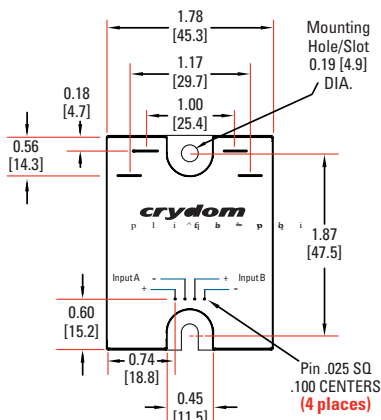

Mating Connector for 841408xxx and 841409xxx
Molex # 50-57-9404 without pins
Crimp Pins Molex # 16-02-0103



WIRING DIAGRAM

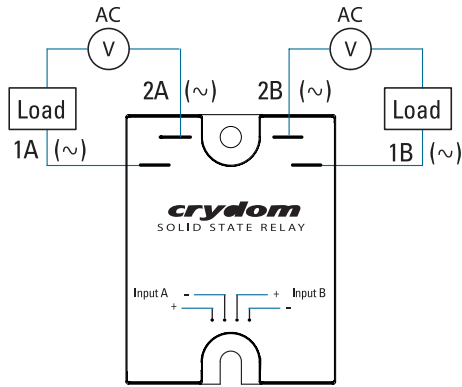

EQUIVALENT CIRCUIT BLOCK DIAGRAMS

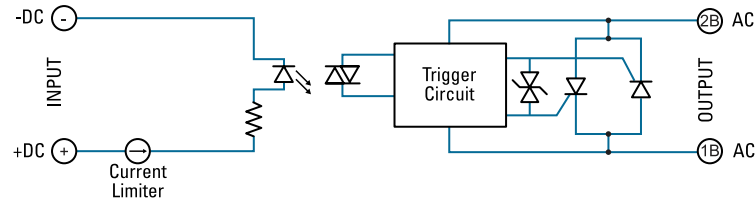
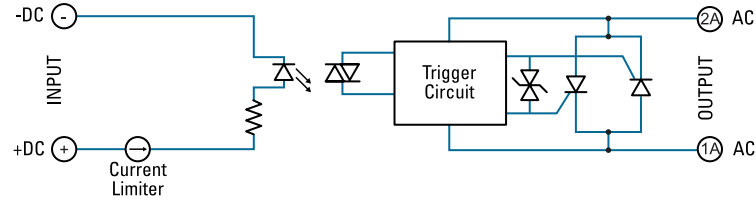

THERMAL DERATE INFORMATION

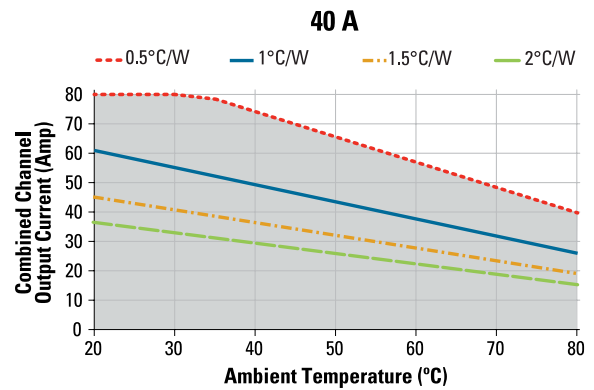
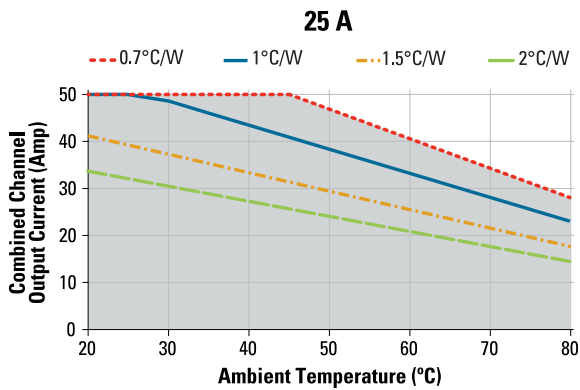

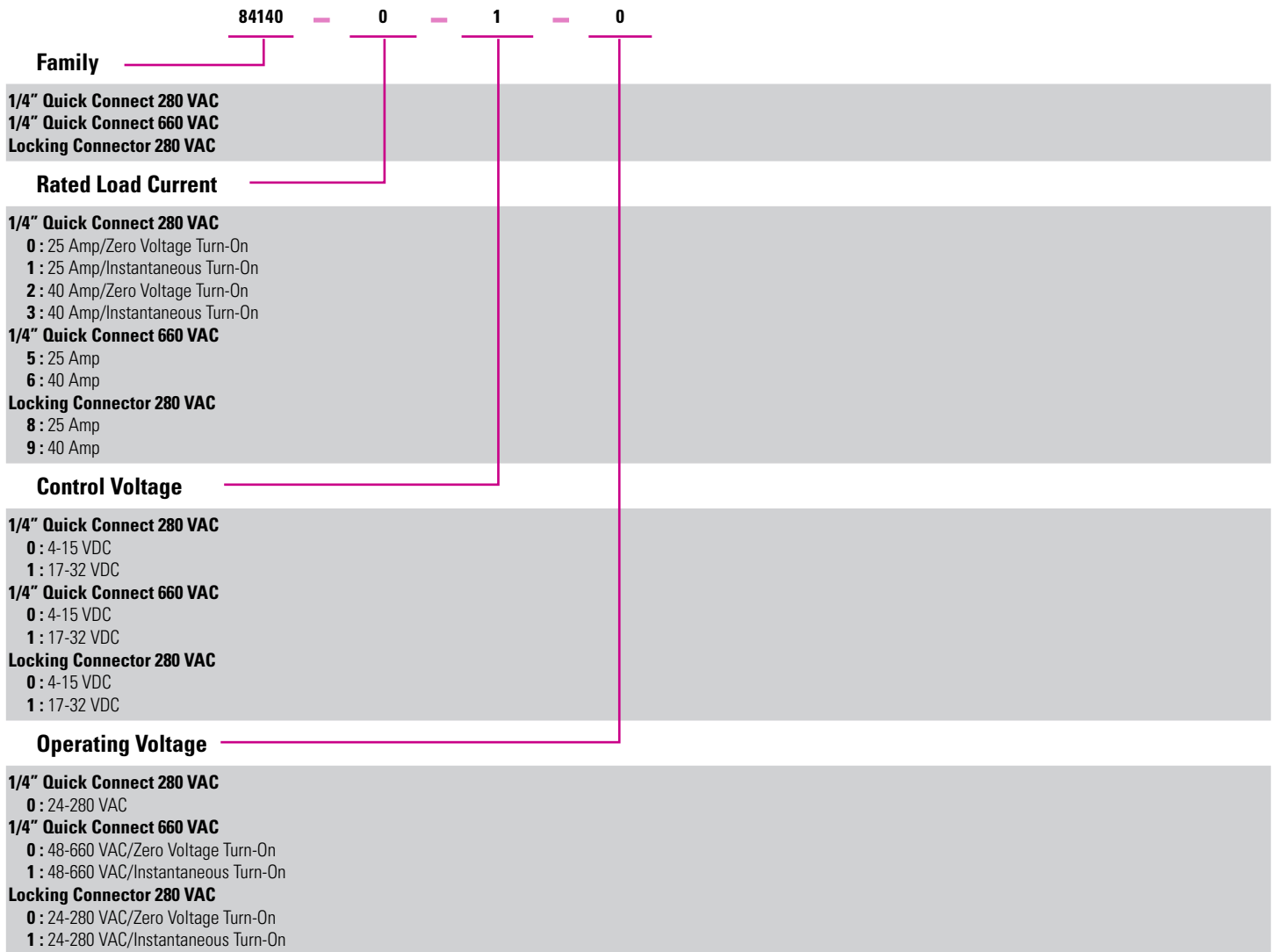

GENERAL NOTES

- (1) All parameters at 25°C unless otherwise specified.
- (2) Turn-on time for Instantaneous turn-on versions is 0.02 msec.

For additional information or specific questions, contact Crydom Technical Support.

AGENCY APPROVALS & CERTIFICATIONS



EN60950-1: Meets the requirements of sections 1.5: 1.7: 2.9: 2.10.5.3: 4.2: 4.5: 4.7:

Certified according to EN 62314:2006

IEC 61000-4-2 Electrostatic Discharge Level 3

IEC 61000-4-4 Electrically Fast Transients Level 3

IEC 61000-4-5 Electrical Surges Level 3

WARNINGS



RISK OF MATERIAL DAMAGE AND HOT ENCLOSURE

- The product's side panels may be hot, allow the product to cool before touching
- Follow proper mounting instructions including torque values
- Do not allow liquids or foreign objects to enter this product

Failure to follow these instructions can result in serious injury, or equipment damage.



HAZARD OF ELECTRIC SHOCK, EXPLOSION OR ARC FLASH

- Disconnect all power before installing or working with this equipment
- Verify all connections and replace all covers before turning on power

Failure to follow these instructions will result in death or serious injury.

Sensata Technologies, Inc. ("Sensata") data sheets are solely intended to assist designers ("Buyers") who are developing systems that incorporate Sensata products (also referred to herein as "components"). Buyer understands and agrees that Buyer remains responsible for using its independent analysis, evaluation and judgment in designing Buyer's systems and products. Sensata data sheets have been created using standard laboratory conditions and engineering practices. Sensata has not conducted any testing other than that specifically described in the published documentation for a particular data sheet. Sensata may make corrections, enhancements, improvements and other changes to its data sheets or components without notice.

Buyers are authorized to use Sensata data sheets with the Sensata component(s) identified in each particular data sheet. HOWEVER, NO OTHER LICENSE, EXPRESS OR IMPLIED, BY ESTOPPEL OR OTHERWISE TO ANY OTHER SENSATA INTELLECTUAL PROPERTY RIGHT, AND NO LICENSE TO ANY THIRD PARTY TECHNOLOGY OR INTELLECTUAL PROPERTY RIGHT, IS GRANTED HEREIN. SENSATA DATA SHEETS ARE PROVIDED "AS IS". SENSATA MAKES NO WARRANTIES OR REPRESENTATIONS WITH REGARD TO THE DATA SHEETS OR USE OF THE DATA SHEETS, EXPRESS, IMPLIED OR STATUTORY, INCLUDING ACCURACY OR COMPLETENESS. SENSATA DISCLAIMS ANY WARRANTY OF TITLE AND ANY IMPLIED WARRANTIES OF MERCHANTABILITY, FITNESS FOR A PARTICULAR PURPOSE, QUIET ENJOYMENT, QUIET POSSESSION, AND NON-INFRINGEMENT OF ANY THIRD PARTY INTELLECTUAL PROPERTY RIGHTS WITH REGARD TO SENSATA DATA SHEETS OR USE THEREOF.

All products are sold subject to Sensata's terms and conditions of sale supplied at www.sensata.com SENSATA ASSUMES NO LIABILITY FOR APPLICATIONS ASSISTANCE OR THE DESIGN OF BUYERS' PRODUCTS. BUYER ACKNOWLEDGES AND AGREES THAT IT IS SOLELY RESPONSIBLE FOR COMPLIANCE WITH ALL LEGAL, REGULATORY AND SAFETY-RELATED REQUIREMENTS CONCERNING ITS PRODUCTS, AND ANY USE OF SENSATA COMPONENTS IN ITS APPLICATIONS, NOTWITHSTANDING ANY APPLICATIONS-RELATED INFORMATION OR SUPPORT THAT MAY BE PROVIDED BY SENSATA.

Mailing Address: Sensata Technologies, Inc., 529 Pleasant Street, Attleboro, MA 02703, USA.

CONTACT US

Americas

+1 (877) 502 5500
sales.crydom@sensata.com

Europe, Middle East & Africa

+44 (1202) 416170
ssr-info.eu@sensata.com

Asia Pacific

sales.isasia@list.sensata.com
China +86 (21) 2306 1500
Japan +81 (45) 277 7117
Korea +82 (31) 601 2004
India +91 (80) 67920890
Rest of Asia +886 (2) 27602006
ext 2808