

Circuit Breaker for Equipment thermal, 2 pole, Push button actuation, with undervoltage



See below:

Approvals and Compliances

Description

- Thermal circuit breaker
- 1 or 2 pole thermal overload protection
- Positively trip-free release
- High configurability
- Snap-in or flange mounted
- Quick connect terminal 6.3 x 0.8 mm or screw clamp terminal M3.5 x 6 mm (lineside P1, P2)

Applications

- Power tools
- Industrial appliances
- Power supplies

References

Alternative: Standard version [TA45-2P](#)

Weblinks

[pdf data sheet](#), [html datasheet](#), [General Product Information](#), [Distributor-Stock-Check](#), [Detailed request for product](#), [Product News](#)

Technical Data

Rated Voltage AC	AC 240 VAC
Rated Voltage DC	60 VDC
Rated current range AC	0.05 - 20 A
Conditional short circuit capacity I _{nc}	IEC 60934: PC1, AC 240 V: 1 kA
Short circuit capacity I _{cn}	IEC 60934: At I _n < 3 A/ 240 VAC: 10xI _n (max. 3 cycles) At I _n ≥ 3 A/ 240 VAC: 300A (max. 3 cycles) At I _n < 3 A/ 60 VDC: 10xI _n (max. 3 cycles) At I _n ≥ 3 A/ 48 VDC: 120A (max. 3 cycles)
Degree of Protection	front side IP40 acc. to IEC 60529
Dielectric Strength	4 kV
Insulation Resistance	500 VDC > 100 MΩ
Lifetime	mechanical: 50'000 switching cycles AC: 1 x I _r : 50'000 switching cycles DC: 1 x I _r : 50'000 switching cycles

Overload	AC: min. 40 trips @ 6 x I _r DC: min. 50 trips @ 4 x I _r
Allowable Operation Temp.	-10 °C to 55 °C
Vibration Resistance	± 0.75 mm @ 5 - 60 Hz acc. to IEC 60068-2-6, test Fc 10 G @ 60 - 500 Hz acc. to IEC 60068-2-6, test Fc
Shock Resistance	30 G / 18 ms acc. to IEC 60068-2-27, test Ea
Possible Tripping Types	Thermal Undervoltage release Remote trip Mechanical lock-out latch
Actuation Type	Pushbutton
Weight	45 - 60g

Approvals and Compliances



Detailed information on product approvals, code requirements, usage instructions and detailed test conditions can be looked up in [Details about Approvals](#)

SCHURTER products are designed for use in industrial environments. They have approvals from independent testing bodies according to national and international standards. Products with specific characteristics and requirements such as required in the automotive sector according to IATF 16949, medical technology according to ISO 13485 or in the aerospace industry can be offered exclusively with customer-specific, individual agreements by SCHURTER.

Approvals



The approval mark is used by the testing authorities to certify compliance with the safety requirements placed on electronic products.

Approval Reference Type: TA45

Approval Logo	Certificates	Certification Body	Description
	VDE Approvals	VDE	VDE Certificate Number: 40019880
	UL Approvals	UL	UL File Number: E71572
	CCC Approvals	CCC	CCC Certificate Number: 2020970307001847

Product standards

Product standards that are referenced

Organization	Design	Standard	Description
	Designed according to	IEC 60934	Circuit-breakers for equipment (CBE)
	Designed according to	UL 1077	Standard for Supplementary Protectors for Use in Electrical Equipment
	Designed according to	CSA C22.2 No. 235	Supplementary Protectors
	Designed according to	GB 17701	Circuit-breaker for equipment





Application standards

Application standards where the product can be used

Organization	Design	Standard	Description
	Designed for applications acc.	IEC/UL 62368-1	IEC 62368-1 includes the basic requirements for safety of audio, video, information technology and office equipment.

Compliances

The product complies with following Guide Lines

Identification	Details	Initiator	Description
	CE declaration of conformity	SCHURTER AG	The CE marking declares that the product complies with the applicable requirements laid down in the harmonisation of Community legislation on its affixing in accordance with EU Regulation 765/2008.
	RoHS	SCHURTER AG	Directive RoHS 2011/65/EU, Amendment (EU) 2015/863
	China RoHS	SCHURTER AG	The law SJ / T 11363-2006 (China RoHS) has been in force since 1 March 2007. It is similar to the EU directive RoHS.
	REACH	SCHURTER AG	On 1 June 2007, Regulation (EC) No 1907/2006 on the Registration, Evaluation, Authorization and Restriction of Chemicals 1 (abbreviated as "REACH") entered into force.

Dimension [mm]

Snap-in type and quick connect terminal
 Undervoltage release, remote trip release

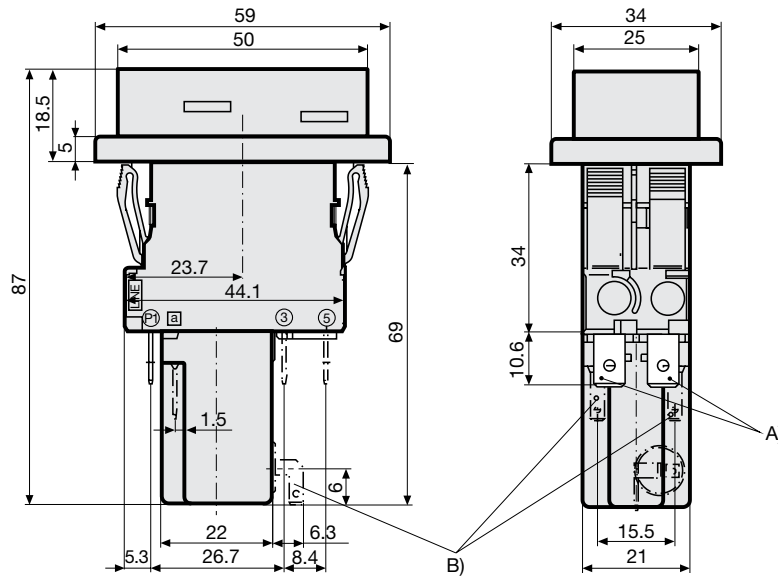

- A) Quick connect terminal, IEC 61210, A6.3-0.8 mm
- B) Quick connect terminal, IEC 61210, A2.8-0.8 mm

Snap-in type and quick connect terminal
 Mechanical lock-out latch

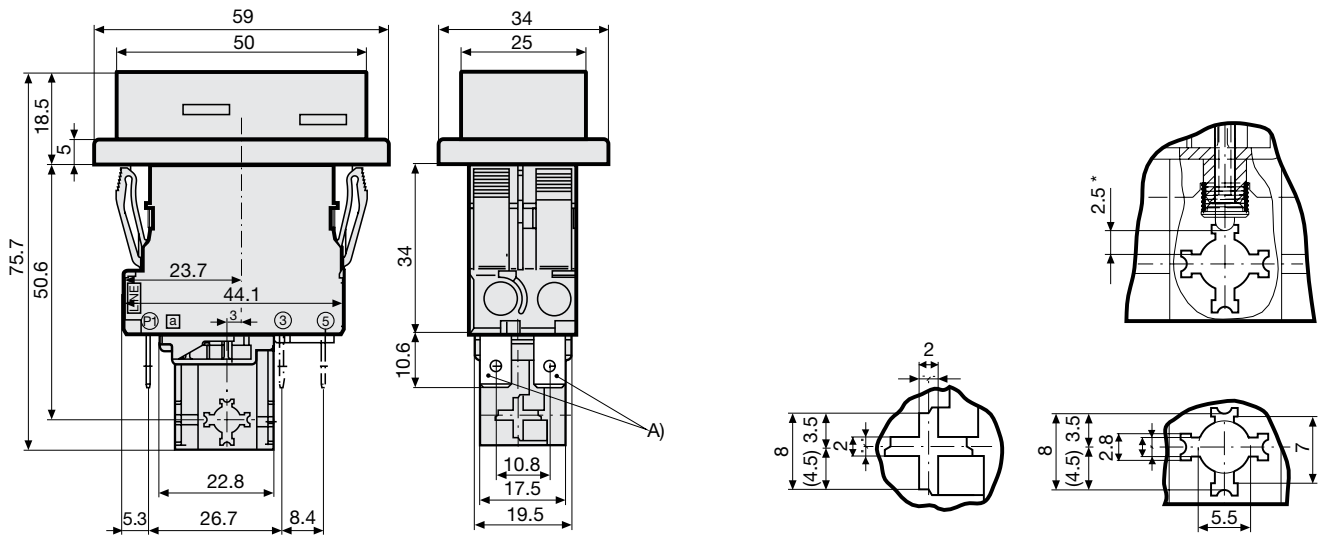

- A) Quick connect terminal, IEC 61210, A6.3-0.8 mm

*) max. switching stroke

Flange type and quick connect terminal
 Undervoltage release, remote trip release

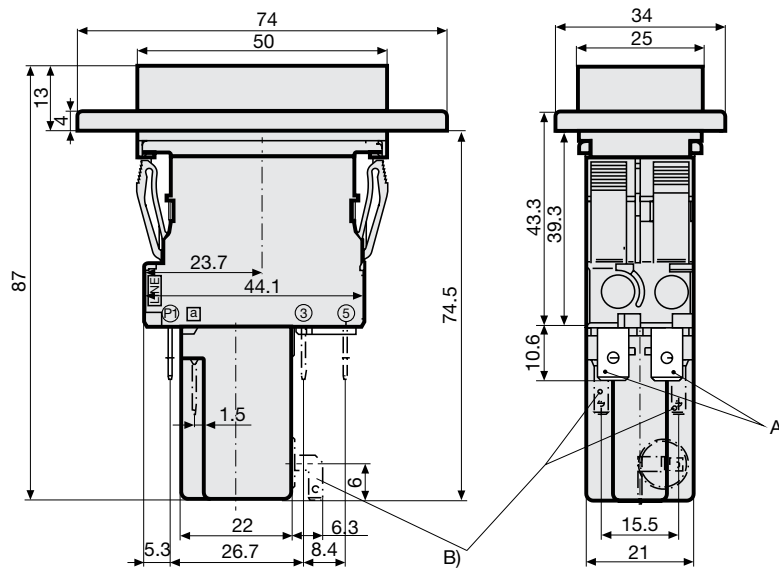

A) Quick connect terminal, IEC 61210, A6.3-0.8 mm
 B) Quick connect terminal, IEC 61210, A2.8-0.8 mm

Flange type and quick connect terminal
 Mechanical lock-out latch

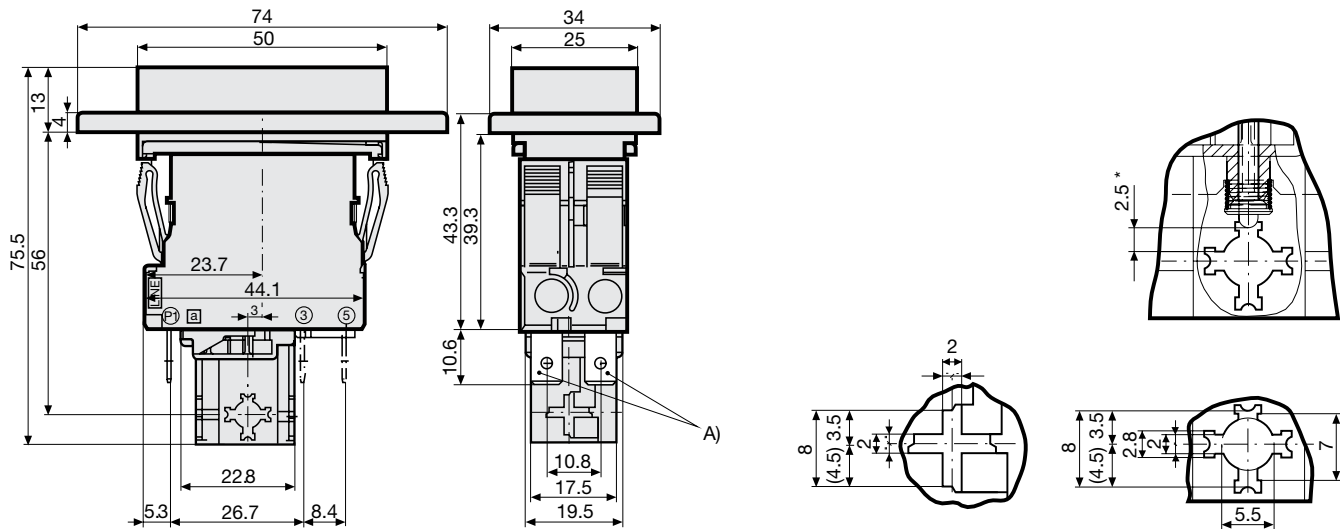

A) Quick connect terminal, IEC 61210, A6.3-0.8 mm

*) max. switching stroke

Cut-out and pin-out

Cut-out snap-in type

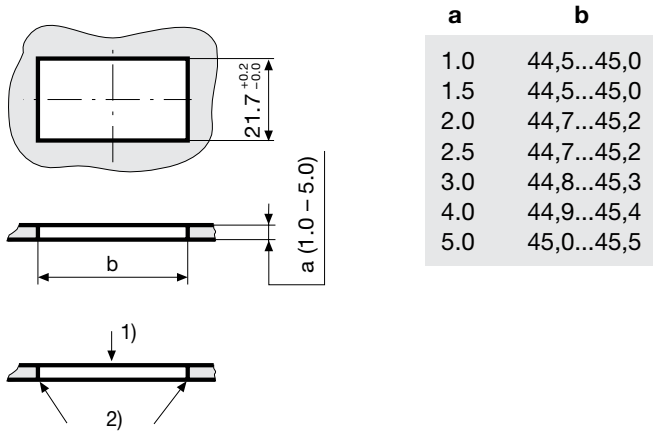

1) Assemble

2) edge must be sharp

Cut-out flange type/ Installation from rear with AZZ05 cover

Cut-out flange type / Installation from rear

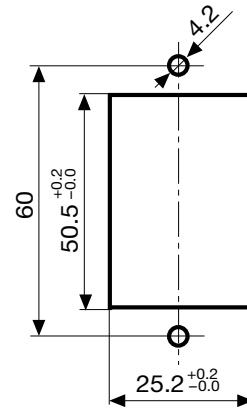

Pin-out

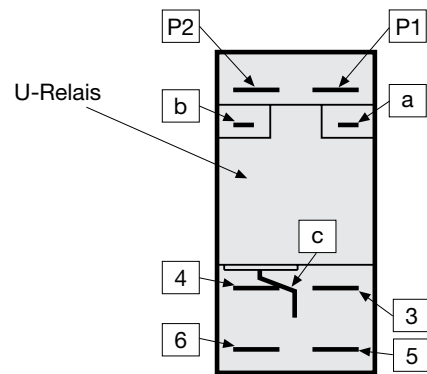
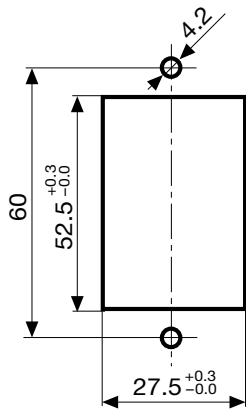

Diagrams

1 pole thermal overload protection

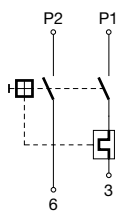

1 pole thermal overload protection, Shunt terminal

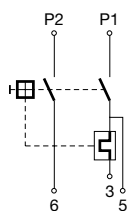

2 pole thermal overload protection

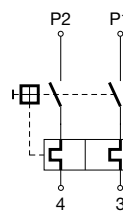

2 pole thermal overload protection, Shunt terminal

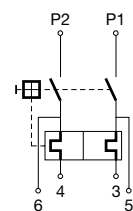

Time-Current-Curves

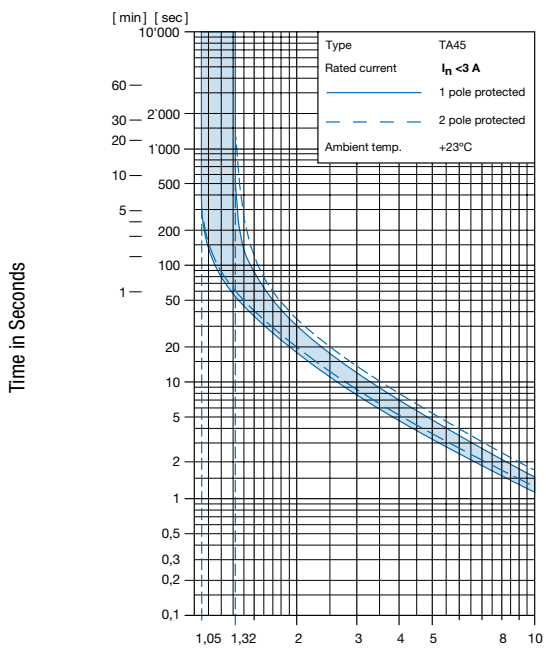

Multiple of Rated Current I_n

Reference Temperature +23°

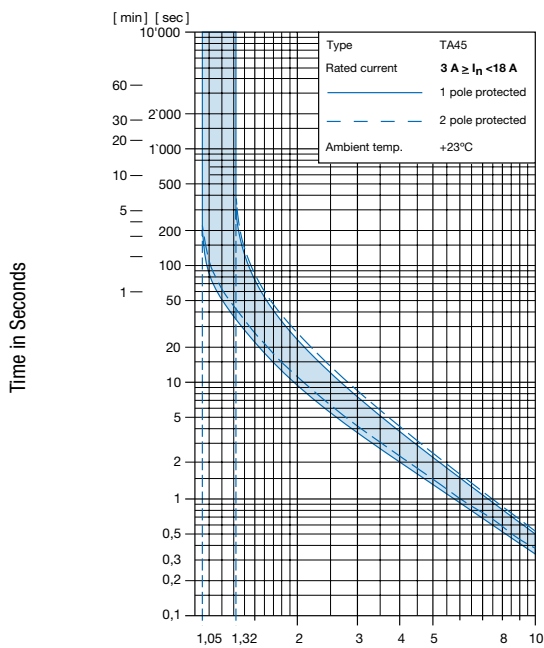

Multiple of Rated Current I_n

Reference Temperature +23°

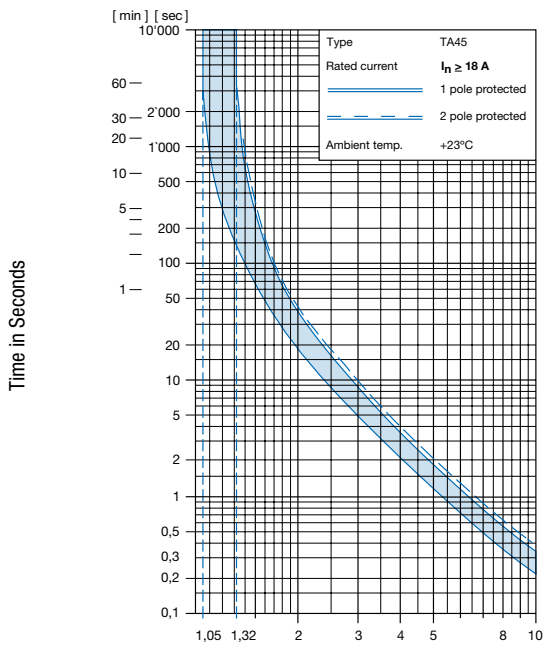

Multiple of Rated Current I_n

Reference Temperature +23°

Effect of ambient temperature

The units are calibrated for an ambient temperature of +23°C. To determine the rated current for a lower or higher ambient temperature, use a correction factor (typical value) from the table below:

Ambient Temperature [°C]	Correction factor
-10	0.89
-5	0.91
0	0.92
+23	1.00
+30	1.03
+40	1.08
+55	1.16

Example: Rated current = 5 A, Environmental temperature = 40 °C, --> Correction factor = 1.08, Resulting current = 5.5 A --> Found to next higher rated current: 6 A

Undervoltage release

Max. operating voltage							1.1 Ue
Rated operating voltage Ue	5 V	12 V	24 V	48 V	120 V	240 V	400 V ¹⁾
Current consumption (± 10%)	10.5 mA	16.5 mA	17.0 mA	3.2 mA	3.7 mA	3.1 mA	2.65 mA
Highest reset level							0.85 Ue
Lowest trip level							0.20 Ue
Trip delay							20 ms - 50 ms
Impulse withstand voltage (1.2 / 50 µs)							≥4 kV
1) only for 3pole							

Remote trip

Permissible impuls duration of the make contact (no)	Between terminal C and P1	unlimited
Electrical load of the make contact (no)	Current max. 12 mA / power max. 1.1 W	

Config. Code

TA45 - AK2 W F 120 A2 - AZM11

The characters are placeholders for the correspondingly keys of selections from the key tables.

TA45 - **AK2** W F 120 A2 - AZM11 = Basic function

Basic function	Configuration key
2-pole, push button, 1 pole overload protection, quick connect terminal, snap-in type, push button gasket IP40	ABL
2-pole, push button, 1 pole overload protection, shunt terminal, quick connect terminal, snap-in type, push button gasket IP40	ABM
2-pole, push button, 2pole overload protection, quick connect terminal, snap-in type, push button gasket IP40	ABN
2-pole, push button, 2p overload protection, shunt terminal, quick connect terminal, snap-in type, push button gasket IP40	ABP
2-pole, push button, 1 pole overload protection, quick connect terminal, snap-in type, push button gasket IP65	ABU
2-pole, push button, 1 pole overload protection, shunt terminal, quick connect terminal, snap-in type, push button gasket IP65	ABV
2-pole, push button, 2pole overload protection, quick connect terminal, snap-in type, push button gasket IP65	ABW
2-pole, push button, 2p overload protection, shunt terminal, quick connect terminal, snap-in type, push button gasket IP65	ABX
2-pole, push button, 1 pole overload protection, screw connection, snap-in type, push button gasket IP40	AEL
2-pole, push button, 1p overload protection, shunt terminal, screw connection, snap-in type, push button gasket IP40	AEM
2-pole, push button, 2pole overload protection, screw connection, snap-in type, push button gasket IP40	AEN
2-pole, push button, 2p overload protection, shunt terminal, screw connection, snap-in type, push button gasket IP40	AEP









Basic function	Configuration key
2-pole, push button, 1 pole overload protection, screw connection, snap-in type, push button gasket IP65	AEU
2-pole, push button, 1p overload protection, shunt terminal, screw connection, snap-in type, push button gasket IP65	AEV
2-pole, push button, 2pole overload protection, screw connection, snap-in type, push button gasket IP65	AEW
2-pole, push button, 2p overload protection, shunt terminal, screw connection, snap-in type, push button gasket IP65	AEX
2-pole, push button, 1 pole overload protection, quick connect terminal, flange type, push button gasket IP40	AHL
2-pole, push button, 1 pole overload protection, shunt terminal, quick connect terminal, flange type, push button gasket IP40	AHM
2-pole, push button, 2pole overload protection, quick connect terminal, flange type, push button gasket IP40	AHN
2-pole, push button, 2p overload protection, shunt terminal, quick connect terminal, flange type, push button gasket IP40	AHP
2-pole, push button, 1 pole overload protection, quick connect terminal, flange type, push button gasket IP65	AHU
2-pole, push button, 1 pole overload protection, shunt terminal, quick connect terminal, flange type, push button gasket IP65	AHV
2-pole, push button, 2pole overload protection, quick connect terminal, flange type, push button gasket IP65	AHW
2-pole, push button, 2p overload protection, shunt terminal, quick connect terminal, flange type, push button gasket IP65	AHX
2-pole, push button, 1 pole overload protection, screw connection, flange type, push button gasket IP40	AJL

Basic function	Configuration key
2-pole, push button, 1p overload protection, shunt terminal, screw connection, flange type, push button gasket IP40	AJM
2-pole, push button, 2pole overload protection, screw connection, flange type, push button gasket IP40	AJN
2-pole, push button, 2p overload protection, shunt terminal, screw connection, flange type, push button gasket IP40	AJP
2-pole, push button, 1pole overload protection, screw connection, flange type, push button gasket IP65	AJU
2-pole, push button, 1p overload protection, shunt terminal, screw connection, flange type, push button gasket IP65	AJV
2-pole, push button, 2pole overload protection, screw connection, flange type, push button gasket IP65	AJW
2-pole, push button, 2p overload protection, shunt terminal, screw connection, flange type, push button gasket IP65	AJX

TA45 - AK2 **W** F 120 A2 - AZM11 = Actuator colour

Actuator colour	Configuration key
Front Black: Green/Red	T
Front Yellow: Green/Red	U
Front Grey: Green/Red	V

TA45 - AK2 **W** F 120 A2 - AZM11 = Legend

Legend	Configuration key
embossed 	F
white printed 	H
black printed 	K
white printed 	L
black printed 	M
white printed 	P
black printed 	R
white printed 	S
black printed 	T

TA45 - AK2 **W** F 120 A2 - AZM11 = Rated current

Rated current	Configuration key
0.05 A	Z05
0.1 A	J01
0.2 A	J02
0.3 A	J03
0.4 A	J04
0.5 A	J05

Other rated currents on request

Rated current	Configuration key
0.6 A	J06
0.7 A	J07
0.8 A	J08
0.9 A	J09
1.0 A	J10
1.1 A	J11
1.2 A	J12
1.3 A	J13
1.4 A	J14
1.5 A	J15
1.6 A	J16
1.7 A	J17
1.8 A	J18
1.9 A	J19
2.0 A	J20
2.1 A	J21
2.2 A	J22
2.3 A	J23
2.5 A	J25
2.8 A	J28
3.0 A	030
3.5 A	035
4.0 A	040
4.5 A	045
5.0 A	050
6.0 A	060
6.5 A	065
7.0 A	070
7.5 A	075
8.0 A	080
9.0 A	090
10.0 A	100
11.0 A	110
12.0 A	120
13.0 A	130
14.0 A	140
15.0 A	150
16.0 A	160
17.0 A	170
18.0 A	180
19.0 A	190
20.0 A	200

Other rated currents on request

TA45 - AK2 **W** F 120 **A2** - AZM11 = Release / lock-out latch

Release / lock-out latch	Configuration key
Remote trip release, rated voltage 240 V AC	A2
Remote trip release, rated voltage 230 V AC	A3
Remote trip release, rated voltage 120 V AC	A4
Remote trip release, rated voltage 48 V AC / DC	A6
Remote trip release, rated voltage 24 V AC / DC	A7
Remote trip release, rated voltage 12 V AC / DC	A8
Undervoltage release with additional contact, rated voltage 240 V AC	E2

Release / lock-out latch	Configuration key	Release / lock-out latch	Configuration key
Undervoltage release with additional contact, rated voltage 230 V AC	E3	Undervoltage release with 2 additional contacts, rated voltage 240 V AC	Z2
Undervoltage release with additional contact, rated voltage 120 V AC	E4	Undervoltage release with 2 additional contacts, rated voltage 230 V AC	Z3
Undervoltage release with additional contact, rated voltage 48 V AC / DC	E6	Undervoltage release with 2 additional contacts, rated voltage 120 V AC	Z4
Undervoltage release with additional contact, rated voltage 24 V AC / DC	E7	Undervoltage release with 2 additional contacts, rated voltage 48 V AC / DC	Z6
Undervoltage release with additional contact, rated voltage 12 V AC / DC	E8	Undervoltage release with 2 additional contacts, rated voltage 24 V AC / DC	Z7
Undervoltage release with additional contact, rated voltage 5 V AC / DC	E9	Undervoltage release with 2 additional contacts, rated voltage 12 V AC / DC	Z8
Mechanical lock-out latch	S0	Undervoltage release with 2 additional contacts, rated voltage 5 V AC / DC	Z9
Undervoltage release, rated voltage 240 V AC	U2	TA45 - AK2 W F 120 A2 - AZM11 = Accessories	
Undervoltage release, rated voltage 230 V AC	U3	Factory mounted accessories	
Undervoltage release, rated voltage 120 V AC	U4	Without cover	
Undervoltage release, rated voltage 48 V AC / DC	U6	Configuration key	
Undervoltage release, rated voltage 24 V AC / DC	U7	Without cover	
Undervoltage release, rated voltage 12 V AC / DC	U8	For subsequent fitting accessories see:	
Undervoltage release, rated voltage 5 V AC / DC	U9	https://www.schurter.com/pdf/english/typ_TA45-ACC.pdf	

Variants

Thermal overload protection	Addition	connection type	Mounting	IP Protection Class Front Side	Actuator colour	Legend	Rated current	Accessories	Config. Code	Order Number
2-pole		Quick connect terminal	Snap-in type	IP40	Front Black: Green/Red	white printed	16.0 A	Without cover	TA45-ABNTL160U3	4430.3602
1-pole		Quick connect terminal	Snap-in type	IP65	Front Black: Green/Red	embossed	16.0 A	Without cover	TA45-ABUTF160E3	4430.3793

Availability for all products can be searched real-time: <https://www.schurter.com/en/Stock-Check/Stock-Check-SCHURTER>

Packaging Unit 1 Pcs

Accessories



Description

TA45-ACC
 Accessories to TA45