

Voltage transducer DVL 750/SP5

$U_{PN} = 750\text{ V}$

For the electronic measurement of voltage: DC, AC, pulsed..., with galvanic separation between the primary and the secondary circuit.

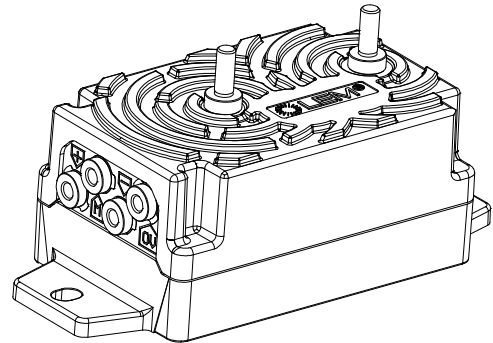

Features

- Bipolar and insulated measurement up to 1000 V
- Primary input connections with M5 threaded studs
- Compatible with AV 100 family.

Special features

- Voltage output
- Secondary output connections with M5 inserts.

Advantages

- Low consumption and low losses
- Compact design
- Good behavior under common mode variations
- Excellent accuracy (offset, sensitivity, linearity)
- Good delay time
- Low temperature drift
- High immunity to external interferences.

Applications

- AC variable speed and servo motor drives
- Static converters for DC motor drives
- Battery supplied applications
- Uninterruptible Power Supplies (UPS)
- Switched Mode Power Supplies (SMPS)
- Power supplies for welding applications
- Renewable Energy (Solar and Wind)
- Single or three phase inverters
- Propulsion and braking choppers
- Propulsion converters
- Auxiliary converters
- High power drives
- Substations.

Standards

- EN 50155: 2017
- EN 50178: 1997
- EN 50124-1: 2017
- EN 50121-3-2: 2016
- UL 508: 2013
- IEC 61010-1: 2010.

Application Domains

- Railway (fixed installations and onboard)
- Industrial.

Absolute maximum ratings

Parameter	Symbol	Unit	Value
Maximum supply voltage ($U_p = 0 \text{ V}$, 0.1 s)	$\pm U_{C \text{ max}}$	V	± 34
Maximum supply voltage (working) (-40 ... 85 °C)	$\pm U_{C \text{ max}}$	V	± 26.4
Maximum input voltage (-40 ... 85 °C)	$U_{P \text{ max}}$	V	1000
Maximum steady state input voltage (-40 ... 85 °C)	$U_{P N \text{ max}}$	V	750 see derating on figure 2

Absolute maximum ratings apply at 25 °C unless otherwise noted.
 Stresses above these ratings may cause permanent damage.
 Exposure to absolute maximum ratings for extended periods may degrade reliability.

UL 508: Ratings and assumptions of certification

File # E189713 Volume: 2 Section: 7

Standards

- USR indicated investigation to the Standard for Industrial Control Equipment UL 508.
- CNR Indicated investigation to the Canadian standard for Industrial Control Equipment CSA C22.2 No. 14-13

Conditions of acceptability

When installed in the end-use equipment, consideration shall be given to the following:

- 1 - *These devices must be mounted in a suitable end-use enclosure.*
- 2 - *The terminal have not been evaluated for field wiring.*
- 3 - *Low voltage circuits are intended to be powered by a circuit derived from an isolating source (such as transformer, optical isolator, limiting impedance or electro-mechanical relay) and having no direct connection back to the primary circuit (other than through the grounding means).*

Marking

Only those products bearing the UL or UR Mark should be considered to be Listed or Recognized and covered under UL's Follow-Up Service. Always look for the Mark on the product.

Insulation coordination

Parameter	Symbol	Unit	Value	Comment
RMS voltage for AC insulation test, 50 Hz, 1 min	U_d	kV	8.5	100 % tested in production
Impulse withstand voltage 1.2/50 μ s	U_{Ni}	kV	16	
Partial discharge extinction RMS voltage @ 10 pC	U_t	V	2700	
Insulation resistance	R_{INS}	M Ω	200	measured at 500 V DC
Clearance (pri. - sec.)	d_{Cl}	mm	See dimensions drawing on page 9	Shortest distance through air
Creepage distance (pri. - sec.)	d_{Cp}	mm		Shortest path along device body
Case material	-	-	V0	According to UL 94
Comparative tracking index	CTI		600	
Maximum DC common mode voltage	$U_{HV+} + U_{HV-}$ and $ U_{HV+} - U_{HV-} $	kV	≤ 4.2 $\leq U_{PM}$	

Environmental and mechanical characteristics

Parameter	Symbol	Unit	Min	Typ	Max
Ambient operating temperature	T_A	$^{\circ}$ C	-40		85
Ambient storage temperature	$T_{A\text{st}}$	$^{\circ}$ C	-50		90
Equipment operating temperature class					EN 50155: OT6
Switch-on extended operating temperature class					EN 50155: ST0
Rapid temperature variation class					EN 50155: H2
Conformal coating type					EN 50155: PC2
Mass	m	g		250	

RAMS data

Parameter	Symbol	Unit	Min	Typ	Max
Useful life class					EN 50155: L4
Mean failure rate	$\bar{\lambda}$	h^{-1}		1/1835004	According to IEC 62380: 2004 $T_A = 45^{\circ}$ C ON: 20 hrs/day ON/OFF: 320 cycles/year $U_C = \pm 24$ V, $U_P = 750$ V

Electrical data

At $T_A = 25\text{ °C}$, $\pm U_C = \pm 24\text{ V}$, $R_M = 100\text{ k}\Omega$, unless otherwise noted.

Lines with a * in the conditions column apply over the $-40 \dots 85\text{ °C}$ ambient temperature range.

Parameter	Symbol	Unit	Min	Typ	Max	Conditions
Primary nominal RMS voltage	U_{PN}	V		750		*
Primary voltage, measuring range	U_{PM}	V	-1000		1000	*
Measuring resistance	R_M	Ω	2000			*
Secondary nominal RMS voltage	U_{SN}	V		7.5		*
Secondary voltage	U_S	V	-10		10	*
Supply voltage	$\pm U_C$	V	± 13.5	± 24	± 26.4	*
Rise time of U_C (10 – 90 %)	t_{rise}	ms			100	
Current consumption @ $U_C = \pm 24\text{ V}$ at $U_P = 0\text{ V}$	I_C	mA		20	25	
Inrush current						NA (EN 50155)
Interruptions on power supply voltage class						NA (EN 50155)
Supply change-over class						NA (EN 50155)
Offset voltage	U_O	mV	-7	0	7	100 % tested in production
Temperature variation of U_O	U_{OT}	mV	-25 -30		25 30	-25 ... 85 °C -40 ... 85 °C
Sensitivity	S	mV/V		10		10 V for primary 1000 V
Sensitivity error	ε_S	%	-0.2	0	0.2	
Thermal drift of sensitivity	ε_{ST}	%	-0.5		0.5	*
Linearity error	ε_L	% of U_{PM}	-0.5		0.5	* $\pm 1000\text{ V}$ range
Total error	ε_{tot}	% of U_{PN}	-0.5 -1		0.5 1	25 °C; 100 % tested in production -40 ... 85 °C *
RMS noise voltage	U_{no}	mV		3		1 Hz to 100 kHz
Delay time to 10 % of the final output value for U_{PN} step	t_{D10}	μs		30		
Delay time to 90 % of the final output value for U_{PN} step	t_{D90}	μs		50	60	0 to 1000 V step, 6 kV/ μs
Frequency bandwidth	BW	kHz		14 8 2		-3 dB -1 dB -0.1 dB
Start-up time	t_{start}	ms		190	250	*
Resistance of primary (winding)	R_P	M Ω		11.3		*
Total primary power loss @ U_{PN}	P_P	mW		0.05		*

Definition of typical, minimum and maximum values

Minimum and maximum values for specified limiting and safety conditions have to be understood as such as well as values shown in “typical” graphs.

On the other hand, measured values are part of a statistical distribution that can be specified by an interval with upper and lower limits and a probability for measured values to lie within this interval.

Unless otherwise stated (e.g. “100 % tested”), the LEM definition for such intervals designated with “min” and “max” is that the probability for values of samples to lie in this interval is 99.73 %.

For a normal (Gaussian) distribution, this corresponds to an interval between -3σ and $+3\sigma$. If “typical” values are not obviously mean or average values, those values are defined to delimit intervals with a probability of 68.27 %, corresponding to an interval between $-\sigma$ and $+\sigma$ for a normal distribution.

Typical, maximal and minimal values are determined during the initial characterization of a product.

Typical performance characteristics

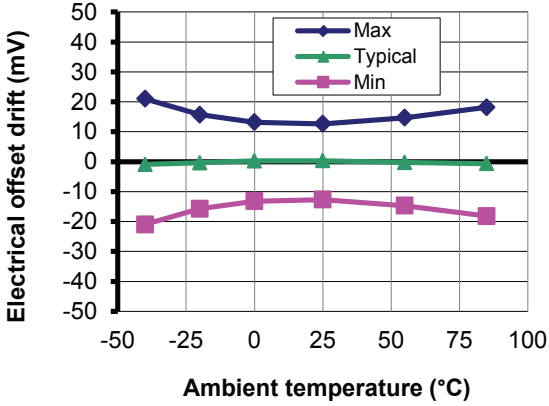

Figure 1: Electrical offset thermal drift

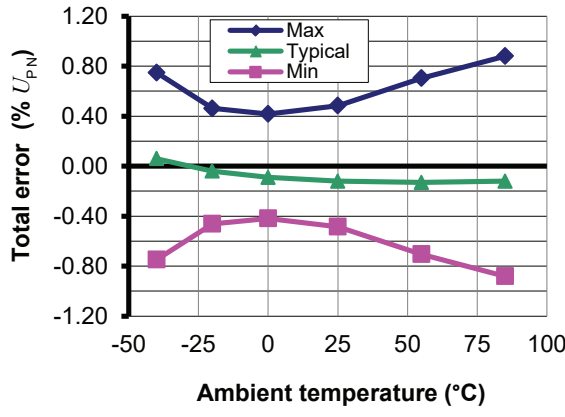

Figure 2: Total error in temperature

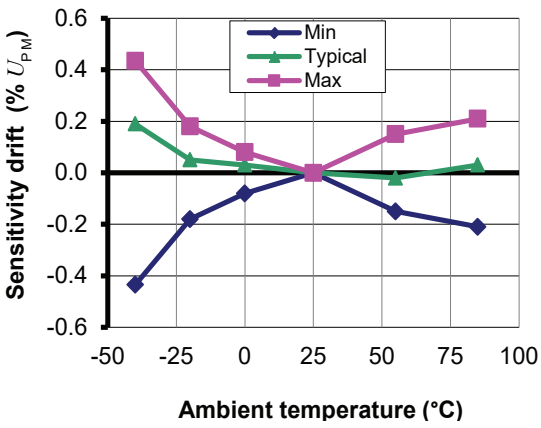

Figure 3: Sensitivity thermal drift

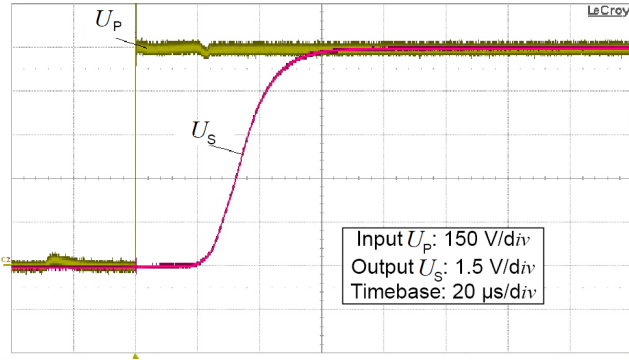

Figure 4: Typical delay time (0 to 750 V)

Typical performance characteristics continued

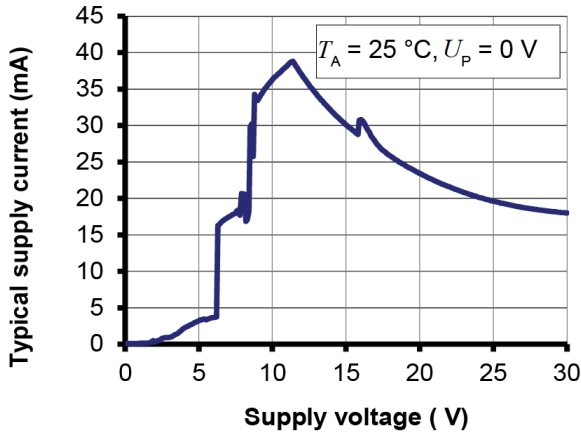

Figure 5: Supply current function of supply voltage

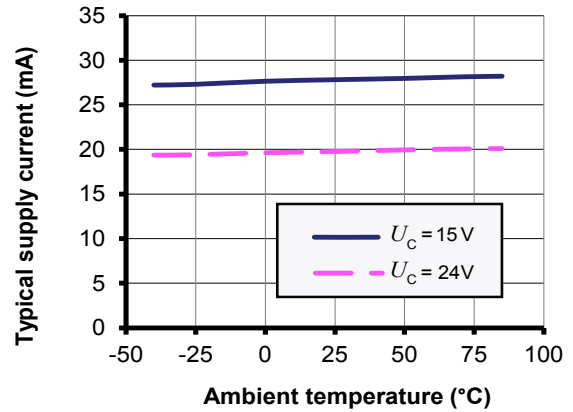

Figure 6: Supply current function of temperature

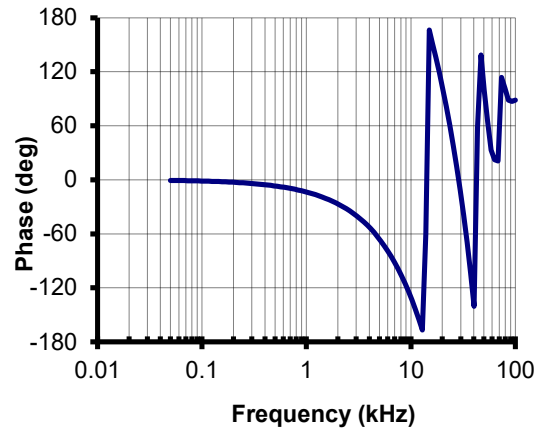
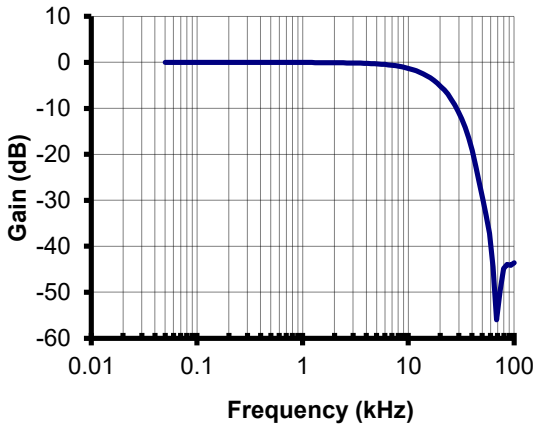

Figure 7: Typical frequency and phase response

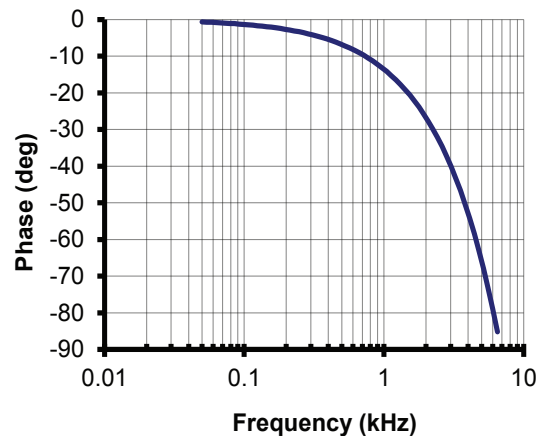
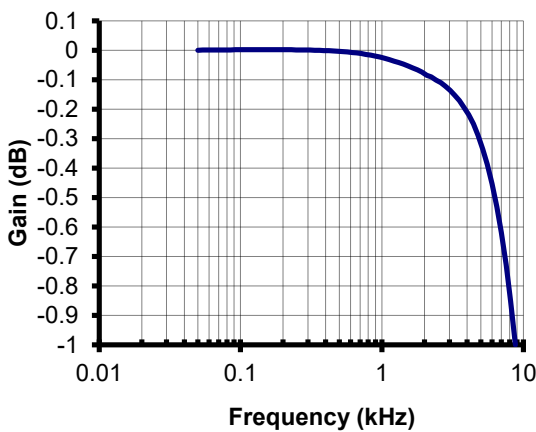

Figure 8: Typical frequency and phase response (detail)

Typical performance characteristics continued

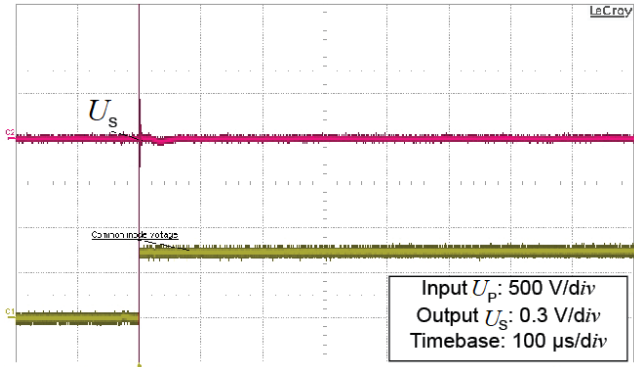

Figure 9: Typical common mode perturbation (750 V step with 6 kV/μs, $R_M = 100 \text{ k}\Omega$)

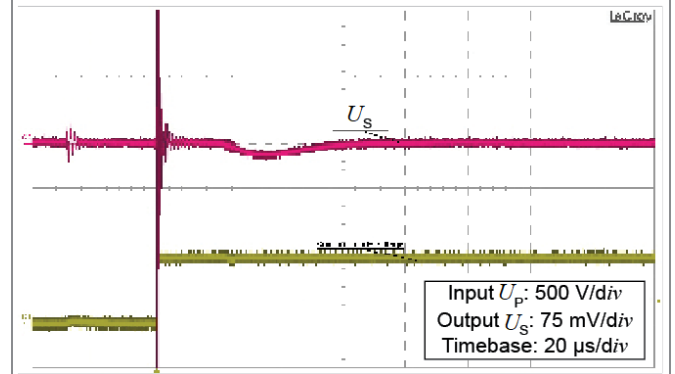

Figure 10: Detail of typical common mode perturbation (750 V step with 6 kV/μs, $R_M = 100 \text{ k}\Omega$)

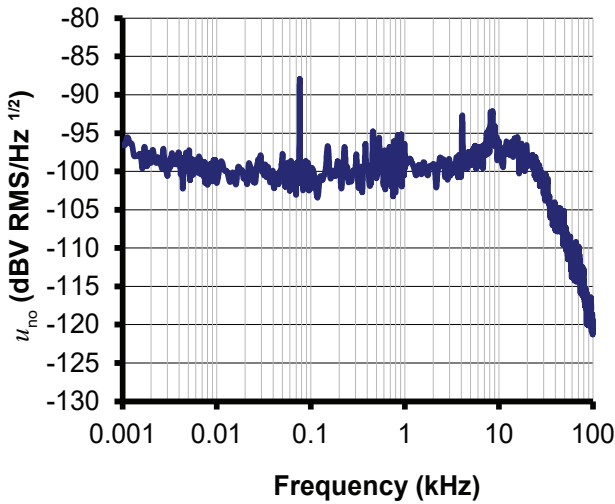

Figure 11: Typical output RMS noise voltage spectral density u_{no} with $R_M = 2 \text{ k}\Omega$

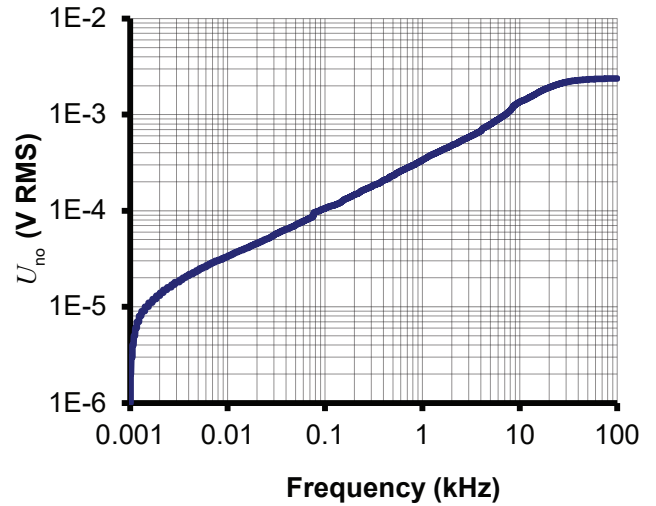

Figure 12: Typical total output RMS noise voltage with $R_M = 2 \text{ k}\Omega$ (f_c is upper cut-off frequency of bandpass, low cut off frequency is 1 Hz)

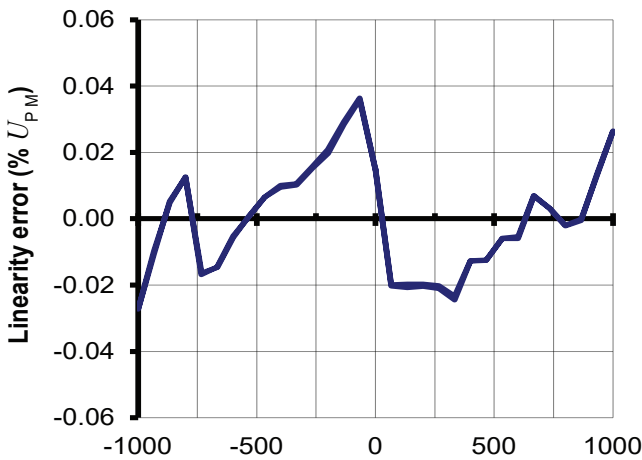

Figure 13: Typical linearity error at 25 °C

Figure 11 (output RMS noise voltage spectral density) shows that there are no significant discrete frequencies in the output. Figure 12 confirms the absence of steps in the total output RMS noise voltage that would indicate discrete frequencies. To calculate the noise in a frequency band $f1$ to $f2$, the formula is:

$$U_{no}(f1 \text{ to } f2) = \sqrt{U_{no}(f2)^2 - U_{no}(f1)^2}$$

with $U_{no}(f)$ read from figure 12 (typical, RMS value).

Example:

What is the noise from 10 to 100 Hz?

Figure 12 gives $U_{no}(10 \text{ Hz}) = 33 \text{ }\mu\text{V}$ and

$U_{no}(100 \text{ Hz}) = 106 \text{ }\mu\text{V}$.

The output RMS noise voltage is therefore.

$$\sqrt{(106 \cdot 10^{-6})^2 - (33 \cdot 10^{-6})^2} = 100 \text{ }\mu\text{V}$$

The schematic used to measure all electrical parameters are:

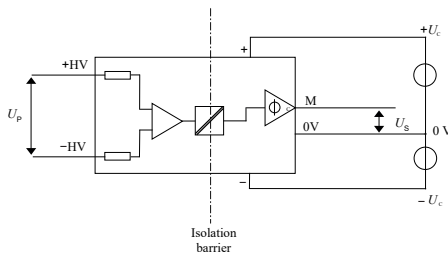

Figure 14: Standard characterization schematics for voltage output transducers ($R_M = 100 \text{ k}\Omega$ unless otherwise noted)

Transducer simplified model

The static model of the transducer at temperature T_A is:

$$U_S = S \cdot U_P + \varepsilon$$

In which

$$\varepsilon = U_{OE} + U_{OT}(T_A) + \varepsilon_S \cdot S \cdot U_P + \varepsilon_{ST}(T_A) \cdot S \cdot U_P + \varepsilon_L \cdot S \cdot U_{PM}$$

- U_S : secondary voltage (V)
- S : sensitivity of the transducer (V/V)
- U_P : primary voltage (V)
- U_{PM} : primary voltage, measuring range (V)
- T_A : ambient operating temperature ($^{\circ}\text{C}$)
- U_{OE} : electrical offset voltage (V)
- $U_{OT}(T_A)$: temperature variation of U_O at temperature T_A (V)
- ε_S : sensitivity error at 25°C
- $\varepsilon_{ST}(T_A)$: thermal drift of sensitivity at temperature T_A
- ε_L : linearity error

This is the absolute maximum error. As all errors are independent, a more realistic way to calculate the error would be to use the following formula:

$$\varepsilon = \sqrt{\sum_{i=1}^N \varepsilon_i^2}$$

Sensitivity and linearity

To measure sensitivity and linearity, the primary voltage (DC) is cycled from 0 to U_{PM} , then to $-U_{PM}$ and back to 0 (equally spaced $U_{PM}/10$ steps).

The sensitivity S is defined as the slope of the linear regression line for a cycle between $\pm U_{PM}$.

The linearity error ε_L is the maximum positive or negative difference between the measured points and the linear regression line, expressed in % of the maximum measured value.

Electrical offset

The electrical offset voltage U_{OE} is the residual output voltage when the input voltage is zero.

The temperature variation U_{OT} of the electrical offset voltage U_{OE} is the variation of the electrical offset from 25°C to the considered temperature.

Total error

The total error ε_{tot} is the error at $\pm U_{PN}$, relative to the rated value U_{PN} .

It includes all errors mentioned above.

Delay times

The delay time t_{D10} and the delay time t_{D90} are shown in the next figure.

Both depend on the primary voltage dv/dt . They are measured at nominal voltage.

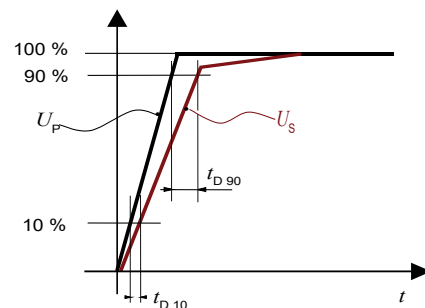
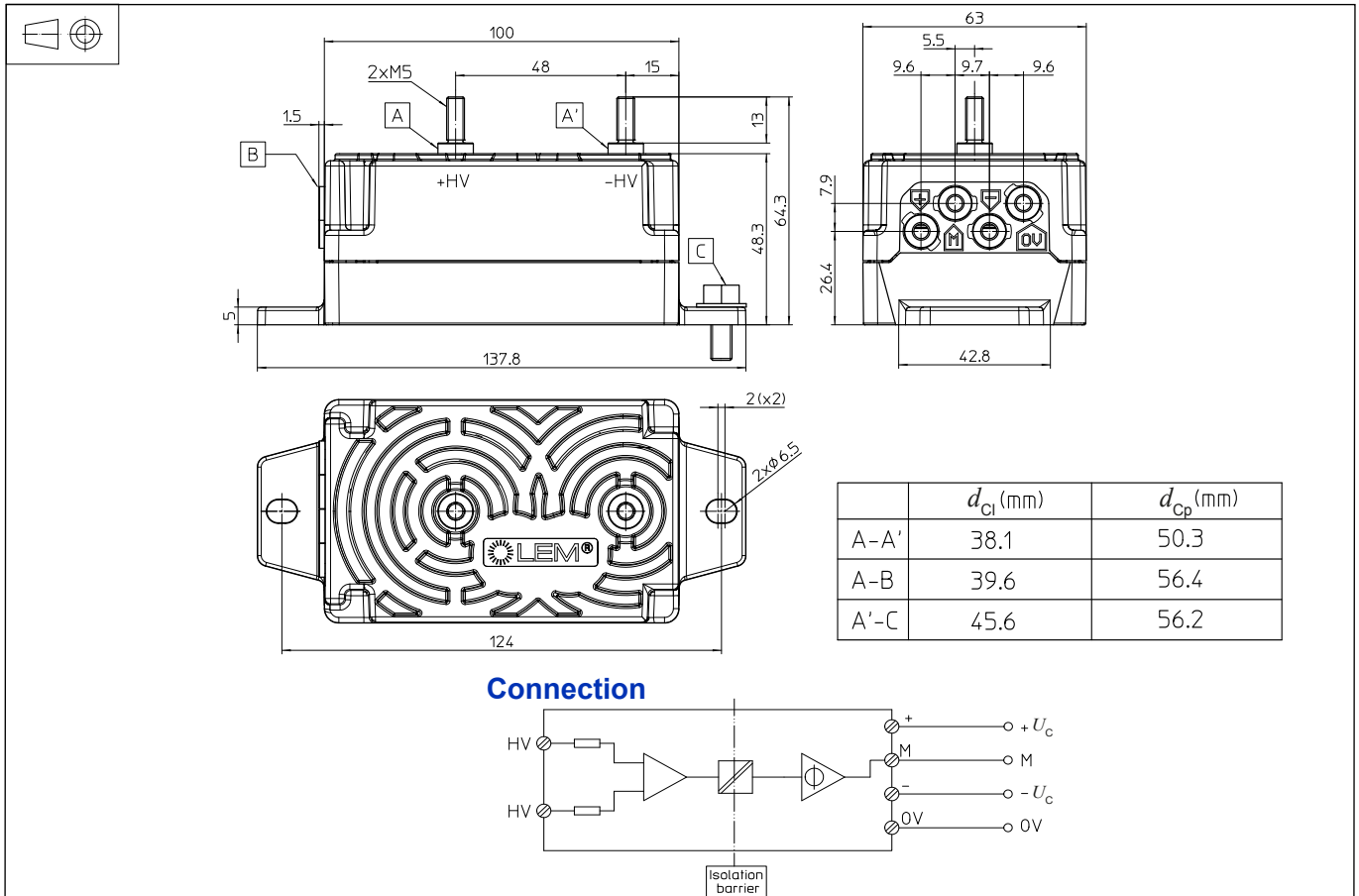

Figure 15: t_{D10} (delay time @ 10 %) and t_{D90} (delay time @ 90 %)

Dimensions (in mm)

Mechanical characteristics

- General tolerance ± 1 mm
- Transducer fastening
 - 2 holes $\varnothing 6.5$ mm
 - 2 M6 steel screws
 - Recommended fastening torque 4 N·m
- Connection of primary
 - 2 M5 threaded studs
 - Recommended fastening torque 2.2 N·m
- Connection of secondary
 - 4 M5 threaded inserts
 - Recommended fastening torque 2.2 N·m
 - BEWARE of maximum screw length 12 mm

Remarks

- U_s is positive when a positive voltage is applied on +HV.
- The transducer is directly connected to the primary voltage.
- The primary cables have to be routed together all the way.
- The secondary cables also have to be routed together all the way.
- Installation of the transducer is to be done without primary or secondary voltage present.
- Installation of the transducer must be done unless otherwise specified on the datasheet, according to LEM Transducer Generic Mounting Rules. Please refer to LEM document N°ANE120504 available on our Web site: <https://www.lem.com/en/file/3137/download/>.

Safety

This transducer must be used in limited-energy secondary circuits according to IEC 61010-1.



This transducer must be used in electric/electronic equipment with respect to applicable standards and safety requirements in accordance with the manufacturer's operating instructions.



Caution, risk of electrical shock

When operating the transducer, certain parts of the module can carry hazardous voltage (e.g. primary connections, power supply). Ignoring this warning can lead to injury and/or cause serious damage. This transducer is a build-in device, whose conducting parts must be inaccessible after installation. A protective housing or additional shield could be used. Main supply must be able to be disconnected.