

# Integrated Current Sensor FHS AH 600

## Definition

The FHS AH current sensor is LEM new SMD open loop current sensor based on the Hall effect principle. It benefits from improvement in sensitivity and accuracy temperature stress compensation. It is suitable for DC, AC, pulsed and mixed current measurements. This field sensor has built in Integrated Magnetic Circuit (IMC), that gives an optimum sensitivity, to offer flexibility in compact design without requiring external magnetic core concentrator. It is a perfect solution to measure current flowing in a conductor such as a PCB track. High isolation between the primary circuit and transducer electronics can be obtained with a double-sided PCB.

## Main features & Advantages

- Hall effect current sensor with Integrated Magnetic Concentrator (IMC)
- Magnetic field measurement range  $\pm 3.3$  mT
- Supply voltage 5 V
- Low power consumption
- High bandwidth: 160 kHz
- Sensitivity range up over to 200 mV/A
- Isolated current measurement
- Small footprint with standard SOIC8 surface mount PCB
- Low cost, Small size
- Excellent linearity
- No power loss in primary circuit
- Internal reference voltage

## Typical applications

- Small drives
- BMS
- Motor control
- UPS
- HVAC
- White goods.
- PCB track current measurement

## Standards

- AECQ 100 pending



RoHS

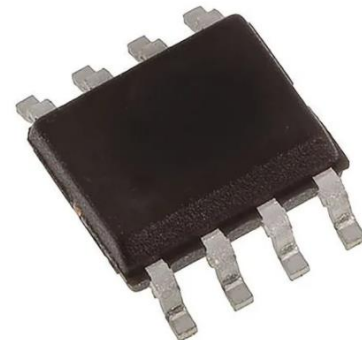

Figure 1 FHS AH package – SOIC-8

(Not to scale - For illustration: not representative)

## Application circuit and pinout

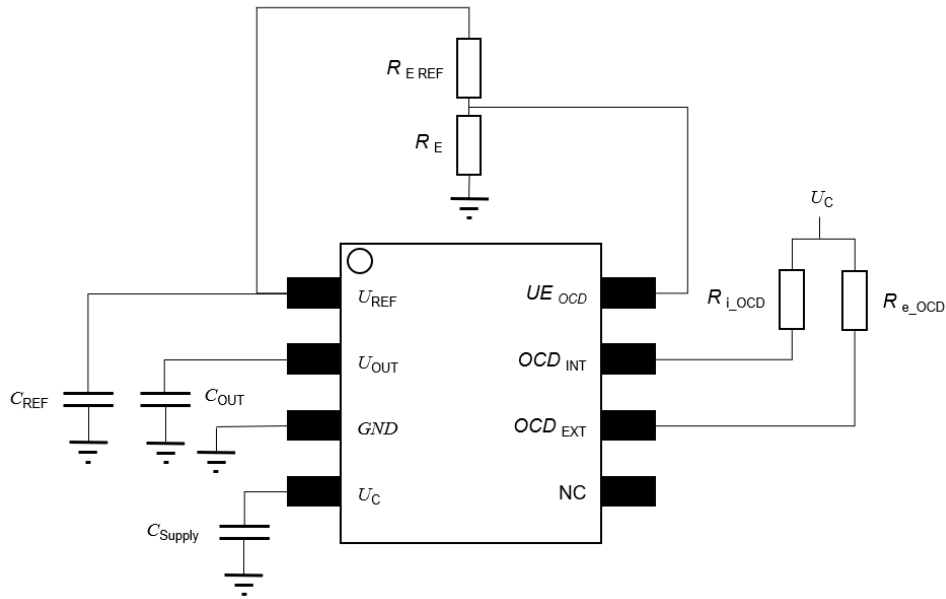

Figure 2 Application circuit

External circuit example	Min	Typ	Max	Unit
$C_{Supply}$		47	100	nF
$C_{OUT}$		4.7	6	nF
$C_{REF}$		47		nF
$R_{I\_OCD}$		4.7	50	k $\Omega$
$R_{E\_OCD}$		4.7	50	k $\Omega$
$R_E$		100		k $\Omega$
$R_{E\_REF}$		100		k $\Omega$

$C_{Supply}$ ,  $C_{OUT}$  and  $C_{REF}$  should be mounted as close as to the pins.

Ideally,  $R_{E\_REF} + R_E$  should have a value around 200 k $\Omega$  due to current limitation on  $U_{REF}$ .

$U_{OUT} - U_{REF}$  is positive when primary current flowing under FHS AH from pin 4/5 to the pin 1/8.

FHS can be directly mounted above the PCB track in which the current to be measured flows.

Pins number	Name	Description
1	$U_{REF}$	Reference voltage
2	$U_{OUT}$	Output voltage
3	$GND$	Ground terminal
4	$U_C$	Supply voltage
5	$NC$	Not Connected or GND
6	$OCD_{EXT}$	External OCD
7	$OCD_{INT}$	Internal OCD
8	$UE_{OCD}$	External OCD threshold voltage terminal

## Block diagram

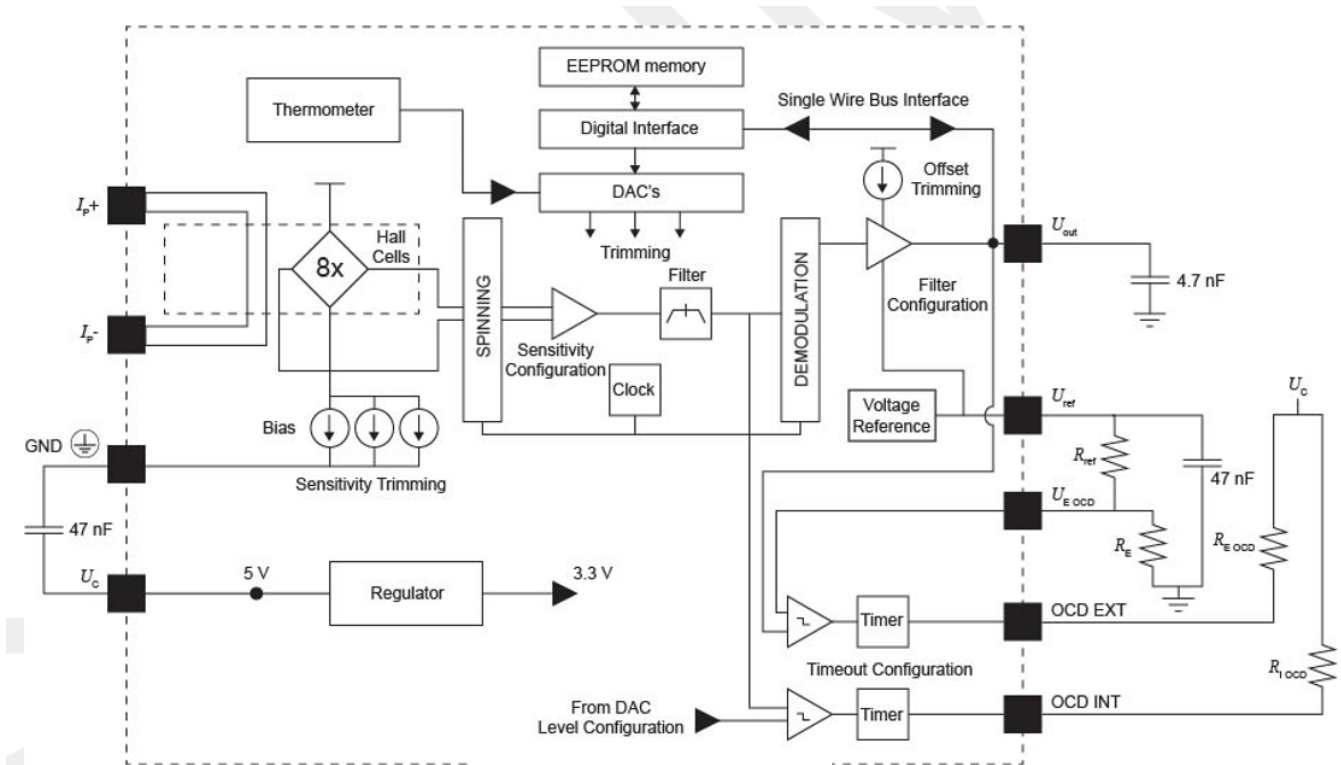

Figure 3 Block diagram FHS AH

## Absolute maximum rating

Parameter	Symbol	Unit	Min	Typ	Max	Comment
Ambient operating temperature	$T_A$	°C	-40		125	
Ambient storage temperature	$T_{A\ st}$	°C	-55		165	TBC
Maximum junction temperature	$T_{J\ max}$	°C		165		
Output sink current		mA		-50		
Output source current		mA		25		
Magnetic flux density	$B_{max}$	T	-3		3	

Absolute maximum ratings apply at 25 °C unless otherwise noted.  
 Stresses above these ratings may cause permanent damage  
 Exposure to absolute maximum ratings for extended periods may degrade reliability.

## Environmental and mechanical characteristics

Parameter	Symbol	Unit	Value
Maximum supply voltage	$U_{C\ max}$	V	8
Electrostatic discharge voltage (HBM -Human Body Model)	$U_{ESD\ HBM}$	kV	2
Mass	$m$	g	0.08

## Electrical Data

At  $T_A = 35\text{ °C}$ ,  $U_C = +5\text{ V}$ ,  $R_L = 100\text{ k}\Omega$ , unless otherwise noted (see Min, Max, Typ, definition paragraph in “Terms and definitions” chapter).

Parameter	Symbol	Unit	Min	Typ	Max	Comment
DC supply voltage	$U_C$	V	4.5	5	5.5	
Current consumption	$I_C$	mA	12	14	19	-40 °C ... 125 °C , without RL
Magnetic flux density measuring range	$B_M$	mT		$\pm 3.3$		$U_C > 4.6\text{ V}$
Output voltage in a flux density $B$	$U_{out}$	V	$U_{ref} + U_{OE} + (S_N \times B)$			
Linearity error 0 ... $B_M$	$\varepsilon_L$	% of $B_M$	-0.5		0.5	
Nominal sensitivity	$S_N$	mV/mT		600		
Sensitivity error	$\varepsilon_S$	%		$\pm 0.5$	$\pm 1$	
Temperature coefficient of $S$	$TCS$	ppm/K	-200		200	-40 °C ... 125 °C, referred to 35 °C
Lifetime $S$ drift		%			$\pm 1$	TBC
Internal reference voltage @ $B = 0\text{ T}$	$U_{ref}$	V	2.48	2.5	2.52	
Output internal resistance of $U_{ref}$	$R_{ref}$	$\Omega$	120	200	333	-40 °C ... 125 °C
Temperature coefficient of $U_{ref}$	$TCU_{ref}$	ppm/K	-150		150	-40 °C ... 125 °C, referred to 35 °C
Lifetime $U_{ref}$ drift		mV			$\pm 2$	TBC
Electrical offset	$U_{OE}$	mV	-10		10	
Lifetime $U_{OE}$ drift		mV			$\pm 2.5$	
Remanent filed		$\mu\text{T}$			15	After $\pm B_M$
Temperature coefficient of $U_{OE}$	$TCU_{OE}$	mV/K	-0.1		0.1	-40 °C ... 125 °C, referred to 35 °C
Output internal resistance of $U_{out}$	$R_{out}$	$\Omega$			5	DC
Noise voltage spectral density	$U_{no}$	$\mu\text{V}/\text{Hz}^{1/2}$		17		TBC
Delay time @ 10 % of $B_N$	$t_{D10}$	$\mu\text{s}$			1.6	Input signal rise time 2 us
Delay time @ 90 % of $B_N$	$t_{D90}$	$\mu\text{s}$			1.4	Input signal rise time 2 us
Frequency bandwidth	$BW$	kHz			160	@ -3 dB
					100	@ -1 dB

## Overcurrent detection (OCD)

Overcurrent detection is a feature included on FHS AH product in order to detect high peaks of currents happening during operation. Two overcurrent detection types are included in this product: Internal OCD and External OCD:

Parameter	Symbol	Unit	Min	Typ	Max	Comment
<b>Internal OCD</b>						
Internal OCD detection threshold	$I_{OCD Th}$	A		TBC $\pm 1PN$		
Internal OCD threshold error	$\epsilon_{I_{OCD Th}}$	%		$\pm 8$		Referred to $B @ U_{OUT} - U_{REF} = 0.8 V$
Internal OCD output on resistance	$R_{on I_{OCD}}$	$\Omega$	70	95	150	Open drain output, active low
Internal OCD output hold time	$t_{hold I_{OCD}}$	$\mu s$	7	10	14	
Internal OCD delay time	$t_{d I_{OCD}}$	$\mu s$	1.3		2.1	
<b>External OCD</b>						
External OCD detection threshold	$I_{E_{OCD Th}}$	A	$\pm 12.5$		$\pm 50$	
External OCD threshold error	$\epsilon_{E_{OCD Th}}$	%		$\pm 5$		$B @ U_{OUT} - U_{REF} = 0.8 V$
External OCD output on resistance	$R_{on E_{OCD}}$	$\Omega$	35	200	280	Open drain output, active low
External OCD output hold time	$t_{hold E_{OCD}}$	$\mu s$		10		
External OCD delay time	$t_{d E_{OCD}}$	$\mu s$		10		

$$U_{E\,OCD} = \frac{R_E}{R_E + R_{E\,REF}} \cdot U_{REF} \Rightarrow B_{E\,OCD} = \frac{U_{REF} - U_{E\,OCD}}{S_N} \quad \text{with } 0.5 < U_{E\,OCD} < U_{REF} - 0.5 \text{Internal}$$

**OCD behavior:**

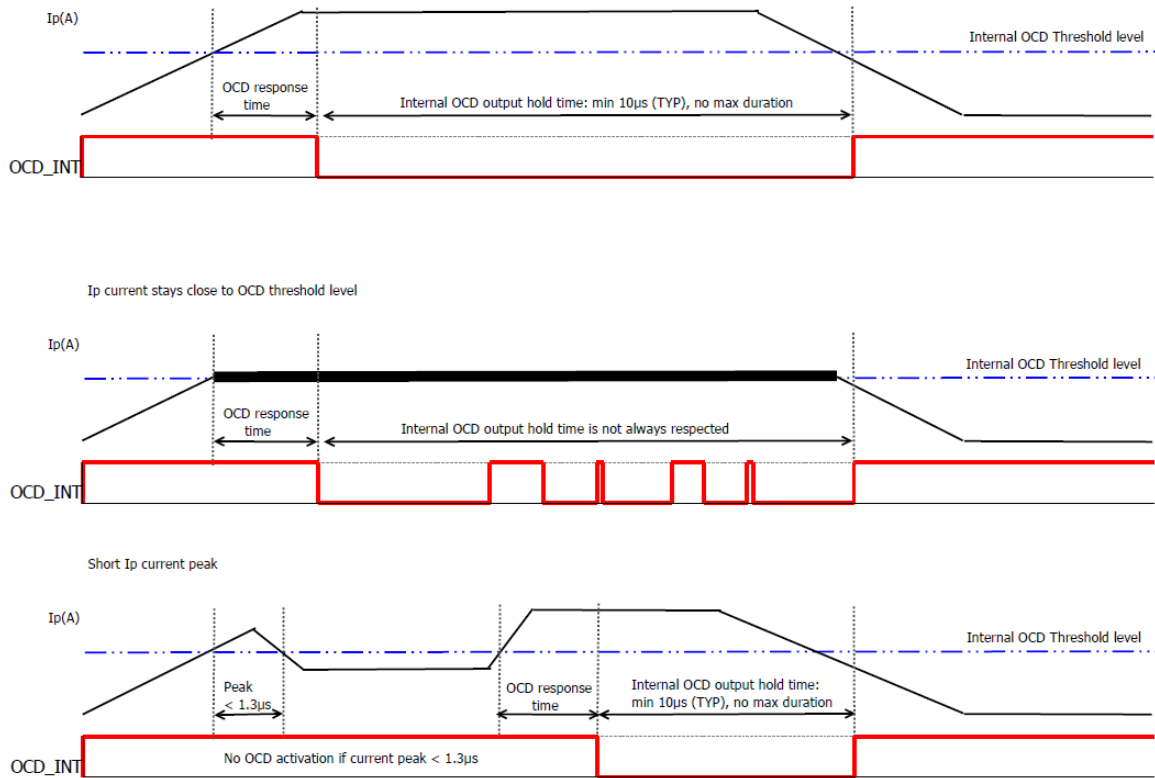

Figure X Internal OCD behaviour

## External OCD behavior:

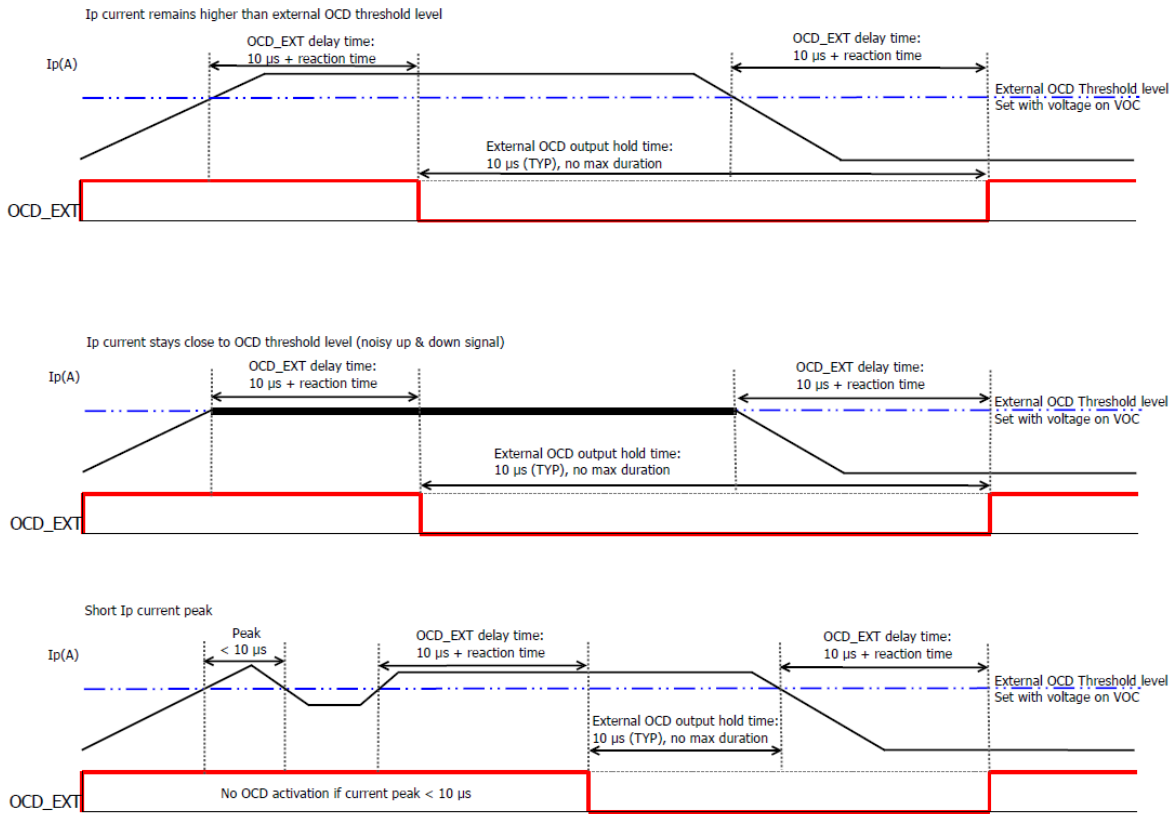

Figure X External OCD behaviour

## Definition of typical, minimum and maximum values

Minimum and maximum values for specified limiting and safety conditions have to be understood as such as well as values shown in "typical" graphs.

On the other hand, measured values are part of a statistical distribution that can be specified by an interval with upper and lower limits and a probability for measured values to lie within this interval.

Unless otherwise stated (e.g., "100 % tested"), the LEM definition for such intervals designated with "min" and "max" is that the probability for values of samples to lie in this interval is 99.73 %.

For a normal (Gaussian) distribution, this corresponds to an interval between  $-3$  sigma and  $+3$  sigma. If "typical" values are not obviously mean or average values, those values are defined to delimit intervals with a probability of 68.27 %, corresponding to an interval between  $-\text{sigma}$  and  $+\text{sigma}$  for a normal distribution.

Typical, maximal, and minimal values are determined during the initial characterization of the product.

Noise

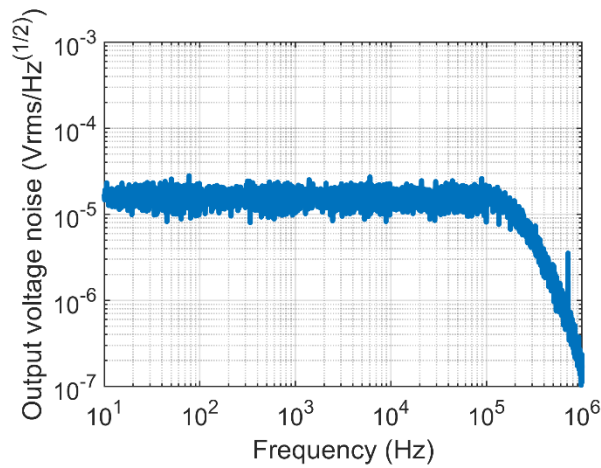

Figure X Output voltage noise

Linearity

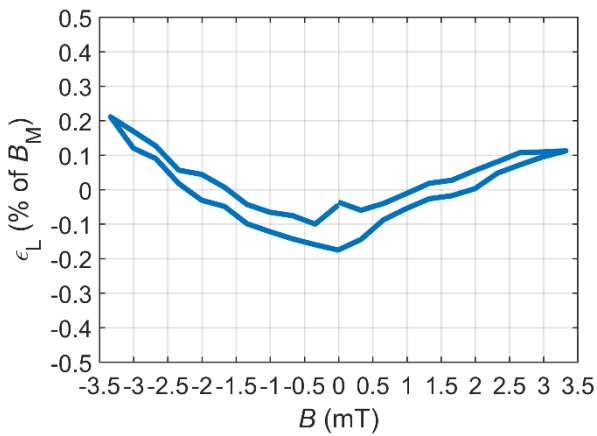

Figure X Linearity error @35 °C

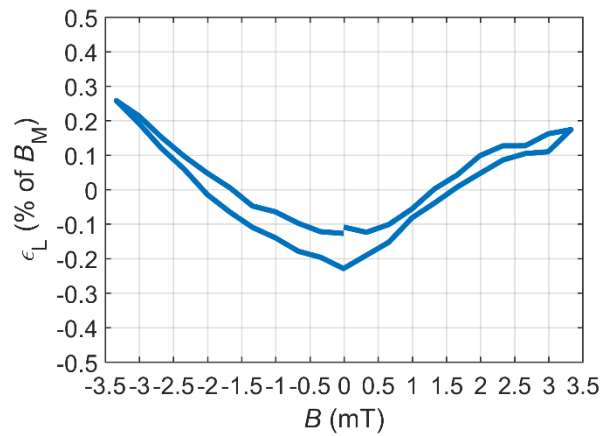

Figure X Linearity error @125 °C

Di/dt

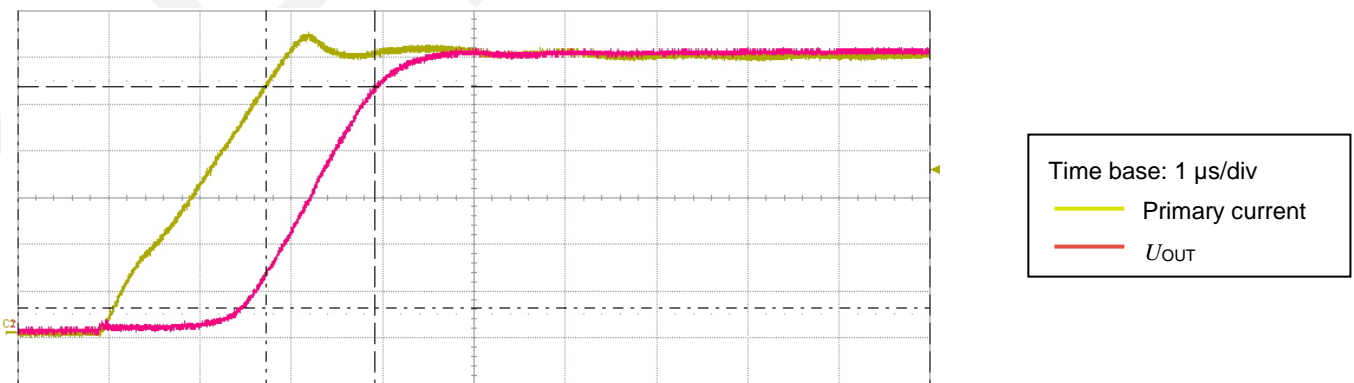

Figure X di/dt



Bandwidth

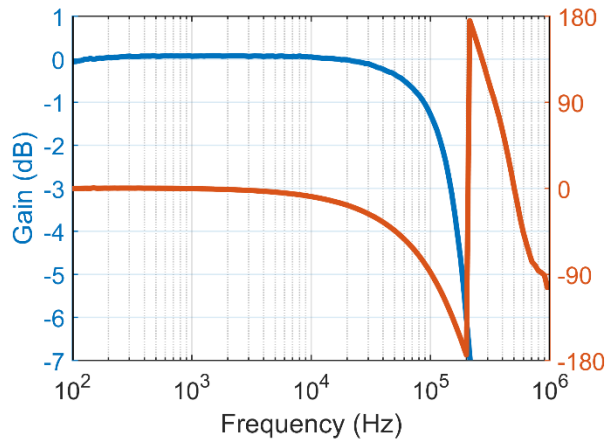

Figure X Bandwidth

SPECIMEN

## Terms and definitions

### Sensitivity and linearity

To measure sensitivity and linearity, the primary current (DC) is cycled from 0 to  $B_M$ , then to  $-B_M$  and back to 0 (equally spaced  $B_M/10$  steps).

The sensitivity  $S$  is defined as the slope of the linear regression line for a cycle between  $\pm B_M$ .

The linearity error  $\epsilon_L$  is the maximum positive or negative difference between the measured points and the linear regression line, expressed in % of  $B_M$ .

### Delay times

The delay time  $t_{D10}$  @ 10 % and the delay time  $t_{D90}$  @ 90 % with respect to the primary are shown in the next figure.

Both slightly depend on the primary current  $di/dt$ . They are measured at nominal voltage output.

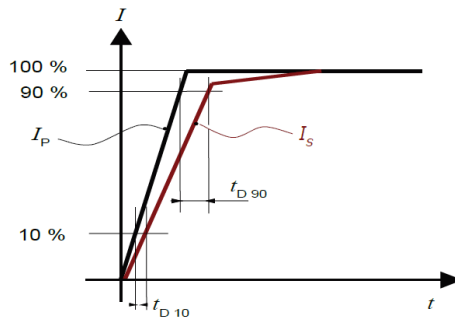

Figure X  $t_{D10}$  (delay time @ 10 %) and  $t_{D90}$  (delay time @ 90 %).

### Typical connection diagram and ground plane

Good EMC practice requires the use of ground planes on PCBs. In drives where high  $dv/dt$  transients are present, a ground plane between the primary conductor and FHS AH will reduce or avoid output perturbations due to capacitive currents. However, the ground plane has to be designed to limit eddy currents that would otherwise slow down the response time. The effect of eddy currents is made negligible by cutting the copper plane under the package as shown in bellow figure.

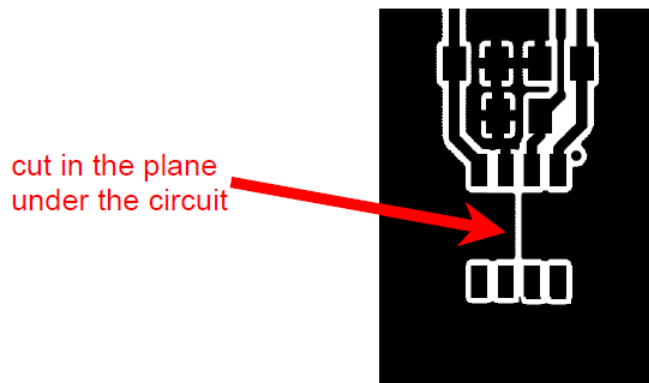

Figure X Top side copper plane has a cut under the IC to optimize response time

## Application information

### Basic operation: example with a long thin conductor

FHS AH is a galvanically isolated current transducer. It senses the magnetic field generated by the measured current and transforms it into an output voltage.

If the current is bidirectional, FHS AH will sense the polarity of the magnetic field and generate a positive or negative output voltage relative to the reference voltage.

A simple case is presented which illustrates the current to magnetic field and then to output voltage conversion.

A current flowing in a long thin conductor generates a flux density around it:  $B = \frac{\mu_0}{2\pi} \cdot \frac{I_P}{r}$  (T)

With:

- $I_P$  the current to be measured (A)
- $r$  the distance from the center of the wire (m)
- $\mu_0$  the permeability of vacuum (physical constant,  $\mu_0 = 4 \cdot \pi \cdot 10^{-7}$  (H/m))

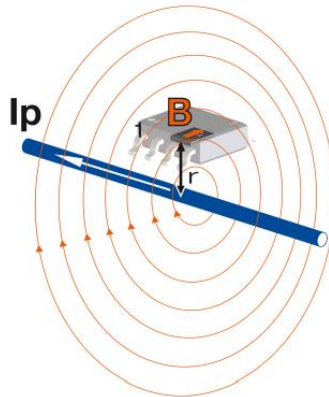

Figure X FHS AH orientation to measure the magnetic field generated by a current along a conductor

If FHS AH is now placed in the vicinity of the conductor (with its sensitivity direction colinear to the flux density B), it will sense the flux density and the output voltage will be:

$$U_{OUT} = G_B \cdot B = G_B \cdot \frac{\mu_0}{2\pi} \cdot \frac{I_P}{r} = 1.2 \cdot 10^{-4} \cdot \frac{I_P}{r}$$
 (V)

where  $G_B$  is the FHS AH magnetic sensitivity (600 V/T).

The sensitivity is therefore:

$$G = \frac{U_{OUT}}{I_P} = \frac{1.2 \cdot 10^{-4}}{r}$$
 (V/A)

The next graph shows how the output voltage decreases when  $r$  increases.

Note that the sensitivity also depends on the primary conductor shape.

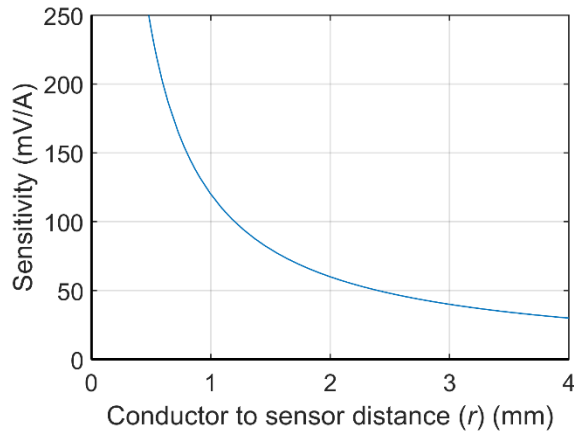

Figure X Sensitivity versus the distance between the conductor and the FHS AH sensing elements

The example above is of limited practical use as most conductors are not round and thin but explains the principles of FHS AH operation.

The measuring range limit ( $I_{PM}$ ) is reached when the output voltage ( $U_{OUT} - U_{REF}$ ) reaches 2 V.

This limit is due to electrical saturation of the output amplifier. The input current or field may be increased above this limit without risk for the circuit.

Recovery will occur without additional delay (same response time as usual).

The maximum current that can be continuously applied to the transducer ( $I_{PM}$ ) is only limited by the primary conductor carrying capacity.

**Single track on PCB**

The main practical configurations will now be reviewed, and their main features highlighted.

The use of FHS AH to measure a current flowing in a track provides the following advantages:

- Isolation is guaranteed by PCB design. If the primary track is placed on the opposite (bottom) side of the PCB, the isolation can be very high
- stable and reproducible sensitivity
- inexpensive
- large input currents (up to about 100 A).

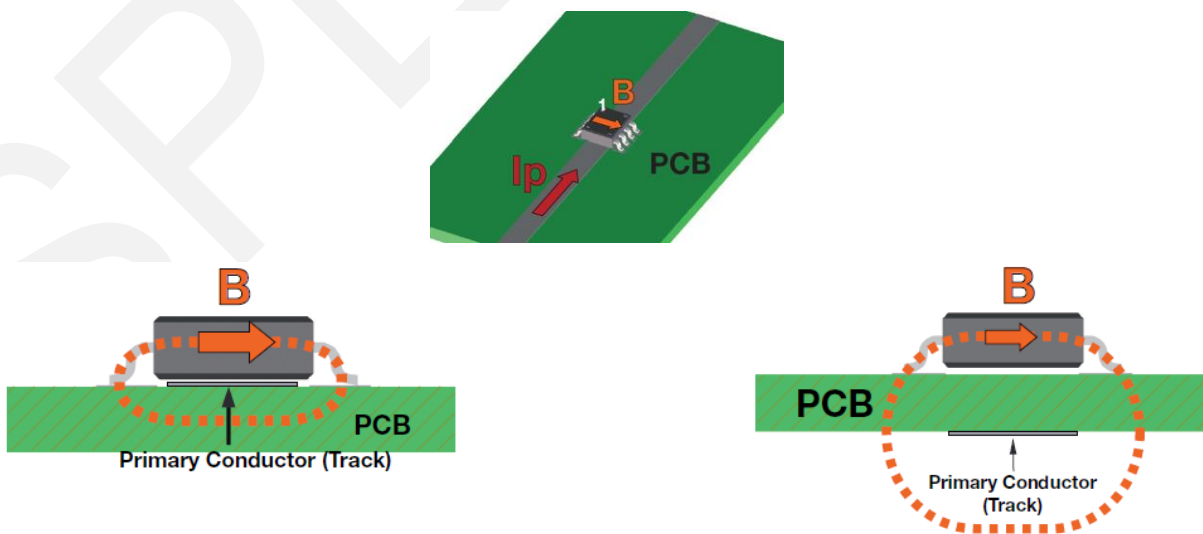

Figure X Principle of FHS AH used to measure current in a PCB track

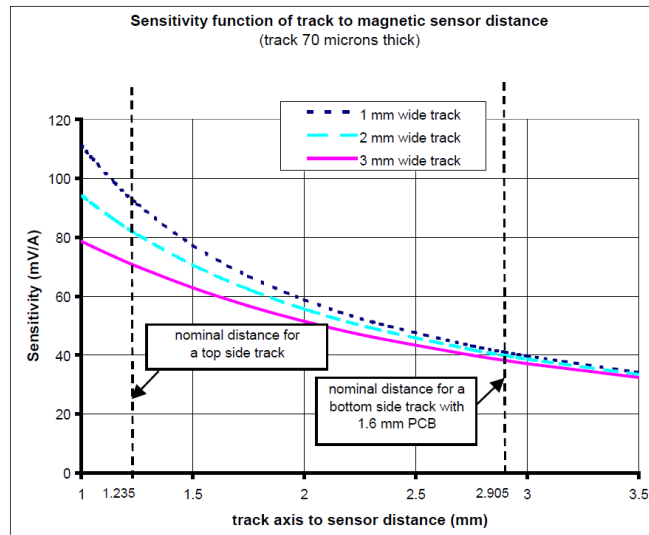

Figure X Sensitivity versus track width and versus distance between the track and the FHS AH sensing elements (TBC)

The sensitivity depends on the track width and distance, as shown in above figure.

The maximum current that can be safely applied continuously is determined by the temperature rise of the track. The use of a track with varying width gives the best combination of sensitivity and track temperature rise.

**Multi-turns**

For low currents (under 10 A), it is advisable to make several turns with the primary track to increase the magnetic field generated by the primary current.

**Cable or busbar**

For very large currents (>50A), FHS AH can be used to measure the current flowing in a cable or busbar. The position of FHS AH relatively to the conductor has to be stable to avoid sensitivity variations.

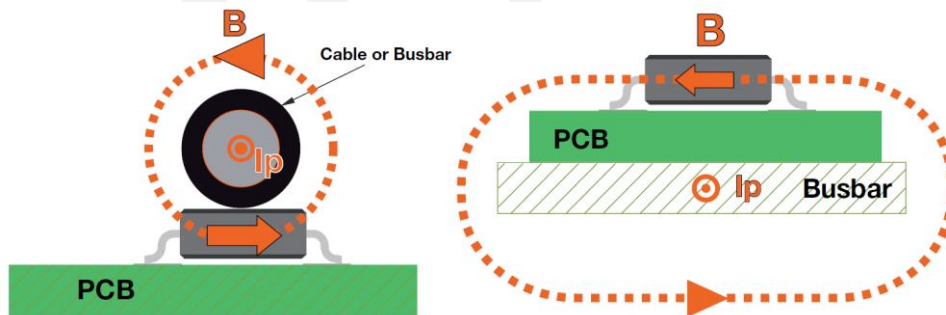

Figure X Example with cable or busbar

**Accuracy considerations**

Several factors influence the output accuracy of FHS AH as a current transducer:

- The sensitivity of the FHS AH
- The distance and shape of the primary conductor
- The circuit output offset
- The circuit non-linearity
- Stray fields

The sensitivity of the FHS AH is calibrated during production at 600 V/T. As already mentioned, the distance and shape of the primary conductor also influence the sensitivity.

No relative movement of the primary conductor to FHS AH should be possible.

To avoid differences in a production, the position and shape of the primary conductor and circuit should always be identical.

The magnetic fields generated by neighboring conductors, the earth's magnetic field, magnets, etc. are also measured if they have a component in the direction to which FHS AH is sensitive (see figure X).  
 As a rule, the stronger the field generated by the primary current, the smaller the influence of stray fields and offset.  
 The primary conductor should therefore be designed to maximize the output voltage.

## PCB footprint & dimensions (in mm)

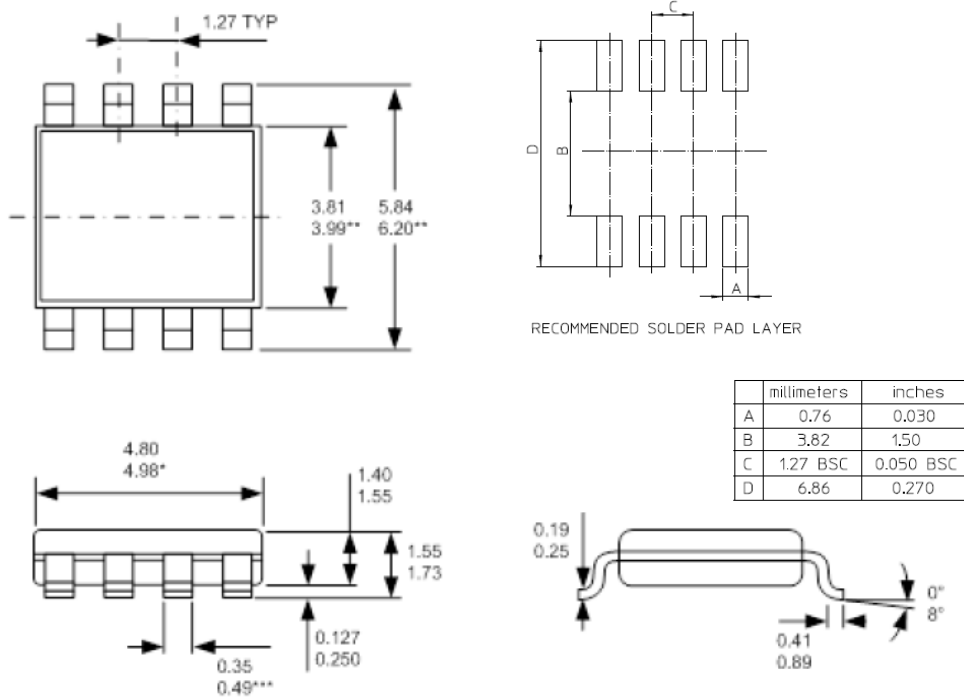

Figure X SOIC8, Package dimensions

### Notes:

All dimensions are in millimeters (angles in degrees)

\* Dimensions do not include mold flash, protrusions or gate burrs (shall not exceed 0.15 per side)

\*\* Dimension does not include interleads flash or protrusion (shall not exceed 0.25 per side)

\*\*\* Dimension does not include dambar protrusion.

Allowable dambar protrusion shall be 0.08 mm total in excess of the dimension at maximum material condition.

Dambar cannot be located on the lower radius of the foot.

## Mechanical characteristics

### Hall plate position

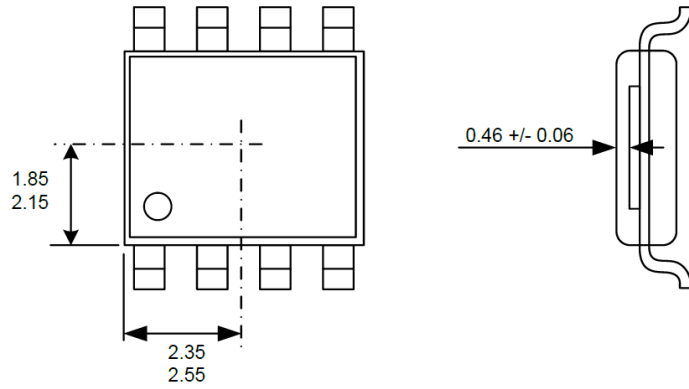

Figure X Hall plate position

### Soldering

Recommended reflow soldering profile as standard: IPC/JEDEC J-STD-020 revision C

### Tape and Reel dimensions

## Packaging

SPECIMEN



## Safety



If the device is used in a way that is not specified by the manufacturer, the protection provided by the device may be compromised.

Always inspect the electronics unit and connecting cable before using this product and do not use it if damaged. Mounting assembly shall guarantee the maximum primary conductor temperature, fulfill clearance and creepage distance, minimize electric and magnetic coupling, and unless otherwise specified can be mounted in any orientation.



Caution, risk of electrical shock

This transducer must be used in limited-energy secondary circuits SELV according to IEC 61010-1, in electric/electronic equipment with respect to applicable standards and safety requirements in accordance with the manufacturer's operating specifications.

Use caution during installation and use of this product; certain parts of the module can carry hazardous voltages and high currents (e.g., power supply, primary conductor).

Ignoring this warning can lead to injury and or/cause serious damage.

**If applicable:** De-energize all circuits and hazardous live parts before installing the product.

All installations, maintenance, servicing operations and use must be carried out by trained and qualified personnel practicing applicable safety precautions.

This transducer is a build-in device, whose hazardous live parts must be inaccessible after installation.

This transducer must be mounted in a suitable end-enclosure.

Besides make sure to have minimum 30 mm between the primary terminals of the transducer and other neighboring components.

**If applicable:** Main supply must be able to be disconnected.

**If applicable:** Always inspect the flexible probe for damage before using this product.

**If applicable:** Never connect or disconnect the external power supply while the primary circuit is connected to live parts.

**If applicable:** Never connect the output to any equipment with a common mode voltage to earth greater than 30 V.

**If applicable:** Always wear protective clothing and gloves if hazardous live parts are present in the installation where the measurement is carried out.

This transducer is a built-in device, not intended to be cleaned with any product. Nevertheless, if the user must implement cleaning or washing process, validation of the cleaning program has to be done by himself.

**If applicable:** When defining soldering process, please use no cleaning process only.



ESD susceptibility

The product is susceptible to be damaged from an ESD event and the personnel should be grounded when handling it.

Do not dispose of this product as unsorted municipal waste. Contact a qualified recycler for disposal.

**If CE marking not applicable:** Although LEM applies utmost care to facilitate compliance of end products with applicable regulations during LEM product design, use of this part may need additional measures on the application side for compliance with regulations regarding EMC and protection against electric shock.

Therefore, LEM cannot be held liable for any potential hazards, damages, injuries or loss of life resulting from the use of this product.



Underwriters Laboratory Inc. recognized component

### Version history

Date	Version	Comment
2022/01/07	V0	Specimen

SPECIMEN