



Features:

- Isolated mounting base 3000V~
- Pressure contact technology with Increased power cycling capability
- Space and weight saving

Typical Applications

- AC/DC Motor drives
- Various rectifiers
- DC supply for PWM inverter

V _{RRM} ,V _{DRM}	Type & Outline
800V	MFx110-08-223F3
1000V	MFx110-10-223F3
1200V	MFx110-12-223F3
1400V	MFx110-14-223F3
1600V	MFx110-16-223F3
1800V	MFx110-18-223F3

MFx stands for any type of **MFC**, **MFA**, **MFK**

SYMBOL	CHARACTERISTIC	TEST CONDITIONS	T _j (°C)	VALUE			UNIT
				Min	Type	Max	
I _{T(AV)}	Mean on-state current	180° half sine wave 50Hz Single side cooled, T _c =85°C	125			110	A
I _{T(RMS)}	RMS on-state current					173	A
I _{DRM} I _{RRM}	Repetitive peak current	at V _{DRM} at V _{RRM}	125			12	mA
I _{TSM}	Surge on-state current	V _R =60%V _{RRM} , t=10ms half sine	125			2.50	kA
I ² t	I ² t for fusing coordination		125			31.2	10 ³ A ² s
V _{TO}	Threshold voltage		125			0.85	V
r _T	On-state slope resistance					2.29	mΩ
V _{TM}	Peak on-state voltage	I _{TM} =330A	25			1.83	V
dv/dt	Critical rate of rise of off-state voltage	V _{DM} =67%V _{DRM}	125			1000	V/μs
di/dt	Critical rate of rise of on-state current	Gate source 1.5A t _r ≤0.5μs Repetitive	125			200	A/μs
I _{GT}	Gate trigger current	V _A =12V, I _A =1A	25	30		150	mA
V _{GT}	Gate trigger voltage			0.7		2.5	V
I _H	Holding current			10		150	mA
I _L	Latching current					1000	mA
V _{GD}	Non-trigger gate voltage	V _{DM} =67%V _{DRM}	125			0.20	V
R _{th(j-c)}	Thermal resistance Junction to case	At 180° sine, Single side cooled per chip				0.25	°C/W
R _{th(c-h)}	Thermal resistance case to heatsink	At 180° sine, Single side cooled per chip				0.15	°C/W
V _{iso}	Isolation voltage	50Hz,R.M.S.,t=1min,I _{iso} :1mA(MAX)		3000			V
F _m	Terminal connection torque(M5)			2.5		4.0	N·m
	Mounting torque(M6)			4.5		6.0	N·m
T _{vj}	Junction temperature			-40		125	°C
T _{stg}	Stored temperature			-40		125	°C
W _t	Weight					175	g
Outline	223F3						

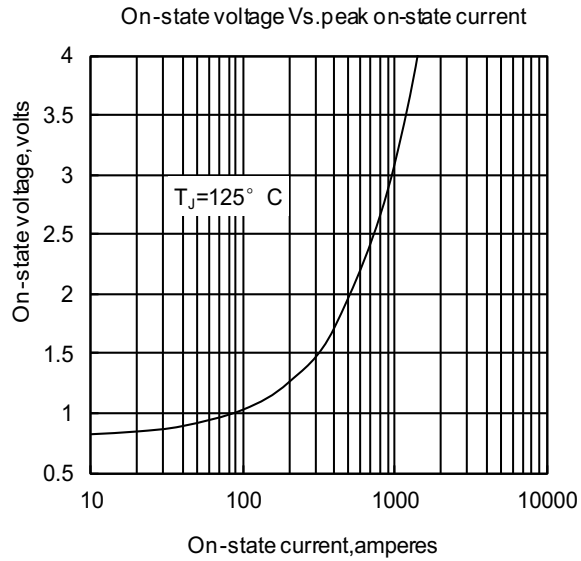

Fig1

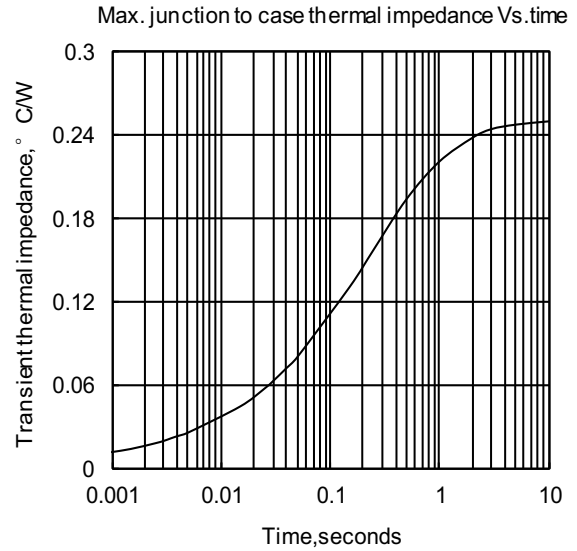

Fig2

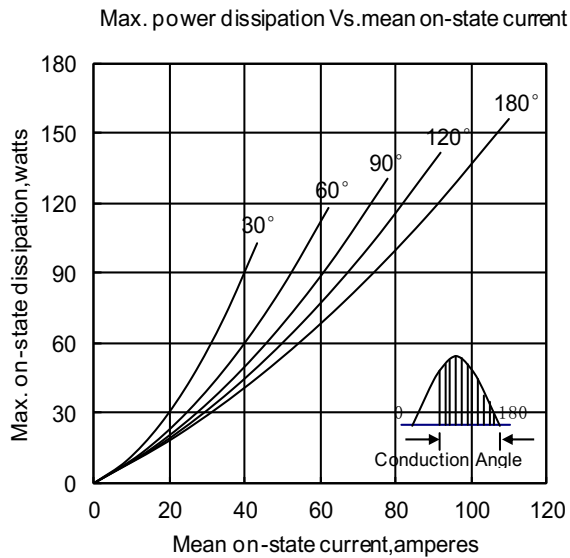

Fig3

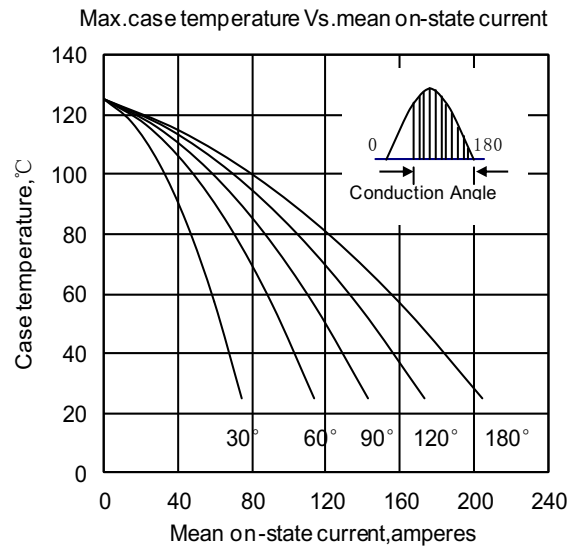

Fig4

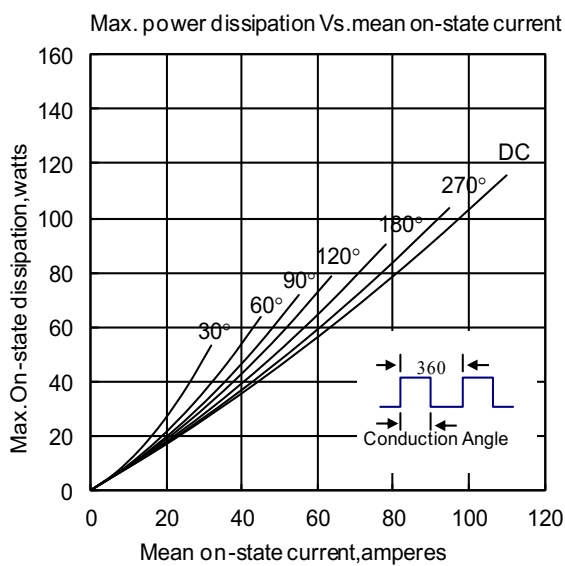

Fig5

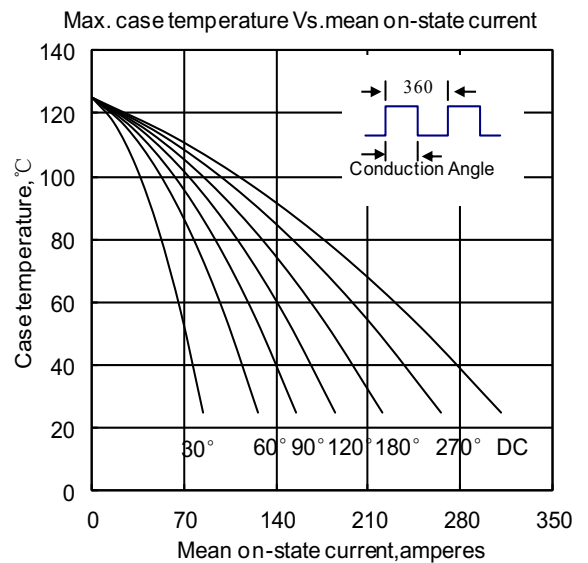

Fig6

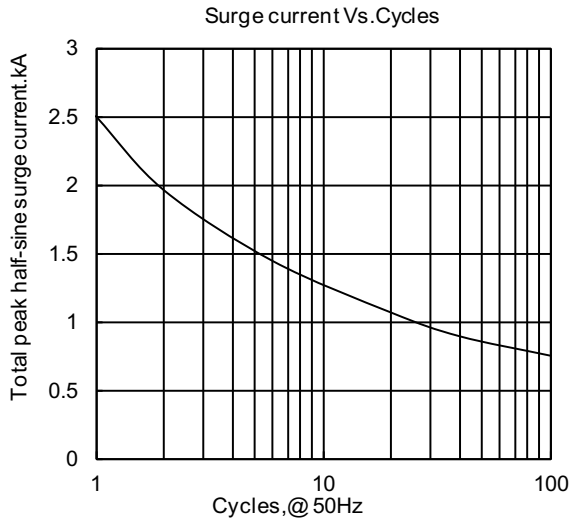

Fig7

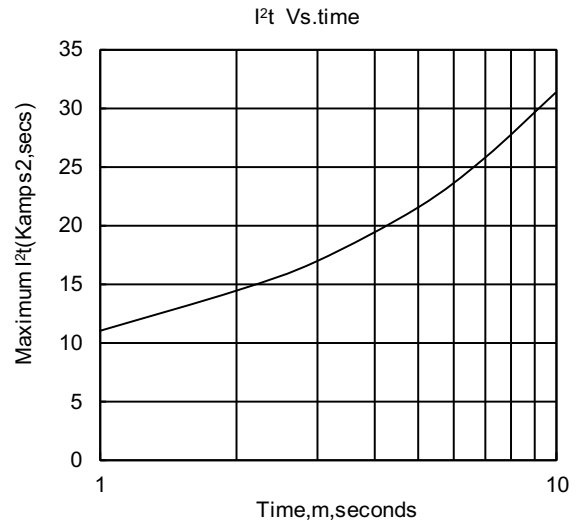

Fig8

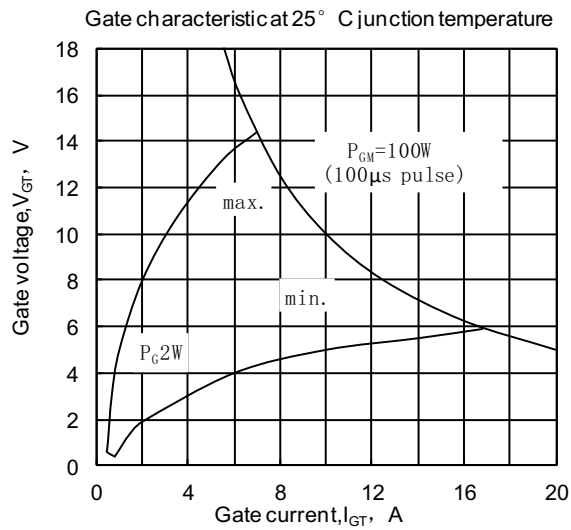

Fig9

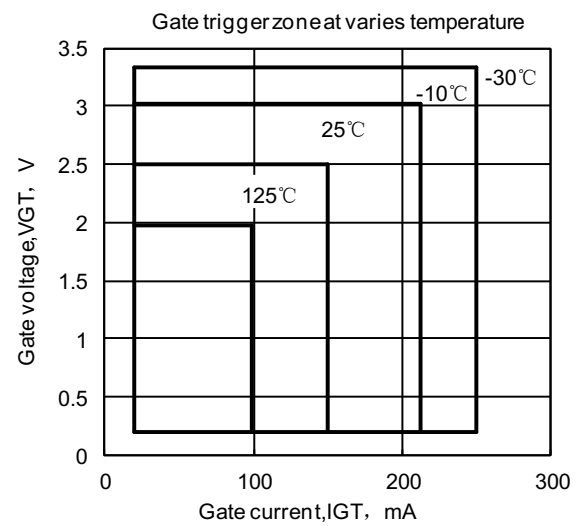
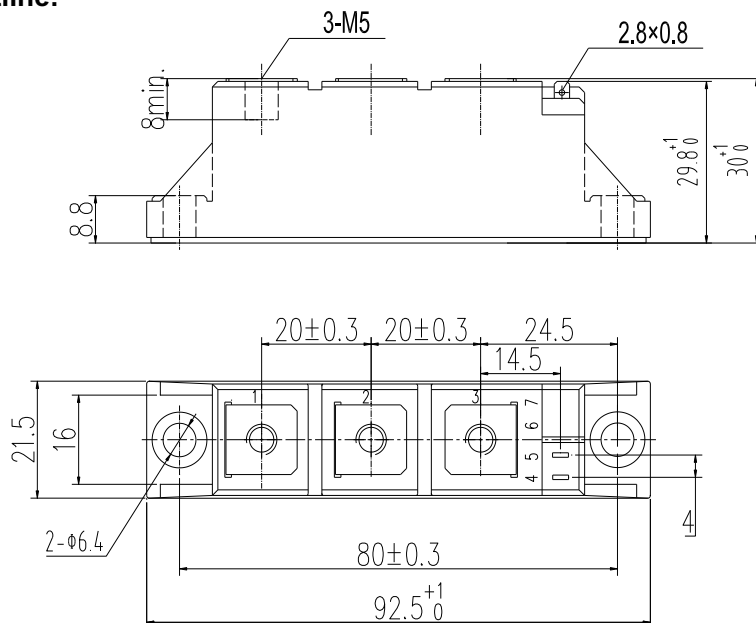

Fig10

Outline:



Unmarked dimensional tolerance: ±0.5mm

