

Features:

- Isolated mounting base 3600V~
- Pressure contact technology with Increased power cycling capability
- Space and weight savings

Typical Applications

- AC/DC Motor drives
- Various rectifiers
- DC supply for PWM inverter

$I_{F(AV)}$ **250A**
 V_{RRM} **2600~3600V**
 I_{FSM} **$9.5 \text{ A} \times 10^3$**
 I^2t **$451 \text{ A}^2 \text{ S} \times 10^3$**



SYMBOL	CHARACTERISTIC	TEST CONDITIONS	T _J (°C)	VALUE			UNIT
				Min	Type	Max	
$I_{F(AV)}$	Mean forward current	180° half sine wave 50Hz Single side cooled, T _C =100°C	150			250	A
$I_{F(RMS)}$	RMS forward current		150			393	A
V_{RRM}	Repetitive peak reverse voltage	V _{RRM} tp=10ms V _{RSM} = V _{RRM} +100V	150	2600		3600	V
I_{RRM}	Repetitive peak current	at V _{RRM}	150			30	mA
I_{FSM}	Surge forward current	10ms half sine wave	150			9.5	KA
I^2t	I ² T for fusing coordination	V _R =0.6V _{RRM}					451
V_{FO}	Threshold voltage		150			0.95	V
r_F	Forward slop resistance						0.87
V_{FM}	Peak forward voltage	I _{FM} =750A	25			1.83	V
$R_{th(j-c)}$	Thermal resistance Junction to case	At 180° sine: Single side cooled				0.13	°C /W
$R_{th(c-h)}$	Thermal resistance case to heatsink	At 180° sine: Single side cooled				0.04	°C /W
V_{iso}	Isolation voltage	50Hz, R.M.S, t=1min, I _{iso} :1mA(max)		3600			V
F_m	Terminal connection torque(M8)				12		N·m
	Mounting torque(M6)				6		N·m
T_{stg}	Stored temperature			-40		125	°C
W_t	Weight				860		g
Outline	413F3						

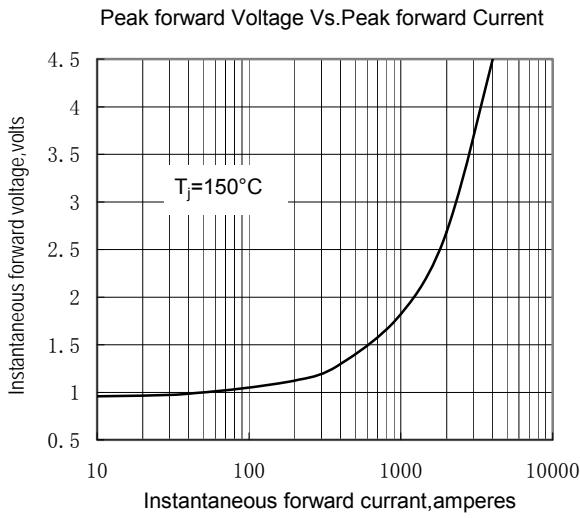

Fig.1

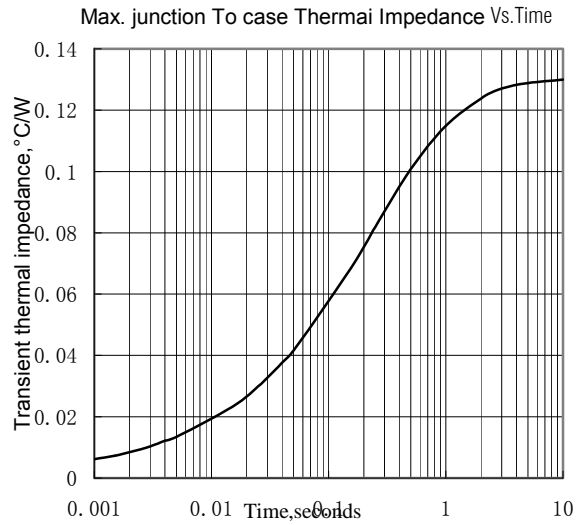

Fig.2

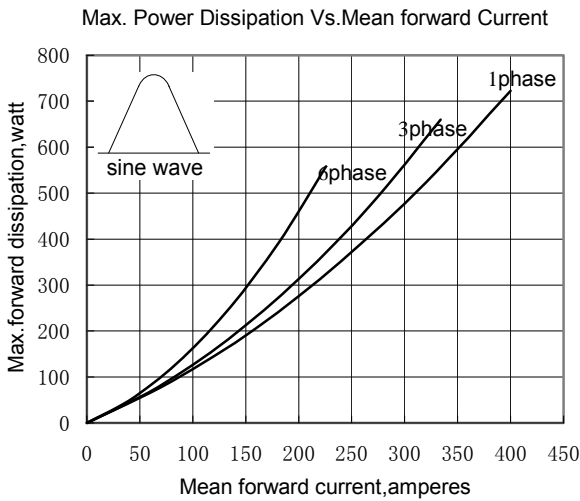

Fig.3

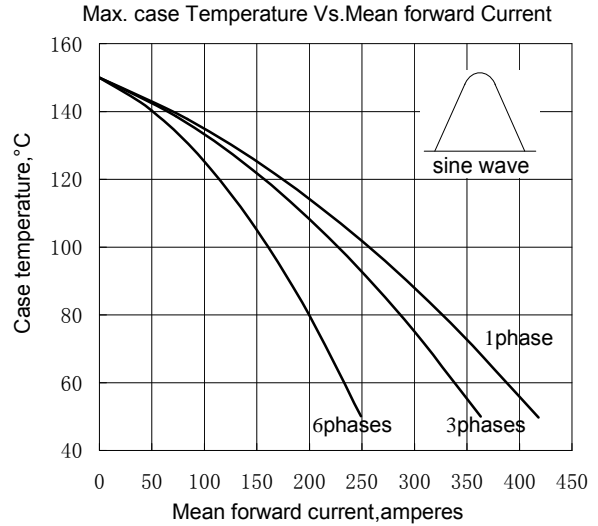

Fig.4

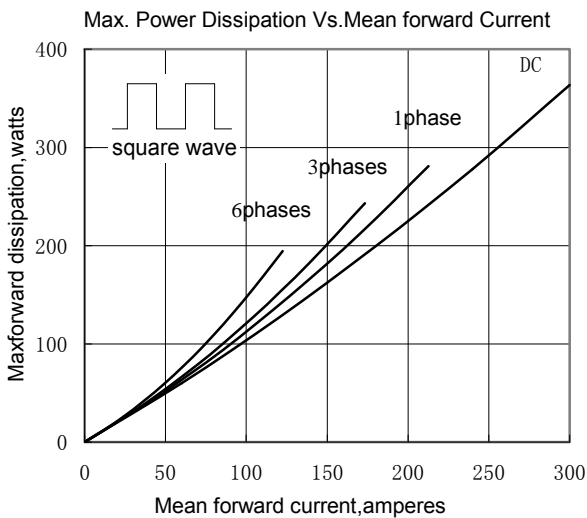

Fig.5

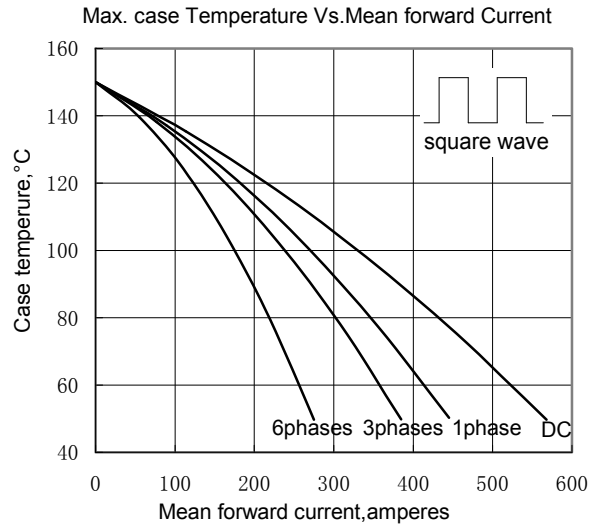

Fig.6

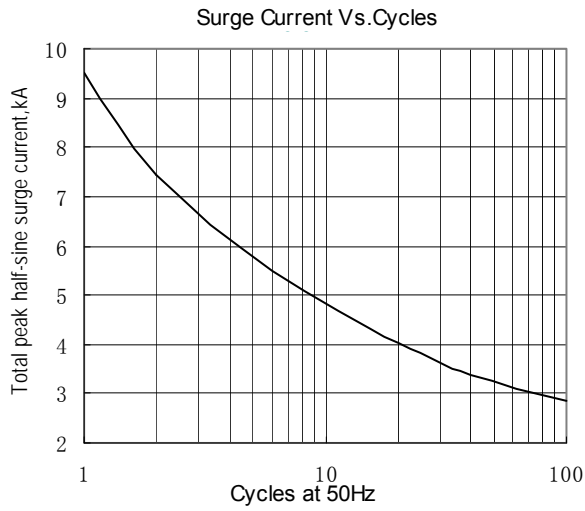

Fig.7

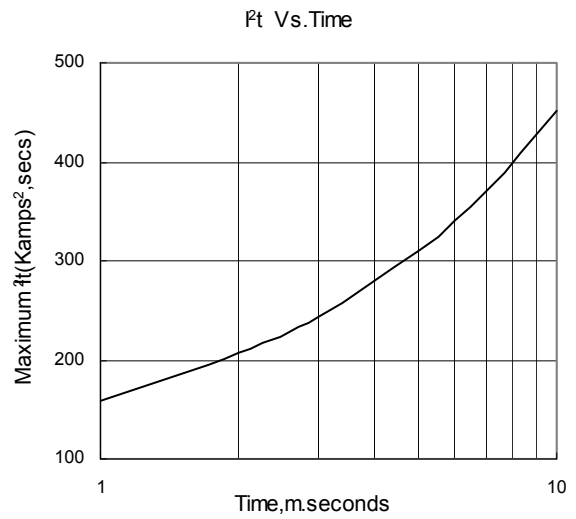
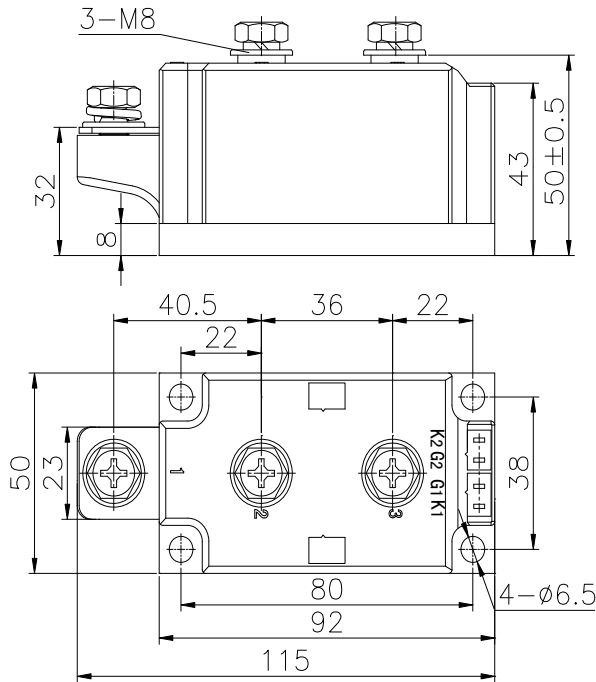

Fig.8

Outline:



413F3

