

# Protected

## → 83 106

- Double break switching
- Options for operation in stable positions
- Choice of actuators and mounting accessories



### Main specifications

	Standard 83 106 0	2 stable lever positions 83 106 4	2 stable plunger positions 83 106 7
<b>Function</b>			
I (changeover)	W3		
I (changeover)	W1 - W2		
R (normally closed)	W1 - W2 - W3		
C (normally open)	W1 - W2 - W3		
<b>Electrical characteristics</b>			
Rating nominal / 250 V AC (A)	5	5	5
Rating thermal / 250 V AC (A)	17.5	17.5	17.5
<b>Mechanical characteristics</b>			
Maximum operating force (N)	4	0.45	2
Min. Release force (N)	1	-	-
Tripping point (mm)	11.45 <sup>+0.2 -0.25</sup>	-	-
Min. overtravel (mm)	0.7	-	-
Mechanical life (operations)	10 <sup>7</sup>	10 <sup>6</sup>	10 <sup>6</sup>
Max. permitted overtravel force (N)	20	-	-
Rest position max. (mm)	12.75	-	-
Differential travel (mm)	0.5 <sup>+0.2</sup>	-	-
Ambient operating temperature (°C)	-40 → +85	-40 → +85	-40 → +85
Contact gap (mm)	0.4 x 2	0.4 x 2	0.4 x 2
Weight (g)	8	9	8

### Additional specifications

#### Components

##### Material

- Case : polyamide UL94V2 (83 106)
- Contacts : nickel silver

##### Levers

- Mild steel (zinc)
- Roller : polyamide
- Adjusting screws : self-retaining
- Plates : iridescent passivated mild steel (zinc)

**NB** : Fixing holes for these microswitches have metal ferrules.

### Product adaptations



- Special levers
- Reinforced spring
- Special contacts
- High operating temperature: 125 °C
- Approvals : UL - cUL

## Principles

### Double break changeover snap-action switch



## Curves

### Operating curve for types 83 106 0 / 4 / 7

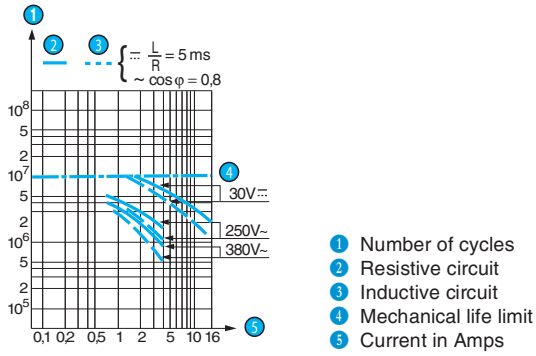

## Dimensions

### → Product

83 106

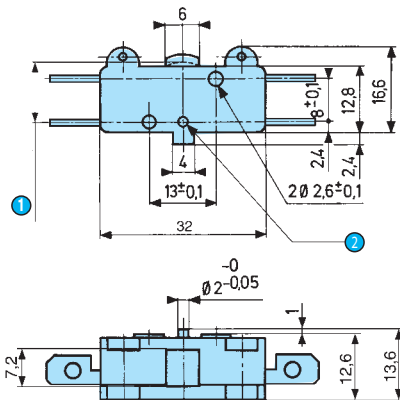

- ① OL = 10.65
- ②  $\text{Ø } 2^{+0.01 +0.65}$  Depth 1.2

83 106 4

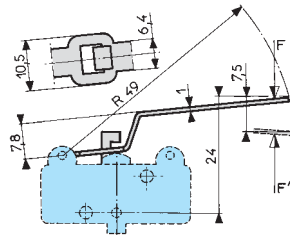

83 106 7

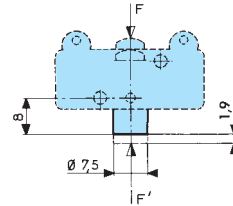

### → Connections

W1 screw

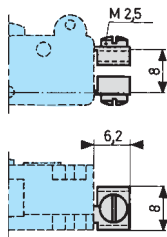

W2 solder

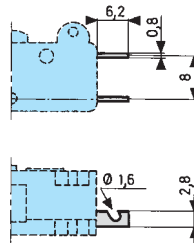

W3 for 6.35 mm clips

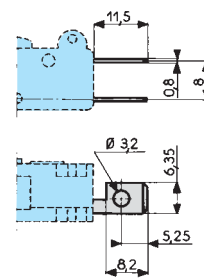

→ Actuators

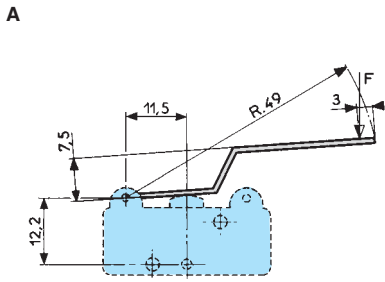

Lever cross-section 1 x 6.4 mm

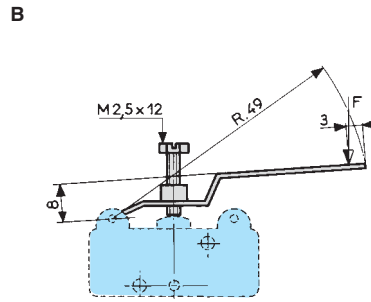

Lever cross-section 1 x 6.4 mm

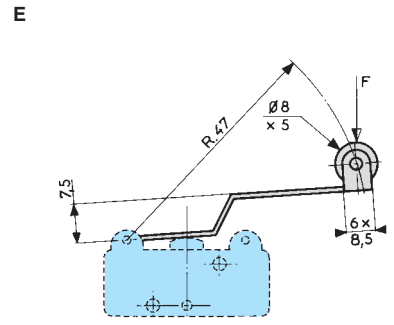

Lever cross-section 1 x 6.4 mm

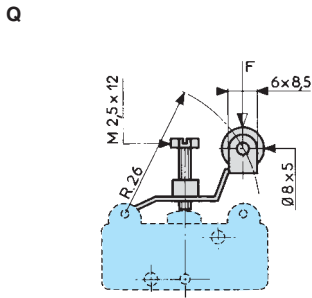

Lever cross-section 1 x 6.4 mm

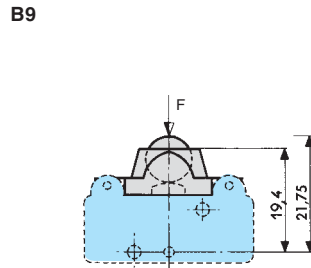

B9

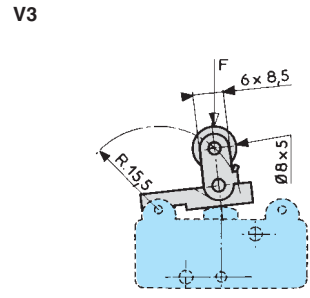

Lever cross-section 1 x 6.4 mm

→ Mounting accessories

O2 2-pole side mounting plate

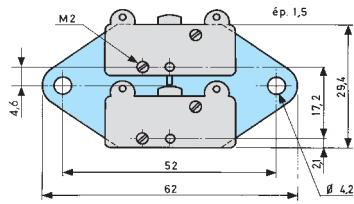

K2 2-pole vertical mounting plate

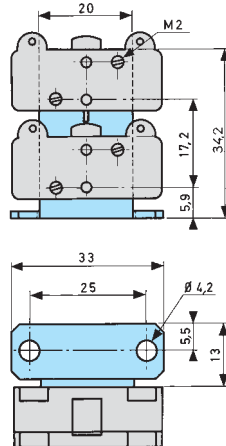

Y Side plate

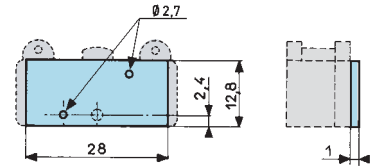



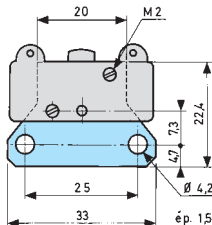



H Horizontal single-pole mounting plate





Unless indicated, the thickness of plates is 1.5 mm

## Actuators and mounting accessories

Actuators		70500888	70500828	70500813	70500840	70500870	70500170
		AR49	BR49	ER47	Q	V3 R15.5	E9
							
Operating force - max.	N	1.2	1.2	1.2	2.8	4	4
Release force - min.	N	0.25	0.25	0.2	0.45	0.8	1
Pre-travel - max.	mm	6.2	6.2	6.2	3.2	1.45	1.5
Differential travel	mm	2.1 ±0.9	2.1 ±0.9	2.1 ±0.9	1.05 ±0.4	0.5 ±0.2	0.5 ±0.2
Total travel max.	mm	7.5	8.4	7.5	4.5	1.9	1.9

Except where otherwise indicated, the flat and roller levers are mounted as shown in the dimensional drawings (mounted on the left).

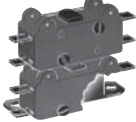
Mounting accessories		70500206	70500208	70500218	70500216
		Y Side plate	H Horizontal single-pole mounting plate	O2 2-pole side mounting plate	K2 2-pole vertical mounting plate
					

Screws: Length	14.5	70599106
	16	70599102
	27.5	70599110

## Other information

### Mounting - Operation

See basic technical concepts

To ensure protection against electric shock after installation in the application, please consult us when conductive parts are located less than 3mm from case/cover rear mating surfaces, opposite to button side.

# Protected

## → 83 109

- Double break switching
- Front connections
- Options for operation in stable positions
- Choice of actuators and mounting accessories



## Main specifications

		Outputs on front face 83 109 0
<b>Function</b>	<b>Connections</b>	
I (changeover)	W2	
R (normally closed)	W2	
C (normally open)	W2	
<b>Electrical characteristics</b>		
Rating nominal / 250 V AC (A)		5
Rating thermal / 250 V AC (A)		17.5
<b>Mechanical characteristics</b>		
Maximum operating force (N)		4
Min. Release force (N)		1
Tripping point (mm)		11.45 <sup>+0.2 - 0.25</sup>
Min. overtravel (mm)		0.7
Mechanical life (operations)		10 <sup>7</sup>
Max. permitted overtravel force (N)		20
Rest position max. (mm)		12.75
differential travel (mm)		0.5 <sup>-0.2</sup>
Ambient operating temperature (°C)		- 40 → +85
Contact gap (mm)		0.4 x 2
Weight (g)		8

## Additional specifications

### Components

#### Material

- Case : polyamide UL94V2
- Contacts : nickel silver

#### Levers

- Mild steel (zinc)
- Roller : polyamide
- Adjusting screws : self-retaining
- Plates : iridescent passivated mild steel (zinc)

**NB** : Fixing holes for these microswitches have metal ferrules.

## Product adaptations



- Special levers
- Reinforced spring
- Special contacts
- Approvals : UL - cUL

## Principles

Double break changeover snap-action switch



## Curves

Operating curve for type 83 109 0

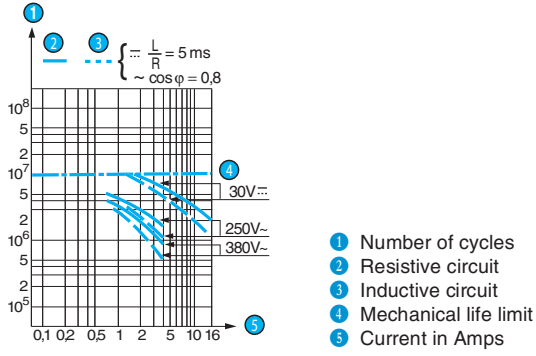

## Dimensions

### → Product

83 109 0

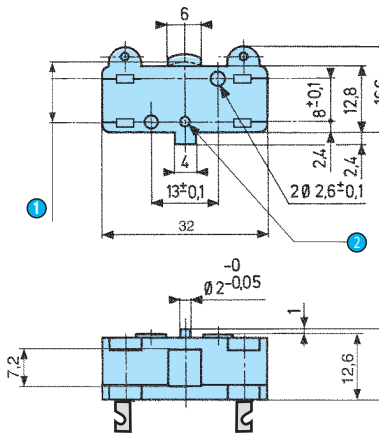

### → Connections

W2 solder

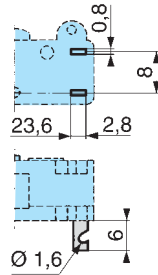

### → Actuators

A

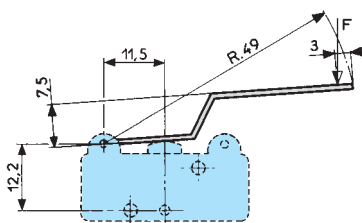

Lever cross-section 1 x 6.4 mm

B

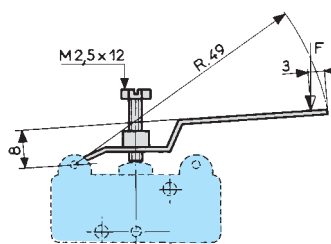

Lever cross-section 1 x 6.4 mm

E

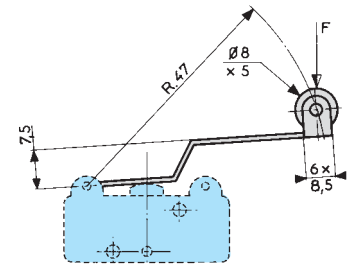

Lever cross-section 1 x 6.4 mm

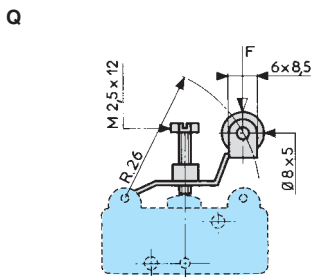

Lever cross-section 1 x 6.4 mm

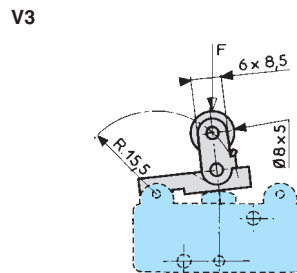
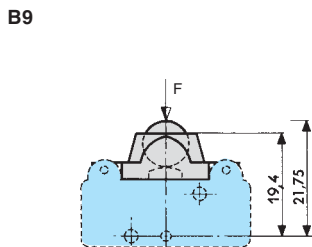

Lever cross-section 1 x 6.4 mm

→ Mounting accessories

O2 2-pole side mounting plate

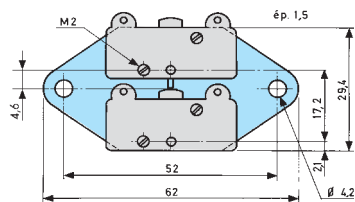

K2 2-pole vertical mounting plate

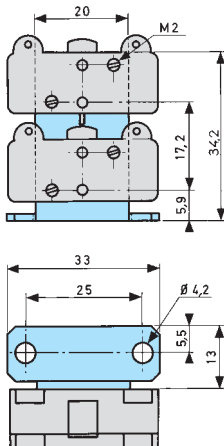



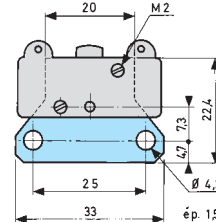



H Horizontal single-pole mounting plate



Unless indicated, the thickness of plates is 1.5 mm

Actuators and mounting accessories

Actuators	70500888	70500828	70500813	70500840	70500870	70500170
	AR49	BR49	ER47	Q	V3 R15.5	B9
						
Operating force - max.	N 1.2	1.2	1.2	2.8	4	4
Release force - min.	N 0.25	0.25	0.2	0.45	0.8	1
Pre-travel - max.	mm 6.2	6.2	6.2	3.2	1.45	1.5
Differential travel	mm 2.1 ±0.9	2.1 ±0.9	2.1 ±0.9	1.05 ±0.4	0.5 ±0.2	0.5 ±0.2
Total travel max.	mm 7.5	8.4	7.5	4.5	1.9	1.9

Except where otherwise indicated, the flat and roller levers are mounted as shown in the dimensional drawings (mounted on the left)..

Mounting accessories	70500208	70500218	70500216
	H Horizontal single-pole mounting plate	O2 2-pole side mounting plate	K2 2-pole vertical mounting plate
			
Screws: Length	14.5	70599106	

Other information

Mounting - Operation

See basic technical concepts

To ensure protection against electric shock after installation in the application, please consult us when conductive parts are located less than 3mm from case/cover rear mating surfaces, opposite to button side.

# Protected

## → 83 111

- Double break switching
- Rear-fixing via nuts or clips
- Choice of actuators



### Main specifications

Function	Connections	Rear-fixing by nuts 83 111 0	Rear-fixing by clips 83 111 5
		83 111 001	83 111 525
I (changeover)	W3	●	●
I (changeover)	W1 - W2	●	●
R (normally closed)	W1 - W2 - W3	●	●
C (normally open)	W1 - W2 - W3	●	●
<b>Electrical characteristics</b>			
Rating nominal / 250 V AC (A)		5	5
Rating thermal / 250 V AC (A)		17.5	17.5
<b>Mechanical characteristics</b>			
Maximum operating force (N)		4	4
Min. Release force (N)		1	1
Tripping point (mm)		11.45 <sup>+0.2 - 0.25</sup>	11.45 + 0.2 - 0.25
Min. overtravel (mm)		0.7	0.7
Mechanical life (operations)		10 <sup>7</sup>	10 <sup>7</sup>
Max. permitted overtravel force (N)		20	20
Rest position max. (mm)		-	-
Maximum differential travel (mm)		0.5 <sup>+0.2</sup>	0.5 <sup>+0.2</sup>
Ambient operating temperature (°C)		- 40 → +85	- 40 → +85
Contact gap (mm)		0.4 x 2	0.4 x 2
Weight (g)		8	8

### Additional specifications

#### Components

##### Material

- Case : polyamide UL94V2
- Contacts : nickel silver

##### Levers

- Mild steel (zinc)
- Roller : polyamide
- Adjusting screws : self-retaining
- Plates : iridescent passivated mild steel (zinc)

**NB** : Fixing holes for these microswitches have metal ferrules.

### Product adaptations



- Special levers
- Reinforced spring
- Special contacts
- Approvals : UL - cUL



## Principles

Double break changeover snap-action switch



## Curves

Operating curve for types 83 111 0 - 83 111 5

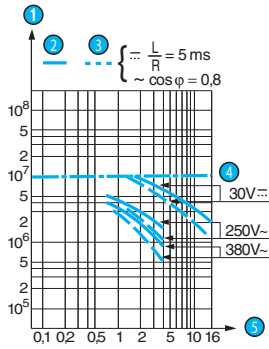

- 1 Number of cycles
- 2 Resistive circuit
- 3 Inductive circuit
- 4 Mechanical life limit
- 5 Current in Amps

## Dimensions

### → Product

83 111 0

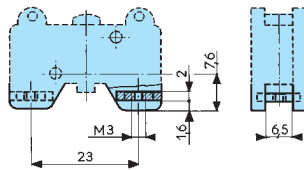

83 111 5

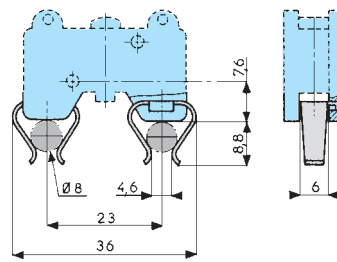

### → Connections

W1 screw

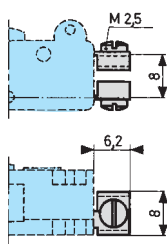

W2 solder

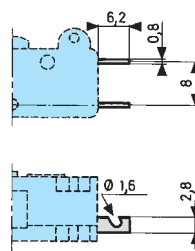

W3 for 6.35 mm clips

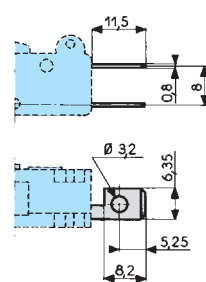

→ Actuators

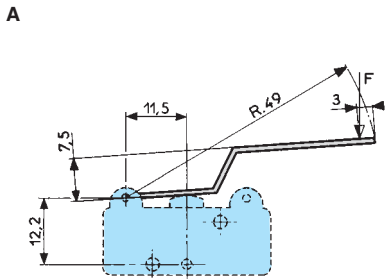

Lever cross-section 1 x 6.4 mm

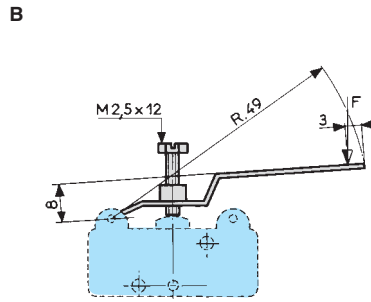

Lever cross-section 1 x 6.4 mm

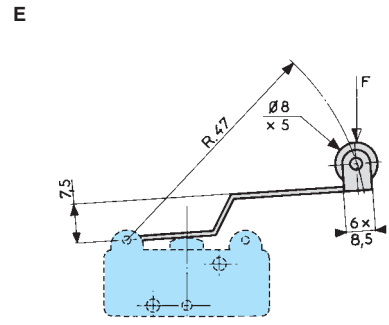

Lever cross-section 1 x 6.4 mm

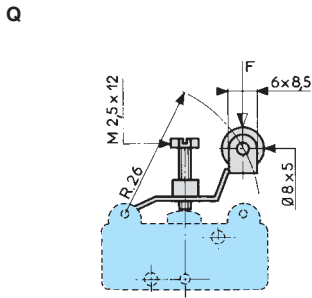

Lever cross-section 1 x 6.4 mm

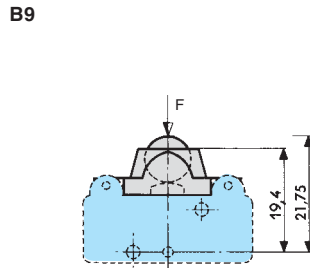



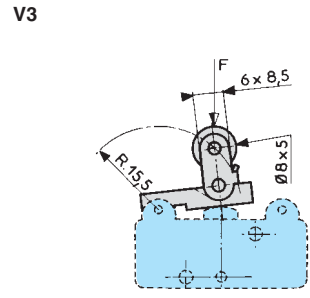



B9



Lever cross-section 1 x 6.4 mm

Actuators and mounting accessories

Actuators	70500888	70500828	70500813	70500840	70500870	70500170	
	AR49	BR49	ER47	Q	V3 R15.5	B9	
							
Operating force - max.	N	1.2	1.2	1.2	2.8	4	4
Release force - min.	N	0.25	0.25	0.2	0.45	0.8	1
Pre-travel - max	mm	6.2	6.2	6.2	3.2	1.45	1.5
Differential travel	mm	2.1 ±0.9	2.1 ±0.9	2.1 ±0.9	1.05 ±0.4	0.5 ±0.2	0.5 ±0.2
Total travel max.	mm	7.5	8.4	7.5	4.5	1.9	1.9

Except where otherwise indicated, the flat and roller levers are mounted as shown in the dimensional drawings (mounted on the left)..

Other information

Mounting - Operation

See basic technical concepts

# Protected

## → 83 112

- Double break switching
- Built-in screw connections
- Options for operation in stable positions
- Choice of actuators and mounting accessories



### Main specifications

		Built-in screw connections 83 112 0
<b>Function</b>	<b>Connections</b>	
I (changeover)	W1	
<b>Electrical characteristics</b>		<b>83 112 001</b>
Rating nominal / 250 V AC (A)		5
Rating thermal / 250 V AC (A)		17.5
<b>Mechanical characteristics</b>		
Maximum operating force (N)		4
Min. Release force (N)		1
Tripping point (mm)		11.45 <sup>+0.2 -0.25</sup>
Min. overtravel (mm)		0.7
Mechanical life (operations)		10 <sup>7</sup>
Max. permitted overtravel force (N)		20
Rest position max. (mm)		12.75
differential travel (mm)		0.5 <sup>+0.2</sup>
Ambient operating temperature (°C)		-40 → +85
Contact gap (mm)		0.4 x 2
Weight (g)		14.5

### Additional specifications

#### Components

##### Material

- Case : polyamide UL94V2
- Contacts : nickel silver

##### Levers

- Mild steel (zinc)
- Roller : polyamide
- Adjusting screws : self-retaining
- Plates : iridescent passivated mild steel (zinc)

**NB** : Fixing holes for these microswitches have metal ferrules.

### Product adaptations



- Special levers
- Reinforced spring
- Special contacts
- Approvals : UL - cUL

## Principles

### Double break changeover snap-action switch



## Curves

### Operating curve for type 83 112 0

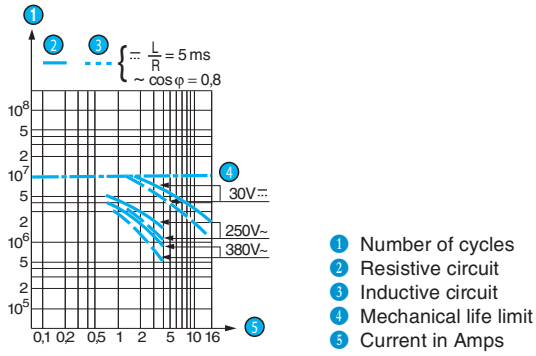

## Dimensions

### → Product

83 112 0

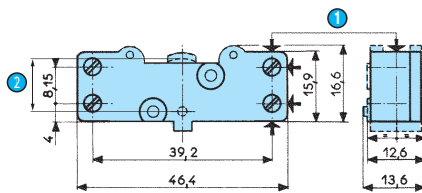

- 1 Connection
- 2 OL = 10.65

### → Actuators

A

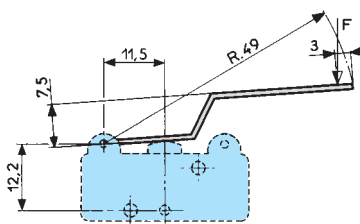

Lever cross-section 1 x 6.4 mm

B

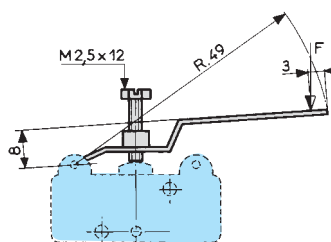

Lever cross-section 1 x 6.4 mm

E

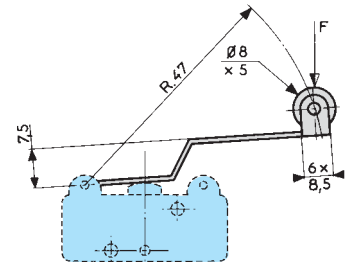

Lever cross-section 1 x 6.4 mm

Q

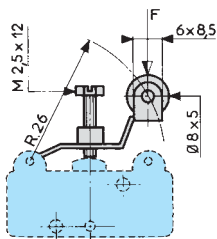

Lever cross-section 1 x 6.4 mm

B9

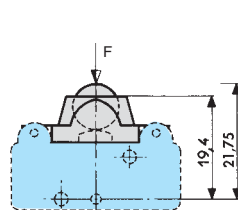

V3

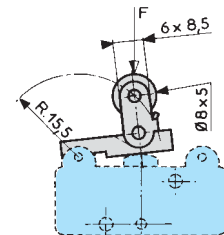

Lever cross-section 1 x 6.4 mm

→ Mounting accessories

**O2**  
2-pole side mounting plate

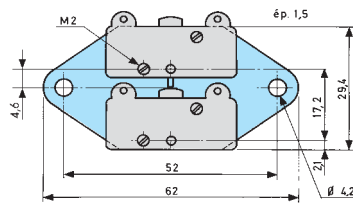

**K2**  
2-pole vertical mounting plate

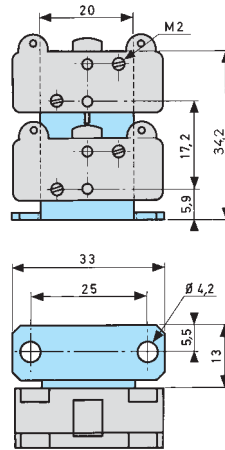



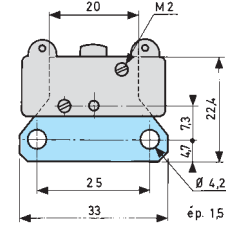



**H**  
Horizontal single-pole mounting plate





Unless indicated, the thickness of plates is 1.5 mm

Actuators and mounting accessories

Actuators	70500888	70500828	70500813	70500840	70500870	70500170
	AR49	BR47	ER47	Q	V3 R15,5	B9
						
Operating force - max.	N	1.2	1.2	1.2	2.8	4
Release force - min.	N	0.25	0.25	0.2	0.45	0.8
Pre-travel - max.	mm	6.2	6.2	6.2	3.2	1.45
Differential travel	mm	2.1 ±0.09	2.1 ±0.09	2.1 ±0.09	1.05 ±0.4	0.5 ±0.2
Total travel max.	mm	7.5	8.4	7.5	4.5	1.9

Except where otherwise indicated, the flat and roller levers are mounted as shown in the dimensional drawings (mounted on the left)..

Mounting accessories	70500208	70500218	70500216
	H Horizontal single-pole mounting plate	O2 2-pole side mounting plate	K2 2-pole vertical mounting plate
			
Screws: Length	14.5	70599106	

Other information

Mounting - Operation

See basic technical concepts

To ensure protection against electric shock after installation in the application, please consult us when conductive parts are located less than 3mm from case/cover rear mating surfaces, opposite to button side.

Warning:

The product information contained in this catalogue is given purely as information and does not constitute a representation, warranty or any form of contractual commitment. Crouzet Automatismes SAS and its subsidiaries reserve the right to modify their products without notice. It is imperative that we should be consulted over any particular use or application of our products and it is the responsibility of the buyer to establish, particularly through all the appropriate tests, that the product is suitable for the use or application. Under no circumstances will our warranty apply, nor shall we be held responsible for any application (such as any modification, addition, deletion, use in conjunction with other electrical or electronic components, circuits or assemblies, or any other unsuitable material or substance) which has not been expressly agreed by us prior to the sale of our products.