



## | D06D SERIES

PANEL MOUNT



### Features

- Ratings from 60 A to 100 A @ 60 VDC
- Mosfet Output
- UL Approved, CE Compliant to EN60950-1
- Improved SEMS Screw and Washer
- Redesigned Housing with Anti-Rotation Barriers
- DC Control
- EMC Compliant to Level 3
- Epoxy Free Design

### Product Selection

Control Voltage	60A	80A	100A
3.5-32 VDC	D06D060	D06D080	D06D100



### SPECIFICATIONS

#### Output Specifications <sup>(2)</sup>

Description	60A	80A	100A
Recommended Operating Voltage [Vdc]	1-48	1-48	1-48
Absolute Maximum Rating [Vdc]	60	60	60
Maximum Off-State Leakage Current @ Rated Voltage [mA]	0.1	0.1	0.1
Maximum Load Current [Adc] <sup>(1) (3)</sup>	3	5	7
Minimum Load Current [mA] <sup>(4)</sup>	5	5	5
Maximum Surge Current (10 msec) [Adc]	180	220	270
Maximum On-State Voltage Drop @ Rated Current [Vdc]	0.6	0.7	0.5
Thermal Resistance Junction to Case (Rjc) [°C/W]	0.73	0.73	0.51
Minimum Heat Sink @ Ambient (for max current = °C/W & Ta)	1	0.5	0.5
Maximum Pulse Width Modulation Frequency [Hz] <sup>(5)</sup>	1000	900	700

## Input Specifications <sup>(2)</sup>

Description	DC Control
Control Voltage Range	3.5-32 VDC
Maximum Reverse Voltage	-32 VDC
Minimum Turn-On Voltage <sup>(6)</sup>	3.5 VDC
Must Turn-Off Voltage	1 VDC
Minimum Input Current (For On-State)	10 mA
Maximum Input Current	15 mA
Nominal Input Impedance	Current Regulated
Maximum Turn-On Time [μsec]	100
Maximum Turn-Off Time [μsec]	150

## General Specifications <sup>(2)</sup>

Description	Parameters
Dielectric Strength, Input/Output/Base (50/60Hz) <sup>(2)</sup>	3750 Vrms
Minimum Insulation Resistance (@500 VDC) <sup>(2)</sup>	10 <sup>9</sup> Ohm
Maximum Capacitance, Input/Output	8 pF
Ambient Operating Temperature Range <sup>(7)</sup>	-40 to 100°C
Ambient Storage Temperature Range	-40 to 125°C
Weight (typical)	2.66 oz. (75.5 g)
Housing Material	UL94 V-0
Baseplate Material	Aluminum
Input Terminal Screw Torque Range (in-lb/NM)	13-15 / 1.5-1.7
Load Terminal Screw Torque Range (in-lb/NM)	18-20 / 2-2.2
SSR Mounting Screw Torque Range (in-lb/Nm)	18-20 / 2-2.2
Input/Load Terminal Screw Torque Range (in-lb/NM) <sup>(1)</sup>	w/"K" Option 8-10 / 0.9-1.13
Input/Load Terminal Screw Thread Size	#6-32 UNC / #8-32 UNC
Humidity per IEC60068-2-78	93% non-condensing
MTBF (Mean Time Between Failures) at 40°C Ambient Temperature <sup>(8)</sup>	21,395,130 hours (2,441 years)
MTBF (Mean Time Between Failures) at 60°C Ambient Temperature <sup>(8)</sup>	11,545,504 hours (1,317 years)



## WIRING DIAGRAM

\* Inductive loads must be diode suppressed.

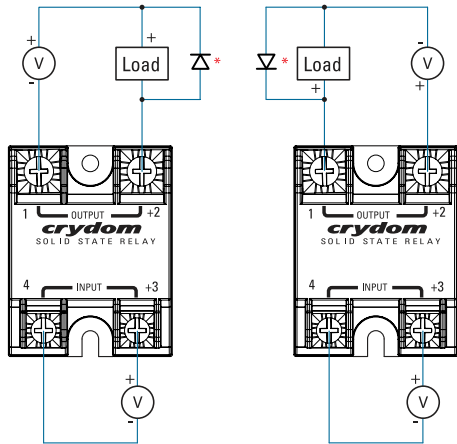

Recommended Wire Sizes		
Terminals	Wire Size (Solid / Stranded)	Wire Pull-Out Strength (lb) [N]
Input	24 AWG (0.2 mm <sup>2</sup> ) / 0.2 [minimum]	<b>10 [44.5]</b>
	2 x 12 AWG (3.3 mm <sup>2</sup> ) / 3.3 [maximum]	<b>90 [400]</b>
Output	20 AWG (0.5 mm <sup>2</sup> ) / 0.518 [minimum]	<b>30 [133]</b>
	2 x 10 AWG (5.3 mm <sup>2</sup> ) / 5.3	<b>110 [490]</b>
	2 x 8 AWG (8.4 mm <sup>2</sup> ) / 8.4 [maximum]	<b>90 [400]</b>



## EQUIVALENT CIRCUIT BLOCK DIAGRAMS

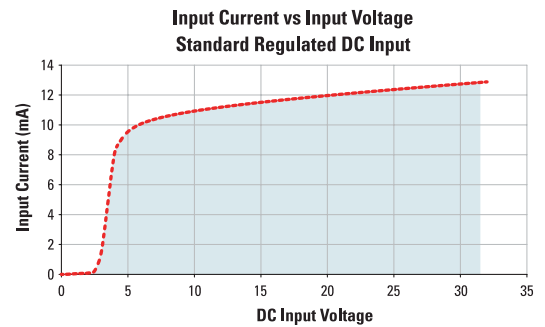
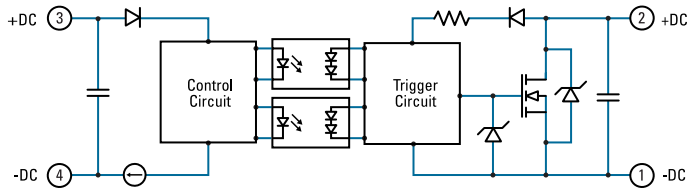



## MECHANICAL SPECIFICATIONS (2)

Tolerances: ±0.02 in / 0.5 mm  
All dimensions are in inches [millimeters]

### Screw Termination

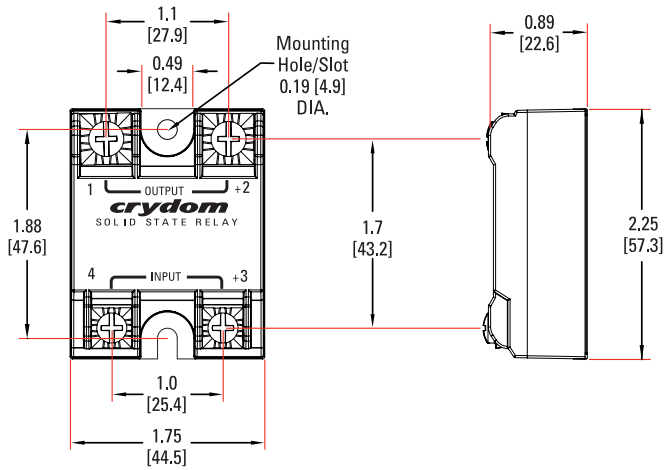

### Hex Standoff Termination ("K" Option) (1)

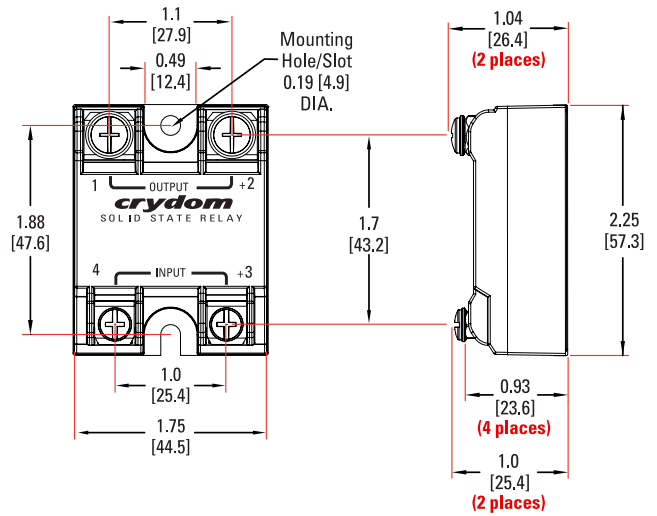

## SURGE CURRENT INFORMATION

--- Single Pulse (i) — Duty Factor (10%) (ii) - - - Duty Factor (20%) (ii) — Duty Factor (50%) (ii)

DC06D60

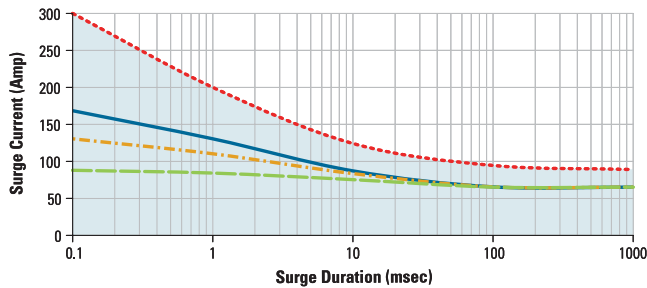

DC06D80

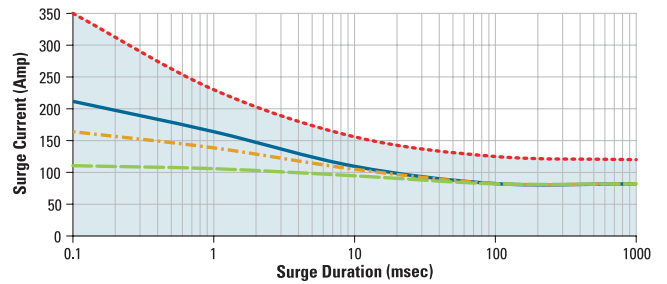

DC06D100

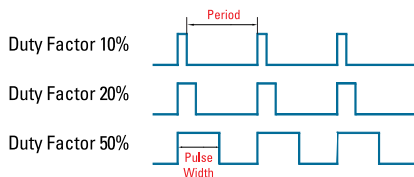
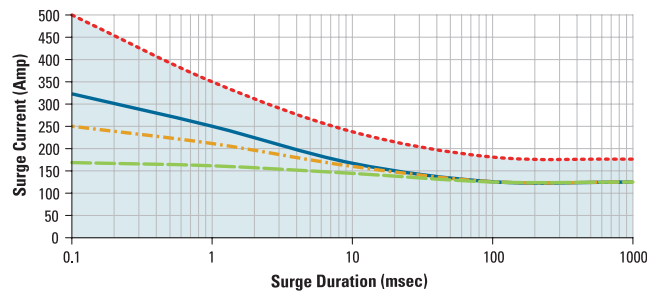

For Pulse Width Modulation applications select the curve according to duty factor and pulse duration as following.

$$\text{Duty Factor} = \frac{\text{Pulse Width}}{\text{Period}} \times 100 (\%)$$

(i) for Single Surge Pulse  $T_c=40^\circ\text{C}; T_j 175^\circ\text{C}$   
(ii) for Repetitive Surge Pulse  $T_c=40^\circ\text{C}; T_j 130^\circ\text{C}$



# THERMAL DERATE INFORMATION

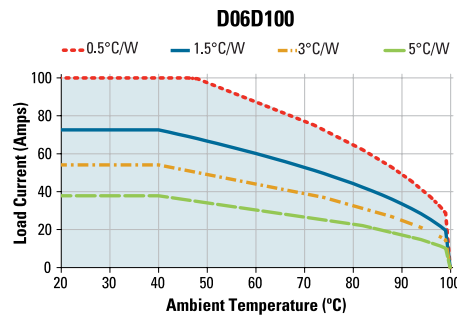
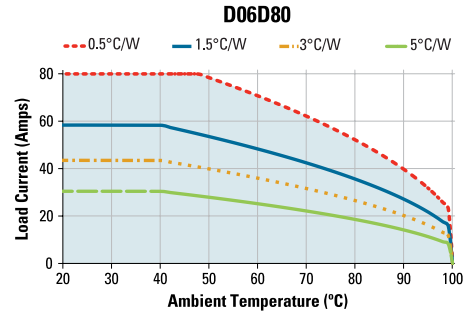
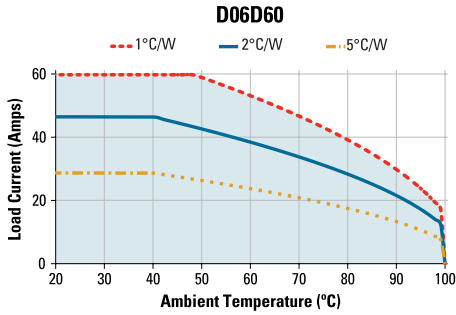

# ORDERING OPTIONS

Example : D06D60KH

1-60VDC, 60 Amps, Installed Standoffs, Thermal Pad Included

**D** - **06D** - **60** - **K** - **H**

**Series** \_\_\_\_\_

**Required for Valid Part Number**

**Operating Voltage** \_\_\_\_\_

**06D:** 1-60 VDC

**Required for Valid Part Number**

**Rated Load Current** \_\_\_\_\_

**60:** 60 Amps  
**80:** 80 Amps  
**100:** 100 Amps

**Required for Valid Part Number**

**Termination** \_\_\_\_\_

**Blank:** Screws & clamps  
**K:** Installed standoffs with screws for PC Board mounting <sup>(1)</sup>

**Thermal Pad** \_\_\_\_\_

**Blank:** Not Included  
**H:** Included

— Required for valid part number  
□ For options only and not required for valid part number

<sup>(1)</sup> Not all part number combinations are available. Contact Sensata Technical Support for information on the availability of a specific part number.



## ACCESSORIES

### New Accessories!

#### Protective Cover and Hardware Kits

##### Protective Cover

Part Number KS101



Clear plastic cover compatible with all new S1 designs. Safety covers provide added protection from electric shock when installing or checking equipment.



##### Hardware Kit

Part Number HK4

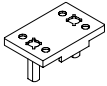

Bag with 2 square brass accessories and 2 screw 8-32 x 5/8 for output. Used to mount TMR1 lug terminals.

### Recommended Accessories

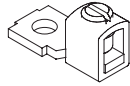
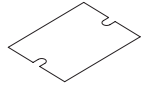
					
Cover	Hardware Kit	Heat Sink Part No.	Thermal Resistance [°C/W]	Lug Terminal	Thermal Pad
KS101	HK1 HK4	HS501DR HS301 / HS301DR HS251 HS201 / HS201DR HS202 / HS202DR HS172 HS151 / HS151DR HS122 / HS122DR HS103 / HS103DR HS101 HS073 HS072 HS053 HS033 HS023	5.0 3.0 2.5 2.0 2.0 1.7 1.5 1.2 1.0 1.0 0.7 0.7 0.5 0.36 0.25	TRM1 TRM6	HSP-1 HSP-2



## GENERAL NOTES

- (1) Option "K" is designed and tested for use with printed circuit boards or ring/fork terminals having a thickness between 0.031 and 0.093 inches (0.79 to 2.36 mm), and loads rated up to 50 Amps. For higher load currents, the "K" standoff temperature must not exceed 105°C. For additional application assistance please contact Sensata Technical Support.
- (2) All parameters at Tc=25°C unless otherwise specified.
- (3) Heat sinking required, see derating curves.
- (4) Low current loads and high ambient temperature can affect turn-on time.
- (5) 8VDC minimum control voltage. Resistive loads only. Consider switching losses; at maximum frequency reduce to 75% output current.
- (6) Increase minimum voltage by 1V for operations from -20°C to 40°C.
- (7) Decrease maximum control voltage 1.35V/°C above 80°C ambient temperature.
- (8) All parameters at 50% power rating and 100% duty cycle (contact Sensata tech support for detailed report).

For additional information or specific questions, contact Sensata Technical Support.



## AGENCY APPROVALS & CERTIFICATIONS



- EN60950-1: Meets the requirements of sections 1.5: 1,7: 2.9: 2.10.5.3: 4.2: 4.5: 4.7:
- IEC 61000-4-2 Electrostatic Discharge Level 3
- IEC 61000-4-4 Electrically Fast Transients Level 3
- IEC 61000-4-5 Electrical Surges Level 3-1: Meets the requirements of sections 1.5: 1,7: 2.9: 2.10.5.3: 4.2: 4.5: 4.7:
- E116950
- Vibration Resistance: IEC 60068-2-6 : Amplitude Range 10-55 Hz, Displacement 0.75mm
- Shock Resistance: IEC 60068-2-27 : Peak Acceleration 15g, Duration 11msec



## WARNINGS



### RISK OF MATERIAL DAMAGE AND HOT ENCLOSURE

- The product's side panels may be hot, allow the product to cool before touching
- Follow proper mounting instructions including torque values
- Do not allow liquids or foreign objects to enter this product

**Failure to follow these instructions can result in serious injury, or equipment damage.**



### HAZARD OF ELECTRIC SHOCK, EXPLOSION OR ARC FLASH

- Disconnect all power before installing or working with this equipment
- Verify all connections and replace all covers before turning on power

**Failure to follow these instructions will result in death or serious injury.**

Sensata Technologies, Inc. ("Sensata") data sheets are solely intended to assist designers ("Buyers") who are developing systems that incorporate Sensata products (also referred to herein as "components"). Buyer understands and agrees that Buyer remains responsible for using its independent analysis, evaluation and judgment in designing Buyer's systems and products. Sensata data sheets have been created using standard laboratory conditions and engineering practices. Sensata has not conducted any testing other than that specifically described in the published documentation for a particular data sheet. Sensata may make corrections, enhancements, improvements and other changes to its data sheets or components without notice.

Buyers are authorized to use Sensata data sheets with the Sensata component(s) identified in each particular data sheet. HOWEVER, NO OTHER LICENSE, EXPRESS OR IMPLIED, BY ESTOPPEL OR OTHERWISE TO ANY OTHER SENSATA INTELLECTUAL PROPERTY RIGHT, AND NO LICENSE TO ANY THIRD PARTY TECHNOLOGY OR INTELLECTUAL PROPERTY RIGHT, IS GRANTED HEREIN. SENSATA DATA SHEETS ARE PROVIDED "AS IS". SENSATA MAKES NO WARRANTIES OR REPRESENTATIONS WITH REGARD TO THE DATA SHEETS OR USE OF THE DATA SHEETS, EXPRESS, IMPLIED OR STATUTORY, INCLUDING ACCURACY OR COMPLETENESS. SENSATA DISCLAIMS ANY WARRANTY OF TITLE AND ANY IMPLIED WARRANTIES OF MERCHANTABILITY, FITNESS FOR A PARTICULAR PURPOSE, QUIET ENJOYMENT, QUIET POSSESSION, AND NON-INFRINGEMENT OF ANY THIRD PARTY INTELLECTUAL PROPERTY RIGHTS WITH REGARD TO SENSATA DATA SHEETS OR USE THEREOF.

All products are sold subject to Sensata's terms and conditions of sale supplied at [www.sensata.com](http://www.sensata.com) SENSATA ASSUMES NO LIABILITY FOR APPLICATIONS ASSISTANCE OR THE DESIGN OF BUYERS' PRODUCTS. BUYER ACKNOWLEDGES AND AGREES THAT IT IS SOLELY RESPONSIBLE FOR COMPLIANCE WITH ALL LEGAL, REGULATORY AND SAFETY-RELATED REQUIREMENTS CONCERNING ITS PRODUCTS, AND ANY USE OF SENSATA COMPONENTS IN ITS APPLICATIONS, NOTWITHSTANDING ANY APPLICATIONS-RELATED INFORMATION OR SUPPORT THAT MAY BE PROVIDED BY SENSATA.

Mailing Address: Sensata Technologies, Inc., 529 Pleasant Street, Attleboro, MA 02703, USA.

## CONTACT US

### Americas

+1 (877) 502 5500 – Option 2

[sales.crydom@sensata.com](mailto:sales.crydom@sensata.com)

### Europe, Middle East & Africa

+44 (1202) 416170

[ssr-info.eu@sensata.com](mailto:ssr-info.eu@sensata.com)

### Asia Pacific

[sales.isasia@list.sensata.com](mailto:sales.isasia@list.sensata.com)

China +86 (21) 2306 1500

Japan +81 (45) 277 7117

Korea +82 (31) 601 2004

India +91 (80) 67920890

Rest of Asia +886 (2) 27602006

ext 2808

# Mouser Electronics

Authorized Distributor

Click to View Pricing, Inventory, Delivery & Lifecycle Information:

[Sensata:](#)

[D06D100](#) [D06D60](#) [D06D80](#) [D06D100H](#) [D06D100K](#)