

# Delphi Elements – Overview

4501 End module 120x85 cm, Arm L or R

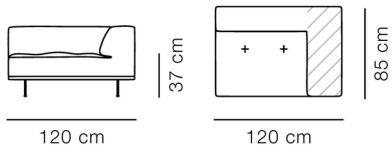

4514 End module 180x85 cm, Arm L or R

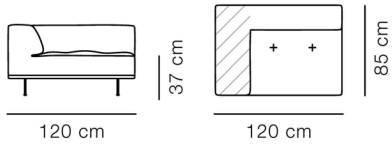
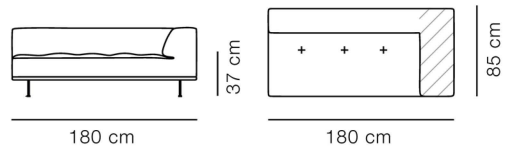
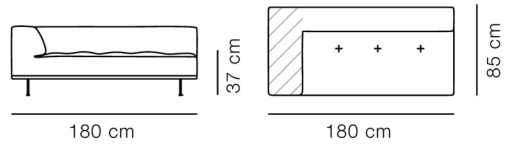

4502 Seat module 120x85 cm

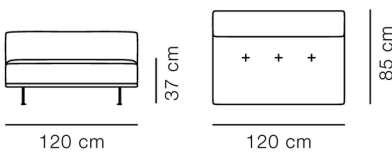

4506 Seat module 85x85 cm

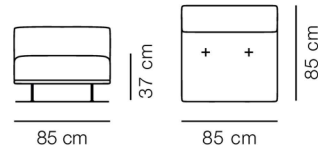

4503 Side chaise module 120x85 cm

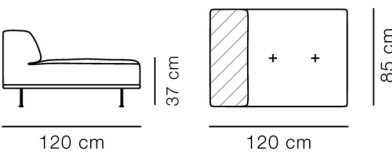

\*Extended arm

4513 Corner module 85x85 cm

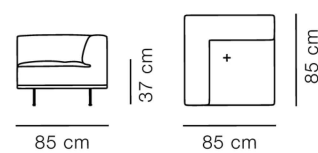

4504 Ottoman 120x85 cm

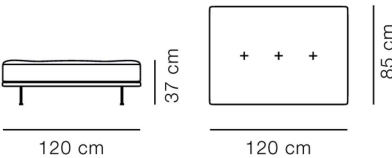

4505 Ottoman 85x85 cm

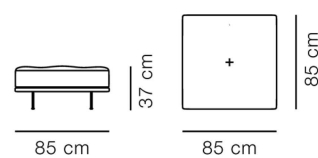

# Delphi Elements – Configuration overview

Model 450A, Configuration A  
 MODEL 4504 / 4501 (left) / 4506 / 4501 (right)

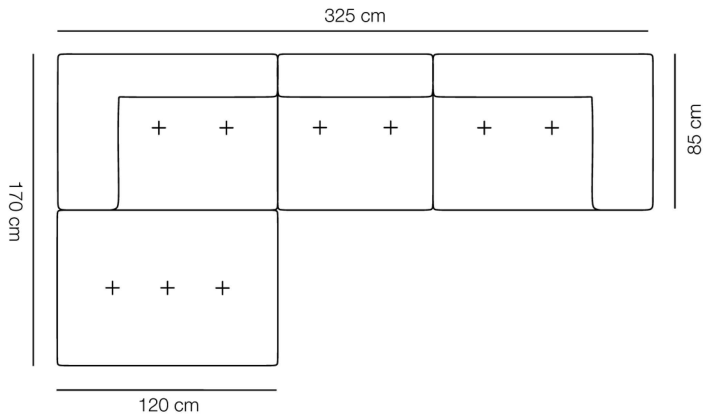

Model 450B, Configuration B  
 MODEL 4501 (left) / 4513 / 4514 (right)

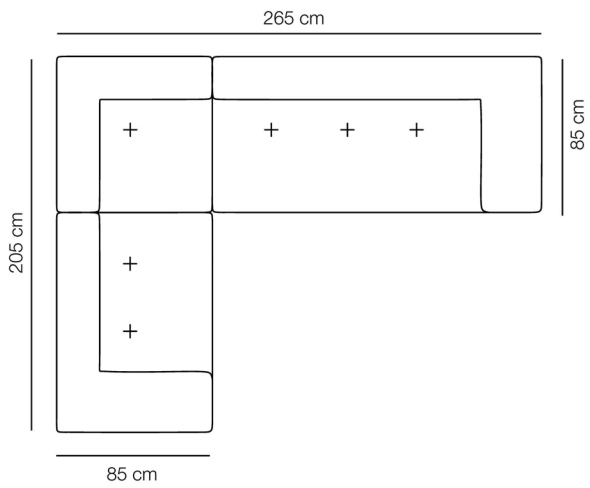

Model 450D, Configuration D  
 MODEL 4514 (left) / 4513 / 4501 (right)

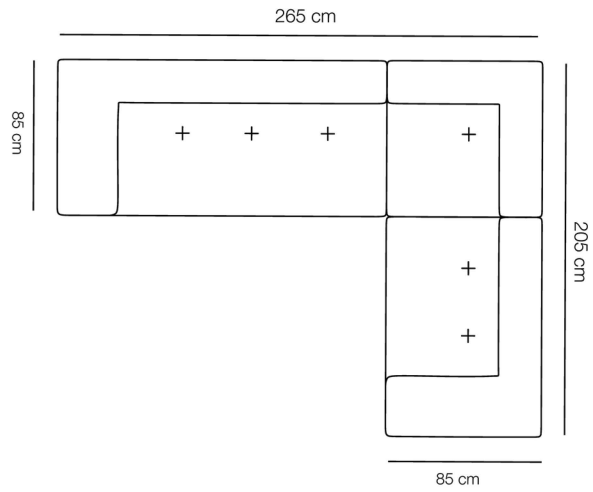

Model 450C, Configuration C  
 MODEL 4503 / 4503 / 4501 (left) / 4502 / 4501 (right)

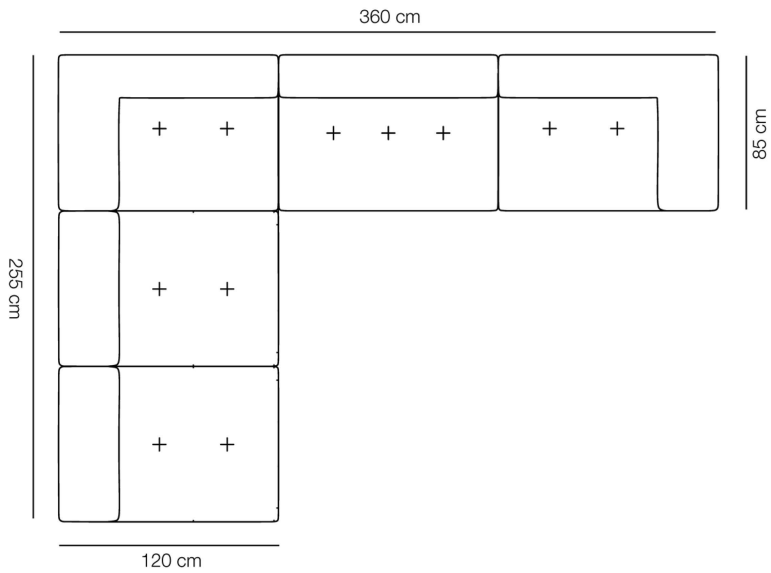

For customer's own configuration, please attach to the order a visual sketch of the desired layout