

BROADCASTERS' MANUAL

Cross - Country

Edition 1 / 01.09.2017

Cross-Country Annex to the FIS Broadcast Manual	3
1. Cross-Country Skiing Competition Formats.....	4
1.1 Techniques.....	4
1.2 Short Distance Sprint Events	5
1.3 Mass Start.....	5
1.4 Mass Start (Technique exchange) Events	6
1.5 Interval Start.....	6
1.6 Relays	6
1.7 Team Sprints.....	6
1.8 Courses and Tracks.....	8
1.9 Starting Order	8
1.10 Entries for Relays.....	8
1.11 Tie-break Rules.....	9
1.12 Lapping.....	9
1.13 Disqualification	9
2. Production Plan and Coverage Philosophy.....	9
2.1 Short Distance Individual Sprint Competitions	9
2.2. Team Sprint	15
2.3. Interval Start.....	19
2.3.1 Pre Timing System	21
2.3.2 Race Spotting Team.....	21
2.4 Mass Start.....	30
2.5 Mass Start (Technique Exchange).....	35
2.6 Relay	41
3.Event Phase.....	44
3.1. Run up to the first TX commitment.....	44
3.2 Camera Production Test and Rehearsal.....	46
3.3 Daily Call Sheets.....	47
4. FIS Cross-Country Skiing 'Tour de Ski Format'	48
4.1 Television Considerations.....	49
5. Graphics Data and Timing.....	51
5.1. FIS Graphics, Data and Timing Partner	51
5.2. TV Graphics Examples	53

Cross-Country Annex to the FIS Broadcast Manual

This Annex details the specific requirements, obligations and arrangements for broadcasting organisations and production companies to create the best possible platform for the planning and final delivery of a first class FIS Cross-Country event for the international television audience.

Should you have any questions about the coverage of Cross-Country events then contact the address below:

FIS International Ski Federation
3653 Oberhofen (Switzerland)
www.fis-ski.com

Pierre Mignerey
Race Director
Tel: +41 79 934 1849
@: mignerey@fisski.com

Sandra Spitz
Event Coordinator
(responsible for TV Production)
Tel: +41 79 305 2959
@: spitz@fisski.com

Michael Lamplot
Media + Kids Event Coordinator
Tel: +420 774 82 8281
@: lamplot@fisski.com

Annemarie Friedrich
Nordic Assistant
Tel: +41 33 244 6161
@: friedrich@fisski.com

Jürg Capol
FIS Marketing Director
Tel: +41 33 244 6124
@: capol@fisski.com

1. Cross-Country Skiing Competition Formats

During the course of a calendar season the most important series of competitions are concentrated during the FIS World Cup calendar with 25 to 30 individual competitions and four to six relays or team sprints. There are some other important competitions including Continental Cups, FIS junior, FIS U23 and National Championships as well as long distance mass participation races including the FIS Marathon Cup.

One of the highlights of the season is the multi stage 'Tour de Ski' which is a series of 7 competitive races that takes place across 9 days in three different host nations. Athletes compete to be the 'Tour de Ski' champion whilst contributing to their overall season performance at the same time.

In senior competitions, ladies compete normally in a short sprint, a team sprint, a short prologue, a distance race over 10km, a 7,5 km + 7,5km Skiathlon, a 30 km mass and interval start format and a 4 x 5km relay.

Men compete normally in a short sprint, a team sprint, a short prologue, a distance race over 15km, a 15 km +15 km Skiathlon, a 50km mass and interval start format and a 4 x 7,5km relay (in World Championships and Olympic Games 4 x 10 km).

The FIS Nordic World Ski Championships are held in odd years with the Winter Olympic Games held every four years. The number of competitions held during the Cross-Country season depends on whether the year falls in a World Championship or Olympic year.

1.1 Techniques

In Cross-Country Skiing, there are two techniques. In the classical technique, the skis are prepared with kick wax which creates friction when in contact with the snow and allows the athlete to ski in "diagonal or classical style" along pre-set parallel tracks. In free technique, the skis are prepared with only glide wax and forward motion is created by using the edges of the skis, also called skating. In both techniques, the competitors use ski poles to aid their forward propulsion.



1.2 Short Distance Sprint Events

A short distance sprint event is considered to be for a distance of not more than 1.8km in length beginning with individual time trials in order to qualify as one of the fastest 30 competitors. Successful athletes will then advance to the elimination heats (competing as groups of six) resulting in a final where the athletes will compete for a competition victory and for valuable World Cup points. In general the initial time trials are not broadcasted on television but are used to conduct a technical and production rehearsal as well as providing pictures for the giant screen.

In Olympic Games and FIS Nordic World Ski Championships sprint competitions, the qualification will be covered live and therefore the starting order will be set in group-starts system for better TV pictures.



1.3 Mass Start

Mass starts apply to most of the Cross-Country race codes where competitors start simultaneously, lined up in an Arrow Start Grid. The first competitor across the finish line wins. Typically the race is competed over a course featuring a stadium component and a 'nature' or open course component and the athletes complete laps in order to cover the required distance.



1.4 Mass Start (Technique exchange) Events

A mass start with athletes using both the classic and freestyle techniques within the same race is called Skiathlon. During a vital exchange within the stadium after half of the race distance has been completed, the athletes change equipment from the classic to the free technique. This format requires two separate courses (one for the classic style and one for the freestyle).

1.5 Interval Start

Interval starts can apply to both sprint and middle/long distance formats. For all FIS standard competitions, competitors start in intervals of 30 seconds depending on the event. The athlete with the fastest individual time wins. Intermediate timing points located at strategic positions around the course are vital to illustrate how each athlete is performing because the fastest and the slowest athletes may be seen together on the same part of the course.

1.6 Relays

A team consists of four athletes, each of who skis one leg of the race and then tags off to a team-mate. The relay is a mass start, although clearly the athlete handovers are an essential part of the coverage plan. This format requires two separate courses one (one for the classic style and one for the freestyle).

1.7 Team Sprints

The team sprint event consists of semi-final and final rounds. In the semi-final heats there are 10 or more teams consisting of two athletes (A and B) who switch three times (A, B, A, B, A, B). The best two teams qualify directly for the final, plus Six lucky losers (fastest times of the non-qualifying teams).

LIST OF EVENTS

The following events feature on the programmes of the FIS World Cup, FIS Nordic World Championships (Cross-Country part) and the Olympic Winter Games. Other distances are held at Continental, FIS, junior, U23 and national levels:

Event	Gender	Technique*	Start
10 km	Ladies	Classic	Interval (mostly 30")
Pursuit 7,5+7,5 km	Ladies	Classic/Free	Mass start
Sprint	Ladies	Free	Interval 15"/Mass start
Team Sprint	Ladies	Classic	Mass start
30 km	Ladies	Free	Mass start
Relay 4x5 km	Ladies	Classic/Free	Mass start
Prologue**	Ladies	Classic	Interval (Mostly 30")
15 km	Men	Classic	Interval (Mostly 30")
Pursuit 15+15 km	Men	Classic/Free	Mass start
Sprint	Men	Free	Interval (Mostly 15")/Mass start
Team Sprint	Men	Classic	Mass start
50 km	Men	Free	Mass start
Relay 4x10 km (4 x 7,5 km in WC)	Men	Classic/Free	Mass start
Prologue**	Men	Classic	Interval (Mostly 30")

* the technique of the single technique events: Ladies sprint, team sprint, 10 km and 30km and Men's' sprint, team sprint, 15 km and 50km alternate at each edition of the FIS World Ski Championships and Olympic Winter Games

** only in Multi Stage events, Technique alternate



1.8 Courses and Tracks

For the different distances, FIS homologation rules require that the courses have a certain amount of uphill sections presenting challenging and demanding races.

The tracks must be a minimum of four to nine metres wide. For the classic technique, the track must be prepared with one classic track (two parallel grooves) in the ideal line (Please make sure that you never destroy the tracks during preparation with the skidoo – Careful Driving requested).

1.9 Starting Order

At OWG, WSC and WC, the Seeded Group is defined as the top 30 competitors in the current World Cup standing (distance or sprint). The current overall WC leader is added as one additional participant if not already included in the original group. No men or ladies within the ranking of top 30 will be substituted if they choose or are not able to enter.

All competitors who are eligible to be in the seeded group must start the competition within the seeded group. Each nation may start in a WSC with a maximum of 4 competitors plus the World Champion of the respective discipline.

For interval start distance competitions, the 30 best athletes (seeded group) according to the current World Cup distance standings registered to compete will start in reverse order as the last group according to the current World Cup distance standings, but, registered athletes with highest FIS points will start between all the seeded athletes. The athlete with the highest FIS points will be set as first of those athletes. The Overall World Cup leader will start as last.

From the first start number to the beginning of the last group (top 30 of the current World Cup distance standings and athletes with highest FIS points), the athletes have assigned starting numbers according to their FIS points, higher FIS points start first.

In mass start events competitors start simultaneously lined up in an Arrow Start Grid according to previous results with the best ones starting in the first positions.

In team sprint events competitors start in the semi-final in an Arrow Start Grid according to the total FIS points of team members. The start position for the final will be according to the results from the semi-finals (rankings followed by times).

Relay start positions for FIS World Cup races are based on the Nations Cup standings; whilst at the FIS World Championships or Olympic Winter Games they are based on the results of the major event that took place the preceding season (FIS World Championships or Olympic Winter Games).

1.10 Entries for Relays

For relays, team captains may initially enter up to four athletes two hours before the team captains' meeting.

1.11 Tie-break Rules

In races with individual start, a tie of two or more athletes with the same time remains as such. In the mass start, sprint and relay races, a photo-finish (showing the tip of the shoe crossing the finish line) decides the ranking between two or more athletes reaching the finish line at the same time.

1.12 Lapping

AN athlete or a team overlapped during mass start races has to leave competition immediately. In all competitions the competitors or teams will be ranked in the final results (not time) according to their ranking at their last intermediate timing point

1.13 Disqualification

AN athlete is disqualified, for example, for using free technique in a classical race or obstructing another athlete.

Complete rules and regulations for Cross-Country Skiing can be found in the Rules and Publications section of fis.com.

2. Production Plan and Coverage Philosophy

2.1 Short Distance Individual Sprint Competitions

Short distance sprint races are reasonably compact and easy to manage as the course length is short (less than 1.8M by definition) and typically will warrant not more than 10 - 14 cameras on and around the course.

Sprint competitions allow the coverage to get up, close and personal with the athletes revealing the speed, determination and battle for position in races that typically last no more than 3 or 4 minutes. As a general rule and for all Cross-Country disciplines cameras should always be positioned to capture the athletes from the front, while lengthy shots of athletes from behind should be avoided. As a general approach, camera positioning is favoured from a low (0.5M from the snow) position to best appreciate the distances between athletes, filling the frame with the action advancing towards the lens and having clear site of the athletes' bib numbers. The low angle also allows the cameras to capture the athletes' faces as their skiing action causes them to lean forwards.

Typically a good camera plan will feature a wide variety of lenses, most of which with a reasonably short focal length, maybe saving a long lens for a Super Slo-Motion camera unit, possibly in the head on position to replay a close up of the athletes in the winning straight. All concerned parties will benefit from the quality of detail included on the camera plan, and broadcasters are encouraged to list the camera number, lens, type of mounting and platform dimensions on each of their plans.



At the beginning of each heat, the athletes are introduced to the spectators and a steadicam is ideally used in this position to best capture the line up, accompanied by name supers for each athlete. A second hand held camera can also be used, particularly to capture the race start in profile. A spotter is used to identify which athlete is competing in which lane because this is decided only just before the race begins. The TV coordination meeting should remind the announcer to follow the order of the television introduction (viewed on the venue jumbo screens).

Budget permitting, sprint races can really exploit the use of a stabilised rail camera, used both for the opening and closing straight. Typically the athletes in each heat will finish in a pack so the cameras will always be able to follow the group as the athletes complete the course.

A fixed camera capturing the athletes as they compete in the first straight is a priority with the remaining camera positions determined by the course design and features. Likely passing points are obvious choices for camera positions, particularly sharp corners and steep hill climbs. Note that it is important to consider the cutting opportunity when positioning the cameras. In some cases the group of athletes may leave the frame before the next camera cut and perhaps a low camera on a straight part of the course will help the cutting sequence.

The final corner and straight tends to offer all the drama and excitement that will eventually determine the final winner and the camera positioning needs to favour this part of the course. The head on position is a vital part of the coverage plan, as well as RF units (one of which may be a steadicam) to shoot the recovery and celebration.

There are two philosophies regarding the capture of the finish. Some prefer to see the end of the race in profile, maintaining the same source for at least the final 5 seconds before the finish line, others prefer to see the finish from the head on position capturing the athletes determination as they cross the finish line. If the race is very close, the profile position is most likely to reveal the final positions, saving the head on position for the replay especially if a photo finish is required. A 'skycam' angle may also be used as a replay with a view directly above the finish line.

FIS's data and timing service provider will provide a photo finish as required to confirm the finish positions across the finish line. This still image is made available to the Host Broadcaster (via the existing fill and matte connectivity) and must be used in the event that the final result is determined by evidence of the photo finish.

Typically the host broadcaster will mount their own camera across the finish line to capture that movement as a replay after the race.

The finish of a heat, semi final or final is often very dramatic as the athletes tends to collapse with exhaustion immediately after crossing the line. A hand held is useful in this situation and close ups of the athletes struggling to catch their breath add to the drama and physical demand of the event.

During the TV Coordination meeting the final decision should be taken if a "Loop of Honour" (like in athletics) after the ladies final with the top three athletes should take place to show the winners to the public and create emotions.

During the heats, a close communication with FIS concerning the jury decisions is important therefore ideally a communication tool should be set up. In addition the FIS event coordinator, who is continuously in contact with the jury, will support the HBC.

Key Points to Consider – Individual Sprint Events

Generally position cameras in a low position, approx.. 0.5M from the snow, save one camera for a course revealing high shot in addition to a standard and fixed beauty shot

Use a good range of lenses between x8 and x55 saving a longer lens for the SSM

Use of at least one steadicam or handheld RF camera for start and finish

Stabilised rail camera for start and finish straight

Fixed camera head on to the opening straight

Using a Ski-doo with an RF camera unit for a selected part of the course

Consider the camera cutting sequence when positioning the cameras

Possibility of using a jimmy jib for course sections and the finish area

A TV photo finish camera is essential across the finish line as well as a regular TV camera for replays

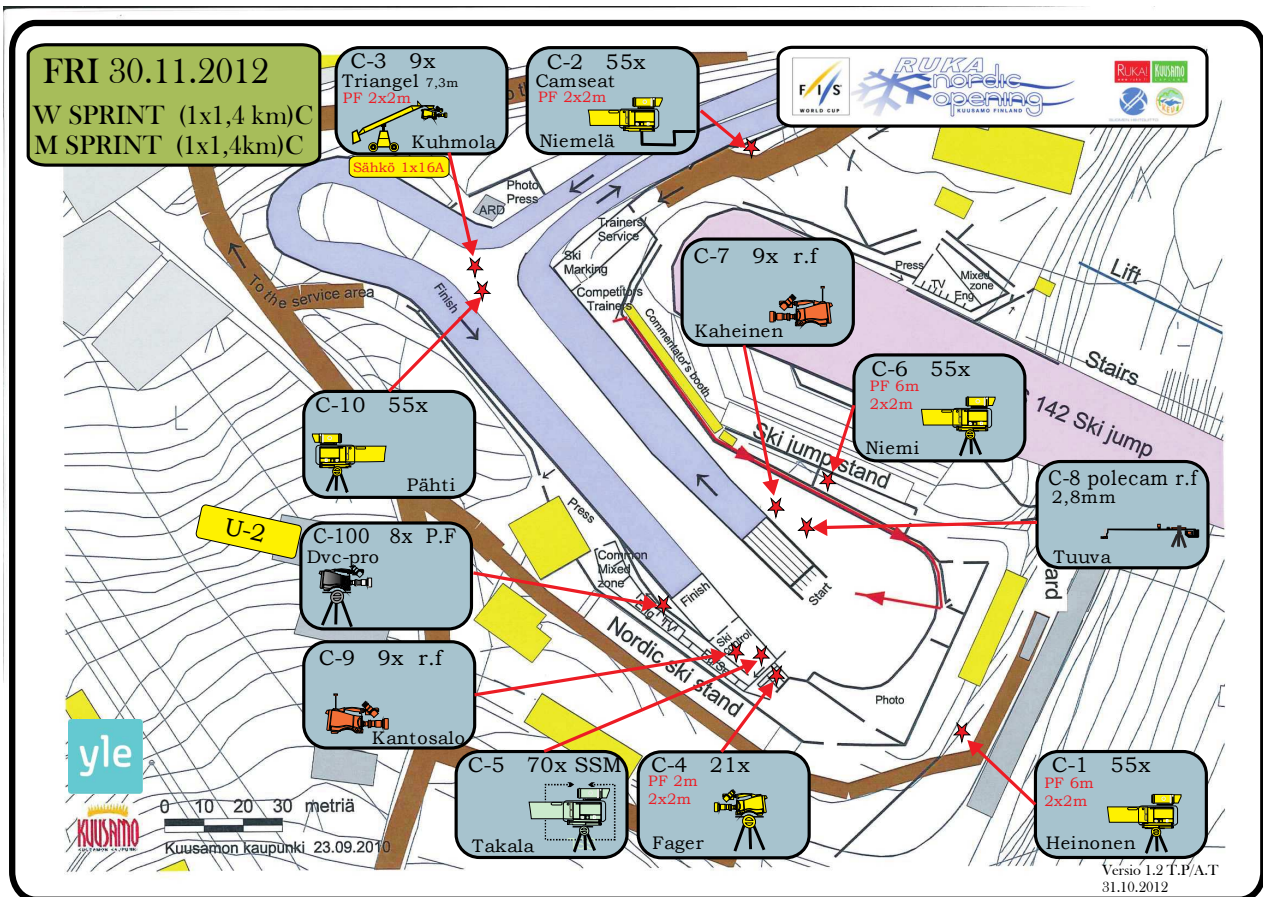

Individual Sprint camera plan example - Stadium

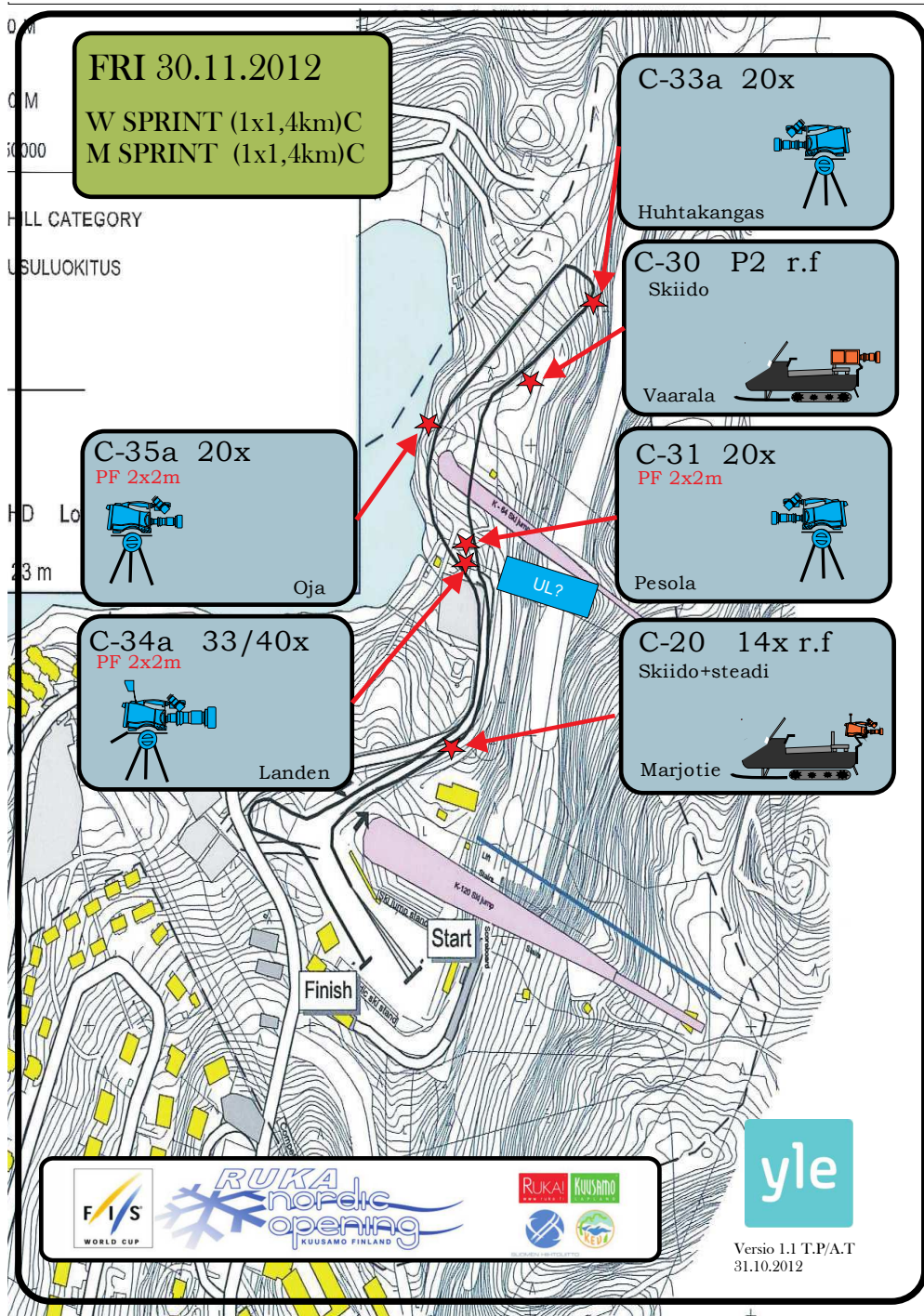

Individual Sprint camera plan example - Course

Multilateral Running Order – Example Sprint

VEISSMAN FIS CROSS-COUNTRY WORLD CUP
BROADCASTER MANUAL



MULTILATERAL RUNNING ORDER - SPRINT EXAMPLE

	IN (GMT)	IN (local time, GMT+1)	OUT	DURATION (h:mm:ss)	ON SCREEN	GRAPHICS	
	10:50:00	11:50:00			Start of the International Feed		
OPENING	10:50:00	11:50:00	12:00:00	00:10:00	OPENING SEQUENCE		
		11:50:00	11:50:20	00:00:20	FIS & INFRONT Animation (tape)		
		11:50:20	11:50:30	00:00:10	Beauty Shot	TITLE EVENT	
		11:50:30	11:51:00	00:00:30	Wide Shots: Atmosphere at the Venue		
		11:51:00	11:52:00	00:01:00	Venue Presentation (tape)		
		11:52:00	11:52:20	00:00:20	Wide Shots: Atmosphere at the Venue		
		11:52:20	11:53:20	00:01:00	INTERVIEW with the leaders W+M (tape)	Athletes ID	
		11:53:20	11:55:00	00:01:40	Back Stage: Athletes Warm Up		
		11:55:00	11:55:10	00:00:10	Beauty Shot	TITLE EVENT	
		11:55:10	11:56:30	00:01:20	Back stage: Favourites	Athletes ID	
		11:56:30	11:56:40	00:00:10	Wide Shot	WEATHER CONDITIONS	
		11:56:40	11:57:00	00:00:20	Wide Shot	COURSE PROFILE W+M	
		11:57:00	11:58:00	00:01:00	Wide Shot	QUALIFICATION RESULTS W+M	
		11:58:00	11:59:00	00:01:00	Wide shot: atmosphere at the venue		
	11:59:00	12:00:00	00:01:00	Close-ups & Warm-ups: Presentation of Athletes at the Start	Athletes ID		
RACE	11:00:00	12:00:00	13:33:30	01:33:30	RACE SEQUENCE		
		12:00:00	12:05:00	00:05:00	Ladies QUATERFINALS Focus on the favourites	Athletes ID / STARTING LIST	
		12:05:00	12:10:00	00:05:00	1 heat	Athletes ID / Results	
		12:10:00	12:15:00	00:05:00	2 heat	Athletes ID / Results	
		12:15:00	12:20:00	00:05:00	3 heat	Athletes ID / Results	
		12:20:00	12:25:00	00:05:00	4 heat	Athletes ID / Results	
		12:25:00	12:25:00	00:05:00	5 heat	Athletes ID / Results	
					Beauty Shot	LUCKY LOSERS	
		12:25:00	12:30:00	00:05:00	Men QUATERFINALS Focus on the favourites	Athletes ID / STARTING LIST	
		12:30:00	12:35:00	00:05:00	1 heat	Athletes ID / Results	
		12:35:00	12:40:00	00:05:00	2 heat	Athletes ID / Results	
		12:40:00	12:45:00	00:05:00	3 heat	Athletes ID / Results	
		12:45:00	12:50:00	00:05:00	4 heat	Athletes ID / Results	
		12:50:00	12:55:00	00:05:00	5 heat	Athletes ID / Results	
		12:55:00	13:01:00	00:05:30	Beauty Shot	LUCKY LOSERS	
		13:01:00	13:06:30	00:05:30	Ladies SEMIFINALS Focus on the favourites	Athletes ID / STARTING LIST	
		13:06:30	13:12:00	00:05:30	1 heat	Athletes ID / Results	
					2 heat	Athletes ID / Results	
					Beauty Shot	LUCKY LOSERS	
		13:12:00	13:13:00	00:01:00	Ladies FINAL Last Preparation in the Waiting Zone	STARTING LIST	
		13:13:00	13:13:30	00:00:30	Take of the Clothes	Athletes ID	
		13:13:30	13:14:00	00:00:30	Walking into the Start Gates	Athletes ID	
		13:14:00	13:15:15	00:01:15	Presentation of Athletes at the Start Gates	Athletes ID / STARTING LIST	
		13:15:15	13:17:45	00:02:30	FINAL	Athletes ID / Results	
		13:17:45	13:18:45	00:01:00	Emotions: Winner Celebration / Losers Reactions	Athletes ID	
		13:18:45	13:19:45	00:01:00	SLO-MO : Decisive moments of the Race	Athletes ID	
		13:19:45	13:20:45	00:01:00	Emotions: Athletes Reaction and Atmosphere	Athletes ID	
		13:20:45	13:21:15	00:00:30	SLO-MO : Moments of the Race / Winner Celebration	Athletes ID	
		13:21:15	13:21:45	00:00:30	Wide Shot	FINAL RESULTS LIST	
		13:21:45	13:22:45	00:01:00	FLASH INTERVIEW with the winner - Ladies	Athlete ID	
		13:22:45	13:23:45	00:01:00	Men FINAL Last Preparation in the Waiting Zone	STARTING LIST	
		13:23:45	13:24:15	00:00:30	Take of the Clothes	Athletes ID	
		13:24:15	13:24:45	00:00:30	Walking into the Start Gates	Athletes ID	
		13:24:45	13:26:00	00:01:15	Presentation of Athletes at the Start Gates	Athletes ID / STARTING LIST	
		13:26:00	13:28:30	00:02:30	FINAL	Athletes ID / Results	
		13:28:30	13:29:30	00:01:00	Emotions: Winner Celebration / Losers Reactions	Athletes ID	
		13:29:30	13:30:30	00:01:00	SLO-MO : Decisive moments of the Race	Athletes ID	
		13:30:30	13:31:30	00:01:00	Emotions: Athletes Reaction and Atmosphere	Athletes ID	
		13:31:30	13:32:00	00:00:30	SLO-MO : Moments of the Race / Winner Celebration	Athletes ID	
		13:32:00	13:32:30	00:00:30	Wide Shot	FINAL RESULTS LIST	
		13:32:30	13:33:30	00:01:00	FLASH INTERVIEW with the winner - Men	Athlete ID	
	CLOSING	12:33:30	13:33:30	13:43:30	00:10:00	CLOSING SEQUENCE	
			13:33:30	13:34:00	00:00:30	Wide Shot	SPRINT CUP STANDING MEN
			13:34:00	13:34:30	00:00:30	HIGHLIGHTS : Best 3 Men	Athletes ID
		13:34:30	13:35:00	00:00:30	Wide Shot	WORLD CUP OVERALL STANDING MEN	
		13:35:00	13:37:45	00:02:45	PODIUM CEREMONY: top 3 (3rd - 1st) - Men	Athletes ID	
		13:37:45	13:38:15	00:00:30	Wide Shot	SPRINT CUP STANDING LADIES	
		13:38:15	13:38:45	00:00:30	HIGHLIGHTS : Best 3 Ladies	Athletes ID	
		13:38:45	13:39:15	00:00:30	Wide Shot	WORLD CUP OVERALL STANDING LADIES	
		13:39:15	13:42:00	00:02:45	PODIUM CEREMONY: top 3 (3rd - 1st) - Ladies	Athletes ID	
		13:42:00	13:43:00	00:01:00	FINAL CLIP : - Best Athletes (with music) - Coaches Reactions - Fans Celebrating		
	13:43:00	13:43:10	00:00:10	Wide Shot	Director / TV production		
	13:43:10	13:43:30	00:00:20	FIS & INFRONT Animation (tape)			
	12:43:30	13:43:30			Estimated International Feed closing time		

Local Time: GMT + 01:00:00

2.2. Team Sprint

In the team sprint format, teams consist of two athletes who alternate skiing the sprint course, three times each, for a total of six laps. The team sprint is always performed in one technique, (either in classic or free technique).

After an initial semi-final round, consisting of 10-15 teams in each heat, the best two teams from two semi-finals qualify directly for the final round and the 6 fastest teams will join them in the final. Athletes must perform a correct exchange between laps by physically touching their team-mate without interfering or obstructing other teams. The winning team is the first team to cross the finish line after the completion of all six laps.

From a coverage plan point of view it is important to capture the exchanges and quality of the tag process as well as showing each team mate in anticipation of the handover and encouraging the team-mate as he or she leaves the exchange zone for their lap. The inclusion of ski waxing as part of the coverage plan may also be considered, as the waxing process may vary depending on the conditions.

Key Points to Consider – Team Sprint Events
Use of at least one steadicam or handheld RF camera for start, finish and exchanges (particularly for the athlete's preparation while waiting for the exchange)
Generally position cameras in a low position, approx.. 0.5M from the snow
Use a good range of lenses between x8 and x55 saving a longer lens for the SSM
Stabilised rail camera for start and finish straight
Fixed camera head on to the opening straight
Using a Ski-doo with an RF camera unit for a selected part of the course
Consider the camera cutting sequence when positioning the cameras
Possibility of using a jimmy jib for course sections and the finish area
A TV photo finish camera is essential across the finish line



TEAM SPRINT CAMERA PLANS – STADIUM

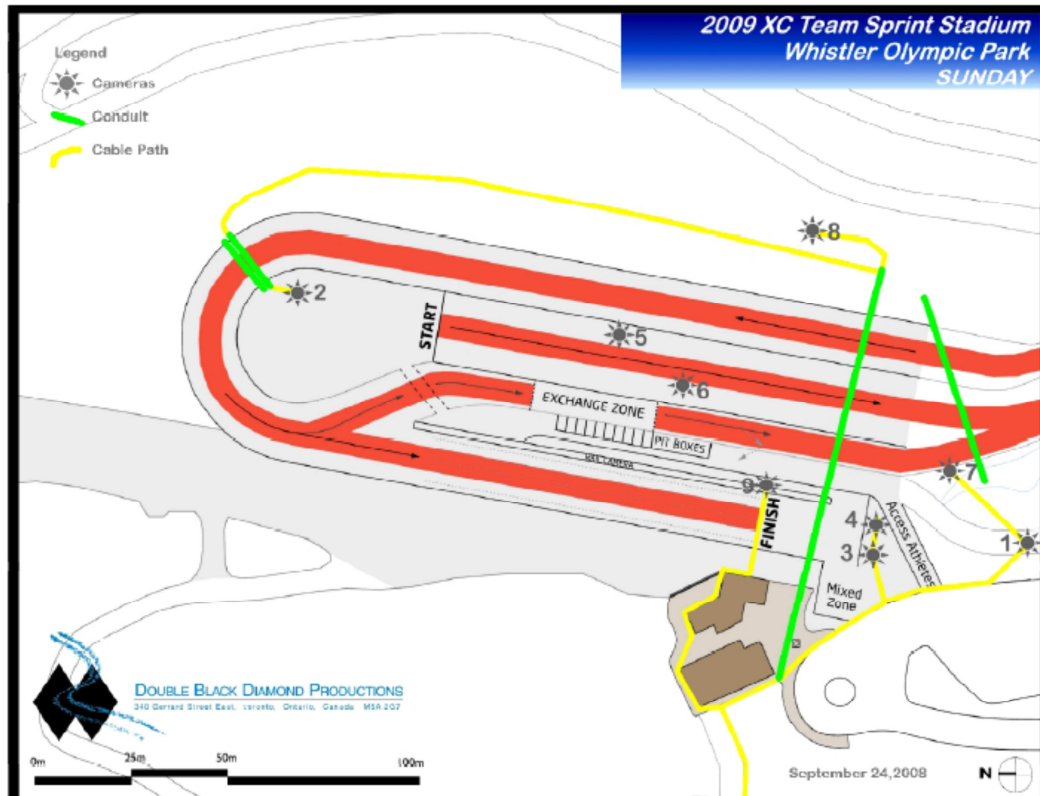

TEAM SPRINT CAMERA PLANS – COURSE

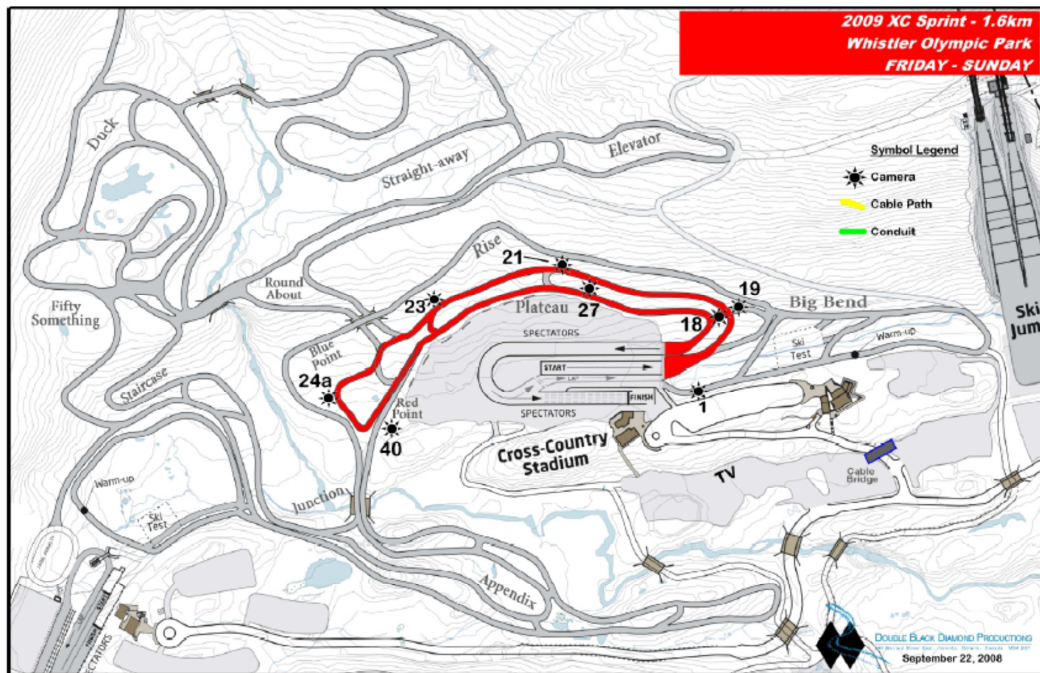

TEAM SPRINT CAMERA NARRATIVE EXAMPLE (VANCOUVER)

Race: Team Sprint – Sunday, January 18

Map: Stadium

Cam	Map Ref	Type	Lens	Platform	Comments
	1	Hard	70x	Crane	Height 15 - 35M
2	2	Hard	70x	Snow Platform	Lens 0.5M above track; tight lapping
3	3	HH	20x	2M Tower	Finish wide
4	4	Hard	86x	Snow Trench	Finish tight; lens 0.5M above snow Man repo from 41B
5	5	HH-RF Steady	WA	On foot on snow	Start, Exchanges, Finish
6	6	HH-RF	20x	On foot on snow	Start, Lapping, Finish
7	7	Hard	86x	Sled on snow	Exchanges, Lapping
8	8	Hard	70x	3M Tower	Start, Lapping & Finish High Side Shot
9	9	ICONIX	tbc	Post	Photo Finish

Race: Team Sprint – Sunday, January 18

Map: 1.6 km Red Course (Men), 1.3 KM Red Course (Women)

Cam	Map Ref	Type	Lens	Platform	Comments
1	19	HH	20x	2X2 on snow	Same as pursuit C-18B
2	21	Hard	70x	2x2 on snow	
3	23	Hard	70x	2x2 on snow platform	1M higher than track
4	24A*	HH	20x	2x2 on snow platform	Follow around corner to SB P/UF
5	40	SB – WESCAM WA	W/A	N/A	
6	27	HARD	70x	2x2 on snow	
7	18	HH	21x	2x2 on snow	Same as pursuit C-18A

TOTALS:

15 Cameramen / 16 cameras = 8 Hard, 6 HH (2 RF O-OPS), 1 snowmobile, 1 Photo Finish

* Men's Race only

MULTILATERAL RUNNING ORDER – EXAMPLE TEAM SPRINT

VISSMAN FIS CROSS-COUNTRY WORLD CUP
BROADCASTER MANUAL



MULTILATERAL RUNNING ORDER - TEAM SPRINT EXAMPLE

	IN (GMT)	IN (local time: GMT+1)	OUT	DURATION (h:mm:ss)	ON SCREEN	GRAPHICS	
	10:50:00	11:50:00			Start of the International Feed		
OPENING	10:50:00	11:50:00	12:00:00	00:10:00	OPENING SEQUENCE		
		11:50:00	11:50:20	00:00:20	FIS & INFRONT Animation (tape)		
		11:50:20	11:50:30	00:00:10	Beauty Shot	TITLE EVENT	
		11:50:30	11:50:50	00:00:20	Wide Shots: Atmosphere at the Venue		
		11:50:50	11:51:50	00:01:00	Venue Presentation (tape)		
		11:51:50	11:52:30	00:00:40	Wide Shots: Atmosphere at the Venue		
		11:52:30	11:53:30	00:01:00	INTERVIEW with the leaders W+M (tape)	Athletes ID	
		11:53:30	11:55:00	00:01:30	Back Stage: Athletes Warm Up		
		11:55:00	11:55:10	00:00:10	Beauty Shot	TITLE EVENT	
		11:55:10	11:55:50	00:00:40	HIGHLIGHTS: Best moments from Semifinals (Ladies/Men)	SEMIFINALS RESULTS W+M	
		11:55:50	11:56:00	00:00:10	Wide Shot	WEATHER CONDITIONS	
		11:56:00	11:56:20	00:00:20	Wide Shot	COURSE PROFILE W+M	
					Ladies Pre-Final	STARTING LIST	
		11:56:20	11:57:20	00:01:00	Last Preparation in the Waiting Zone	Athletes ID	
		11:57:20	11:57:50	00:00:30	Take of the clothes	Athletes ID	
		11:57:50	11:58:20	00:00:30	Walking into the Start Gates	Athletes ID	
		11:58:20	12:00:00	00:01:40	Close-ups & Warm-ups: Presentation of Athletes at the Start	Athletes ID / STARTING LIST	
	RACE	11:00:00	12:00:00	12:50:00	00:50:00	RACE SEQUENCE	
			12:00:00	12:15:00	00:15:00	LADIES FINAL	Athletes ID / Results
		12:15:00	12:16:20	00:01:20	Emotions: Winners Celebration / Losers Reactions	Athletes ID	
		12:16:20	12:16:50	00:00:30	SLO-MO: Decisive moments of the Race	Athletes ID	
		12:16:50	12:17:50	00:01:00	Emotions: Athletes Reaction and Atmosphere	Athletes ID	
		12:17:50	12:18:20	00:00:30	SLO-MO: Athletes Celebration	Athletes ID	
		12:18:20	12:18:50	00:00:30	Wide Shot	FINAL RESULTS LIST	
		12:18:50	12:19:40	00:00:50	FLASH INTERVIEW with the Winners - Ladies	Athlete ID	
					Men Pre-Final	STARTING LIST	
		12:19:40	12:20:40	00:01:00	Last Preparation in the Waiting Zone	Athletes ID	
		12:20:40	12:21:10	00:00:30	Take of the clothes	Athletes ID	
		12:21:10	12:21:40	00:00:30	Walking into the Start Gates	Athletes ID	
		12:21:40	12:23:00	00:01:20	Presentation of Athletes at the Start Gates	Athletes ID / STARTING LIST	
		12:23:00	12:45:00	00:22:00	MEN FINAL	Athletes ID / Results	
		12:45:00	12:46:30	00:01:30	Emotions: Winners Celebration / Losers Reactions	Athletes ID	
		12:46:30	12:47:00	00:00:30	SLO-MO: Decisive moments of the Race	Athletes ID	
		12:47:00	12:48:00	00:01:00	Emotions: Athletes Reaction and Atmosphere	Athletes ID	
		12:48:00	12:48:30	00:00:30	SLO-MO: Athletes Celebration	Athletes ID	
		12:48:30	12:49:00	00:00:30	Wide Shot	FINAL RESULTS LIST	
		12:49:00	12:50:00	00:01:00	FLASH INTERVIEW with the Winners - Men	Athlete ID	
CLOSING	11:50:00	12:50:00	13:00:00	00:10:00	CLOSING SEQUENCE		
		12:50:00	12:51:00	00:01:00	Wide Shot	NATIONS STANDING MEN	
		12:51:00	12:51:45	00:00:45	HIGHLIGHTS: Best 3 Teams (Men)	Athletes ID	
		12:51:45	12:54:25	00:02:40	PODIUM CEREMONY: top 3 (3rd - 1st) Nations - Men	Athletes ID	
		12:54:25	12:55:25	00:01:00	Wide Shot	NATIONS STANDING LADIES	
		12:55:25	12:56:10	00:00:45	HIGHLIGHTS: Best 3 Teams (Ladies)	Athletes ID	
		12:56:10	12:58:50	00:02:40	PODIUM CEREMONY: top 3 (3rd - 1st) Nations - Ladies	Athletes ID	
		12:58:50	12:59:30	00:00:40	FINAL CLIP: - Best Athletes (with music) - Coaches Reactions - Fans Celebrating		
		12:59:30	12:59:40	00:00:10	Wide Shot	Director / TV production	
		12:59:40	13:00:00	00:00:20	FIS & INFRONT Animation (tape)		
	12:00:00	13:00:00		Estimated International Feed closing time			

Local Time: GMT + 01:00:00

2.3. Interval Start

Interval start races present the most challenging of the Cross-Country race codes because it is essential to be able to illustrate exactly what is happening during the course of the race. The production approach and philosophy is very different to the mass start format, particularly as it may take up to one hour for all the athletes to start their race with up to 120 athletes starting at usually 30 second intervals.

The best athletes are arranged into the 'Seeded Group' (the top 30 athletes) and therefore the most likely winning times are going to be seen from the athletes departing in the last 30 minutes of the race.

Television coverage for interval start formats require an experienced producer, director and spotting team as well as a sophisticated communications system and carefully prepared race timing system.

Once again, the philosophy of camera positioning is to maintain a low angle approach with the athletes, generally maintaining wide and group revealing shots while showing the natural beauty and environment of the race course and surroundings. Some close up cameras may be used particularly as one of a group of three cameras positioned around the timing points.

The positioning of the pre and intermediate timing points is very important and the lap length should not be less than 5km. Typically two timing points apply to 10km races with three timing points for 15km races.

The overall philosophy of the coverage is to avoid plotting the entire course with camera positions but use the intermediate timing intervals as strategic story telling junctions allowing many of the athletes to pass through before advancing to coverage from the next timing interval.

The opening phase of the race broadcast will only feature the first group of athletes starting the course because they will need time to reach the first intermediate timing point before that action can be featured. Typically a sequence of cameras are strategically positioned to show each start, a hand held camera low down to capture the preparation and release of the athlete from the start position, followed by two other cameras, the first to show the athlete just after leaving the start position as a loose head to toe shot and the second to show the athlete making progress on the course. This camera may pan with the athlete before cutting back to the start position for the next athlete.

In addition, the HBC should add in the first ten minutes more shots from the warming up of the favourites as well as the preparation in the waxing area.

Typically for a 15km race, intermediate timing points may be positioned at 2km, 7km, 12km, a total of three intermediate timing points (not more points should be used, in some cases 2 intermediate points would be enough). Given that the last intermediate timing point is close to the finish line, continuous coverage should be available from this point onwards as this will clearly determine who will be amongst the top three athletes.

Important is that the timing points are not looking close the same from landscape. There must be a significant Different as the covering with the banners/Sponsors are the same from the Marketing AgenCy.

Three cameras tend to be used to cover each of the strategic timing points, although the pre timing system should allow the cameras to tell the story before an athlete actually passes through a timing point. Each timing point ideally should accommodate three cameras, the first positioned 100 – 200M in advance of the timing line, with a short lens and is the first 'cut to' option when introducing this particular timing location.

The second camera will be positioned after the timing line and can alternatively be used as the first camera to cut to when introducing this timing location. Again, using a short lens this camera will reveal the approach and the pass through the timing line.

The third camera, fitted with a longer lens can offer a particular athlete approaching and passing through the timing interval in close up and may also be offered as a replay source. This camera obviously reveals the effort, determination and breathing technique of the athlete as they pass through the timing interval.

The director should offer consistency with the cutting pattern when establishing a timing location, selecting either the first or second camera option to commence the sequence. The skill when covering interval starts races is largely the mechanism by which the transition from one timing point to another is presented. In practice this can be summarised as follows:

- Identify location, i.e. which timing point
- Identify who is approaching (may need to see the athlete bibs)
- Identify where they are in relation to the timing line
- Reveal their performance through the timing interval

A development for interval start formats is the introduction of the race leader chair or 'throne' and a signing wall (Plexiglas) just before the start where the athlete sign in for the competition (like in cycling). The FIS PR and Media Coordinator will request the current race leader to maintain a proud position on the leader chair for the benefit of the spectators and TV audience. This element must be included in the coverage plan and is typically covered by a hand held camera.

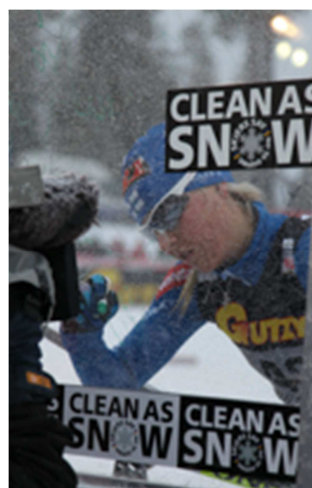

2.3.1 Pre Timing System

For interval start formats over a distance a pre timing system exclusively for the host broadcaster will be prepared by the appointed timing and data service provider, including the necessary cabling around the course. Typically 300-400M before each official intermediate timing interval will be an additional timing point available to the producer and head spotter (and the commentary information system).

The pre timing system allows the producer to anticipate the speed and form of the athletes as they approach the timing interval and can aid the story telling process as distances are reduced or increased between the competitors. The system should be carefully tested before an event.

As an example, an athlete is observed passing through the pre timing interval with the current fastest time and is identified as competitor '27'.

The head spotter alerts a field spotter close to that timing position to announce when Athlete 27 is approaching sight of the first camera position (100 – 200M before the timing interval). When the field spotter catches sight of the athlete, the cameraman is alerted and a count can be offered before the athlete is revealed in the camera's view.

2.3.2 Race Spotting Team

Also used in Mass Start, the race spotting team is essential for communicating athlete positioning, form and progress on the course and provides the producer with vital information that will allow him to cut the camera sequence according to a story telling theme. Following instructions from the Head Spotter a Field Spotter is used to reveal when an athlete arrives in a certain position in relation to the timing interval, and can communicate that information back to the truck and the associated cameramen.

As a minimum, a head spotter and five spotters are required, three working along the course and two in the stadium. Obviously a good spotter is familiar with the names and appearance of the athletes as well as thorough understanding of the sport. The spotter must be clear, brief and concise when communicating with the head spotter and selected cameramen close to his or her particular position.

The spotters will identify athletes who have been highlighted by the producer because of their current progress (according to pre timing information) and offer 'appearance' times given in seconds before reaching a camera's view. Spotters are provided with a cabled communication system in the same way a floor manager would be equipped with a very specific 'group' set up allowing the spotter to communicate with the Head Spotter and selected cameramen only.

An audio engineer is typically hired to configure the communications system alone, with the cameramen communications arranged specifically to hear the director, vision engineering and a spotters group.

The head spotter stays in the OB van and relies on the timing information (particularly from the pre timing system) and can relay information about athletes' progress to the field spotters. The field spotter in turn will report back information when a particular athlete will be seen in shot by a particular camera.

The producer/director tends to communicate with the head spotter only who in turn communicates with the spotter team. Typically before a race and once the start list has been released the Head Spotter will identify with the Producer a list of between 12 and 15 athletes who are likely to be challenging for a podium position.

For interval start races, two spotters are associated to each timing point one before the first camera and the second at the first camera of the timing point.

The spotters are typically provided by the Organising Committee or NSA although this is a reasonably specialised function and a producer may choose to recommend his/her own for a major competition.



Sapporo 2007

Spotter plan

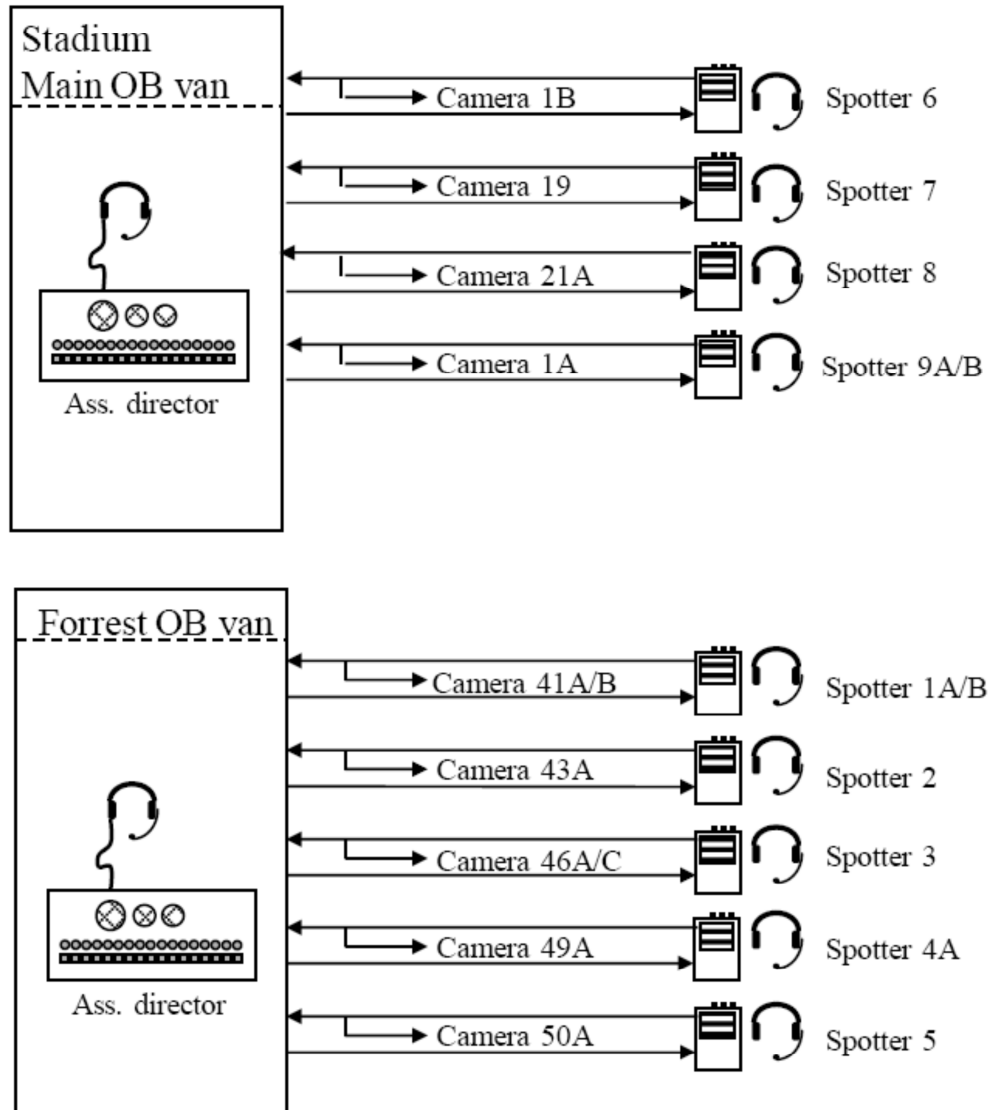

EVENTS		SPOTTER POSITIONS											
		1A	1B	2	3	4A	4B	5	6	7	8	9A	9B
Pursuit Men	02-24	x		x	x	x		x	x		x		x
Pursuit Women	02-25	x		x				x	x	x			x
NC team	02-25									x			x
10km interval W	02-27		x		x		x		x				
15km interval M	02-28		x							x		x	
Relay Women	03-01	x		x				x	x	x			x
Relay Men	03-02	x		x	x	x		x	x		x		x
30km Mass W	03-03	x		x	x	x		x	x		x		x
NC Ind. Gundersen	03-03									x	x		x
50km Mass M	03-04	x		x	x	x		x	x		x		x

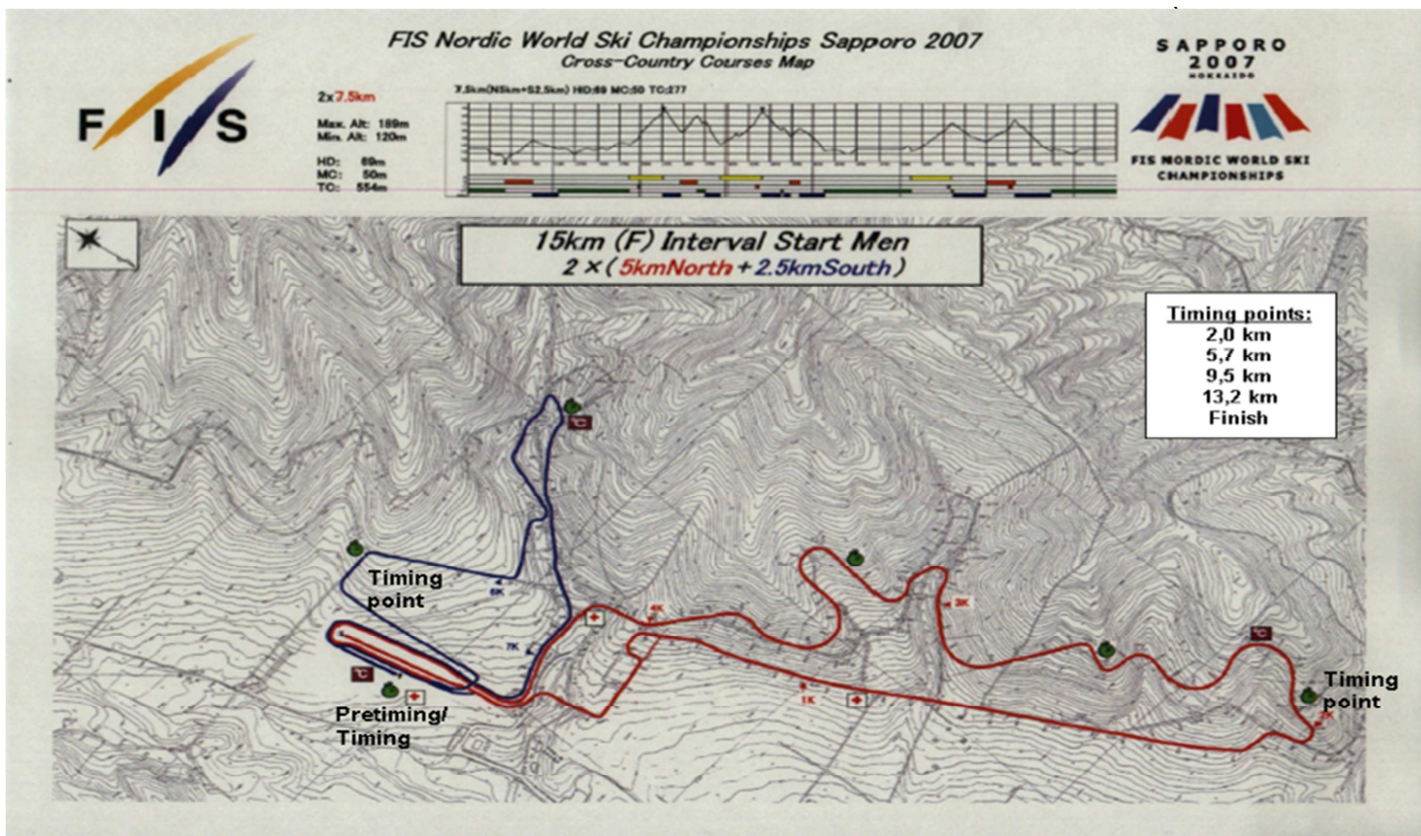

INTERVAL START EVENTS – KEY POINTS TO CONSIDER

Key Points to Consider – Interval Start Events
Very carefully considered camera plan to be prepared during the course design or selection with special attention to the cameras positioned around the intermediate timing points. The positioning of the signing Wall and Leader Chair needs to be agreed at the Site Inspection
Positioning three cameras strategically around each timing interval offering consistency with the cutting pattern
For interval start formats, working with an experienced producer/editor and head spotter and field spotting team to apply fine timing decisions and athlete positioning information on strategic parts of the course
Wide and revealing shots of the athletes generally captured from low angle positions, with a longer lens for the athlete CU through the timing intervals and finish area
The ability to capture the atmosphere and enthusiasm of the spectators, including using a RF unit in and among the crowd
Although the entire course should not be covered by cameras, the final timing interval to the finish line should be available as continuous coverage (typically in the stadium section of the course)
Rail camera for straights in the stadium portion of the course
Use of handheld RF camera for the start, finish and recovery
Using ski-dogs with an RF camera unit for selected parts of the course
Jimmy Jib for course sections and the finish area

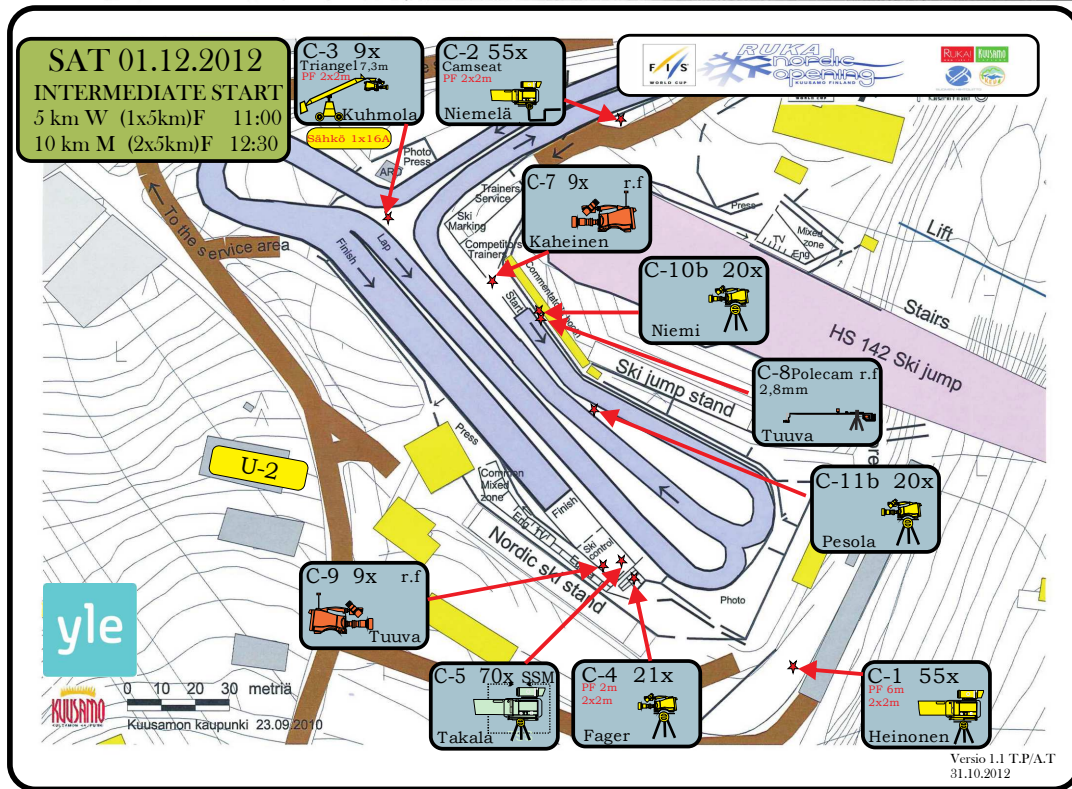

Example camera plan, Interval Start events - Stadium

SAT 01.12.2012

INTERMEDIATE START

5 km W (1x5km)F 11:00
10 km M (2x5km)F 12:30

C-34c 33/40x
PF 2x2m
Landen

C-33c 20x
PF 1,5m
2x2m
Huhtakangas

C-32c 20x
PF 2x2m
Kantosalo

A
N.45 min aikaa siirtä NC..
4 KM 5 KM

FIS WORLD CUP
RUKA nordic opening KUUSAMO FINLAND
RUKA KUUSAMO
SUOMEN LUJAVUUS

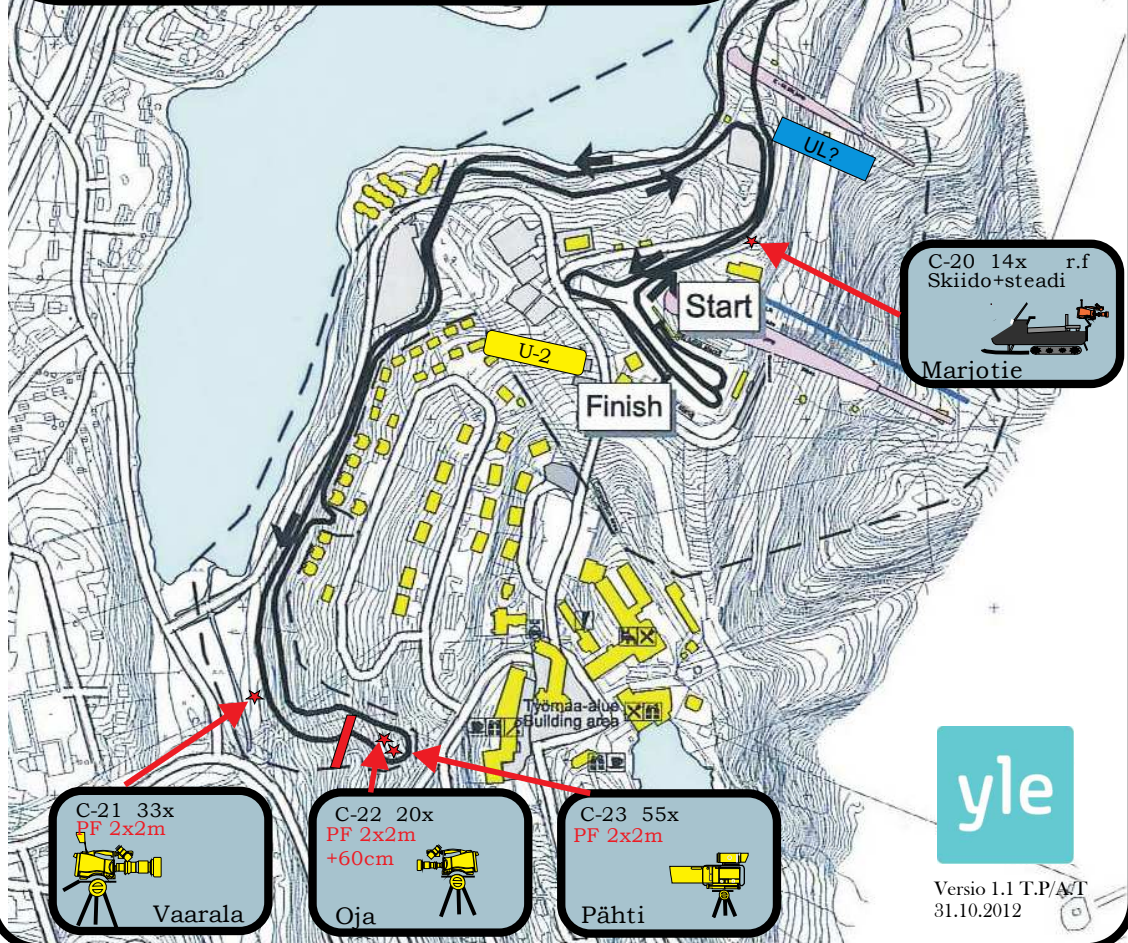

C-20 14x r.f
Skiido+stedi
Marjotie

C-21 33x
PF 2x2m
Vaarala

C-22 20x
PF 2x2m
+60cm
Oja

C-23 55x
PF 2x2m
Pähti



Versio 1.1 T.P./A/T
31.10.2012

SAT 01.12.2012

INTERMEDIATE START

5 km W (1x5km)F 11:00
10 km M (2x5km)F 12:30

C-34c 33/40x
PF 2x2m
Landen

C-33c 20x
PF 1,5m
2x2m
Huhtakangas

C-32c 20x
PF 2x2m
Kantosalo

A
N.45 min aikaa siirtyä NC..
4 KM 5 KM

FIS WORLD CUP
RUKA nordic opening KUUSAMO FINLAND
RUKA KUUSAMO
SUOMEN HIIPOJAT

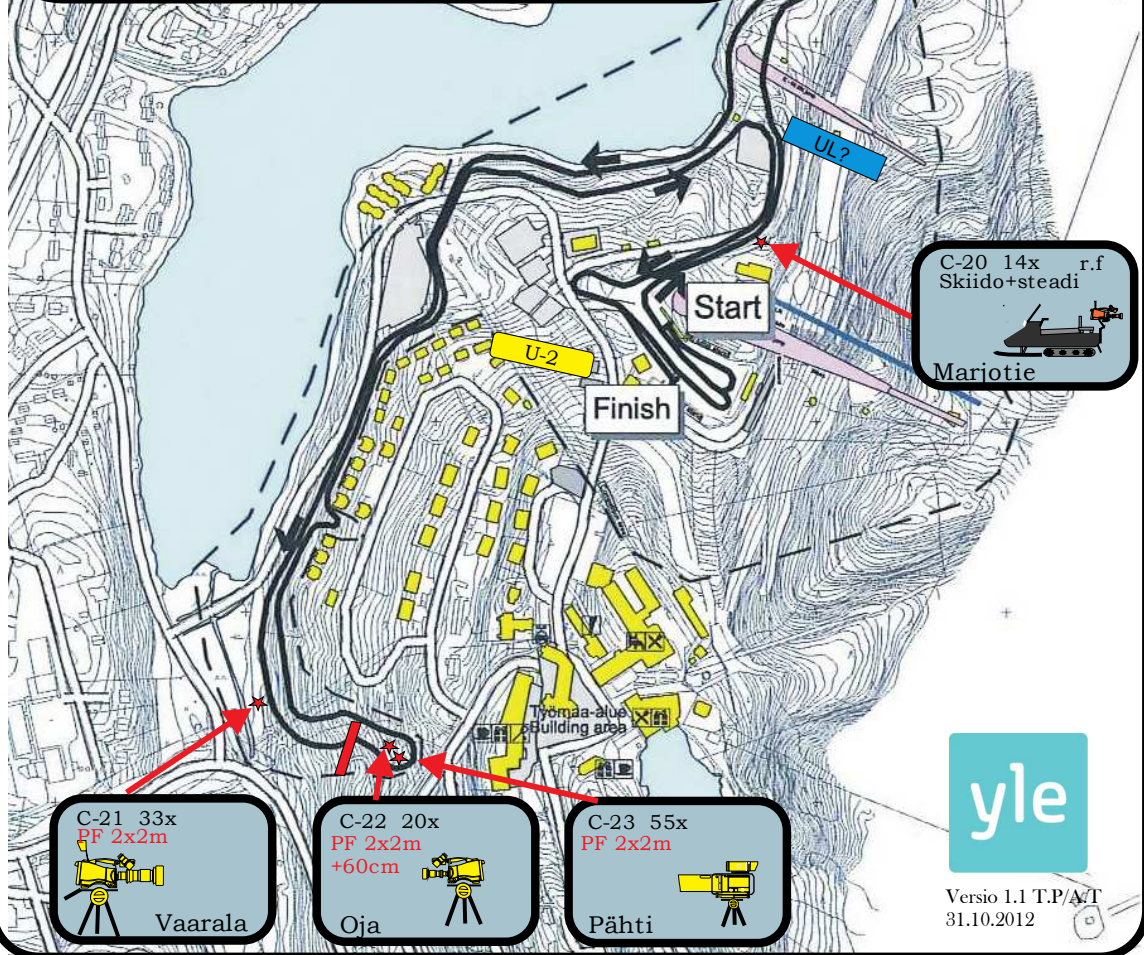

C-20 14x r.f
Skiido+stead
Marjotie

C-21 33x
PF 2x2m
Vaarala

C-22 20x
PF 2x2m
+60cm
Oja

C-23 55x
PF 2x2m
Pähti



Versio 1.1 T.P./A.T
31.10.2012

MULTILATERAL RUNNING ORDER – INTERVAL START EXAMPLE

VISSMAN FIS CROSS-COUNTRY WORLD CUP
BROADCASTER MANUAL



MULTILATERAL RUNNING ORDER - INTERVAL START EXAMPLE

	IN (GMT)	IN (local time: GMT+1)	OUT	DURATION (h:mm:ss)	ON SCREEN	GRAPHICS
	10:50:00	11:50:00			Start of the International Feed	
OPENING	10:50:00	11:50:00	12:00:00	00:10:00	OPENING SEQUENCE	
		11:50:00	11:50:20	00:00:20	FIS & INFRONT Animation (tape)	
		11:50:20	11:50:30	00:00:10	Beauty Shot	TITLE EVENT
		11:50:30	11:51:00	00:00:30	Wide Shots: Atmosphere at the Venue	
		11:51:00	11:52:00	00:01:00	Venue Presentation (tape)	
		11:52:00	11:52:20	00:00:20	Wide Shots: Atmosphere at the Venue	
		11:52:20	11:53:20	00:01:00	INTERVIEW with the Leader (tape)	Athletes ID
		11:53:20	11:55:00	00:01:40	Back Stage: Athletes Warm Up	
		11:55:00	11:55:10	00:00:10	Beauty Shot	TITLE EVENT
		11:55:10	11:56:00	00:00:50	Wide Shots: Atmosphere at the Venue	
		11:56:00	11:56:10	00:00:10	Wide Shot	WEATHER CONDITIONS
		11:56:10	11:56:30	00:00:20	Wide Shot	COURSE PROFILE
		11:56:30	11:57:30	00:01:00	Wide Shot	STARTING ORDER
		11:57:30	11:58:10	00:00:40	Wide shot: atmosphere at the venue	
	11:58:10	11:58:30	00:00:20	Back stage: Wall Signing (favourites)	Athletes ID	
	11:58:30	12:00:00	00:01:30	Close-ups & Warm-ups: Athletes at Start	Athletes ID	
RACE	11:00:00	12:00:00	13:10:00	01:10:00	RACE SEQUENCE	
		12:00:00	13:10:00	01:10:00	10 km F Ind.	Athlete ID / Result
CLOSING	12:10:00	13:10:00	13:20:00	00:10:00	CLOSING SEQUENCE	
		13:10:00	13:11:00	00:01:00	Wide Shot	FINAL RESULTS LIST
		13:11:00	13:12:00	00:01:00	HIGHLIGHTS: Best 3 Athletes	Athletes ID
		13:12:00	13:13:00	00:01:00	Wide Shot	WORLD CUP OVERALL STANDING
		13:13:00	13:13:30	00:00:30	HIGHLIGHTS: World Cup Leader	Athletes ID
		13:13:30	13:14:30	00:01:00	FLASH INTERVIEW with the winner (in English)	Athlete ID
		13:14:30	13:17:30	00:03:00	PODIUM CEREMONY: top 3 (3rd - 1st)	Athletes ID
		13:17:30	13:18:30	00:01:00	Wide Shot	DISTANCE OVERALL STANDING
		13:18:30	13:19:30	00:01:00	FINAL CLIP: - Best Athletes (with music) - Coaches Reactions - Fans Celebrating	
		13:19:30	13:19:40	00:00:10	Wide Shot	Director / TV production
	13:19:40	13:20:00	00:00:20	FIS & INFRONT Animation (tape)		
	12:20:00	13:20:00			Estimated International Feed closing time	

INTERMEDIATE POINTS:

START INTERVAL:

Number of Athletes:

Local Time: GMT + 01:00:00

2.4 Mass Start



Mass starts are again reasonably simple to manage as the format is conventional and easier to understand in the same way a motor race is conducted or an athletics event over any distance. Start formats will obviously vary depending on the race code but for a group mass start skiers line up in an arrow format with a number of tracks within the shape. The best-ranked skiers are positioned at the arrow's point. Mass starts are common to a number of race codes although for the distance races the course is completed by the repetition of laps or loops of the same course. The stadium component of the course will stimulate the crowd and the athletes and the shorter the loops, the greater will be the frequency of the athletes passing through the stadium.

In the planning phase of the competition it's very important for the HB director to work closely with the OC and the FIS to ensure cameras are not obstructed by the anticipated coaching zones or spectator areas.

For classic style competitions the course will feature 4 or more tracks all the way around with 6 tracks in the finish straight. The course will also feature a number of coaching zones and feeding stations (important here to use as well close ups and not only overview pictures) and may feature 3-5 bonus sprint opportunities with 15, 12, 10, 8, 7, 6, 5... 1 sprint points awarded. Athletes will have to finish the race to qualify for the WC points.

For the first time, there will be in addition an award "BMW XDrive Cup" for the World Cup points and bonus seconds. The winner of the BMW xDrive Cup ranking, who will receive a car, will be the athlete (male & female) who has collected the most bonus seconds or/and bonus points from the beginning to the end of the season (In mass start competitions as well as in sprint World Cup competition where the winner receive 60 points, the second 56 etc). TV Graphics (current standing) for this Cup are available.

The most sensible approach for high quality TV coverage is to assemble a team who is familiar with the sport and certainly a programme producer or editor who can focus their attentions on exactly what is happening during the course of the race. This is a 'hands off' position relying largely on the CIS to reveal timing progress amongst the athletes. This information will be quickly shared with the director and using the spotting team, relevant stories unfolding within the race may be told.

The philosophy for the coverage of mass start events is to establish an intermediate timing point at an early stage of the race to quickly establish the distances emerging between the leading group and other competitors. In theory all parts of the course must be considered in the camera plan because the athletes are competing against each other and not the clock.

The exciting start to the race can be approached using a combination of hand held and head on cameras, and treated almost like the starting grid of a motor race.

Again, the philosophy of camera positioning is to maintain a low angle approach to the athletes, generally offering wide and group revealing shots while showing the natural beauty and environment of the race course and surroundings.

For the longer distance races, pit stops may also be featured during the course and may be used after a certain amount of laps have been completed. Athletes may choose to change their skis which are positioned in their dedicated box (according starting bibs). The athlete that changes his skis will have a longer loop to race than the ones that decide not to stop for ski exchange. This component of the race must be considered in the camera plan and is typically covered by a handheld camera.

For the numbers of ski exchange the Data And Timing partner has newly developed a TV Graphic.



Mass start races may have a number of leader changes and it is important to maintain those stories by observing a former leader's struggle to keep up with the new leading pace, or for example a former leader's effort to reach the leading group after a pit stop. Similarly an athlete chasing the lead group maybe gradually reducing the distance and 'the attack' should also be featured.

An essential component of the TV coverage will be the inclusion of the intermediate timing points and typically all the leading athletes can be seen passing the timing point, whilst 'buying' time before cutting to the next camera in sequence. Also, the design of the course may allow the athletes to be captured on different parts of the course by the same camera.

Crowd shots should be used to help contribute to the atmosphere and interest in the event while the transitions from one camera to another are what determines the difference between good and bad coverage. Using a RF handheld camera, great POV coverage in and among the spectators is encouraged particularly with the flags and cheers of the fans as the athletes pass by.

The first athlete across the line wins. It is not uncommon for 10 skiers to be fighting for the line, often resulting in a photo finish (when the athletes cross the finish line so close together, the winner must be determined by a photograph taken at the moment of crossing).

Key Points to Consider – Mass Start Distance Events
Carefully considered camera plan to be prepared during the course design or selection with special attention to the cameras positioned around the timing points
For the distance races, an experienced producer/editor and team of spotters to aid the 'story telling' concept
Allowing athletes to pass through the timing points to illustrate the differences and help 'buy' time to the next camera cut given the length of the course
Wide and revealing shots of the athletes generally captured from low angle camera positions
Some wide shots of the athletes, probably from an elevated position may also work well, to help identify the scale and size of the course as well as the relative distances between the athletes
Capturing the atmosphere and enthusiasm of the spectators, including using a RF unit in and among the crowd
Using the spotters to apply fine timing decisions to cut to the empty space before athletes enter frame
Sensible inclusion of the pitstop zone to anticipate and feature the ski changes
Feature the bonus points, including individual points table and overall points table. Use a replay of the winner, inserting the bonus points table as a lower third
Rail camera for straights in the stadium portion of the course
Use of handheld RF camera for start, finish and pit stops
Using ski-doo's with an RF camera unit for selected parts of the course
Jimmy Jib for course sections and the finish area
A Photo Finish camera is essential at the finish line

CAMERA PLAN – MASS START EXAMPLE (TRONDHEIM)

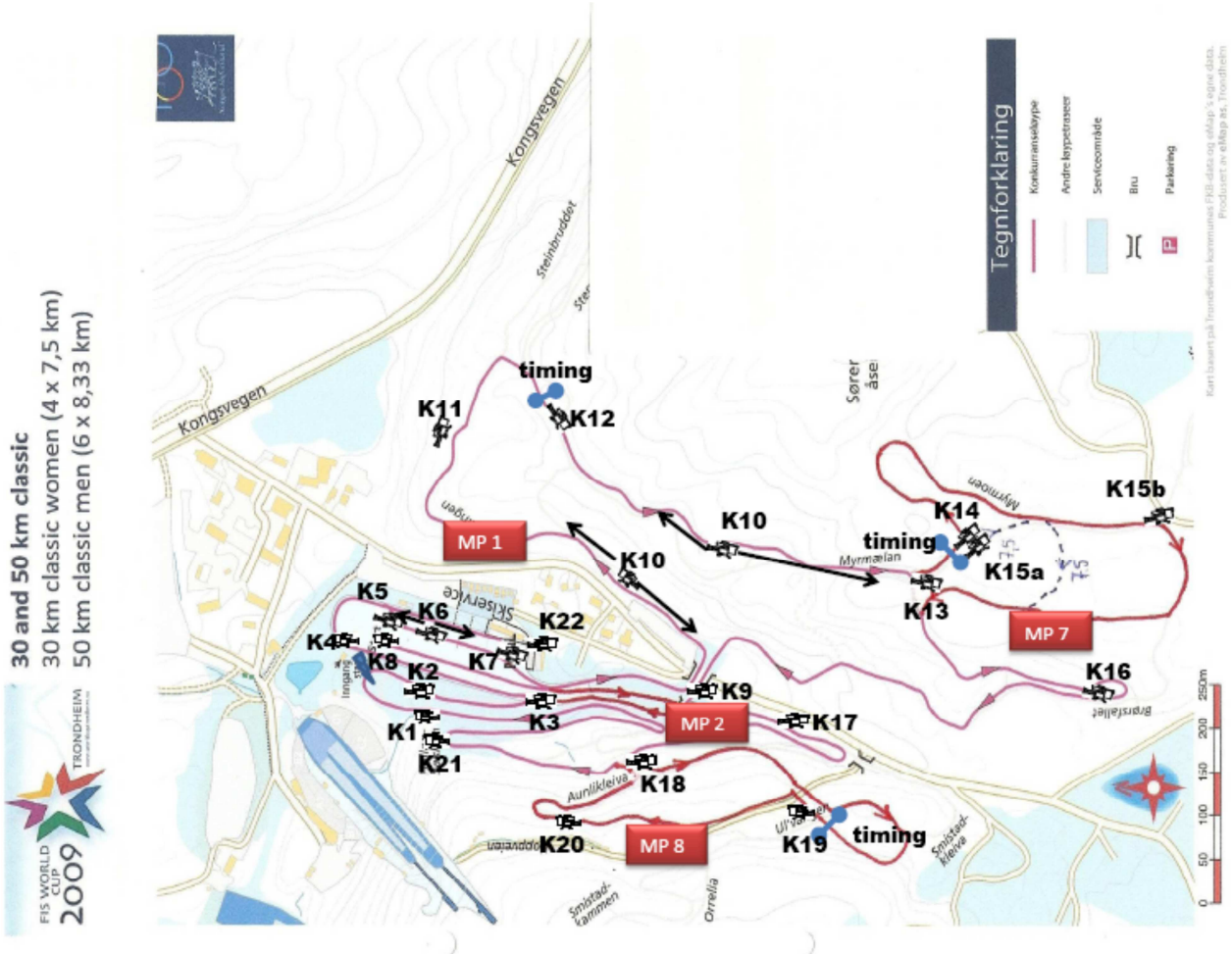

MULTILATERAL RUNNING ORDER – MASS START EXAMPLE (NOVE MESTO)

VISSMAN FIS CROSS-COUNTRY WORLD CUP

BROADCASTER MANUAL



MULTILATERAL RUNNING ORDER - MASS START START EXAMPLE

	IN (GMT)	IN (local time: GMT+1)	OUT	DURATION (h.mm.ss)	ON SCREEN	GRAPHICS
	10:50:00	11:50:00			Start of the International Feed	
OPENING	10:50:00	11:50:00	11:55:00	00:05:00	OPENING SEQUENCE	
		11:50:00	11:50:20	00:00:20	FIS & INFRONT Animation (tape)	
		11:50:20	11:50:30	00:00:10	Beauty Shot	TITLE EVENT
		11:50:30	11:51:00	00:00:30	Wide Shots: Atmosphere at the Venue	
		11:51:00	11:52:00	00:01:00	Venue Presentation (tape)	
		11:52:00	11:52:20	00:00:20	Wide Shots: Atmosphere at the Venue	
		11:52:20	11:53:20	00:01:00	INTERVIEW with the Leader (tape)	Athletes ID
		11:53:20	11:55:00	00:01:40	Back Stage: Athletes Warm Up	
		11:55:00	11:55:10	00:00:10	Beauty Shot	TITLE EVENT
		11:55:10	11:56:00	00:00:50	Wide Shots: Atmosphere at the Venue	
		11:56:00	11:56:10	00:00:10	Wide Shot	WEATHER CONDITIONS
		11:56:10	11:56:30	00:00:20	Wide Shot	COURSE PROFILE
		11:56:30	11:57:30	00:01:00	Wide Shot	STARTING ORDER
		11:57:30	11:58:00	00:00:30	Athletes WALK-IN	
		11:58:00	11:59:00	00:01:00	Athletes Presentation	Athletes ID
	11:59:00	12:00:00	00:01:00	Athletes Close-ups: First Row	Athletes ID	
RACE	11:00:00	12:00:00	12:50:00	00:50:00	RACE SEQUENCE	
		12:00:00	12:50:00	00:50:00	15 km C MSt	Athlete ID / Result
CLOSING	11:50:00	12:50:00	13:00:00	00:10:00	CLOSING SEQUENCE	
		12:50:00	12:51:00	00:01:00	Wide Shot	FINAL RESULTS LIST
		12:51:00	12:52:00	00:01:00	HIGHLIGHTS: best 3 Athletes	Athletes ID
		12:52:00	12:53:00	00:01:00	Wide Shot	WORLD CUP OVERALL STANDING
		12:53:00	12:53:30	00:00:30	HIGHLIGHTS: World Cup Leader	Athlete ID
		12:53:30	12:54:30	00:01:00	FLASH INTERVIEW with the winner (in English)	Athlete ID
		12:54:30	12:57:30	00:03:00	PODIUM CEREMONY: top 3 (3rd - 1st)	Athletes ID
		12:57:30	12:58:30	00:01:00	Wide Shot	DISTANCE OVERALL STANDING
		12:58:30	12:59:30	00:01:00	FINAL CLIP: - Best Athletes (with music) - Coaches Reactions - Fans Celebrating	
		12:59:30	12:59:40	00:00:10	Wide Shot	Director / TV production
	12:59:40	13:00:00	00:00:20	FIS & INFRONT Animation (tape)		
	12:00:00	13:00:00		Estimated International Feed closing time		

INTERMEDIATE POINTS:

BONUS POINTS:

Number of Athletes:

Local Time: GMT + 01:00:00

2.5 Mass Start (Technique Exchange)

The mass start (technique exchange) event combines both a classic technique leg followed by a free technique leg (so called Skiathlon) and therefore also requires two different courses. Similar to the mass start event, competitors begin simultaneously, lined up in an arrow format with the best-ranked skiers at the arrow's point. At the race's halfway mark, athletes enter the stadium and change skis and poles as quickly as possible. The women ski a 7.5-kilometre classic course, followed by 7.5 km (or more) of free technique; the men ski 15 kilometres classic followed by 15 kilometres free. Short loops ensure the competitors pass through the stadium every six to eight minutes. The first athlete to cross the finish line wins.



The coverage plan should include some details of the classic technique to demonstrate the glide and grip of the skis, particular as some athletes may excel in one discipline more than in the other. The equipment change is an important feature in the race and should be captured via a pair of handheld units and at least one head on camera.

Key Points to Consider – Mass Start (Technique Exchange) Events

Carefully considered camera plan to be prepared during the course design or selection with special attention to the cameras positioned around the timing points and the crucial technique exchange

Given the format demands two separate courses, the camera plan and cable installation should aim to combine technical resources, moving cameras during the race to new positions with allocated cable drops

An experienced producer/editor and team of spotters to aid the 'story telling' concept - using the spotters to apply fine timing decisions to cut to the empty space before athletes enter frame

Allowing athletes to pass through the timing points to illustrate the time differences and help 'buy' time to the next camera cut positioned on the course

Wide and revealing shots of the athletes generally captured from low angle camera positions

Capturing the atmosphere and enthusiasm of the spectators, including using a RF unit in and among the crowd

Using the spotters to apply fine timing decisions to cut to the empty space before athletes enter frame

Rail camera for straights in the stadium portion of the course

Use of handheld RF cameras for start, finish and the equipment exchange

Using ski-doo's with an RF camera unit for selected parts of the course

Jimmy Jib for course sections and the finish area

A Photo Finish camera is essential at the finish line



CAMERA PLAN – MEN MASS START (TECHNIQUE EXCHANGE) – VANCOUVER

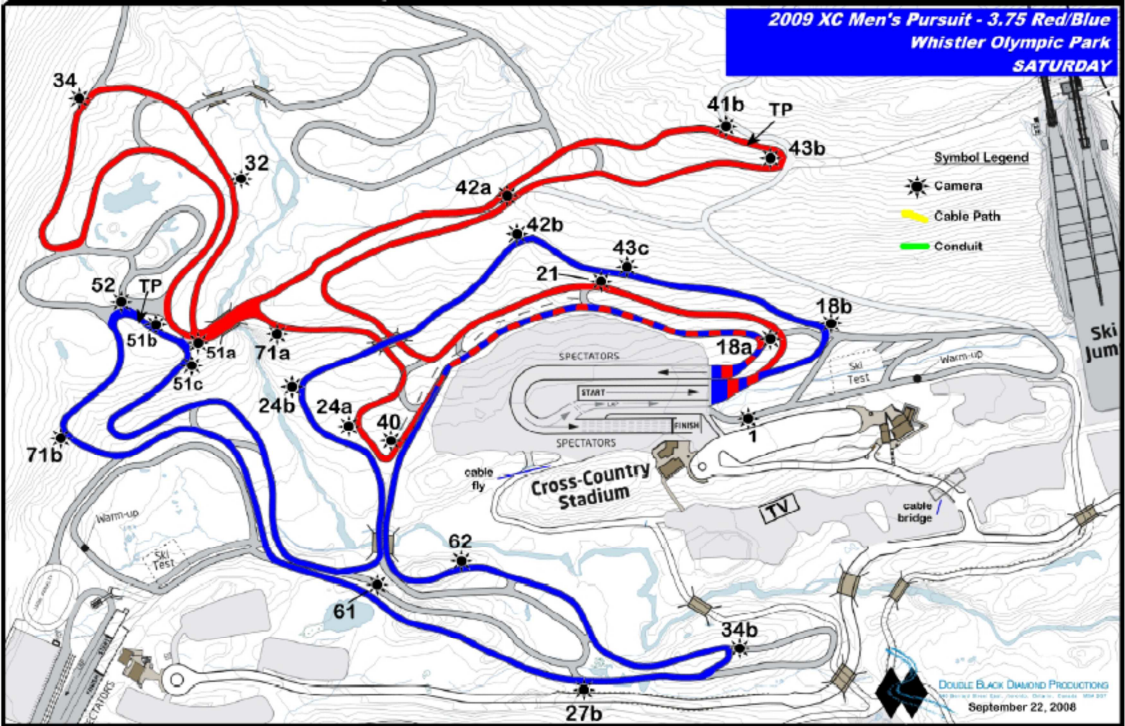

PURSUIT STADIUM CAMERA NARRATIVE EXAMPLE (VANCOUVER)

Cam	Map Ref	Type	Lens	Platform	Comments
1	1	Hard	70x	Crane	Height 15 - 35M
2	2	Hard	70x	Snow Platform	Lens 0.5M above track; tight lapping
3	3	HH	20x	2M Tower	Finish wide
4	4	Hard	86x	Snow Trench	Finish tight; lens 0.5M above snow Man repo from 41B
5	5	HH-RF Steady	WA	On foot on snow	Start, Exchanges, Finish
6	6	HH-RF	20x	On foot on snow	Start, Lapping, Finish
7	7	Hard	86x	Sled on snow	Exchanges, Lapping
8	8	Hard	70x	3M Tower	Start, Lapping & Finish High Side Shot
9	9	ICONIX	tbc	Post	Photo Finish

MASS START (TECHNIQUE EXCHANGE) CAMERA - (red course)

Cam	Map Ref	Type	Lens	Platform	Comments
1	18A	HH	21x	2x2 on snow	
2	21	Hard	70x	2x2 on snow	
3	40	SB-WESCAM	WA	N.A.	Stationary Panning, under bridge
4	42A	HH	20x	2x2 on snow	Low angle; out and return speed
5	43B	HH	33x	2x2 on snow	Approach & climb to TP
6	41B	HH	20x	2x2 on snow	TP – from elevated area skiers
7	51A	HH	21x	2x2 on snow	
8	32	Hard	70x	2x2 on snow platform	Lens 0.5M above track
9	34A	HH	20x	2x2 on snow platform	Lens 0.5M above track
10	51B	HH	21x	Standing on snow	Shot thru trees from blue track
11	71A	HH	20x	2x2 on snow	Pan to bridge
12	24A	HH	20x	2x2 on snow platform	Follow around corner to SB P/U
13	40	SB-WESCAM	WA	N.A.	

MASS START (TECHNIQUE EXCHANGE) CAMERA NARRATIVE EXAMPLE –
(BLUE COURSE)

Cam	Map Ref	Type	Lens	Platform	Comments
1	18B	HH	21x	2x2 on snow	Cam & Man Repo from 18A
2	43C	HH	33x	2x2 on snow	Cam & Man Repo from 43B
3	42B	HH	20x	2x2 on snow	Low Angle; Cam & Man Repo from 42A
4	24B	HH	20x	2x2 on slow platform – in tower set back in trees	Low Angle; Cam & Man Repo from 24A
5	61	HH-JIB	WA	5x5 on snow	
6	51C	HH	21x	2x2 on snow platform	Cam & Man Repo from 51B Lens 0.5M above track
7	52	HH	20x	2x2 on snow	TP – Man Repo from 21
8	71B	HH	20x	2x2 on snow	Cam & Man Repo from 71A
9	27B	Hard	70x	2x2 on rock wall	Cam & Man Repo from C-27 Friday
10	34B	HH	20x	2x2 on snow	Cam & Man Repo from 34A
11	62	Hard	70x	2x2 on snow	Man Repo from 32
12	40	SB-WESCAM	WA	NA	

Totals: 20 Cameramen, 24 cameras = 9 Hard, 13 HH (1 JIB + 2RF O-OPS), 1 snowmobile, 1 photo-finish

MULTILATERAL RUNNING ORDER – MASS START (TECHNIQUE EXCHANGE)

VISSMAN FIS CROSS-COUNTRY WORLD CUP

BROADCASTER MANUAL



MULTILATERAL RUNNING ORDER - MASS START START (TECHNIQUE EXCHANGE) EXAMPLE

	IN (GMT)	IN (local time: GMT+1)	OUT	DURATION (h,mm:ss)	ON SCREEN	GRAPHICS
	10:50:00	11:50:00			Start of the International Feed	
OPENING	10:50:00	11:50:00	12:00:00	00:10:00	OPENING SEQUENCE	
		11:50:00	11:50:20	00:00:20	FIS & INFRONT Animation (tape)	
		11:50:20	11:50:30	00:00:10	Beauty Shot	TITLE EVENT
		11:50:30	11:51:00	00:00:30	Wide Shots: Atmosphere at the Venue	
		11:51:00	11:52:00	00:01:00	Venue Presentation (tape)	
		11:52:00	11:52:20	00:00:20	Wide Shots: Atmosphere at the Venue	
		11:52:20	11:53:20	00:01:00	INTERVIEW with the Leader (tape)	Athletes ID
		11:53:20	11:55:00	00:01:40	Back Stage: Athletes Warm Up	
		11:55:00	11:55:10	00:00:10	Beauty Shot	TITLE EVENT
		11:55:10	11:56:00	00:00:50	Wide Shots: Atmosphere at the Venue	
		11:56:00	11:56:10	00:00:10	Wide Shot	WEATHER CONDITIONS
		11:56:10	11:56:30	00:00:20	Wide Shot	COURSE PROFILE
		11:56:30	11:57:30	00:01:00	Wide Shot	STARTING ORDER
		11:57:30	11:58:00	00:00:30	Athletes WALK-IN	
		11:58:00	11:59:00	00:01:00	Athletes Presentation	Athletes ID
	11:59:00	12:00:00	00:01:00	Close-ups & Warm-ups: Athletes at Start (favourites)	Athletes ID	
RACE	11:00:00	12:00:00	12:45:00	00:45:00	RACE SEQUENCE	
		12:00:00	12:45:00	00:45:00	Skiathlon	Athlete ID / Result
CLOSING	11:45:00	12:45:00	12:55:00	00:10:00	CLOSING SEQUENCE	
		12:45:00	12:46:00	00:01:00	Wide Shot	FINAL RESULTS LIST
		12:46:00	12:47:00	00:01:00	HIGHLIGHTS: Best 3 Athletes	Athletes ID
		12:47:00	12:48:00	00:01:00	Wide Shot	WORLD CUP OVERALL STANDING
		12:48:00	12:48:30	00:00:30	HIGHLIGHTS: World Cup Leader	Athletes ID
		12:48:30	12:49:30	00:01:00	FLASH INTERVIEW with the winner (in English)	Athlete ID
		12:49:30	12:53:00	00:03:30	PODIUM CEREMONY: top 3 (3rd - 1st)	Athletes ID
		12:53:00	12:53:30	00:00:30	Wide Shot	DISTANCE OVERALL STANDING
		12:53:30	12:54:30	00:01:00	FINAL CLIP: - Best Athletes (with music) - Coaches Reactions - Fans Celebrating	
		12:54:30	12:54:40	00:00:10	Wide Shot	Director / TV production
	12:54:40	12:55:00	00:00:20	FIS & INFRONT Animation (tape)		
	11:55:00		12:55:00		Estimated International Feed closing time	

INTERMEDIATE POINTS:

BONUS POINTS:

Number of Athletes:

Local Time: GMT + 01:00:00

2.6 Relay

In the exciting relay event, teams of four ski the first two legs of the relay using the classic technique, and the last two legs using free technique. The women ski four x 5-kilometre legs for a total of 20 kilometres while the men ski four x 7,5-kilometre legs for a total of 30 kilometres (at Olympics and World Championships 4 x 10 km). The relay begins in a mass start format with teams lined up in an Arrow Start Grid; the exchange between skiers is similar to that in the team sprint competition. The winning team is the first to cross the finish line after the fourth leg of the relay has been completed. A relay course must be arranged with two loops, one for the classic technique and one for the free technique and therefore this is an important consideration when developing the production plan.

Same coverage plan philosophy as a group (mass start, pursuit and relay) team event and therefore two RF camera units for the changeover is always the best way to show the exchanges for each team.



The team exchanges are important and for an international broadcast each team exchange should be revealed, and observing one team-mate hand over to the other another is a good way of illustrating the time difference.

Key Points to Consider – Team Relay Events

Carefully considered camera plan to be prepared during the course design or selection with special attention to the cameras positioned around the timing points and the relay exchange portion of the course

Given the format demands two separate courses, the camera plan and cable installation should aim to combine technical resources, moving cameras during the race to new positions with allocated cable drops

An experienced producer/editor and team of spotters to aid the 'story telling' concept - using the spotters to apply fine timing decisions to cut to the empty space before athletes enter frame

Allowing athletes to pass through the timing points to illustrate the distances between the participating teams

Wide and revealing shots of the athletes generally captured from low angle camera positions

Capturing the atmosphere and enthusiasm of the spectators, including using a RF unit in and among the crowd

Rail camera for straights in the stadium portion of the course

Use of handheld RF camera for start, finish and exchanges

Using ski-doo's with an RF camera unit for selected parts of the course

Jimmy Jib for course sections and the finish area

A Photo Finish camera is essential at the finish line



CAMERA PLAN – MEN RELAY EXAMPLE (LA CLUSAZ)

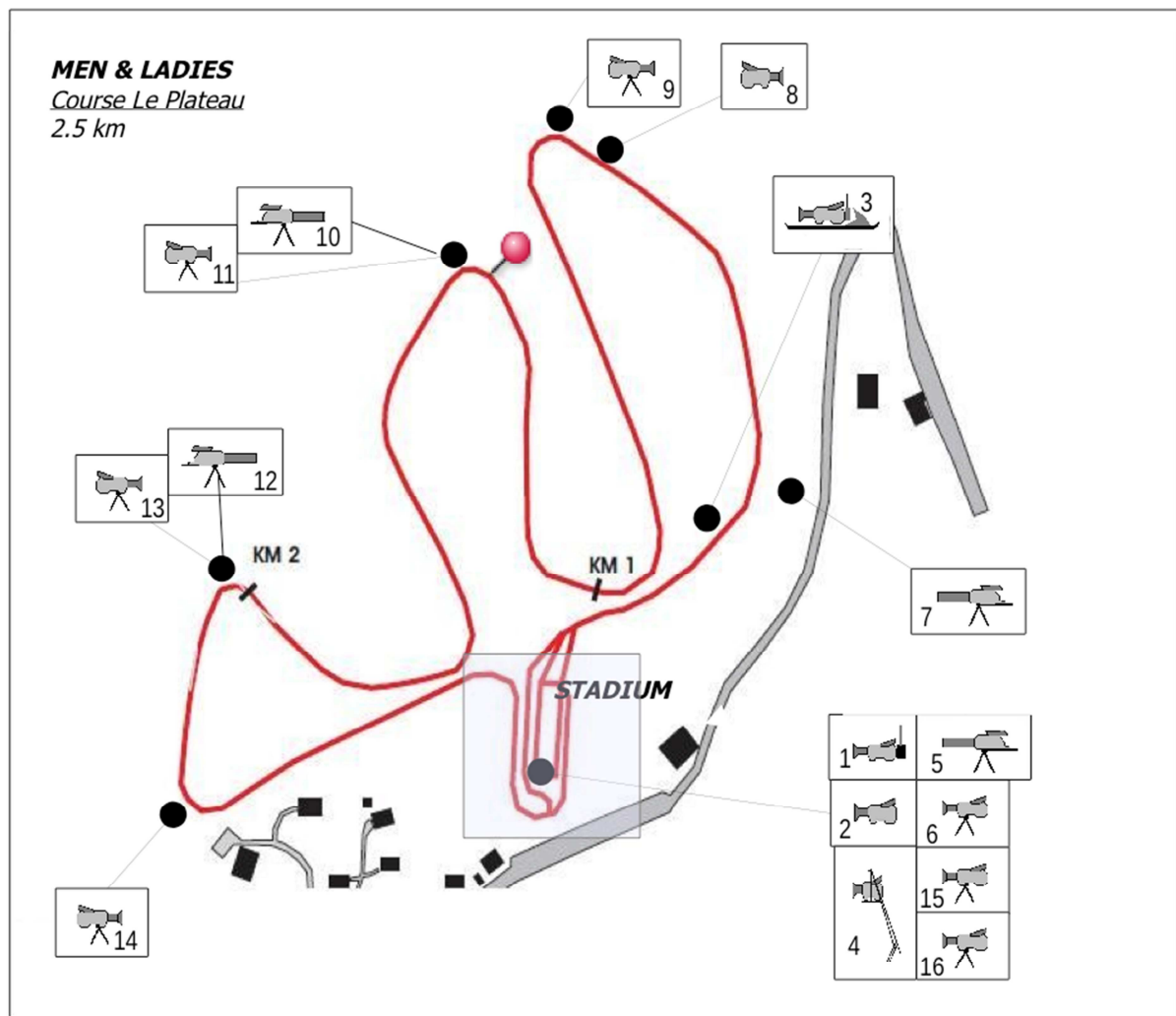

CAMERA PLAN – MEN RELAY NARRATIVE EXAMPLE (LA CLUSAZ)

Men Relay 4x7,5 C+F

Cam	Comments
1	Hand-held radio, wide angle lens, start, transit & changes Skidoo, Finish Area skiers right side, podium
2	Hand-held cabled, 22x lens, cable no. 1: start, transit & changes, cable no 2: Finish Area, skiers left side, podium, Mixed Zone
3	Crane 13M, wide angle lens, platform ground level 6x6, start, transit & changes, finish
4	Platform 4M, 86x lens (after the last transit, this operator will move to Cam 14)
5	Platform 2M, 22x lens (ex feeding area)
6	Ref. Cam 7 Mass Start: Platform Ground Level, 86X lens, top of the uphill
7	Ref. Cam 8 Mass Start: Intermediate 1.7 – 22x lens, hand-held or light tripod to show the gradient of the uphill
8	Ref. Cam 9 Mass Start: Intermediate 1.7 – 22x lens, platform ground level top of the uphill
9	Ref. Cam 10 Mass Start: Platform ground level, top of the uphill, 72x lens
10	Ref. Cam 11 Mass Start: Platform ground level beside Cam 10, 22x lens
11	Ref. Cam 12 Mass Start: Platform ground level, 72x lens, top of the last uphill
12	Ref. Cam 13 Mass Start: Platform 2M skiers left, 22x lens, downhill and curve to the stadium
13	Ref. Cam 14 Mass Start: Hand-held, wide-angle, area in-between the transit lane and the entrance to the finish straight
14	Ref. Cam 15 Mass Start: Platform on commentary cabins, 72x lens, finish action (it will be operated after the last transit)

3.Event Phase

3.1. Run up to the first TX commitment

As soon as a FIS Cross-Country Skiing competition reaches the final planning week a number of scheduled activities must take place to fully prepare the venue, course and broadcasting

arrangements a relatively short amount of time. The following table provides an example for a combined format race (i.e. a sprint with a middle or long distance format).

Days before TX	Description
- 5 Days	Tender and support vehicles travel and park
- 4 Days	Assemble all camera platforms as well as initial cabling for both race formats.
- 3 Days	Cabling continues
- 2 Days	<p>Director and Timing Supervisor agree and identify pre and intermediate timing points as per the survey details</p> <p>Complete cabling, position and install cameras and microphones</p> <p>HB Outside Broadcast vehicles arrive as well as any mobile production facilities for attending rights holders</p> <p>TV Compound park and power</p>
- 1 Days	<p>Initial meeting and inspection of the finish area/TV position with organising committee, chief of press/media to discuss any details</p> <p>SNG vehicles park and power with cabling to the HB production vehicle</p> <p>Complete OB Van configuration and perform technical facilities check before the end of the day and according to local daylight conditions</p> <p>As part of the facilities and production rehearsal produce the test race with timing (as required and agreed on a case by case basis)</p> <p>Commentator's briefing (as required)</p> <p>TV coordination meeting to include current progress, all technical issues, running order brief and programme of unilateral activities</p> <p>Third and final meeting with all FIS management parties, the OC including Chief of course, Stadium and ceremonies and the venue announcer</p>
TX Day 1	Complete Race 1 and reset of course for race 2
TX Day 2	Full facilities check and rehearsal followed by race 2

3.2 Camera Production Test and Rehearsal

The competition format, location and experience of the host broadcaster will determine the necessity to conduct a full test race in advance of the first televised commitment and this requirement should be considered on a case by case basis.

If required, the NSA and OC will organise a junior or amateur race in good time in advance of the first competition. The 'test' race will take place at a specific time and must include a full timing service and a post race presentation.

Some experienced broadcasters use a skidoo travelling at a similar speed to the athletes to step through the camera positions and cutting sequence.



3.3 Daily Call Sheets

The HB is expected to distribute call sheets on a daily basis to their production crew to include the necessary checks of their production facilities including the interface with timing and signal path to the uplink vehicle.

All pre and post unilateral requests must be included in the daily call sheets.

EXAMPLE DAILY CALL SHEET

Time	Description
08:00	Engineering crew arrive on site and check power and facilities
09:00	Production crew arrive on site, (cameras, audio assistants, VTR, graphics, uplink)
09:15 – 09:30	Production briefing
09:30	All camera operators and crew to positions
10:00 – 10:30	Full faces check and rehearsal
10:50 – 12:30	On Air Race 1
12:35 – 12:45	Post unilateral 1
12:45 – 12:55	Post unilateral 2
13:00 – 14:00	Lunch
14:00 – 14:20	All cameras and crew in position
14:20 – 15:30	On Air Race 2
15:35 – 15:45	Post Unilateral 1
15:45 – 15:55	Post unilateral 2
16:00	Off air, de-rig and power down

4. FIS Cross-Country Skiing 'Tour de Ski Format'



The FIS Tour de Ski is a spectacular and unique component of the calendar season featuring 6-9 top international Cross-Country Skiing competitions in 7-9 days hosted in 5 different venues in 3 different nations. The events are scheduled during the festive season between Christmas and the beginning of the New Year.

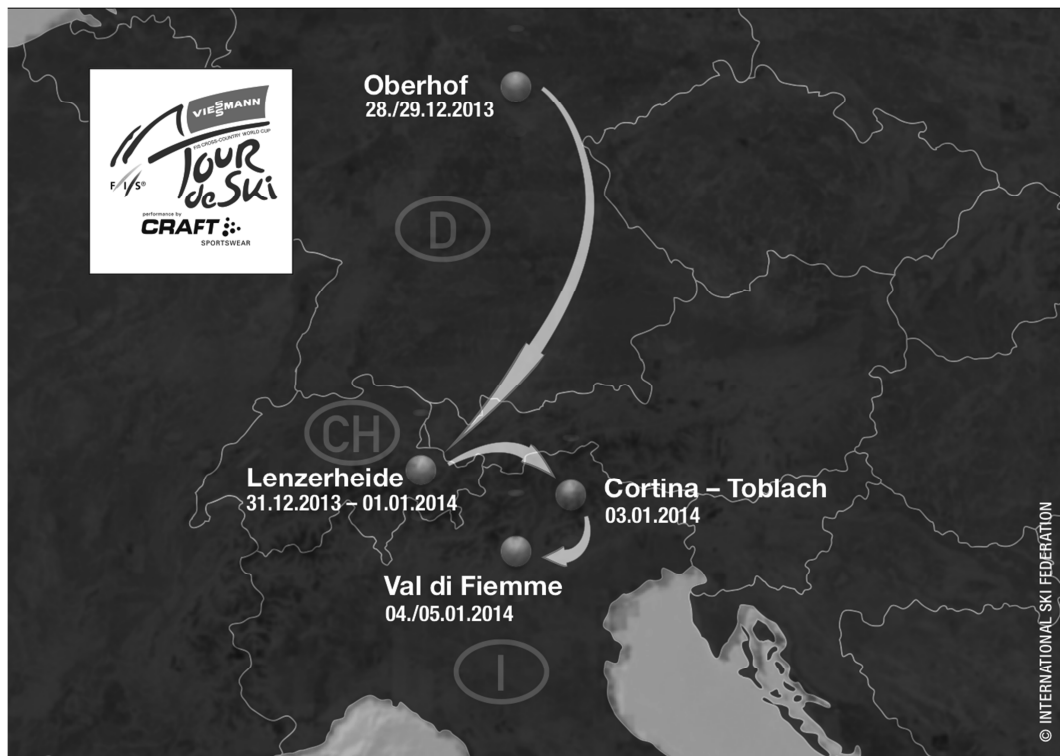

The FIS Tour de Ski is organised by the International Ski Federation (FIS) and the National Ski Associations (NSA's) of Germany, Switzerland and Italy. The overall coordination for the organisation of the FIS Tour de Ski is handled by the FIS Tour Board.

The FIS Tour de Ski allows competitors to contribute to their overall points standings for the season as a whole as well as compete for the individual and team trophies awarded to the best performing athletes from the 6-9 competitions.

Only entry for all FIS TOUR DE SKI stages is possible. Abandonment in one race will lead to exclusion from the rest of the FIS TOUR DE SKI.

Details to the Tour, Rules and Race Formats you can Find here: http://www.fis-ski.com/data/document/rules-cc_1314_draft_all_with-cover.pdf

4.1 Television Considerations

Each host venue of the Tour de Ski will be associated with one or more race disciplines and the appointed host broadcaster will be responsible for launching a coverage plan which includes those formats. The production philosophy for each race remains unchanged according to the guidelines outlined in section 4 although the course variety featured in the 'Tour de Ski' will require careful planning and consideration, particularly for the final hill climb.

The multilateral running order formats are designed to best reflect the current standings in the Tour de Ski, including pre-race flash quotes from the current leader and a video package of the top three. The FIS TV Supervisor will contribute to the editorial decision making of the running order format.

All FIS Cross-Country Skiing events will include a pre-competition TV Coordination meeting likely to be attended by the following personnel:

FIS (Race Director – Event/Tour Coordinator– Media Coordinator)

Tour de Ski Venue Manager

International Media Agent (TVM)

Local Organisers (Chief of Stadium and Course / TV & Media Coordinator / Chief of Ceremony / Speaker)

Host Broadcaster Producer/Director

Unilateral Broadcasters

TV/Radio Commentators

FIS aims to present the Tour de Ski as with all of FIS Cross-Country Skiing events with the same high standards of production and consistency. The FIS TV Supervisor will support consistencies within the coverage plan and the final delivery.



MULTILATERAL RUNNING ORDER - MASS START TOUR DE SKI EXAMPLE

	IN (GMT)	IN (local time: GMT+1)	OUT	DURATION (h:mm:ss)	ON SCREEN	GRAPHICS
	10:50:00	11:50:00			Start of the International Feed	
OPENING	10:50:00	11:50:00	12:00:00	00:10:00	OPENING SEQUENCE	
		11:50:00	11:50:20	00:00:20	FIS & INFRONT Animation (tape)	
		11:50:20	11:50:30	00:00:10	Beauty Shot	TITLE EVENT
		11:50:30	11:51:00	00:00:30	Wide Shots: Atmosphere at the Venue	
		11:51:00	11:52:00	00:01:00	Venue Presentation (tape)	
		11:52:00	11:52:20	00:00:20	Wide Shots: Atmosphere at the Venue	
		11:52:20	11:53:20	00:01:00	INTERVIEW: Tour de Ski Leader (tape)	Athlete ID
		11:53:20	11:55:00	00:01:40	Back Stage: Athletes Warm Up	
		11:55:00	11:55:10	00:00:10	Beauty Shot	TITLE EVENT
		11:55:10	11:55:40	00:00:30	TOUR OPENER	
		11:55:40	11:55:50	00:00:10	Wide Shots: Atmosphere at the Venue	
		11:55:50	11:56:20	00:00:30	TOUR NEWS FLASH: Top 3 Tour Leaders (tape)	Athletes ID
		11:56:20	11:56:30	00:00:10	Wide Shots: Atmosphere at the Venue	
		11:56:30	11:57:00	00:00:30	Athletes WALK-IN	Athletes ID
		11:57:00	11:57:10	00:00:10	Wide Shot	WEATHER CONDITIONS
		11:57:10	11:57:30	00:00:20	Wide Shot	COURSE PROFILE
		11:57:30	11:58:30	00:01:00	Wide Shot	STARTING ORDER
		11:58:30	11:58:40	00:00:10	Wide shot: atmosphere at the venue	
		11:58:40	11:59:30	00:00:50	Favourites to win the Tour de Ski	Athletes ID
	11:59:30	12:00:00	00:00:30	Close-ups & Warm-ups: Athletes at Start (favourites)	Athletes ID	
RACE	11:00:00	12:00:00	12:35:00	00:35:00	RACE SEQUENCE	
		12:00:00	12:35:00	00:35:00	10 km C MSt	Athlete ID / Result
					FLASH INTERVIEW: Tour de Ski Leader	Athlete ID
CLOSING	11:35:00	12:35:00	12:45:00	00:10:00	CLOSING SEQUENCE	
		12:35:00	12:36:00	00:01:00	Wide Shot	FINAL RESULTS LIST
		12:36:00	12:36:40	00:00:40	Wide Shot	TOUR DE SKI OVERALL STANDING
		12:36:40	12:37:00	00:00:20	Wide Shot	WORLD CUP OVERALL STANDING (2 pag.)
		12:37:00	12:38:00	00:01:00	HIGHLIGHTS: Best 3 Athletes	Athletes ID
		12:38:00	12:38:10	00:00:10	Wide shot: atmosphere at the venue	
		12:38:10	12:38:40	00:00:30	HIGHLIGHTS: Tour de Ski Leader	Athlete ID
		12:38:40	12:43:10	00:04:30	- S tage Winner PODIUM CEREMONY: - Tour Leader - T our Sprint Leader	Athletes ID
		12:43:10	12:44:30	00:01:20	FINAL CLIP (with music): - Best Athletes - C oaches Reactions - F ans Celebrating	
		12:44:30	12:44:40	00:00:10	Wide Shot	Director / TV production
	12:44:40	12:45:00	00:00:20	FIS & INFRONT Animation (tape)		
	11:45:00	12:45:00			Estimated International Feed closing time	

INTERMEDIATE POINTS:

BONUS SECONDS:

Number of Athletes:

Local Time: GMT + 01:00:00

5. Graphics Data and Timing

5.1. FIS Graphics, Data and Timing Partner

FIS, in close partnership with a third party service provider is responsible for the data and timing service that will deliver the FIS TV graphic presentation used during the transmission of the international signal for any given FIS event.

The service provider, under the supervision of the TV Producer, will be responsible for the complete graphics presentation, including the overall race timing, pre and intermediate timing, results and standings, course profiles, name supers, photo finish, weather, title, TV Director credit etc. This data and timing service:

Shall be a component of the international world feed and will therefore be seen by all RHB's in their TV transmissions. The service is provided in the English language

Will be inserted with the corporate name/logo free of charge by the RHB's

In all cases the GFX presentation must be suitable for 4:3 safe aspect ratio

The HB is responsible for providing and installing the necessary cables from the timing and data room to their production vehicle/facilities including a talkback system. The HB must also provide a colour monitor for the timing room with the dirty programme feed.

The graphics, data and timing partner will also be responsible for the photo finish technology and will make available this image to the host broadcaster as and when required. As a standard component of each running order, a course profile animation is included in the format and this will be prepared and delivered by the timing partner.

Typically the animation is pre-recorded to EVS by the host broadcaster and used in rehearsal and during the programme at the HB's convenience.

The data and timing service will be located as conveniently as possible to the TV Compound infrastructure and will be identified during the site survey.

The connectivity can be summarised as follows:

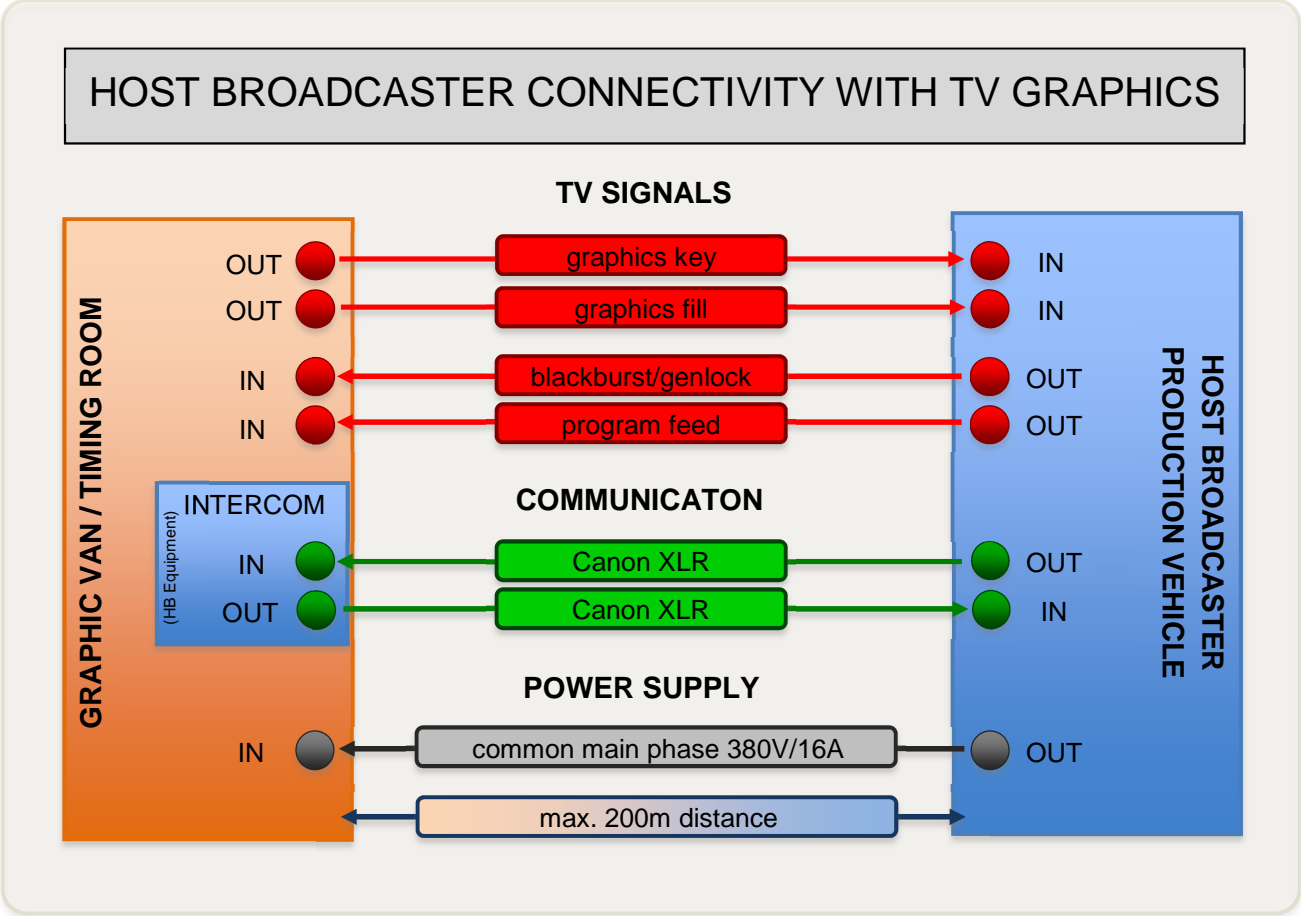

5.2. TV Graphics Examples

Basics pulse / heart rate



Basics Track Profile

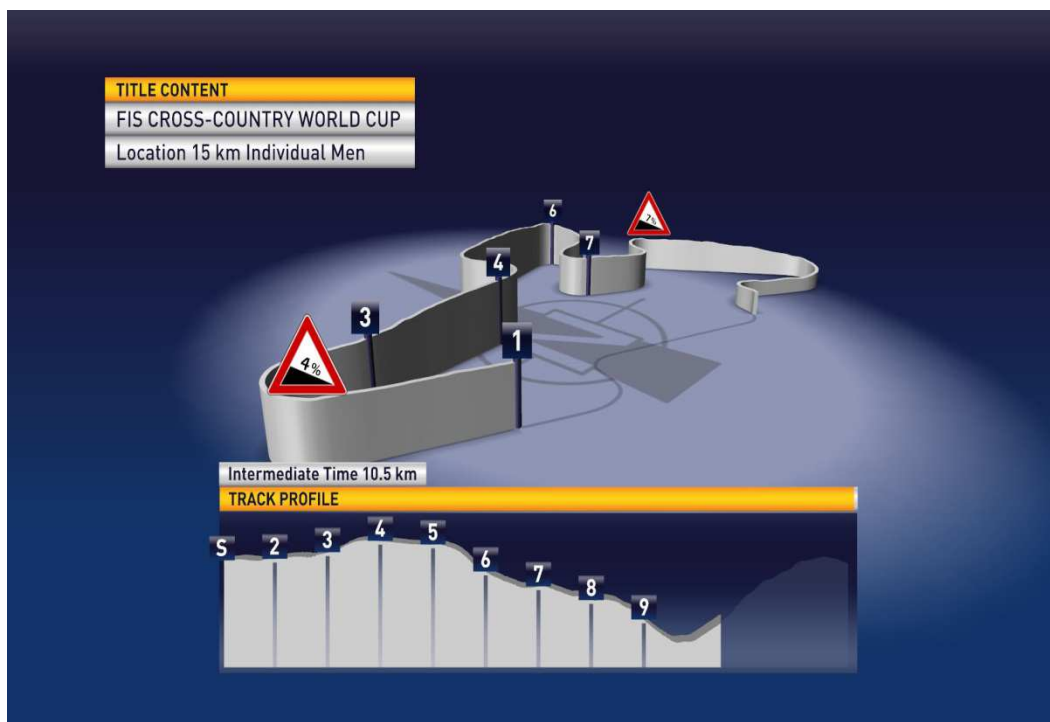

Ko all at finish with
lucky loser



FIS WORLD CUP CROSS COUNTRY
BEITOSTOELEN (NOR)
KO SPRINT

QUARTER FINAL MEN - HEAT 5				METER
1	Dario COLOGNA	0	SUI 	1:05.3
2	Lukas BAUER	0	CZE 	+0.8
3	Juha LALLUKKA	LL	FIN 	+1.3
4	Tim TSCHASRNKE	LL	GER 	+1.7
5	Eldar ROENNING		NOR 	+10.0
6	Matti HEIKKINEN		FIN 	+11.5

www.fisrasscountry.com

Pur starting order
time difference



FIS WORLD CUP CROSS COUNTRY
BEITOSTOELEN (NOR)
15 KM INDIVIDUAL MEN

START LIST			TIME
1	Dario COLOGNA	SUI 	+0:00
2	Roland CLARA	ITA 	+0:05
3	Devon KERSHAW	CAN 	+0:06
4	Curdin PERL	SUI 	+0:07
5	Martin JAKS	CZE 	+0:08
6	Lukas BAUER	CZE 	+0:10
7	Daniel RICKARDSSON	SWE 	+0:10
8	Tom REICHELT	GER 	+0:12

www.fisrasscountry.com

Weather

BAUHAUS FIS WORLD CUP SKI JUMPING
LILLEHAMMER (NOR)
LARGE HILL INDIVIDUAL

WEATHER CONDITIONS

Air Temperature	-4.5 °C
Snow Temperature	-10.0 °C
Humidity	82 %
Wind	0.5 m/s
Weather	lightly snowfall

www.fisiskijumping.com

World Cup Ranking

BAUHAUS FIS WORLD CUP SKI JUMPING
LILLEHAMMER (NOR)
LARGE HILL INDIVIDUAL

WORLD CUP STANDINGS

			POINTS
1	Thomas MORGENSTERN	AUT	325
2	Andreas KOFLER	AUT	250
3	Ville LARINTO	FIN	232
4	Matti HAUTAMAEKI	FIN	201
5	Simon AMMANN	SUI	189
6	Anders BARDAL	NOR	152
7	Tom HILDE	NOR	150
8	Johan Remen EVENSEN	NOR	141
9	Adam MALYSZ	POL	129
10	Daiki ITO	JPN	117

www.fisiskijumping.com