

INSTALLATION GUIDE

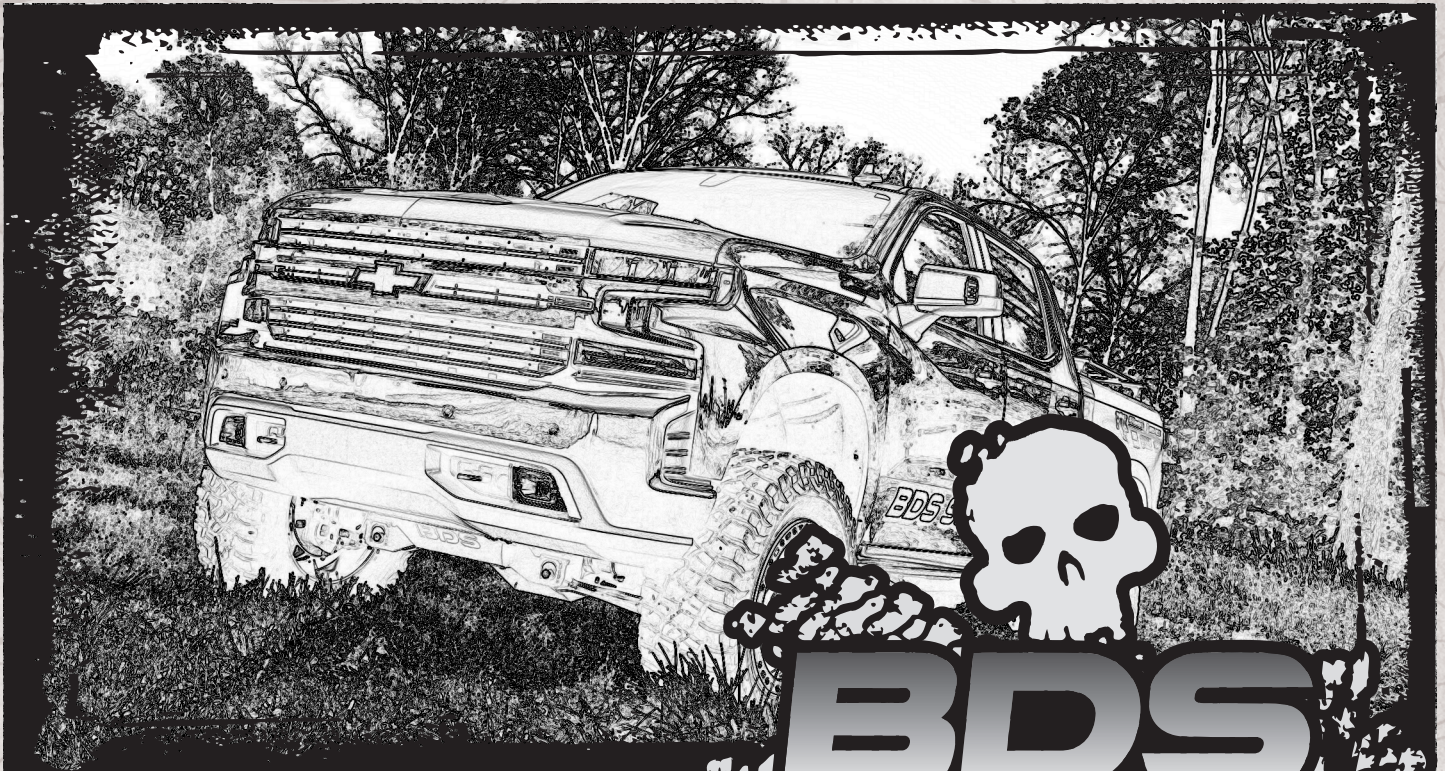

Part#: 021664

HARDCORE LIMITED LIFETIME WARRANTY

4" and 6" Suspension Systems

4" and 6" Chevy/GMC 1500 4WD Pickup | 2019-2022
4" Chevy Trail Boss/GMC 1500 AT4 4WD Pickup | 2019-2022
4" Chevy ZR2/GMC 1500 AT4X 4WD Pickup | 2019-2022

Rev. 021523

491 W. Garfield Ave., Coldwater, MI 49036 • Phone: 517-279-2135

E-mail: tech-bds@ridefox.com

Read And Understand All Instructions And Warnings Prior To Installation Of System And Operation Of Vehicle.

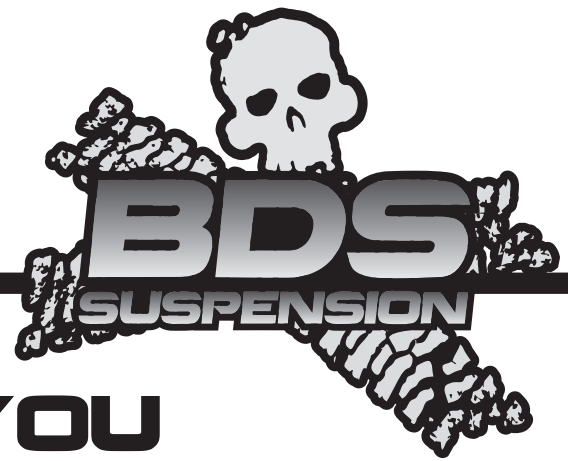

THANK YOU

Your truck is about to be fitted with the best suspension system on the market today. That means you will be driving the baddest looking truck in the neighborhood, and you'll have the warranty to ensure that it stays that way for years to come. Thank you for choosing BDS Suspension!

BEFORE YOU START

BDS Suspension Co. recommends this system be installed by a professional technician. In addition to these instructions, professional knowledge of disassembly/ reassembly procedures and post installation checks must be known.

FOR YOUR SAFETY

Certain BDS Suspension products are intended to improve off-road performance. Modifying your vehicle for off-road use may result in the vehicle handling differently than a factory equipped vehicle. Extreme care must be used to prevent loss of control or vehicle rollover. Failure to drive your modified vehicle safely may result in serious injury or death. BDS Suspension Co. does not recommend the combined use of suspension lifts, body lifts, or other lifting devices. You should never operate your modified vehicle under the influence of alcohol or drugs. Always drive your modified vehicle at reduced speeds to ensure your ability to control your vehicle under all driving conditions. Always wear your seat belt.

BEFORE INSTALLATION

Special literature required: OE Service Manual for model/year of vehicle. Refer to manual for proper disassembly/reassembly procedures of OE and related components.

Adhere to recommendations when replacement fasteners, retainers and keepers are called out in the OE manual.

Larger rim and tire combinations may increase leverage on suspension, steering, and related components. When selecting combinations larger than OE, consider the additional stress you could be inducing on the OE and related components.

Post suspension system vehicles may experience drive line vibrations. Angles may require tuning, slider on shaft may require replacement, shafts may need to be lengthened or trued, and U-joints may need to be replaced.

Secure and properly block vehicle prior to installation of BDS Suspension components. Always wear safety glasses when using power tools.

If installation is to be performed without a hoist, BDS Suspension Co. recommends rear alterations first.

Due to payload options and initial ride height variances, the amount of lift is a base figure. Final ride height dimensions may vary in accordance to original vehicle attitude. Always measure the attitude prior to beginning installation.



Visit 560plus.com for more information.

TRACTION CONTROL

In an effort to reduce the risk of rollover crashes the National Highway Traffic Safety Administration (NHTSA) established the Federal Motor Vehicle Safety Standard (FMVSS) No. 126 requiring all new passenger vehicles under 10,000 lbs GVWR include an electronic stability control (ESC) system as standard equipment. Effective August 2012 this law requires aftermarket products to be compliant with these same standards.



BEFORE YOU DRIVE

Check all fasteners for proper torque. Check to ensure for adequate clearance between all rotating, mobile, fixed, and heated members. Verify clearance between exhaust and brake lines, fuel lines, fuel tank, floor boards and wiring harness. Check steering gear for clearance. Test and inspect brake system.

Perform steering sweep to ensure front brake hoses have adequate slack and do not contact any rotating, mobile or heated members. Inspect rear brake hoses at full extension for adequate slack. Failure to perform hose check/ replacement may result in component failure. Longer replacement hoses, if needed can be purchased from a local parts supplier.

Perform head light check and adjustment.

Re-torque all fasteners after 500 miles. Always inspect fasteners and components during routine servicing.

CONTENTS OF YOUR KIT

021664 (DRV) / 021665 (PASS) Knuckle Box Kit

Part #	Qty	Description
03613	1	Steering Knuckle - DRV (021664 only)
03614	1	Steering Knuckle - PASS (021665 only)
02911	2	Ball Joint Cap (021664 Only)
9452K145	2	O-Ring (021664 Only)
874	1	Bolt Pack (021664 Only)
	3	Wire Clamp (Fastenal #0708759)
	2	1/4"-20 x 3/4" Bolt, Grade 5, Clear Zinc
	2	1/4"-20 Prevailing Torque Nut, Clear Zinc
	4	1/4" SAE Washer, Clear Zinc
	2	12mm-1.75 Nylock Nut, Clear Zinc
640	1	Bolt Pack
	4	14mm-2.00 x 80mm Bolt, Class 10.9, Clear Zinc
	4	14mm-2.00 Prevailing Torque Nut, Clear Zinc
	8	14mm Washer, Clear Zinc
02826	2	Steering Stop (As Needed)
A408	1	Driver Side UCA Assembly (021664 Only)
A409	1	Passenger Side UCA Assembly (021665 only)
401-2039	2	Tie Rod End

021684 (6") / 021405 (4") Strut Spacer Box Kit

Part #	Qty	Description
03827	2	6" Strut Spacer (021684 Only)
03828	2	4" Strut Spacer (021405 Only) (TB / AT4)
629	1	Bolt Pack
	6	10mm-1.50 prevailing torque nut clear zinc
	6	3/8" USS flat washer clear zinc

021682 Front Box Kit

Part #	Qty	Description
03615	1	Front Cross Member
03616	1	Rear Cross Member
03617	1	Sway Bar Drop - DRV
03618	1	Sway Bar Drop - PASS
02802	2	BDS Badge
995	1	Rivet Bolt Pack
03730	1	Diff Drop - DRV
03731	1	Diff Drop - PASS
03732	1	Diff Drop Brace - PASS
849	1	Bolt Pack - Control Arm/ Crossmember
	8	M18 x 2.5 Prevailing Torq Nut - Clear Zinc
	8	3/4 SAE Thru Hard Flat Washer - Clear Zinc
	2	18mm-2.50 x 120mm Class 10.9 Bolt - Clear Zinc
	2	18mm-2.50 x 130mm Class 10.9 Bolt - Clear Zinc

021683 (Gas) / 021685 (Diesel) Box Kit

Part #	Qty	Description
02175B	1	Differential Skid Plate - DRV
03626	1	Differential Skid Plate - PASS
03646	1	Front Skid Plate (021683 Only)
03627	1	Weld In Plate
099000	7	11.5in Nylon Cable Tie - Black
0708765	1	Wire Clamp
142	1	.875x3.268 Sleeve
05037	2	CV Spacer
342701	1	Thread Locker
02001	8	Eccentric Cam
03623	4	Eccentric Cam Bolt
03622	1	Passenger Side Diff Mount Spacer
05014	1	Front Skid Plate (021685 Only)
97525A505	2	3/16in SS Blind Rivet (021685 Only)
03586	1	BDS Badge (021685 Only)
01715	1	Trans Line Relocation (021685 Only)
846	1	Bolt Pack - Diff Drop
	3	9/16"-12 x 4" Bolt - Grade 8 - Yellow Zinc
	1	9/16"-12 x 1-3/4" Bolt - Grade 8 - Yellow Zinc
	8	9/16" SAE Washer - Yellow Zinc
	4	9/16"-12 Prevailing Torque Nut
	1	14mm-2.00 x 120mm Bolt - Class 10.9 - Clear Zinc
	1	14mm Washer - Clear Zinc
	1	12mm-1.75 x 120mm Bolt, Class 10.9, Clear Zinc
	2	1/2" SAE Washer, Clear Zinc
	1	12mm-1.75 Prevailing Torque Nut, Clear Zinc
	4	10mm-1.50 x 30mm Bolt, Class 10.9, Clear Zinc
	4	3/8" SAE Washer, Clear Zinc
422	1	Bolt Pack
	4	3/8"-16 x 1-1/4" bolt grade 8 yellow zinc
	4	3/8"-16 prevailing torque nut yellow zinc
	8	3/8" USS flat washer thru-hardened yellow zinc
847	1	Bolt Pack - Skid Plate & Knuckle (021683 Only)
	5	Wire Clamp
	7	6mm-1.00 x 12mm Bolt - Class 8.8 - Clear Zinc
	7	1/4" SAE Washer - Clear Zinc
	8	1/2"-13 x 1-1/4" Bolt - Grade 8 - Yellow Zinc
	2	1/2"-13 x 4" Bolt - Grade 8 - Yellow Zinc
	12	1/2" SAE Washer - Yellow Zinc
	2	1/2"-13 Prevailing Torque Nut - Yellow Zinc
361	1	Bolt Pack - Skid Plate & Knuckle (021685 Only)
	5	Wire Clamp
	7	6mm-1.00 x 12mm Bolt, Class 8.8, Clear Zinc
	7	1/4" SAE Washer, Clear Zinc
	8	1/2"-13 x 1-1/2" Bolt, Grade 8, Yellow Zinc
	8	1/2" SAE Washer, Yellow Zinc
	1	1/4"-20 Prevailing Torque Nut, Clear Zinc
	1	1/4" USS Washer, Clear Zinc

011518 5" Rear Box Kit / 011316 3" Rear Box Kit

Part #	Qty	Description
03669	2	5" Rear Block (011518 Only)
03670	2	3" Rear Block (011316 Only)
962961212QB	4	9/16 x 2-9/16 x 12-1/2 Square U-bolt (5")
962961138QB	4	9/16 x 2-9/16 x 11-3/8 Square U-bolt (3")
3396	2	Bump Stop Spacer
03578	2	Leaf Spring U-bolt Plate (011518 Only)
380412FCP	2	Center Pin (011518 Only)
03667	1	Rear ABS BRKT
03668	1	Rear Brake Line BRKT
N96FH-B	8	9/16 Fine High Nut- Black
W96S-B	8	9/16 SAE Flat Washer-Black
848	1	Bolt Pack
	2	10mm-1.50 x 100mm Allen head bolt
	2	1/4"-20 x 1" Bolt - Grade 5 - Clear Zinc
	2	1/4"-20 Prevailing Torque Nut - Clear Zinc
	4	1/4" SAE Washer - Clear Zinc
	2	5/16"-18 x 1" Bolt - Grade 5 - Clear Zinc
	2	5/16"-18 Prevailing Torque Nut - Clear Zinc
	4	5/16" SAE Washer - Clear Zinc

121405 4" AT4 or ZR2 Box Kit

Part #	Qty	Description
03828	2	4" Strut Spacer
03805	2	Rear Shock Relocation
69	4	.75 x .083 x 1.375 Sleeve
854	1	Bolt Pack - Shock Relocation
	4	9/16"-12 x 3-1/2" Bolt
	8	9/16" SAE Washer
	4	9/16"-12 Prevailing Torque Nut
629	1	Bolt Pack - Strut Spacer
	6	10mm-1.50 prevailing torque nut clear zinc
	6	3/8" USS flat washer clear zinc



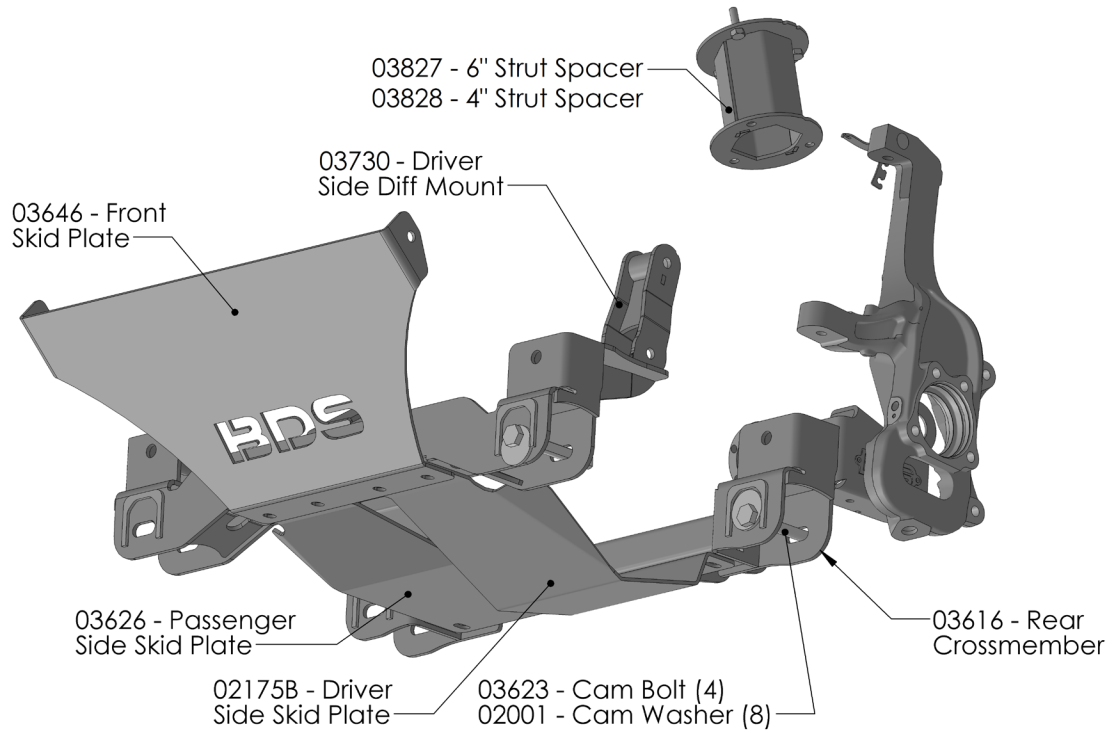
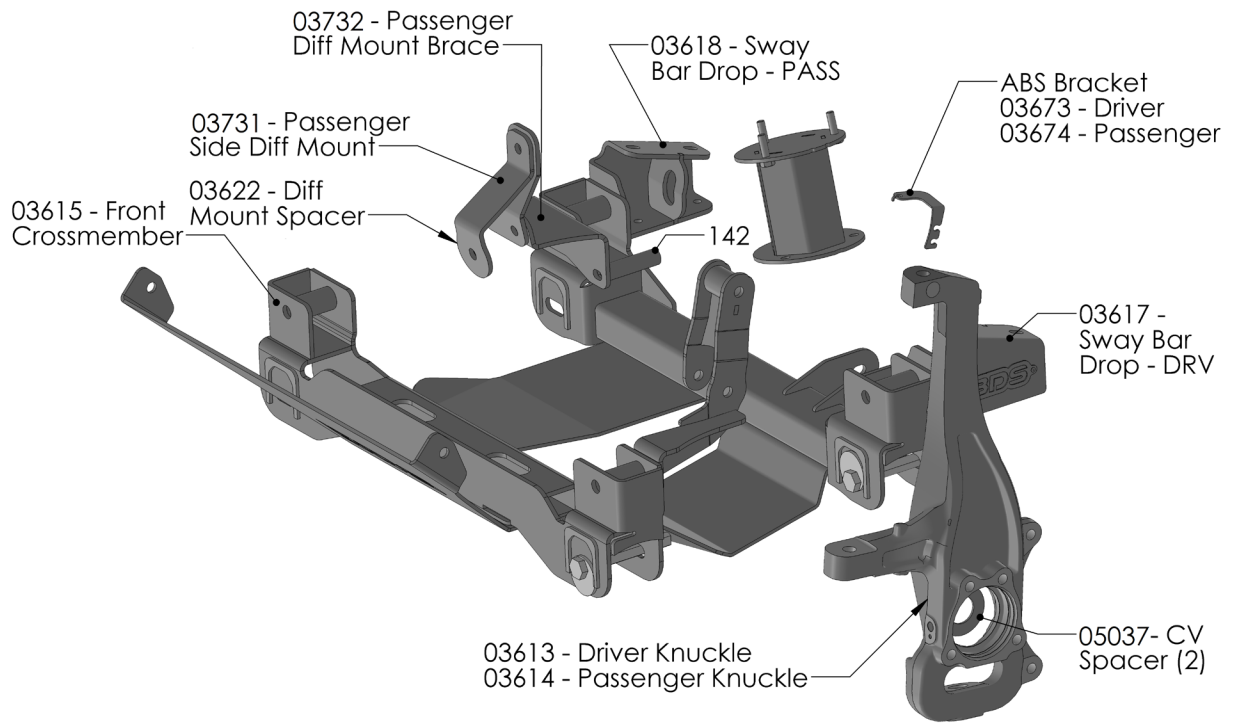

TIRES AND WHEELS 6" FITMENT GUIDE

Chevy

35" x 12.50 on 17x8, 17x9, 18x9 w/4.5" BS
35" x 12.50 on 20x9 or 22x9 w/4.5"-6.25" BS
37" x 12.50 on 20x9 or 22x9 w/ 5.5"- 6.25" BS

GMC

295/70 on 17x8, 17x9, 18x9 w/4.5" BS
295/65 on 20x9 w/4.5"-6.25" BS
35" x 12.50 on 20x9 or 22x9 w/5.5"-6.25" BS

*See troubleshooting notes

*Trimming may be required



TIRES AND WHEELS 4" FITMENT GUIDE

Chevy

33" x 12.50 on 17x8, 17x9, 18x9 w/4.5" BS
33" x 12.50 on 20x9 or 22x9 w/4.5"-6.25" BS
35" x 12.50 on 20x9 or 22x9 w/ 5.5"- 6.25" BS

GMC

295/65 on 17x8, 17x9, 18x9 w/4.5" BS
295/60 on 20x9 w/4.5"-6.25" BS
35" x 12.50 on 20x9 or 22x9 w/5.5"-6.25" BS

*See troubleshooting notes

*Trimming may be required



TROUBLESHOOTING INFORMATION FOR YOUR VEHICLE

1. Do not install this kit on a 4" standard (Non Trail Boss / Non AT4) truck unless the box kit description for BDS021664 & BDS021665 specifically say compatible with 4" and 6".
2. Upper control arms will add an additional 1-2 degrees over stock control arms.
3. Requires frame bracket modification and welding.
4. All aftermarket wheels should be test fit prior to mounting the tire to ensure proper clearance to the brake caliper. Some wheel profiles will not clear the brake caliper. These can be test fitted before the vehicle is lifted.
5. 17" wheels with 4.5" backspacing should be test fit prior to mounting the tire to ensure proper clearance to the steering knuckle/tie rod.
6. Stock 20" Wheels (6.25" Backspacing) can be installed, stock 17" or 18" Wheels CAN NOT be installed.
7. Must purchase kits 750H or 747H for Adaptive Ride Equipped Vehicles (Denali), see separate instructions for these kits.
8. Must purchase kits 775H, 776H, 777H, 778H, 779H, or 780H for Diesel models.
9. 1829H kit is for AT4X or ZR2 specific models only. This kit is designed to relocate the shock to reuse the factory Multimatic shocks. Fox 2.0 Replacement struts will not work with AT4X or ZR2 models.
10. 6" lift will NOT work with TrailBoss or AT4 Models.
11. O-rings in factory steering knuckle will be reused. Take care not to damage O-rings on disassembly and assembly
12. When disassembling the steering knuckle from the truck, be careful not to drop the CV shaft on to the top of the lower ball joint. The top of the lower ball joint has very sharp edges that can cut the CV boot.
13. If possible, do not remove the CV shafts from the front differential. The CV retaining clips will need to be replaced if the front CV shafts are removed.
14. Replacement ball joint is BDS081203, use this for replacement purposes if a new ball joint is ever needed. Ball joint is directional and must be installed with the 'dot' facing either inward or outward on the vehicle, otherwise damage may occur.

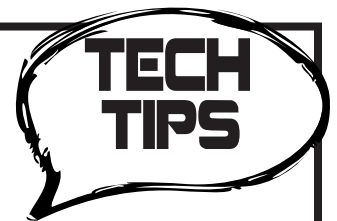

INSTALLATION INSTRUCTIONS

MEASURE FIRST

Measure from the center of the wheel up to the bottom edge of the wheel opening:

LF _____ RF _____

LR _____ RR _____

WELDING IS REQUIRED

The installation of this kit requires minor welding of a reinforcement plate. We recommend this procedure be performed by an experienced welder. If necessary, this kit can be completely installed and then driven to a shop to have the plate welded. This method will make reaching the weld locations slightly more difficult but it can be done if necessary.

FRONT DISASSEMBLY

1. Park the vehicle on a clean, flat surface and block the rear wheels for safety.
2. Disconnect the positive and negative battery cables from the battery.
3. Raise the front of the vehicle with a hydraulic jack and support the frame with jack stands. Remove the wheels.



Tip *If an impact wrench is not being used, the CV axle nut will need to be removed with the weight of the vehicle on the wheel.*

4. Remove the ABS line and brake sensor from the retaining clips at the frame, upper control arm and knuckle. Disconnect the brake line bracket from the steering knuckle (Fig. 1). Save bolt.

FIGURE 1A



FIGURE 1B



5. Remove the ABS sensor from the steering knuckle (Fig. 2).

FIGURE 2



SPECIAL TOOLS

36mm Socket - Hub Nut

Reciprocating Saw or Cut Off Wheel & Grinder

Welder

C-Clamps (2)

Rivet Gun

Ball Joint Separator

6. Remove the splash guard from the vehicle (Fig. 3).

FIGURE 3



7. Remove the tie rod end nut. Disconnect the tie rod from the knuckle (Fig. 4). **Aluminum Knuckle:** Avoid striking the knuckle, typically the taper unseats more easily and gently hitting the end of the tie rod end will unseat the taper. A pickle fork can also be used. Save the mounting nut.

FIGURE 4



8. Remove the two brake caliper mounting bolts and remove the caliper from the knuckle (Fig. 5). Hang the caliper securely out of the way DO NOT hang the caliper by the brake hose. Save caliper bolts.

FIGURE 5

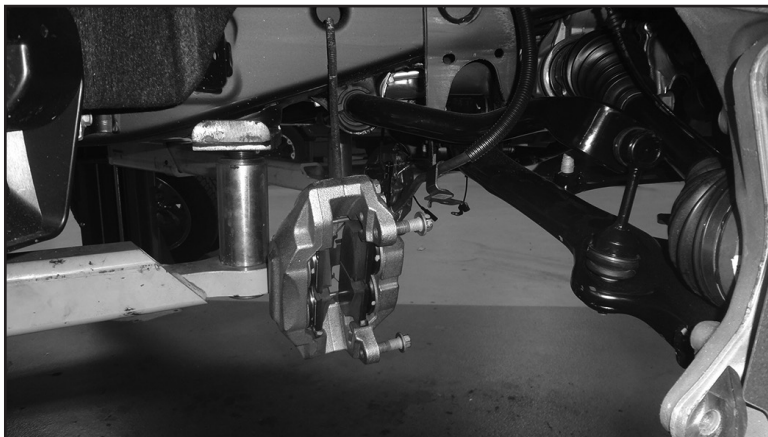

9. Remove the brake rotor retaining bolt and remove the rotor from the vehicle.

10. Remove and retain the axle shaft nut. (Fig. 6)

 **Tip** *The axle nut will require a 36mm socket.*

FIGURE 6



11. Remove the sway bar links nut from the the lower control arms (Fig. 7). Save the hardware.

FIGURE 7

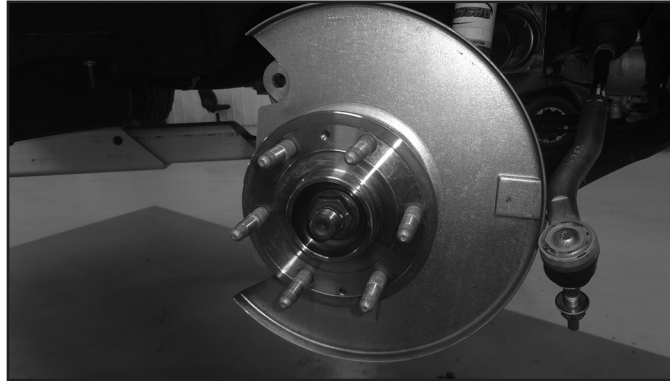
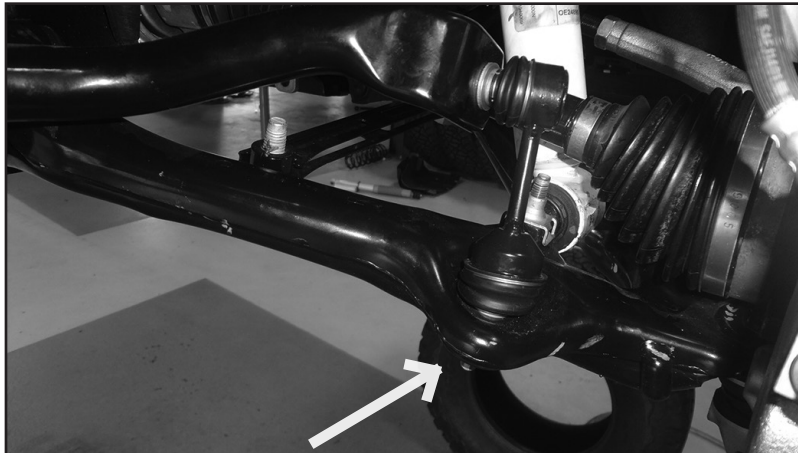

12. Mark the orientation of the sway bar and remove it from the frame by removing the four bushing cap mounting bolts (Fig. 8). Save all sway bar components, the hardware can be discarded..

 **Tip** *Mark D and P on the sway bar to indicate driver and passenger side for orientation when reinstalling the sway bar.*

FIGURE 8



13. Remove the upper and lower ball joint nuts and thread back on by hand a couple of turns. **Aluminum Knuckles:** Avoid striking the knuckle to release the taper, recommended to use a ball joint separator tool to release the taper. If you do resort to hitting the knuckle avoid re-use and discard.



Tip When disassembling the steering knuckle from the truck, be careful not to drop the CV shaft on to the top of the lower ball joint. The top of the lower ball joint has very sharp edges that can cut the CV boot.

FIGURE 9

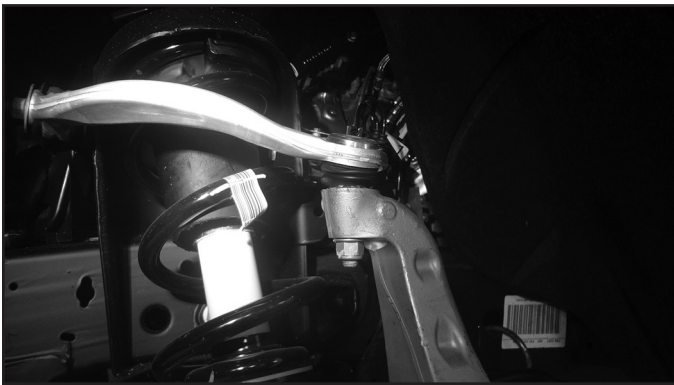
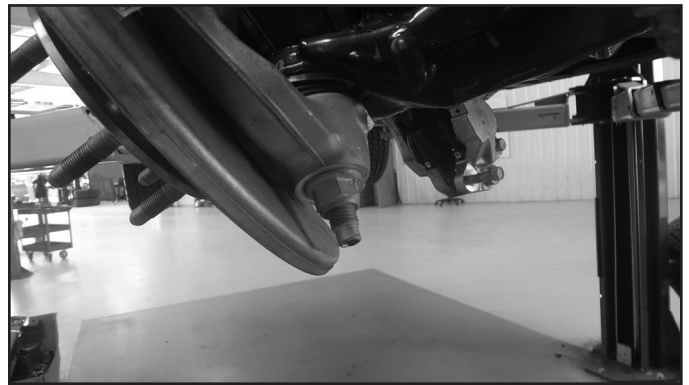

FIGURE 10



14. Mark each of the front strut bodies to indicate driver's versus passenger's side.
15. Support the lower control arm with a jack. Remove the upper ball joint nut and the lower strut mount bolts (Fig. 11). Save bolts. Swing the knuckle / lower control arm down to remove the CV shaft from the hub. Retain ball joint nut and strut bolts.

FIGURE 11



16. Remove the lower ball joint nut and remove the knuckle from the vehicle. Retain hardware.

17. Remove the front and rear lower control arm mounting bolts and remove the lower control arm from the vehicle. Save mounting hardware and control arms.
18. Remove the three upper strut mounting nuts (Fig. 12) and remove the strut from the vehicle. DO NOT remove the center strut rod nut, it is under extreme pressure. Save nuts.

FIGURE 12

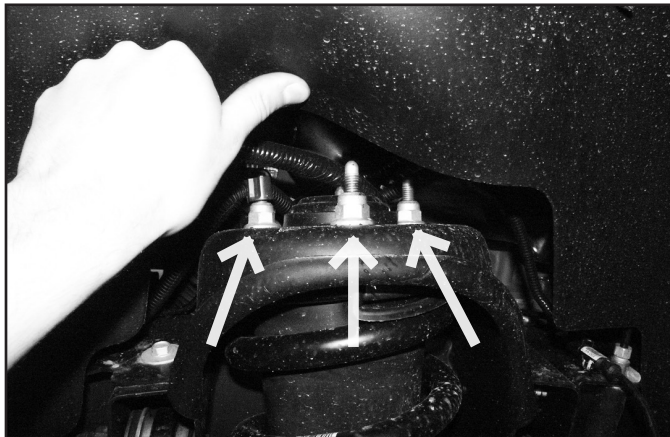

19. Make an alignment mark to show the relationship between the front driveshaft and the differential yoke. Remove the six driveshaft bolts and disconnect the driveshaft from the differential. Save bolts. (Fig. 13)

FIGURE 13



20. Remove the bolt attaching the differential to the rear cross member (Fig. 14). The hardware will not be reused.

FIGURE 14



21. Remove the factory rear cross member from the vehicle by removing the 4 bolts. (Fig 15) Cross member and hardware will not be reused.

FIGURE 15



22. Disconnect the differential actuator wire connector from the actuator (Fig. 16).



Tip *If you are having difficulty accessing the plug, wait until the differential is being lowered to disconnect it.*

FIGURE 16

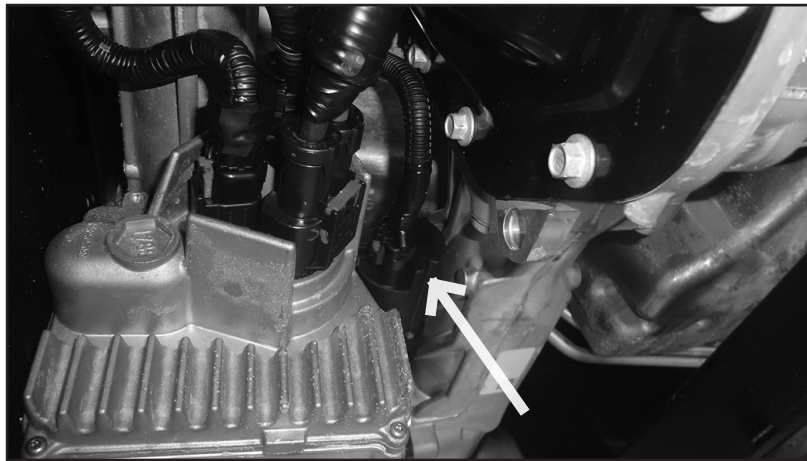

23. Disconnect the differential breather hose (Fig. 17).



Tip *The differential may need to be lowered a little bit to disconnect the breather hose. This can be done as the differential is being removed.*

FIGURE 17 - SHOWN WITH DIFFERENTIAL REMOVED FOR CLARITY



24. **Diesel Models Only:** Remove the transmission cooler line near the from drive shaft attached to the transmission.

25. Support the front differential with an appropriate jack. Remove the driver's side differential mounting bolts (Fig. 18). Save mounting bolt hardware.



Tip We highly recommend having an assistant to help with removal of the front differential.



Caution If possible, do not remove the CV shafts from the front differential. The CV retaining clips will need to be replaced if the front CV shafts are removed.

FIGURE 18

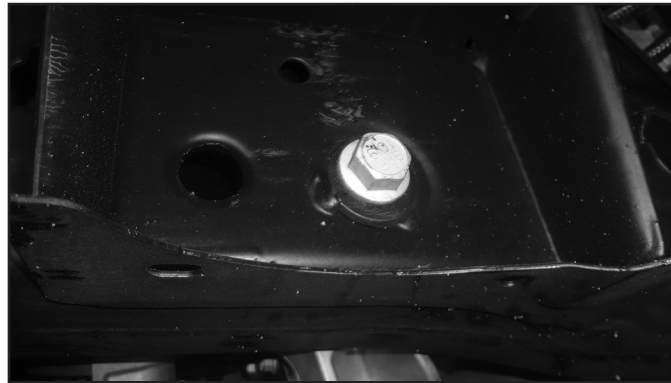

26. Remove the nut from the passenger's side differential mounting bolt (Fig. 19A). Carefully lower the differential to the ground while removing the long bolt for the passenger's side differential mount (Fig. 19B). Do not remove the CV shafts if possible. If removed the CV shafts will need the retaining clips replaced.



Tip The bolt holding the actuator may need to be removed in order to aid in removal of the long bolt for the differential. The bolt is on the right side in Figure 19B. Reinstall the bolt for the actuator after it has been removed. It also helps to push the rear of the differential upwards to point the bolt head downwards to aid in removal.

FIGURE 19A



FIGURE 19B

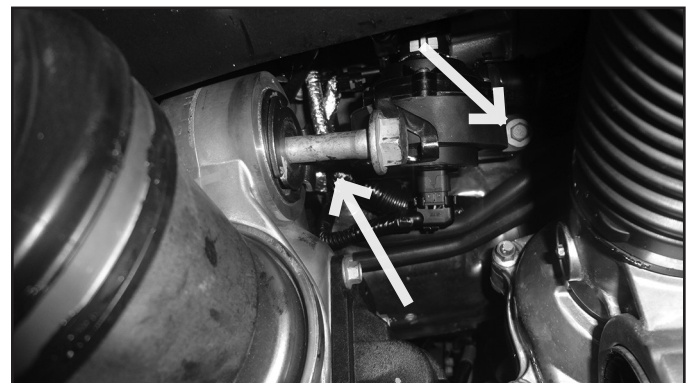

27. The driver's side rear lower control arm pocket must be cut to provide clearance for the front differential in the relocated position. This area needs to be cleaned of any oil, grease and/or undercoating. These coatings are flammable.



Tip A putty knife and parts cleaning solvent work well to remove undercoating.

28. Measure from the inside of the driver's side rear control arm pocket out 2-9/16" and mark (Fig. 20A). Repeat this measurement on the opposite side of the pocket. Make vertical cut lines at the 2-9/16" mark up both front and back faces of the pocket (Fig. 20B).

FIGURE 20A - DRIVER SIDE REAR



FIGURE 20B - DRIVER SIDE REAR

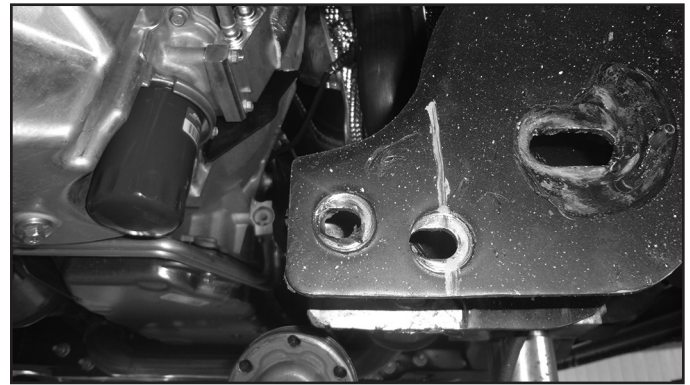

29. Make a vertical cut along each of the cut lines on the front and back faces of the control arm pocket with a reciprocating saw (recommended), cut-off wheel or plasma cutter. Be careful, the undercoating on the frame is flammable and can melt and drip off the frame. Keep a fire extinguisher near by.
30. With the vertical cuts complete, cut the top portion of the pocket by connecting the two cuts.
31. The bottom front of the rear lower control arm pockets must be cut to provide clearance for the rear cross member. This area needs to be cleaned of any oil, grease and/or undercoating. These coatings are flammable.



Tip A putty knife and parts cleaning solvent work well to remove undercoating.

32. Measure down 1-3/8" from the bottom edge of the rear control arm bolt hole on both the driver and passenger sides (Fig. 21A & C). The passenger side will also have a vertical cut 1-3/4" in from the edge of the pocket as shown in Figure 21B & D.

Note: This will only need to be done on the front of the rear lower control arm pocket. On the passenger side do NOT cut out the inner most slot as shown in Figure 21D.

FIGURE 21A - DRIVER SIDE REAR

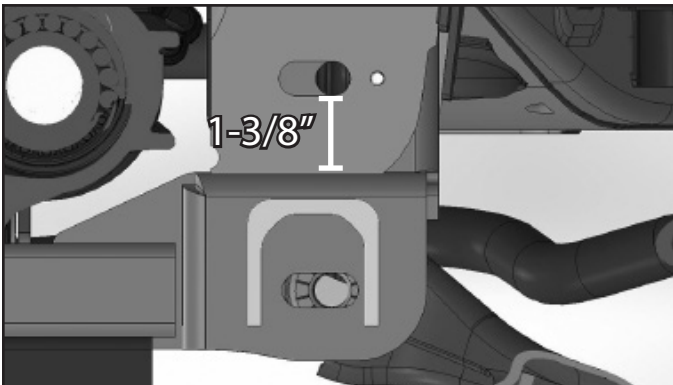

FIGURE 21B - PASSENGER SIDE REAR

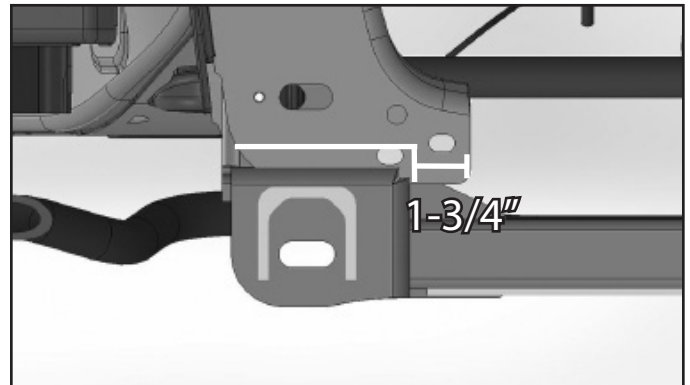
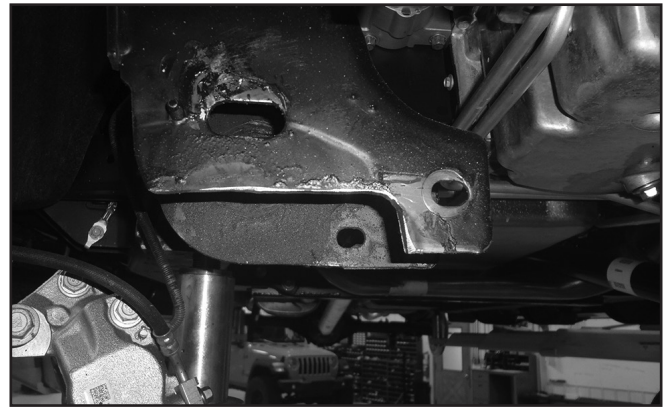

FIGURE 21C - DRIVER SIDE REAR



FIGURE 21D - PASSENGER SIDE REAR



33. The bottom front of the front lower control arm pockets must be cut to provide clearance for the front cross member. This area needs to be cleaned of any oil, grease and/or undercoating. These coatings are flammable.



Tip A putty knife and parts cleaning solvent work well to remove undercoating.

34. Make a line parallel with the bottom edge of the front lower control arm pocket as shown in Figure 22. Trim all the way to the inner edge of the lower control arm pocket.

Note: This will only need to be done on the front of the front lower control arm pocket. Additional grinding may be required on the lower control arm pocket for cross member clearance.

FIGURE 22A

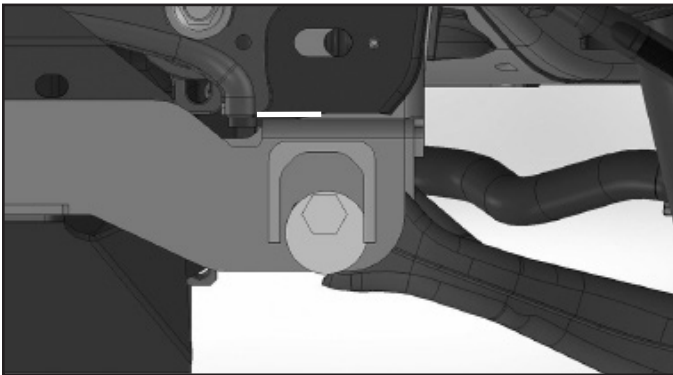
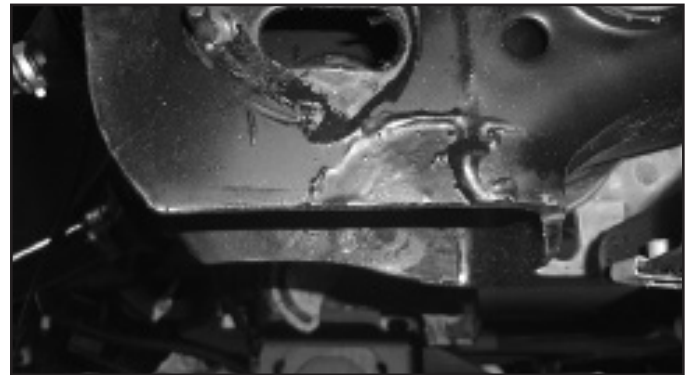

FIGURE 22B



FRONT INSTALLATION

35. Place the provided weld-in plate (03627) up against the cut edge of the control arm pocket. The plate should be flush with the bottom edge of the pocket and overhang the front and back outside surfaces an equal amount. (Fig. 23). Tack weld the plate in place.



Tip Welding should be performed by an experienced welder. Ensure the battery has been disconnected prior to welding. See pre-installation notes at the beginning of these instructions.

FIGURE 23 - SHOWN ALREADY PAINTED



36. With the plate tacked, go back and weld the plate in place. Weld along the OUTSIDE of the pocket on the vertical surfaces. Welding on the inside will result in cross member interference. Weld along the top edge of the plate on the inside of the pocket. Once the area has cooled, paint all exposed metal to prevent corrosion.
37. Install the new driver's side differential bracket (03730) to the original mount with the factory long bolt (Fig. 24A). The bracket will line up with the alignment pin on the front control arm pocket (Fig 24B). Leave hardware loose.



Tip *Install the bracket onto the pin first before installing the bolt into the factory mount.*

FIGURE 24A



FIGURE 24B



38. Install the front cross member (03615) in the control arm pockets with the the provided shorter 18mm bolt, prevailing torque nuts, and washers Run bolts from front to rear (Fig. 25). Leave hardware loose. Make sure to attach the differential bracket to the frame on the driver's side with the provided hardware.



Tip *The hardware for the cross members is located in bolt pack 849.*

FIGURE 25

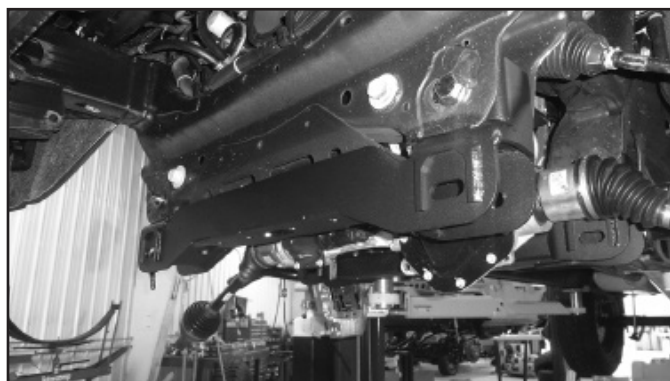

39. Install the new passenger's side differential bracket (03731) to the original mounting location with the new 14mm bolt, 14mm washer, and factory nut (Fig. 26). Snug up hardware, but do not tighten.

 **Tip** *The hardware for the differential drop is located in bolt pack 846.*

FIGURE 26



40. Install the new passenger's side differential brace (03732) to the front of the rear control arm pocket. The bracket will mount to the alignment pin and into the slot from the factory rear cross member. Attach to the passenger's side differential bracket with a 9/16" x 1-3/4" bolt, prevailing torque nut, and washers (Fig 27). Leave hardware loose.

FIGURE 27 - SHOWN WITH DIFFERENTIAL ALREADY INSTALLED

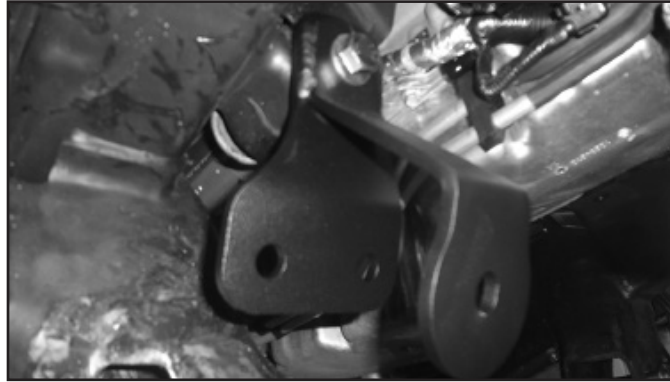
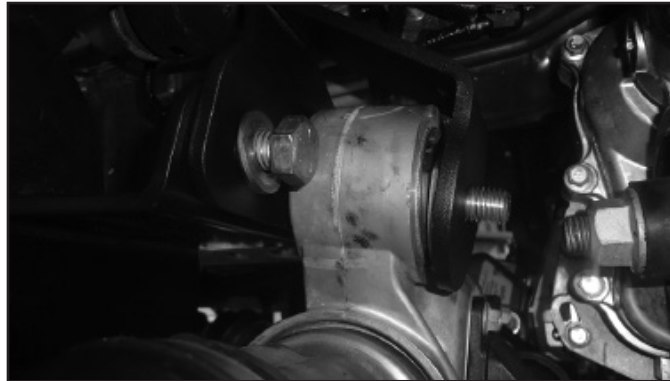

41. Install the provided sleeve through the slot on the factory rear cross member location. Attach the differential brace to the frame with the provided 12mm x 120mm bolt, 12mm prevailing torque nut, and 1/2" washers (Fig. 28). Leave hardware loose.

 **Tip** *The hardware for the differential drop / spacer tube is located in bolt pack 846.*

FIGURE 28

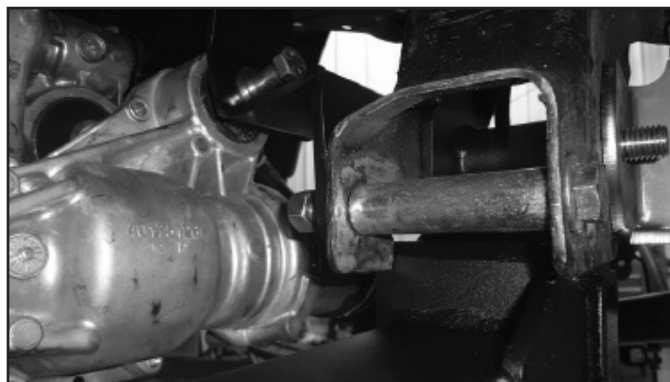

42. Install the differential to the new driver's and passenger's differential brackets. Loosely attach the differential to both differential drop brackets with 9/16" x 4" bolts, prevailing torque nuts, and washers (Fig 29C & D). The passenger's side differential bracket will use a spacer (03622) on the front side between the bushing and the differential bracket (Fig. 29A & B).

 **Tip** Run the passenger's side differential bolt from rear to front as shown in Figure 29D.

 **Tip** When installing the passenger's side differential mount install the spacer (03622; Figure 29B) with the differential into the slotted mount. The spacer takes up the gap created from the flange on the differential mount.

FIGURE 29A - SPACER SHOWN INSTALLED

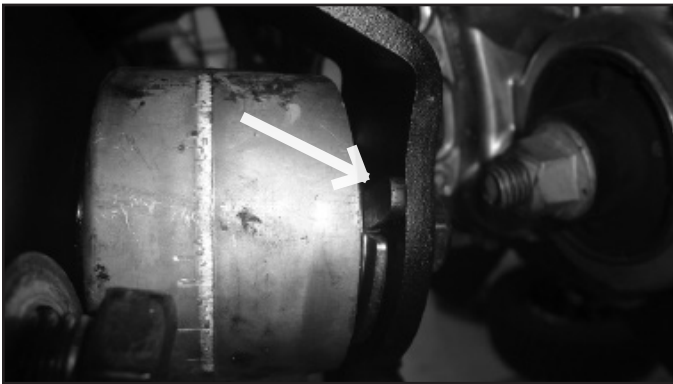

FIGURE 29C- DRIVER SIDE

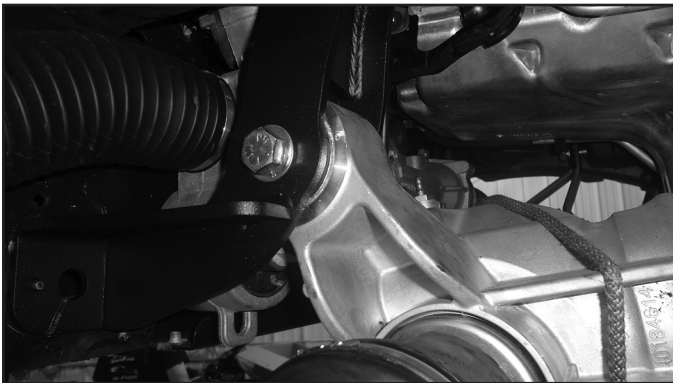

FIGURE 29B

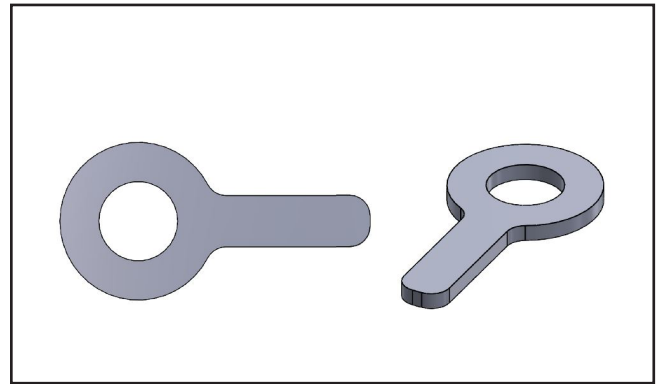
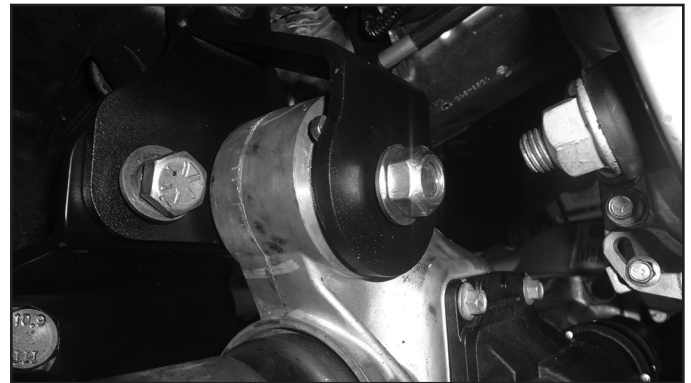

FIGURE 29D - PASSENGER SIDE



43. Install the new rear cross member (03616) with the provided longer 18mm bolt, prevailing torque nuts, and washers. The tabs on the cross member should align with the center diff bracket. Run the bolts from front to rear. Leave hardware loose. Make sure the passenger's side bolt runs through the differential brace. (Fig. 30).

 **Tip** The bolts for the differential may need to be removed one side at a time in order to install the 18mm bolts for the rear cross member. It is also possible with the differential hardware being loose to move the differential out of the way enough to install the 18mm cross member bolts..

FIGURE 30



44. Install the 9/16" x 4" bolts, prevailing torque nuts, and washers in the rear cross member and through the differential mount on the rear cross member (Fig. 31). Leave hardware loose.

FIGURE 31

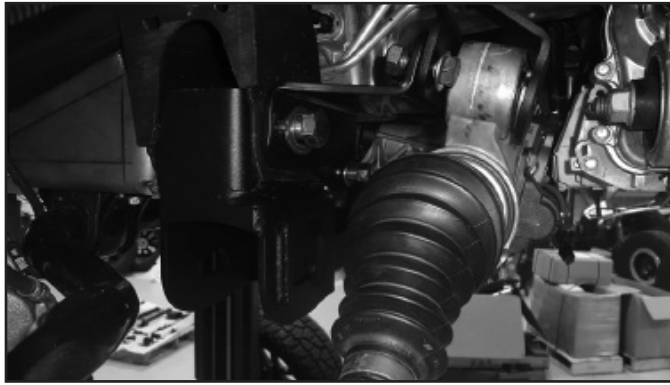

45. Reconnect the differential actuator wiring. Reattach the wire to the differential housing with the factory clips.
46. Reconnect the differential breather line. The line will need to be removed from retaining clips above to gain slack.



Tip *The breather line may need to be accessed through the engine compartment to be rerouted for more slack.*

47. Remove the nut and washer from the back side of the rear cross member bolt. Install the sway bar drop brackets (03617 & 03618) into the 18mm bolt for the rear cross member. Reinstall the nut and washer for the rear cross member bolt. Snug up the sway bar drop bracket to the frame with thread locker and the provided 10mm bolts and washers. Do not tighten the sway bar to frame bolts at this time. (Fig. 32A & B).



Tip *The hardware for the sway bar drop brackets are located in bolt pack 846. Thread locker will dry quickly, make sure up to step 49 is performed in a timely manner to prevent the thread locker from drying.*

FIGURE 32A



FIGURE 32B



48. The badge can now be riveted on to the sway bar drops using the provided 1/8" rivets. Any residue on the badge can be cleaned up using alcohol or brake cleaner before install. With the badge not installed it can be painted to what ever color you desire, or left raw as a stainless steel badge. Avoid damage to the ball joint boots during installation.
49. Install the OE lower control arms in the new cross members with the provided 18mm cam bolts, cam washers, and 18mm prevailing torque nuts. Run the front bolts from front to rear. Run the rear bolts from rear to front. Leave hardware loose. The main body of the cam will be 'up' in the cam slot.



Tip The nuts for the lower control arms are located in bolt pack 849.

50. Tighten all 18mm hardware for the front and rear cross members to 250 ft-lbs. Torque all differential mount hardware: 1/2" hardware to 65 ft-lbs, 9/16" & 14mm hardware to 90 ft-lbs. Torque the 10mm sway bar drop hardware to 45 ft-lbs.



Tip Center the cams for the lower control arms and snug up the nuts, but do NOT tighten the nuts at this time.

51. Reinstall the front drive shaft using the factory hardware and thread locker. Torque the six bolts to 48 ft-lbs.
52. Loosely attach the differential skid plates (03626 & 02175) to the rear cross member with four 1/2" x 1-1/2" bolts and washers in the threaded holes in the cross member.



Tip The hardware for the skid plates is located in bolt pack 847 or 361.

53. Install the front skid plate (03646) to the frame holes with the provided 1/2" x 4" bolt, prevailing torque nut, and washers. Leave hardware loose (Fig. 33). The differential skid plates will sandwich between the front skid plate and front cross member also using 1/2" x 1-1/2" bolts and washer. Use thread locker on all skid plate bolts to the cross members. Tighten all skid plate bolts to 65 ft-lbs (Fig. 33 & 34)

Note: Trail Boss / AT4 the intrusion beam will need to be removed for the front skid plate to be installed.

FIGURE 33



FIGURE 34

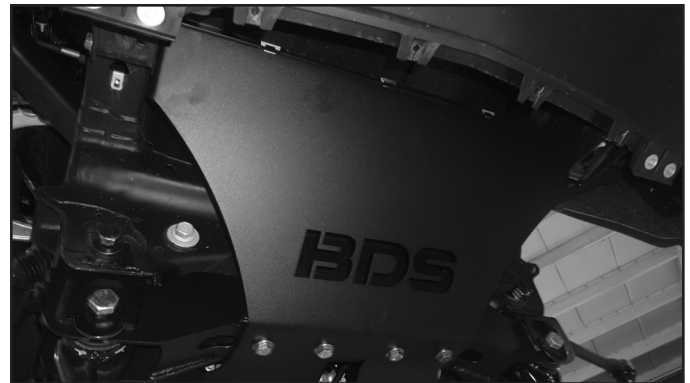

54. **Diesel Models Only:** Install the front skid plate (05014) Attach to the front cross member as shown in Figure 34 with the differential skid plates on the bottom. Attach using 1/2"-13 bolts and 1/2" SAE Washers from Bolt Pack 361. Use thread locker on all skid plate bolts to the cross members. Tighten all skid plate bolts to 65 ft-lbs (Fig. 34). Rivet BDS badge onto skid plate using 3/16" Rivets

FIGURE 34 (DIESEL MODELS ONLY)



55. Remove the hub bearing/rotor assembly and brake dust shield from the factory steering knuckles. Remove the two O-rings on the knuckle. Be sure to note which hub goes on which side of the vehicle. Save mounting bolts.

! Caution *Make sure not to damage the O-rings on removal and installation into the new steering knuckle.*

56. The brake dust shield needs to be trimmed on both the driver and passenger sides. Measure in from the lower vertical edge 1-1/4" and make a cut as shown in Figure 35A. The upper edge will need to be cut at a 45 degree angle as shown in Figure 35B on the upper right side. Figure 35 A & B show the cut to clear the brake caliper. The cuts will be mirror images on the passenger side as to what is shown in the pictures.

💡 Tip *Check for clearance to the brake caliper after installation.*

FIGURE 35A - DRIVER SIDE SHOWN



FIGURE 35B - PASSENGER SIDE SHOWN

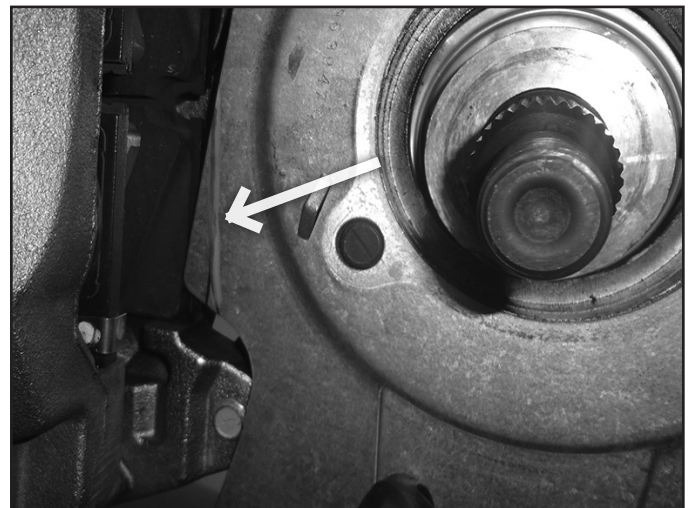

57. Install the modified dust shield on the corresponding new knuckles. Install the two O-rings on the new knuckle. Fasten the hub/shield with the OE bolts. Apply thread locker to the bolt threads and torque to 111 ft-lbs. with a final pass of 30-45 degrees per the factory specification.

CONTROL ARM INSTALLATION

58. Remove the stock upper control arm from the vehicle by removing the two bolts attaching the upper control arm to the strut bucket / frame (Fig. 36). Save hardware. If replacing the upper arm on a Denali truck, remove the sensor arm from the ball stud on the upper control arm.

FIGURE 36

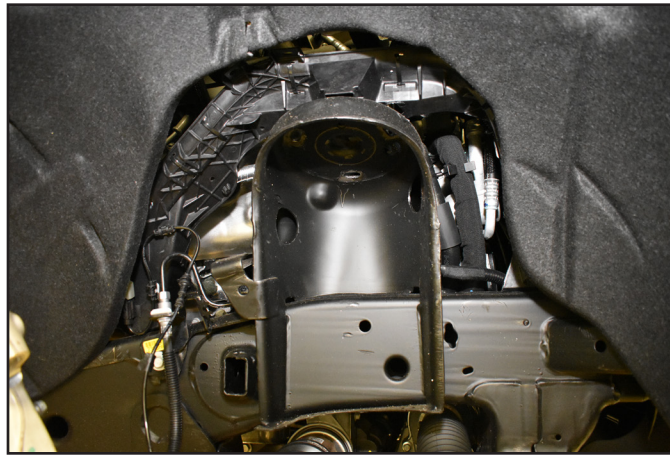

59. The new replacement control arm assemblies have a larger profile than the OEM assemblies. They are also designed with a wider range of available travel. Due to these unique differences, the tab on the side of the strut bucket must be removed to avoid interfering with the proper function of the new control arm assembly. Cut the tab from the side of the strut bucket as shown in Figure 37.

FIGURE 37

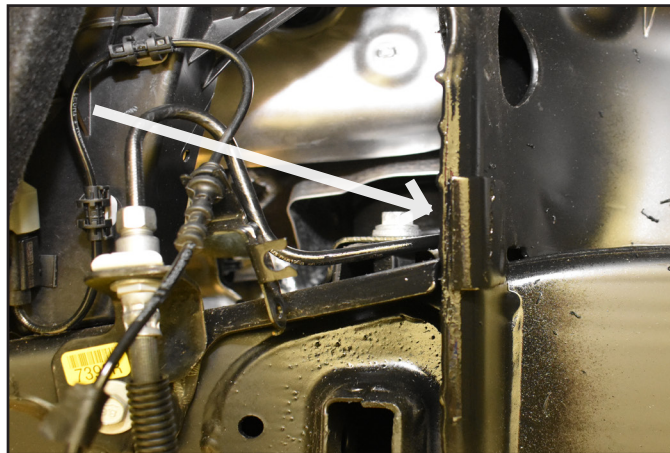

60. Install the new upper control arm to the vehicle using the **new provided 14mm bolts, washers, and nuts from Bolt Pack 640 and using thread locker**. Run the bolt with a washer from the inside out of the strut bucket outwards with a washer and nut on the outer bushing washer surface. Do this for the front and rear control arm mounts. (Fig. 38) Snug up hardware.

FIGURE 38



IMPORTANT

**FAILURE TO FOLLOW
PROCEDURE FOUND
IN STEP 60 CAN
RESULT IN BUSHING
DAMAGE.**

61. Install the CV shaft spacer (05037) on the CV stub shaft with the chamfered edge facing towards the inside of the vehicle (Fig 39A). Install the assembled knuckle on the lower control arm and loosely fasten with the original lower control arm nut (Fig. 39B). Install the CV shaft assembly in the hub, swing the whole assembly up and attach to the new upper control arm to the knuckle assembly using the OE Nylock

Nut. Snug up ball joint using the OE Nylock Nut, but do not torque down. The upper ball joint will be removed from the knuckle later so that the strut can be installed.

Note: The OE nylock nut will only be temporarily used to set the control arm at the correct ride height so that the rubber bushing preload is correct. DO NOT USE THE OE NYLOCK NUT FOR THE FINAL INSTALL.

 **Tip** Assistance may be needed to install the knuckle assembly.

FIGURE 39A

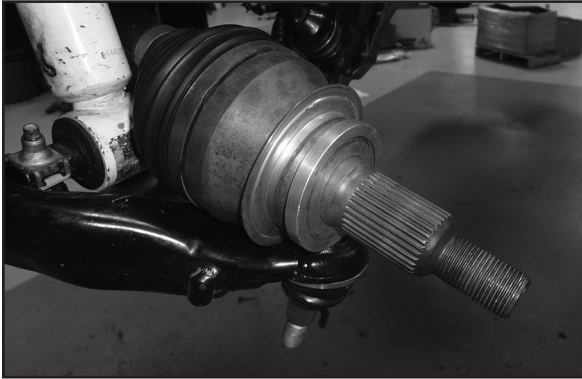
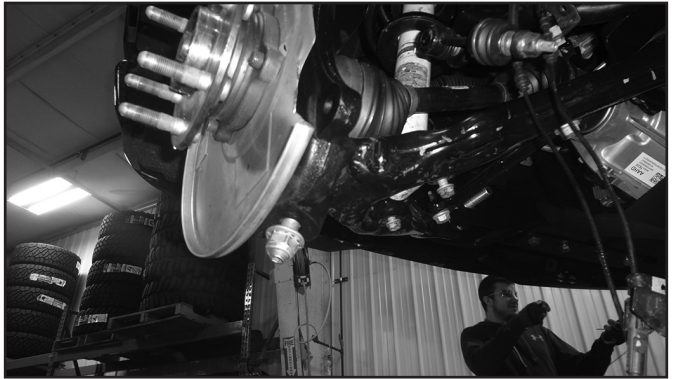

FIGURE 39B



62. Snug up the lower ball joint nut to fully seat the taper. It will be torqued later in the installation.
63. Using a jack, set the ride height from the fender lip to the center of the hub at 28-1/4" for a 6" or 4" Trail BOSS/ AT4 Kits and 26-1/4" for a 4" standard truck. Using a torque wrench on the **inside of the strut bucket** and a **wrench on the outside bushing** to prevent the nut / bushing from moving, tighten the control arm hardware to **126 ft-lbs**. This will ensure the rubber bushings are tightened to the right position and not put preload in the rubber bushings. DO NOT spin the "bushing side" hardware when tightening, only tighten from the inside "frame side".

FIGURE 40A

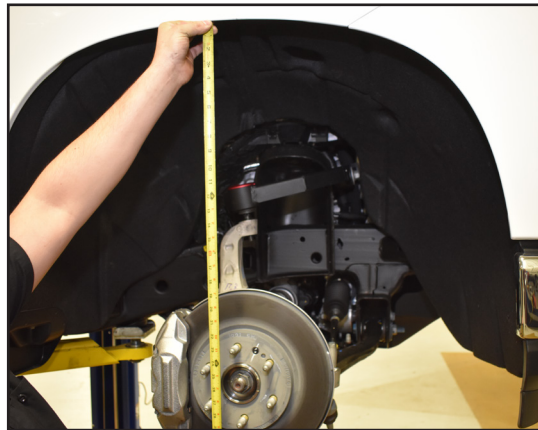
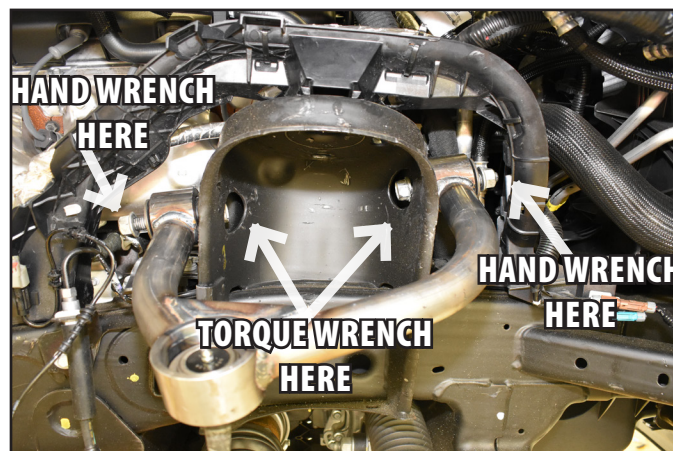

FIGURE 40B



64. Torque the lower ball joint nut to 37 ft-lbs and then a final pass of 125-135 degrees per the factory specification.

STRUT / COILOVER INSTALLATION

If installing coilovers use instructions provided in the coilover box kit.

STRUT SPACER INSTALLATION

65. Install the provided strut spacers on the strut with the provided 10mm prevailing torque nuts and washers. The spacers will only install one way (Fig. 41). Torque hardware to 30 ft-lbs.



Tip *The hardware for the strut spacers is located in bolt pack 629.*

FIGURE 41

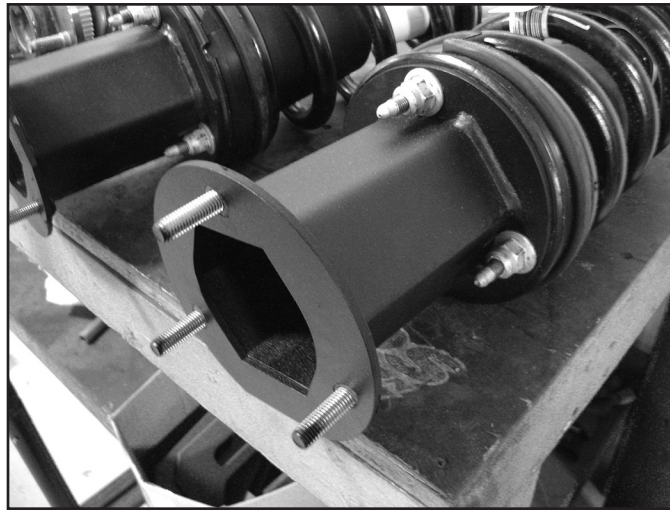

66. Remove the upper ball joint nut and swing the knuckle out of the way. Discard the OE ball joint nut. The lower control arm may need to be lowered to install the new strut assembly. Install the new strut assembly to the appropriate frame and lower mount with the factory hardware. Leave hardware loose.

Note: Be sure that the strut is oriented properly in the vehicle.

FOX 2.0 SNAP RING COILOVER INSTALLATION

67. Place indexing marks on the strut body, strut cap and upper coil seat for reference when the new strut is reassembled. Note the orientation of the bar pin relative to the outside facing upper mounting stud.



Caution *Coil spring is under extreme pressure. Improper removal/installation of coil spring could result in serious injury or death. Use only a high-quality spring compressor and carefully read and follow the manufacturer's instructions.*

68. Using an appropriate strut compressor, compress the coil spring and remove the upper strut nut, save nut for later installation. Remove the strut from the coil spring. Release the pressure from the coil spring and save all of the upper parts for re-installation on the new strut.
69. Remove the OE jounce bumper from the strut. Install the OE jounce bumper on the new Fox 2.0 snap ring coilover in the same orientation as it was on the factory strut.
70. Use the upper snap ring groove for 6" of lift and the lower groove for 4" of lift.

FIGURE 42

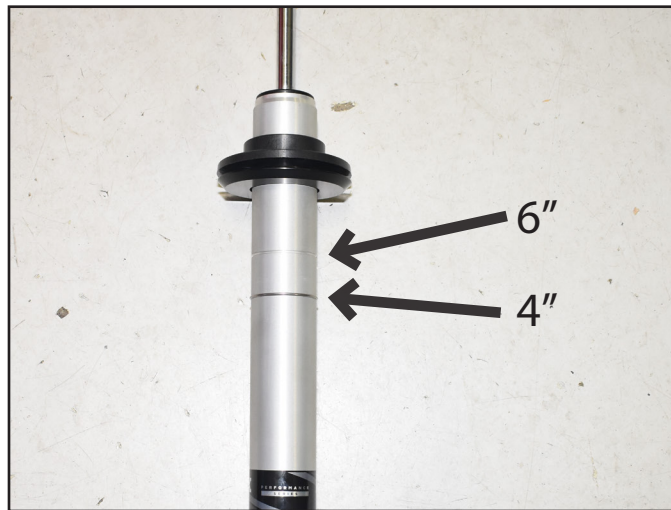

71. Re-install the OE strut cap with the OE coil seat and shroud the same as it was installed on the factory strut. The upper strut cap fits only one way with the OE coil seat. It's easiest to line up your original indexing marks made earlier. Compress the assembly for strut installation.

FIGURE 43

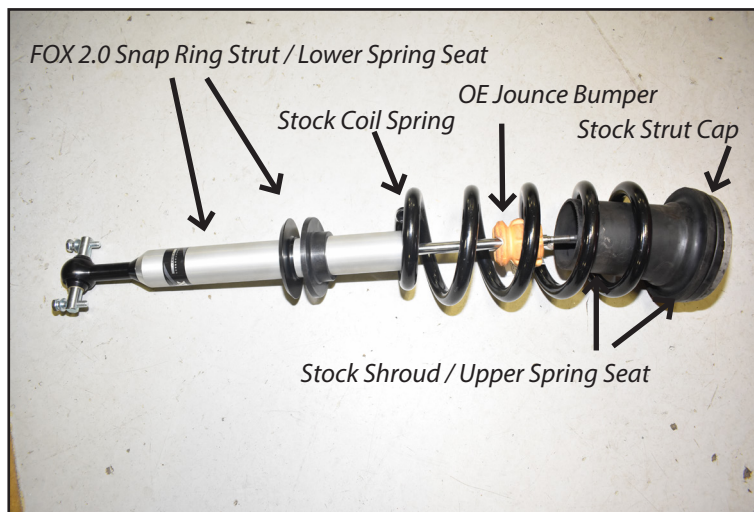

72. Install the new Fox 2.0 snap ring coilover, orienting it the same as the factory one, in the coil spring. Fasten the strut cap with the factory nut. The lower barpin can be rotated to line up with the lower control arm mounting surface. **Torque the strut nut to 22 ft-lbs. Do not overtighten the strut stem.**

! Caution Make sure the coil spring is compressed far enough for the nut to tighten against the cap and is not compressing the coil spring. Improper installation can result in strut stem failure.

73. Remove the upper ball joint nut and swing the knuckle out of the way. Discard the OE ball joint nut. The lower control arm may need to be lowered to install the new strut assembly. Install the new Fox 2.0 Snap Ring Coilover assembly to the appropriate frame mount with the factory hardware. Leave hardware loose.

Note: Be sure that the coilover is oriented properly in the vehicle.

FRONT INSTALLATION CONTINUED

74. Torque the upper strut nuts to 43 ft-lbs. and lower strut bolts to 37 ft-lbs.
75. Reattach the upper ball joint to the knuckle (Fig. 44). **Use the provided nylock nut within bolt pack 874.** Use the jack to support the lower control arm and torque the upper ball joint nut to 26 ft-lbs with the first pass and 60-75 degrees on the final pass.

Note: DO NOT use the OE Nylock Nut.

Denali Models Only: Install the ball stud removed from the factory arm into the replacement BDS arm.

FIGURE 44

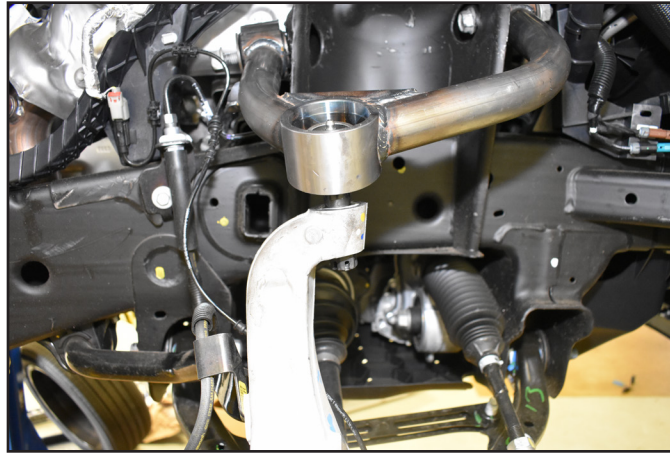

76. Torque the CV axle nut to 185 ft-lbs.



Tip *This may need to be done on the ground with the weight of the vehicle.*

77. Remove the factory tie rod ends and install the new provided tie rod ends. Leave approximately 5/8" of threads showing on the steering link.
78. Attach the ABS wire to the knuckle with the provided wire clamps and 6mm bolts, washers, and thread locker as shown in Figures 45A & B. Figure 45B shows the driver side with the brake sensor wire routing along the knuckle as well. Tighten to 92 in-lbs.



Tip *The hardware for the knuckles is located in bolt pack 847 or 361.*

FIGURE 45A

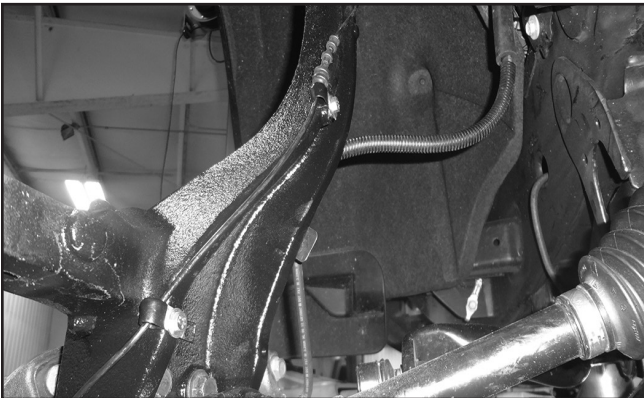
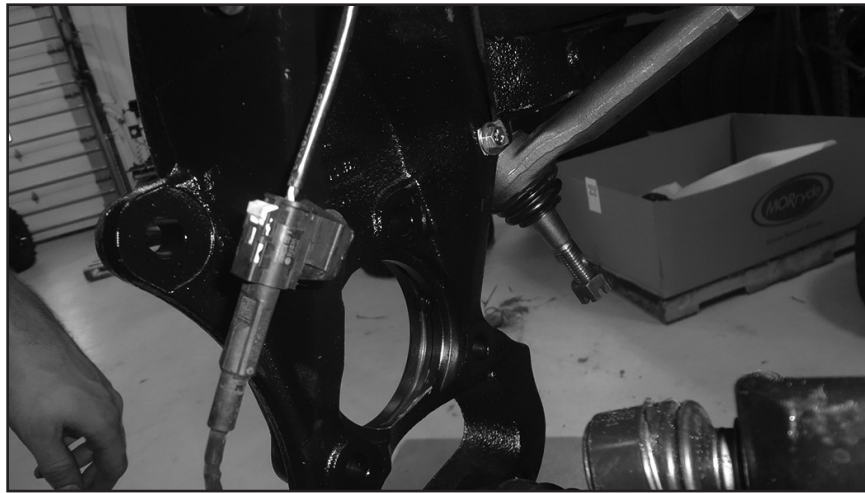

FIGURE 45B



79. Attach the brake sensor plug to the knuckle with the factory bracket and 6mm bolts, washers, and thread locker (Fig. 46). Tighten to 92 in-lbs.

FIGURE 46 - DRIVER SIDE ONLY



80. Attach the caliper to the new steering knuckle with the original mounting hardware and thread locker. Torque bolts to 37 ft-lbs with a final pass of 30-45 degrees per the factory specification.
81. **2019 Models:** Attach the brake line bracket to the knuckle with the provided 6mm bolt, washer, and thread locker (Fig. 47A). **2020+ Models:** Attach the brake line to the knuckle with the provided 6mm bolt, washer, and thread locker and wire clamp (Fig. 48). Cut along the factory brake line bracket and remove it from the vehicle. Be careful not to cut the brake line. Tighten to 92 in-lbs. *Note: The tab on the driver side may need to be cut off to mount to the steering knuckle. (Fig. 47B)*

FIGURE 47A



FIGURE 47B

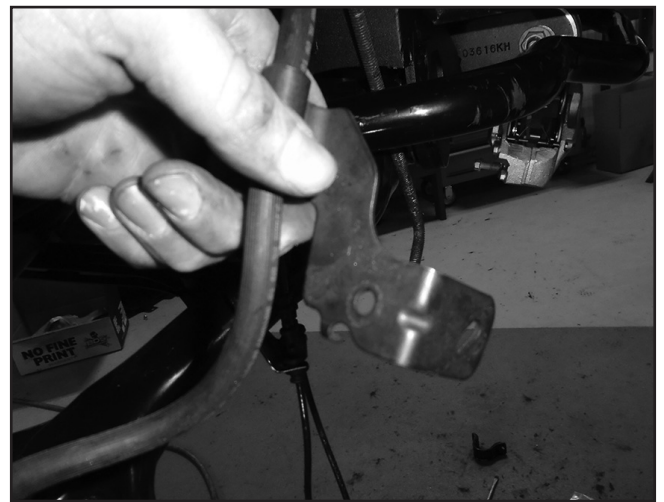

FIGURE 48



82. Reattach the brake wire / ABS wires to the factory position on the knuckle. Use the provided wire clamps and 1/4" bolt to attach the brake wire / ABS wire to the upper control arm. Check for enough slack in the wires and adjust as necessary.
83. Attach the front sway bar to the sway bar drop bracket with the provided 3/8" bolts, prevailing torque nuts, and washers (Fig. 49). Attach the sway bar link to the front control arms. Torque the 3/8" bolts for the sway bar drop to 44 ft-lbs. Torque the sway bar link to the lower control arm to 74 ft-lbs.



Tip The hardware for the sway bar drop is located in bolt pack 422.

FIGURE 49

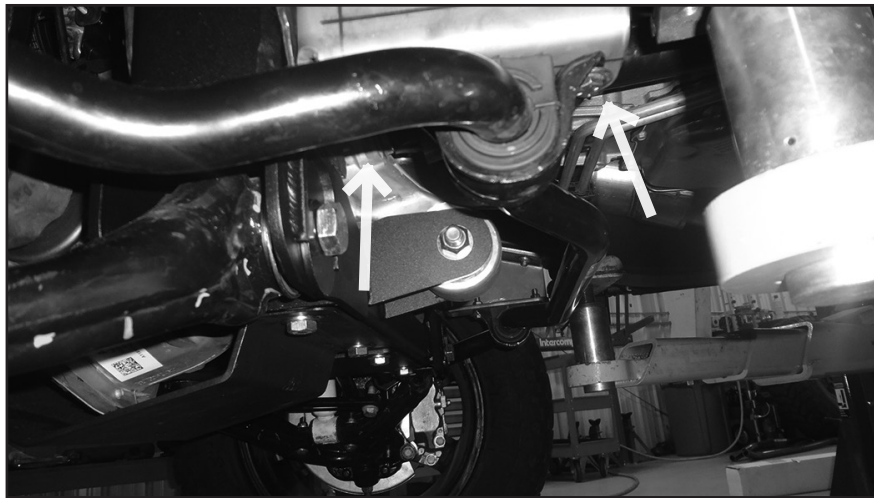

84. Connect the steering tie rod ends to the knuckles with the provided nylock nuts. Torque to 44 ft-lbs. Tighten the tie rod end jam nuts securely. They will be adjusted during alignment. Install the zerk fittings into the tie rod ends.
85. **Diesel Models Only:** Install transmission line drop bracket (01715) to stock location and then attach the transmission line to the stud. Install factory hardware and tighten to 10 ft-lbs. Do not tighten hardware to stud with impact. Torque the transmission line to the drop bracket using 1/4" nut and washer to 5 ft-lbs. See Figure 50 and 51.



Tip Transmission line drop bracket hardware is found in Bolt Pack 361.

FIGURE 50 (DIESEL MODELS ONLY)

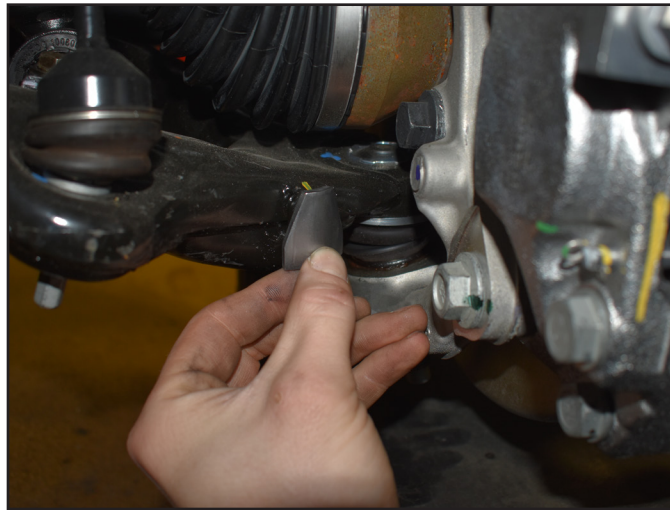

FIGURE 51 (DIESEL MODELS ONLY)



86. Install the wheels/tires and lower the front of the vehicle to the ground. Torque lug nuts to 140 ft-lbs.
87. Bounce the front of the vehicle to settle the suspension. Center the cams and torque the lower control arm mounting bolts to 133 ft-lbs with a final pass of 90-105 degrees per the factory specification.
88. Make sure the upper ball joint is greased at regular maintenance intervals (3-5,000 miles). The grease fitting can be accessed using a flathead screwdriver and removing the cap from the ball joint cup.
89. Install the provided O-ring into the groove on the ball joint cap. Use the provided grease packet to lubricate the O-ring. Snap the ball joint cap into place on the control arm.
90. **OPTIONAL:** Due to control arm clearance and certain size wheel and tire combinations, a steering stop may be required. These are only needed when the tire hits the upper control arm at full lock. Prep the lower control arm for welding, remove paint. Disconnect the battery in the truck to protect electronics.
91. **OPTIONAL:** Weld steering stop on to lower control arm as shown (Fig. 52).

FIGURE 52 (OPTIONAL)



92. Check differential and CV shafts for clearance in all areas including those cut for clearance.
93. Check all hardware for proper torque.
94. If necessary, bleed the entire brake system. See service manual for proper brake system bleeding procedures.
95. Reconnect the battery cables to the battery.

REAR INSTALLATION

1. Block the front wheels. Safely raise the rear of the vehicle and support with jack stands just ahead of the front leaf spring frame mount.
2. Remove the wheels.
3. Support the rear axle with a floor jack.
4. Disconnect the rear brake line bracket from the frame (Fig. 1). Save hardware.

FIGURE 1



5. Remove bolts attaching the ABS lines to the top of the rear differential (Fig. 2).

FIGURE 2

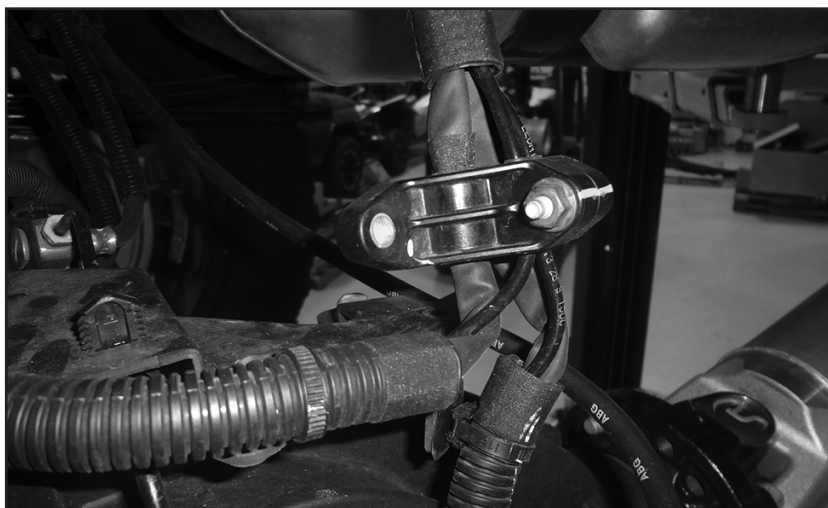

6. Support the center of the axle with a hydraulic jack. Remove the factory shocks from the axle and frame. Save hardware and discard shocks.



Tip AT4X and ZR2 models can have the shock removed from the axle end only and leave connected at the frame end. Save hardware.

7. With the axle still well supported remove the passenger's side u-bolts. The u-bolts will not be reused. If equipped with a rear lift block, remove and discard the block.



Tip If installing the optional add-a-leaf kit 111209, do so now following the instructions included in the kit. This portion of the installation should also be completed one side at a time.

The hole in the factory axle mount may need to be clearanced slightly for proper pin fitment.

5" REAR BLOCK KIT ONLY - 3" REAR BOX KITS SKIP TO BLOCK INSTALLATION

8. Fasten a C-clamp on each side of the leaf spring center pin. With the clamps in place, remove the center pin and discard.
9. Slide the new center pin up through the lower flat overload leaf and top two factory leaves. Remove the factory upper u-bolt plate and install the new u-bolt plate. Install the plate such that the long distance from the hole to the bend is towards the front of the vehicle (Fig. 3).



Tip 2019 Models Only: Make sure the taper shim is installed in the same direction as it was from the factory.

FIGURE 3

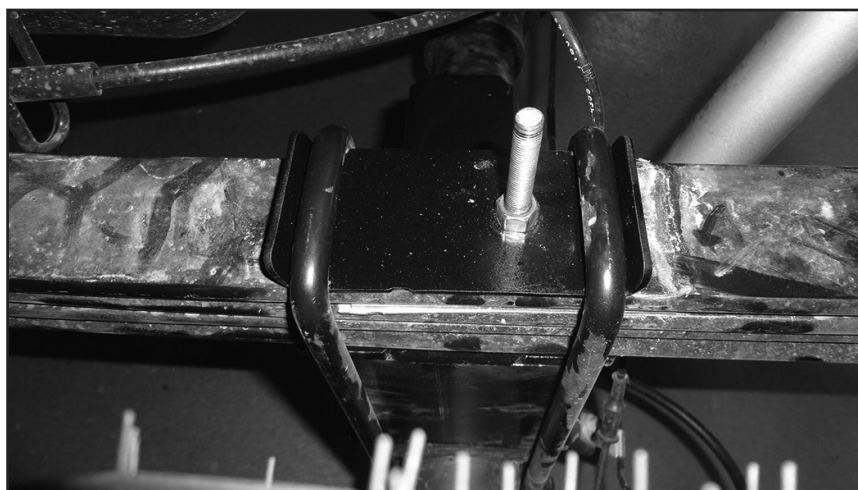

10. Start the nut on the center pin to hold the pack together but do not use the center pin to pull the leaves together. When the pack is completely together, torque the center pin to 30 ft-lbs. Remove the C-clamps.
11. Lower the axle just enough to install the new provided lift block between the axle and the spring. **5" Lift Blocks:** Position the block so the male pin side is forward when compared to the female or top of the block (Fig. 4B). This will assist in shifting the axle forward. **3" Lift Block:** Position the block so the shorter side is towards the front of the vehicle. (Fig. 4C). Align the pin in the block with the hole in the axle and the hole in the block with the leaf spring pin. It may be necessary to loosen the driver's side u-bolts slightly to allow the axle to lower far enough to install the block.
12. Using the support jack, raise the axle so that the axle, spring and block are all touching. Install the new provided u-bolts, nuts and washers allow with the factory u-bolt plate. (Fig. 4A & B) Snug u-bolts but do not tighten.

FIGURE 4A



5" LIFT BLOCK - FIGURE 4B

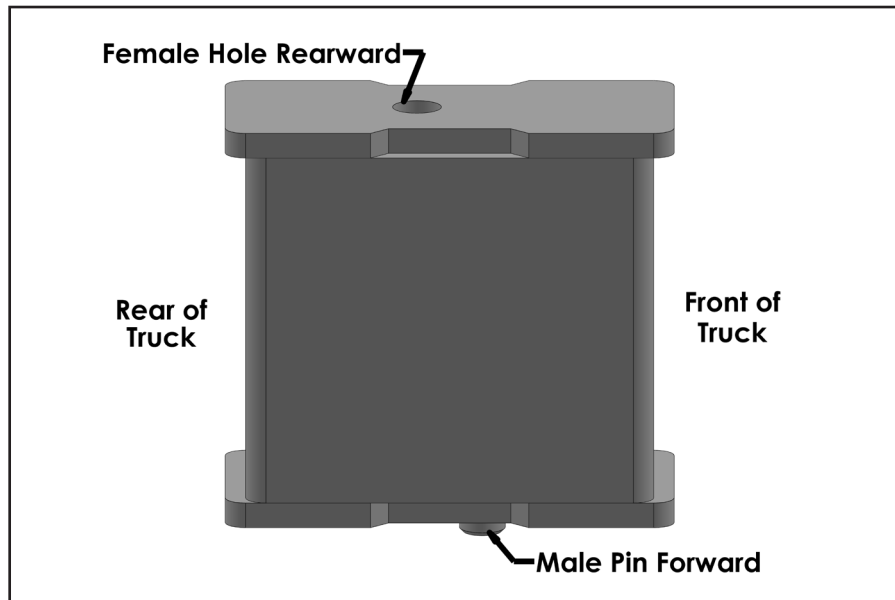

3" LIFT BLOCK - FIGURE 4C

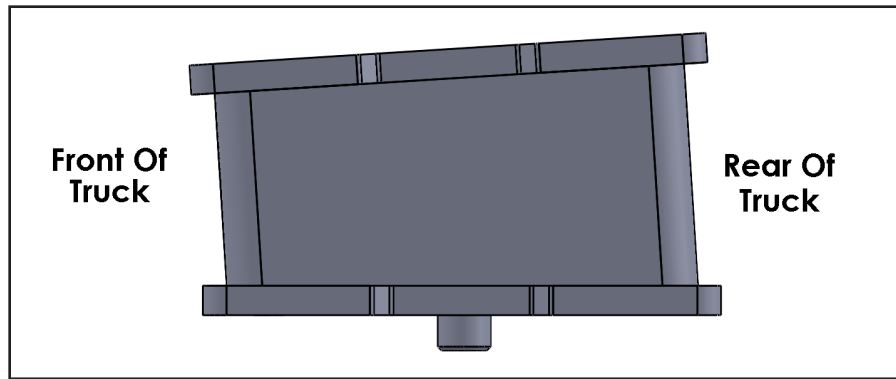

13. Repeat the installation on the driver's side of the vehicle. Pay special attention to all of the brake lines and wires. Do not allow them to get over-extended.
14. Remove the rear rubber bump stops from the frame. Access the bolt head up through the center of bump stop using a 10mm socket. Remove the bump stop and install the provided 3" diameter x 3" tall spacer between the bump stop and the frame mount with a 10mm Allen head bolt and thread locker. Center the spacer on the lip of the factory bump stop cup and torque bolt to 37 ft-lbs. (Fig. 5)



Tip Hardware for the bump stop spacer is located in bolt pack 848.

FIGURE 5



NON AT4X AND ZR2 MODELS ONLY (FOX 2.5 REMOTE RESIVOIR SHOCKS FOLLOWED AT THE END OF THESE INSTRUCTIONS):

15. Locate the new rear shocks. Install the provided bushings and steel sleeves into the eyes of the shocks. Lubricating the bushings and sleeves with some grease will make installation easier.
16. Install the new shocks with stock hardware and torque upper and lower bolts to 60 ft-lbs. The axle mounting tabs may need to be bent open slightly to allow for clearance of the larger diameter shocks.

ZR2 AND AT4X MODELS ONLY:

17. Mark the hole to be drilled for the rear shock relocation bracket (Fig. 6A). See the template at the end of the instructions for hole drilling placement. For reference the hole spacing is 3" (noted in the template).
18. Drill the hole out to 9/16" through both sides of the rear shock mount. Be sure the holes are concentric with each other since a bolt will be inserted through both holes (Fig. 6B).

FIGURE 6A

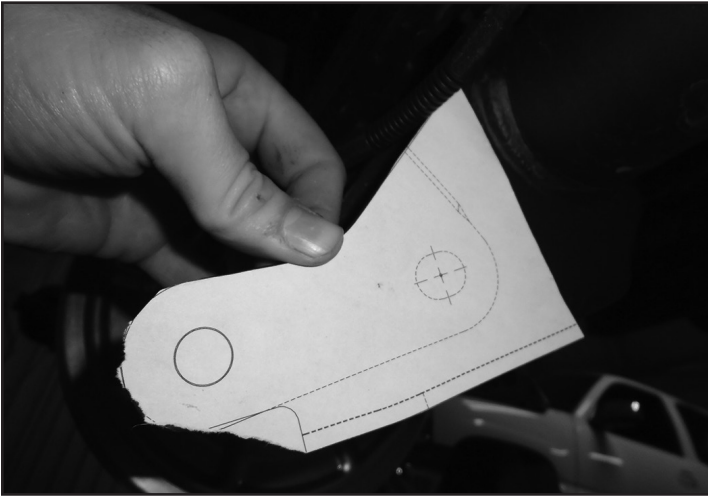
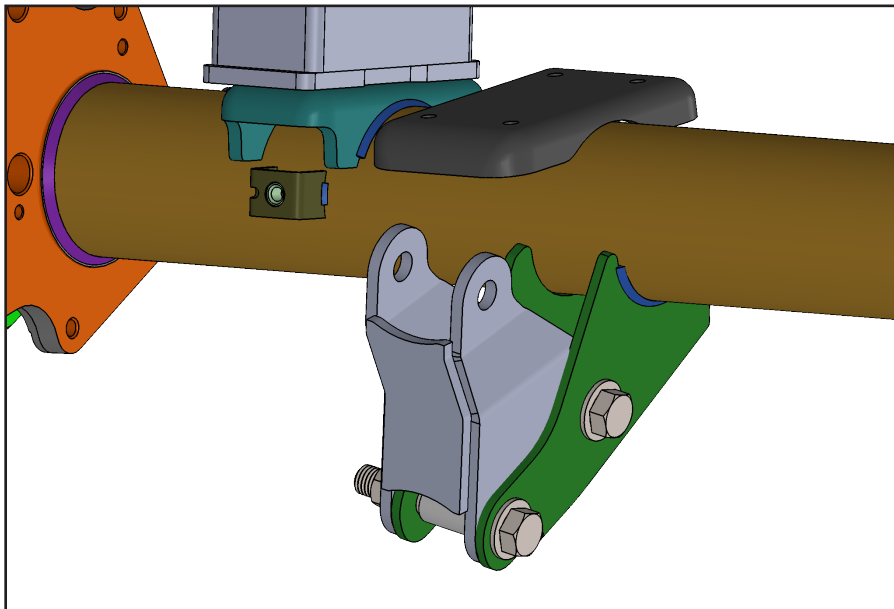

FIGURE 6B



19. Install the provided rear shock relocation bracket with the provided sleeves and 9/16" hardware in the factory shock location and the new hole drilled in the previous step. The bracket should offset the factory bracket to the outside of the vehicle (Fig. 7).

FIGURE 7



20. If removed, reinstall the rear Multimatic shock in the factory upper mount and the upper mount on the rear shock relocation bracket with the factory hardware. Torque all 9/16" and factory hardware to 60 ft-lbs.

ALL MODELS:

21. Install the provided brake line bracket on the frame using the factory mounting hole and factory bolts. The bracket will offset away from the frame and towards the front of the vehicle. Attach the factory brake line bracket to the relocation bracket with two 5/16" x 1" bolt, prevailing torque nut, and washers. Torque the factory and 5/16" bolts to 15 ft-lbs. (Fig. 8)



Tip Hardware for the brake line bracket is located in hardware pack 848. Install the bracket with the notch up.

FIGURE 8

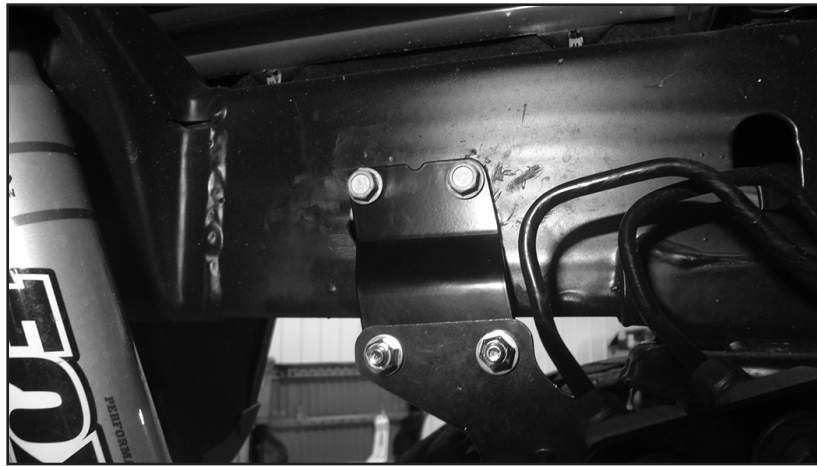

22. Install the provided ABS line bracket to the top of the rear differential using the factory mounting hole and factory bolts. The bracket will rotate the ABS line 90 degrees facing up. Attach the ABS line bracket to the relocation bracket with two 1/4" x 1" bolt, prevailing torque nut, and washers. Torque the factory and 1/4" bolt to 8 ft-lbs. (Fig. 9)



Tip Hardware for the ABS line bracket is located in hardware pack 848.

FIGURE 9

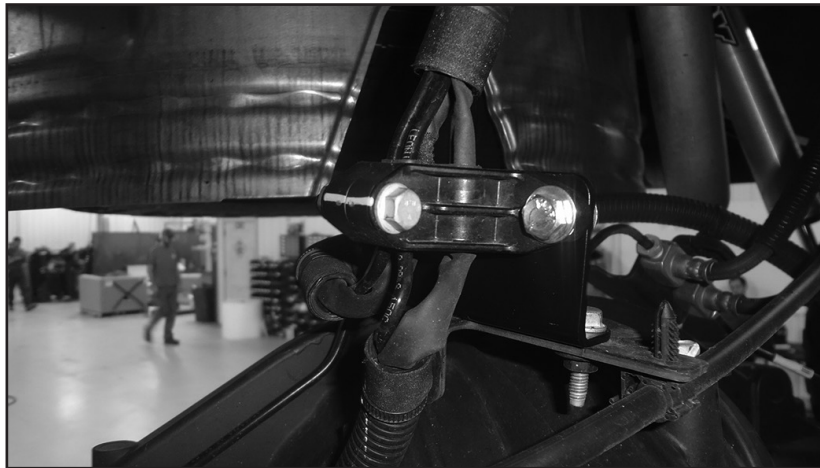

23. Install wheels and tires. Lower the vehicle to the ground. Torque lug nuts to 140 ft-lbs.
24. Bounce the rear of the vehicle to settle the suspension. Torque leaf spring u-bolts to 100-120 ft-lbs.

POST INSTALLATION

25. Double check all fasteners for proper torque.
26. Check all moving parts for clearance.
27. Complete a full radius turning check to ensure that no interference occurs.
28. Align headlights
29. Double check the brake lines for adequate slack at full wheel travel.
30. Complete a vehicle alignment.
31. GM Owners manual required service every 7,500 miles to visually inspect steering, suspension, and chassis components for damage, including cracks or tears in the rubber boots, loose or missing parts, or signs of wear at least once a year. Specifically check upper and lower ball joint, CV axles, driveshaft boots, and universal joints.
32. Check all fasteners after 500 miles.



WE WANT TO SEE YOUR RIDE!

Grab photos of your BDS-equipped truck in action and send them in for a chance to be featured. Send it in to our Bad Ass Rides customer gallery at bds-suspension.com/bar and post them on the BDS Fan Page on Facebook at facebook.com/BDSSuspensions. Don't forget about your BDS swag! BDS offers t-shirts, hoodies, decals and more available on the BDS website or through your local BDS distributor.

TIME TO HAVE SOME FUN

Thank you for choosing BDS Suspension.

For questions, technical support and warranty issues relating to this BDS Suspension product, please contact your distributor/installer before contacting BDS Suspension directly.

ZR2 / AT4X DRILLING TEMPLATE

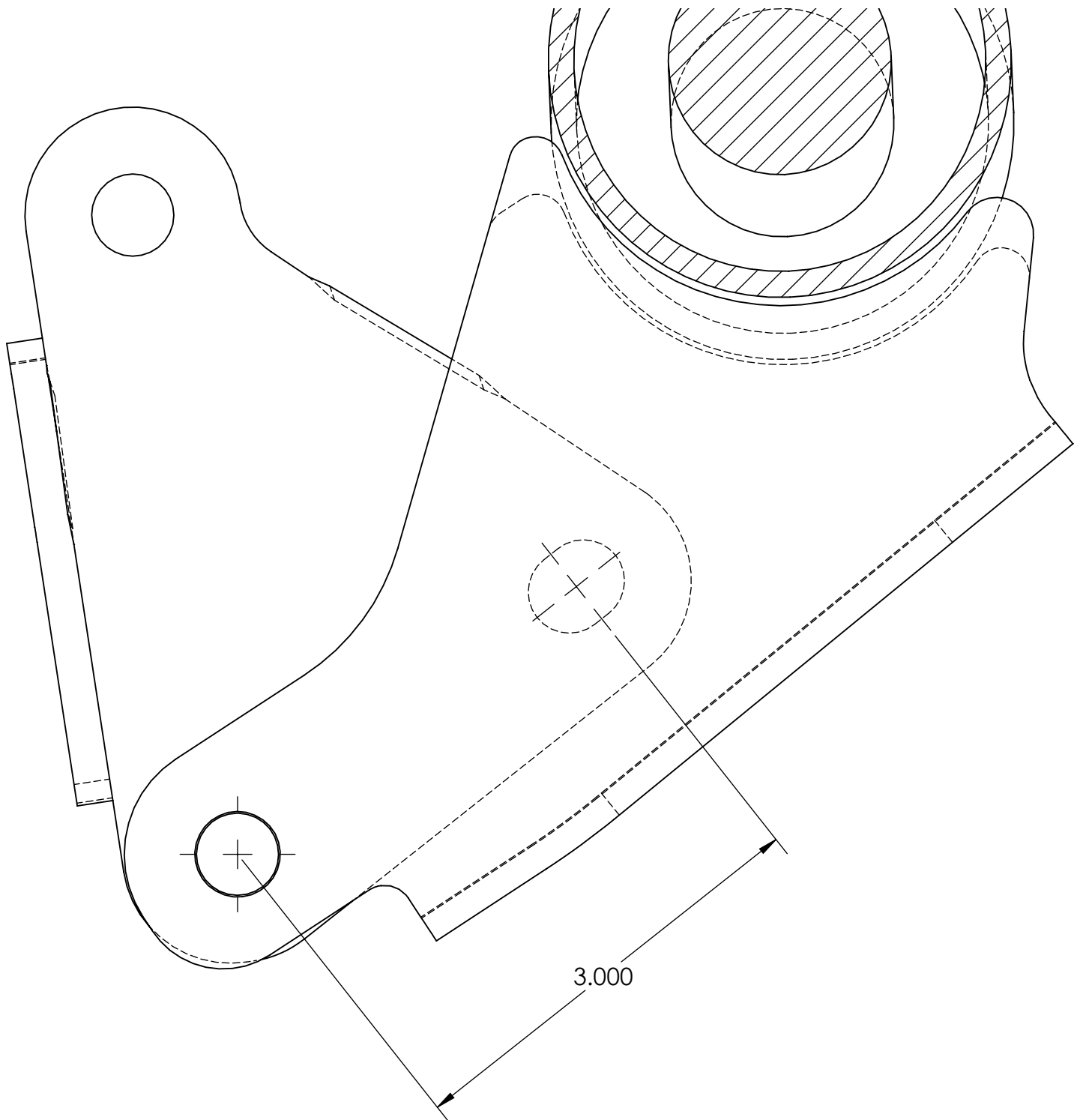

2019-21 GM 1500 4WD LIFT SYSTEM

TORQUE SPECIFICATIONS

COMPONENT	TORQUE (FT-LBS)
18mm Crossmember Bolts	250
1/2" Differential Hardware	65
9/16" or 14mm Differential Hardware	90
10mm Sway Bar Drop	45
Driveshaft Bolts	48
Differential Skid Plate Hardware	45
Strut Spacer to Strut Nut	30
Hub Bolts	111 + Final Pass 30-45 Degrees
Upper Ball Joint Nut	26 + Final Pass 60-75 Degrees
Lower Ball Joint Nut	37 + Final Pass 125-135 Degrees
CV Axle Nut	185
Strut Spacer to Frame Nuts	40
Strut to Lower Control Arm	37
ABS Wire / Brake Line Brackets / 6mm Knuckle Hardware	92 In-lbs
Brake Caliper Bolt	37 + Final Pass 30-45 Degrees
ABS Wire / Brake Line Wire to UCA	92 In-lbs
Sway Bar to Drop Bracket	44
Sway Bar Link to Lower Control Arm	74
Tie Rod to Steering Knuckle	44
ARC Sensor to Frame (Denali Only)	92 In-lbs
Wheels / Tires	140
Lower Control Arm Cam Bolts	133 + Final Pass 90-105 Degrees
Upper Control Arm	148
Rear Bump Stop Spacer	37
Center Pin Nut	30
Shock Spacer (Denali Only)	60
Rear Shocks	65
Rear Brake Line Bracket (5/16" / 8mm Hardware)	15
Rear ABS Line Bracket (1/4" / 6mm Hardware)	8
U-Bolts	100-120

FOX 2.5 REMOTE RESIVOIR REAR SHOCK INSTALLATION INSTRUCTIONS

1. For remote reservoir applications, FOX highly recommends raising the rear of the bed of the vehicle $\frac{3}{4}$ " to prevent damage to the reservoir during the installation of the rear shocks. The reservoirs can be installed without raising the bed, however it is difficult and can cause cosmetic damage to the remote reservoirs on the shocks.
2. On 70-inch, short bed models, the bed is attached to the frame of the vehicle using (6) six bolts, (4) four rear bolts and (2) two front bolts (Fig. 1). Longer beds may have more bolts attaching the bed to the frame

FIGURE 1

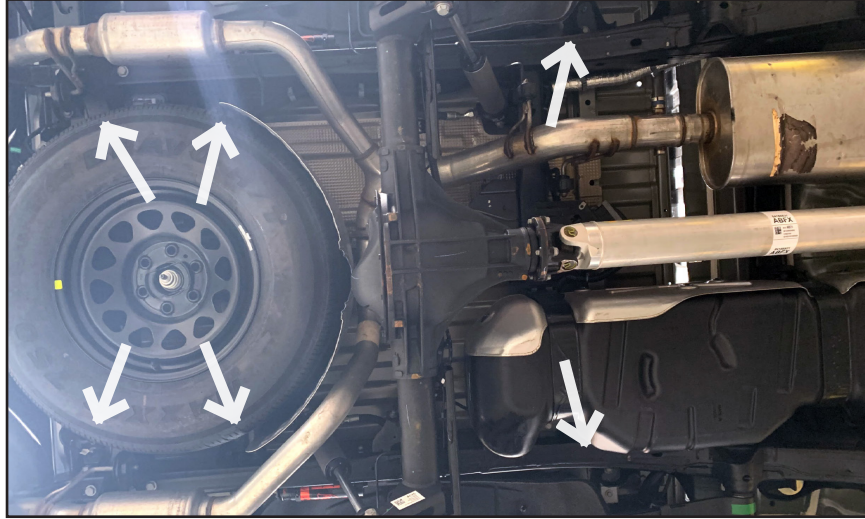

3. Remove the rear bolts attaching the bed of the truck to the frame. DO NOT discard bolt bolts, as they will be used to reinstall the bed (Fig. 2).

FIGURE 2



4. Loosen the (2) most forward bolts of the bed. DO NOT remove. These bolts keep the bed aligned while you lift the rear of the bed to slide the reservoirs between the bed and the frame rail (Fig. 3).

FIGURE 3



5. Once bed bolt removal is complete, slowly lift the rear of the bed from underneath the bed plate (Fig. 4). Lift the bed $\frac{3}{4}$ " from the frame rail (Fig. 5). DO NOT lift the bed from underneath the bedside as this may cause damage to the bedside. Be sure to check that the bed does not contact the cab of the truck as this could cause damage to the bed and the cab of the vehicle (Fig. 6).

FIGURE 4

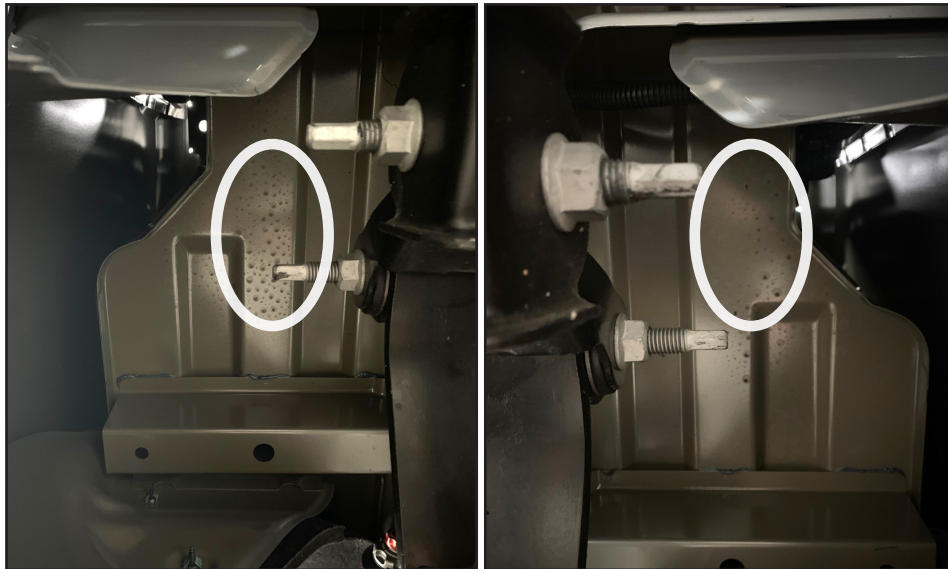
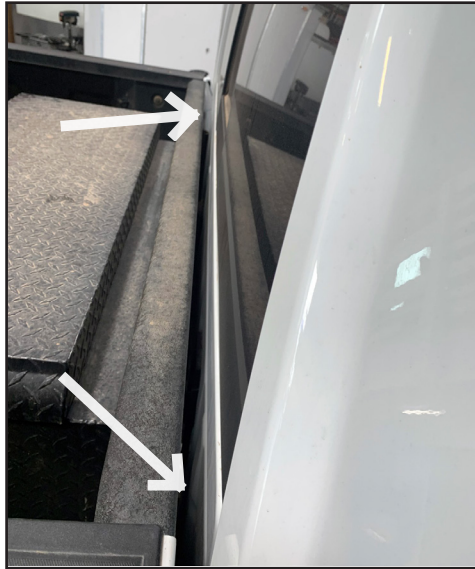

FIGURE 5



FIGURE 6



6. Make sure to identify which shock goes on the correct side (Fig. 7). The driver side is shown on the left and the passenger side is shown on the right.

FIGURE 7



7. Once the rear of the bed has been lifted off the frame, you can now slide the remote reservoirs between the bed (Fig. 8).

FIGURE 8



8. Once the reservoirs have been slid between the frame and the bed of the vehicle, slowly lower and reattach the bed to the vehicle using the OEM hardware. Torque the box hardware to 63 ft-lbs.
9. Using the OEM hardware install the upper and lower portions of the shocks on both sides of the vehicle. Tighten the upper and lower shock hardware to 70 ft-lbs.

10. You must trim the fender liners on both sides of the vehicle as shown in Figure 9 for the reservoirs to fit correctly. The suggested shape of the trimming follows the curvature of the forward most fender liner, continues just below the 2 screws and then back to the rear of the fender liner.

FIGURE 9



11. The remote reservoirs mount to the vehicle using supplied mounting brackets toward the back of the vehicle in the wheel arch (Fig. 10). The left image in Figure 9 is the driver side and right image is the passenger side.

FIGURE 10



12. To install the rear reservoir brackets, you must drill a 7/32" hole that is 7" away from the edge of the OEM bump stop mount toward the rear of the vehicle and 3-3/4" above the bottom of the frame rail (Fig. 11).

FIGURE 11

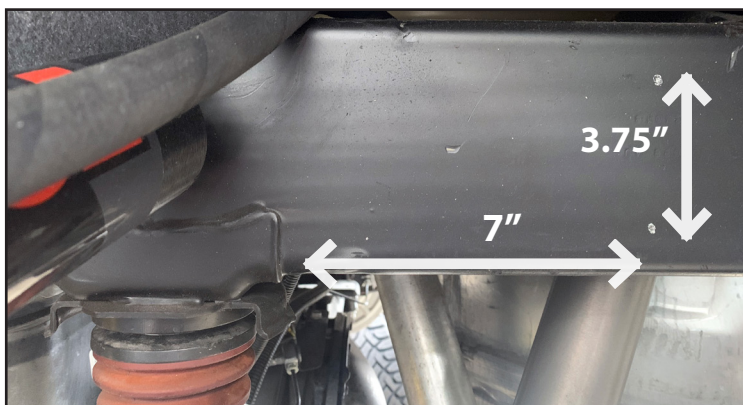

13. Install the bracket using one of the 1/4" self-tapping screws to partially install the reservoir bracket. Ensure that you mount the bracket so that the forward most hole is the side that has the screw installed (Fig. 12).

FIGURE 12



14. Using the bracket as a guide, drill a 7/32" hole through the rear most hole of the reservoir bracket. Install the remaining 1/4" self-tapping screw to fully install the reservoir bracket. There should be (2) two self-tapping screws in each bracket (Fig. 13).

FIGURE 13



15. Repeat reservoir installation steps on both sides of the vehicle.
16. Using two supplied billet clamps and screws, mount the reservoir to the brackets. Utilize the slots in the bracket to locate clamps. Do not feed the clamps through the slots in the brackets. Torque the (4) four socket head cap screws to 19 in-lbs. (Fig. 14). Repeat on both sides of the vehicle.

FIGURE 14

