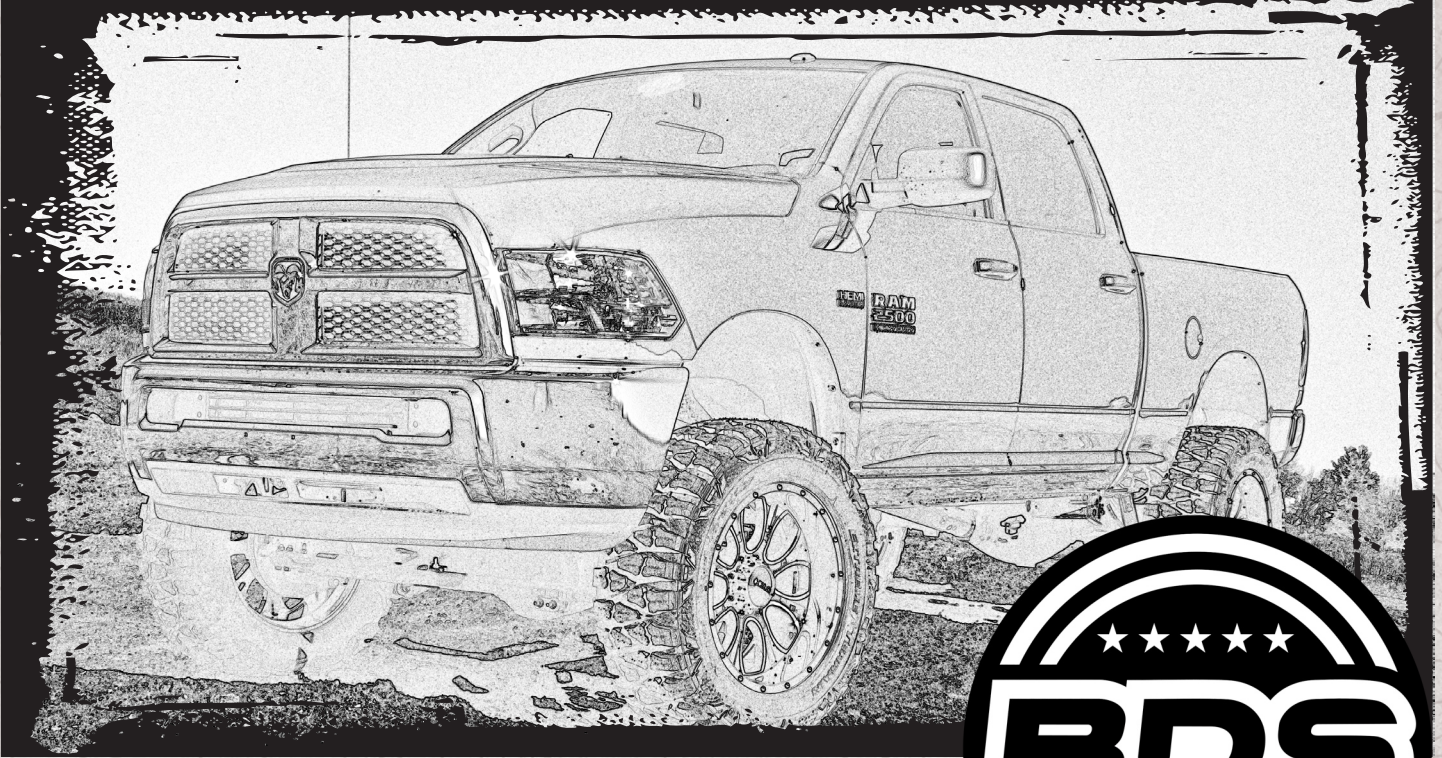


# INSTALLATION GUIDE



Part#: 012129

**HARDCORE LIMITED LIFETIME WARRANTY**

## 1.25" Rear Spring Spacer Kit

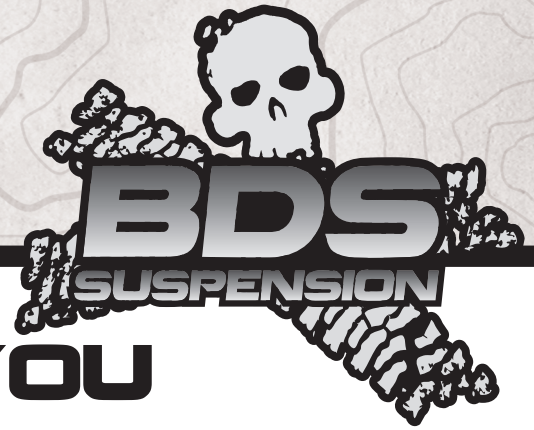
**Dodge 2500 Pickup | 2014-2015**

Rev. 091318

491 W. Garfield Ave., Coldwater, MI 49036 • Phone: 517-279-2135

Web: [www.bds-suspension.com](http://www.bds-suspension.com) • E-mail: [tech-bds@ridefox.com](mailto:tech-bds@ridefox.com)

# Read And Understand All Instructions And Warnings Prior To Installation Of System And Operation Of Vehicle.



## THANK YOU

Your truck is about to be fitted with the best suspension system on the market today. That means you will be driving the baddest looking truck in the neighborhood, and you'll have the warranty to ensure that it stays that way for years to come. Thank you for choosing BDS Suspension!

### BEFORE YOU START

BDS Suspension Co. recommends this system be installed by a professional technician. In addition to these instructions, professional knowledge of disassembly/ reassembly procedures and post installation checks must be known.

### FOR YOUR SAFETY

Certain BDS Suspension products are intended to improve off-road performance. Modifying your vehicle for off-road use may result in the vehicle handling differently than a factory equipped vehicle. Extreme care must be used to prevent loss of control or vehicle rollover. Failure to drive your modified vehicle safely may result in serious injury or death. BDS Suspension Co. does not recommend the combined use of suspension lifts, body lifts, or other lifting devices. You should never operate your modified vehicle under the influence of alcohol or drugs. Always drive your modified vehicle at reduced speeds to ensure your ability to control your vehicle under all driving conditions. Always wear your seat belt.

### BEFORE INSTALLATION

Special literature required: OE Service Manual for model/year of vehicle. Refer to manual for proper disassembly/reassembly procedures of OE and related components.

Adhere to recommendations when replacement fasteners, retainers and keepers are called out in the OE manual.

Larger rim and tire combinations may increase leverage on suspension, steering, and related components. When selecting combinations larger than OE, consider the additional stress you could be inducing on the OE and related components.

Post suspension system vehicles may experience drive line vibrations. Angles may require tuning, slider on shaft may require replacement, shafts may need to be lengthened or trued, and U-joints may need to be replaced.

Secure and properly block vehicle prior to installation of BDS Suspension components. Always wear safety glasses when using power tools.

If installation is to be performed without a hoist, BDS Suspension Co. recommends rear alterations first.

Due to payload options and initial ride height variances, the amount of lift is a base figure. Final ride height dimensions may vary in accordance to original vehicle attitude. Always measure the attitude prior to beginning installation.



Visit [560plus.com](http://560plus.com) for more information.

### BEFORE YOU DRIVE

Check all fasteners for proper torque. Check to ensure for adequate clearance between all rotating, mobile, fixed, and heated members. Verify clearance between exhaust and brake lines, fuel lines, fuel tank, floor boards and wiring harness. Check steering gear for clearance. Test and inspect brake system.

Perform steering sweep to ensure front brake hoses have adequate slack and do not contact any rotating, mobile or heated members. Inspect rear brake hoses at full extension for adequate slack. Failure to perform hose check/ replacement may result in component failure. Longer replacement hoses, if needed can be purchased from a local parts supplier.

Perform head light check and adjustment.

Re-torque all fasteners after 500 miles. Always inspect fasteners and components during routine servicing.

# CONTENTS OF YOUR KIT

<b>Spacer Box Kit</b>		
<i>Part #</i>	<i>Qty</i>	<i>Description</i>
02497	1	Rear Track Bar Bracket
145	1	Track Bar Bracket Sleeve (2-1/8" long)
826	1	Bolt Pack - Rear Track Bar Bracket
	1	9/16"-12 x 4" bolt - grade 8
	2	9/16" SAE Thru-hardened washer
	1	9/16"-12 Prevailing torque nut
	1	3/8"-16 x 1-1/2" bolt - grade 8
	1	3/8" SAE Washer
	1	3/8"-16 Serrated edge flanged nut
	1	7/16"-14 x 1-1/2" bolt - grade 8
	2	7/16" SAE thru hardened washer
	1	7/16"-14 Prevailing torque nut
02790	2	1-1/4" Rear Coil Spacer
422	1	Bolt Pack
	4	3/8"-16 x 4" bolt
	4	3/8" USS flat washer
	8	3/8"-16 Prevailing torque nut
02817	2	Rear Bump Stop
796	1	Bolt Pack - Rear Bump Stop
	4	10mm-1.50 x 55mm bolt
	4	10mm washer - clear zinc
911121	2	12" Sway Bar Link
M00475-bk-01	4	Spherical bushings
144	4	3/4" x 1/2" ID x 1.255 DOM sleeve
7608	4	Grease Zerk w/ Check Ball
795	1	Bolt Pack - Rear Sway Bar
	4	12mm-1.75 x 65mm bolt - class 10.9
	8	7/16" USS washer
	4	12mm-1.75 Prevailing torque nut
	4	12mm-1.75 x 65mm bolt
	8	7/16" USS washer - clear zinc
	4	12mm-1.75 Prevailing torque nut - clear zinc

# INSTALLATION INSTRUCTIONS

## INSTALLATION INSTRUCTIONS

1. Park vehicle on clean flat and level surface. Block front wheels for safety.
2. Disconnect the rear trackbar from the axle, retain all hardware. (Fig 1)

## SPECIAL TOOLS

1/2" Drill

*Tip: You may need to detach the vent hose clip from the track bar bracket to prevent the nut tab from puncturing the vent hose.*

**FIGURE 1**



3. Raise rear of vehicle and support frame rails with jack stands.
4. Remove the rear wheels.
5. Support the rear axle with a hydraulic jack.
6. Disconnect the rear sway bar links from the frame and sway bar. (Fig 2)

**FIGURE 2**



7. Disconnect the rear shocks and lower the axle, retain hardware. On the driver's side it is easiest to access the top hardware by cutting the inner fender well as shown. This trim procedure is not required but greatly aids in removal and installation of the shock. (Fig 3a, 3b)
8. Remove the rear coil springs and upper and lower coil spring retainers.

**FIGURE 3A**

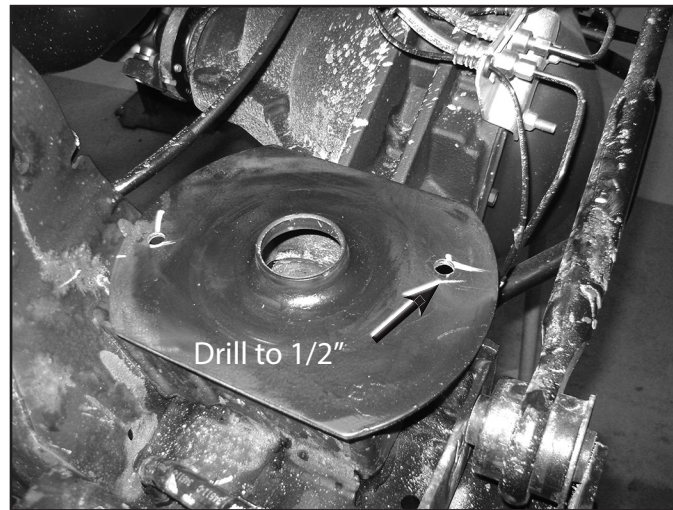


**FIGURE 3B**



9. Locate the holes in the rear lower coil mount. Clearance the rear most hole on the driver's side to 1/2" to accept larger hardware, the remaining 3 holes will accept 3/8" hardware. (Fig. 4)

**FIGURE 4**



10. Install the rear coil spacers with 3/8" hardware (BP 422) except at Driver's Rear location, this will attach with the trackbar hardware. Tighten 3/8" hardware to 35 ft-lbs.

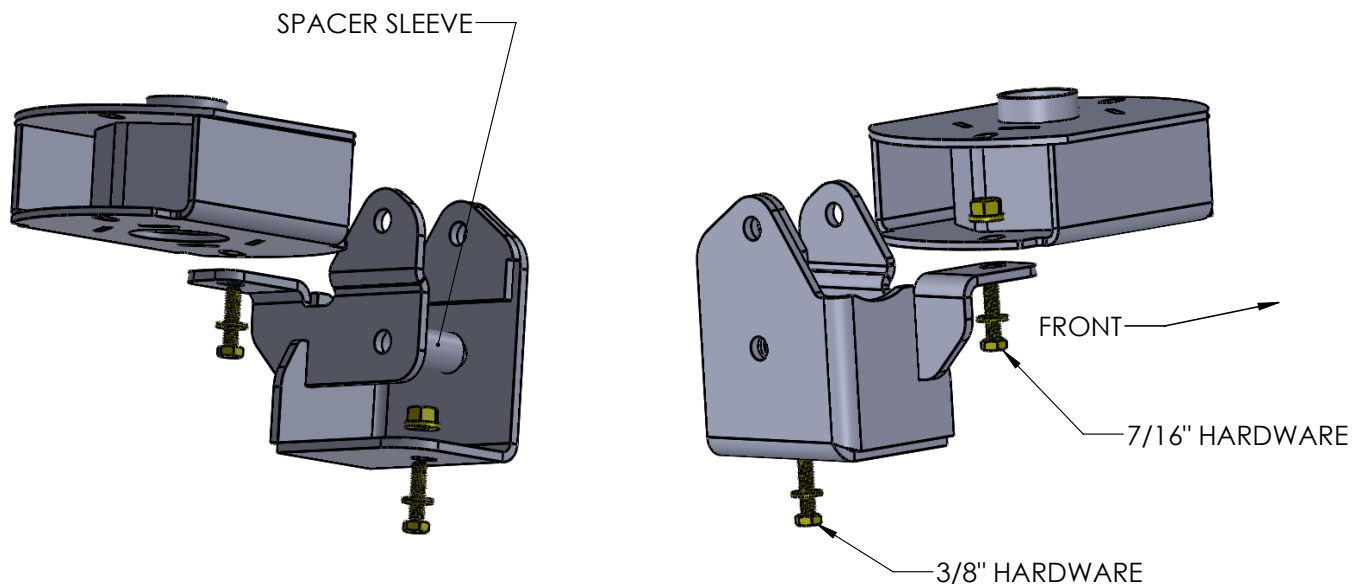


**Tip**

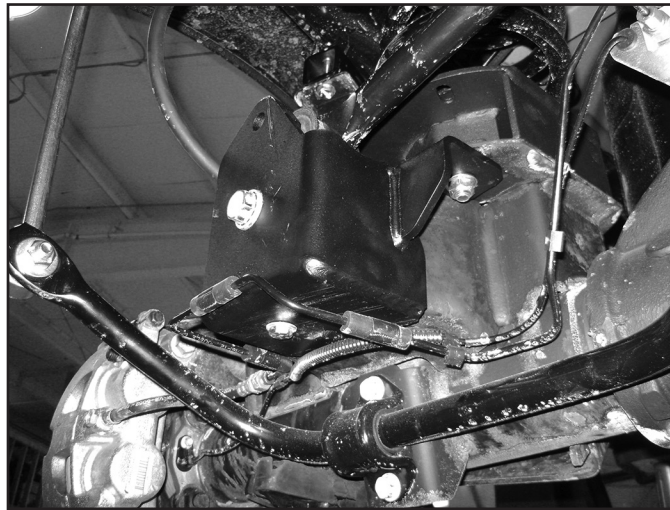
*The coil spacers are designed to center on the factory coil cup. Due to some OE variance, the spacers may sit up slightly on the corner of the cup. Once the weight of the vehicle is on the coil spacers, they will fully seat on the axle.*

11. Install the trackbar bracket to the axle, hardware is located in bolt pack 826. First loosely attach the bracket using the 7/16" hardware through coil spacer and lower coil mount. Next, place the 2-1/8" long sleeve (145) and place it inside the track bar bracket at the factory track bar bolt location using the factory track bar bolt and nut tab. Using the 3/8" x 1-1/2" bolt, washer, and flange nut attach the bracket through the bottom hole. (Fig. 5a, 5b)

**FIGURE 5A**

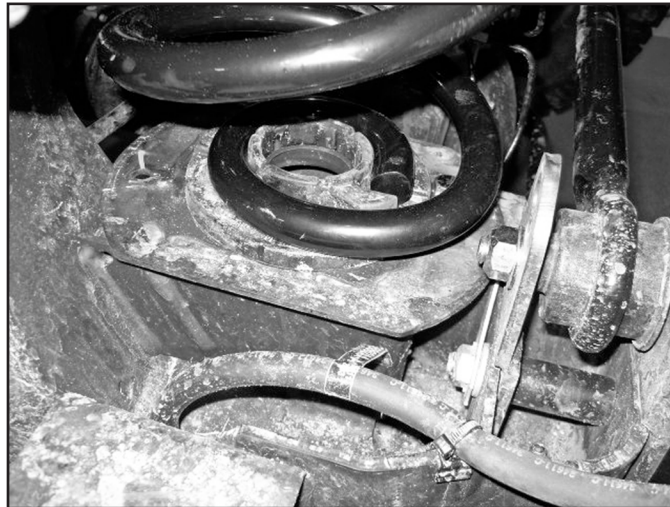


**FIGURE 5B**



12. Tighten trackbar bracket hardware as follows: 14mm factory hardware 95 ft-lbs, 7/16" hardware 45 ft-lbs, 3/8" hardware 35 ft-lbs,
13. Reinstall factory coils with OEM isolators on the spacers. Raise axle and ensure that the isolators are centered over the factory mounts. Orientate the coils so that the lower locating tab is at the rear of the vehicle. This will give maximum clearance to the trackbar hardware. (Fig 6)

**FIGURE 6**



14. **Shock Installation:** Grease and install bushings and sleeves into new shocks. Install new shocks with new stem bushings and washers, the same as the factory shock setup. **Fox shocks only:** Fox shocks will require an offset stem eliminator bracket and bolt pack 946. The eye of the shock will need to be offset to the REAR of the vehicle to give the shock body clearance to the frame rail hole. Locate the OE frame hole towards the rear of the vehicle from the original stem mounting hole. Enlarge this hole using a 3/8" drill bit to fit to the tab on the offset bracket. Verify shock clearance to the frame opening, in may be necessary to slightly enlarge the opening due to variances in trucks, however this is highly unlikely. (Fig. 7)

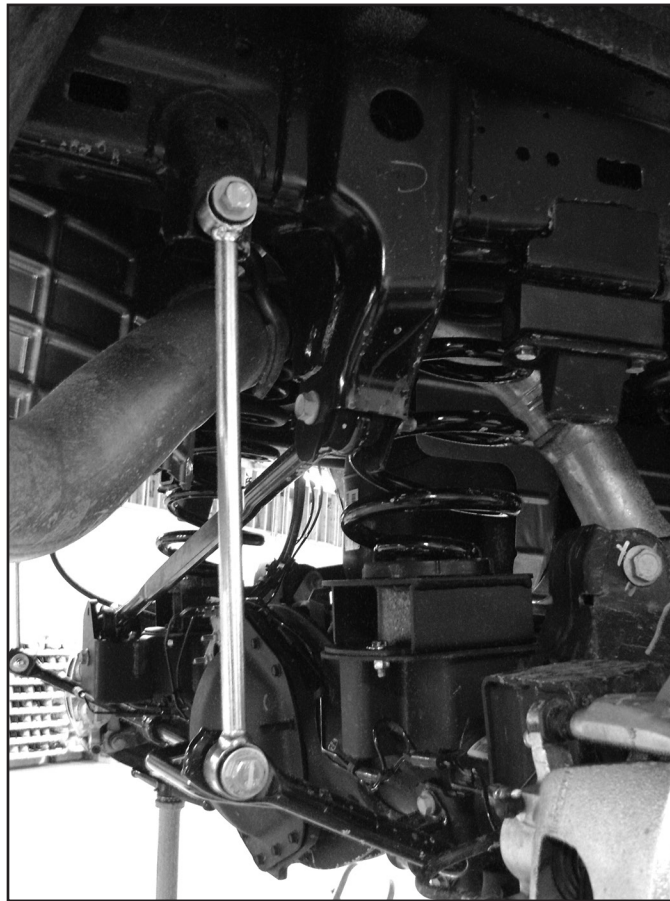
*Note: The offset stem eliminator will be taller than pictured in Figure 7. The offset stem eliminator will install the same way as shown in Figure 7.*

**FIGURE 7**



15. Grease sleeves and install into sway bar links assembly. Install sway bar links with new 12mm hardware, the grease zerks will face to the rear of the vehicle so they can be accessible. (BP795). Tighten to 45 ft-lbs. (Fig 8)

**FIGURE 8**



16. Remove the factory bump stops. Install bump stop drop brackets with new 10mm hardware (BP 796). Install so the small holes are to the inside. Tighten to 35 ft-lbs. (Fig 9a, 9b)



**FIGURE 9A**



**FIGURE 9B**



17. Reinstall wheels, if installing aftermarket wheels it is recommended to remove all of the rotor retaining clips to allow the wheel to sit flush against the rotor. Tighten to factory specifications.
18. Lower vehicle to the ground.
19. Attach trackbar to the new bracket with 9/16" x 4" hardware (BP 826). It may be necessary to have an assistant push on one side of the truck slightly to get the holes aligned. Tighten to 95 ft-lbs.
20. Recheck all hardware for proper torque, check again after 500 miles.



## **WE WANT TO SEE YOUR RIDE!**

Grab photos of your BDS-equipped truck in action and send them in for a chance to be featured. Send it in to our Bad Ass Rides customer gallery at [bds-suspension.com/bar](http://bds-suspension.com/bar) and post them on the BDS Fan Page on Facebook at [facebook.com/BDSSuspensions](https://facebook.com/BDSSuspensions). Don't forget about your BDS swag! BDS offers t-shirts, hoodies, decals and more available on the BDS website or through your local BDS distributor.

---

## **TIME TO HAVE SOME FUN**

**Thank you for choosing BDS Suspension.**

For questions, technical support and warranty issues relating to this BDS Suspension product, please contact your distributor/installer before contacting BDS Suspension directly.