

INSTALLATION GUIDE

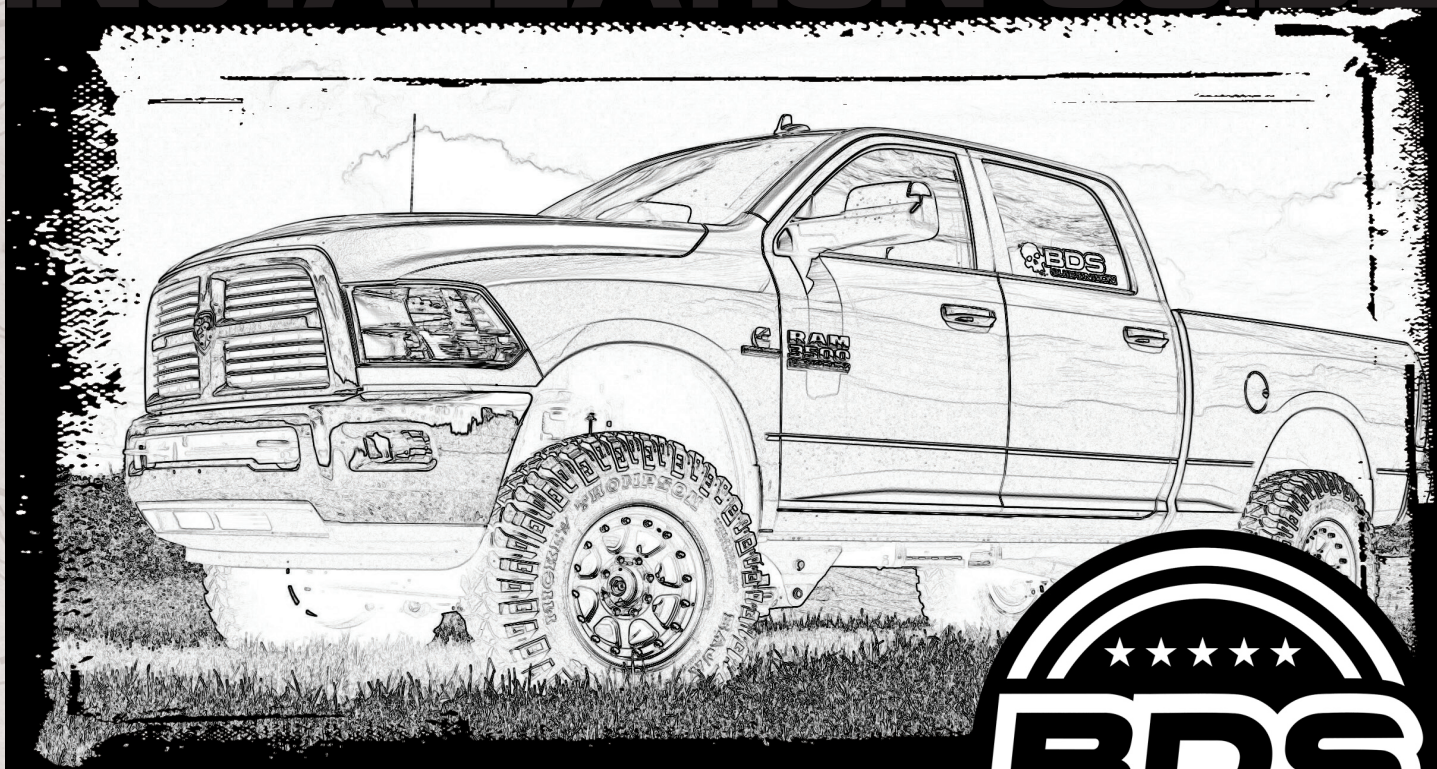

Part#: 012615



HARDCORE LIMITED LIFETIME WARRANTY

6" Radius Arm Suspension System

Dodge Ram 2500 4WD Pickup | 2014-2018

Dodge Ram 3500 4WD Pickup | 2013-2018

491 W. Garfield Ave., Coldwater, MI 49036 • Phone: 517-279-2135

Rev. 020524

Web: www.bds-suspension.com • E-mail: tech-bds@ridefox.com

Read And Understand All Instructions And Warnings Prior To Installation Of System And Operation Of Vehicle.



THANK YOU

Your truck is about to be fitted with the best suspension system on the market today. That means you will be driving the baddest looking truck in the neighborhood, and you'll have the warranty to ensure that it stays that way for years to come. Thank you for choosing BDS Suspension!

BEFORE YOU START

BDS Suspension Co. recommends this system be installed by a professional technician. In addition to these instructions, professional knowledge of disassembly/ reassembly procedures and post installation checks must be known.

FOR YOUR SAFETY

Certain BDS Suspension products are intended to improve off-road performance. Modifying your vehicle for off-road use may result in the vehicle handling differently than a factory equipped vehicle. Extreme care must be used to prevent loss of control or vehicle rollover. Failure to drive your modified vehicle safely may result in serious injury or death. BDS Suspension Co. does not recommend the combined use of suspension lifts, body lifts, or other lifting devices. You should never operate your modified vehicle under the influence of alcohol or drugs. Always drive your modified vehicle at reduced speeds to ensure your ability to control your vehicle under all driving conditions. Always wear your seat belt.

BEFORE INSTALLATION

Special literature required: OE Service Manual for model/year of vehicle. Refer to manual for proper disassembly/reassembly procedures of OE and related components.

Adhere to recommendations when replacement fasteners, retainers and keepers are called out in the OE manual.

Larger rim and tire combinations may increase leverage on suspension, steering, and related components. When selecting combinations larger than OE, consider the additional stress you could be inducing on the OE and related components.

Post suspension system vehicles may experience drive line vibrations. Angles may require tuning, slider on shaft may require replacement, shafts may need to be lengthened or trued, and U-joints may need to be replaced.

Secure and properly block vehicle prior to installation of BDS Suspension components. Always wear safety glasses when using power tools.

If installation is to be performed without a hoist, BDS Suspension Co. recommends rear alterations first.

Due to payload options and initial ride height variances, the amount of lift is a base figure. Final ride height dimensions may vary in accordance to original vehicle attitude. Always measure the attitude prior to beginning installation.

BEFORE YOU DRIVE

Check all fasteners for proper torque. Check to ensure for adequate clearance between all rotating, mobile, fixed, and heated members. Verify clearance between exhaust and brake lines, fuel lines, fuel tank, floor boards and wiring harness. Check steering gear for clearance. Test and inspect brake system.

Perform steering sweep to ensure front brake hoses have adequate slack and do not contact any rotating, mobile or heated members. Inspect rear brake hoses at full extension for adequate slack. Failure to perform hose check/ replacement may result in component failure. Longer replacement hoses, if needed can be purchased from a local parts supplier.

Perform head light check and adjustment.

Re-torque all fasteners after 500 miles. Always inspect fasteners and components during routine servicing.

TIRES AND WHEELS

FITMENT GUIDE

6" Lift:

37x12.50 w/ 4.5~5.625" Backspacing on 9" wide wheel

37x13.50 w/ 5.625" Backspacing on 9" wide wheel



CONTENTS OF YOUR KIT

012615

Part #	Qty	Description
082405R	1	Pitman Arm
02446	1	Trackbar bracket
27031	1	Fish Wire
01797	1	1/2" Bolt Tab
01499	1	1/4" Spacer
03855	1	Brake Bracket - Drv
03856	1	Brake Bracket - Pass
99000	2	Cable Tie
342701	1	Thread locker
02322BK	2	Bump Stop
01253B	1	Sway Bar Drop - Drv
01254B	1	Sway Bar Drop - Pass
03964	1	Ram 2500/3500 Radius Arm Cam Plate
792	1	Bolt Pack - Trackbar Bracket
	1	1/2"-13 x 1-3/4" bolt - grade 8 - yellow zinc
	1	1/2"-13 Prevailing torque nut - yellow zinc
	1	1/2"-13 Nut (non locking) - yellow zinc
	3	1/2"-13 USS Washer - yellow zinc
	1	18mm-2.50 x 80mm bolt - class 10.9 clear zinc
	1	18mm-2.50 Prevailing torque nut - clear zinc
	2	3/4" SAE Washers - Clear zinc
495	1	Bolt Pack - Brake Line Brackets
	2	1/4" USS Washer, Clear Zinc
	2	5/16"-18 Nylock Nut, Clear Zinc
422	1	Bolt Pack - Sway Bar Drop
	4	3/8"-16 x 1-1/4" Bolt, Grade 8, Yellow Zinc
	4	3/8"-16 Prevailing Torque Nut, Yellow Zinc
	8	3/8" USS Washer, Yellow Zinc
358	1	Bolt Pack - Sway Bar Drop
	2	18mm-2.50 x 140mm Bolt, Class 10.9, Clear Zinc
	4	18mm Washer, Clear Zinc
	2	18mm-2.50 Prevailing Torque Nut, Clear Zinc

032401

Part #	Qty	Description
032401R	1	Front 5.5" Driver Coil - Gas
032402R	1	Front 5.5" Passenger Coil - Gas

032602

Part #	Qty	Description
032602R	2	Front 6" Coils - Diesel

122321

Part #	Qty	Description
A243	2	Dodge Ram 2500/3500 Radius Arm
02802	2	BDS Badge
995	1	Bolt Pack
	4	1/8" x 0.251-0.312 18-8 Stainless Steel Blind Rivet

PRE INSTALLATION

IMPORTANT

It is required that ride height measurements be taken before and after installation. Measure from the **WHEEL AXLE CENTER** up to the **FENDER LIP** of the wheel opening. Do this for all 4 wheels. Record measurements below.**

BEFORE

Left Front _____ *Right Front* _____

Left Rear _____ *Right Rear* _____

AFTER

Left Front _____ *Right Front* _____

Left Rear _____ *Right Rear* _____



****These ride heights will be required if you have any ride height concerns after installation. Please be prepared to provide these to Technical Support.**

INSTALLATION INSTRUCTIONS

PRE INSTALLATION NOTES:

6.4L Gas models will require exhaust modification to clear the front driveshaft. 5.7L Gas models may require modification - but not in all cases. The vehicle can be driven without the front driveshaft to an exhaust shop for modification and reinstalled after modification.

SPECIAL TOOLS

- #1: Pitman arm puller
- #2: 11/16" drill (step drill highly recommended)
- #3: Welder

MEASURE FIRST

Measure and record from the center of the wheel up to the bottom edge of the wheel opening as shown on the previous page.

RADIUS ARM INSTALLATION INSTRUCTIONS

1. Park vehicle on clean flat and level surface. Block the rear wheels for safety.
2. Disconnect the battery / batteries, welding will be required. Do not weld on the vehicle with the batteries connected.
3. Remove the front trackbar bolt from the frame rail. Retain all hardware. (Fig. 1)

FIGURE 1

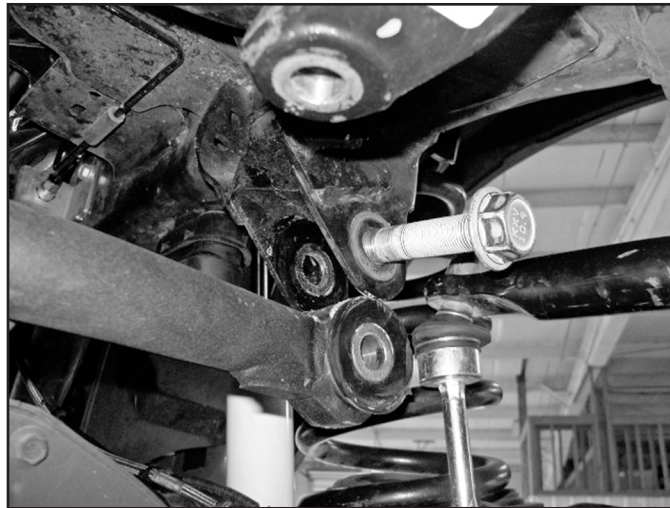

4. Raise the front of the vehicle and support the frame rails with jackstands. Do not support on the radius arms, they will be removed during the installation.

SUSPENSION DISASSEMBLY

5. Support the front axle with a hydraulic jack.
6. Remove the factory wheels, remove the retaining clips that hold the rotor on and may interfere with aftermarket wheels.
7. Break the jam nuts loose on the adjusting collar of the drag link. (Fig 2)

FIGURE 2

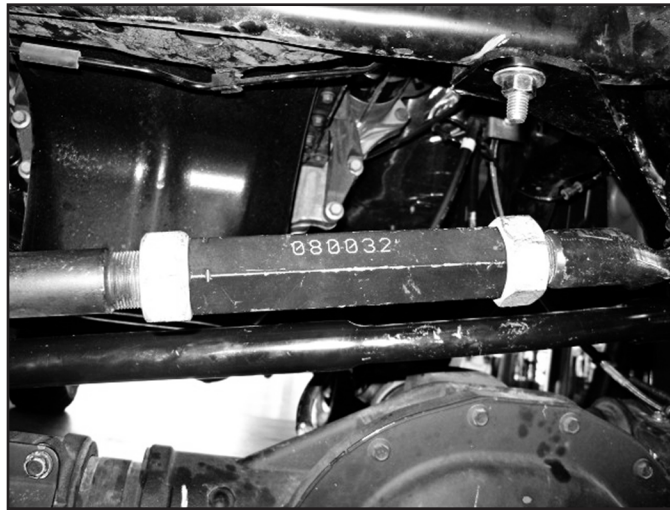

8. Disconnect the tie rod from the pitman arm, do not damage the tie rod boot. Mark the orientation of the pitman arm and remove the pitman arm from the sector shaft. (Fig. 3)

FIGURE 3



9. Disconnect the sway bar links from the sway bar. Disconnect the sway bar mounting hardware from the frame, and remove sway bar. Retain all hardware. (Fig. 4)

FIGURE 4

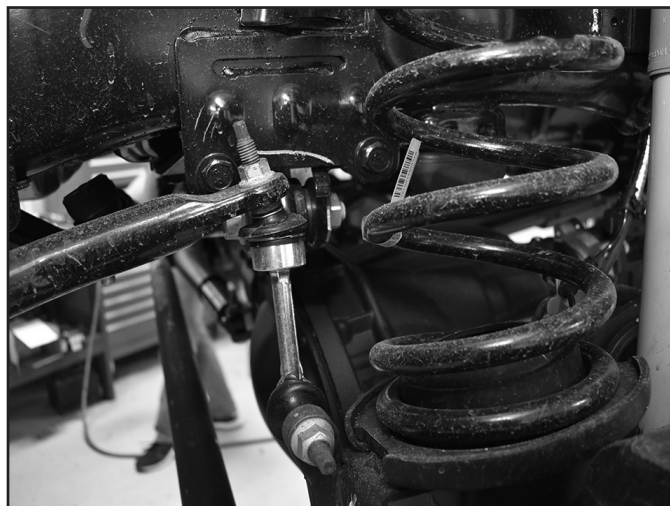

10. Disconnect the brake line brackets from the top of the radius arm mount on both sides of the axle, retain bolts, discard brackets. (Fig. 5)

FIGURE 5

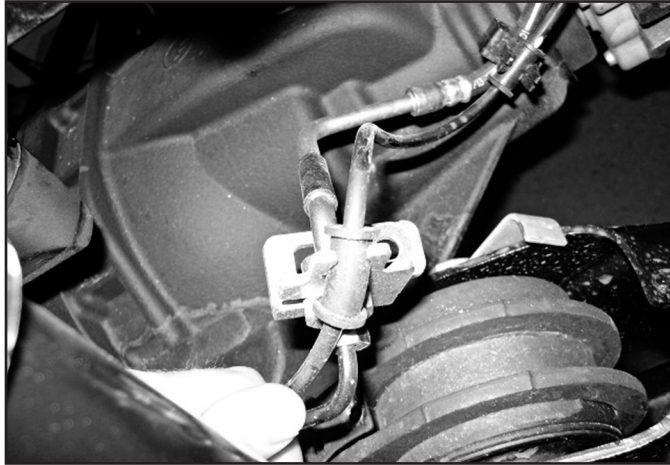

11. Disconnect the factory shocks from the lower shock mount. (Fig. 6) Lower the front axle and remove the factory coil springs.

FIGURE 6



12. Raise the front axle and reattach factory shocks with factory bolt. It is not necessary to put the nut tab back on. The shocks will be there to keep the axle secure. Keep a jack under the axle for extra support.

RADIUS ARM INSTALLATION:

13. Working on one side of the vehicle at a time, remove the factory radius arm. Retain all hardware. It will be necessary to remove the shock bolt and move the shock out of the way to get the upper hardware out. Reinsert the lower shock bolt when the arm is removed.
14. Replace the radius arm with the new one, both sides are the same. Reattach with factory hardware at the frame and upper axle mount. Replace the cam bolt with the 18mm bolt supplied in bolt pack 358 and provided cam plates. Insert the cam plates so the bolt is as far forward as possible. (Fig 8A Passenger side shown) Note: This will provide more caster than the factory cam bolts allow. Remove one of the opposing bolts at the axle to allow the axle to rotate while supporting it with a jack. (Fig 8B)

FIGURE 8A

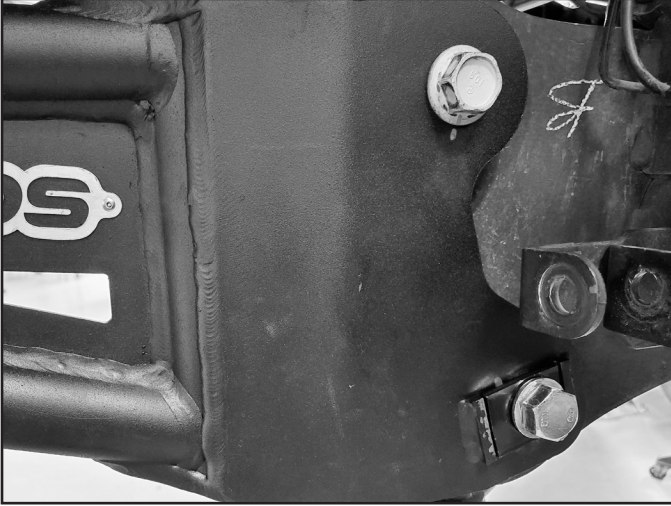

FIGURE 8B



15. Repeat radius arm installation on opposite side.
16. Tighten the upper bolt at the axle to 258 ft-lbs. Tighten lower cams to 258 ft-lbs. Do not tighten the pivot bushing hardware at the frame at this time.

BUMP STOP INSTALLATION:

17. Remove the factory bump stops, it is easiest to hit them from side with a hammer to pop them out. (Fig. 12)

FIGURE 12



18. Grease new replacement bump stops and raise axle to press the bump stops into position. These will be a tight fit. It is easiest to lift the axle with a jack to compress the bump stops into position. (Fig. 13)

FIGURE 13



TRACK BAR BRACKET INSTALLATION

19. Install the trackbar bracket with factory bolt through the original trackbar hole.
20. Clearance the factory hole on the frame crossmember where the trackbar bracket meets to $9/16"$.
21. The upper slot in the trackbar bracket will align with the hole in the factory trackbar bracket. These holes have variations in their position, and minor grinding of the hole horizontally may be required. Clearance the hole so $1/2"$ hardware will fit through it. (Fig. 14)

FIGURE 14

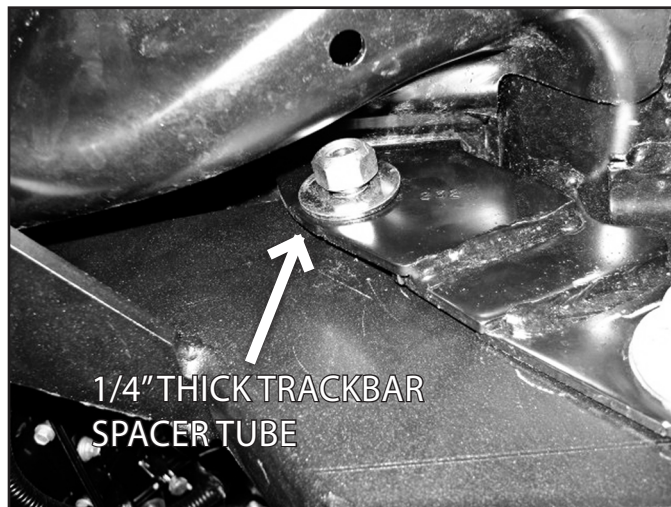

22. Fish the bolt tab through the frame rail with the included bolt wire and attach to the trackbar bracket with $1/2"$ USS washer and regular nut. Apply thread locker to the bolt threads. Attach the upper hole with $1/2" \times 1-3/4$ (#792) bolt with spacer washer as shown. (Fig. 15A, 15B)

FIGURE 15A



FIGURE 15B



23. Tighten $1/2"$ trackbar hardware to 65 ft-lbs. Tighten 18mm factory bolt to 150 ft-lbs.
24. Support front axle and remove the factory shocks. Retain the lower hardware, discard shocks and upper hardware.

COIL BUCKET MODIFICATION AND COIL/SHOCK INSTALL

25. **6" Diesel:** Lower the axle and install the new coils with factory isolator. The end of the spring with the windings closer together will go at the top, do not install upside down. The passenger's side upper mount will need to be reindexed. There is a template at the end of the instruction sheet. Cut this out and place over the passenger's side upper mount, mark the center of the hole, and drill to 1/2". The hole should now be directly to the 'Rear' of the vehicle. Install isolator with the new coil spring. Ensure that coils are seated properly, have someone help if necessary. (Fig 11a, 11b, 12a, 12b)

FIGURE 12A



FIGURE 12B



FIGURE 13A



FIGURE 13B



26. **5.5" Gas:** Lower the axle and install the new coils with factory isolator. The end of the spring with the windings closer together will go at the top, do not install upside down. The passenger's side upper mount will need to be reindexed. There is a template at the end of the instruction sheet. Cut this out and place over the passenger's side upper mount, mark the center of the hole, and drill to 1/2". The hole should now be directly to the 'Outside' of the vehicle. Install isolator with new coil spring. Ensure that coils are seated properly, have someone help if necessary. (Fig 14a, 14b, 15a, 15b)

FIGURE 14A



FIGURE 14B

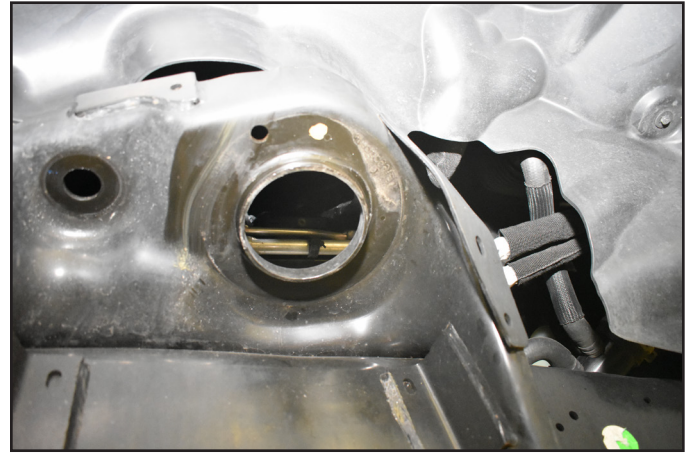

FIGURE 15A

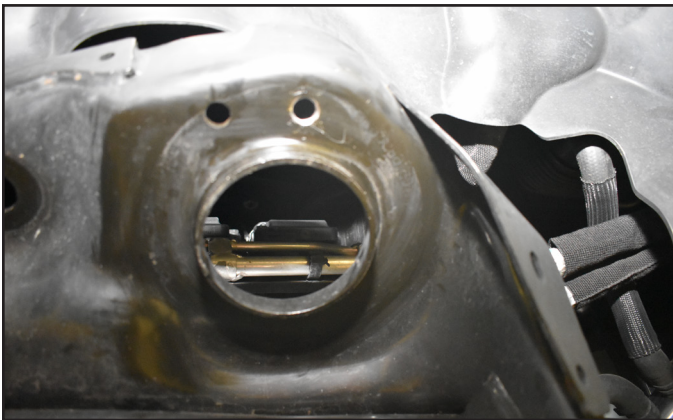
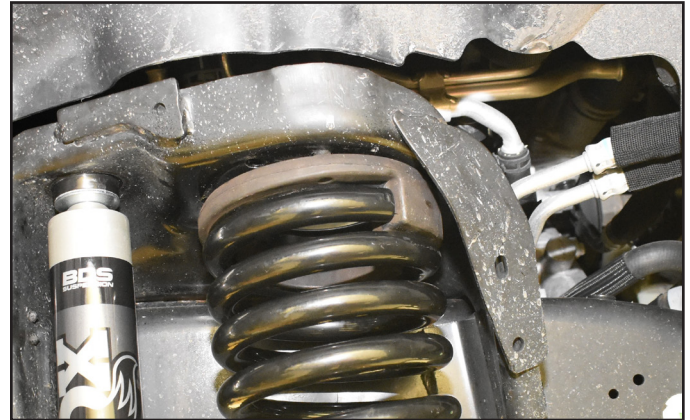

FIGURE 15B



27. Grease and install bushings and sleeves into the shocks. Install new shocks with cup washers, bushings, and 1/2" nut at the top mount. Tighten the nut until the bushings begin to swell.
28. Attach the lower shock with factory hardware. Tighten hardware to 65 ft-lbs.

29. Disassemble the drag link. Trim the tab from the tie rod end flush with the end of the threads. (Fig 17A, 17B). Trim the end of the tab on the drag link to 1-1/4" long (Fig. 17c).

FIGURE 17A



FIGURE 17B

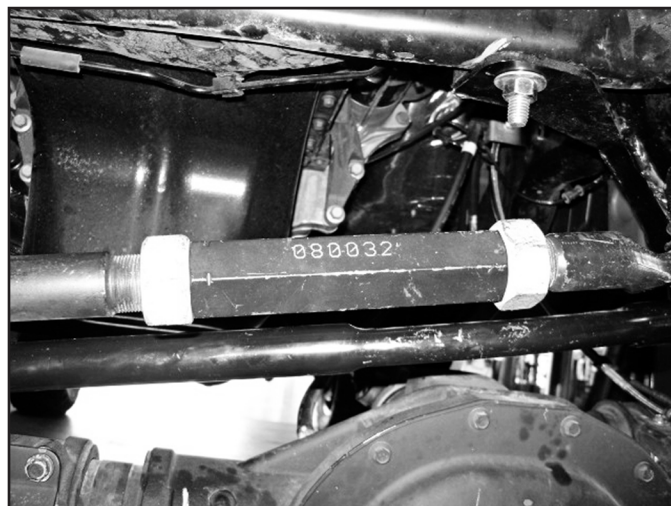

FIGURE 17C



30. Reassemble the drag link, adjust so that there is approximately 3/4"~7/8" of thread exposed past the jam nuts and that the tie rod end faces up. (Fig. 18A)

FIGURE 18A



31. Install new pitman arm, use alignment mark made earlier. The included pitman arm can be installed in 2 different positions. Ensure that the pitman arm is installed in the most counter clockwise position (towards the driver side) as shown in (Fig. 18B). Loctite factory nut and install with lock washer tighten nut to 225 ft-lbs.

FIGURE 18B



32. Attach drag link to pitman arm with factory nut. Tighten to 65 ft-lbs. (Fig. 19)

FIGURE 19

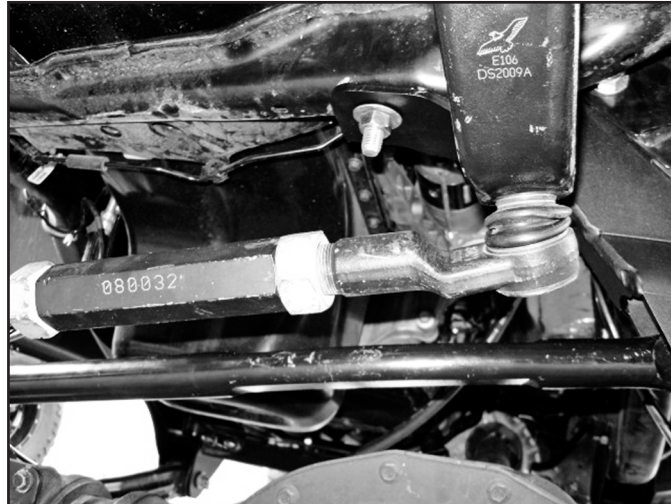

33. Mount the brake line relocation bracket to the factory brake line mount location at the frame with factory hardware, torque to 9ft-lbs. Mount the brake line to the relocation bracket using the provided hardware (Bolt pack 495), torque to 101in-lbs. (Fig. 20 Driver Side shown, Fig. 21 Passenger side)

FIGURE 20

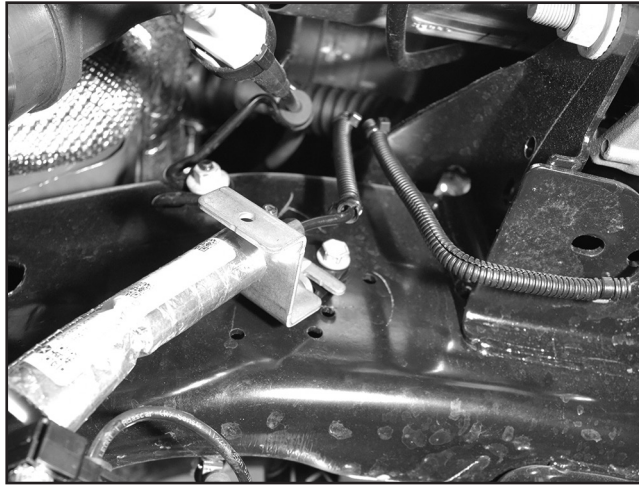
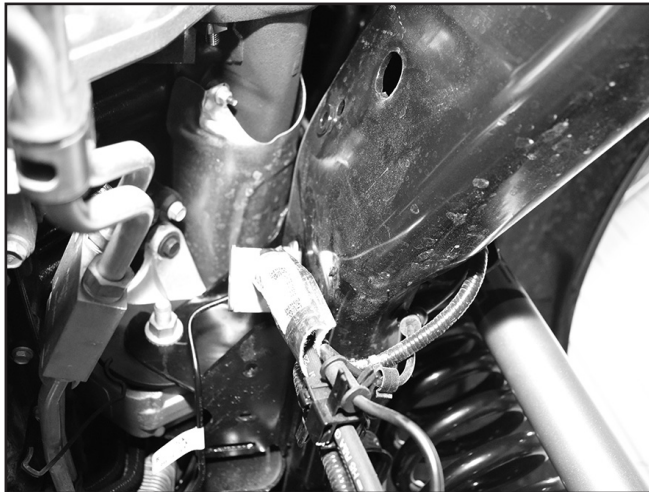

FIGURE 21



34. Install the sway bar drop brackets with factory hardware to the frame. The flat side of the bracket will face "out" and the brackets will offset the sway bar slightly forward. Attach the sway bar to the drop brackets with 3/8" hardware (Bolt Pack 422), tighten factory hardware to 43 ft-lbs and 3/8" hardware to 37 ft-lbs. (Fig. 22, 23)

FIGURE 22



FIGURE 23



35. Reconnect the sway bar links with the factory hardware, torque to 60ft-lbs

36.PLEASE SEE INDEX RING KIT INSTRUCTIONS AT THIS TIME.

37.PLEASE SEE REAR KIT INSTRUCTIONS AT THIS TIME.

38. Install wheels and tighten lug nuts to factory specifications. Lower the vehicle to the ground.

39. Tighten radius arm hardware to 133 ft-lbs Plus 90 deg.

40. Turn the steering wheel to get the trackbar to align with the bracket. Install new 18mm bolt and tighten to 150 ft-lbs (#792).

POST-INSTALLATION

1. Adjust the steering wheel to center with the collar on the drag link. Securely lock off the jam nuts once the wheel is straight. Do not drive the vehicle with the steering wheel off-center or adverse traction control problems may arise.
2. Recheck all hardware, check again at 500 miles, and again at regularly scheduled maintenance intervals. Check brake lines and ABS wires for proper clearance through steering sweep, use zip ties on the ABS wires if necessary. An alignment must now be performed.

TIME TO HAVE SOME FUN

Thank you for choosing BDS Suspension.

For questions, technical support and warranty issues relating to this BDS Suspension product, please contact your distributor/installer before contacting BDS Suspension directly.



WE WANT TO SEE YOUR RIDE!

Grab photos of your BDS-equipped truck in action and send them in for a chance to be featured. Send it in to our Bad Ass Rides customer gallery at bds-suspension.com/bar and post them on the BDS Fan Page on Facebook at facebook.com/BDSSuspensions. Don't forget about your BDS swag! BDS offers t-shirts, hoodies, decals and more available on the BDS website or through your local BDS distributor.

