

REV	DESCRIPTION	DATE
-----	-------------	------

△ RDK-97163 張馨尹 2008/09/08

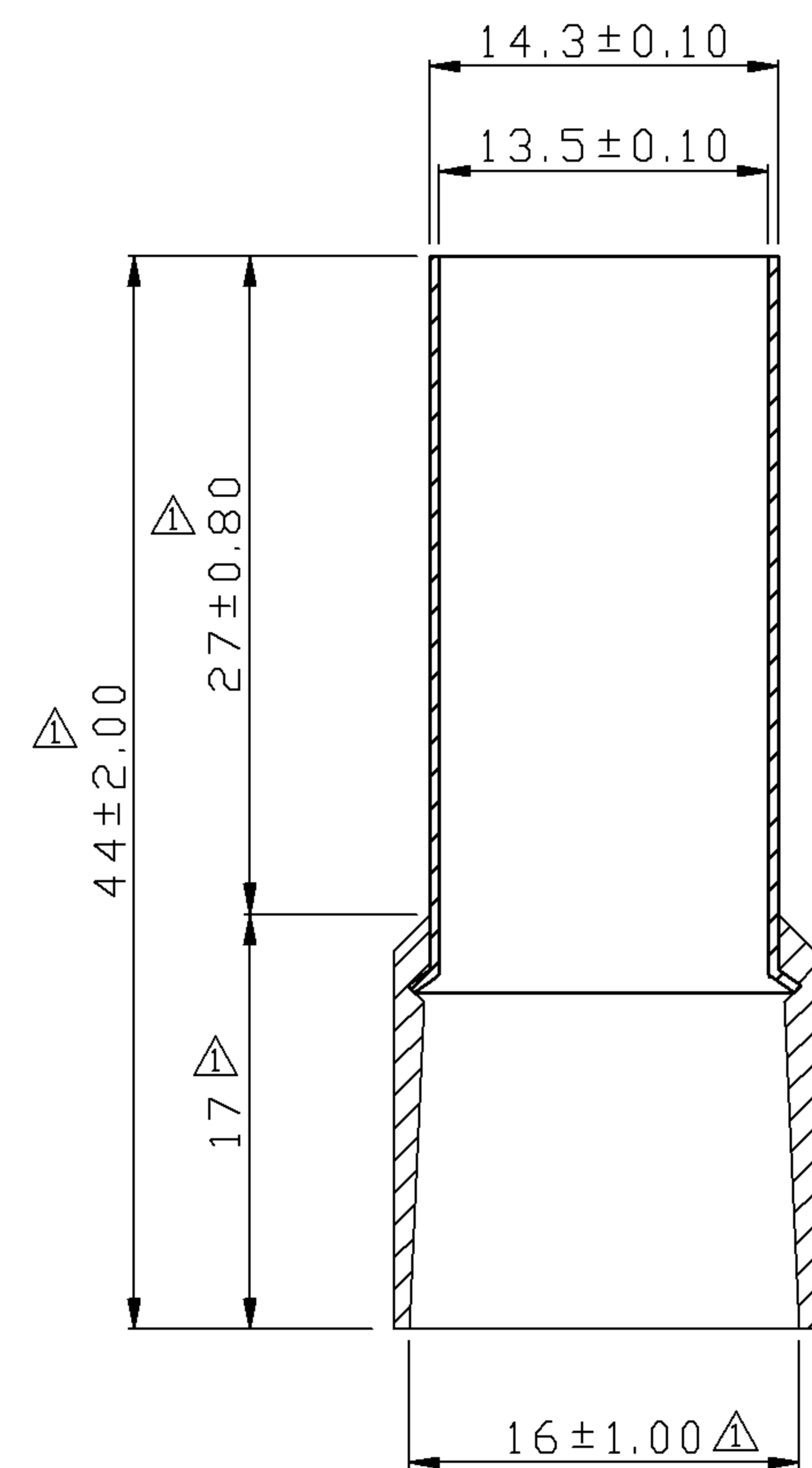
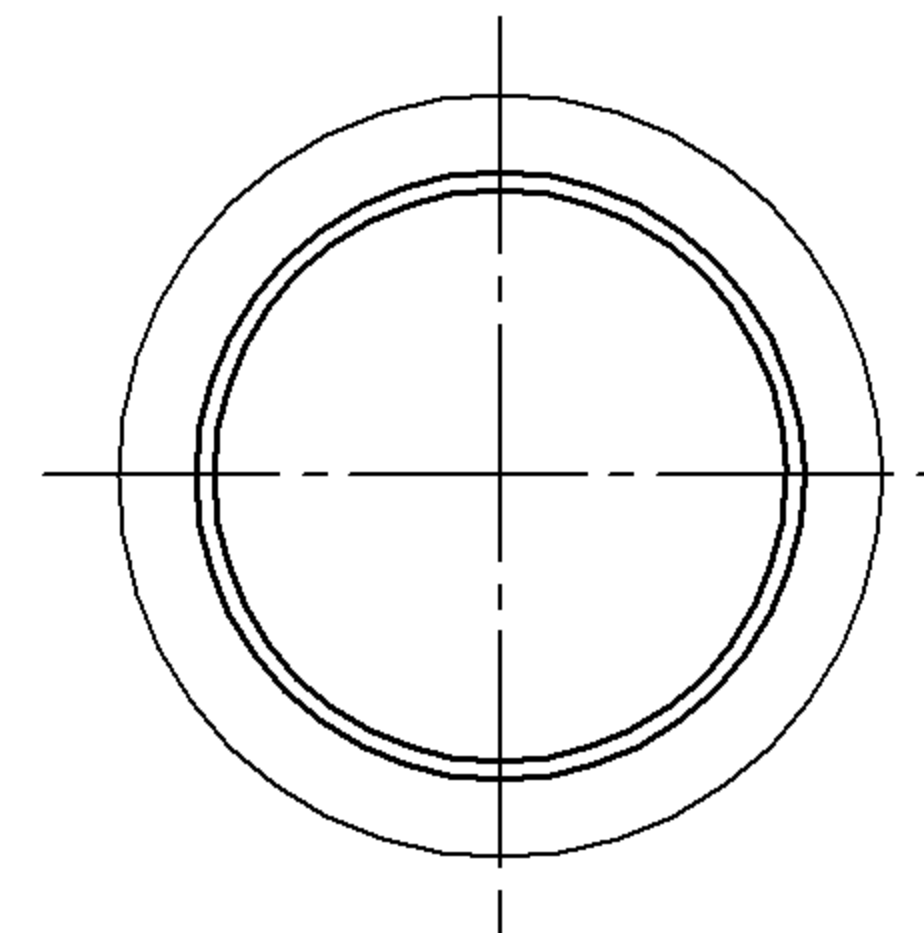

NOTE:

- MAXIMUM ELECTRIC CURRENT : 

A.W.G.	2/0
AMP.	265
- MAXIMUM ELECTRICAL RATING : 105°C 600 VOLTS MAX.
- INSULATION MATERIAL : NYLON
- INSULATION COLOR :  
FRENCH COLOR : YELLOW  
GERMAN COLOR : YELLOW  
DIN COLOR : YELLOW
- CONNECTOR MATERIAL : COPPER TUBE.
- WIRE RANGE : 2/0 A.W.G.( 70 mm<sup>2</sup>)
- CONNECTOR SURFACE TREATMENT : TIN PLATED

Tolerance Unless Otherwise Specified	
0 >	mm ± 0.50 ANGLE
>	mm ± 0° ° REF ±
>	mm ± ° ° ±
>	mm ± ° ° ±

NAME	NYLON-INSULATED CORD END TERMINALS (E SERIES)			UNIT	
PART NO.	E70-27	MATERIAL	-----	APPROVE	
NUMBER	KA-95467-C	SCALE	SHEET	PAGE	CHECKED
DATE	2006/06/11	2/1	1-1	10F1	DRAWN 張馨尹

**KST. K.S. TERMINALS INC.**