

MOLDING  
**BASE**

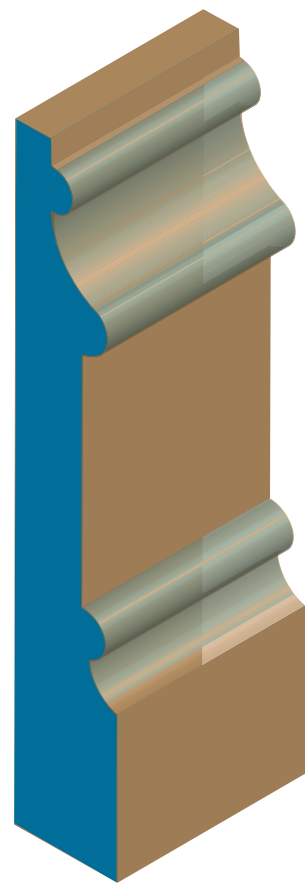

**PHILLIPS**  
FOREST PRODUCTS

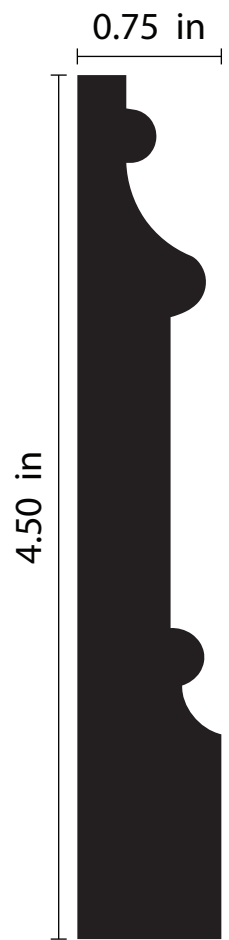

BS-001

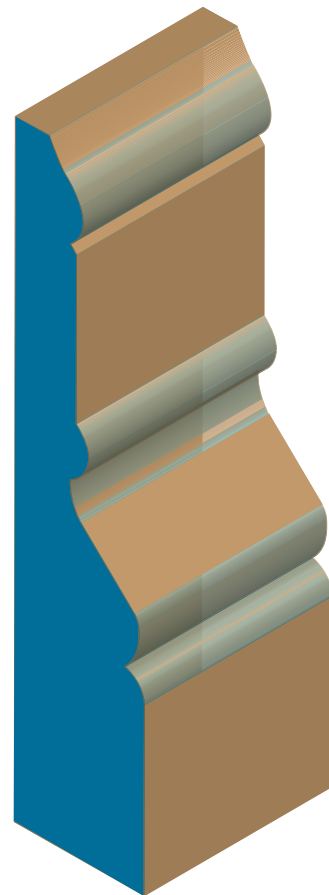
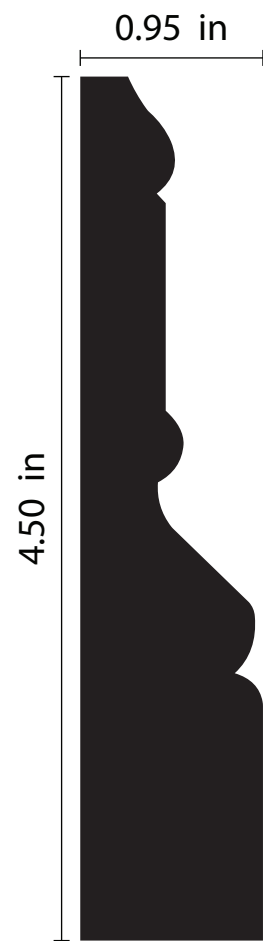

BS-003

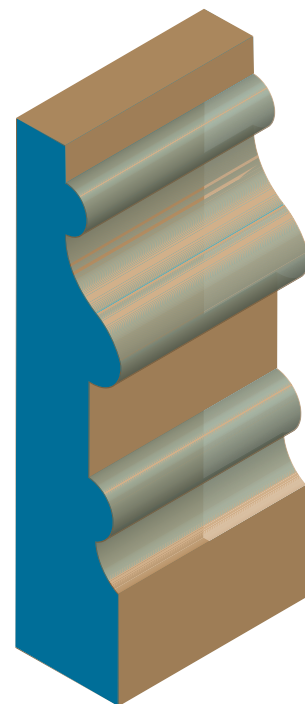
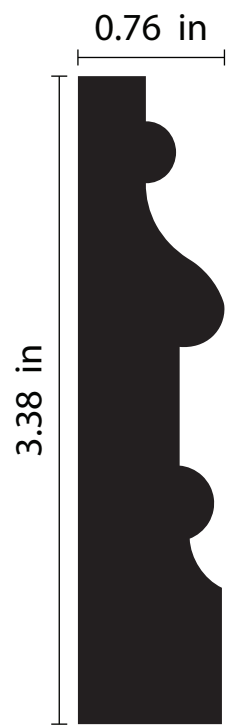

BS-002

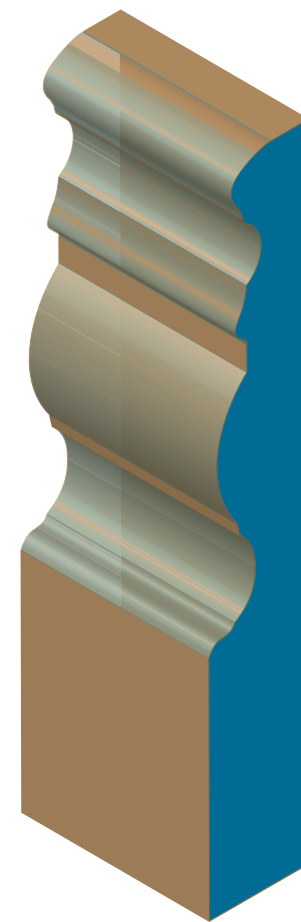
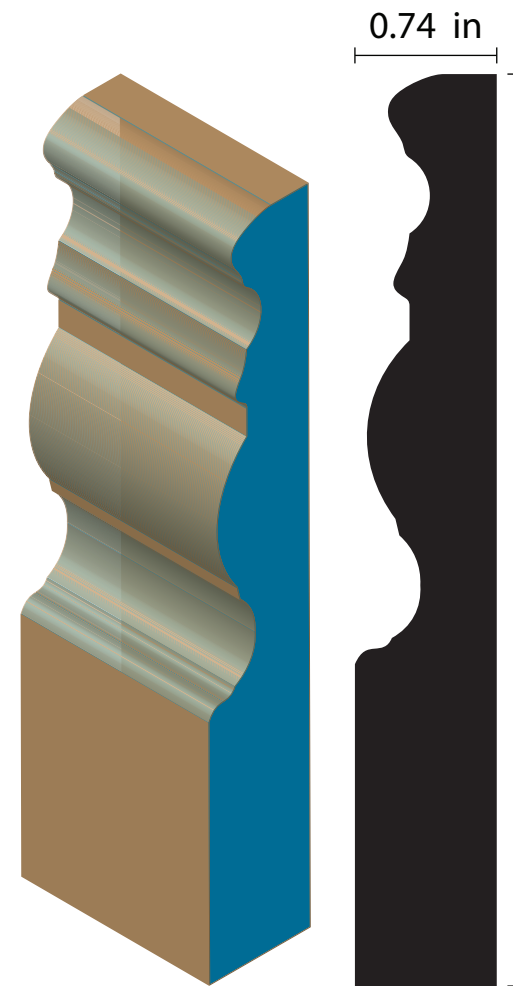

BS-004



BS-005



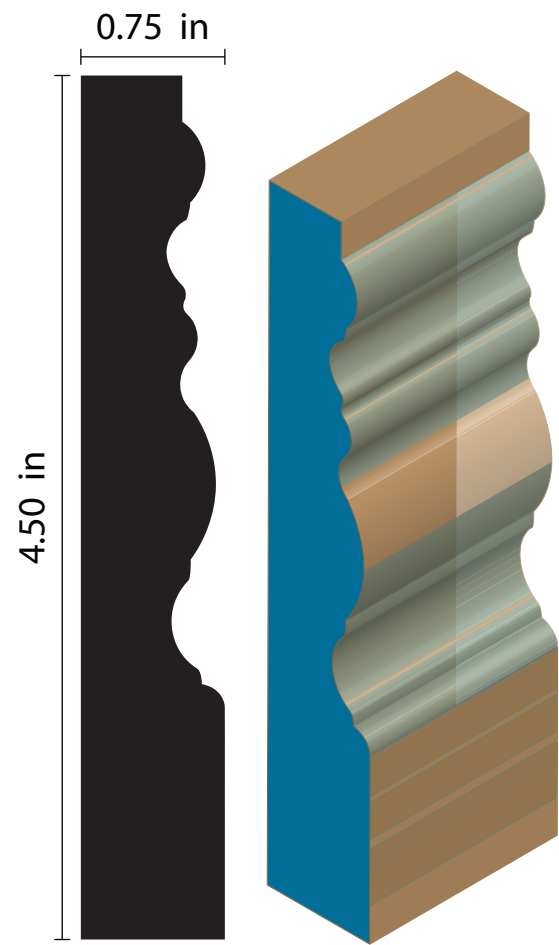

**BS-006**

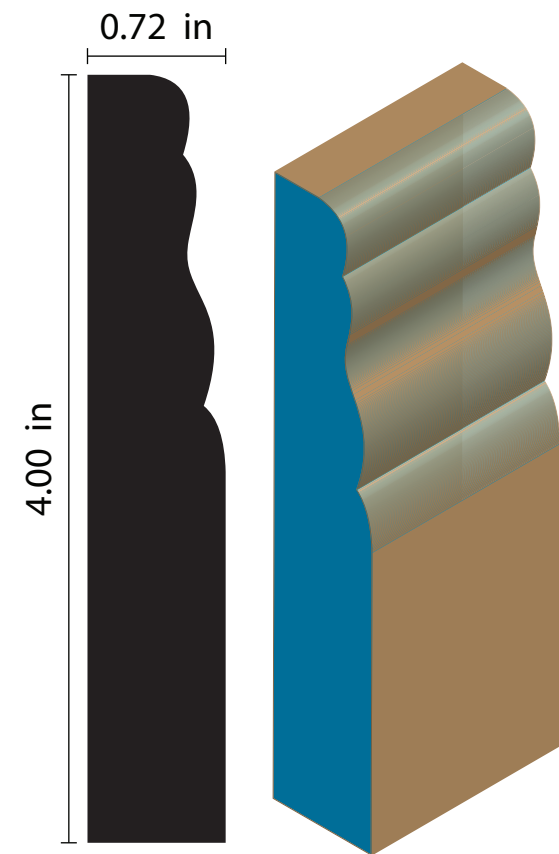

**BS-007**

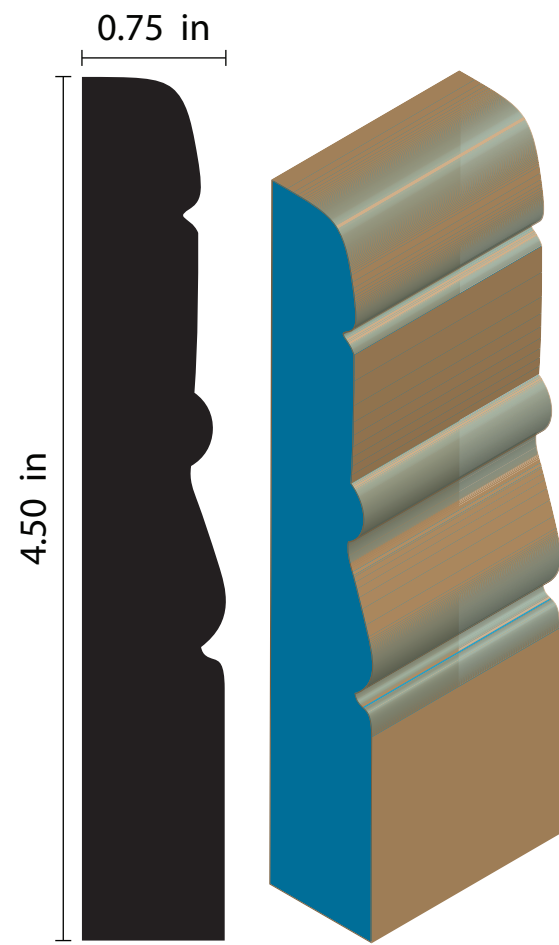

**BS-008**

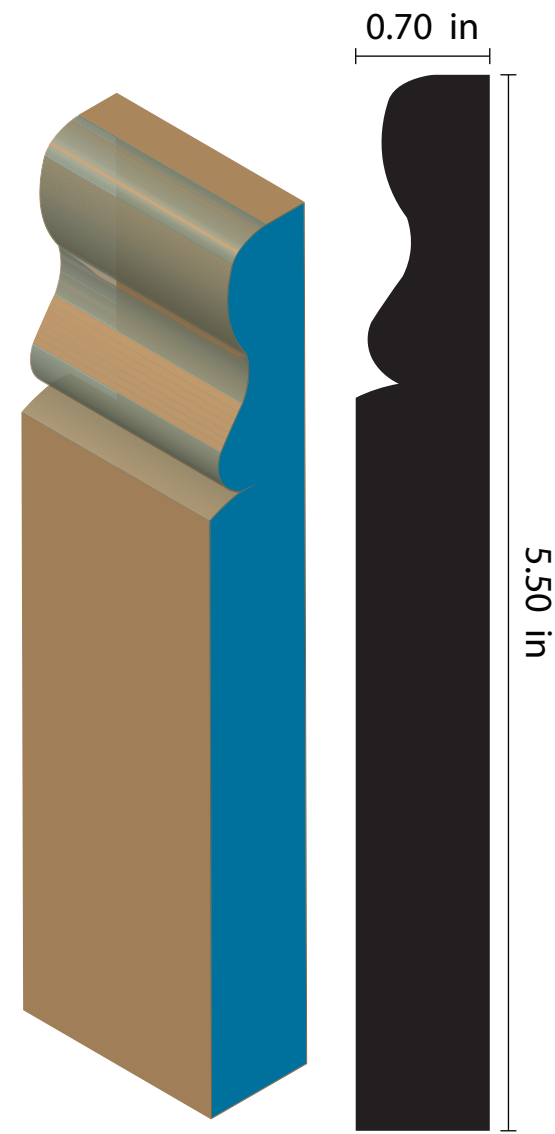

**BS-009**

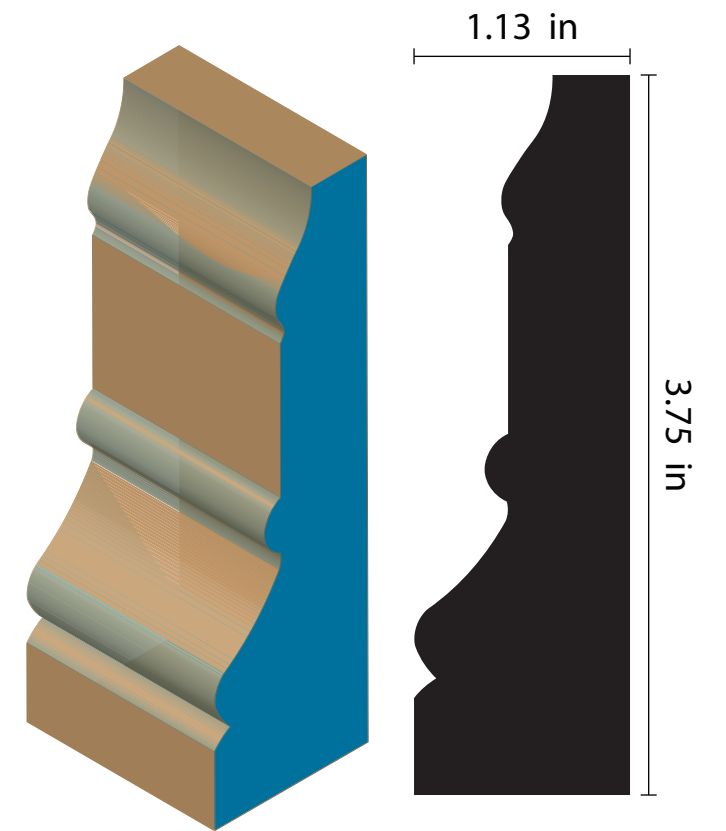

**BS-010**

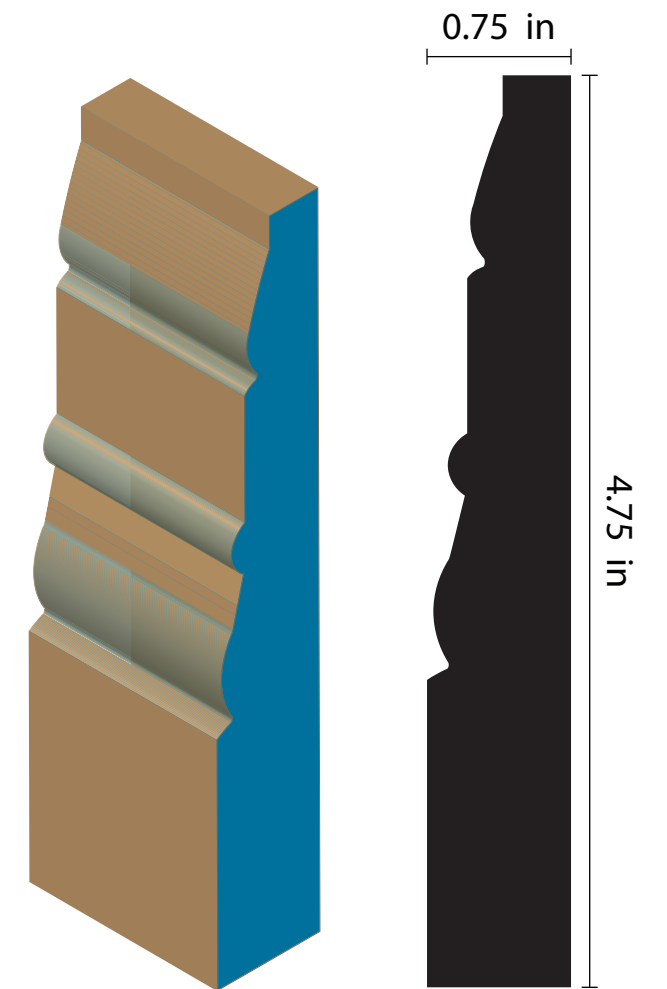

**BS-011**



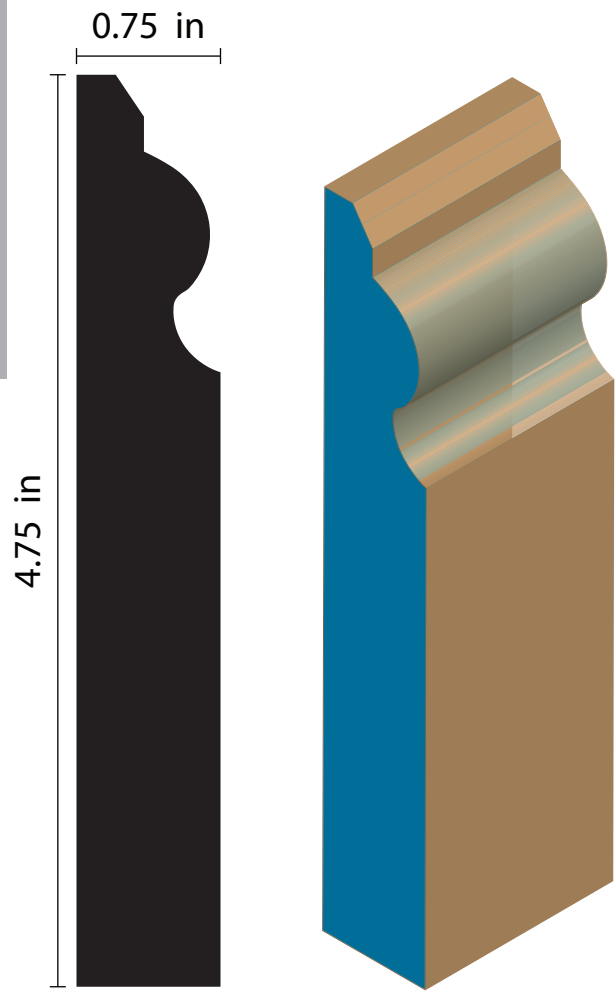

**BS-012**

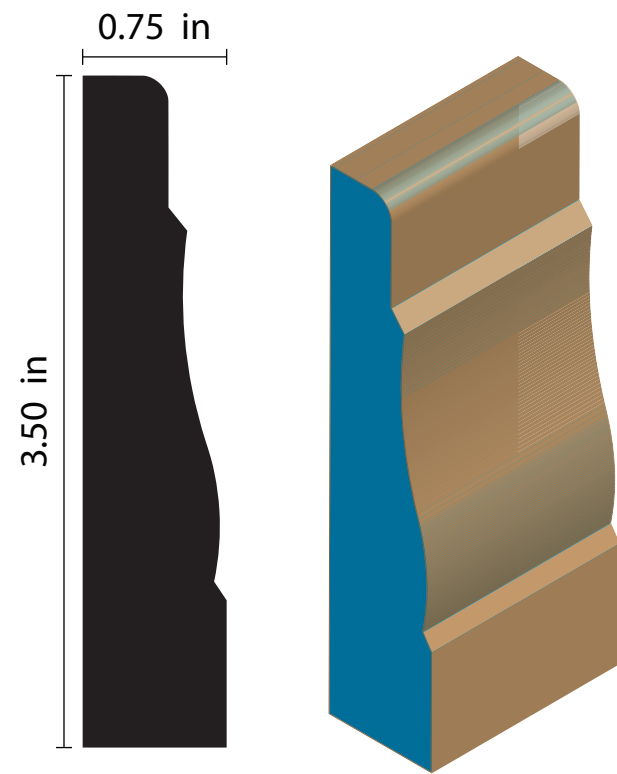

**BS-013**

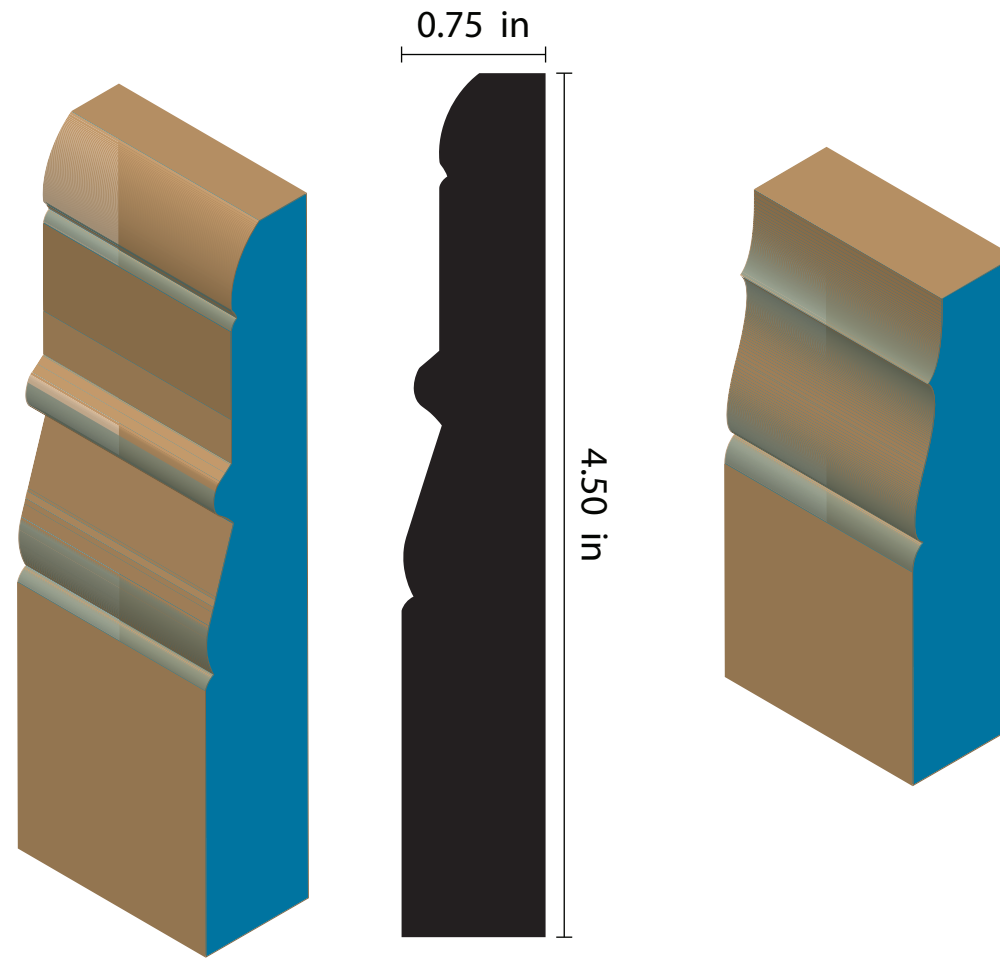

**BS-017**



**BS-016**

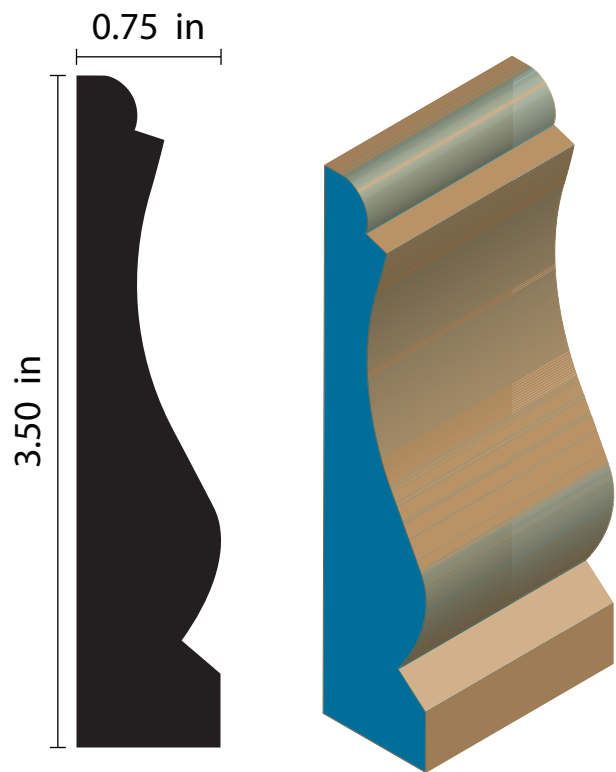

**BS-014**

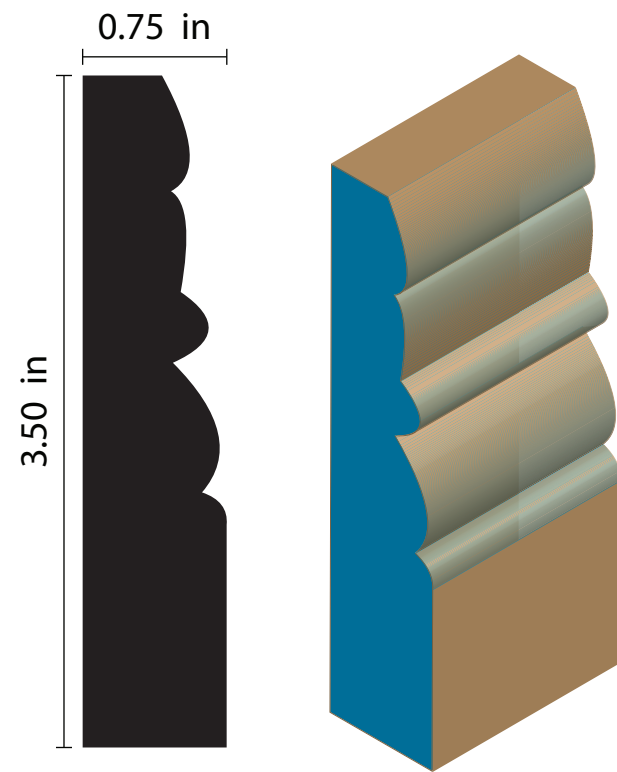

**BS-015**

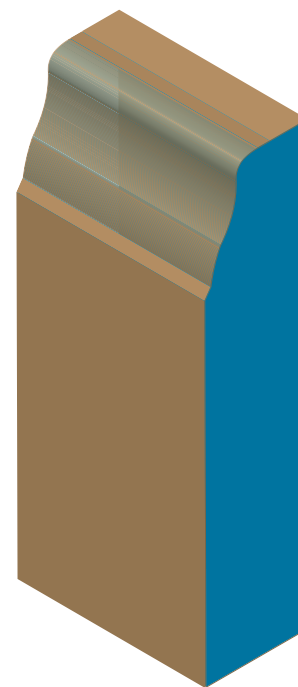

**BS-019**

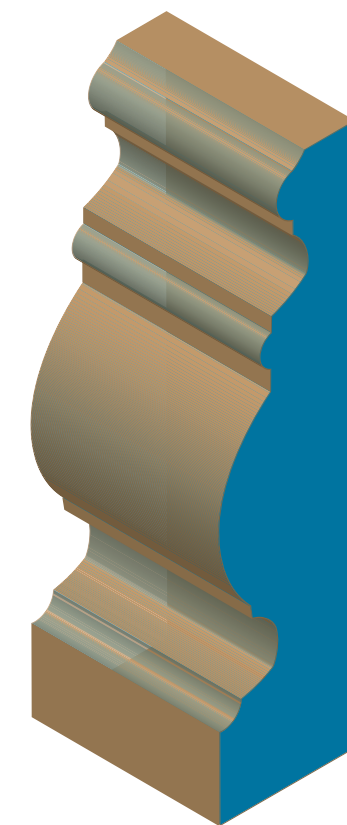

**BS-018**





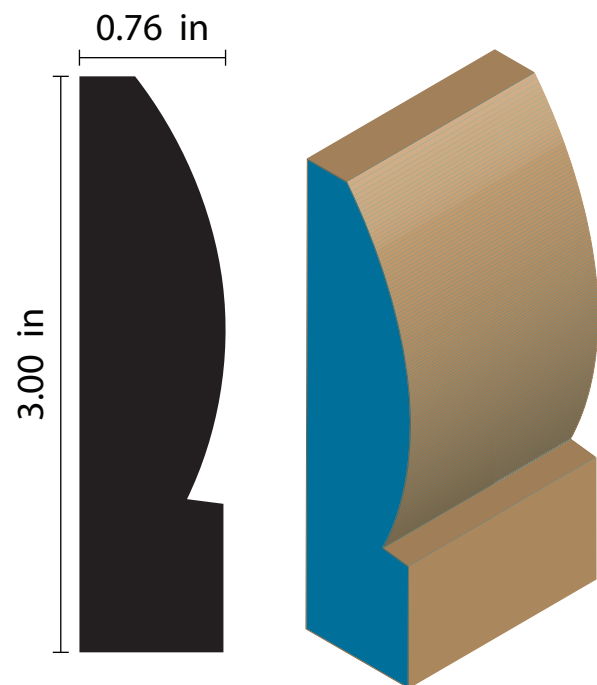

**BS-020**

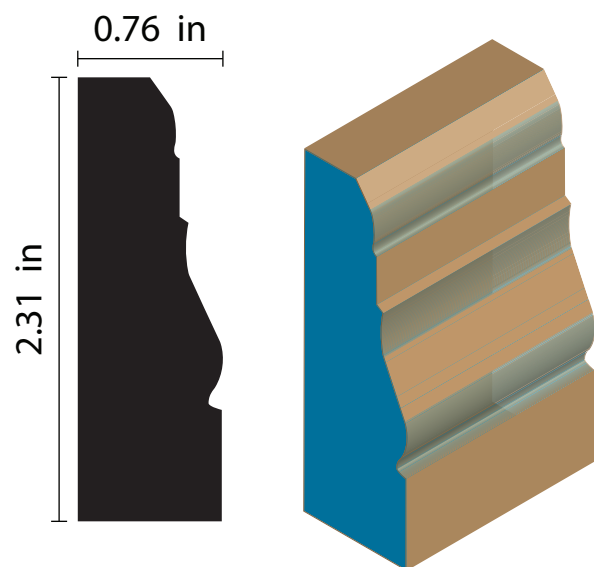

**BS-021**

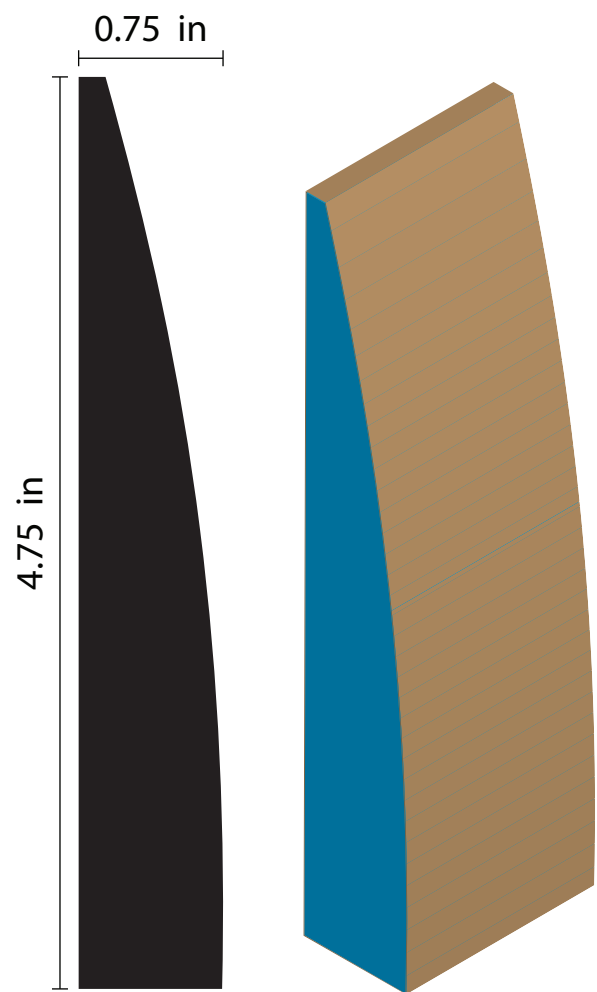

**BS-023**

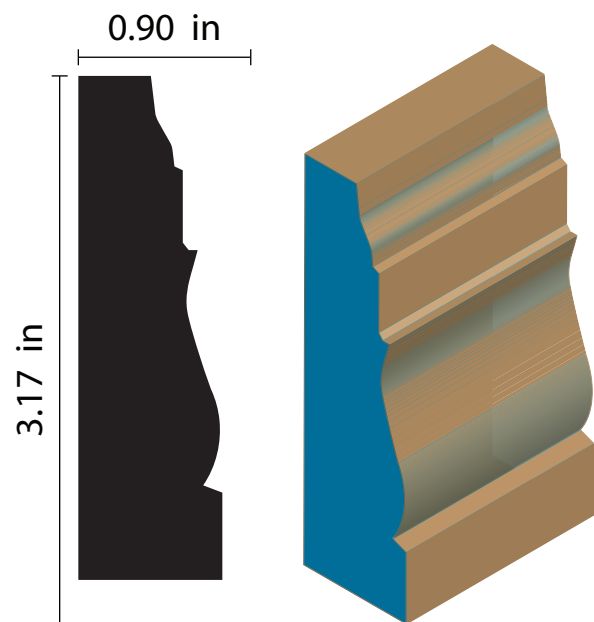

**BS-022**

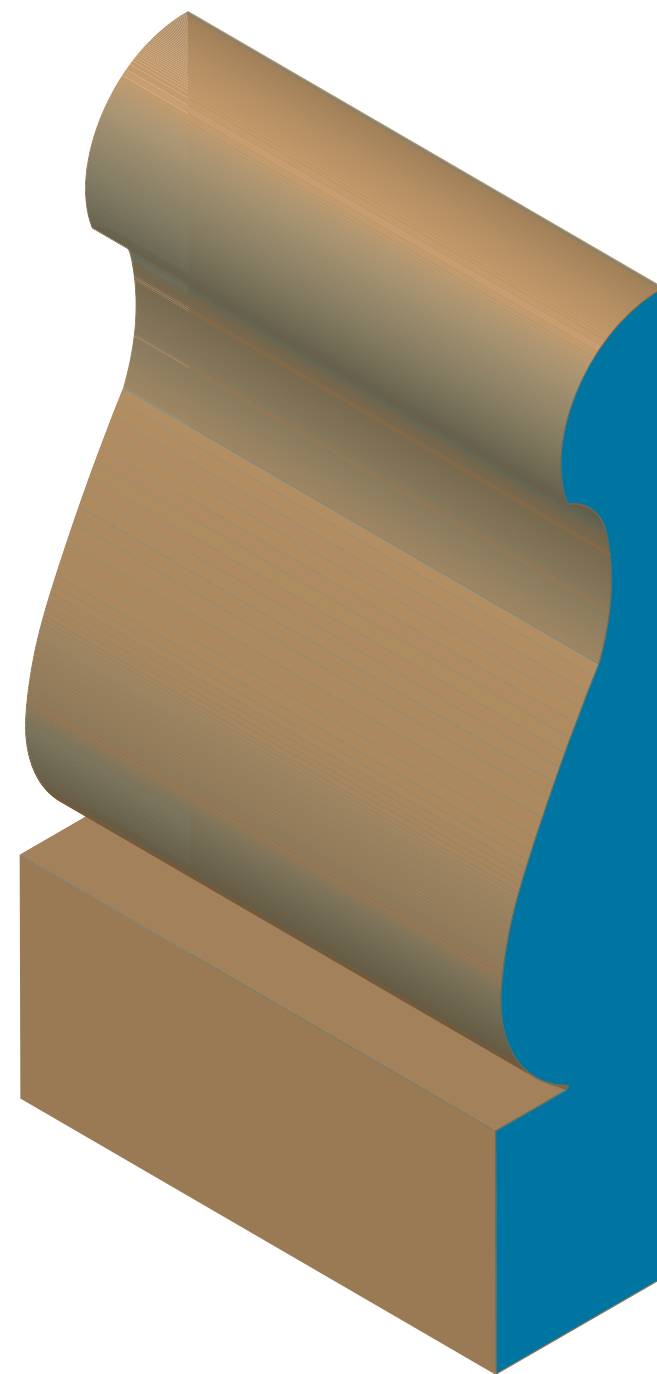

**BS-024**



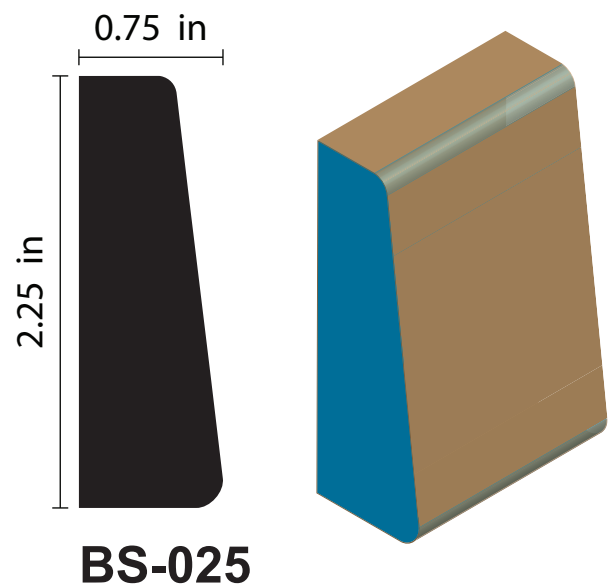

BS-025

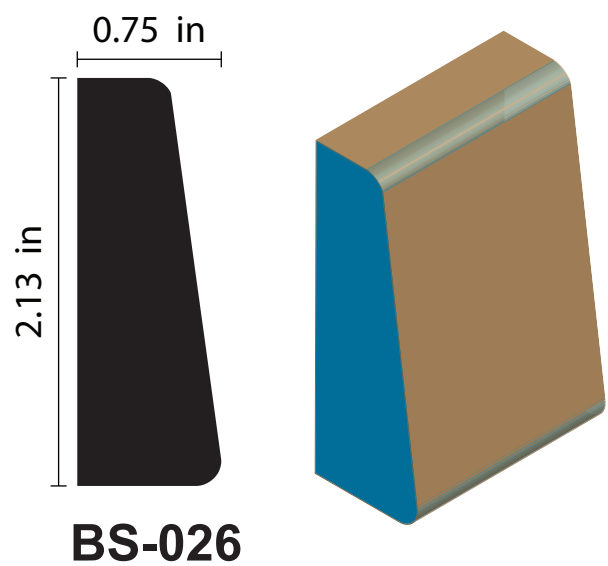

BS-026

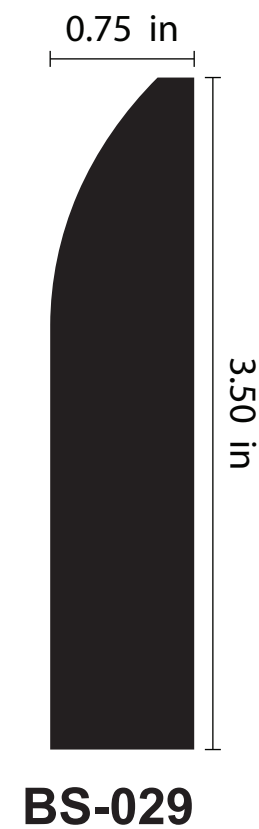

BS-029

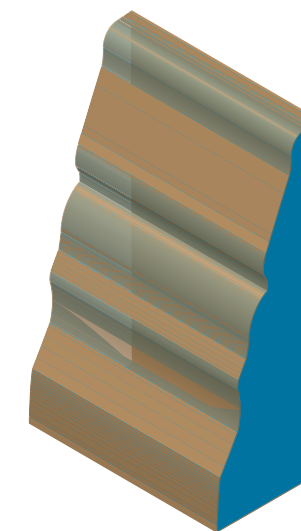

BS-031

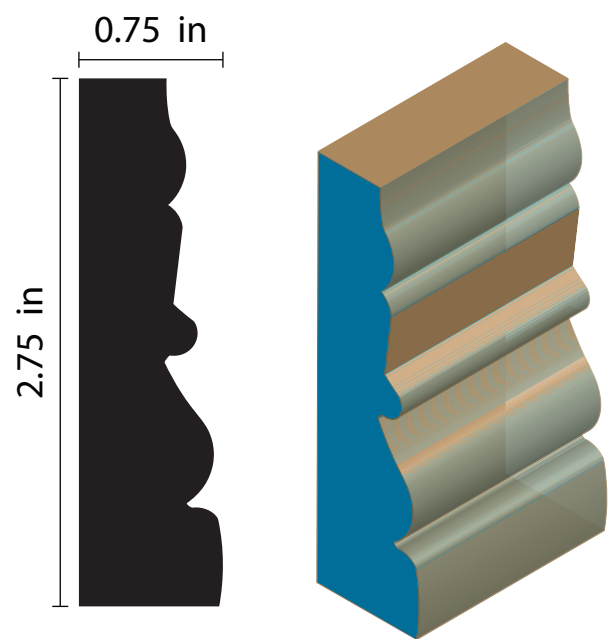

BS-027

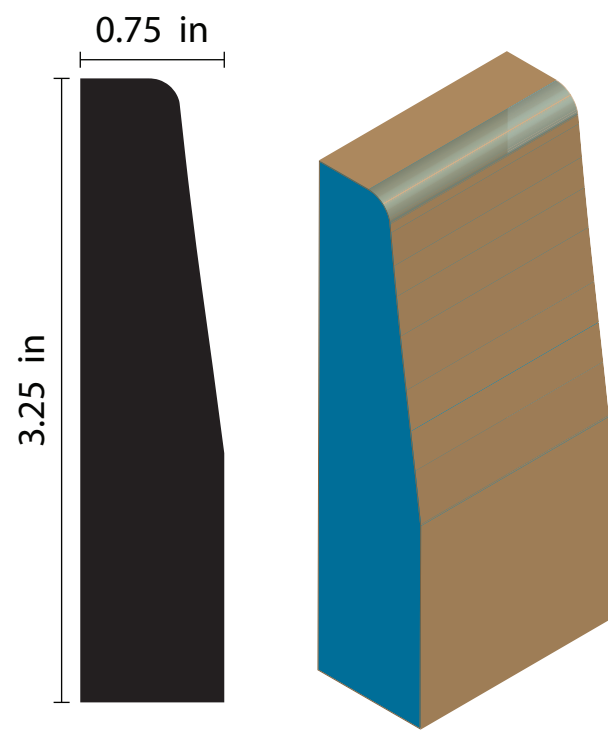

BS-028

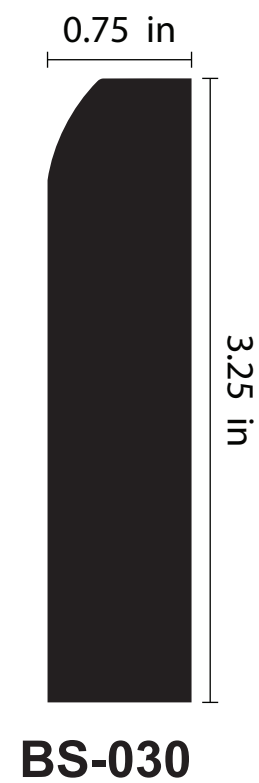
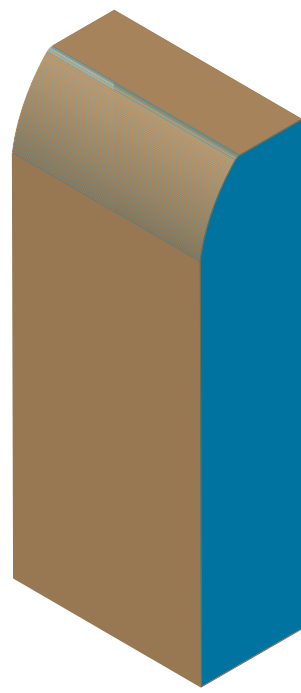

BS-030

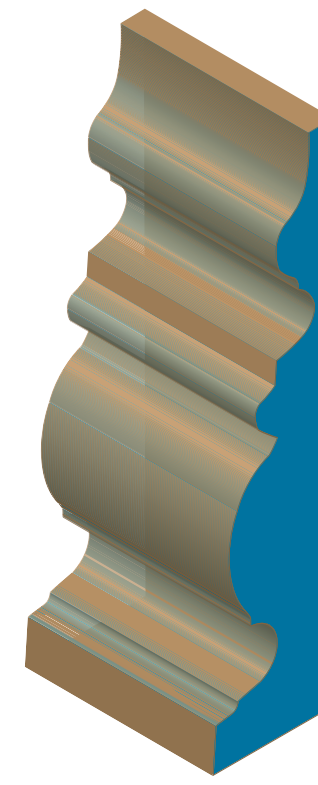

BS-032



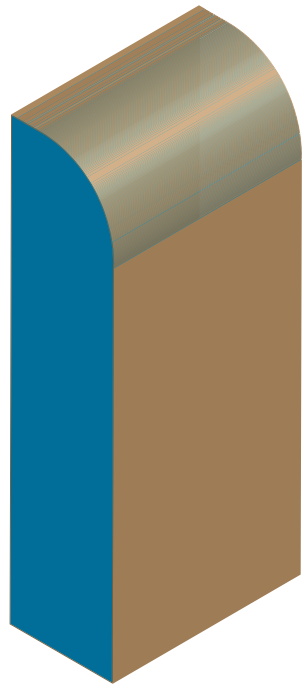
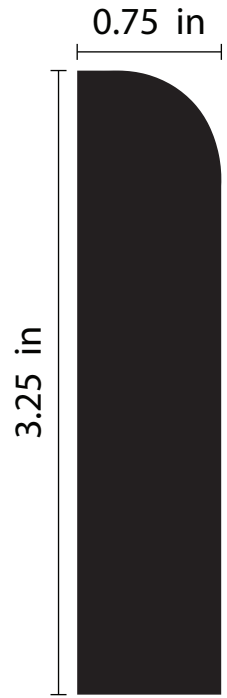

BS-033

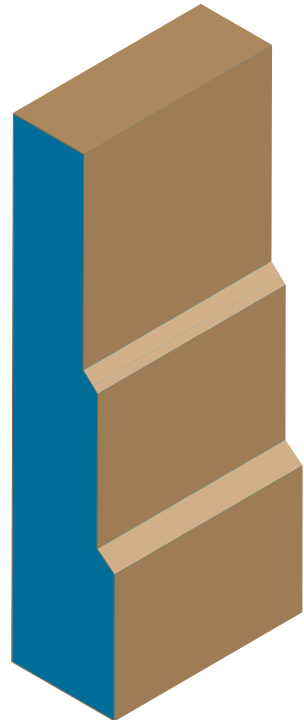
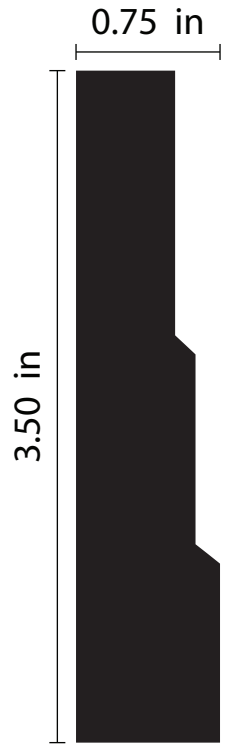

BS-034

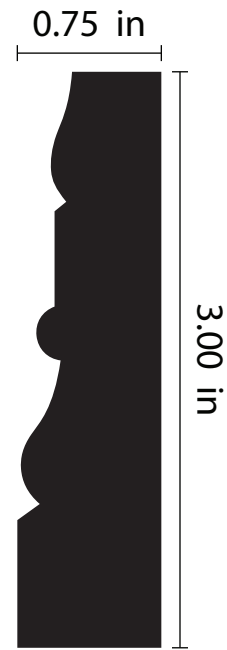
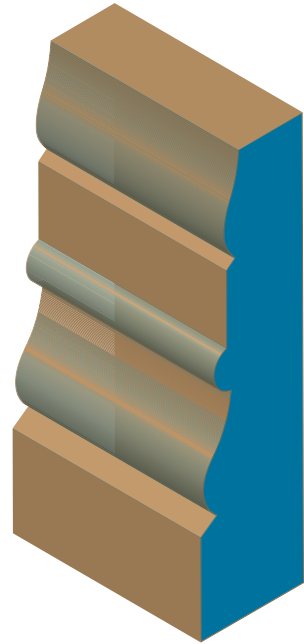

BS-037

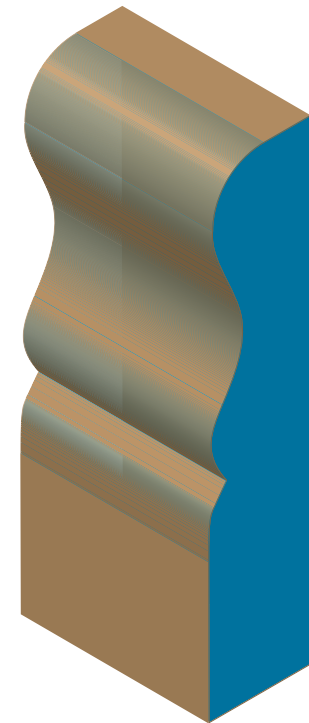

BS-038

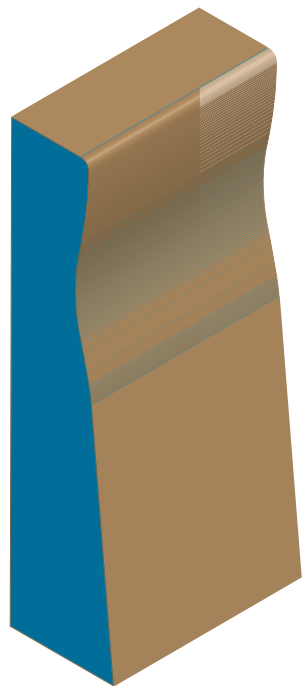
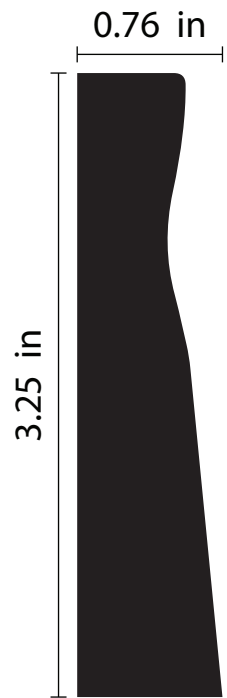

BS-035

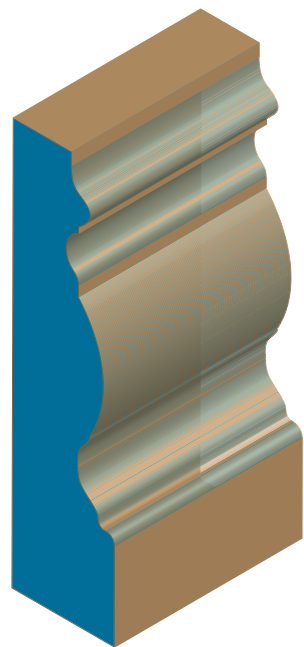
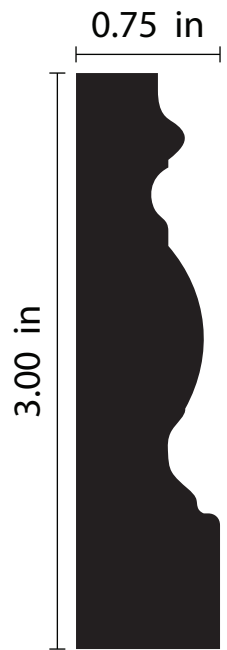

BS-036

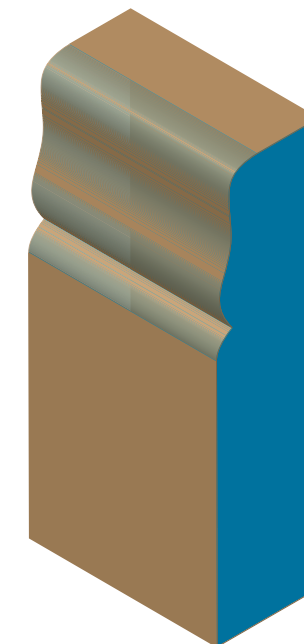

BS-039

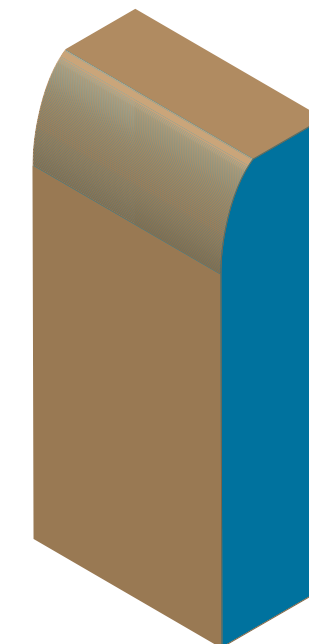

BS-040



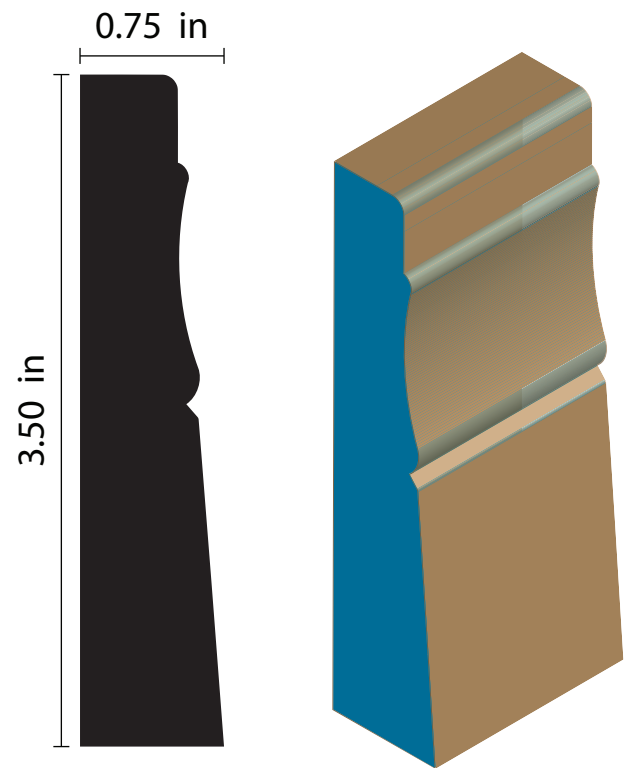

BS-042

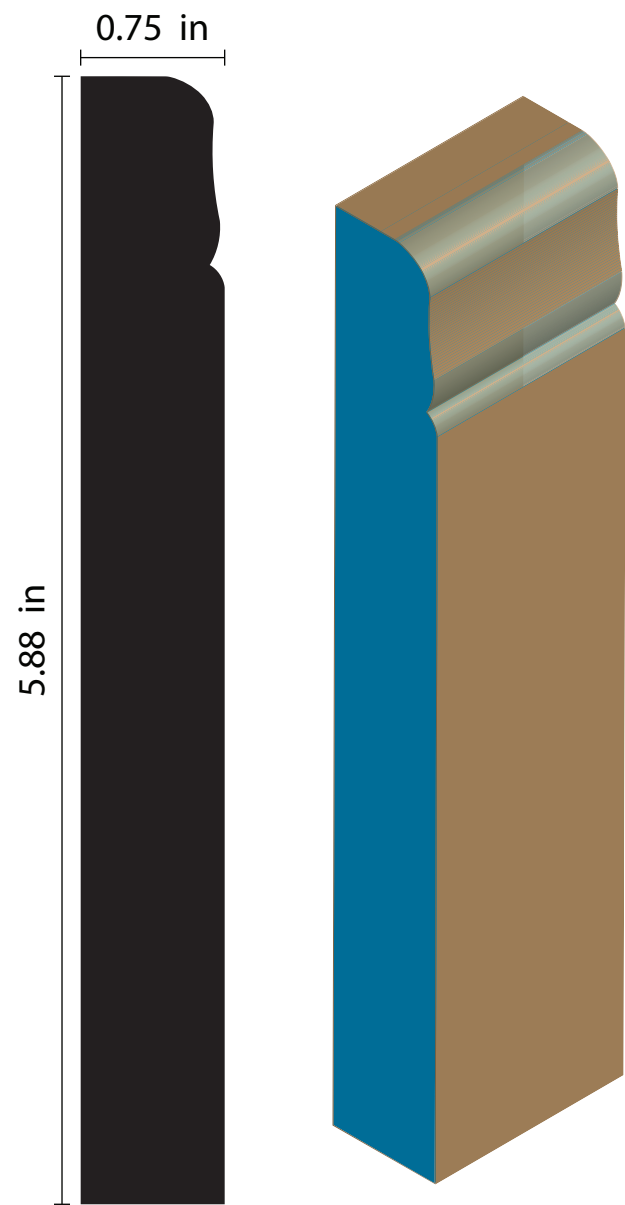

BS-041

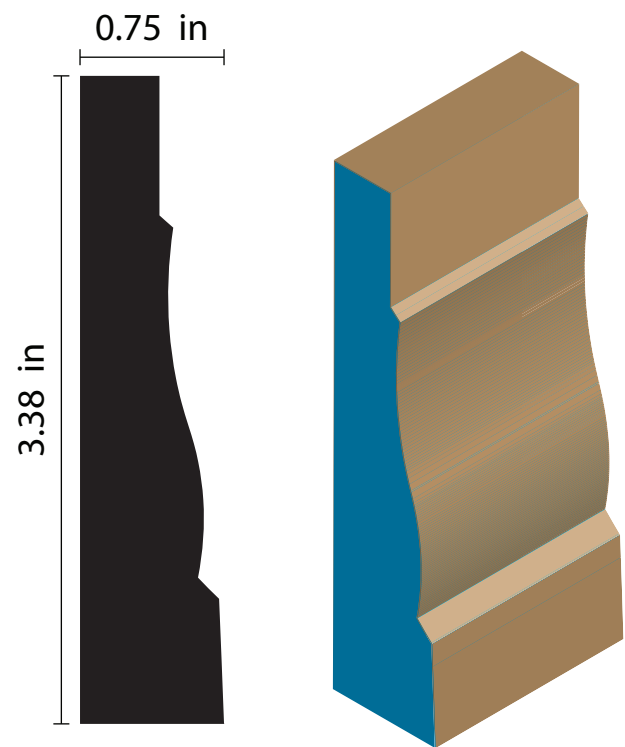

BS-043

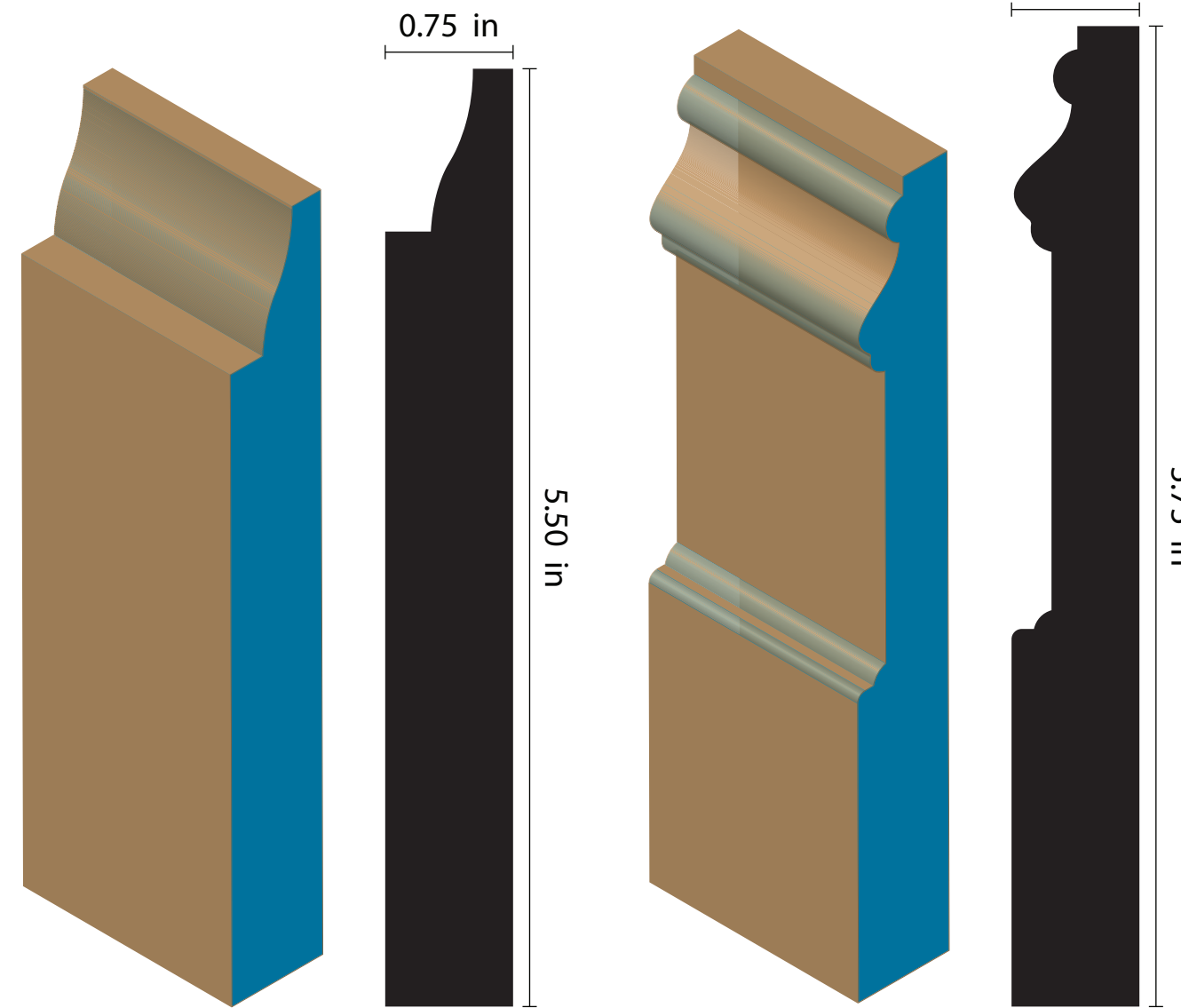

BS-044

BS-045





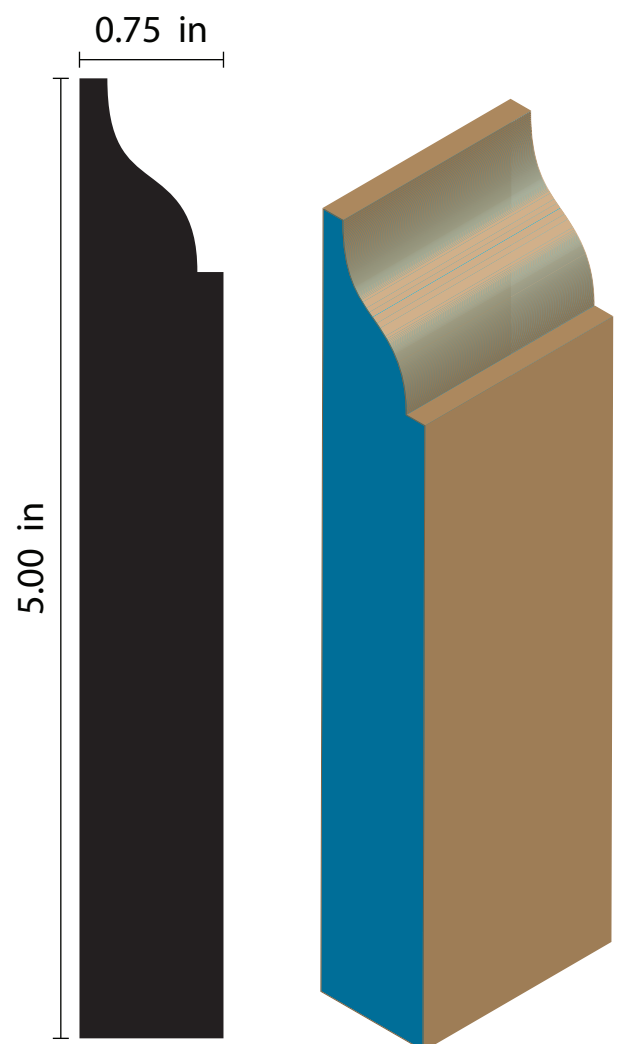

BS-046

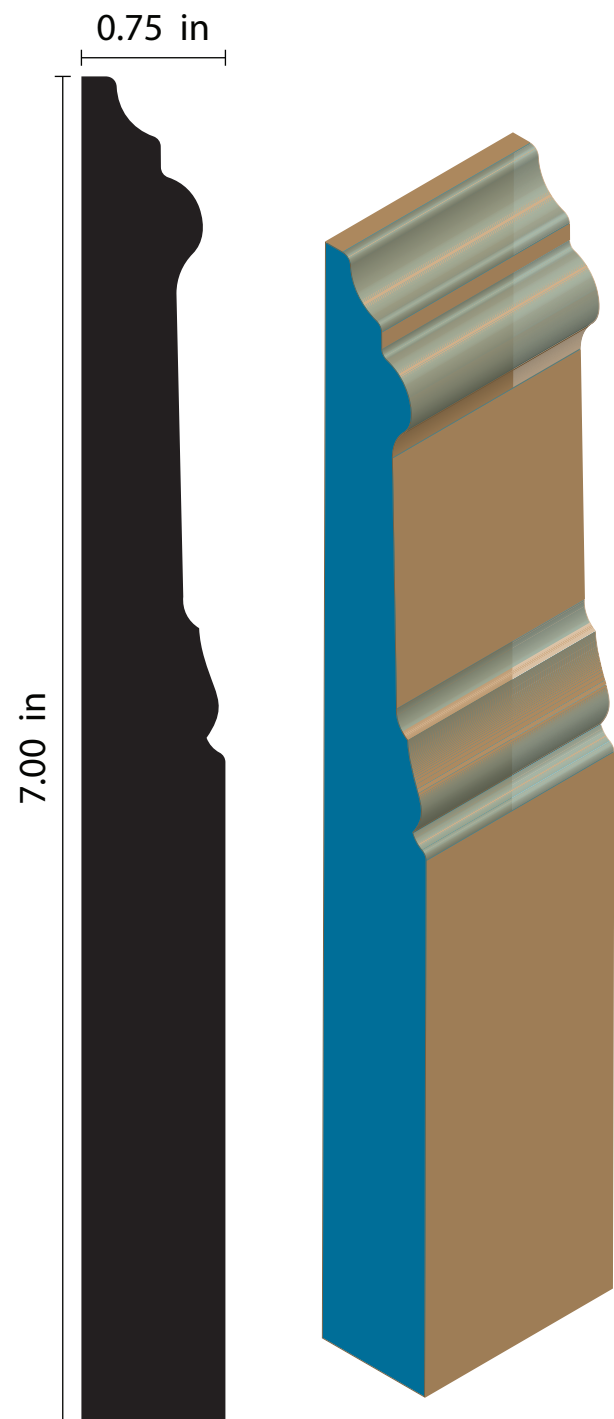

BS-047

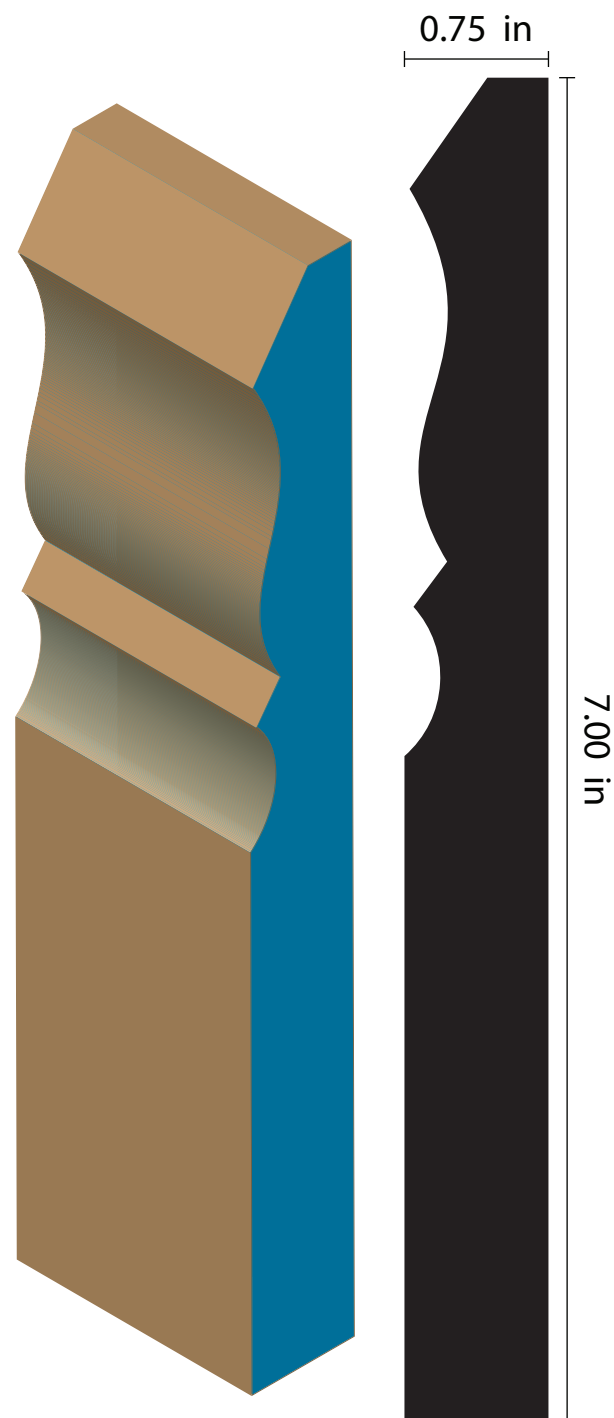

BS-048



BS-049

7.00 in



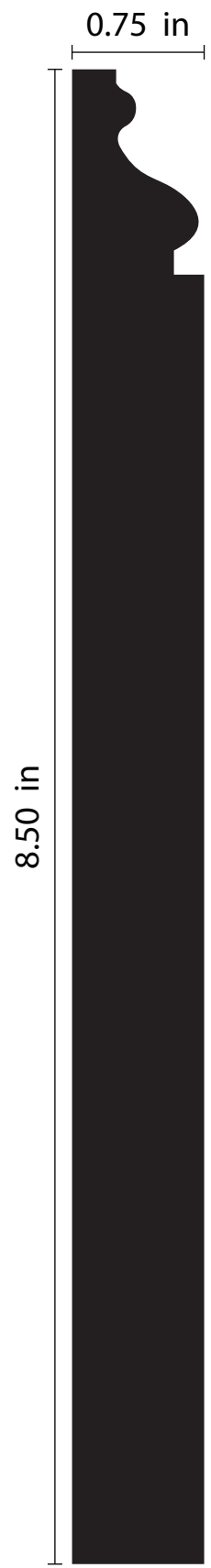

BS-050

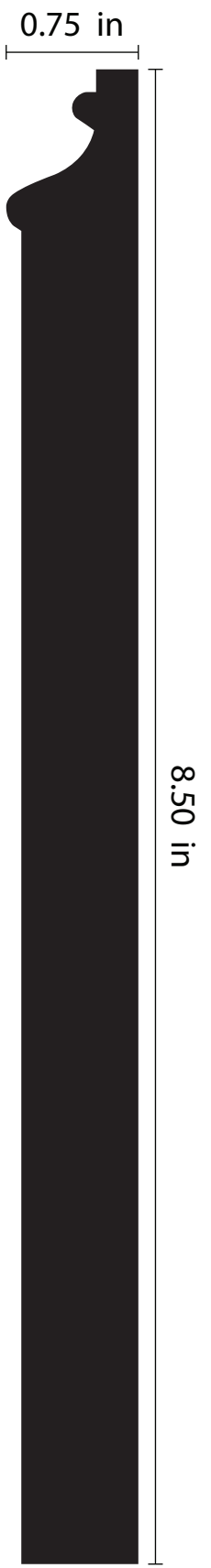
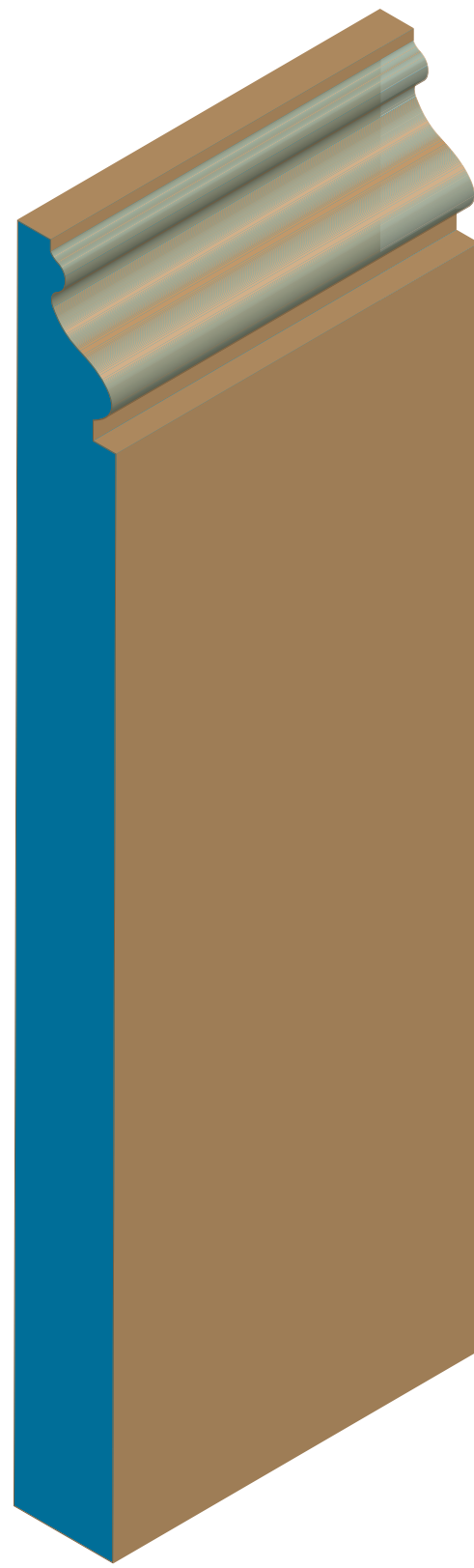

BS-051



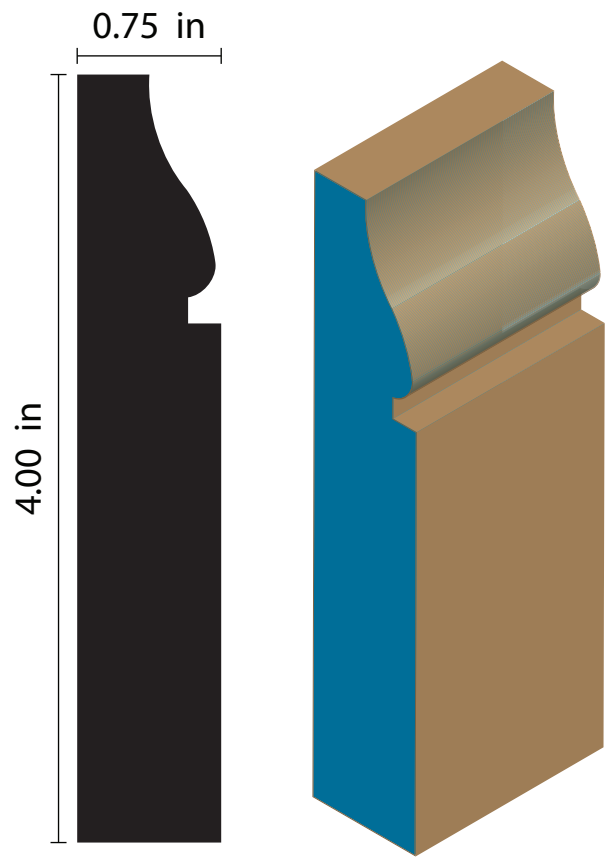

**BS-052**

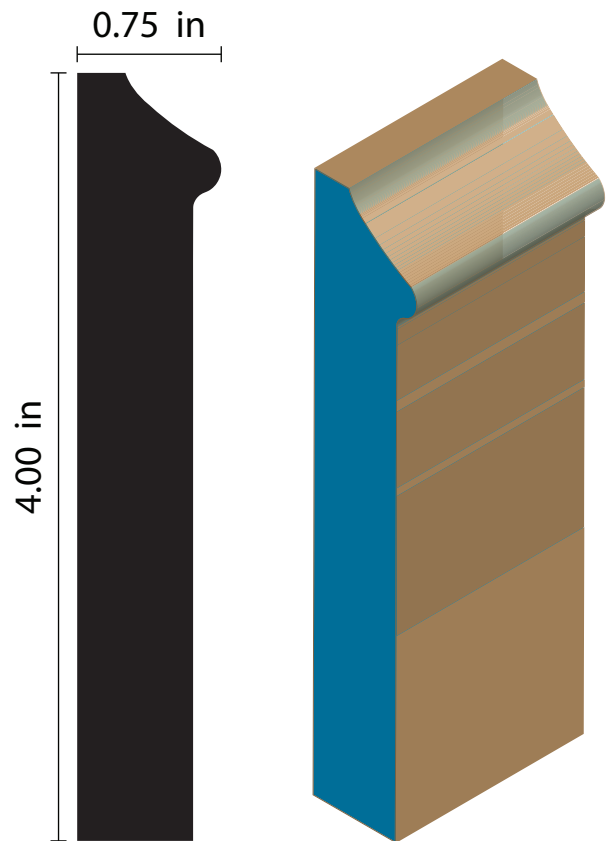

**BS-053**

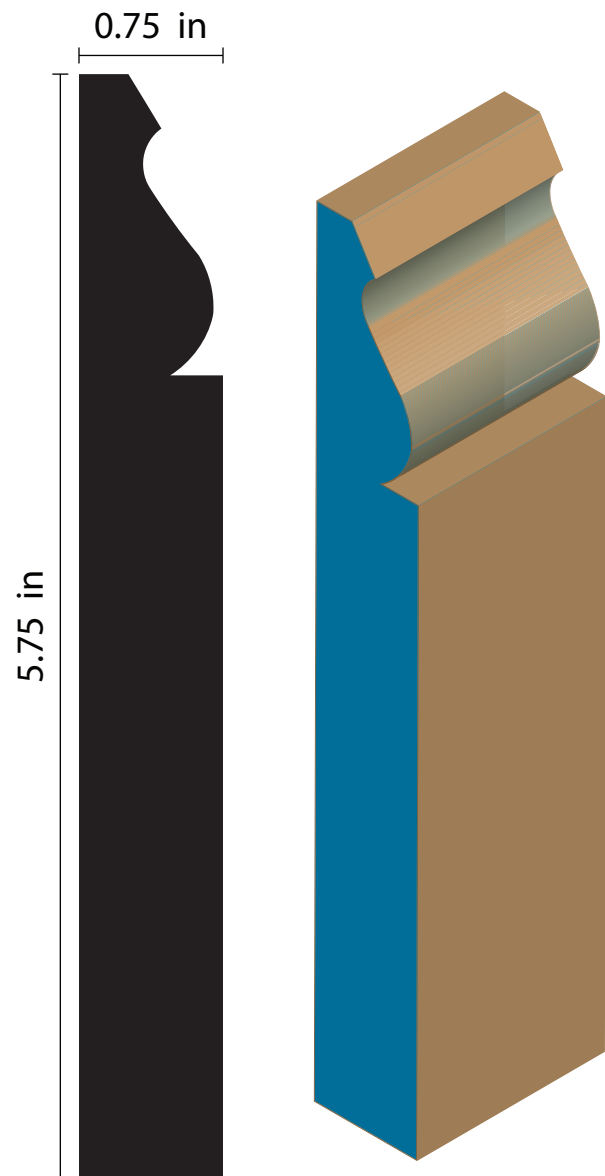

**BS-054**

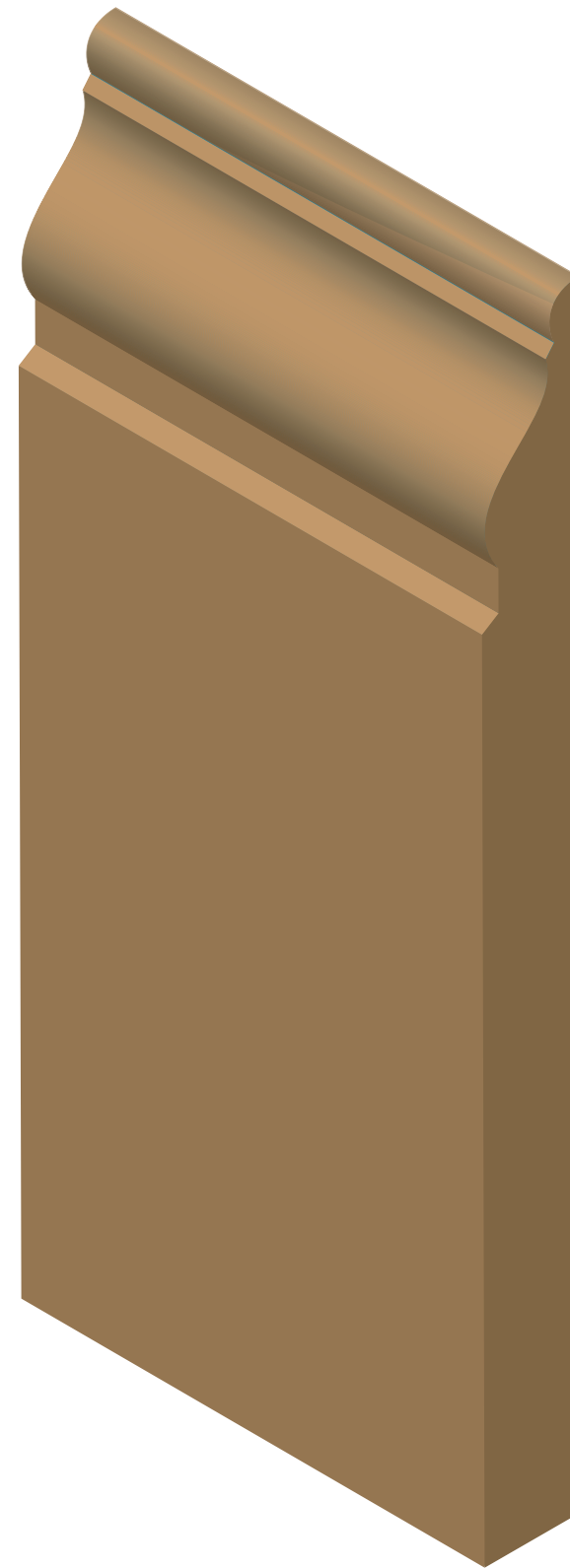

**BS-055**



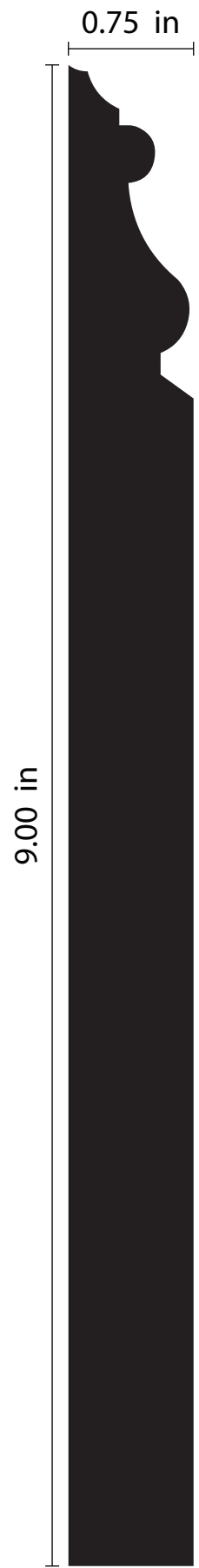

BS-064

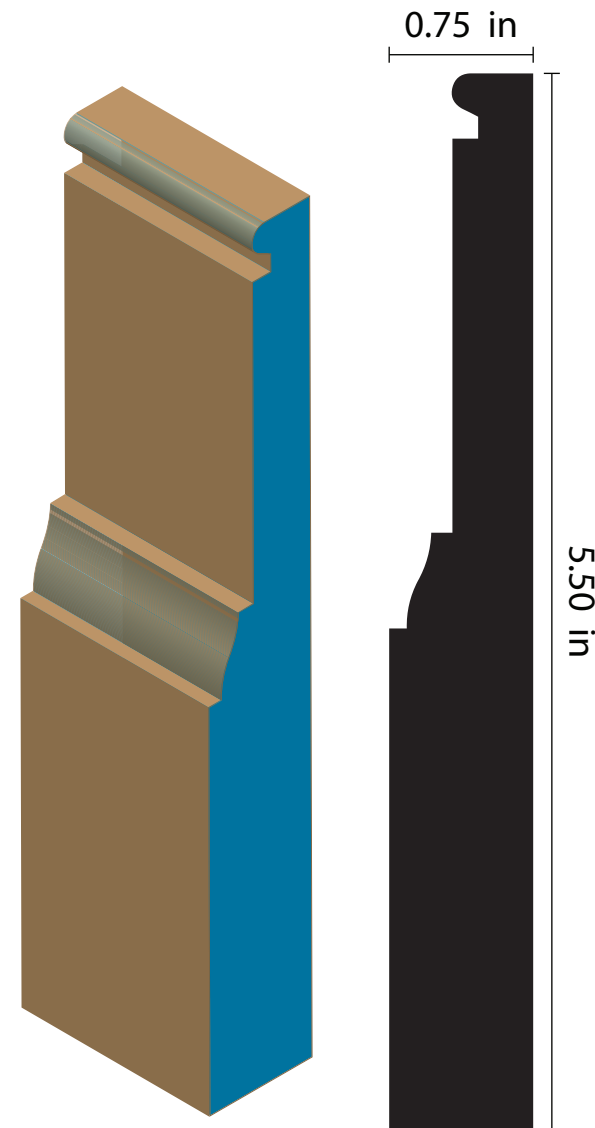
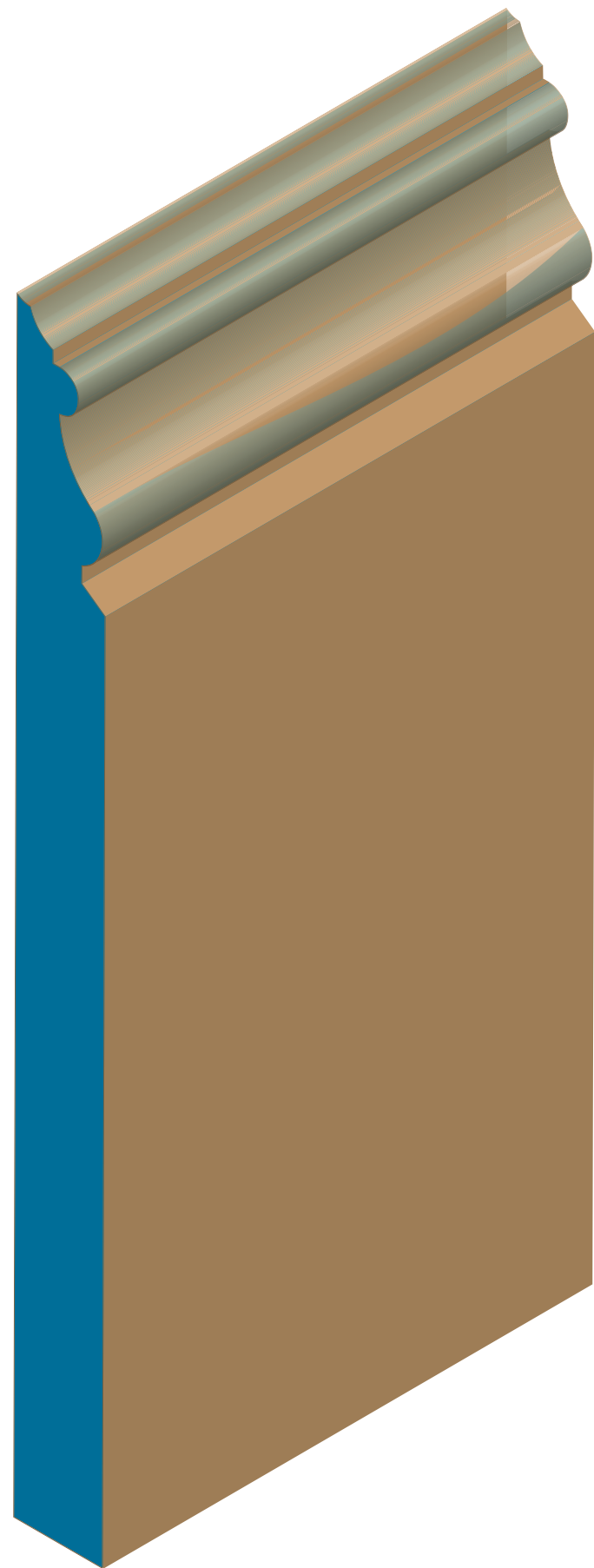

BS-063



BS-065





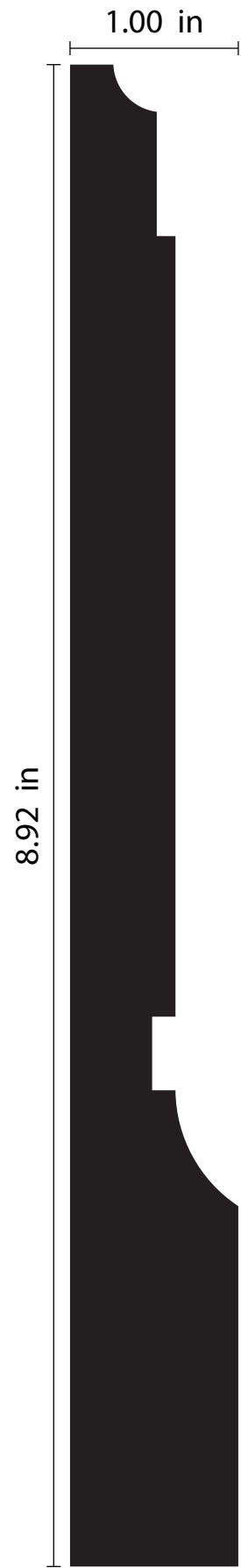

BS-066

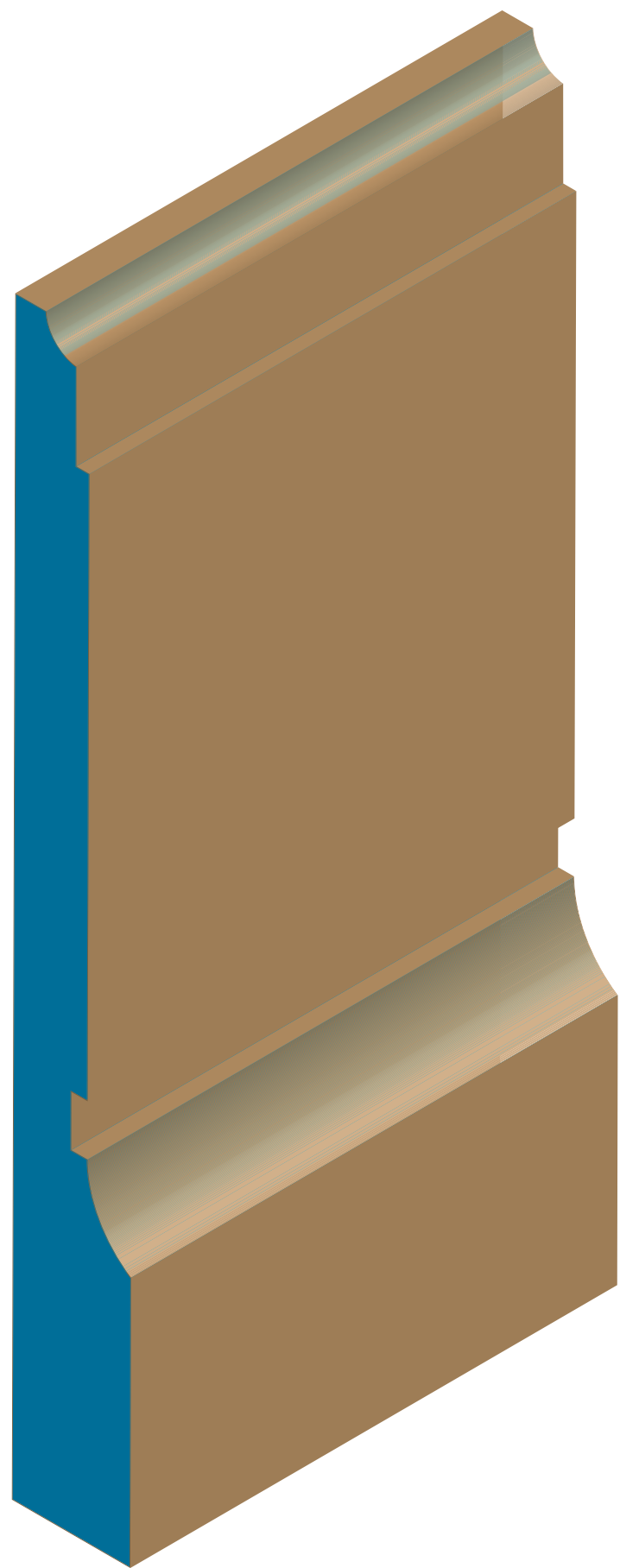

BS-067/68

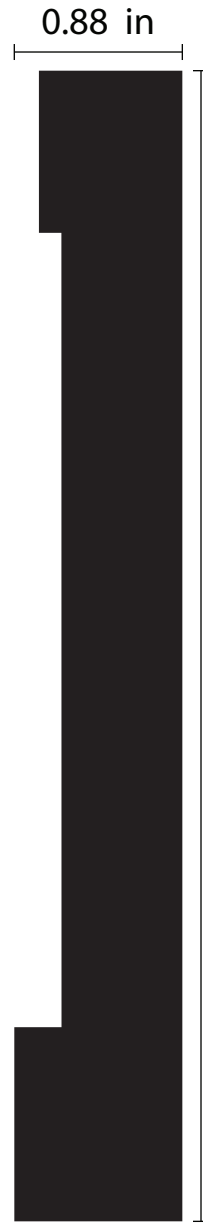

BS-071

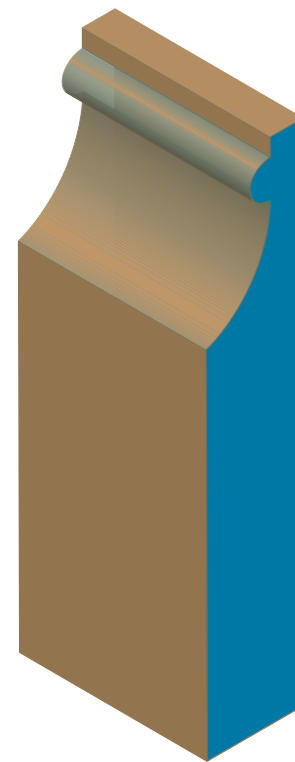

BS-069



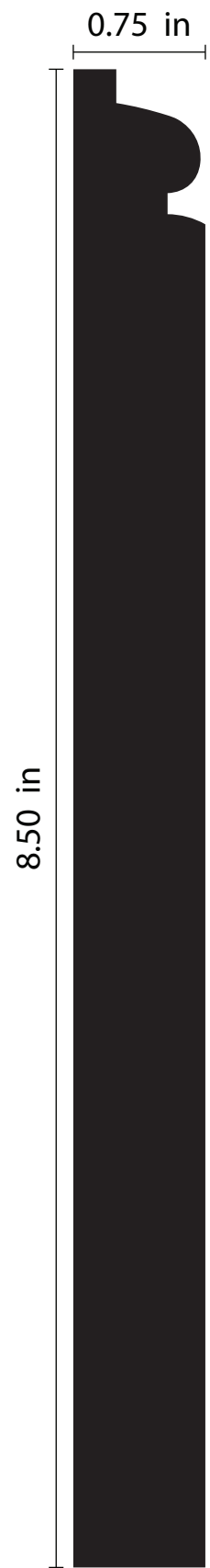

BS-070

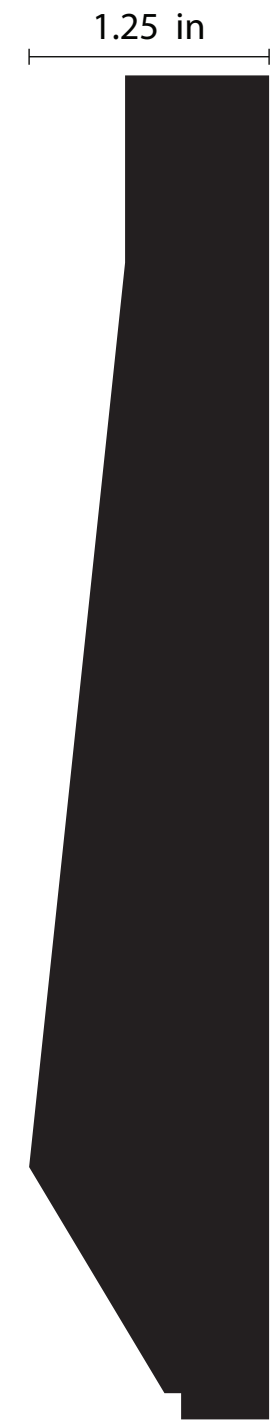
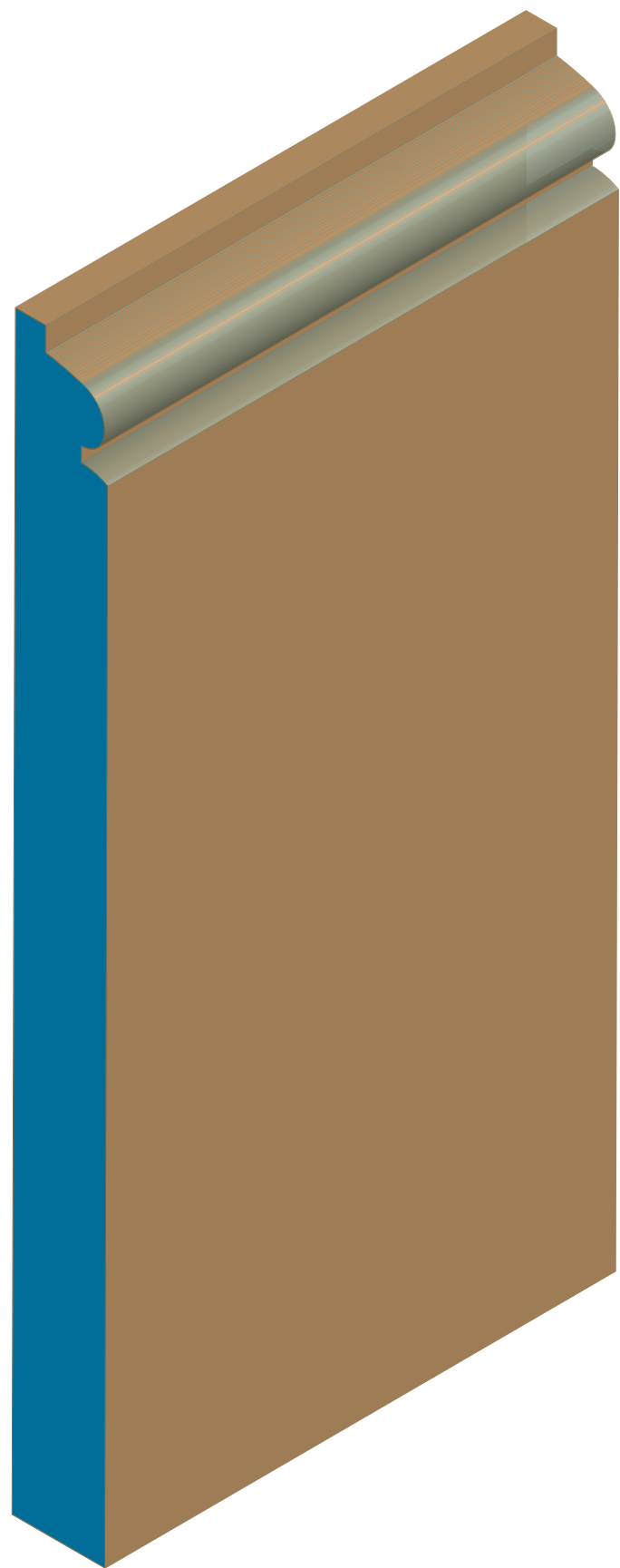

BS-073



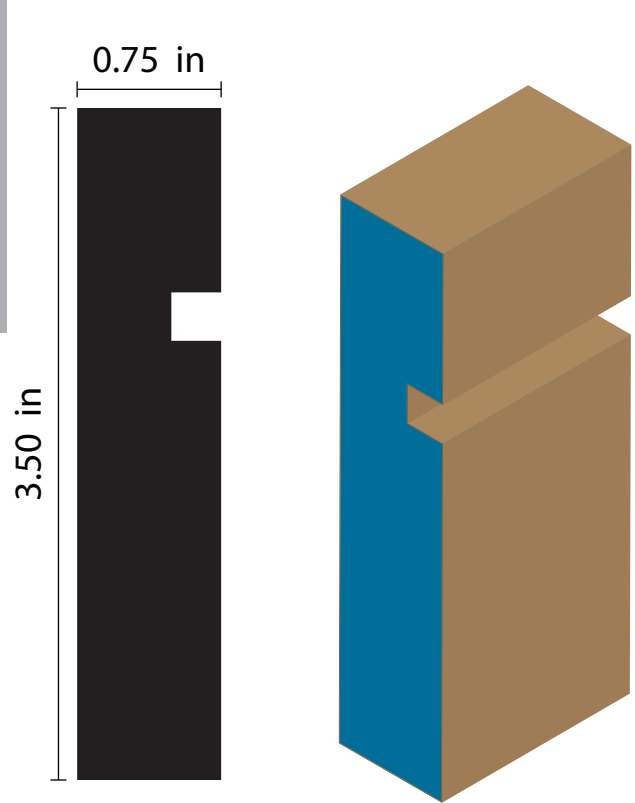

BS-072

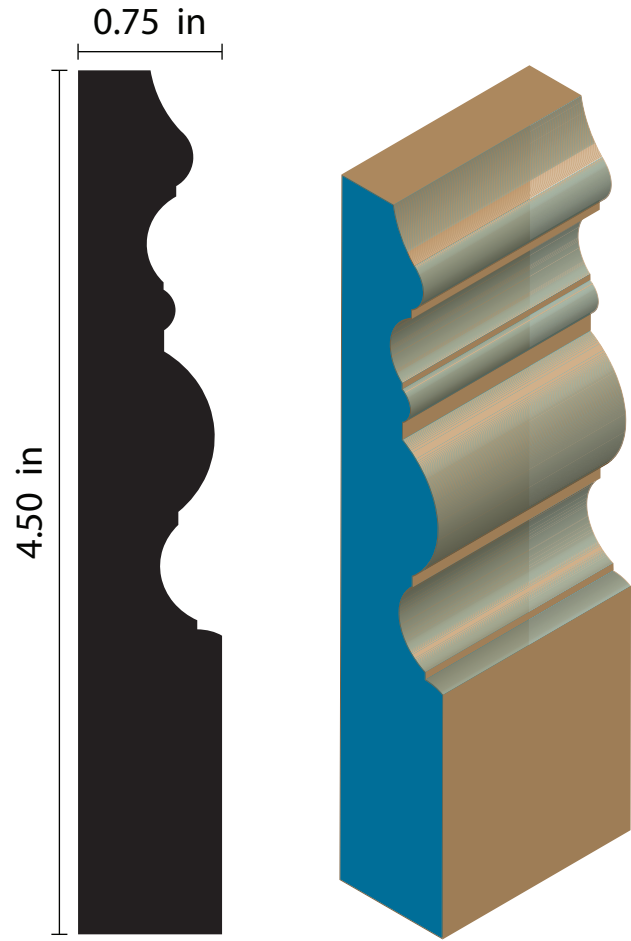

BS-075

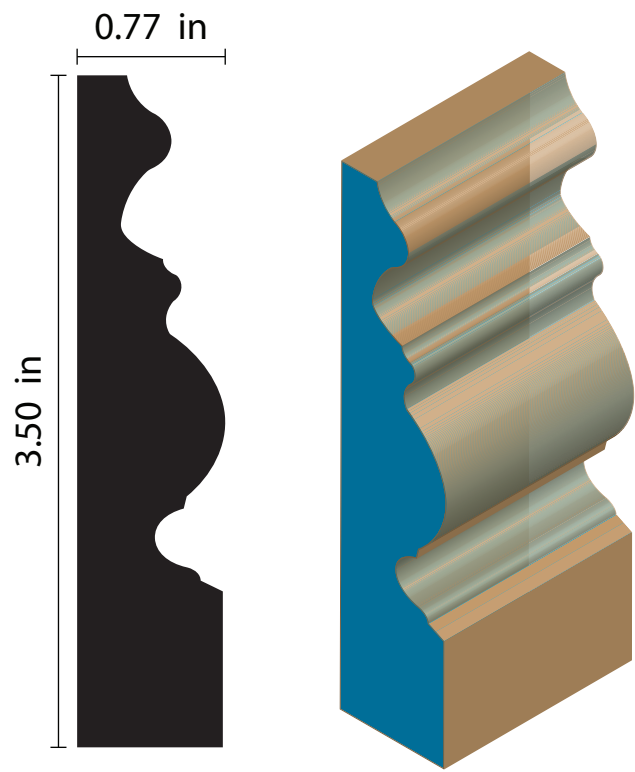

BS-077

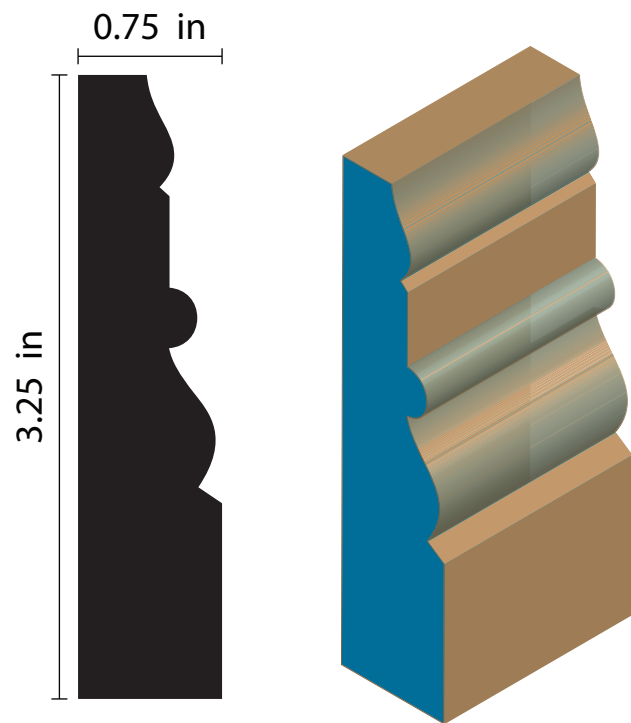

BS-074



BS-076

7.50 in



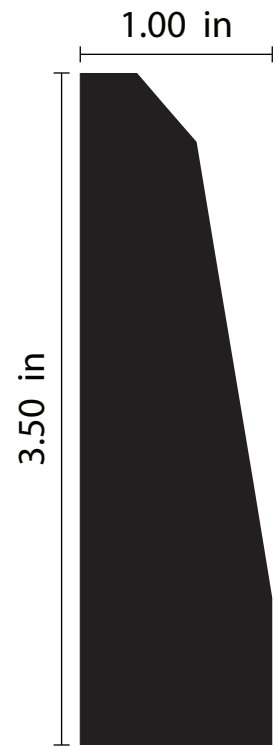

BS-078

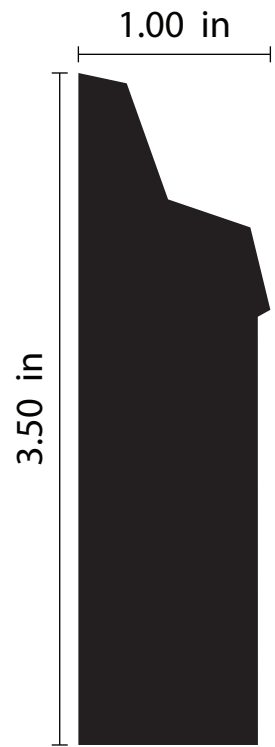
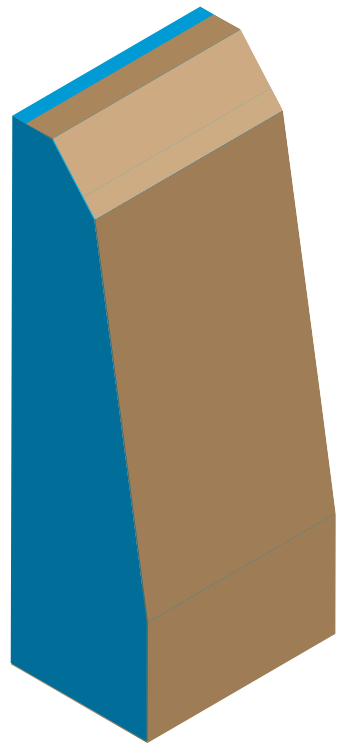

BS-080

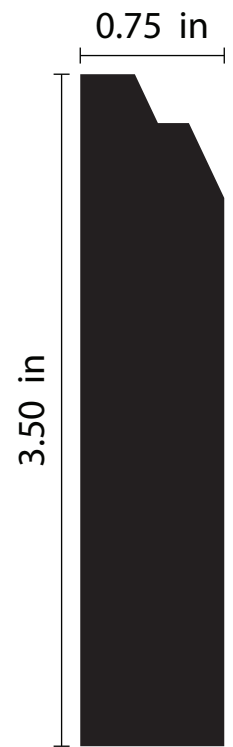

BS-079

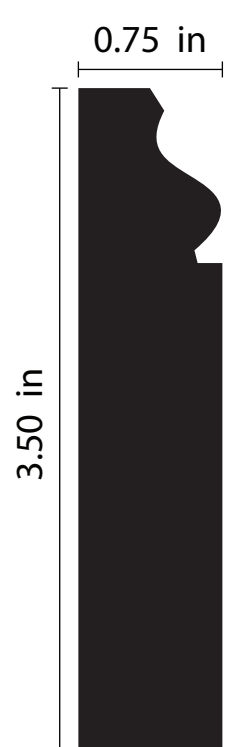
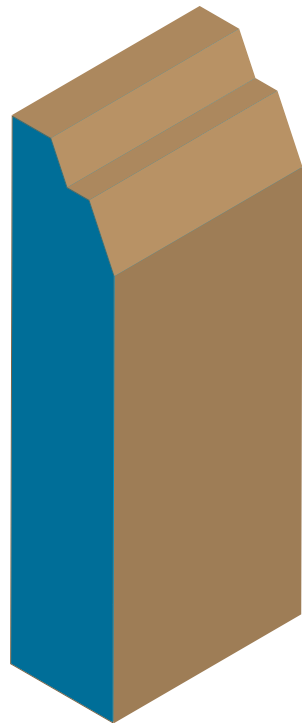

BS-081

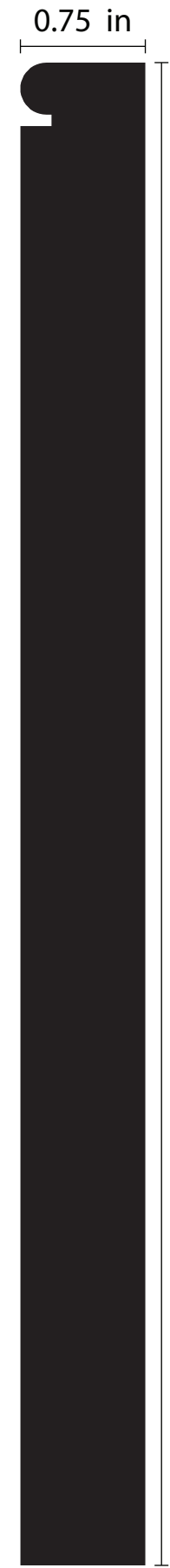
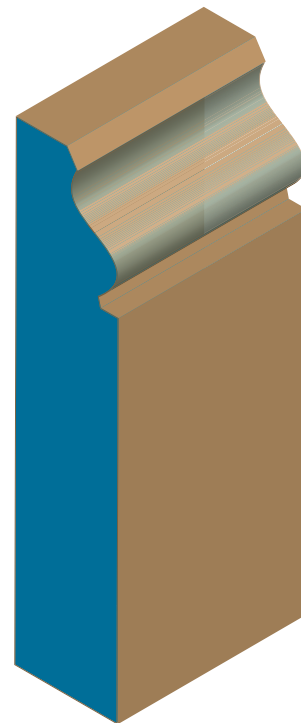

BS-082

9.00 in





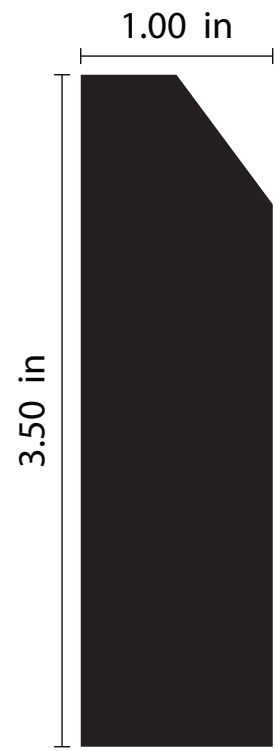

BS-083

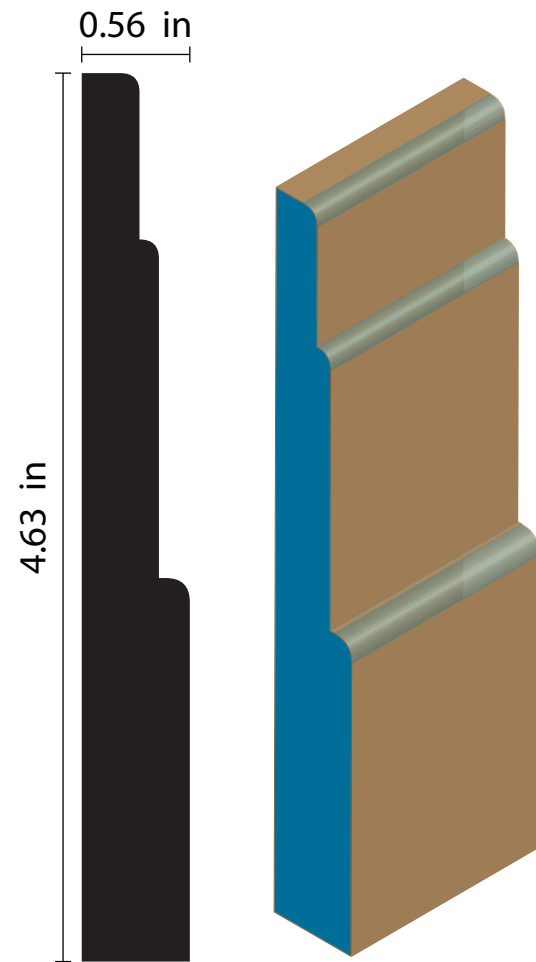

BS 086



BS-087

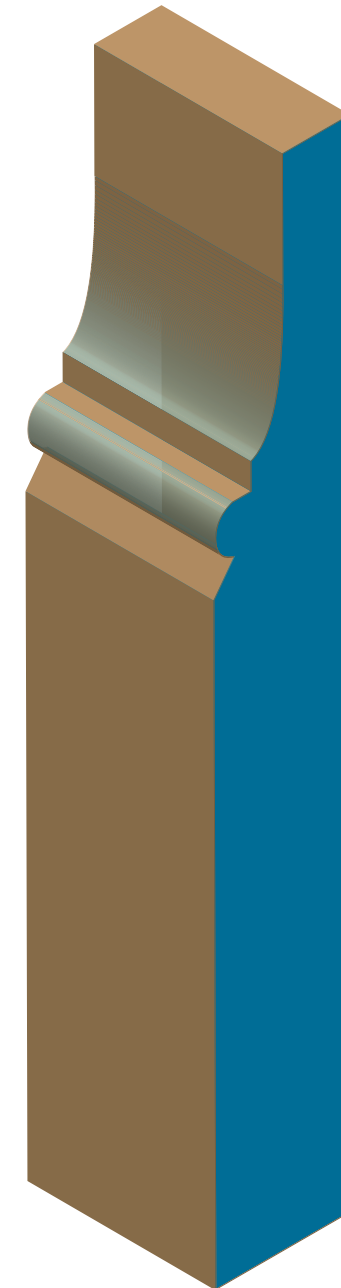

BS-085

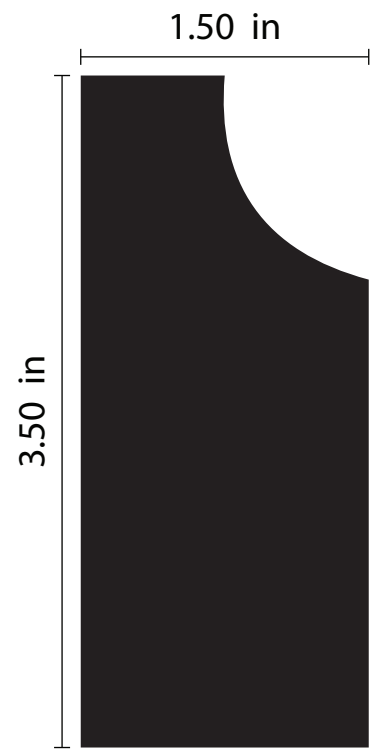

BS-084



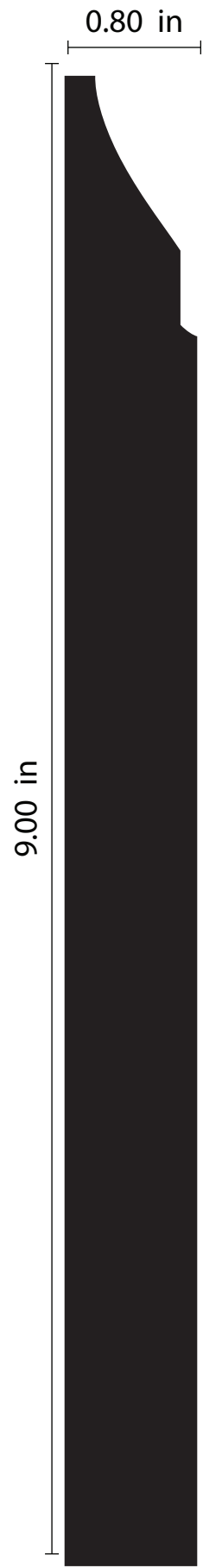

**BS-088**

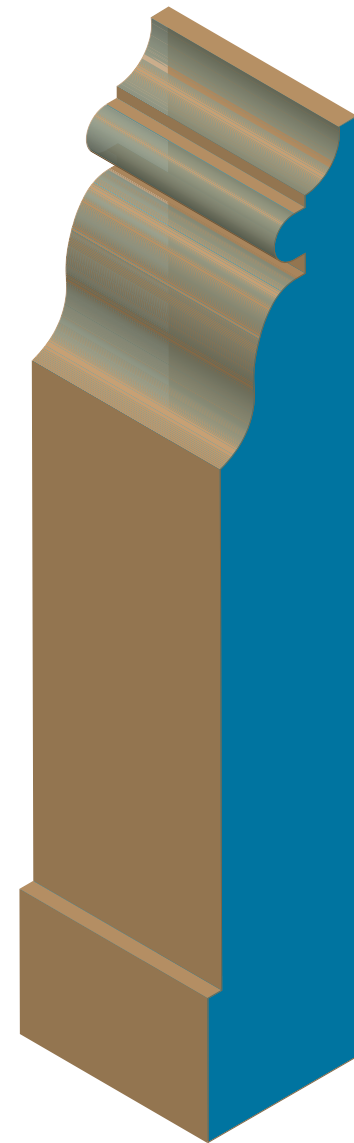
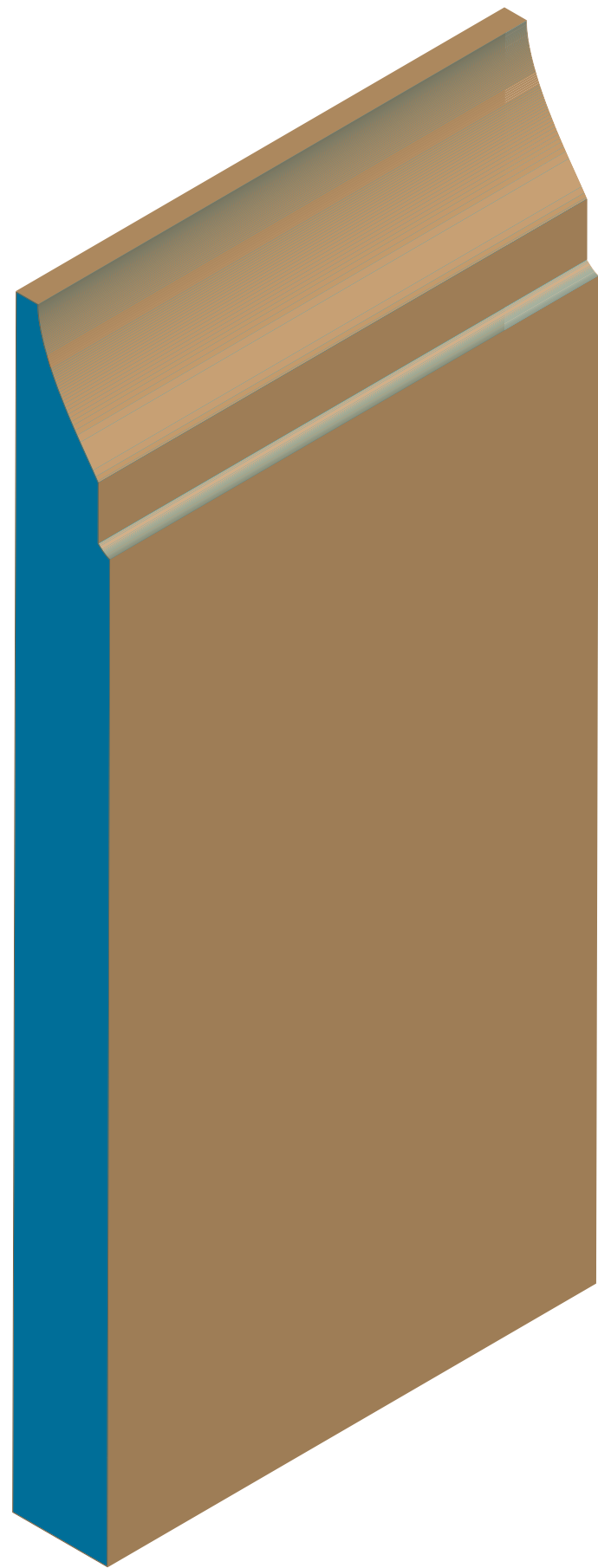

1.10 in



**BS-089**

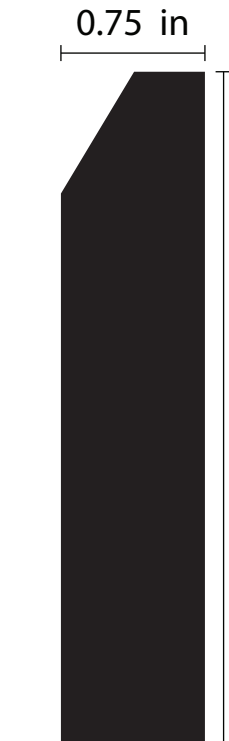

**BS-091**



**BS-092**





BS-090

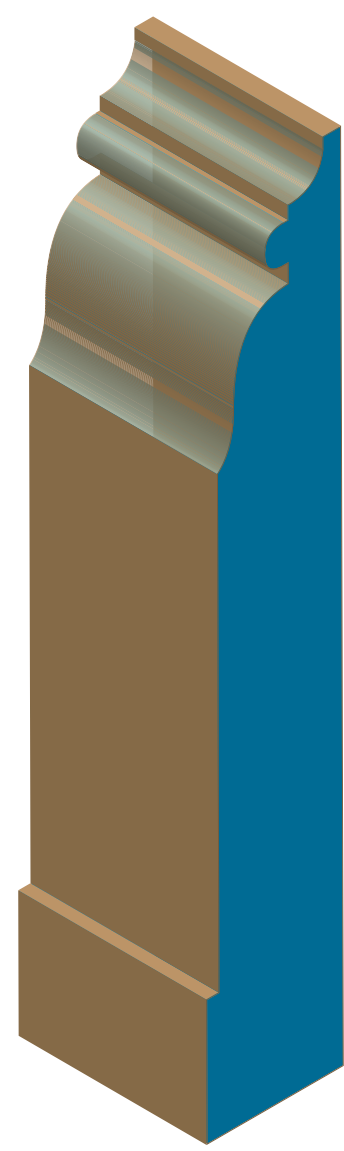
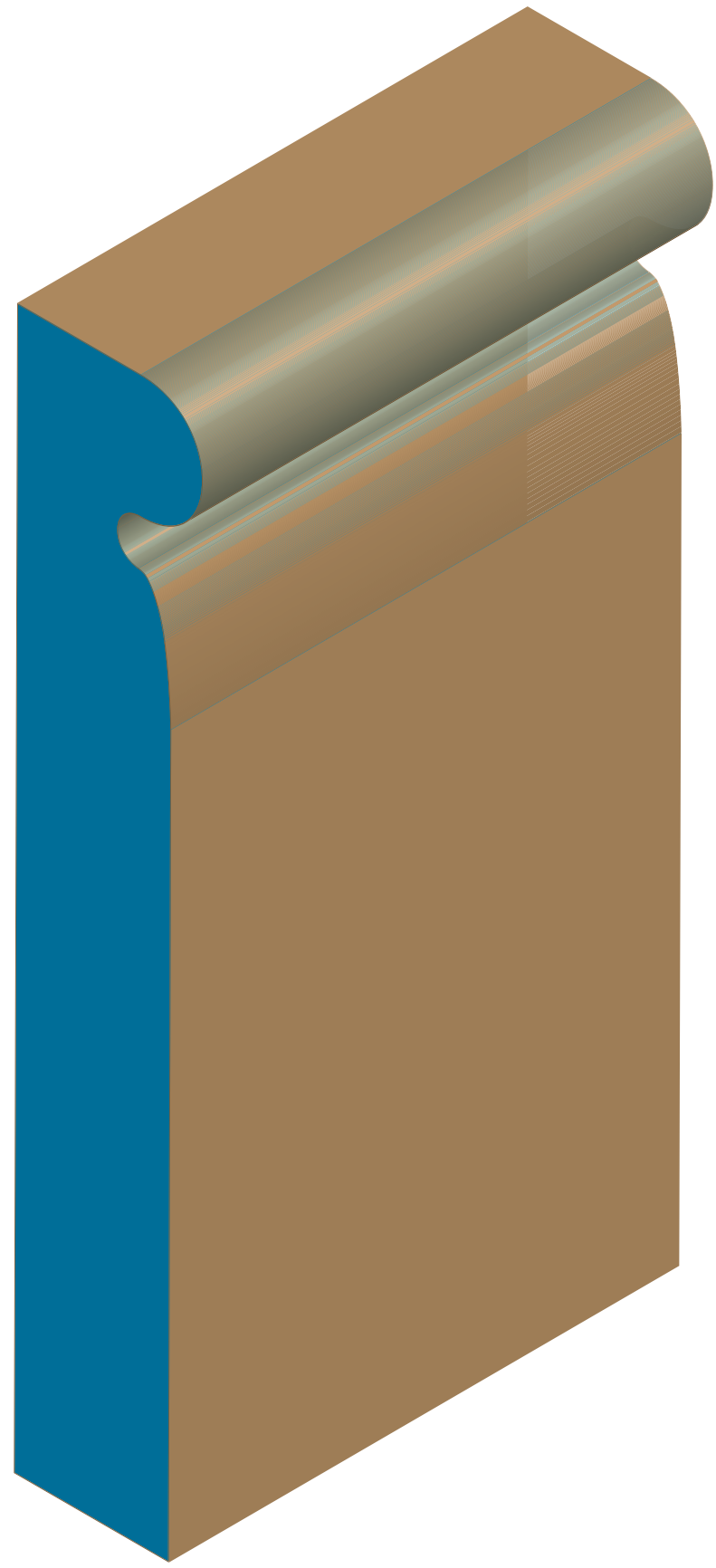

BS-094



BS-095



BS-096

