

MOLDING

CHAIR RAIL



PHILLIPS

FOREST PRODUCTS

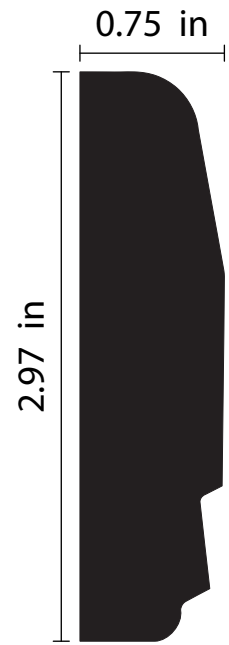

CR-001

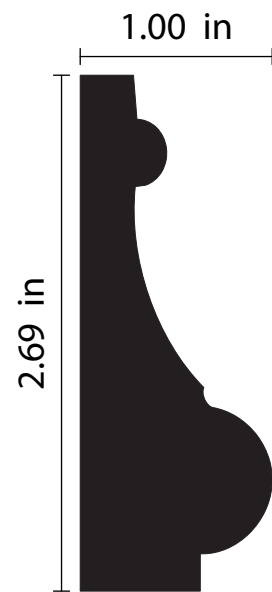
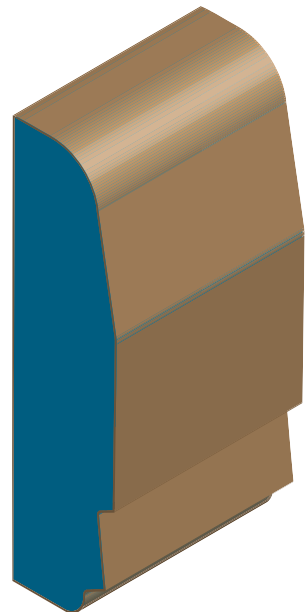

CR-002

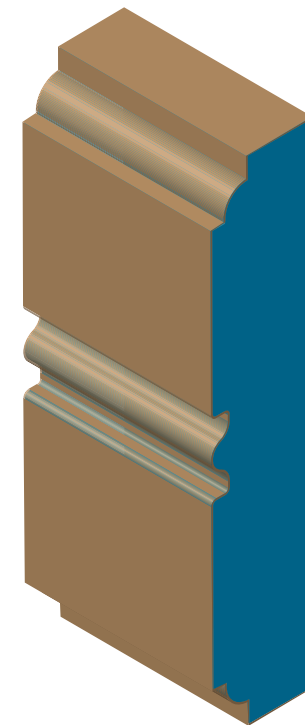
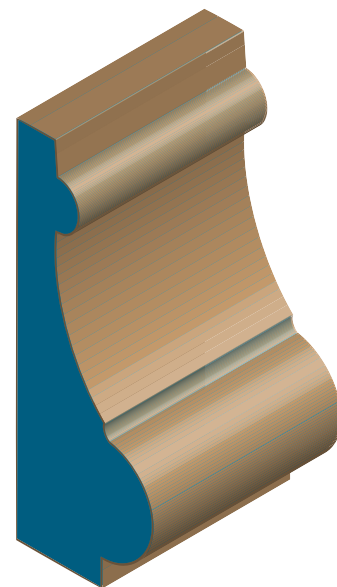

CR-005



CR-006

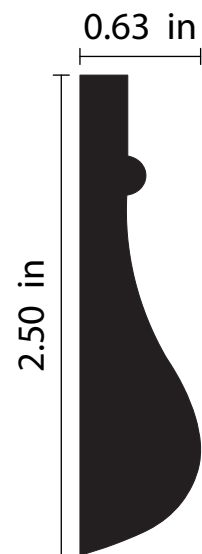

CR-003

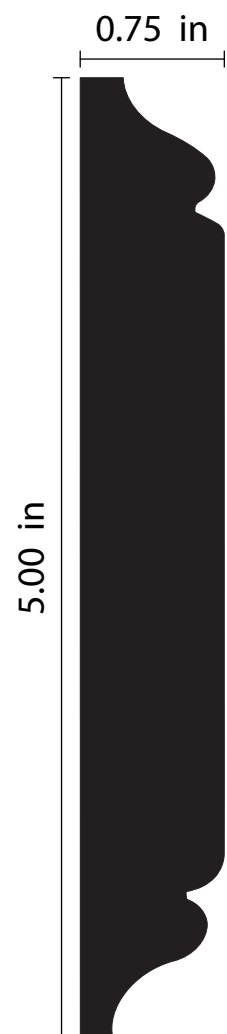
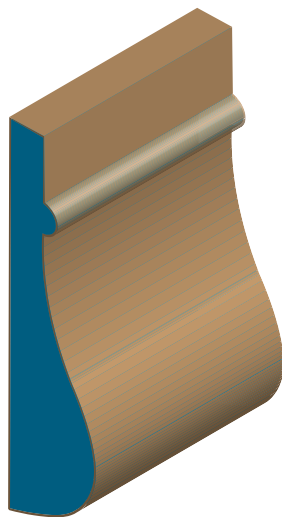

CR-004

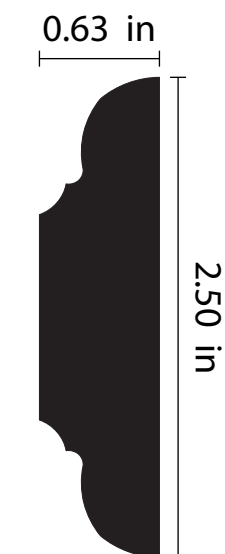
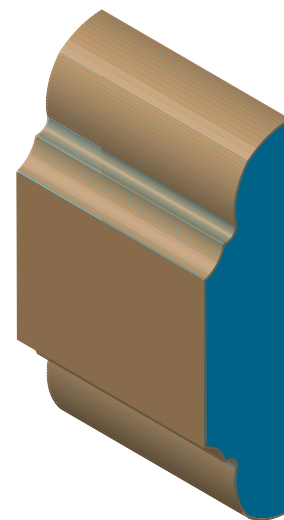
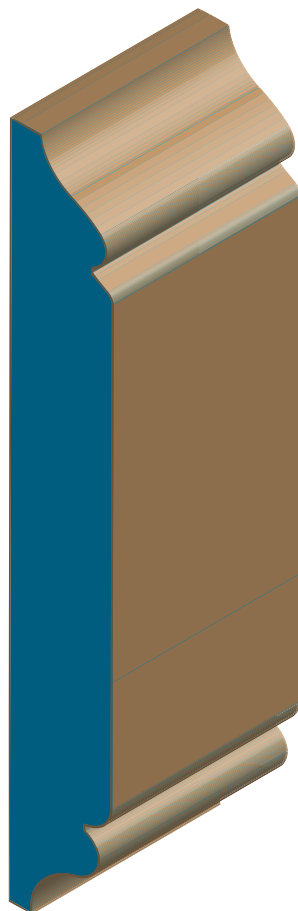

CR-007

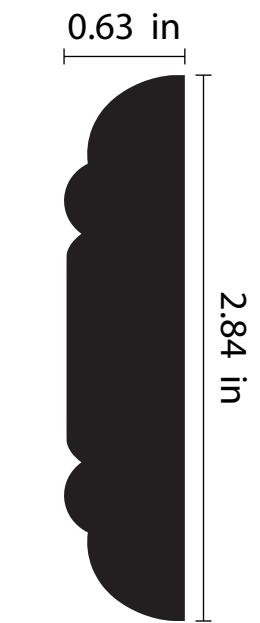

CR-008



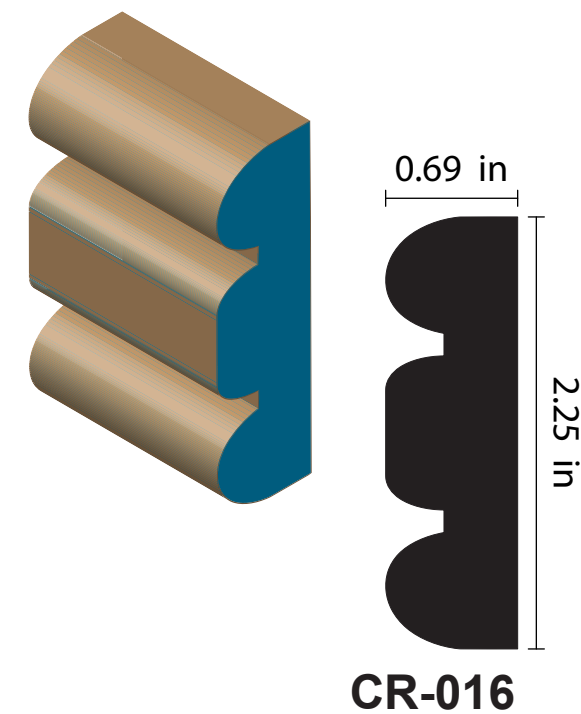
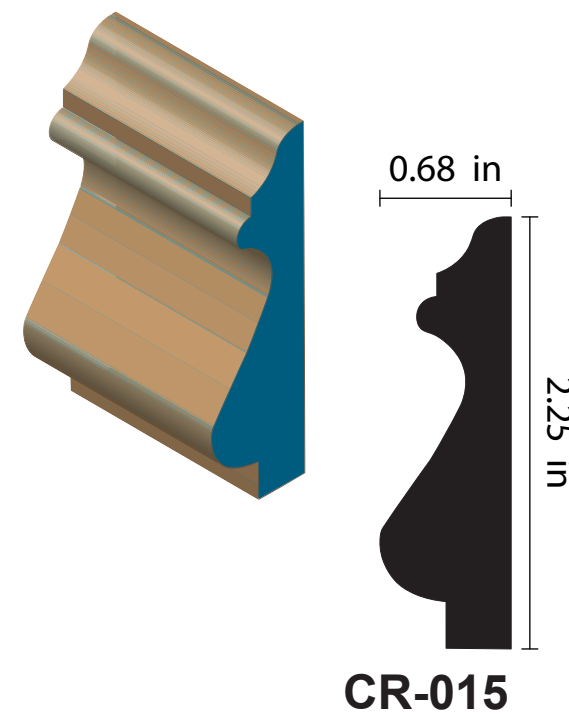
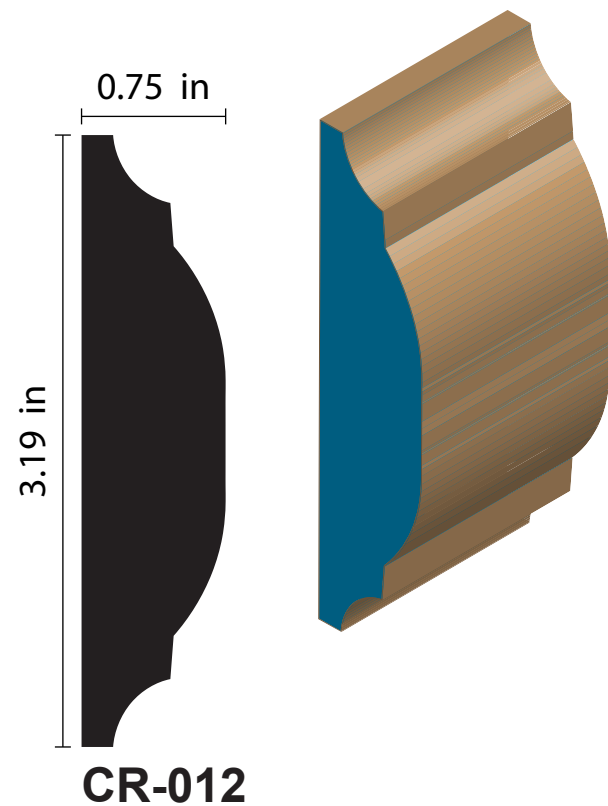
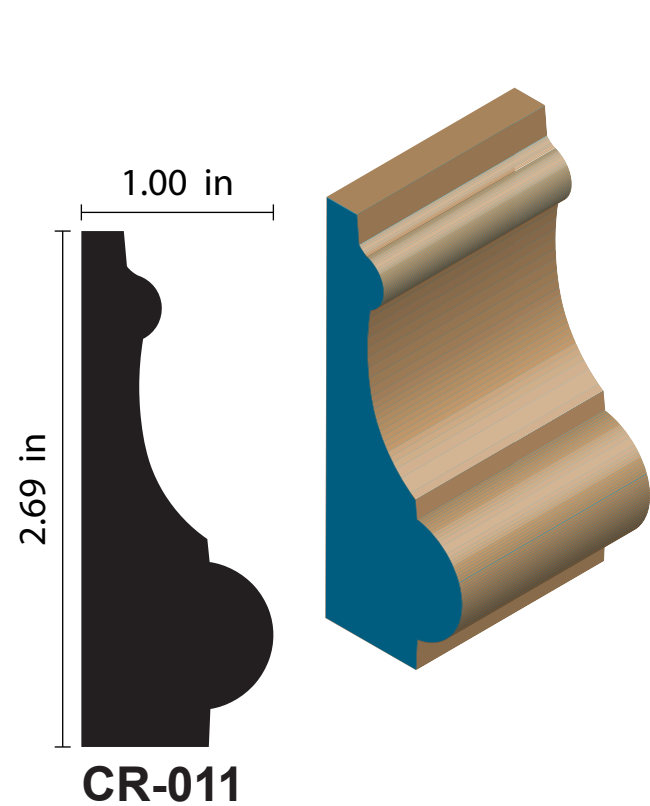
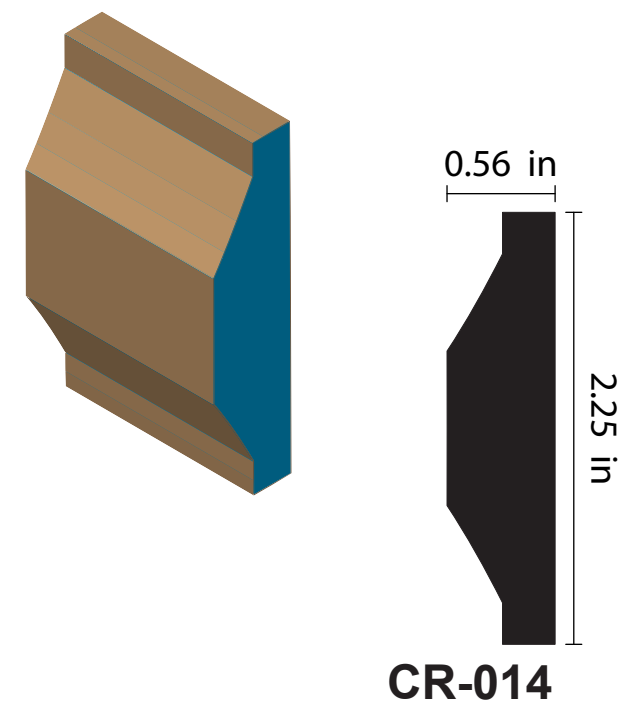
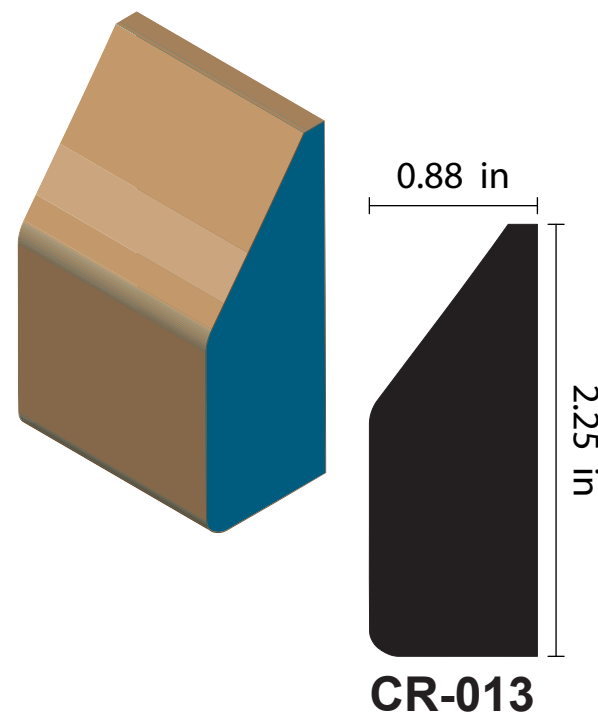
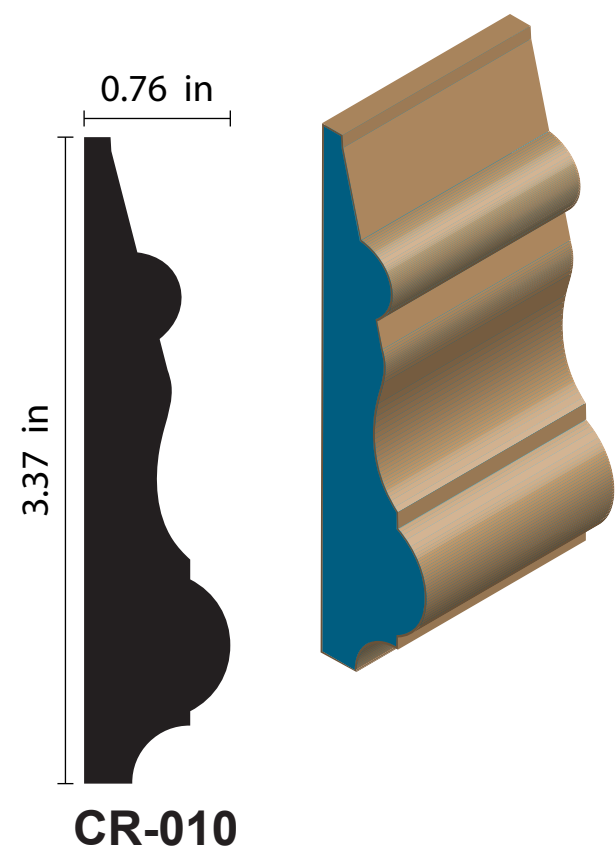
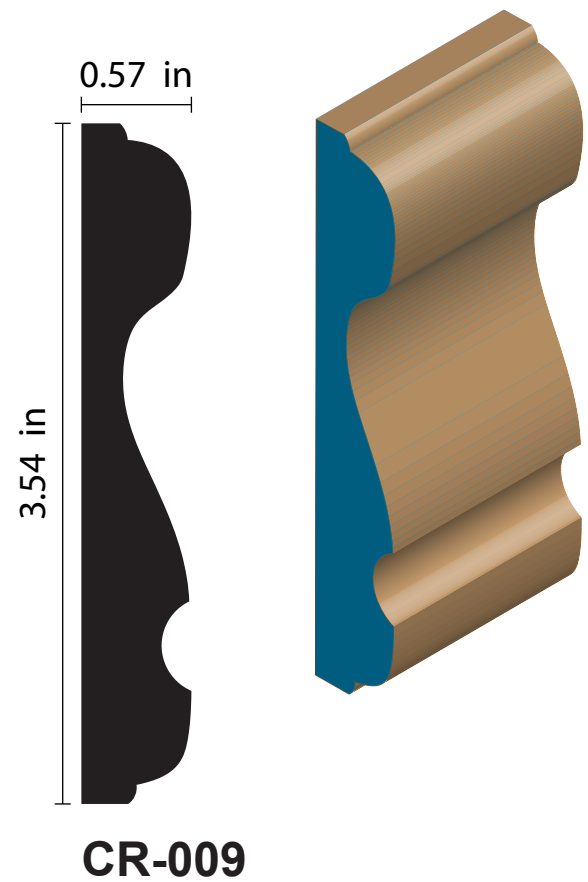

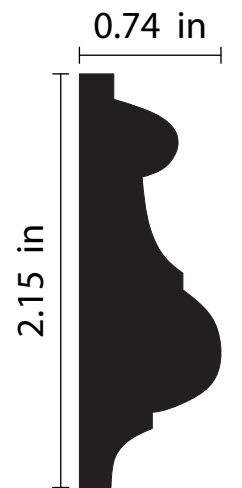

CR-017

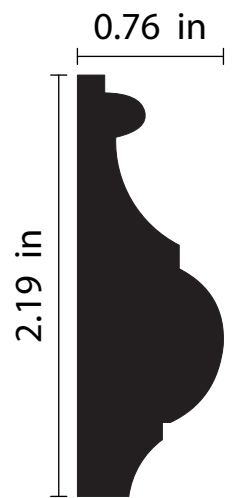
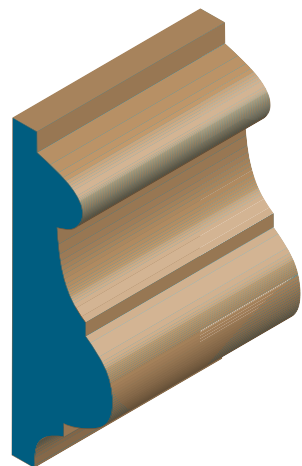

CR-018

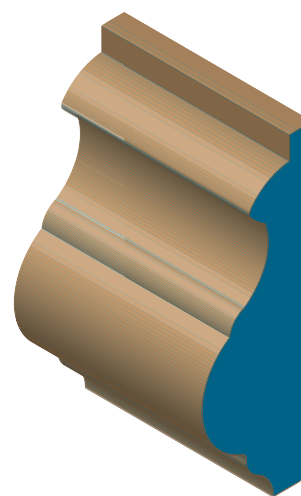
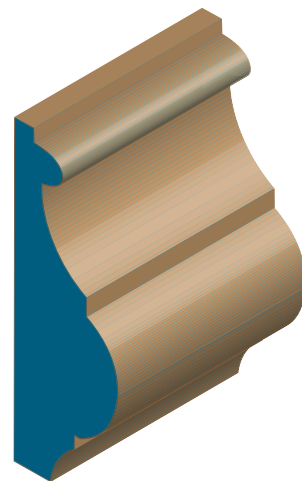

CR-021

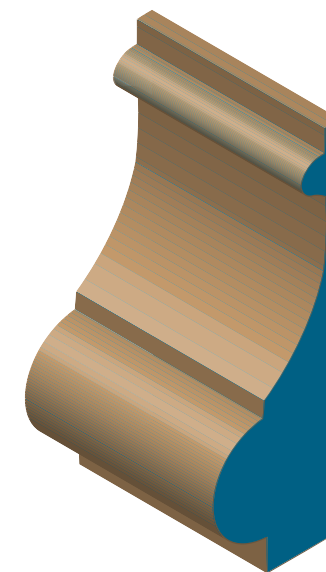

CR-022

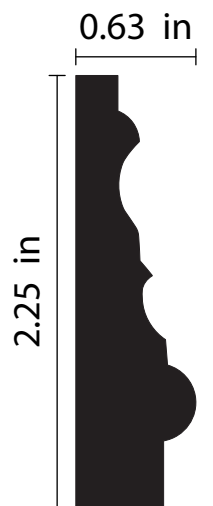

CR-019

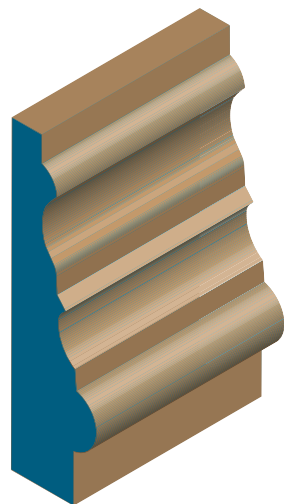

CR-020

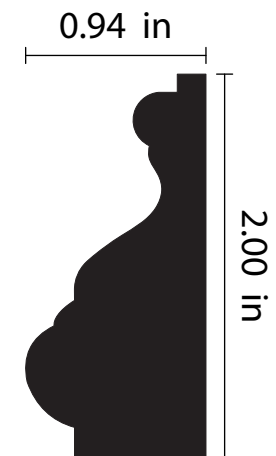
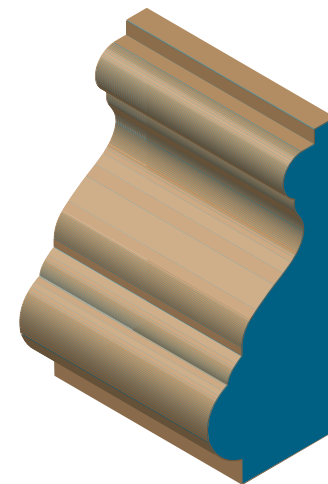
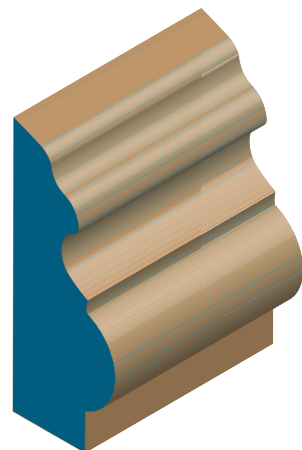

CR-023



CR-024



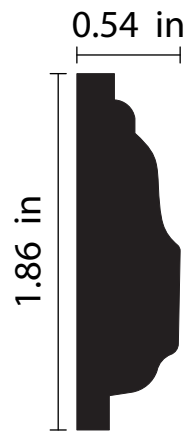

CR-025

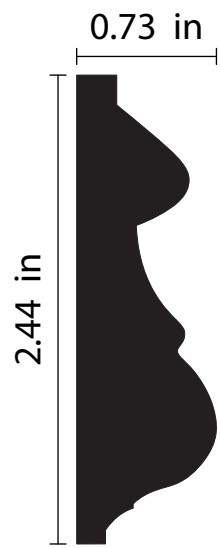
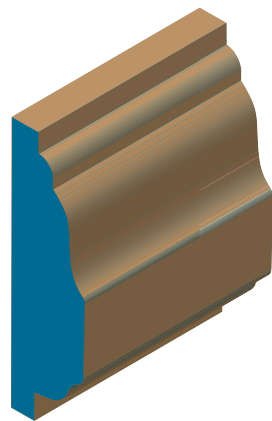

CR-026

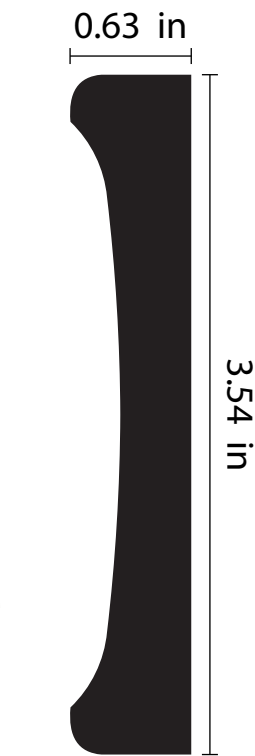
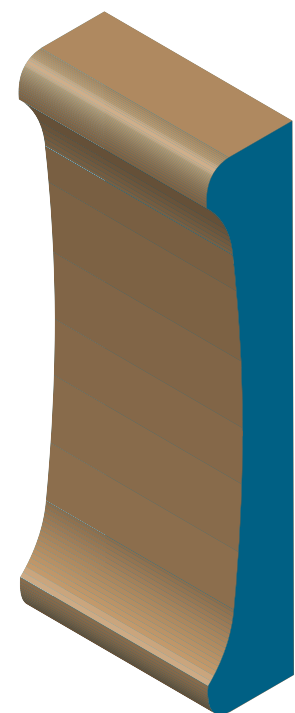
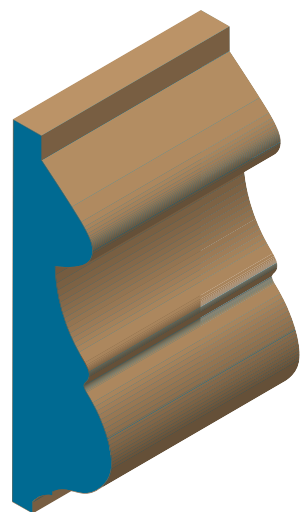

CR-029

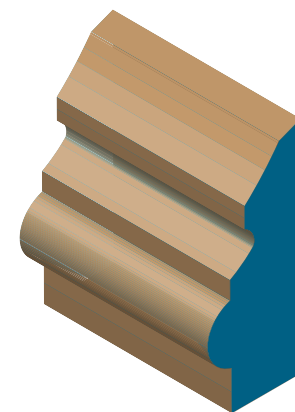

CR-030

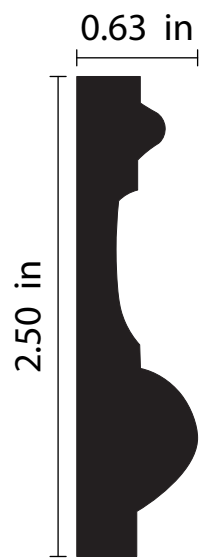

CR-027

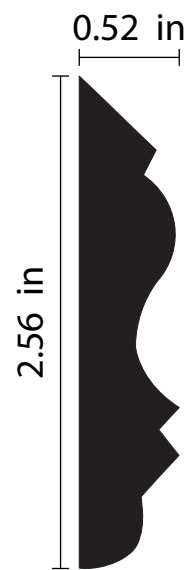
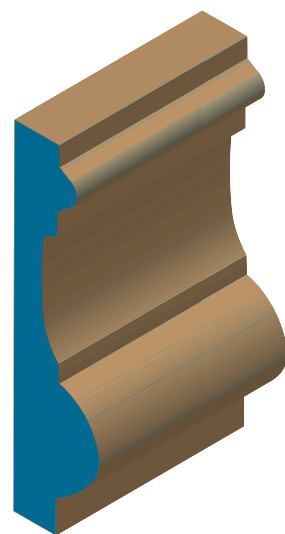

CR-028

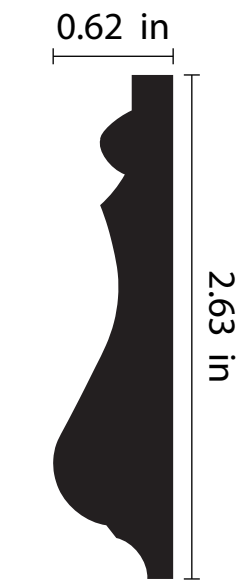
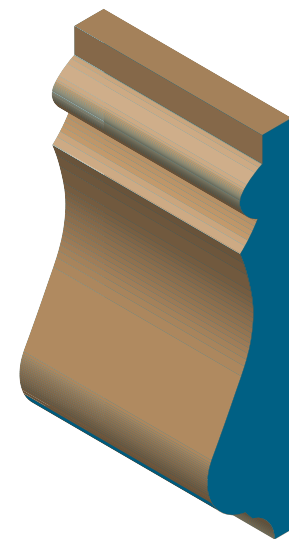
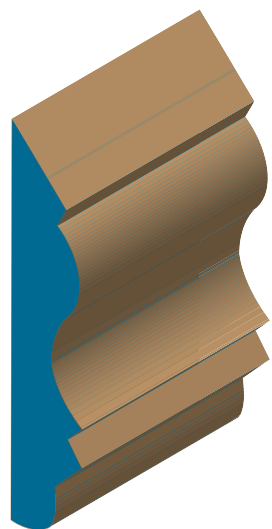

CR-031

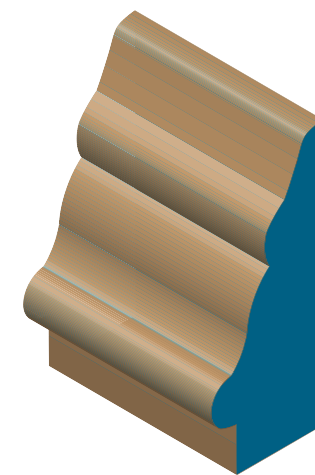

CR-032



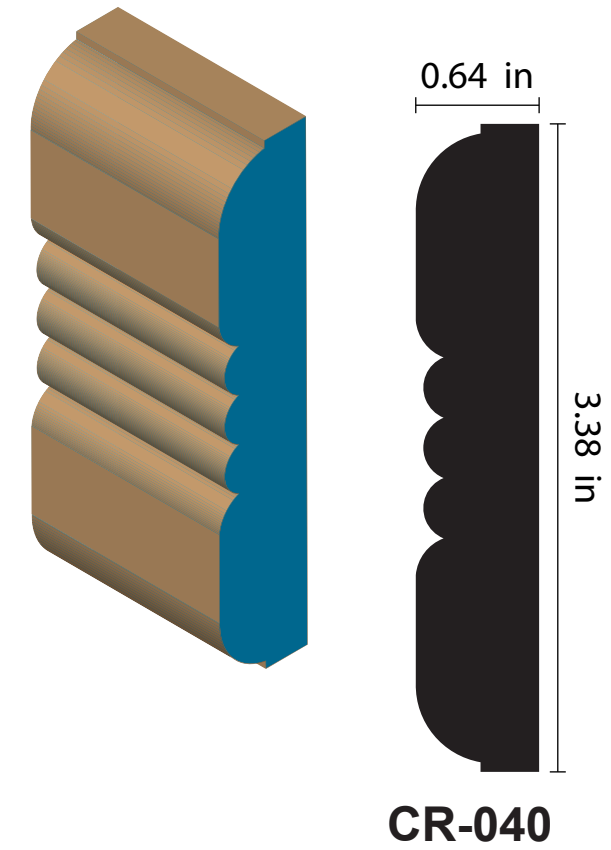
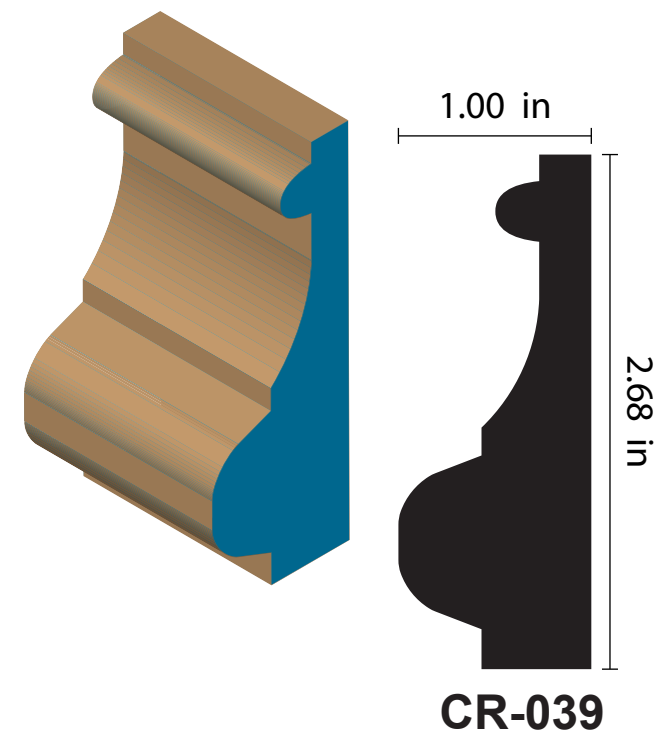
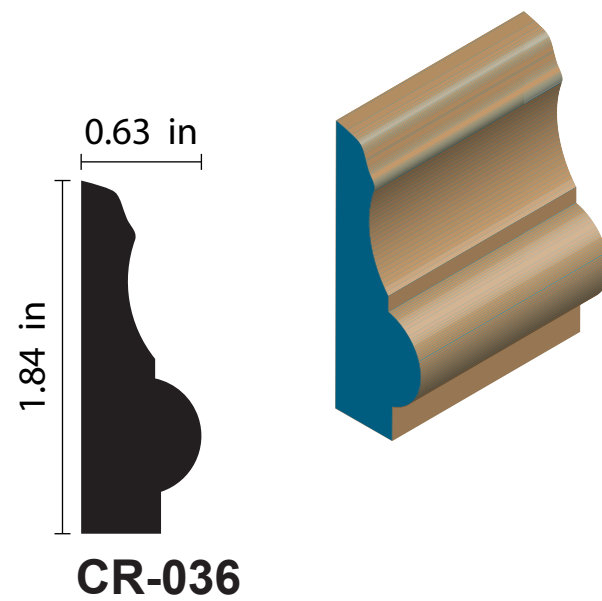
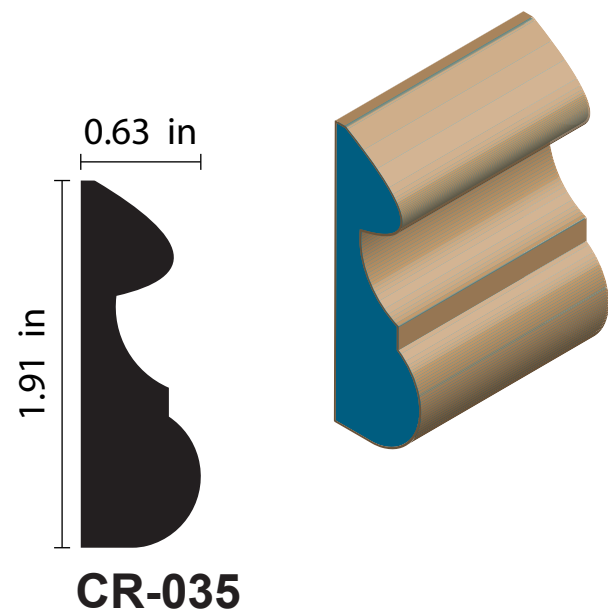
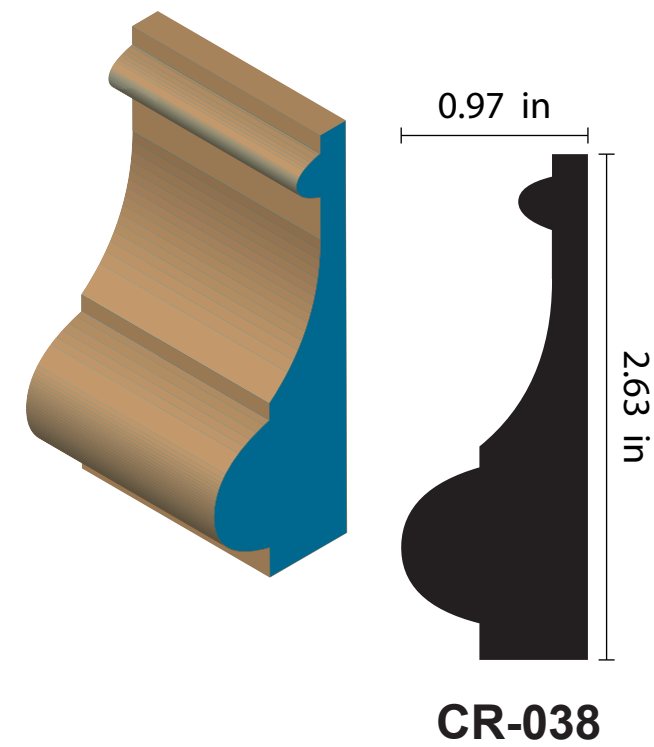
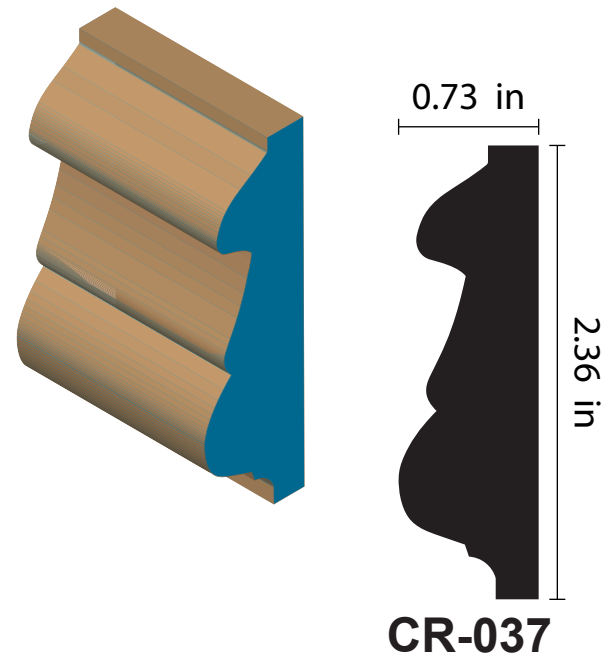
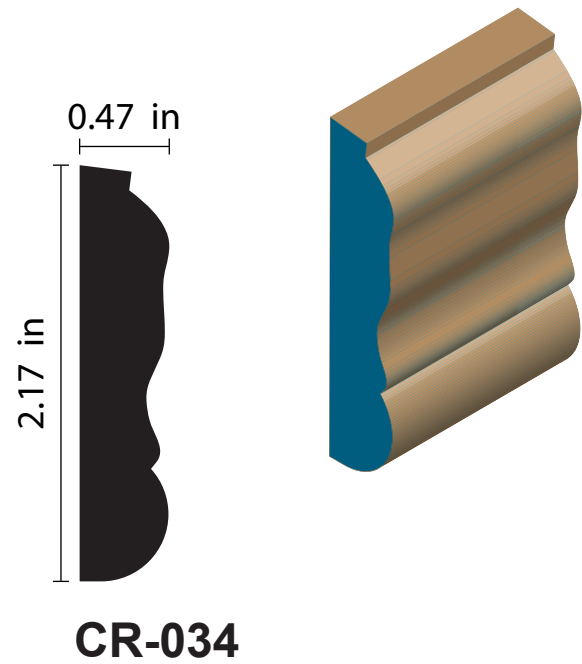
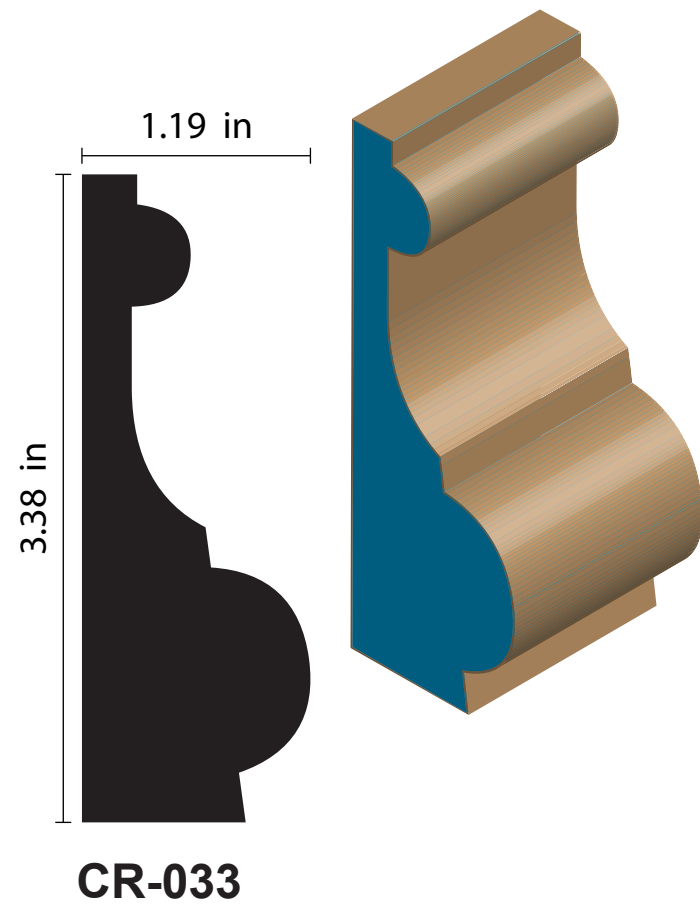

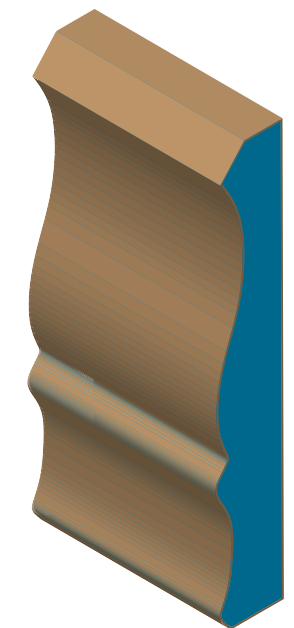
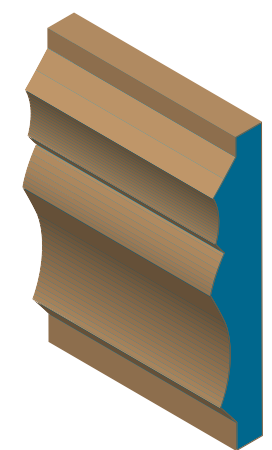
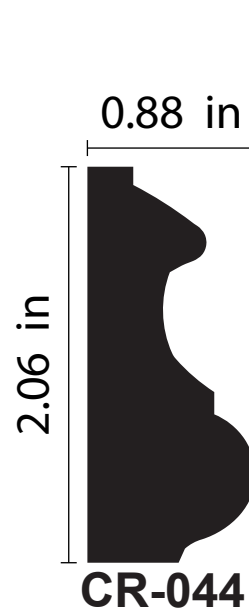
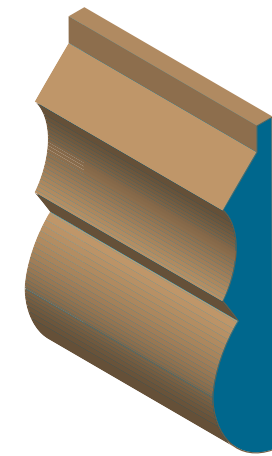
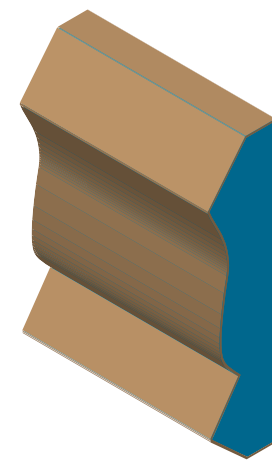

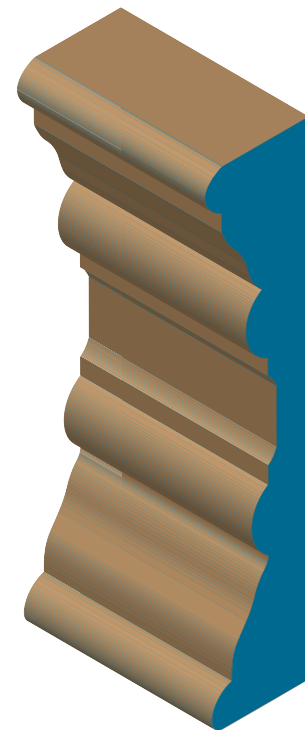
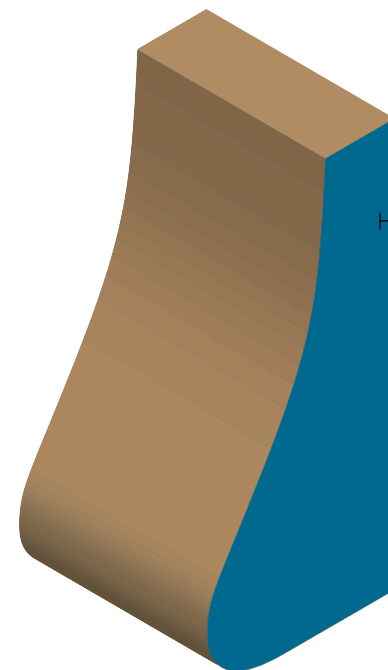
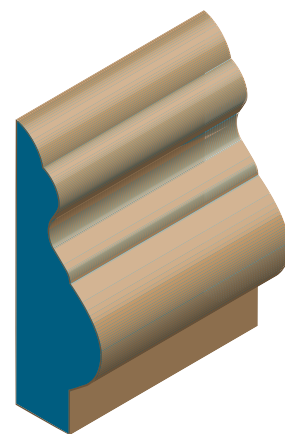
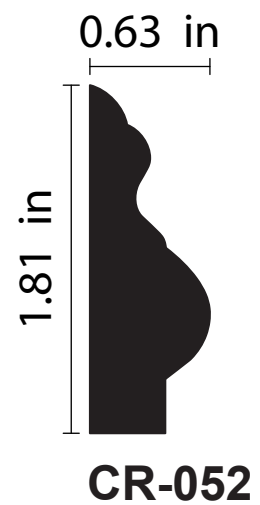
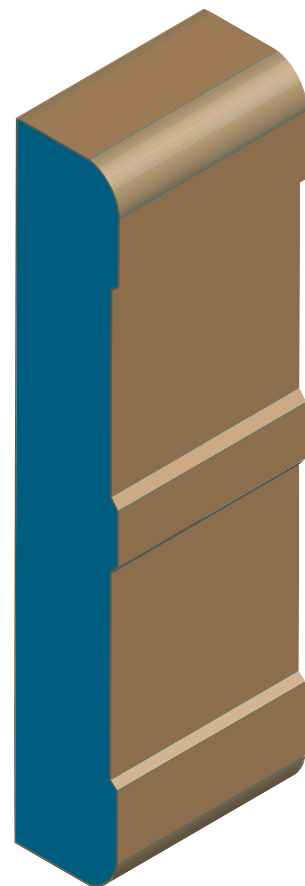
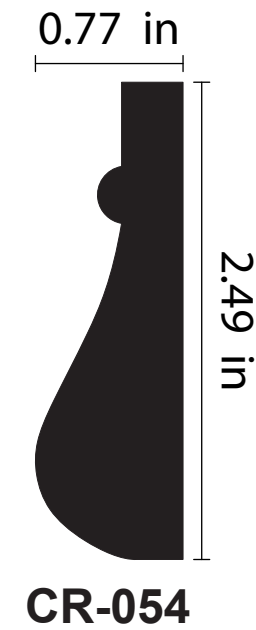
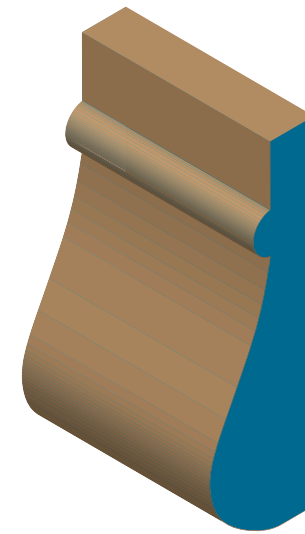
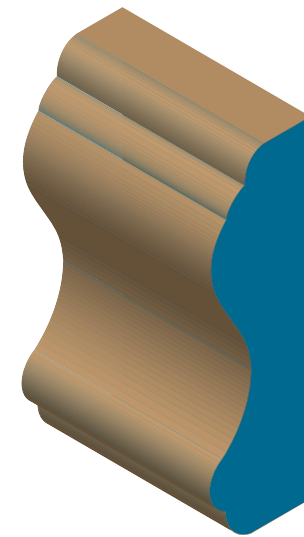
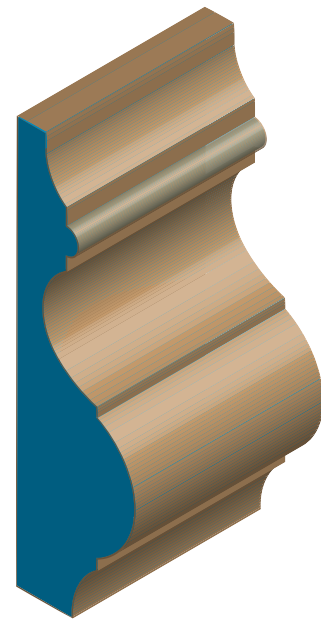
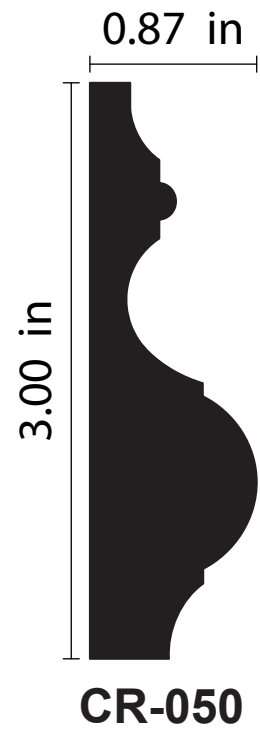
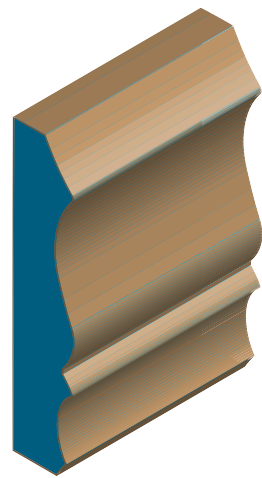

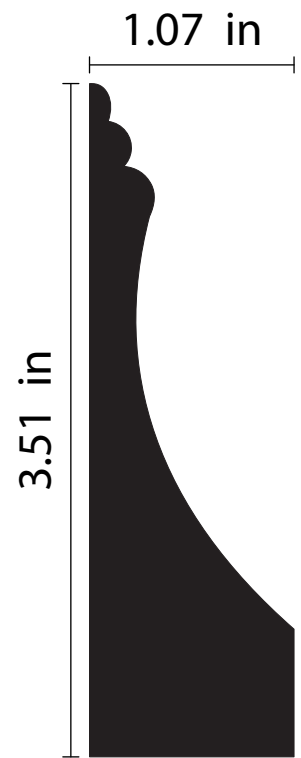

CR-057

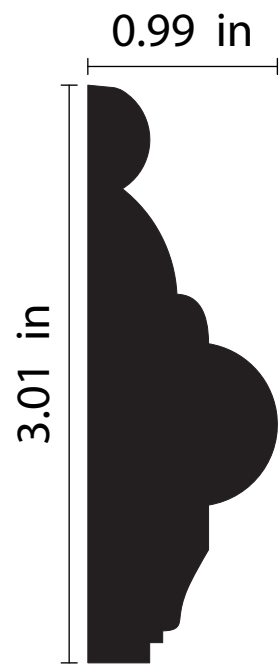
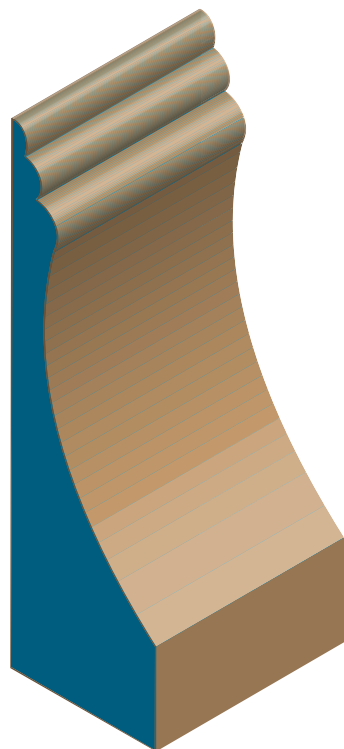

CR-058

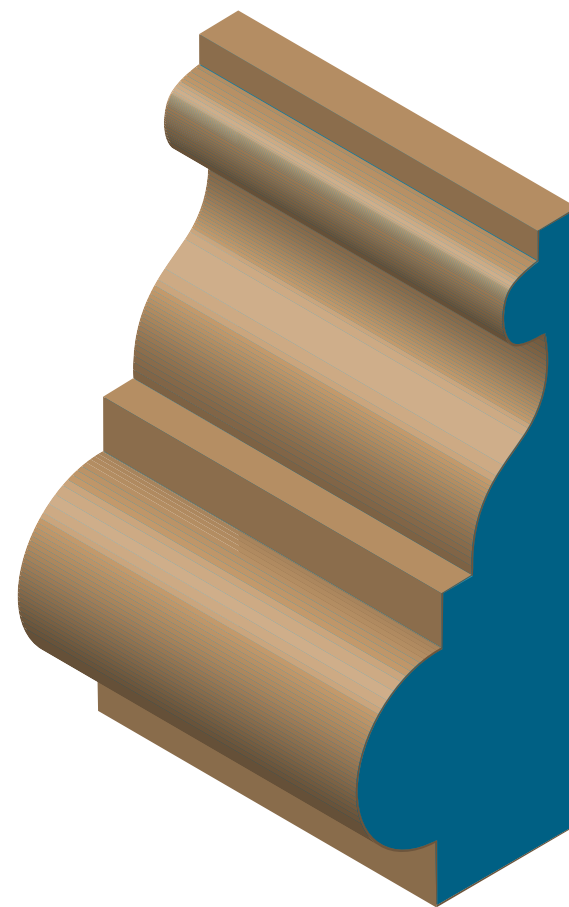
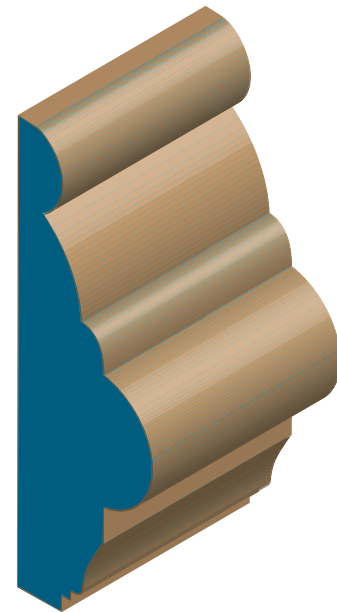

CR-061

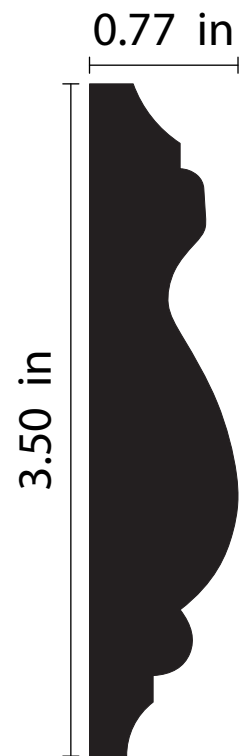

CR-059

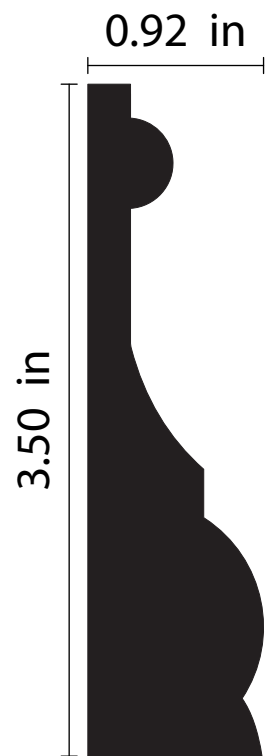
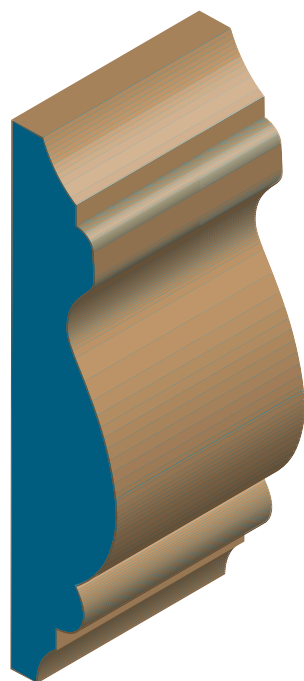

CR-060

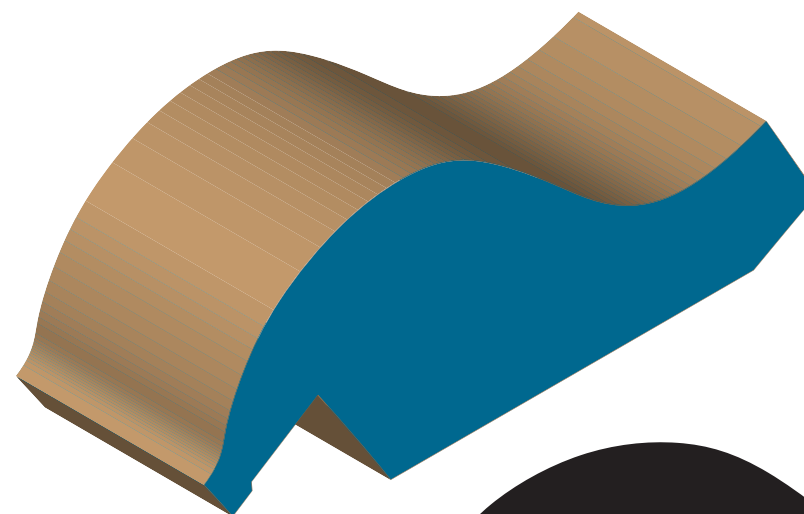
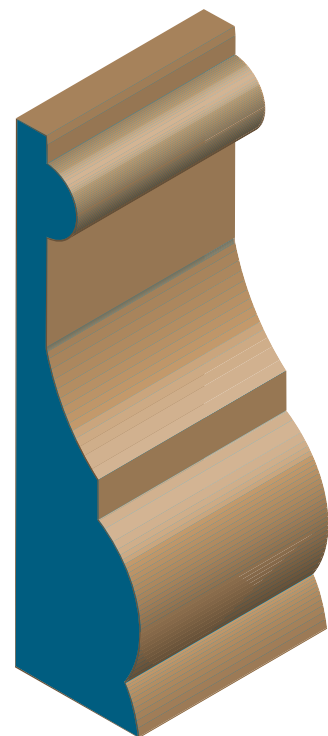

CR-062



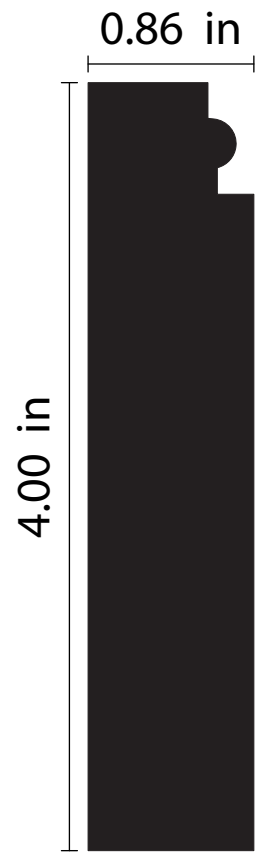

CR-063

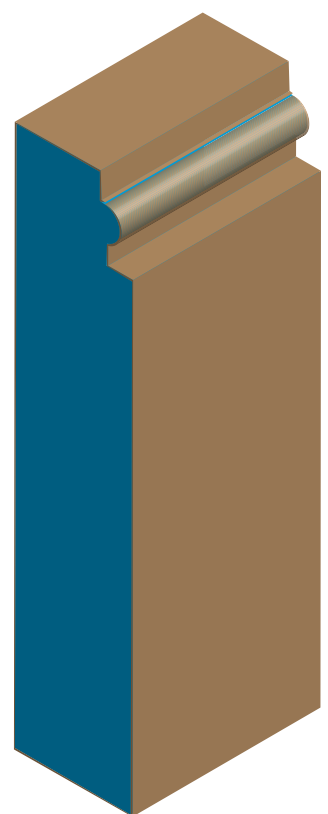

CR-065

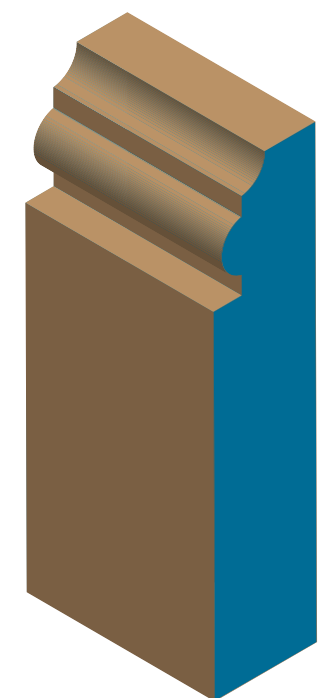
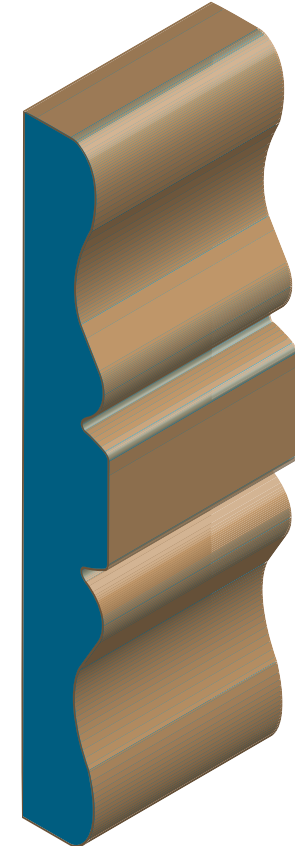

CR-069

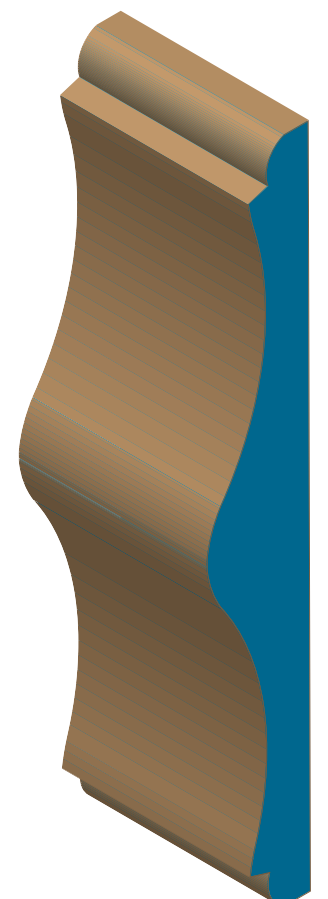

CR-066

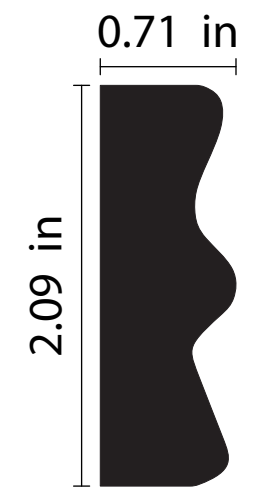

CR-64

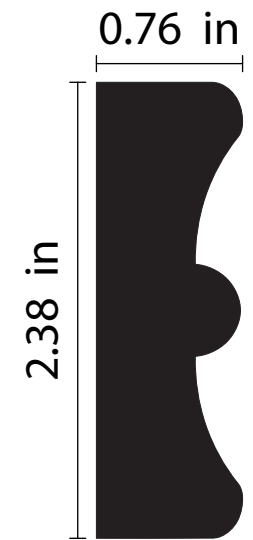
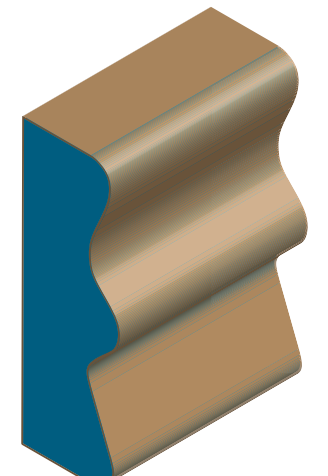

CR-067

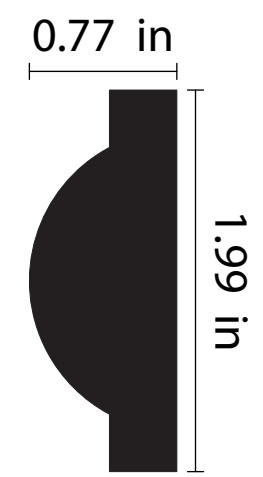
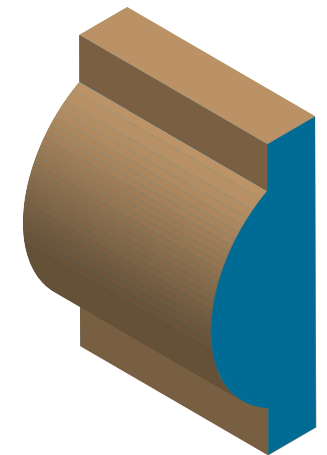
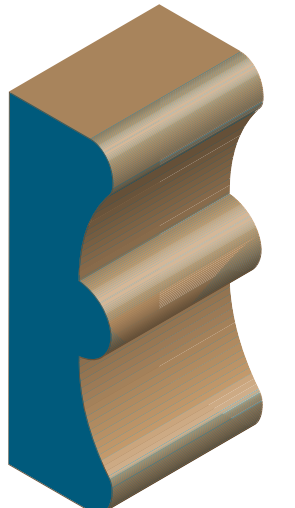

CR-070

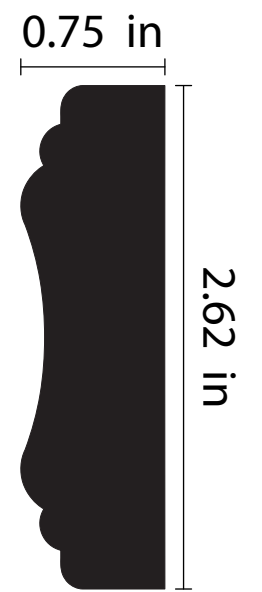
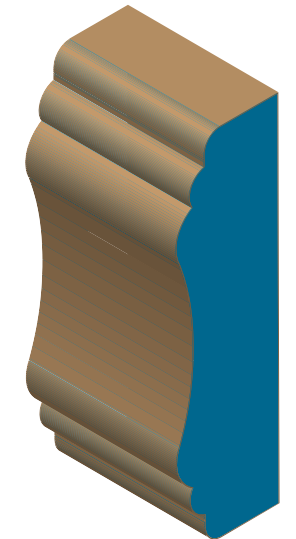

CR-068



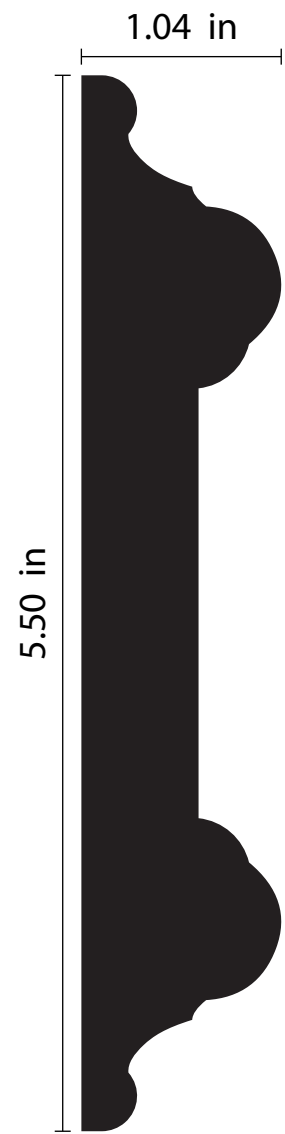

CR-071

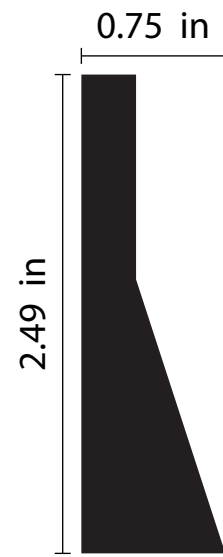
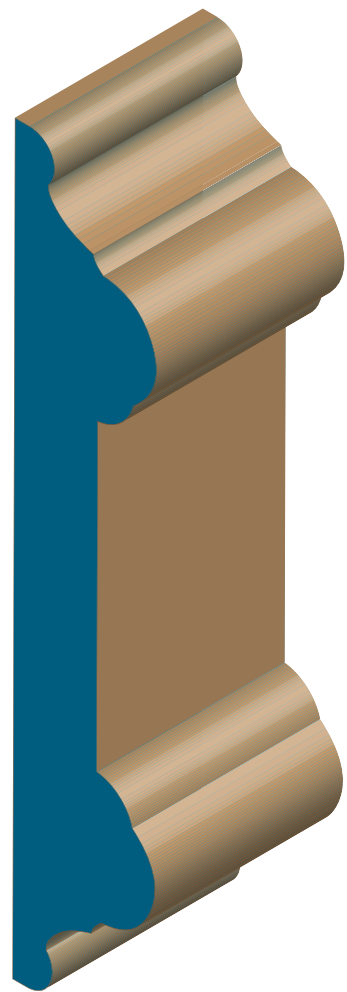

CR-072

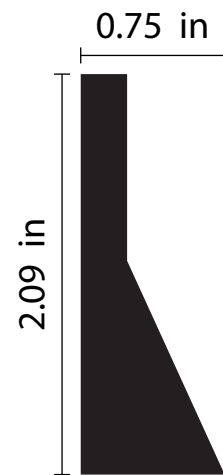
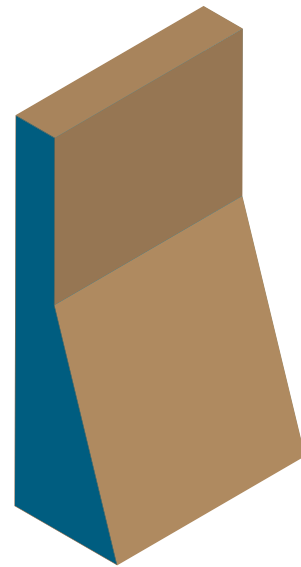

CR-073

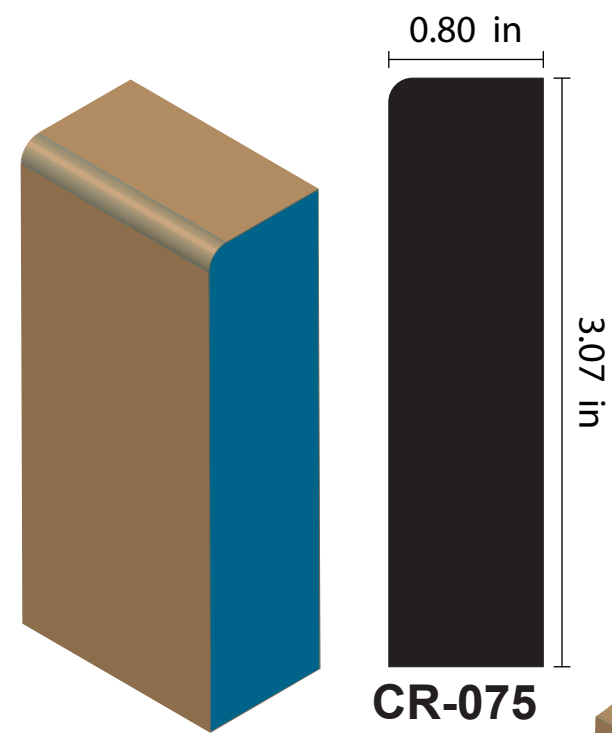
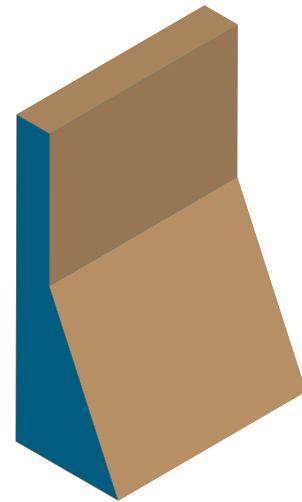

CR-075

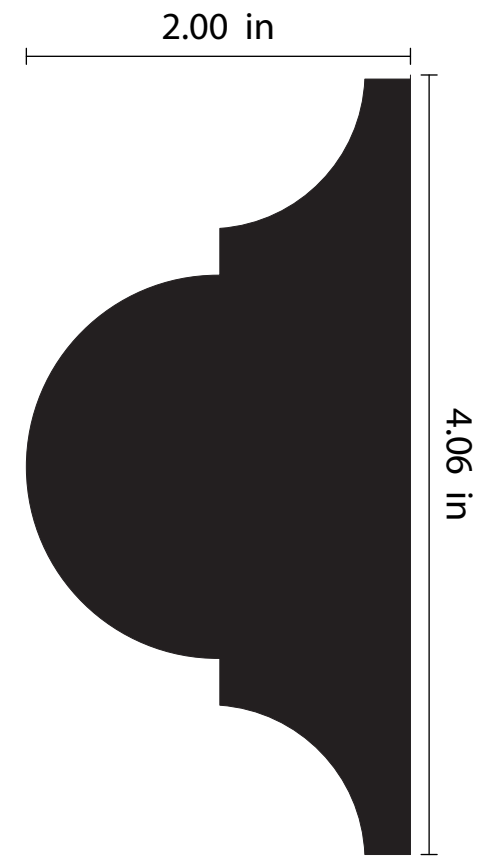
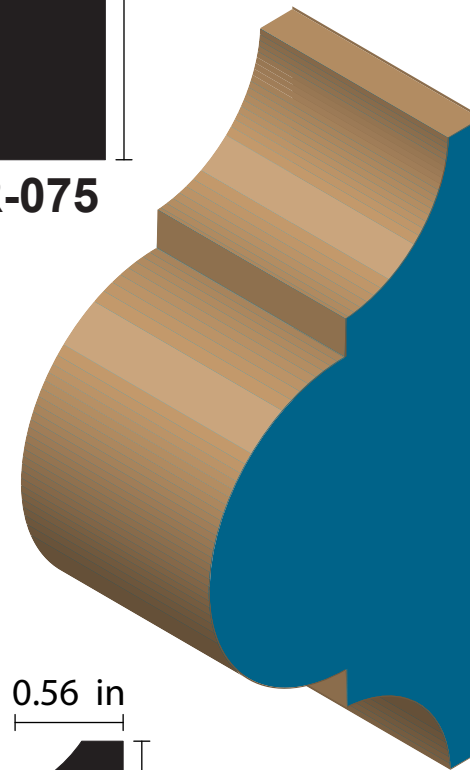

CR-076

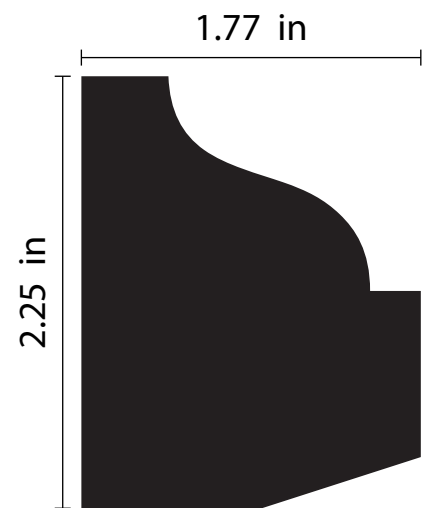

CR-074

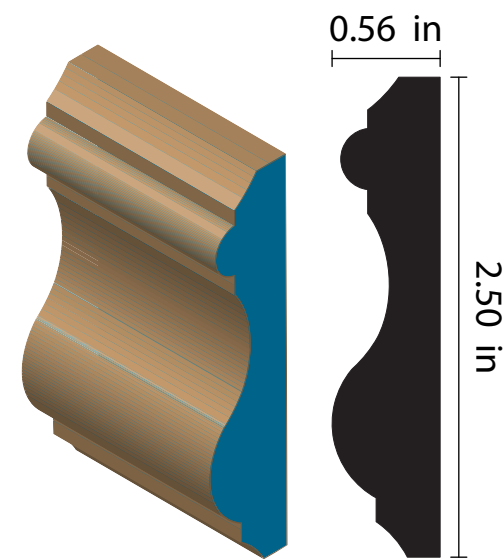
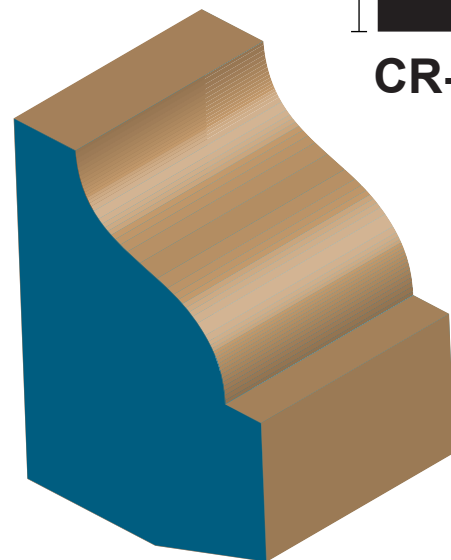

CR-077

4.06 in



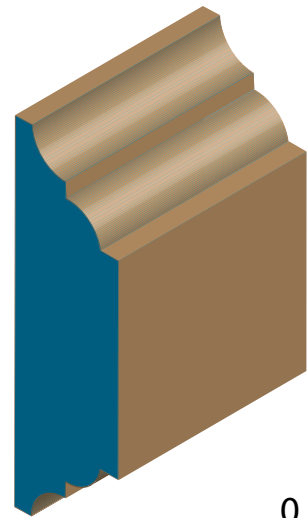

CR-078

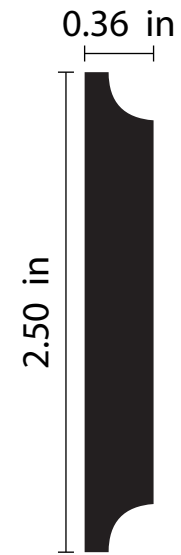

CR-079

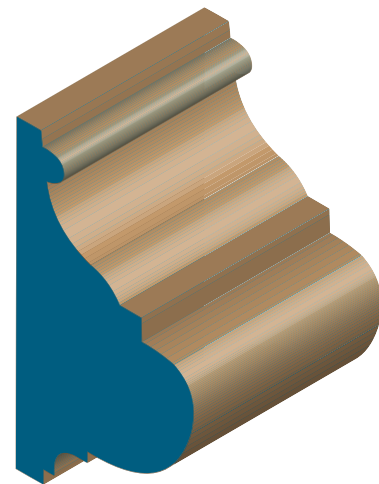
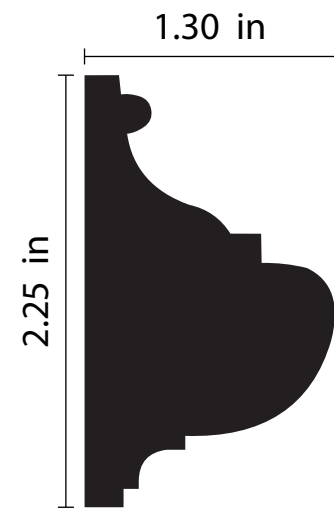

CR-080

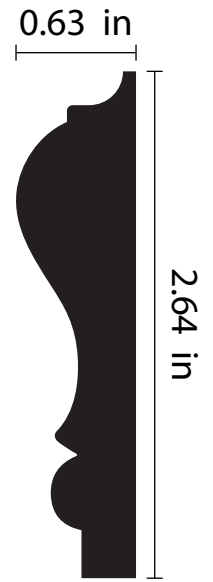
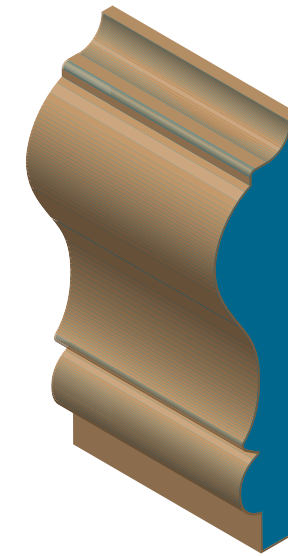

CR-081

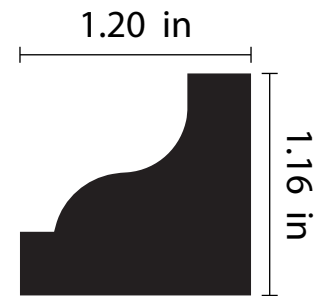
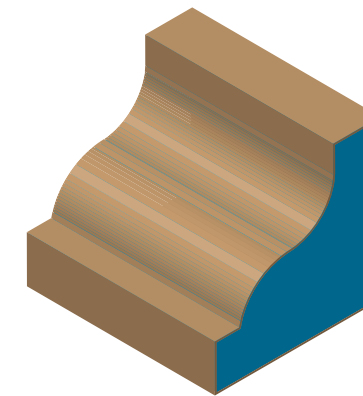

CR-082
CX/CN-006-3

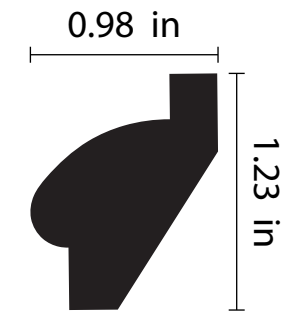
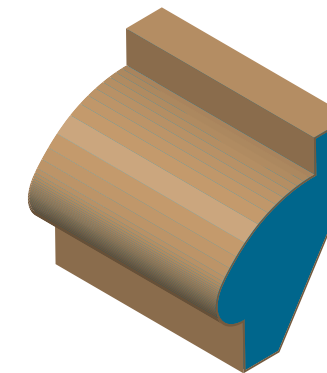

CR-083
CX/CN-006-8



