

MOLDING  
**BASE**

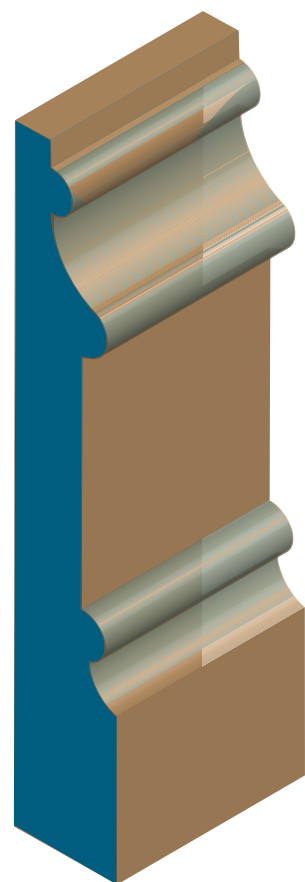

**PHILLIPS**

FOREST PRODUCTS

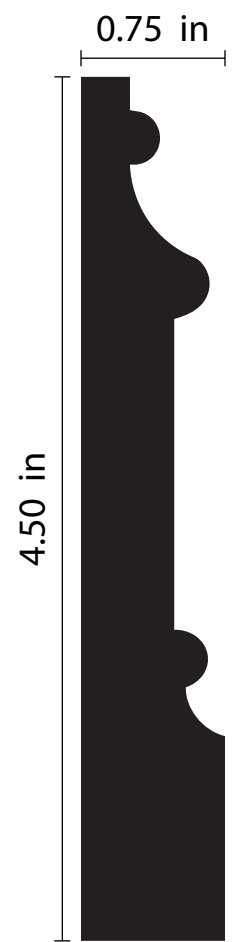

BS-001

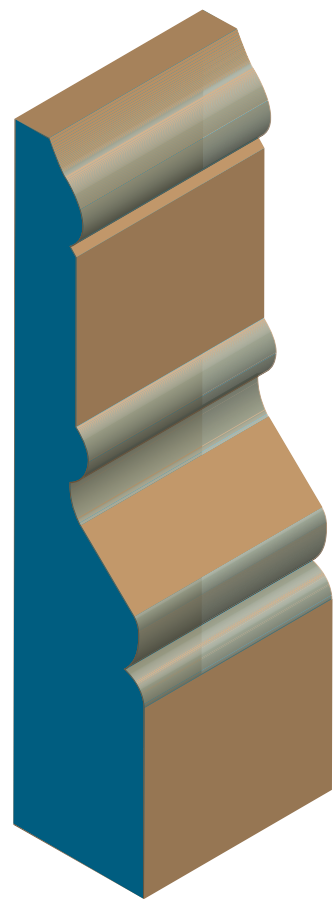
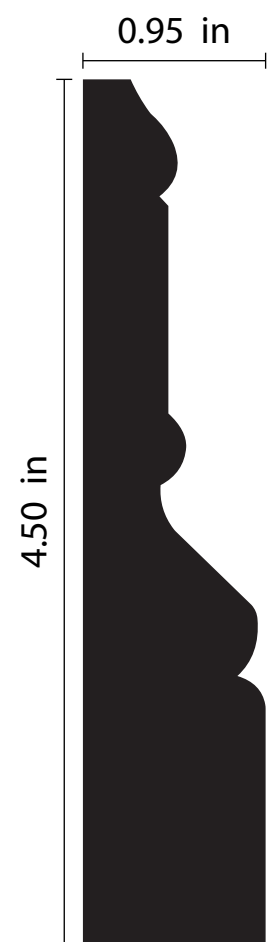

BS-003

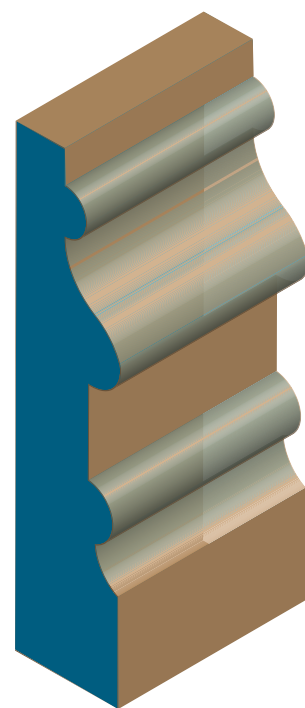
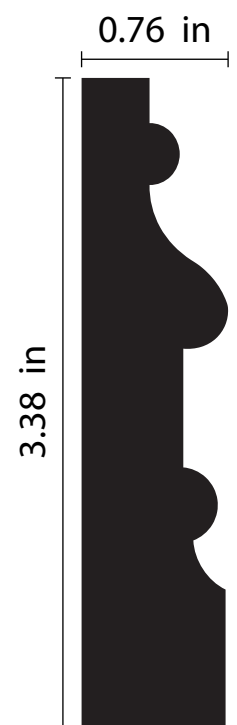

BS-002

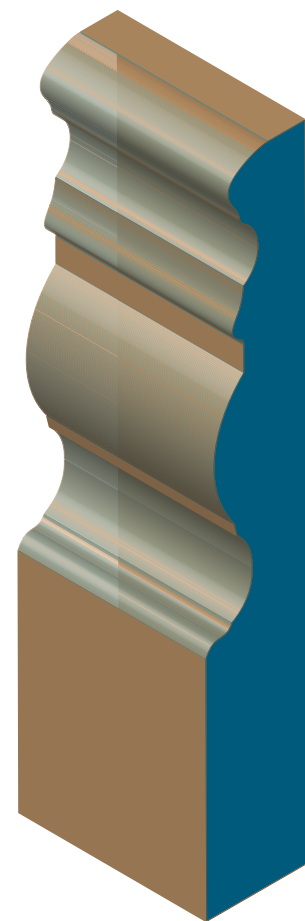
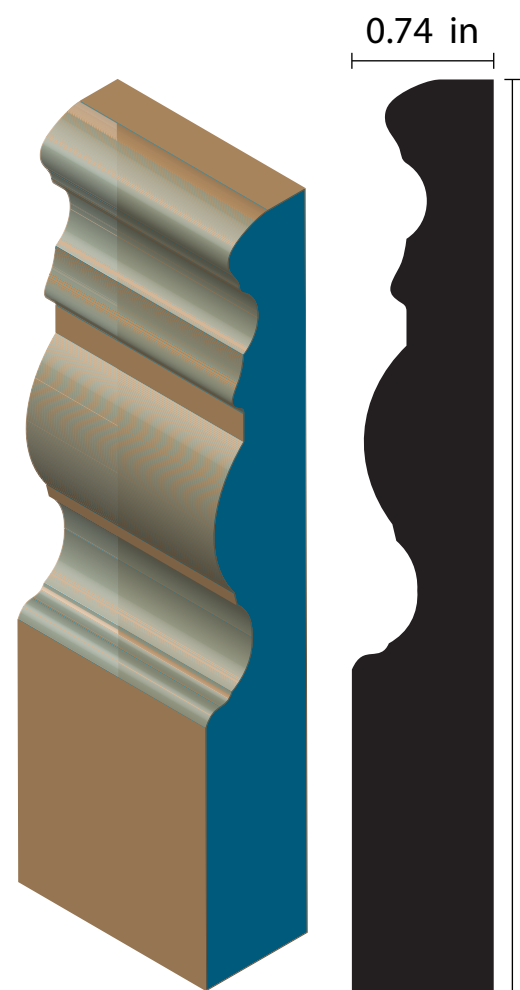

BS-004

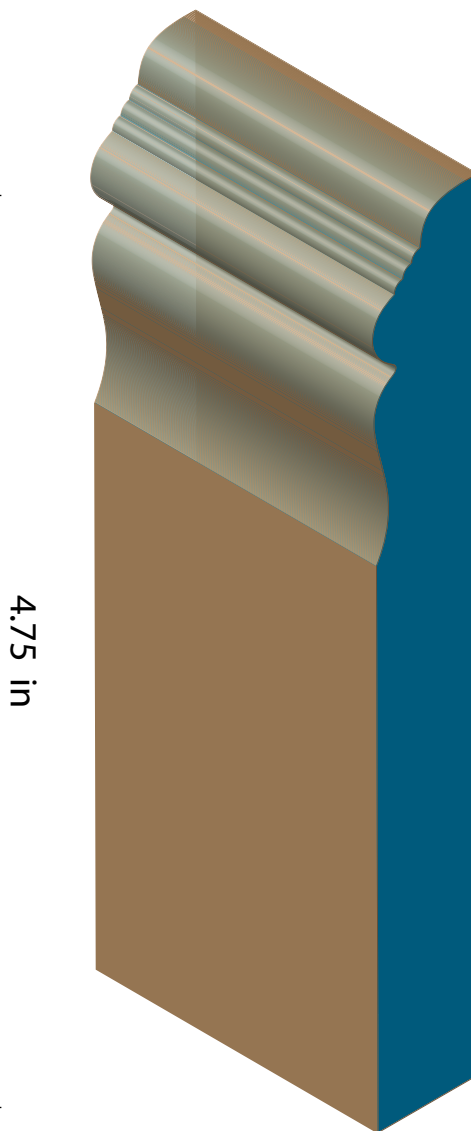

BS-005



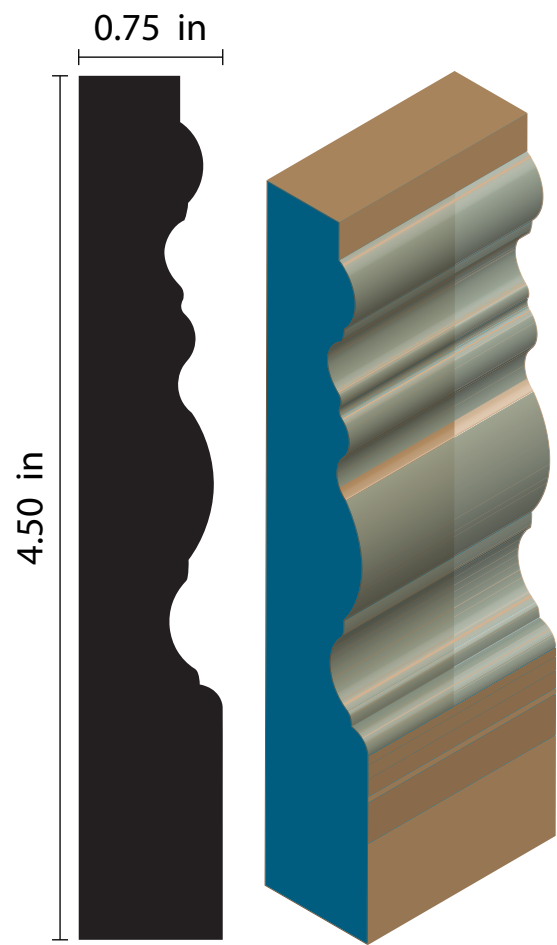

**BS-006**

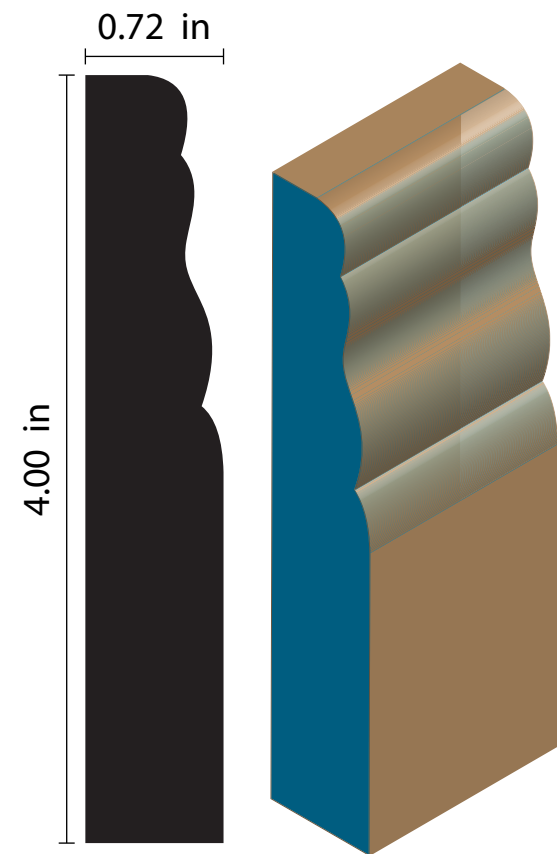

**BS-007**

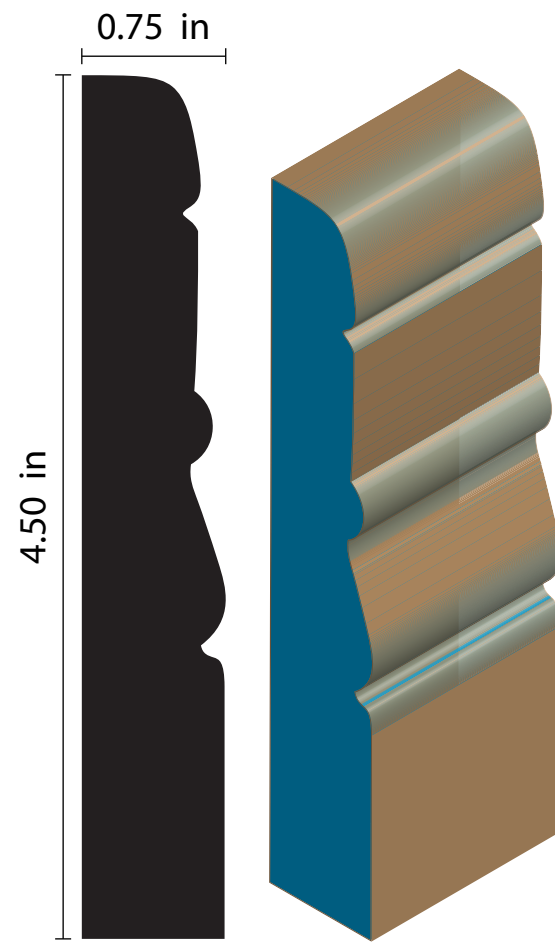

**BS-008**

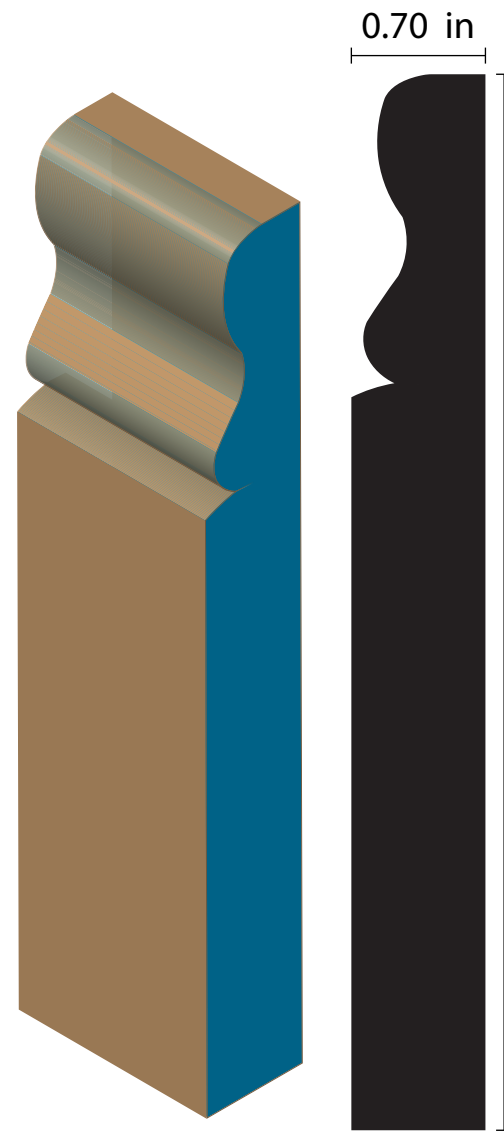

**BS-009**

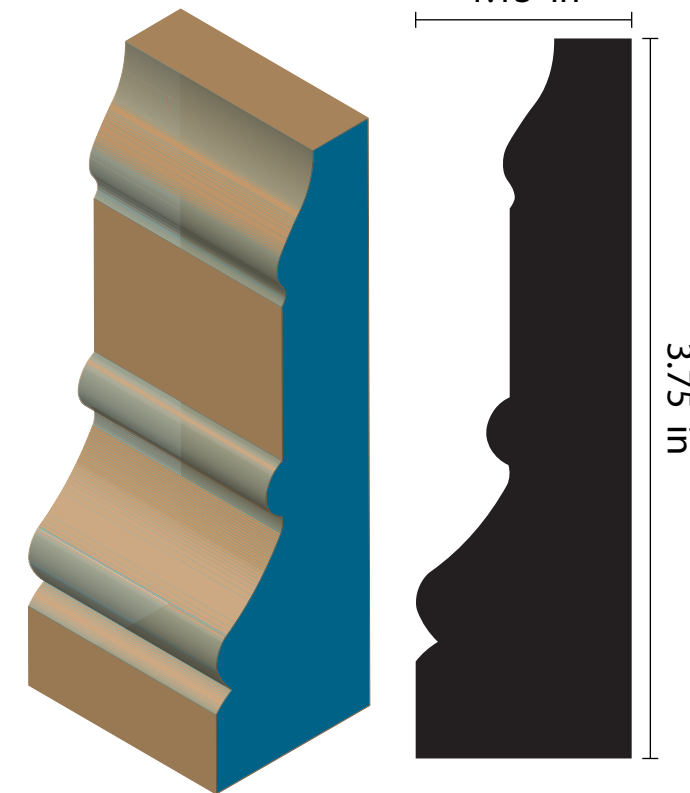

**BS-010**

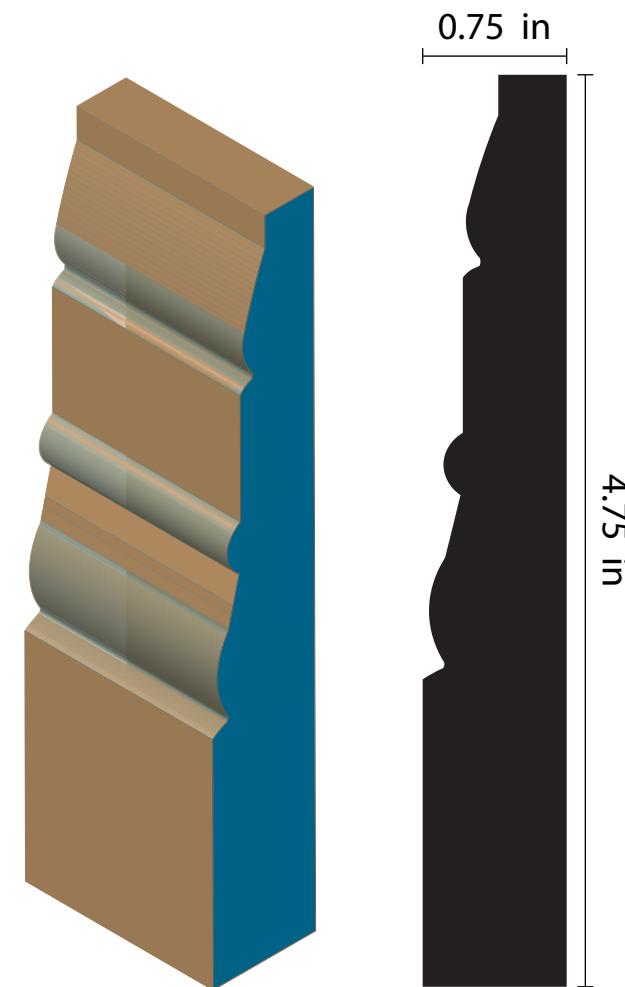

**BS-011**



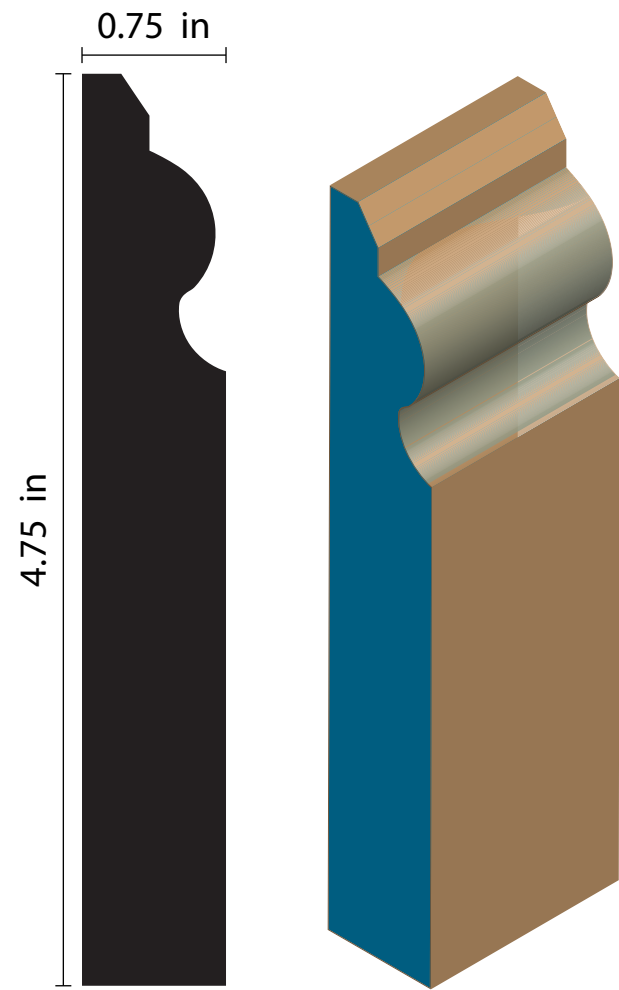

**BS-012**

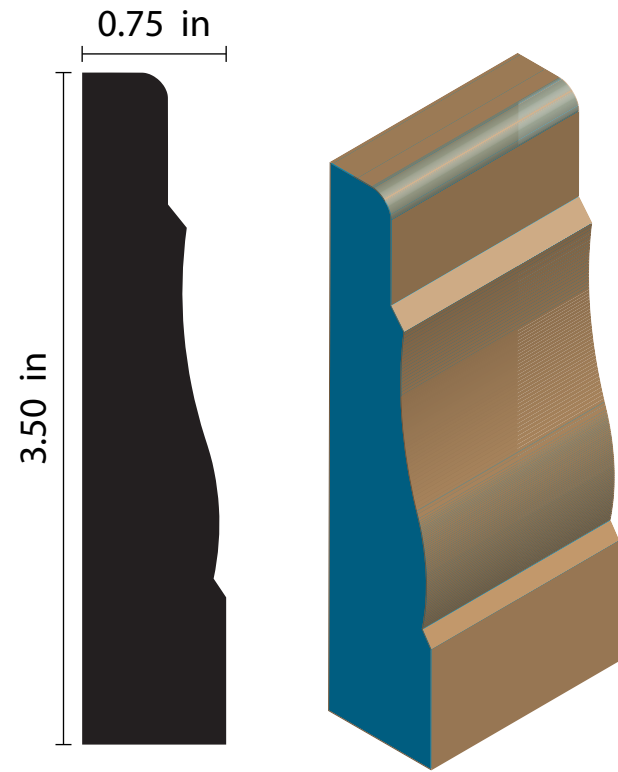

**BS-013**

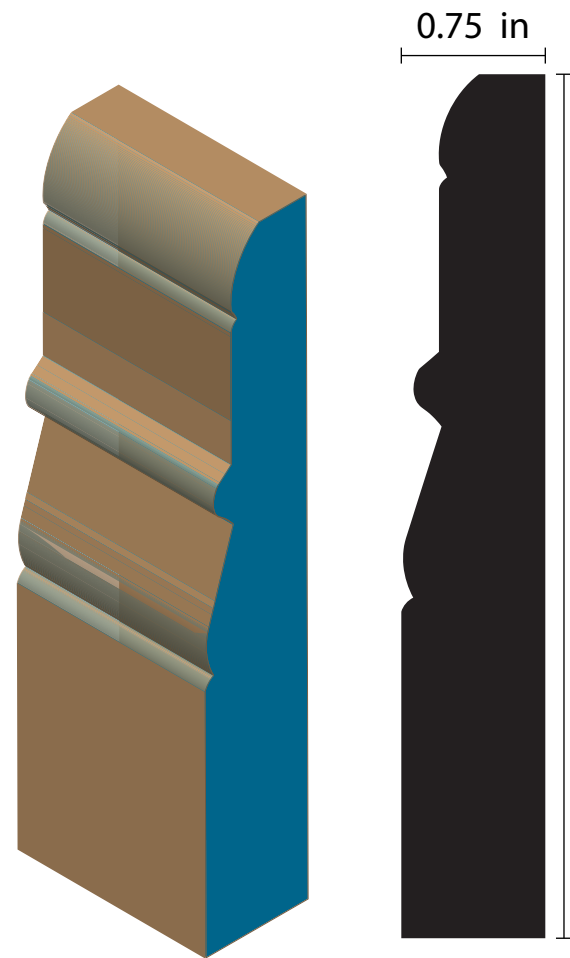

**BS-017**

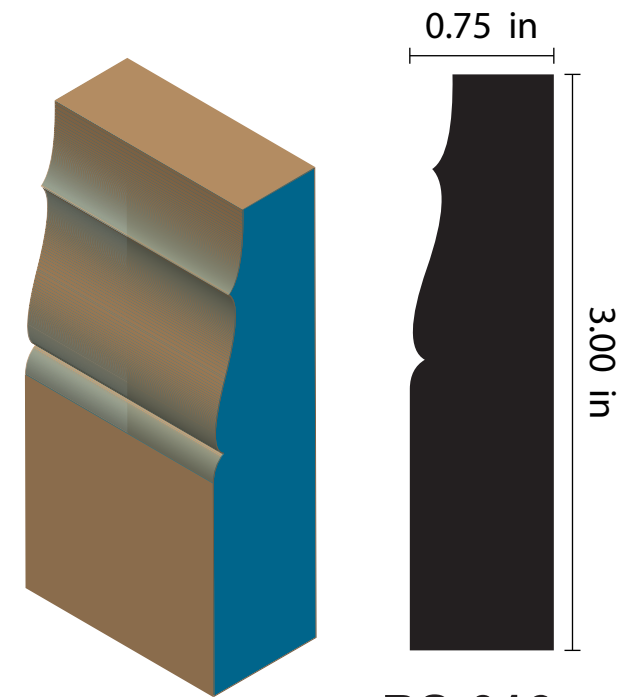

**BS-016**

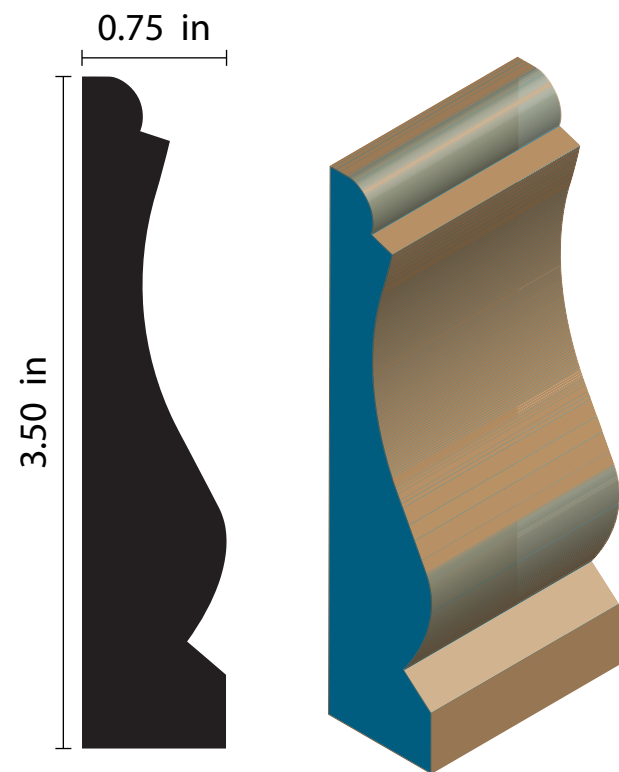

**BS-014**

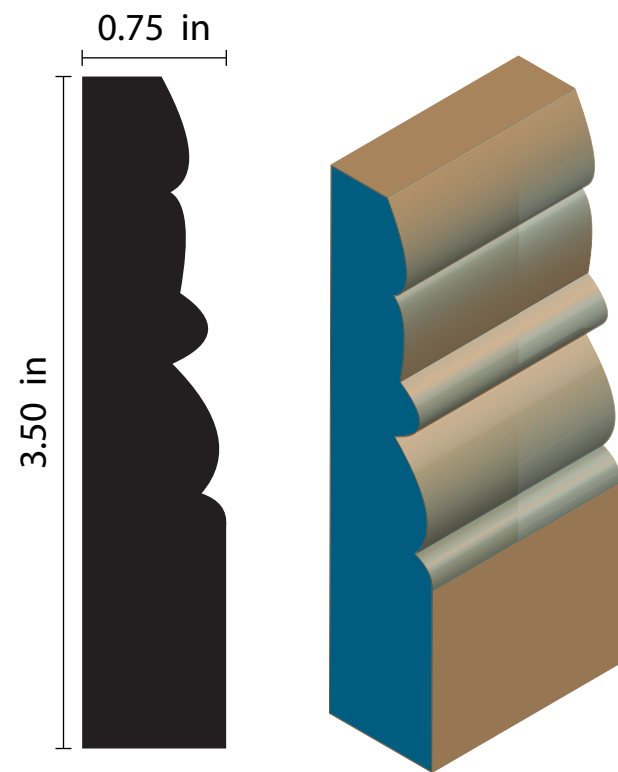

**BS-015**

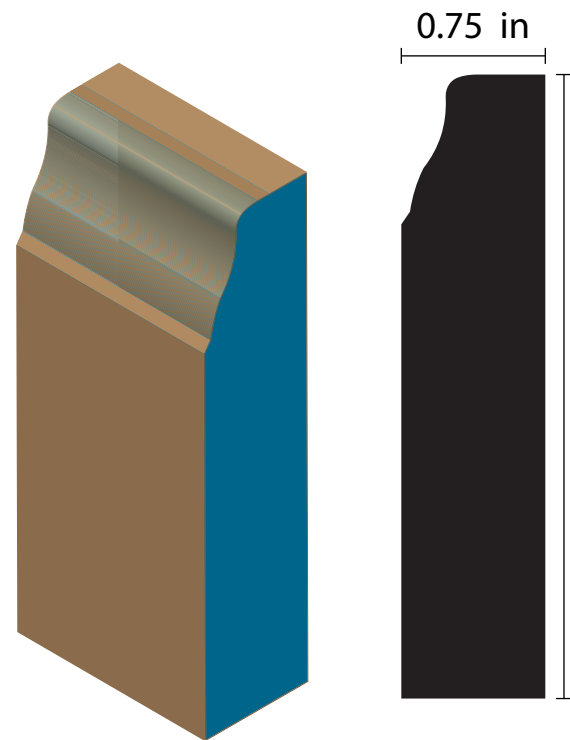

**BS-019**

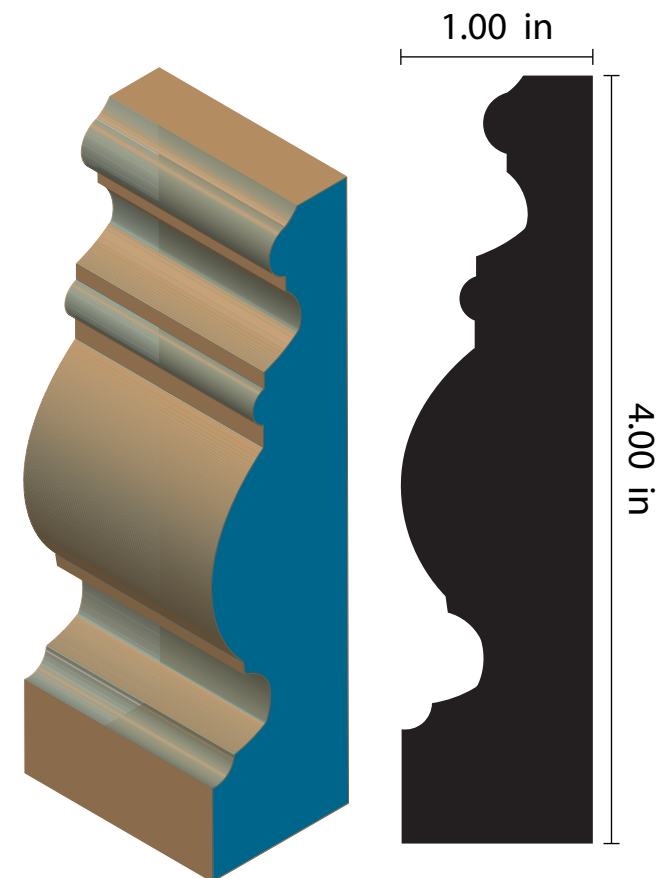

**BS-018**





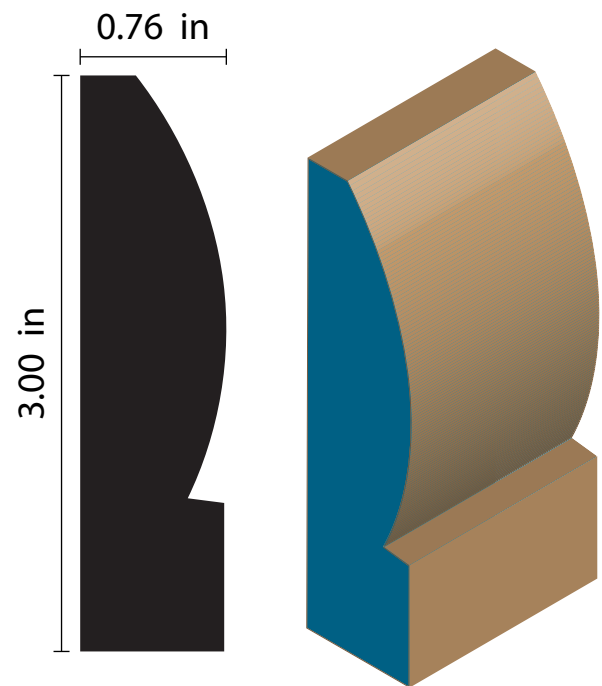

BS-020

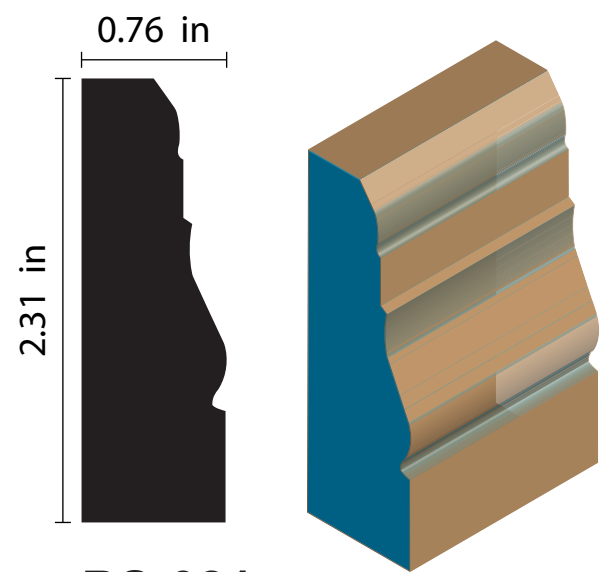

BS-021

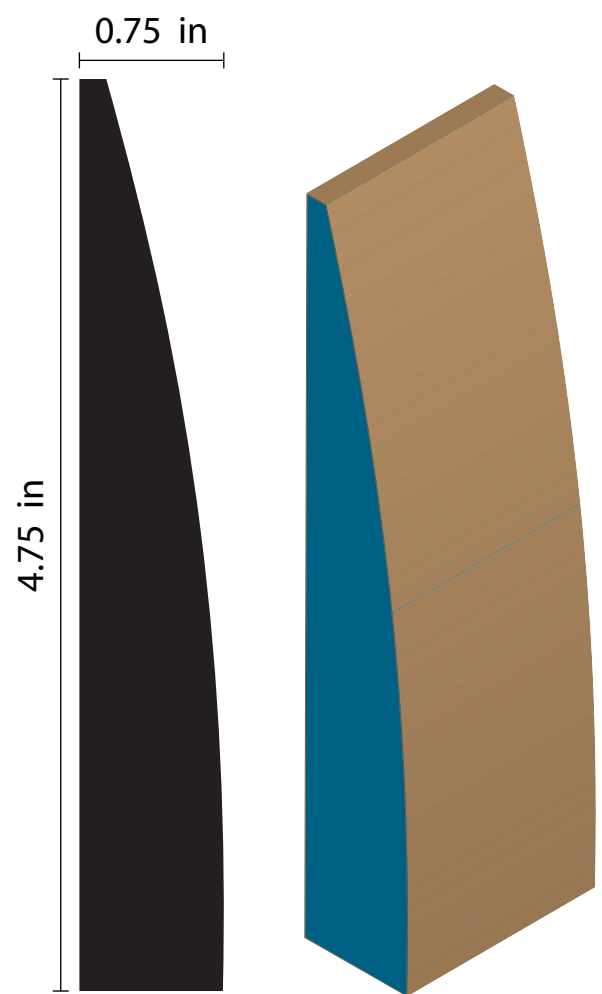

BS-023

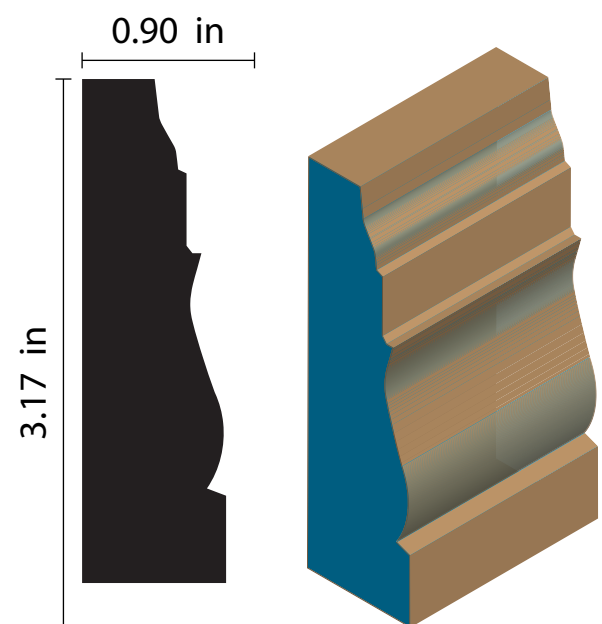

BS-022

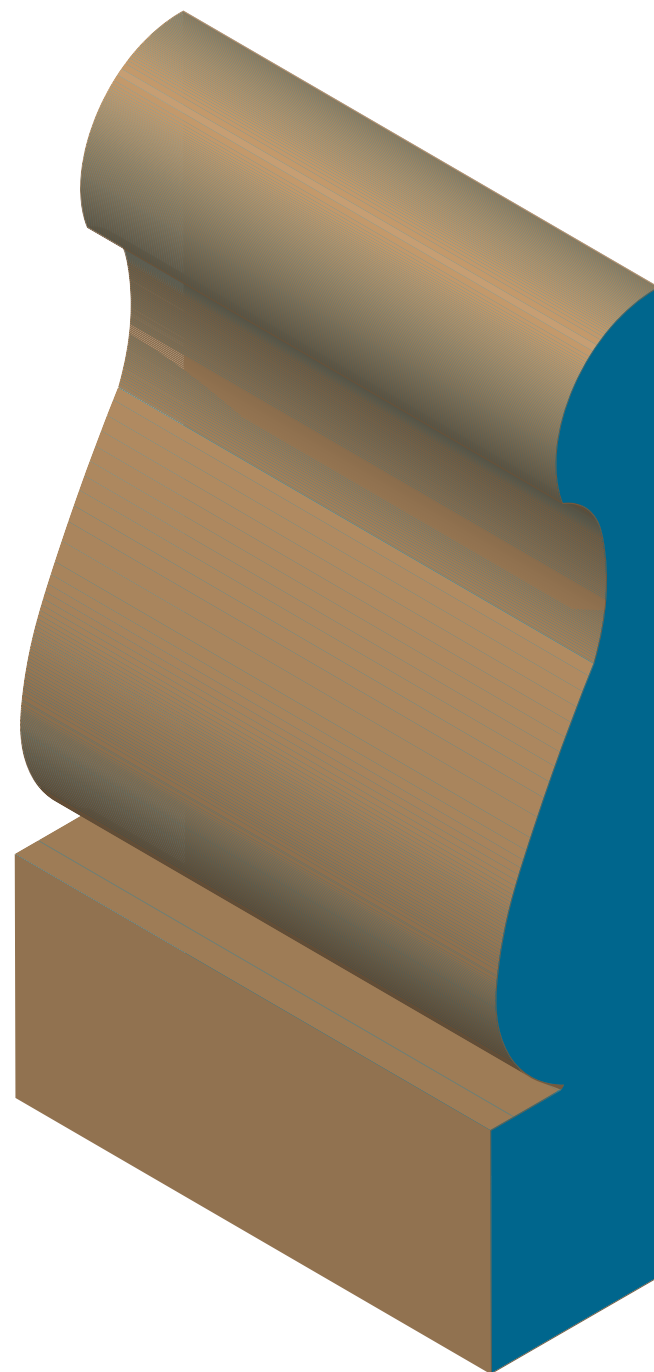

BS-024



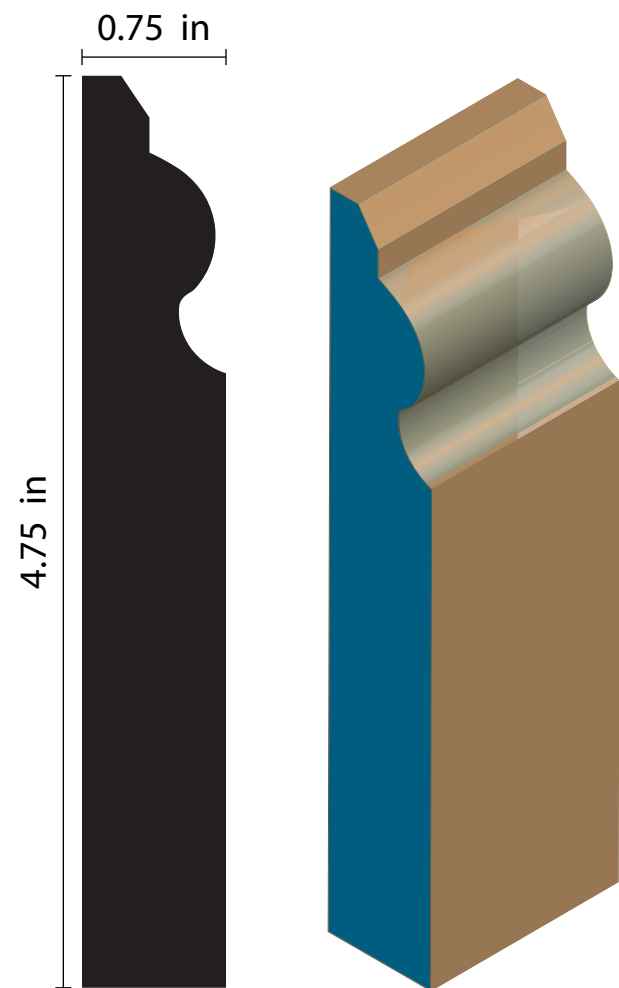

**BS-012**

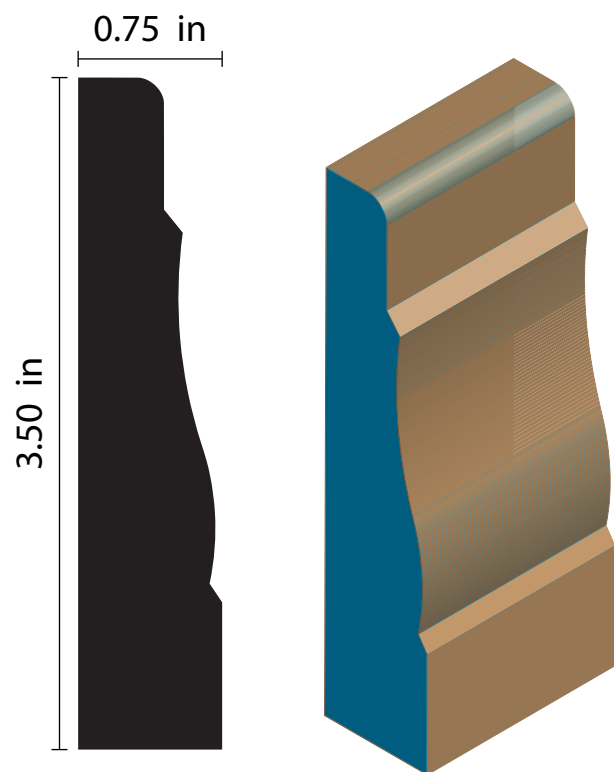

**BS-013**

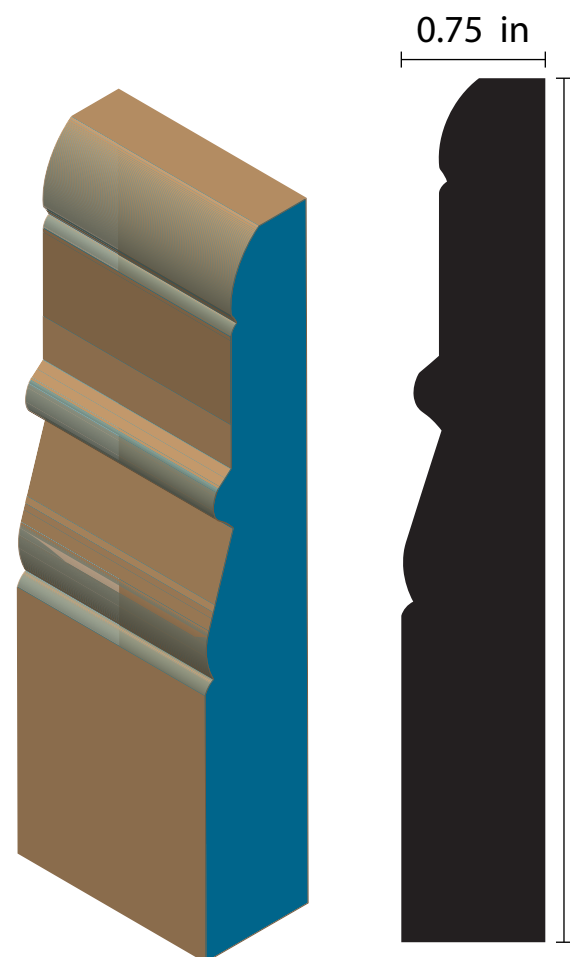

**BS-017**

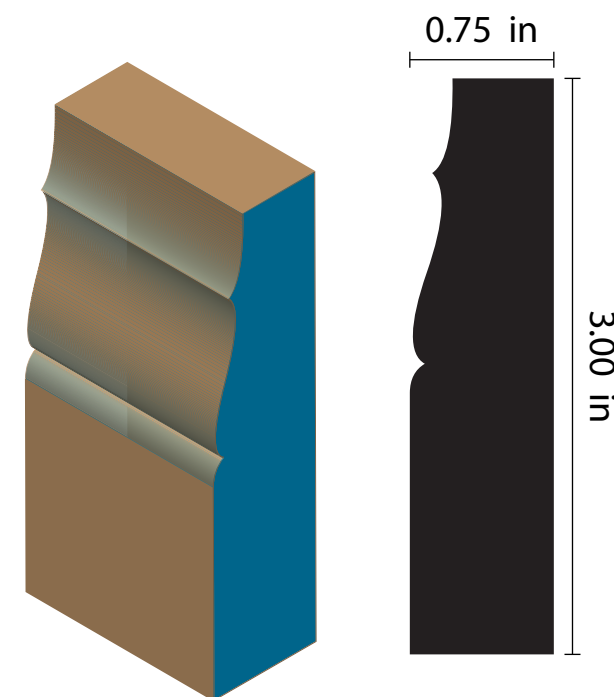

**BS-016**

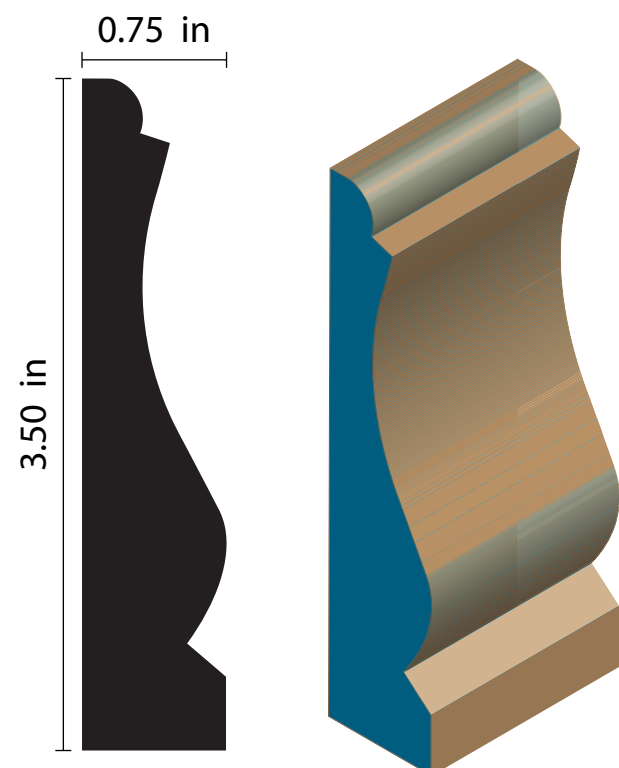

**BS-014**

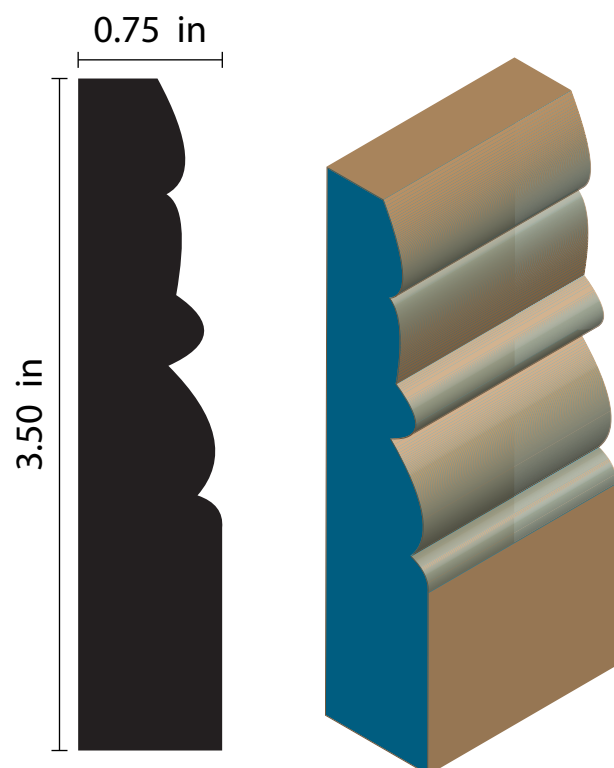

**BS-015**

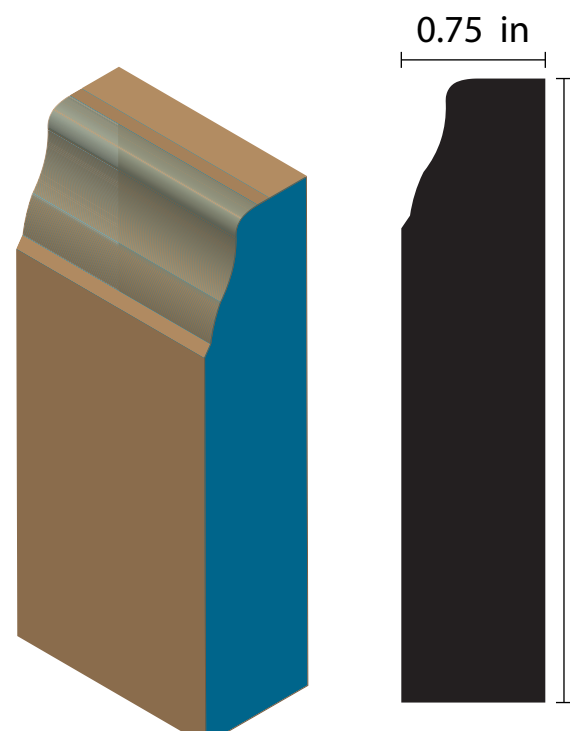

**BS-019**

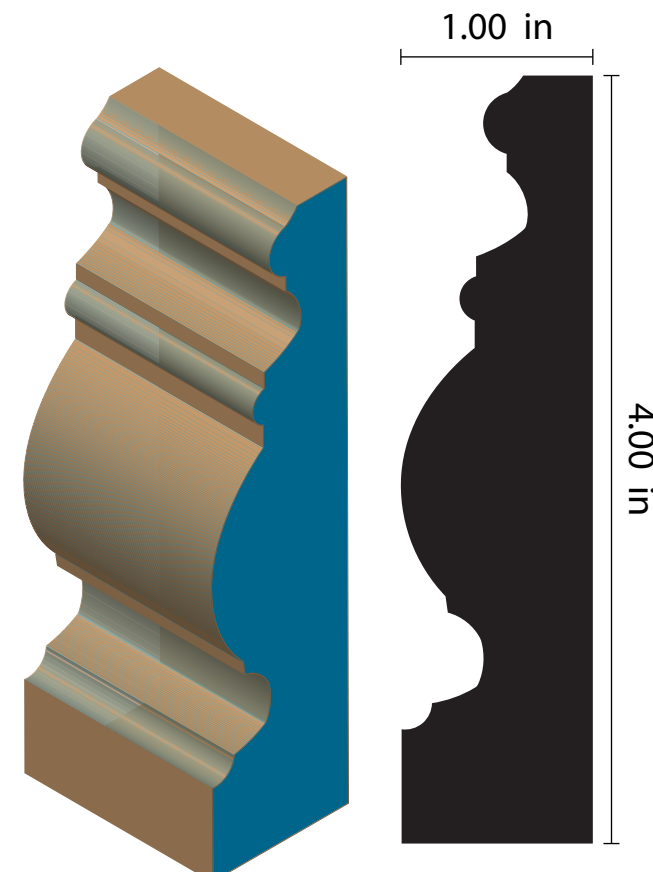

**BS-018**



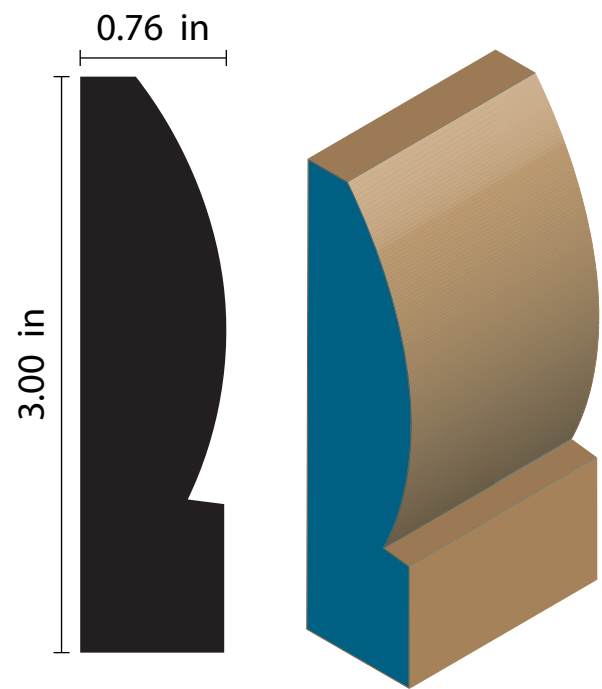

**BS-020**

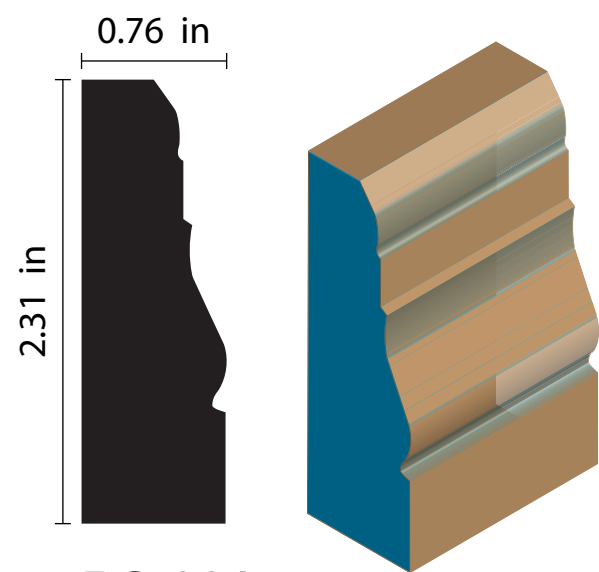

**BS-021**

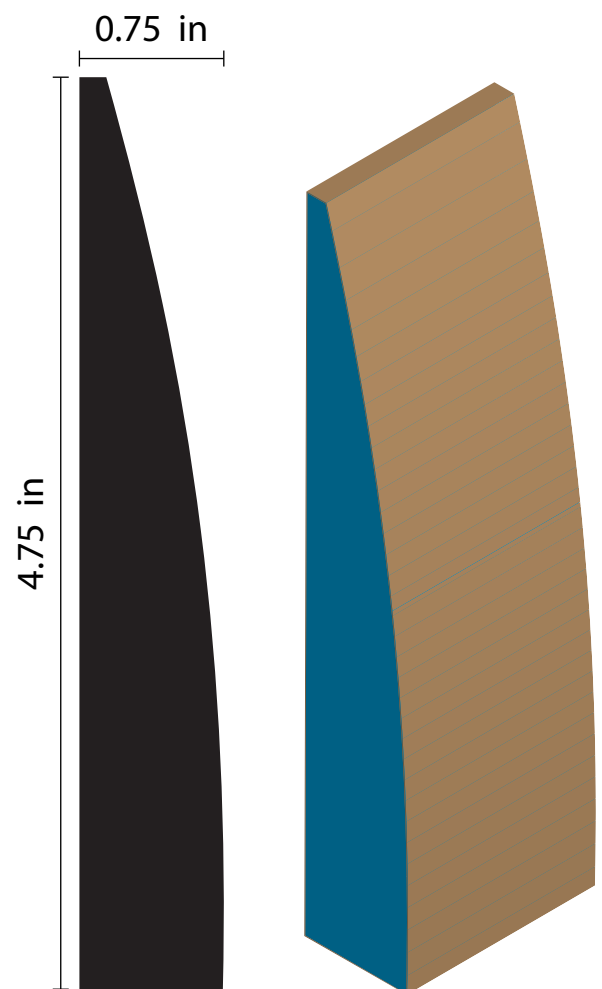

**BS-023**

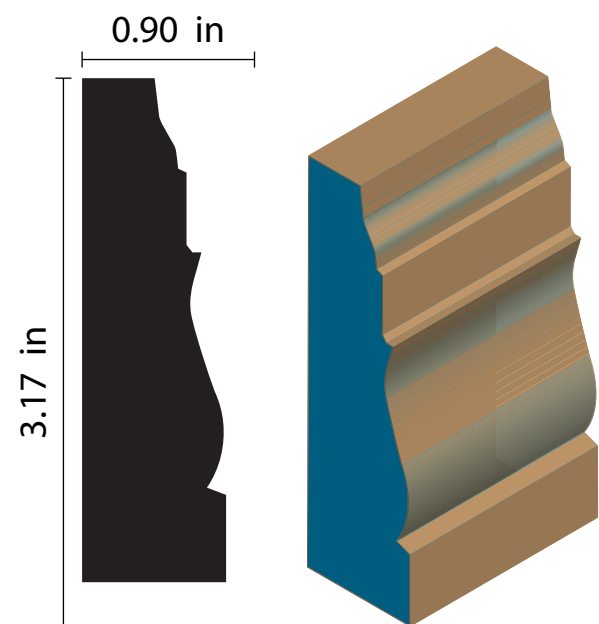

**BS-022**

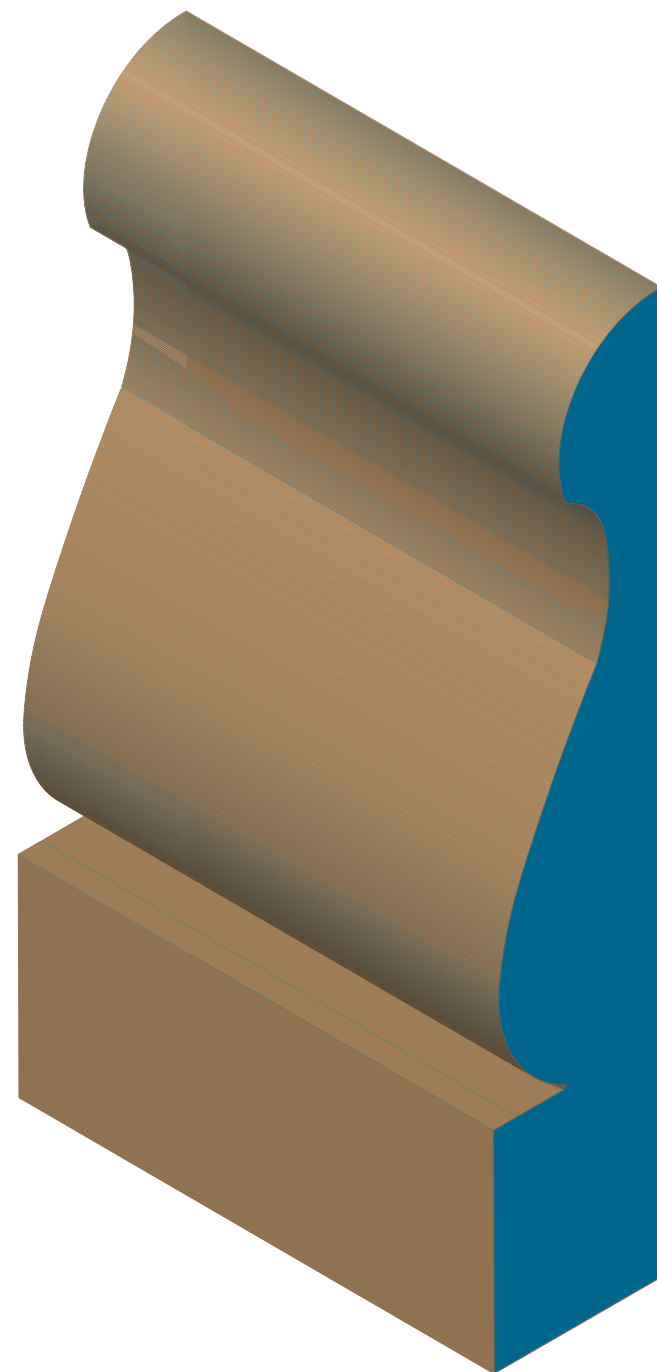

**BS-024**





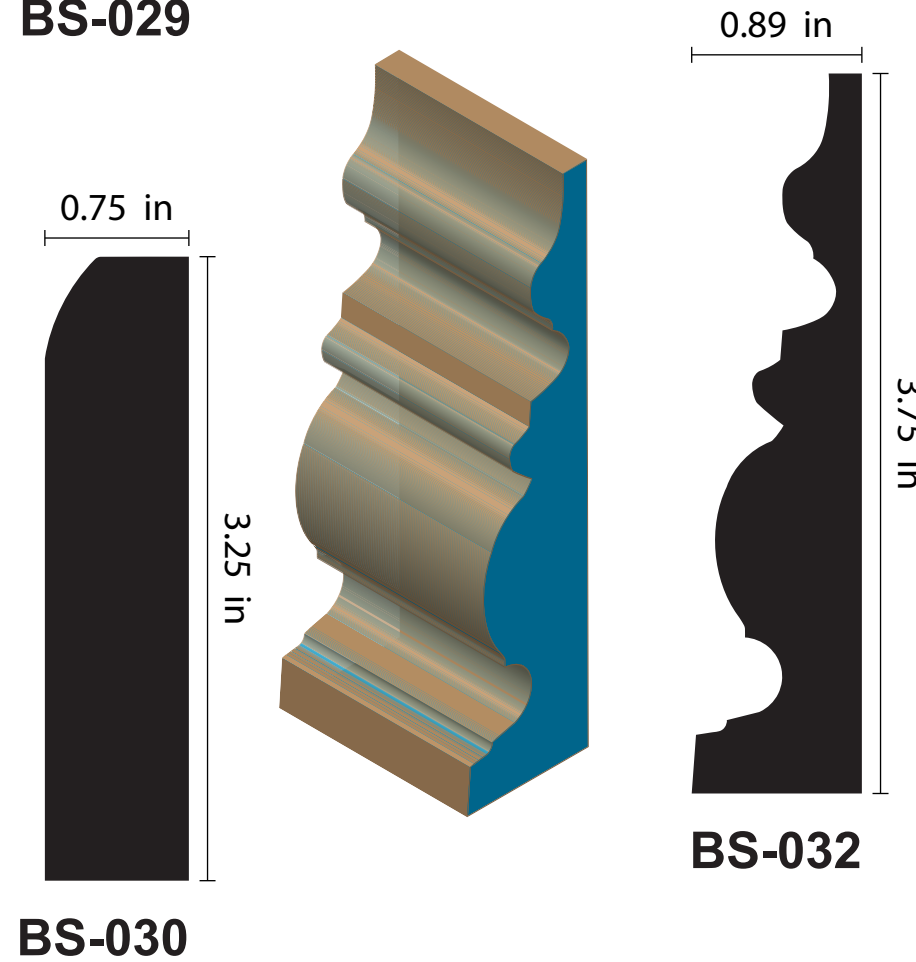
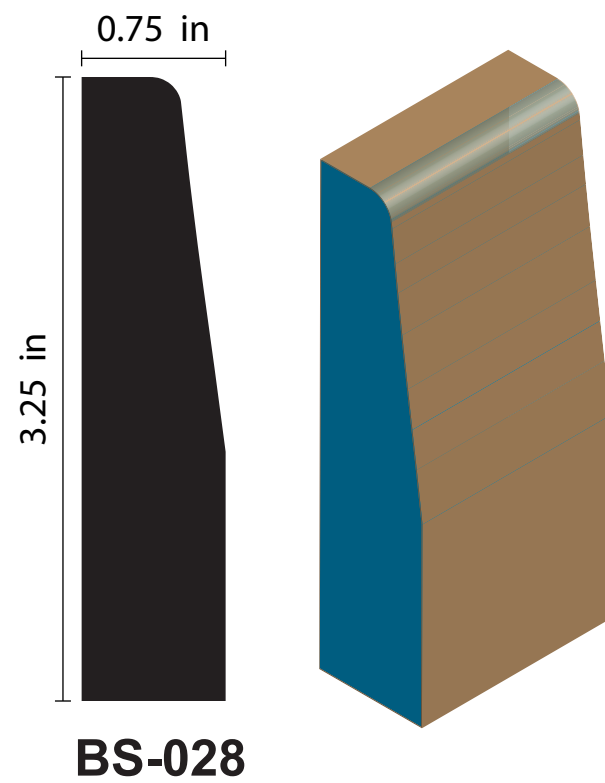
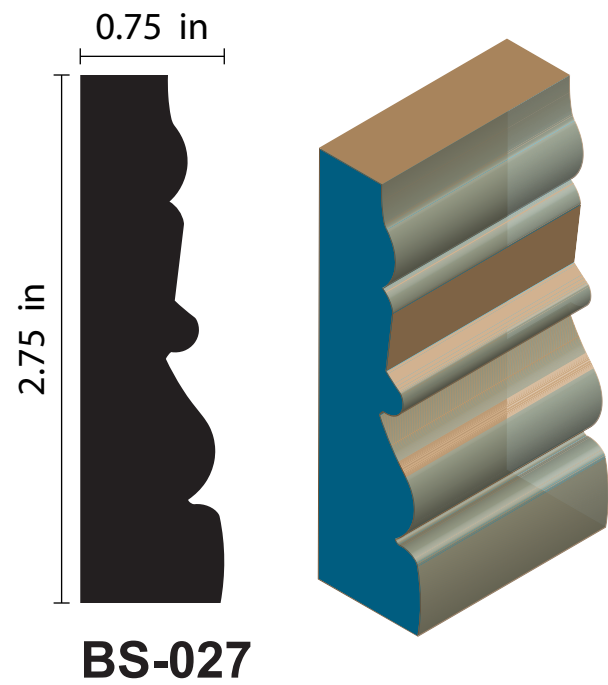
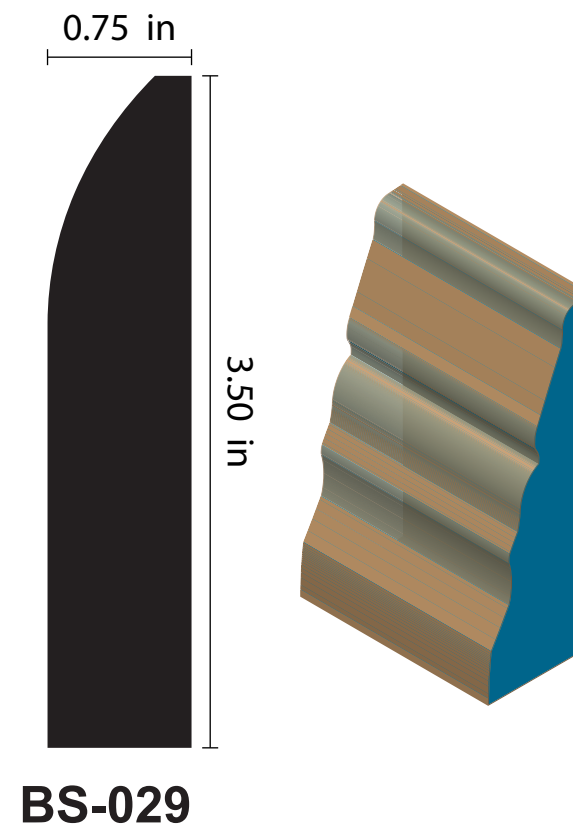
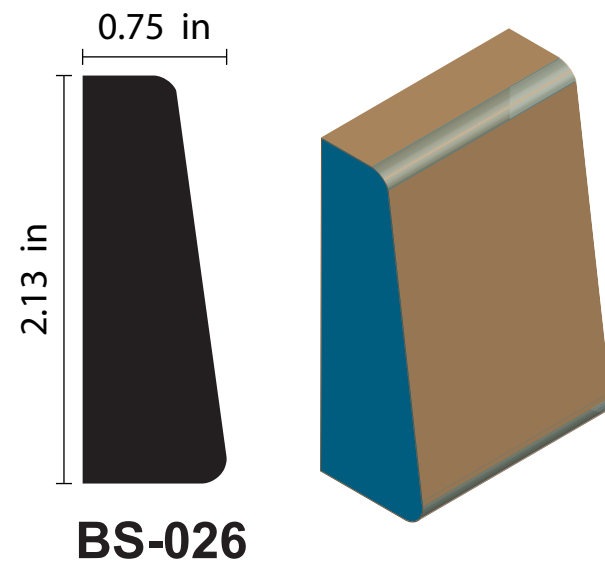
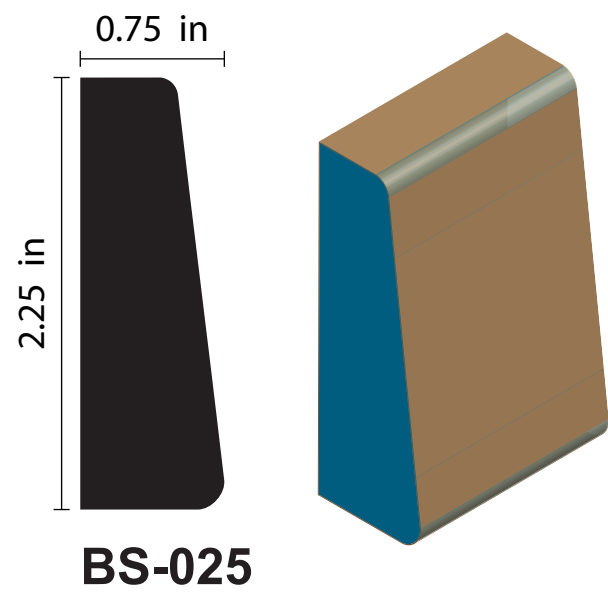



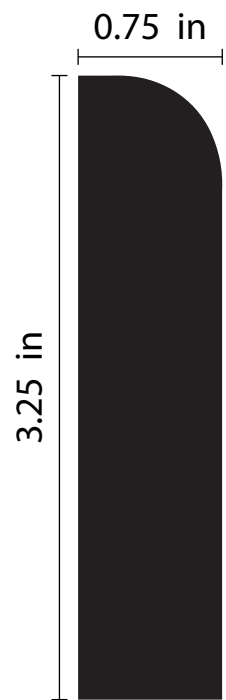

BS-033

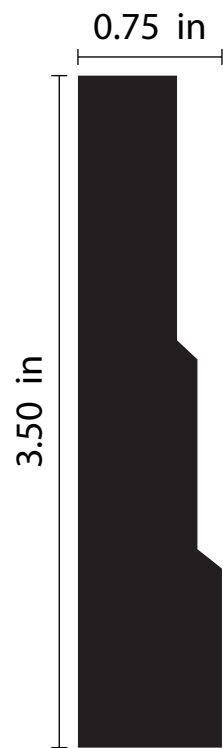
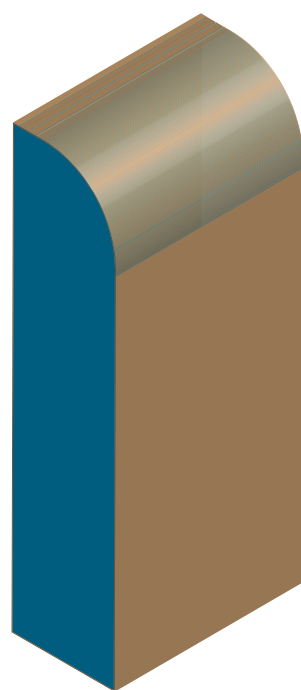

BS-034

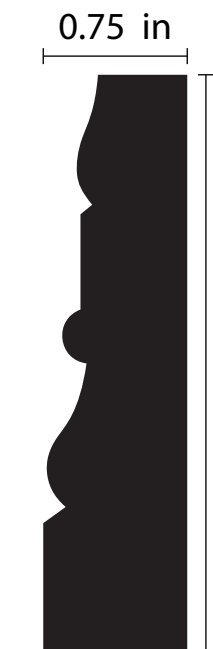
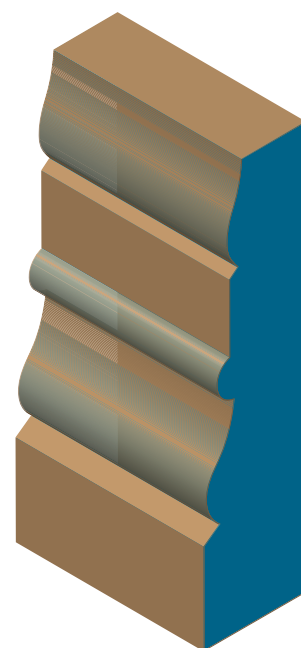
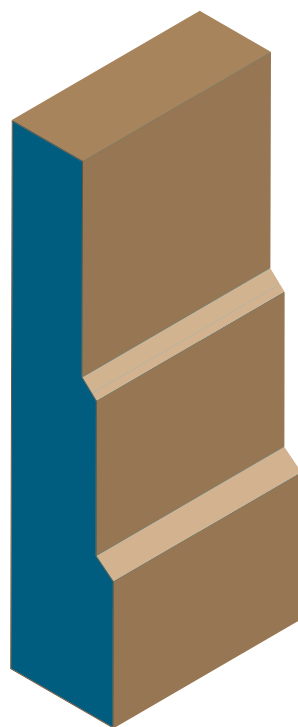

BS-037

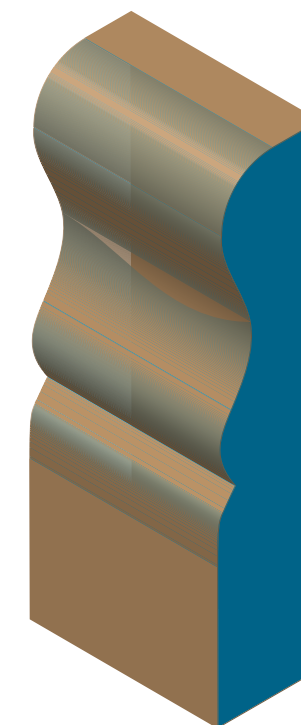

BS-038

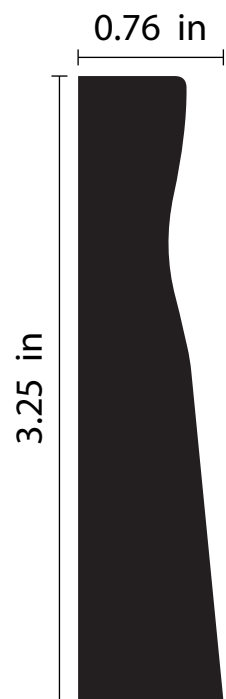

BS-035

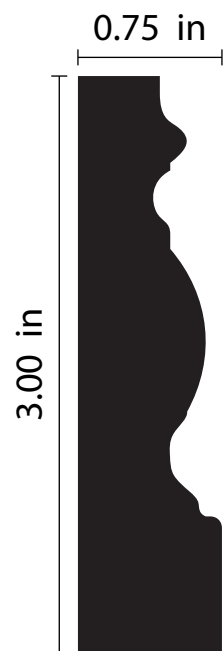
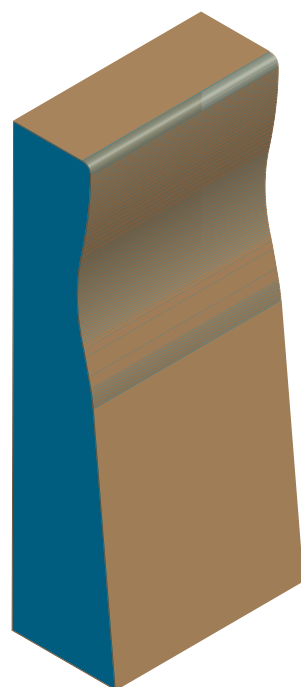

BS-036

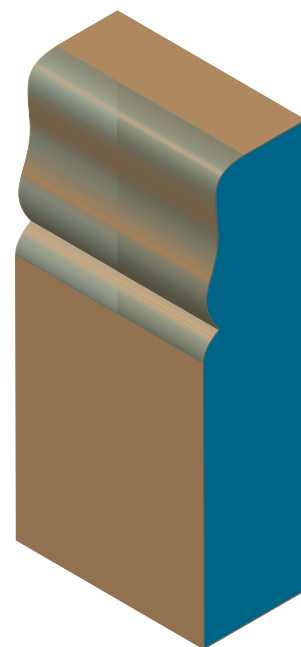
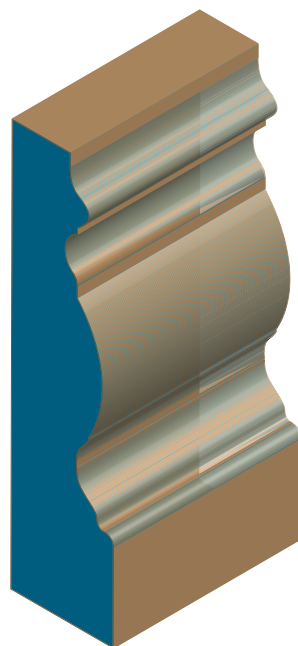

BS-039

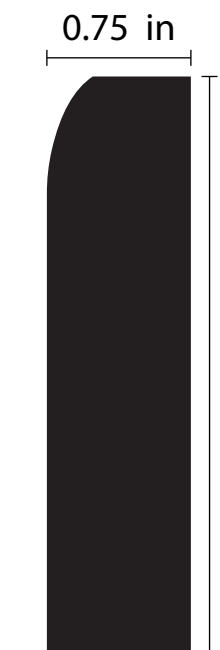

BS-040



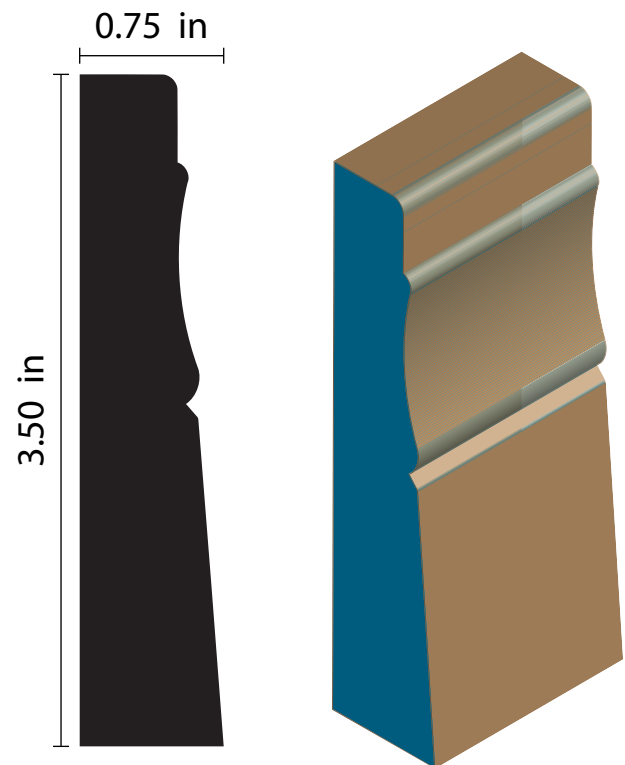

BS-042

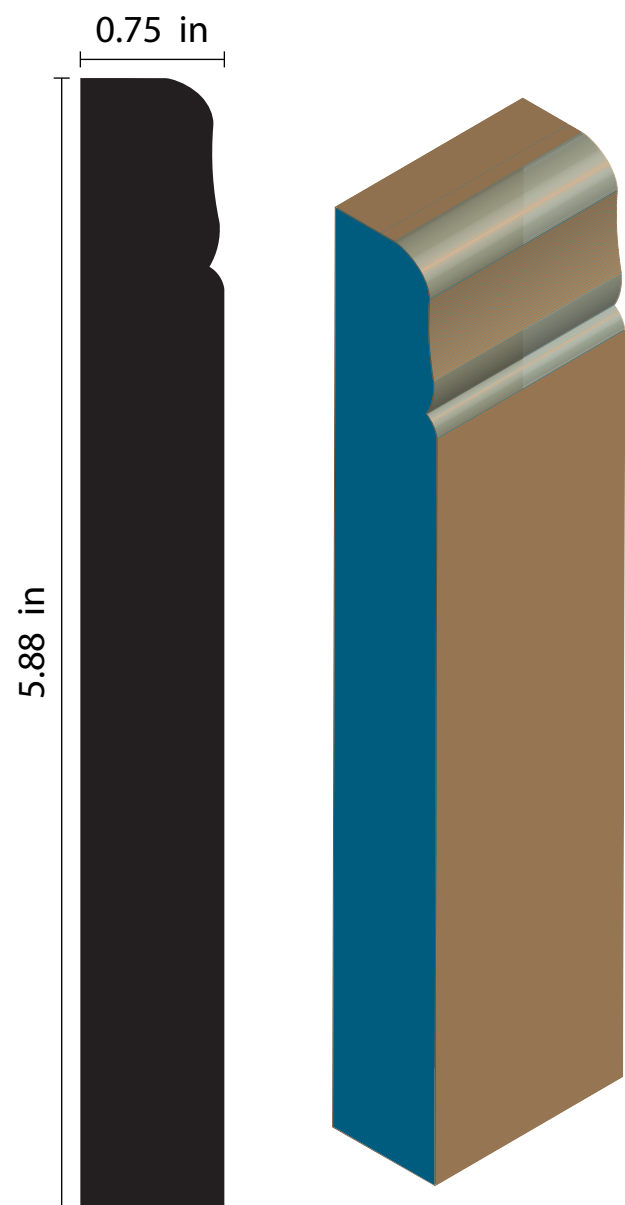

BS-041

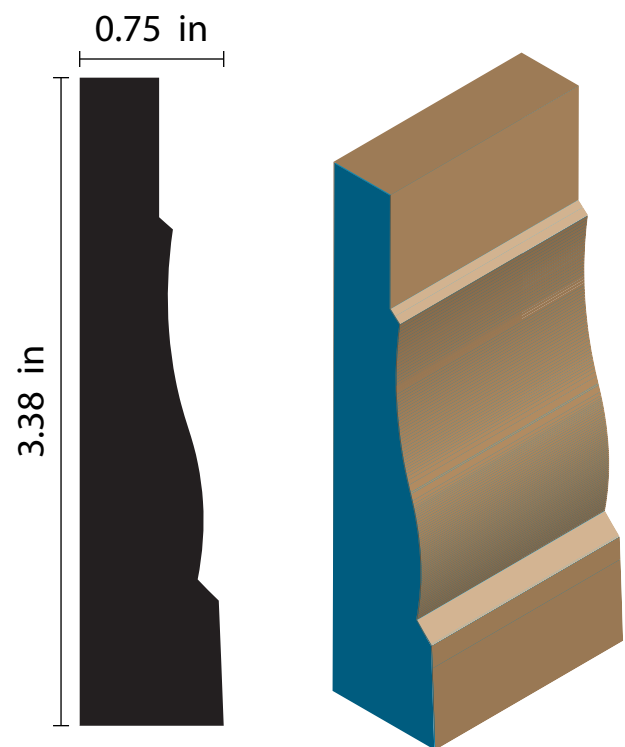

BS-043

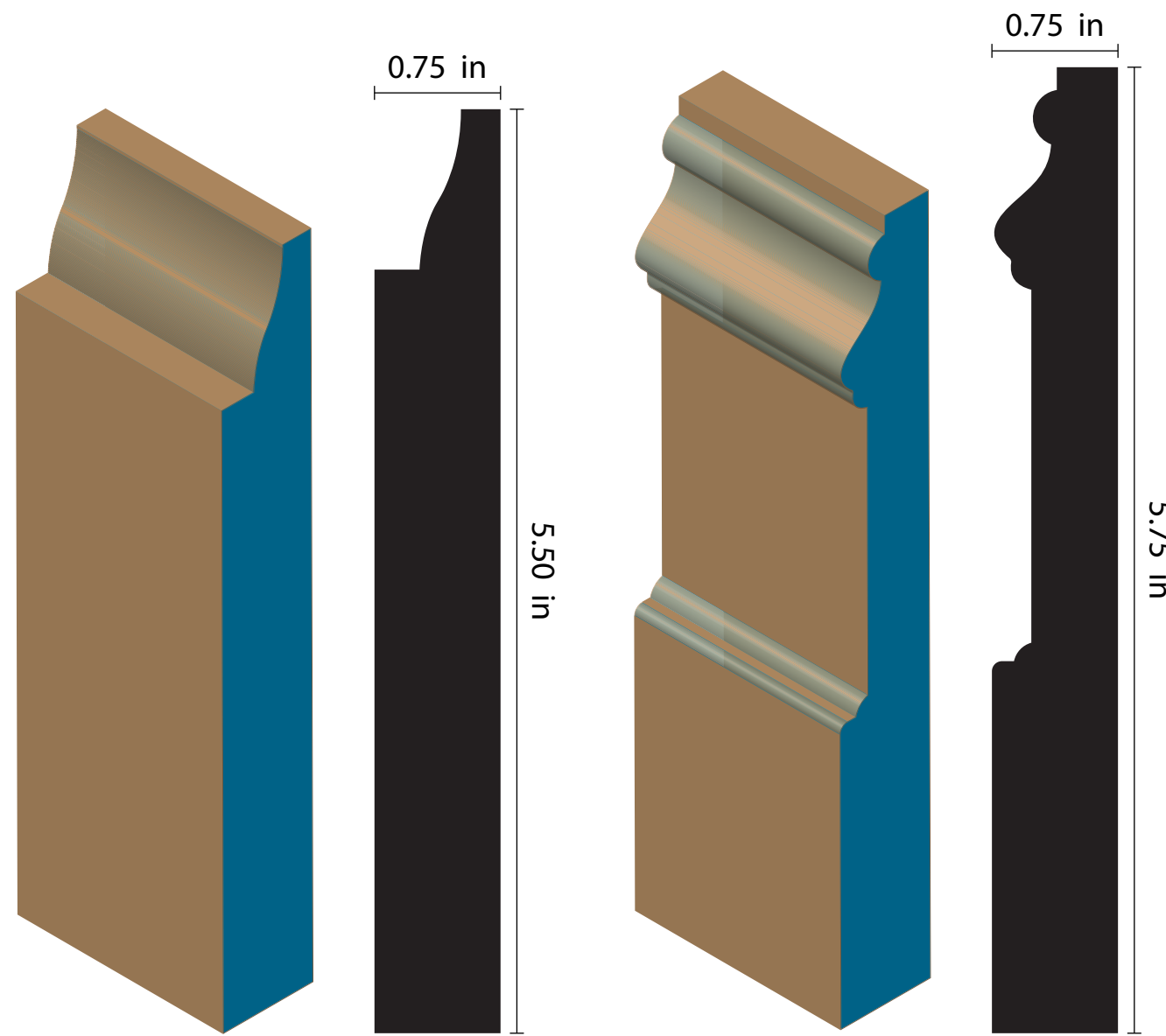

BS-044

BS-045



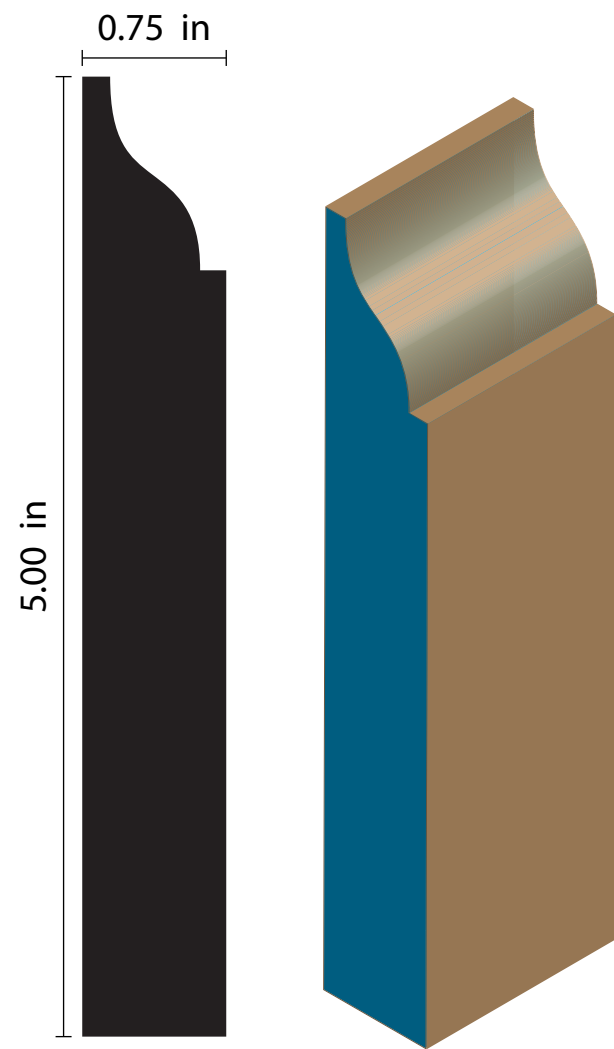

BS-046

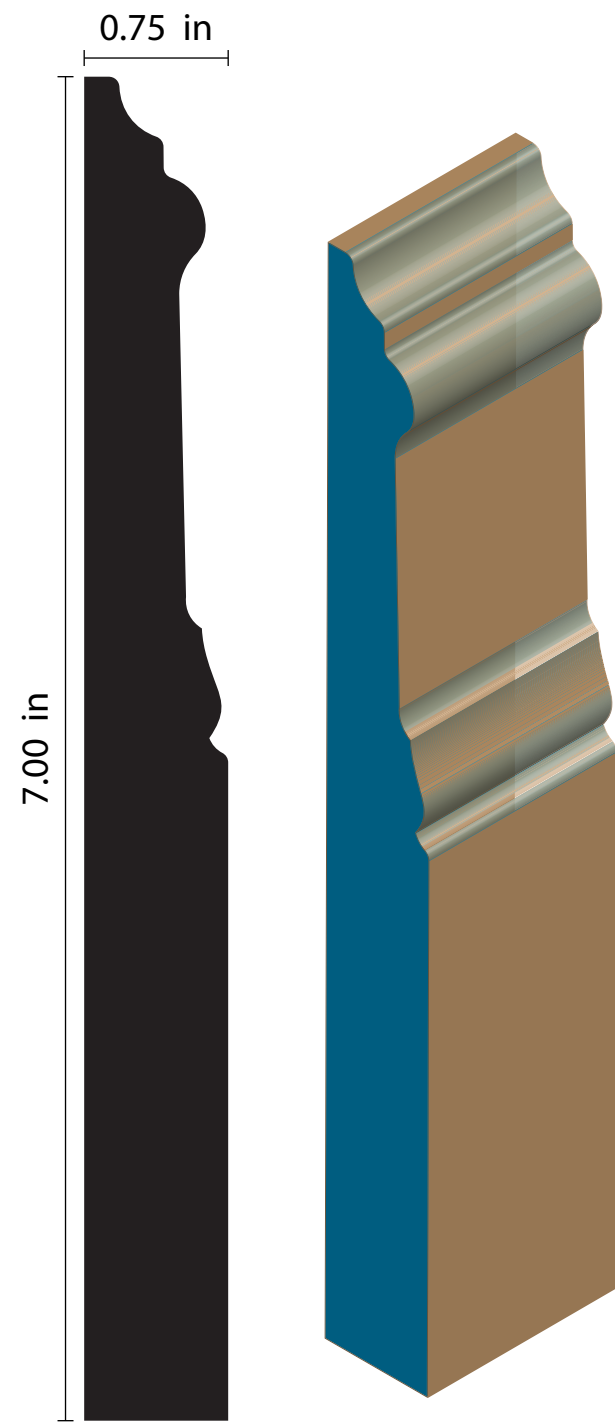

BS-047

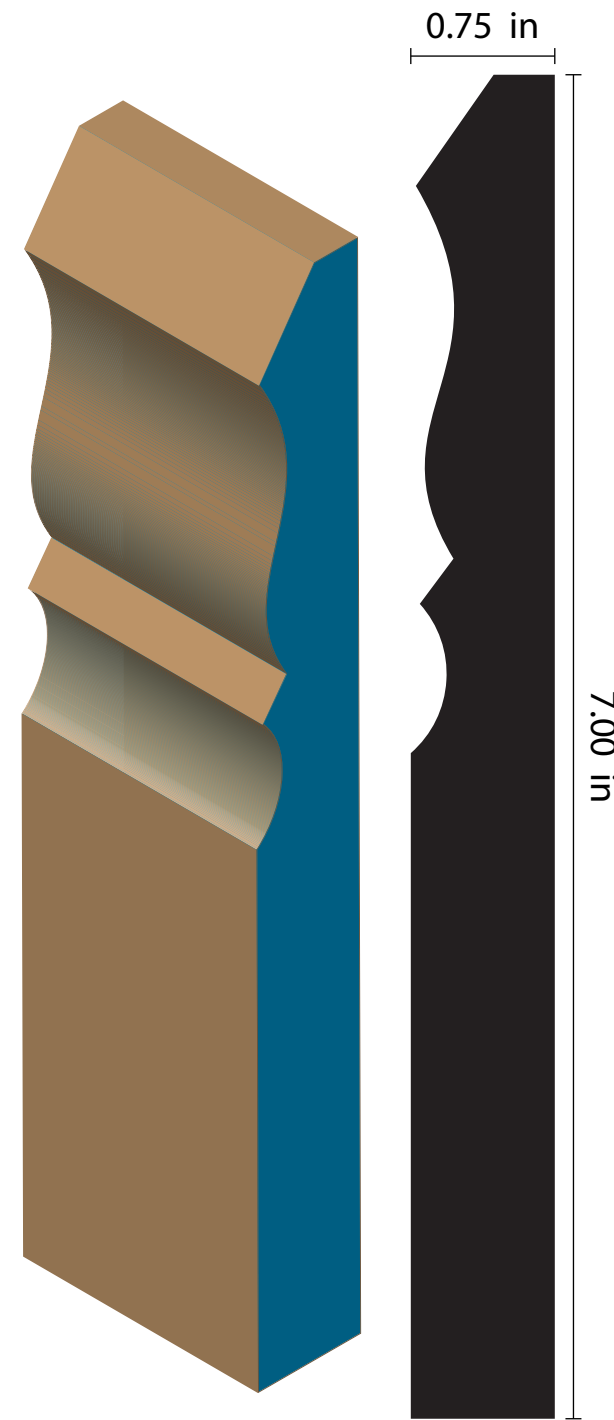

BS-048

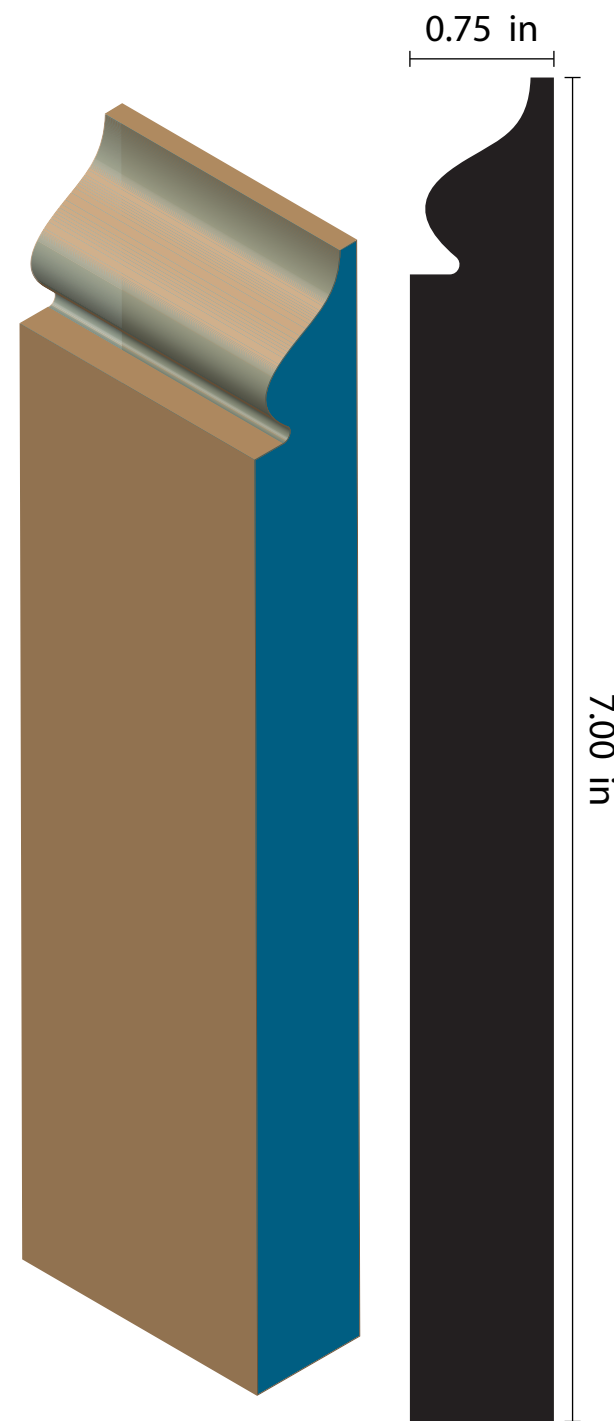

BS-049



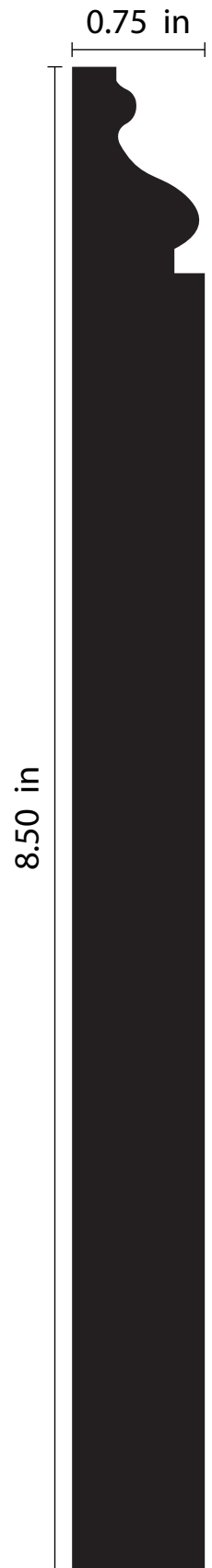

BS-050

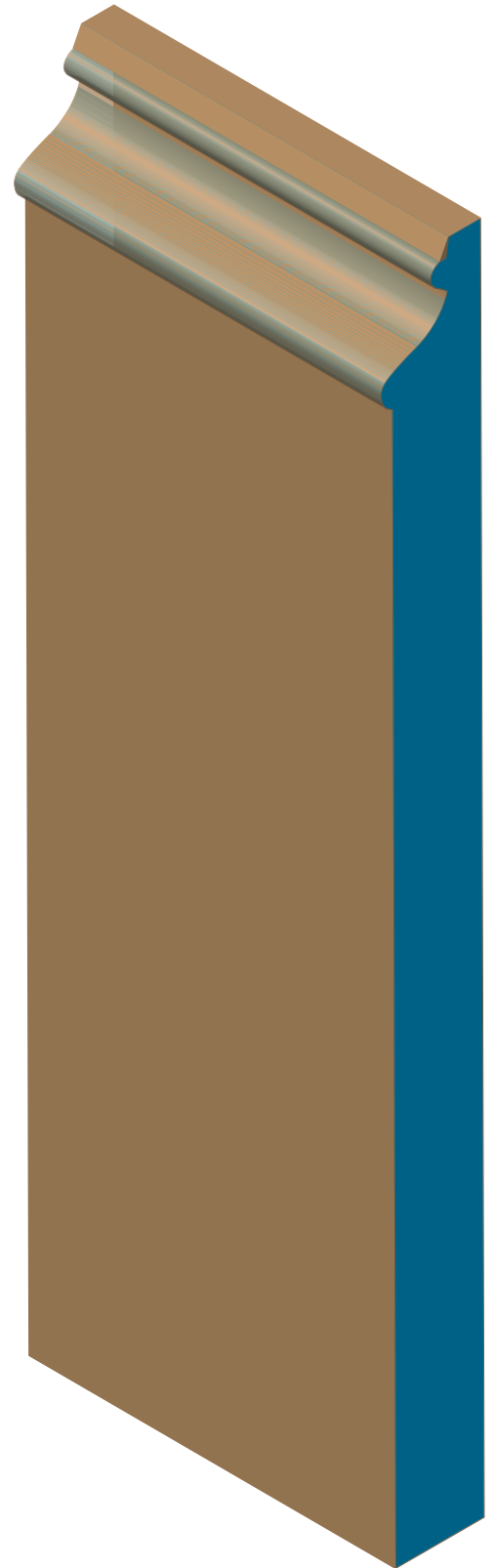
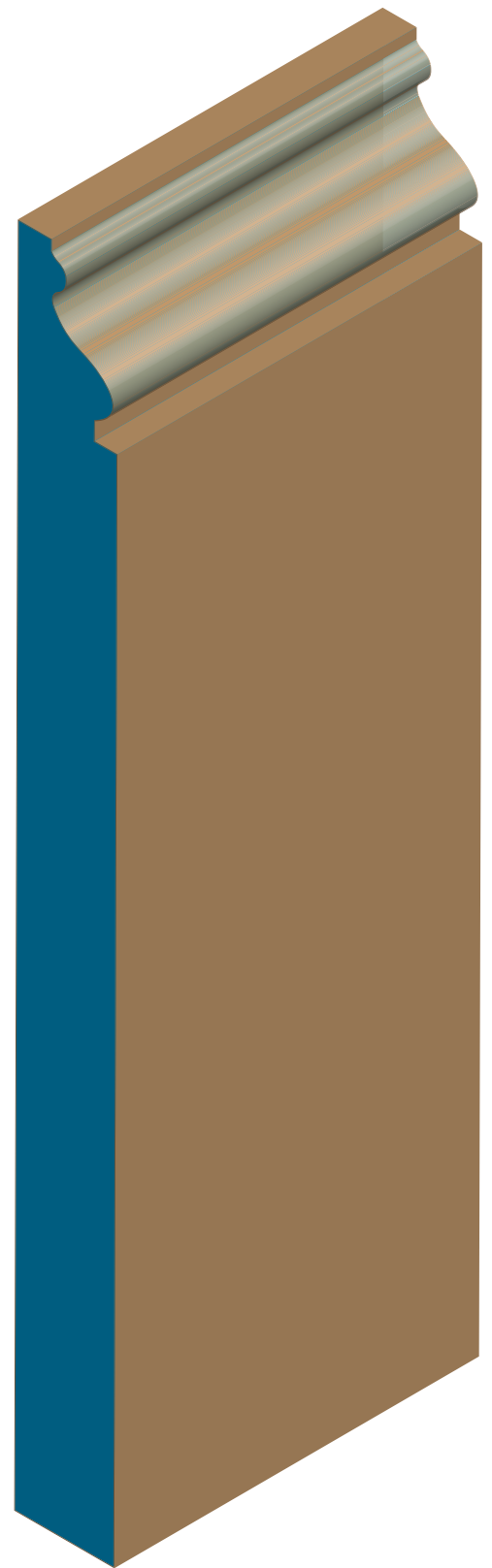

BS-051





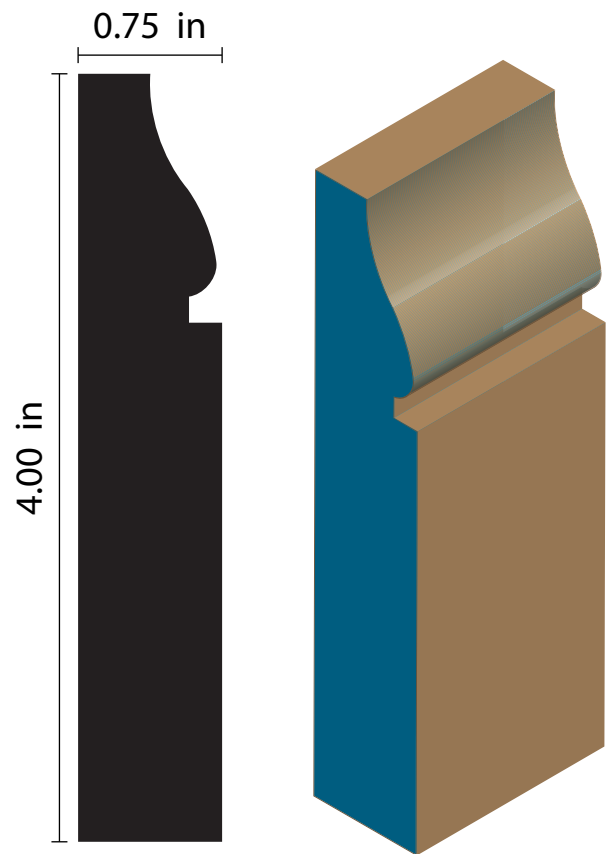

**BS-052**

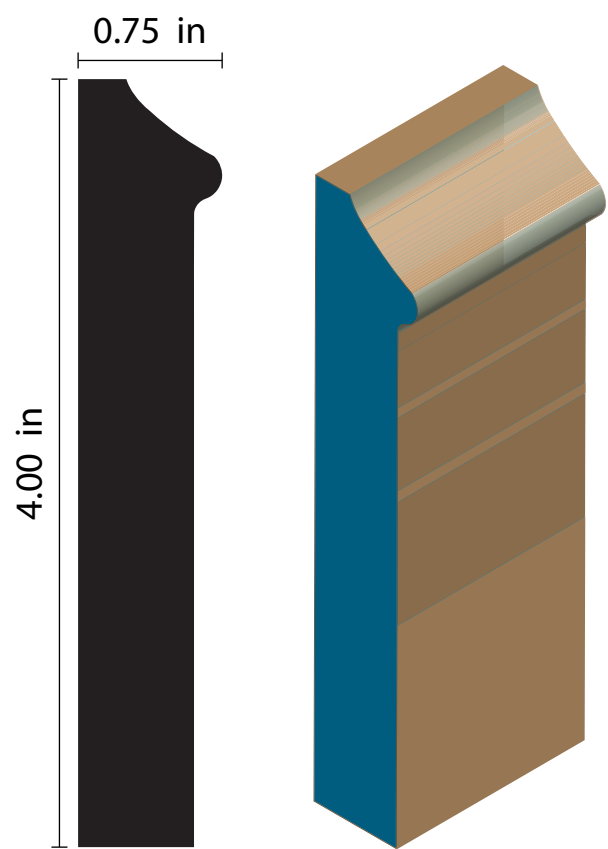

**BS-053**

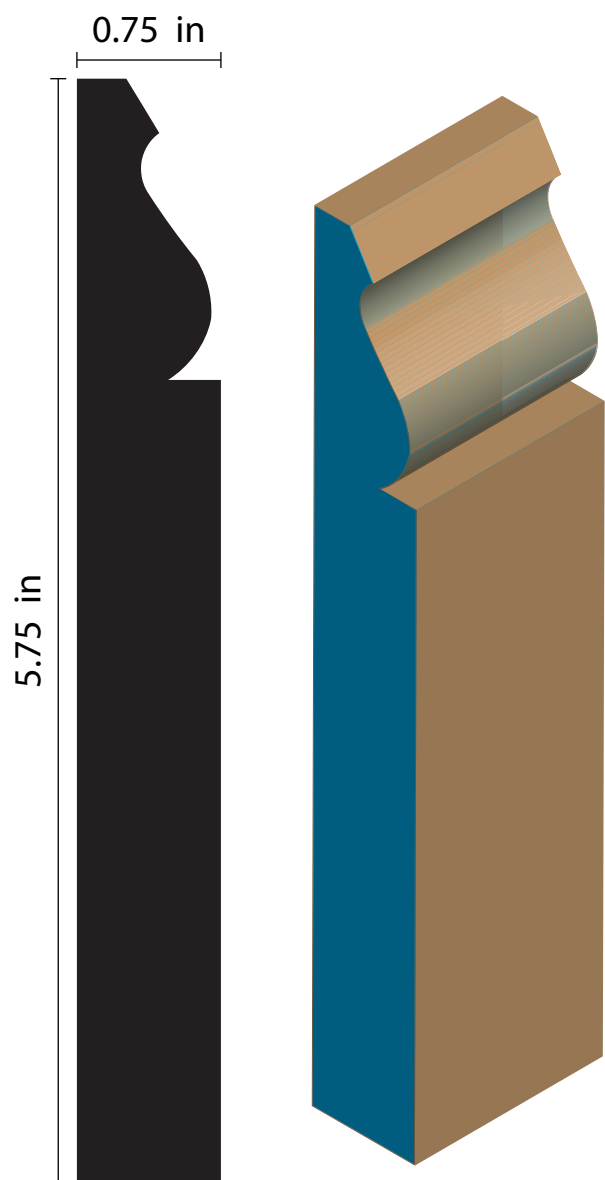

**BS-054**

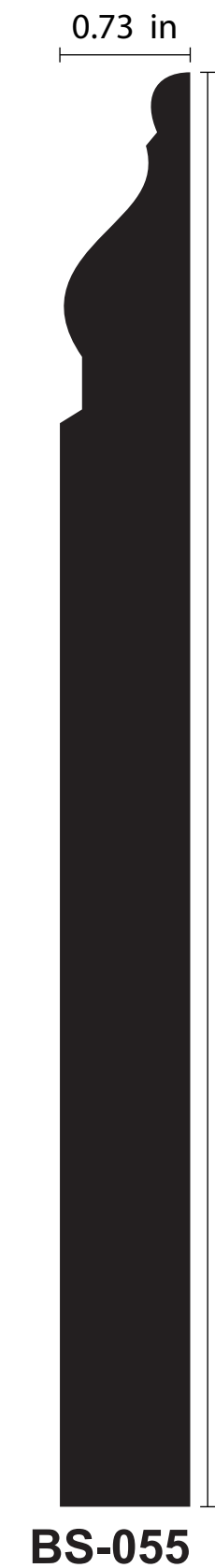

**BS-055**



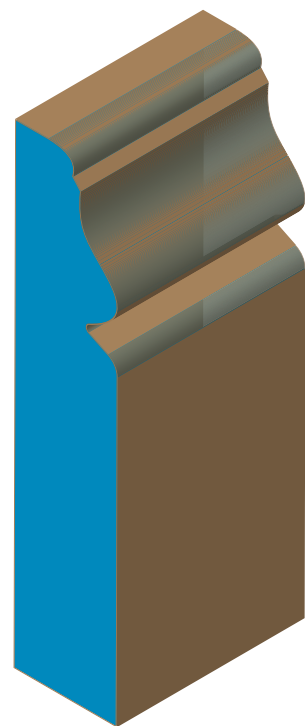
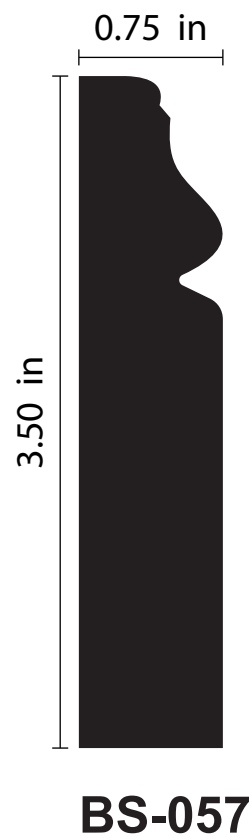
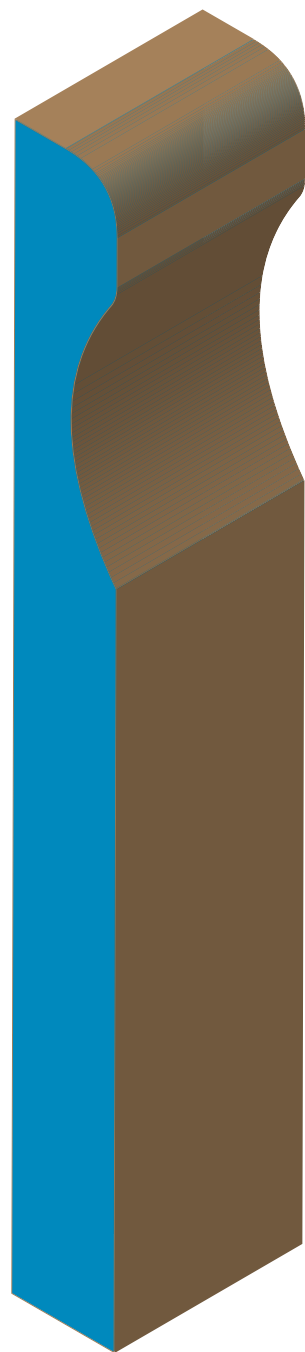
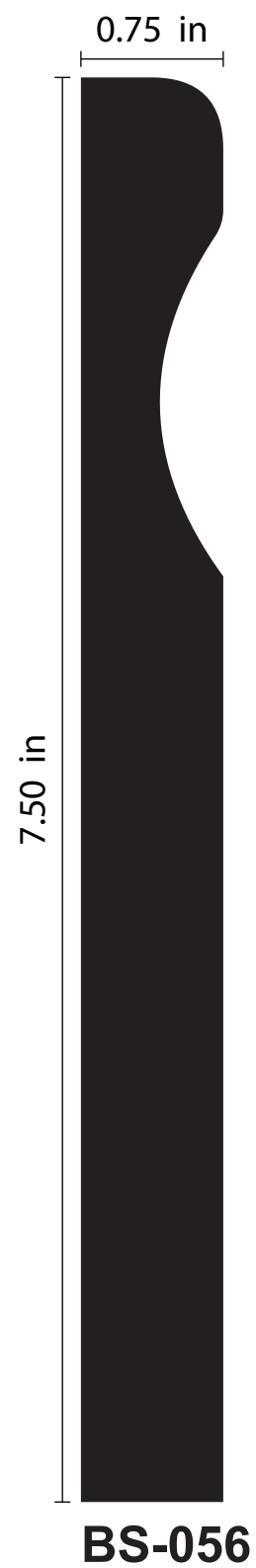

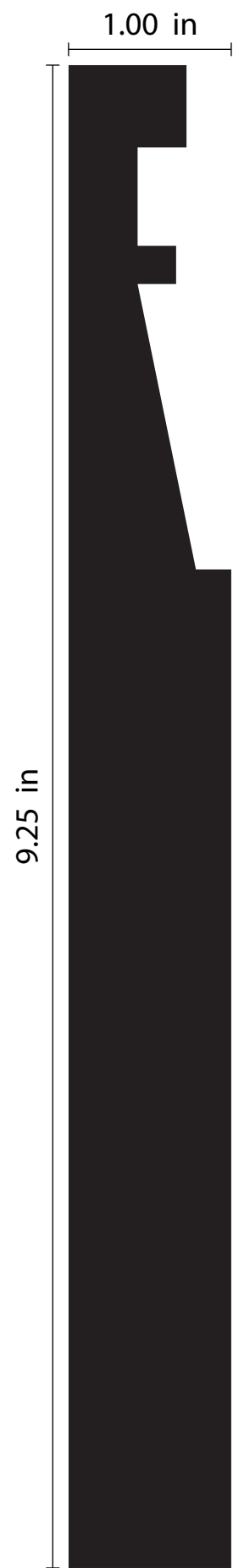

BS-061

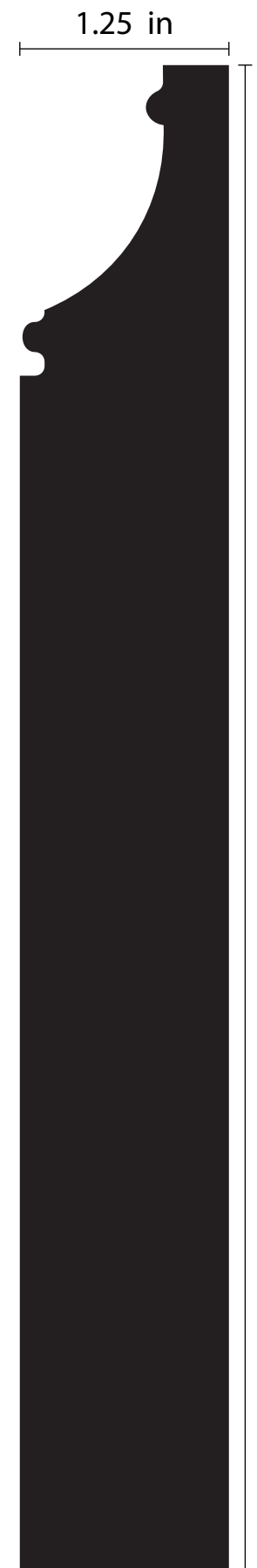

BS-062



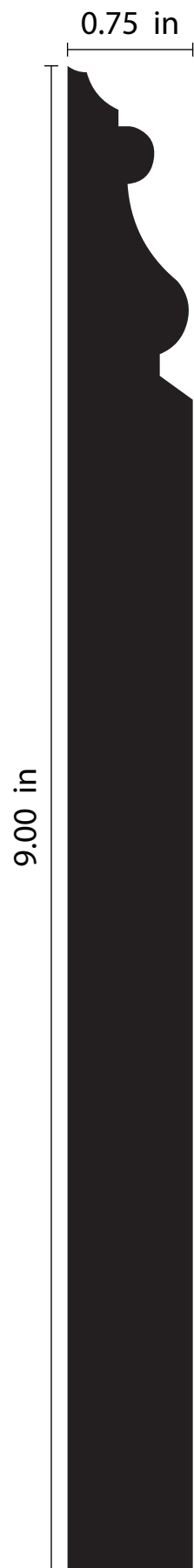

BS-064

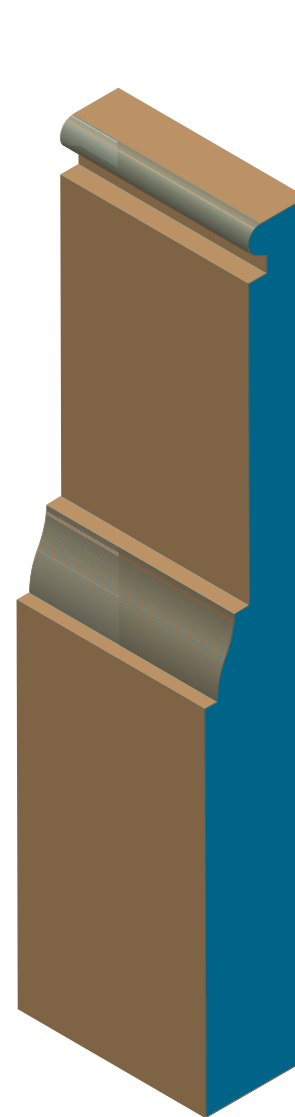
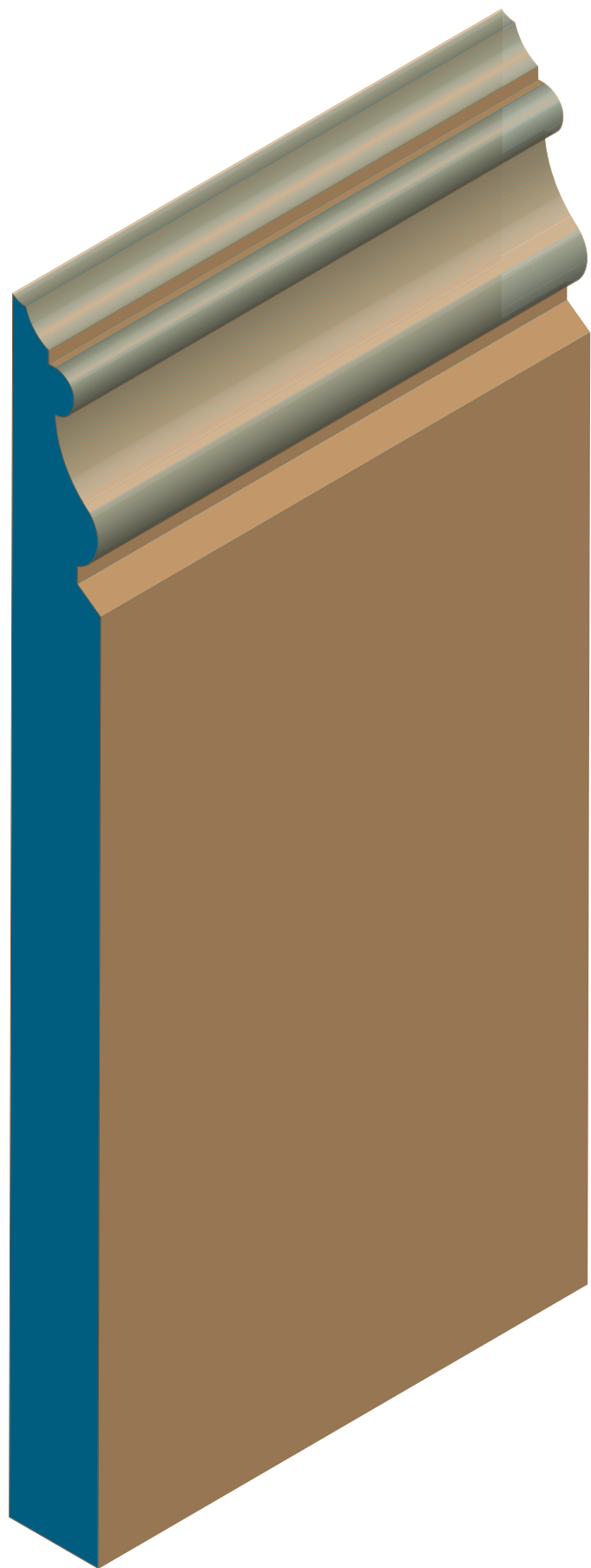

BS-063

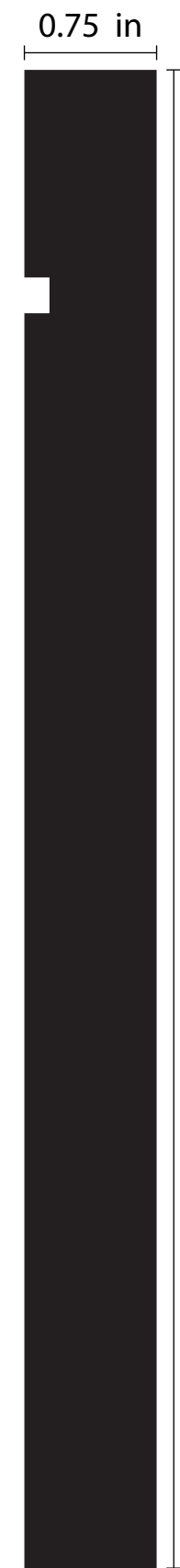

BS-065





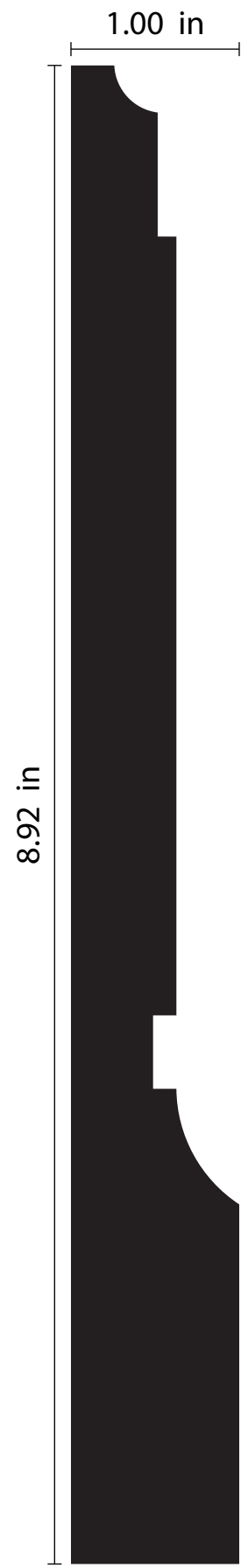

BS-066

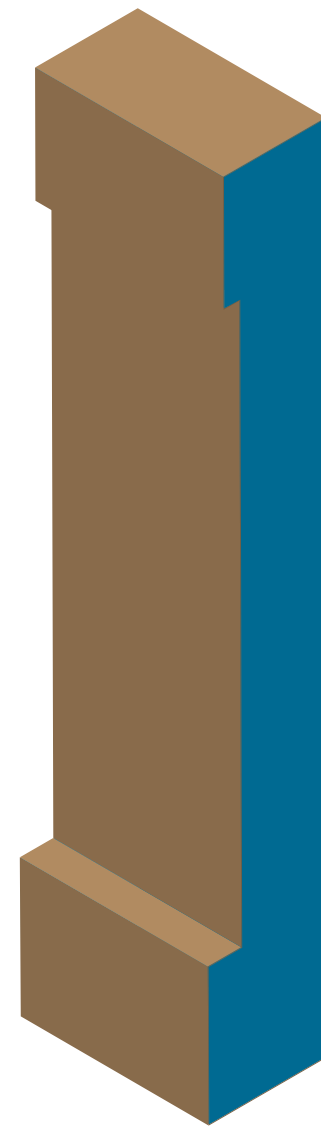
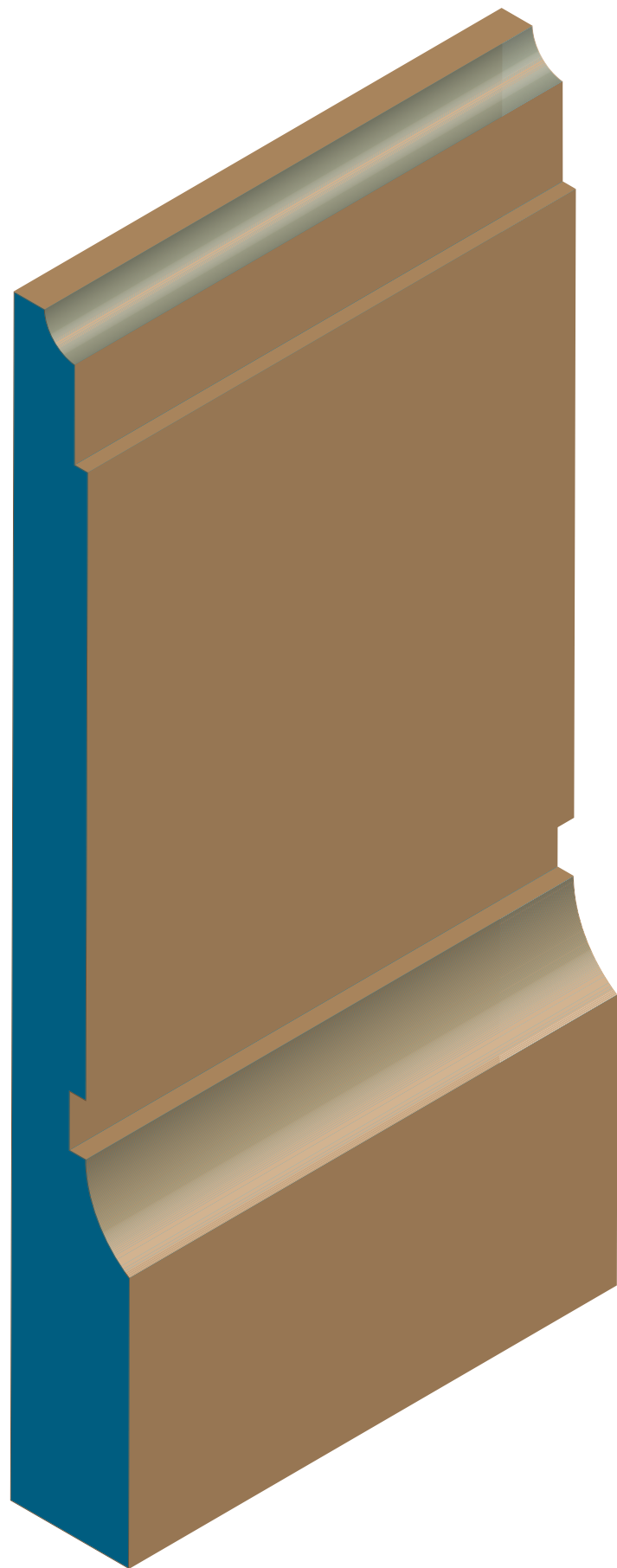

BS-067/68



BS-071

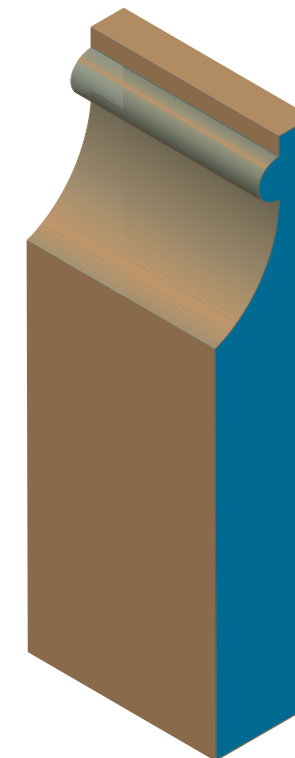

BS-069

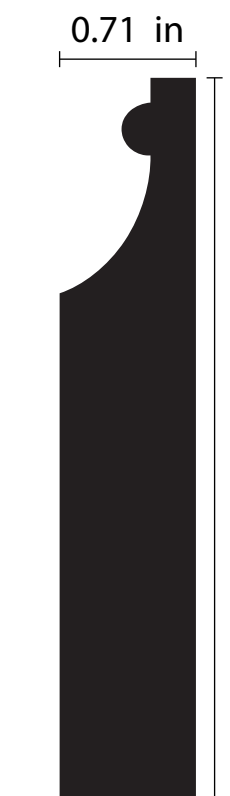

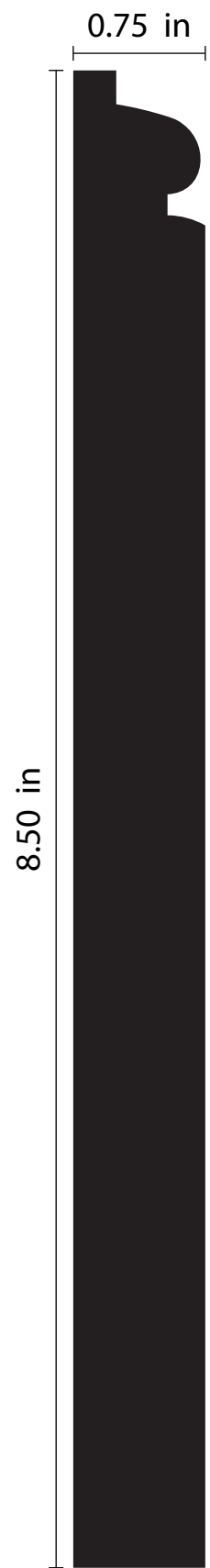

BS-070

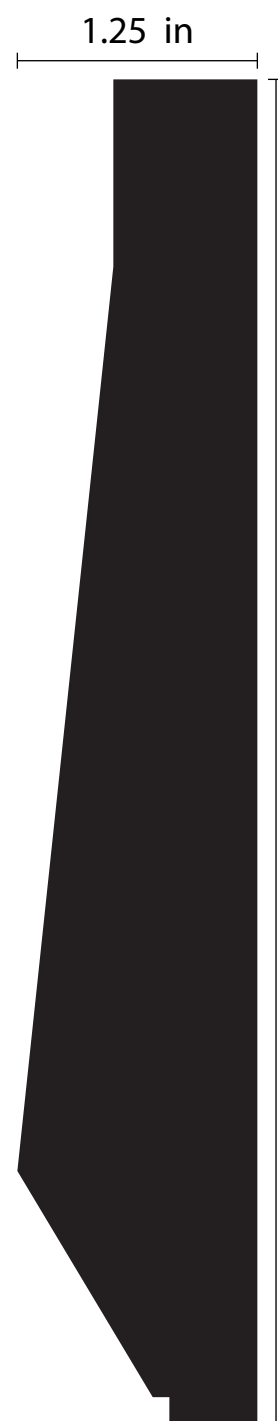
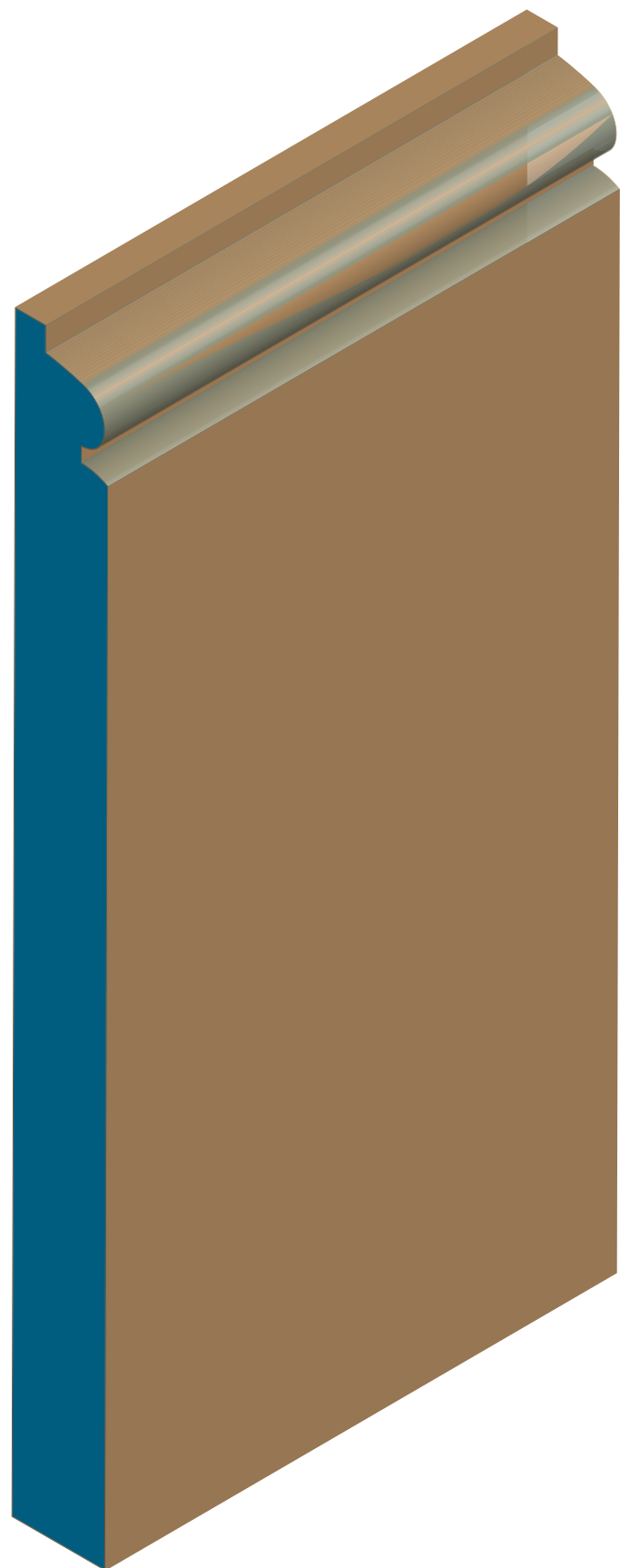

BS-073



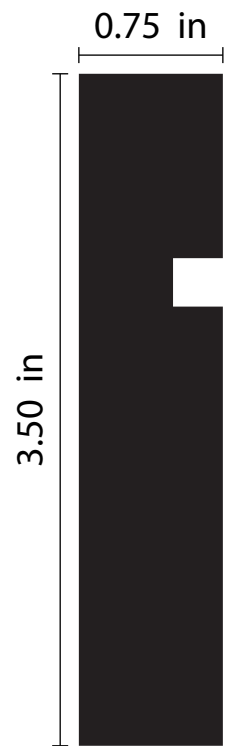

BS-072

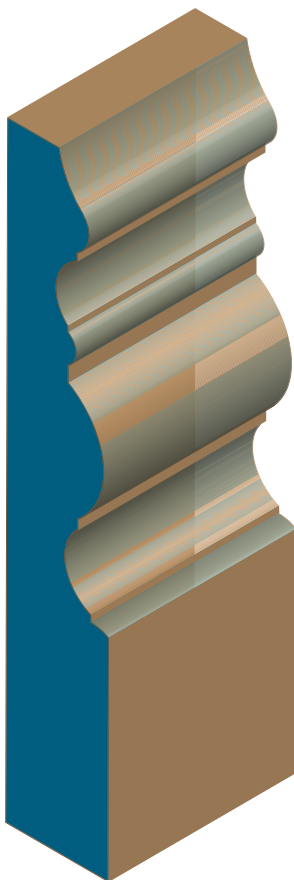
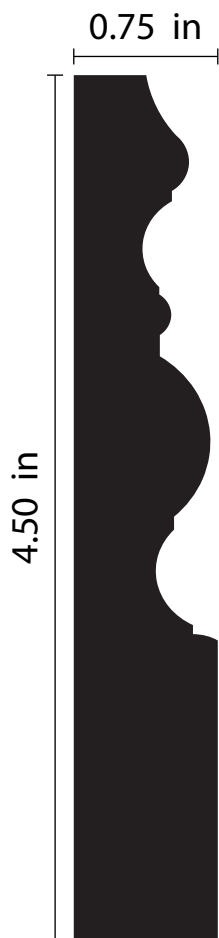

BS-075

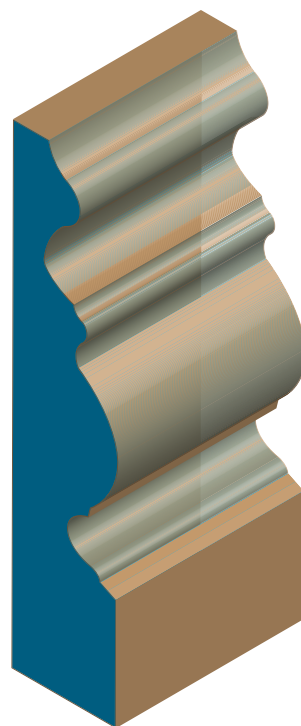
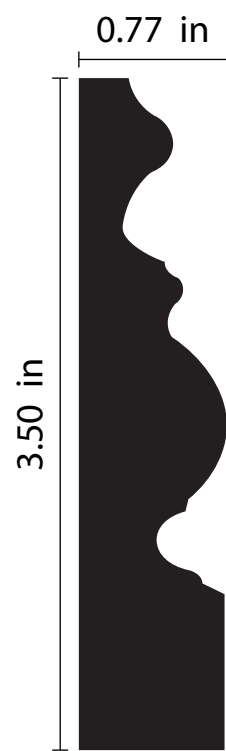

BS-077

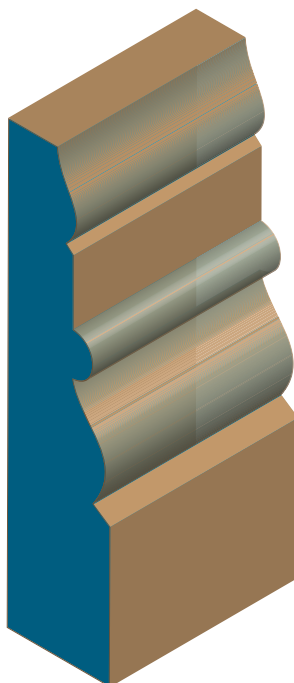
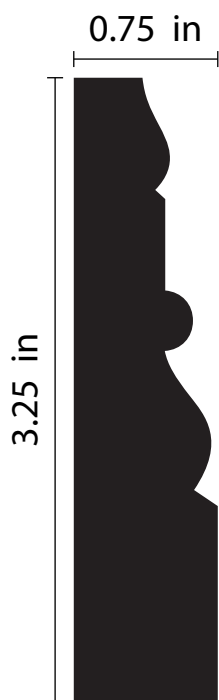

BS-074



BS-076



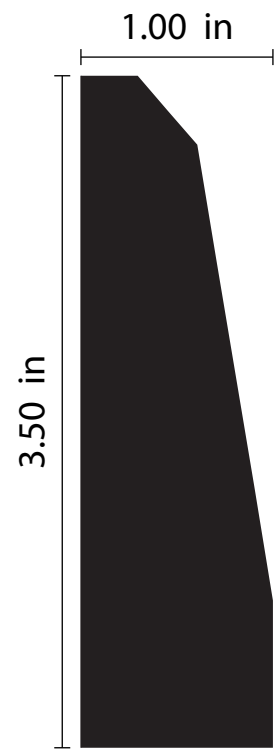

BS-078

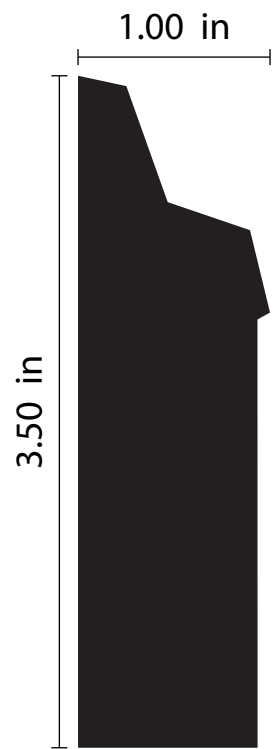

BS-080

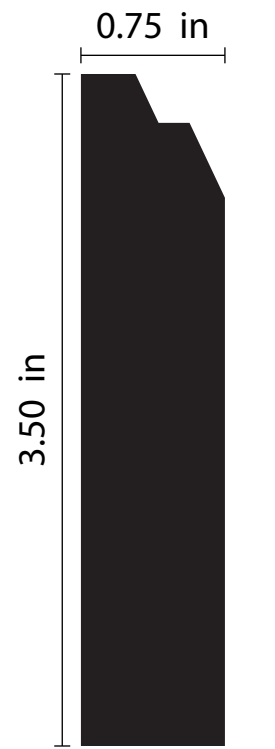

BS-079

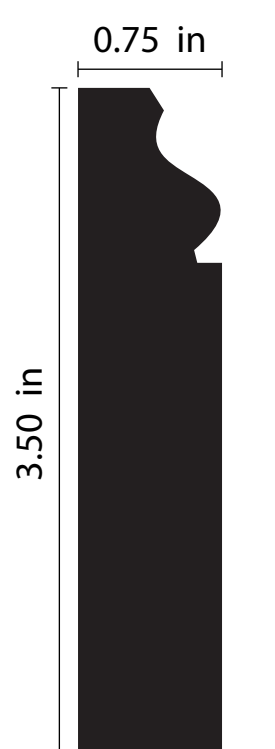

BS-081

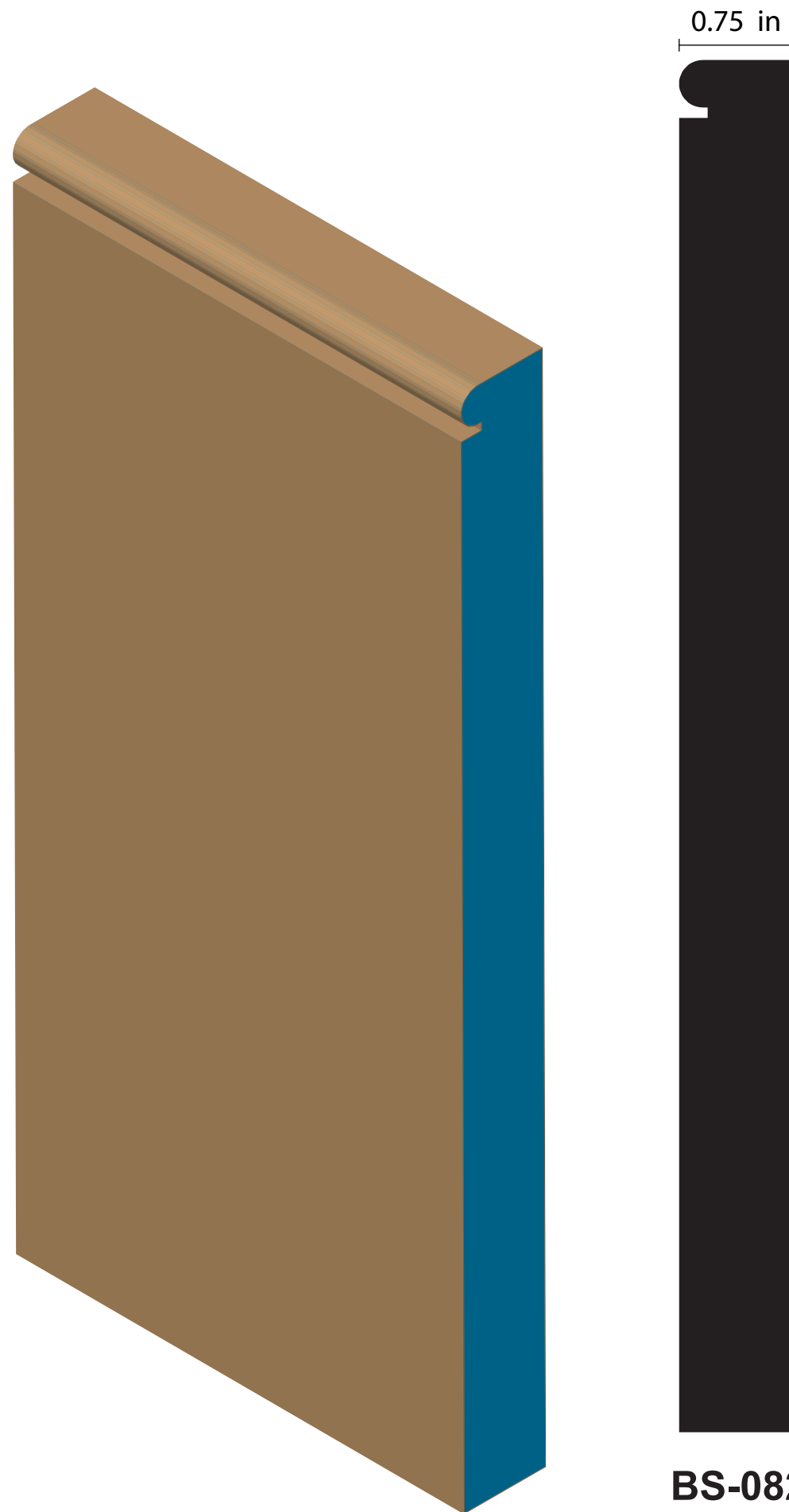

BS-082





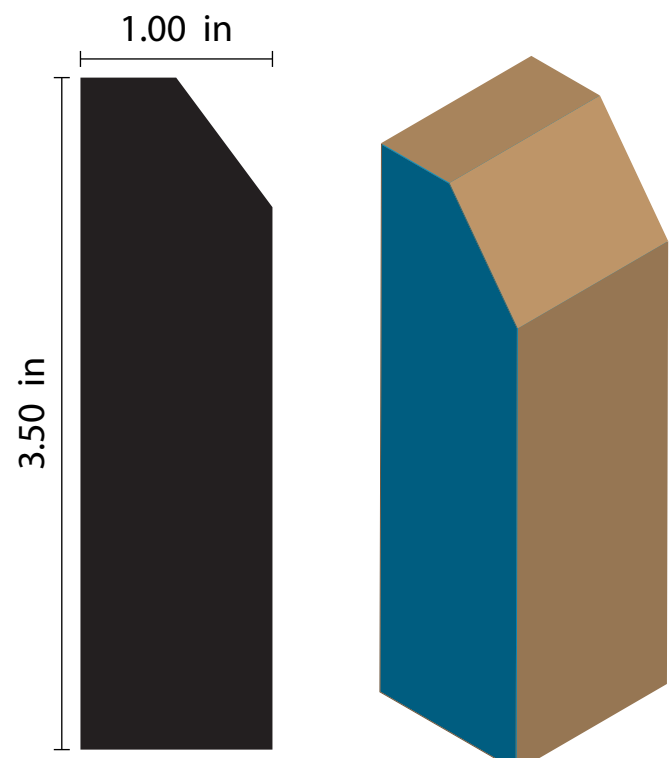

BS-083

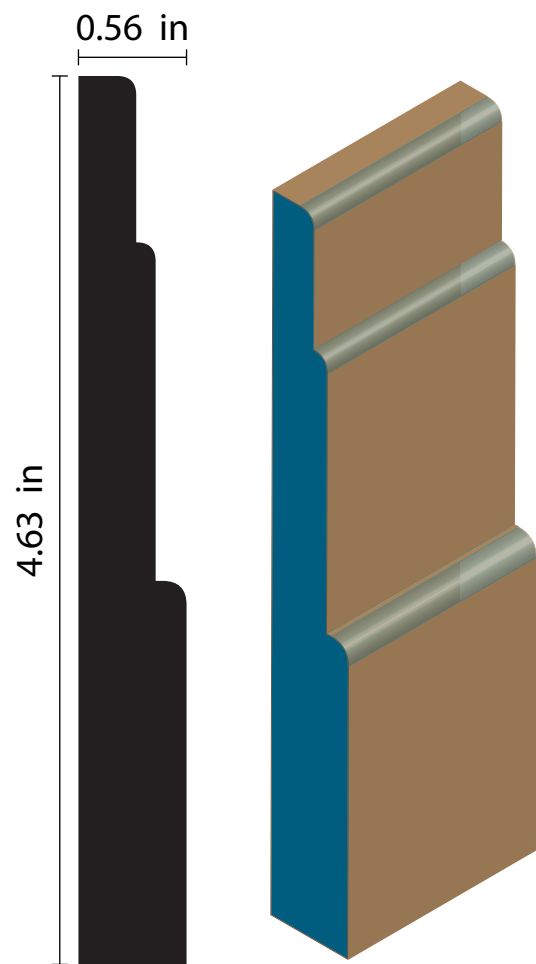

BS 086

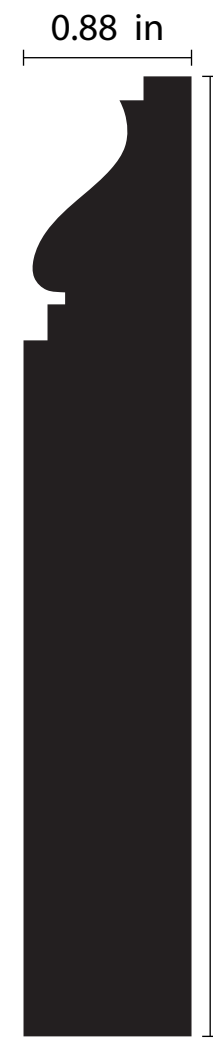
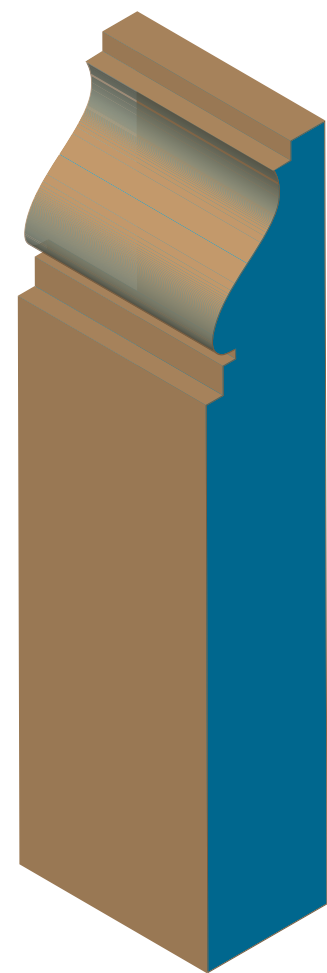

BS-087

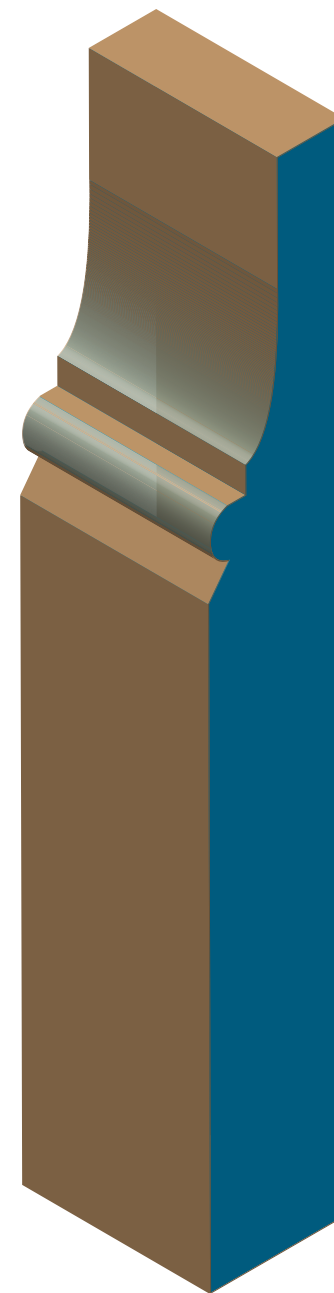

BS-085

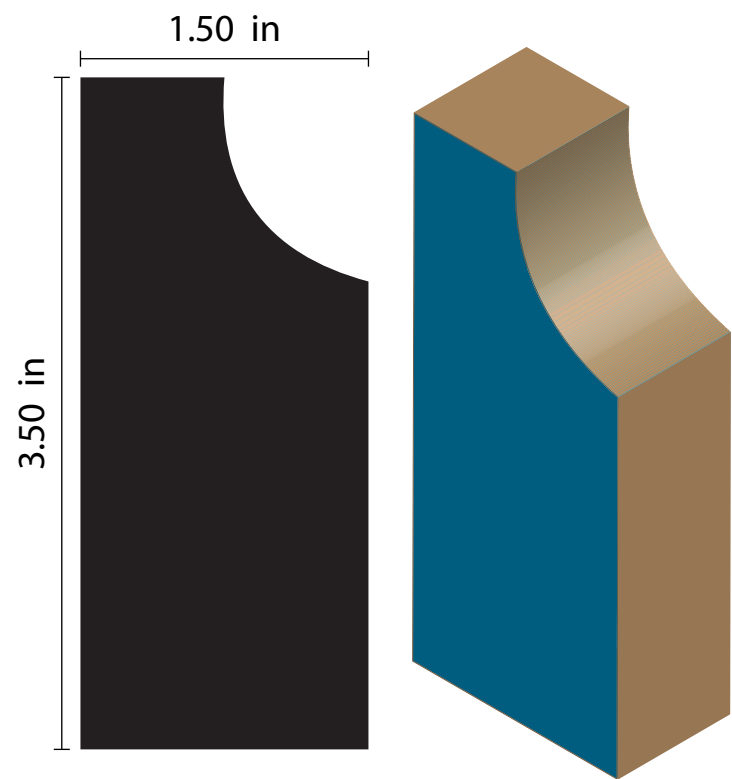

BS-084



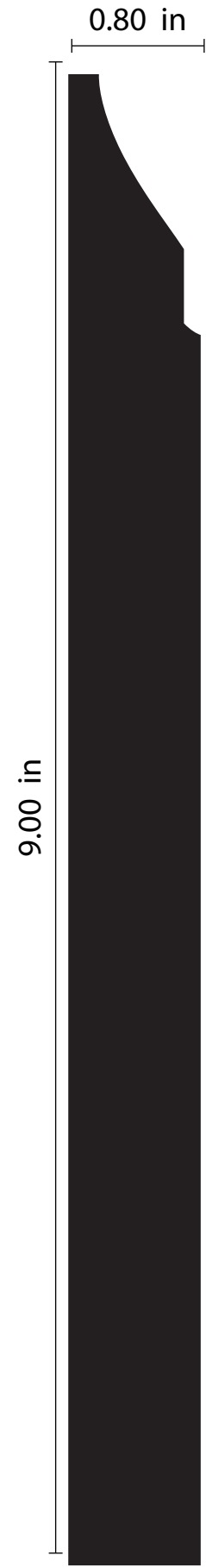

BS-088

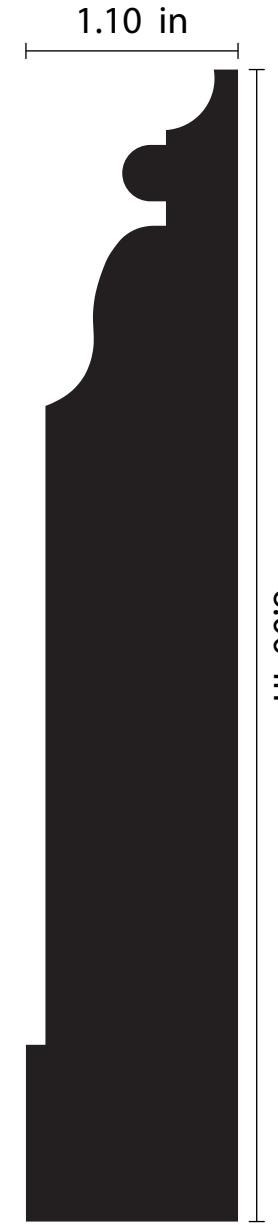
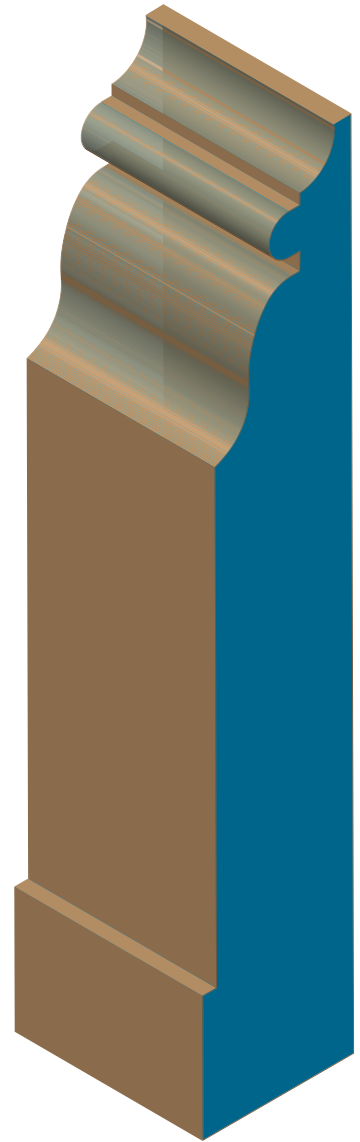
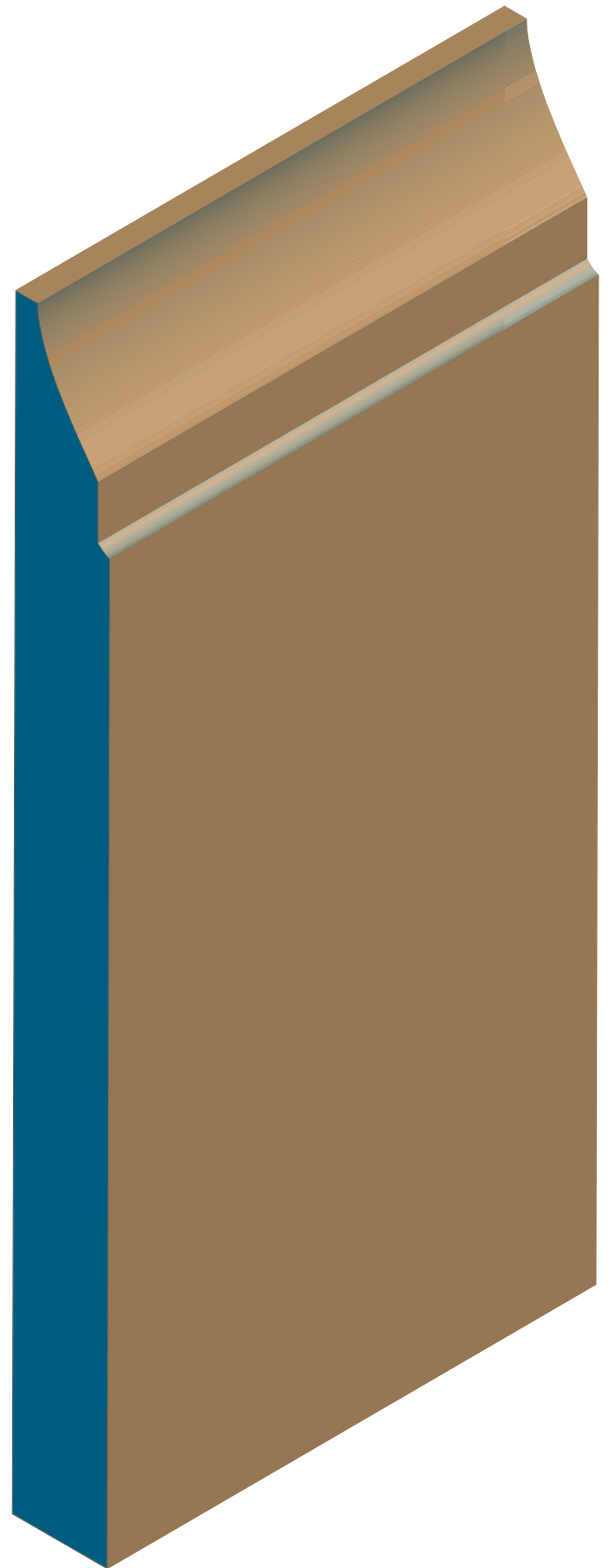

BS-089

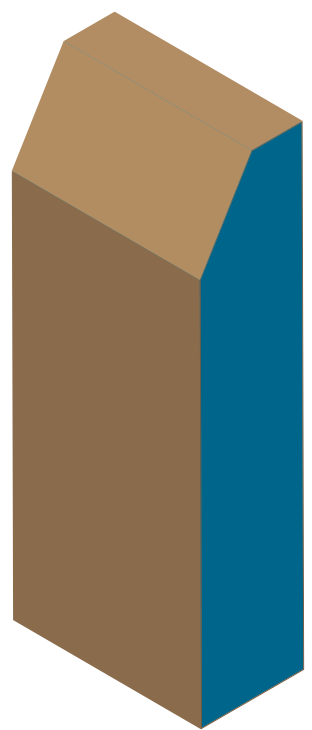
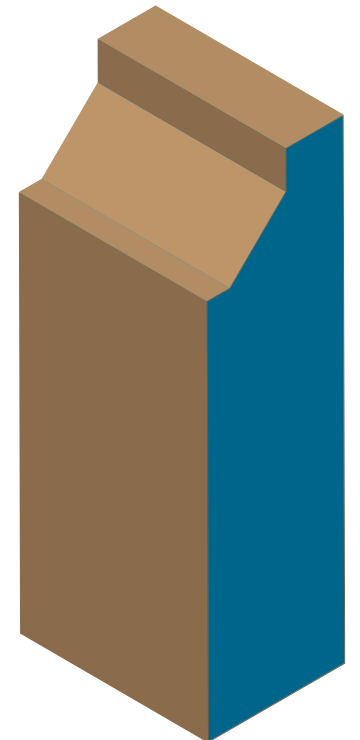

BS-091



BS-092



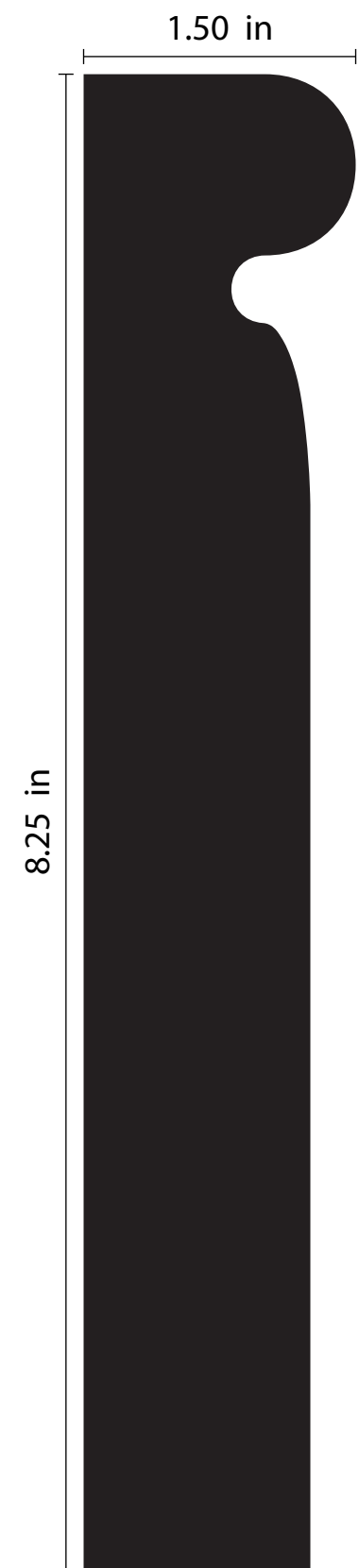

BS-090

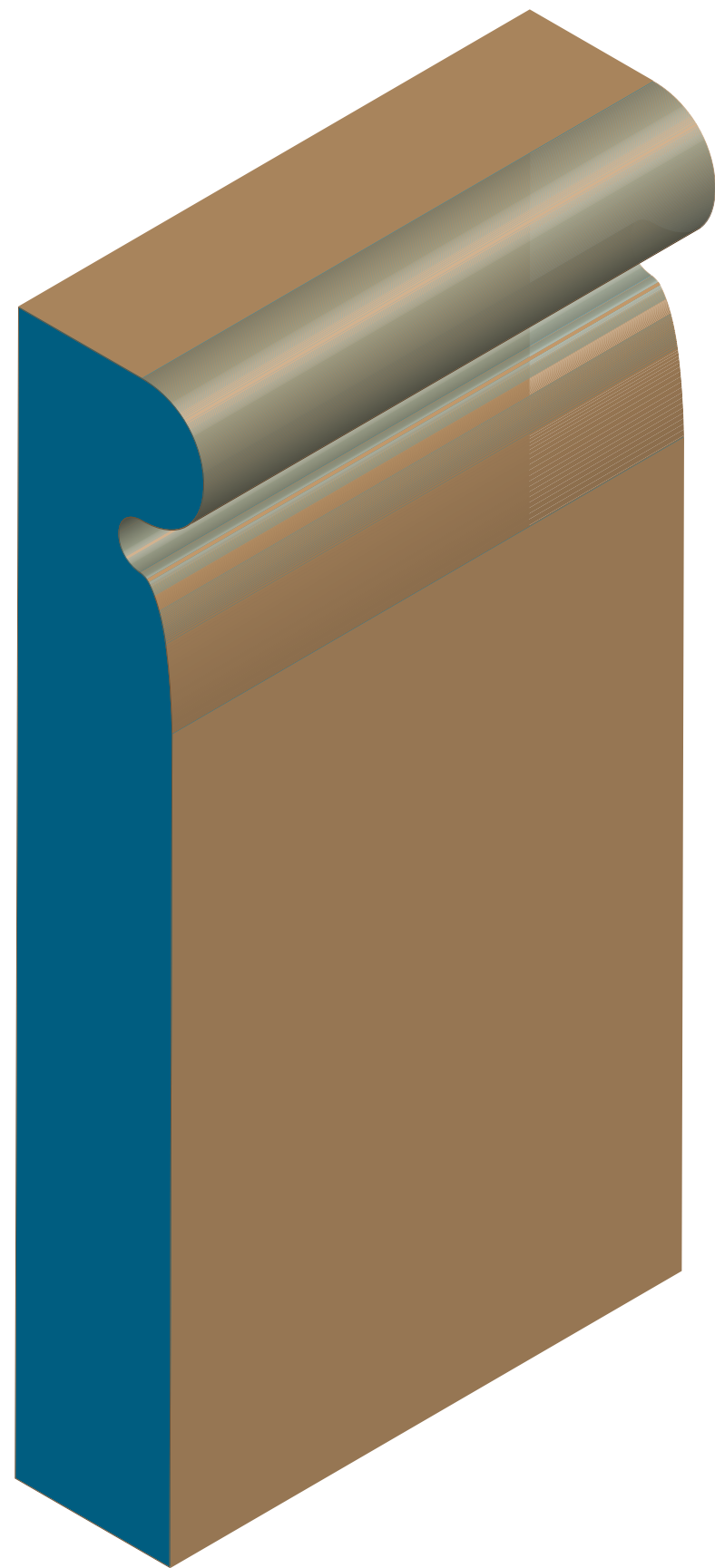

BS-094



BS-095



BS-096



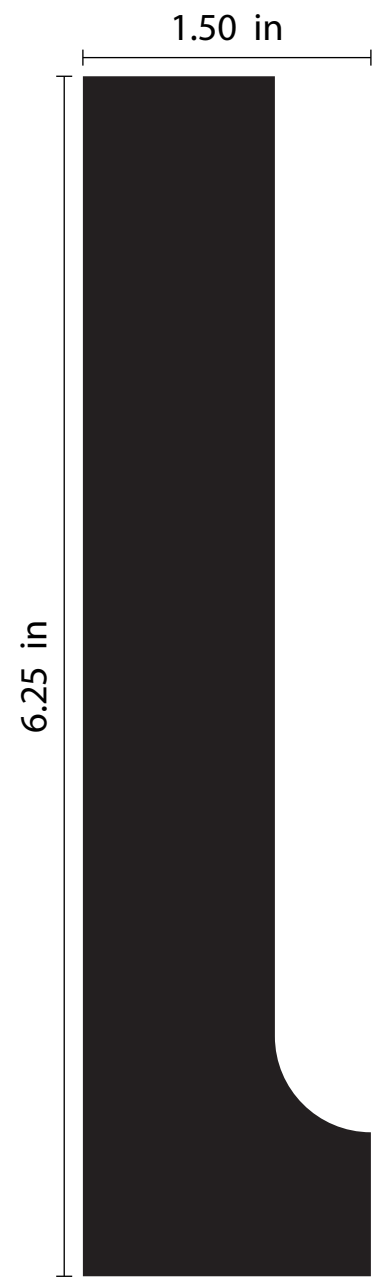

BS-097

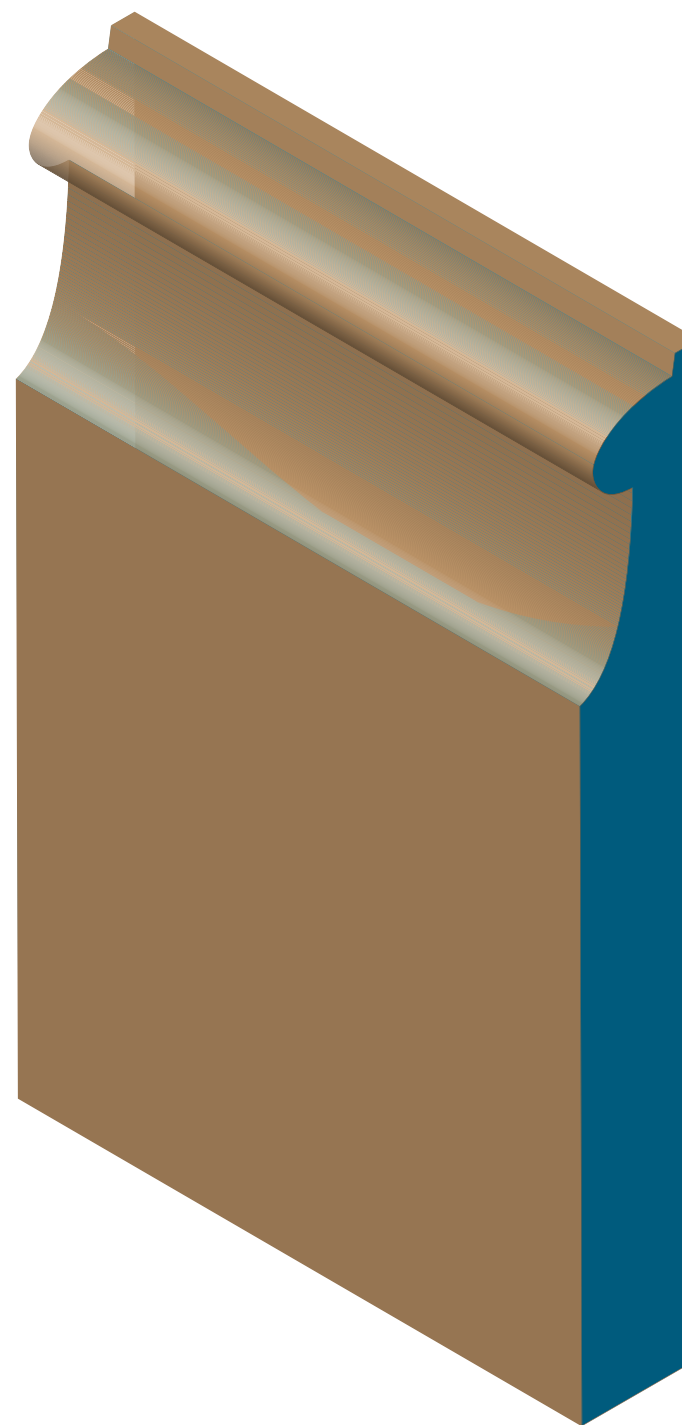
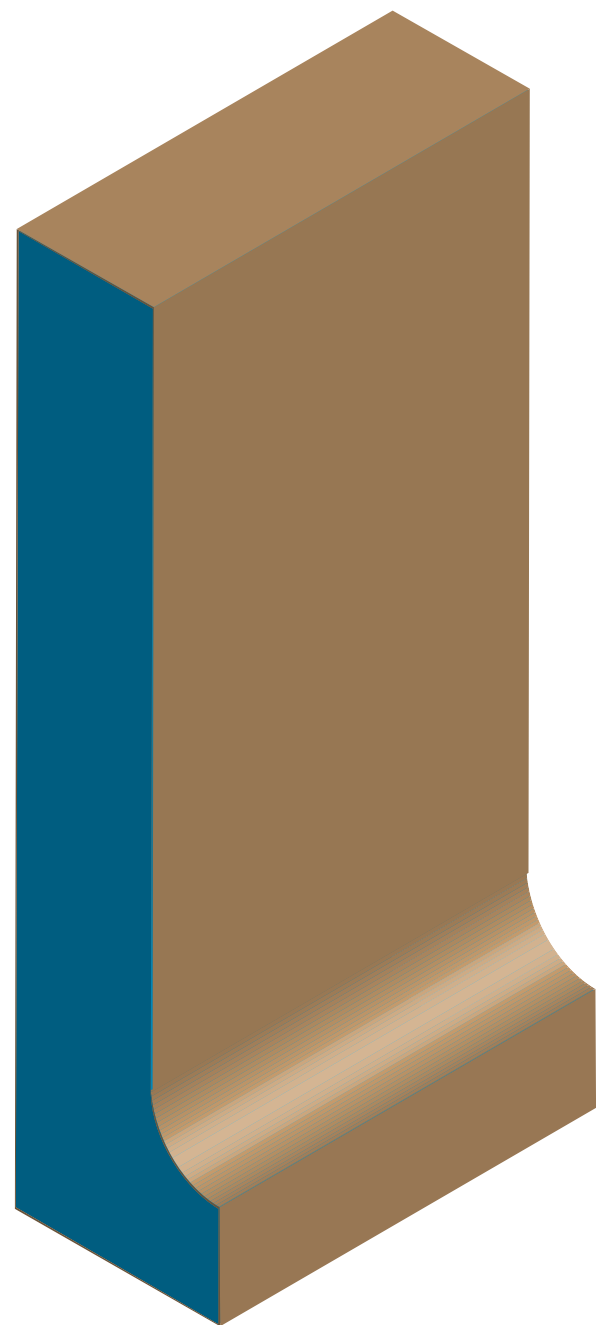

BS-098



