



GUBI

LIGHTING COLLECTION

CONTENTS

04 TYPOLOGY OVERVIEW	80 SATELLITE COLLECTION
08 BESTLITE COLLECTION	84 MULTI-LITE COLLECTION
36 COLLAR COLLECTION	94 TURBO COLLECTION
40 SEMI COLLECTION	98 RONDE COLLECTION
48 GROSSMAN COLLECTION	102 TYNELL COLLECTION
68 PEDRERA COLLECTION	114 GRAVITY COLLECTION

LIGHTING COLLECTION



‘Much like art, lighting is often the most aesthetic part of an interior. It calls for a moment of reflection. Lighting can change the atmosphere of a room, introducing a warm and nurturing ambience. Ultimately, lighting is what makes a space feel like a home.’

A handwritten signature in black ink, which appears to read 'Jacob Gubi'. The signature is fluid and cursive, written in a dark color.

Jacob Gubi
Chief Creative Director & Owner, GUBI

TABLE LAMPS



Bestlite Collection



Grossman Collection



Pedrer Collection



Multi-Lite Collection



Tynell Collection



Gravity Collection

FLOOR LAMPS



Bestlite Collection



Grossman Collection



Pedrer Collection

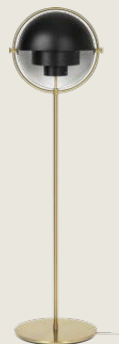

Multi-Lite Collection



Tynell Collection



Gravity Collection

PENDANTS



Bestlite Collection



Collar Collection

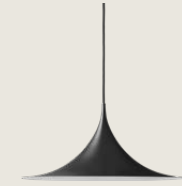

Semi Collection



Semi Collection



Pedrer Collection



Satellite Collection



Multi-Lite Collection



Turbo Collection



Ronde Collection



Tynell Collection



Gravity Collection

WALL LAMPS



Bestlite Collection



Grossman Collection

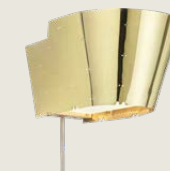

Tynell Collection



Gravity Collection



BESTLITE COLLECTION

1930

Designed by Robert Dudley Best

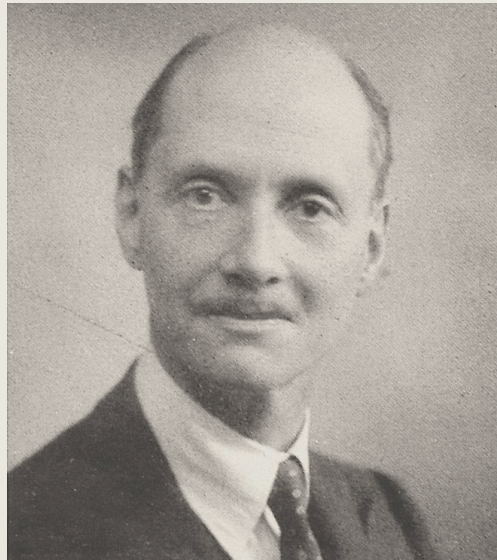

The Bestlite Collection comprises Table Lamps BL1 and BL2; Floor Lamps BL3 and BL4; Wall Lamps BL5, BL6, BL7 and BL10; and the BL9 Pendant.

A luminary in lighting

The Bestlite Collection, designed by Robert Dudley Best, has been in continuous production since 1930. Developed at the end of the revolutionary Bauhaus movement, the collection's utilitarian forms and clean lines are strongly representative of the period. The Bestlite lamp was first adopted by garages and the Royal Air Force engineering departments due to its functionality. A feature in the Architects' Journal calling the Bestlite the first evidence of Bauhaus in Britain brought the lamp to the attention of the design-conscious public. Retail demand for the Bestlite lamps soon followed and, when

Winston Churchill chose the BL1 Table Lamp for his desk, Bestlite's iconic status was secured. The Bestlite Collection is held in the permanent collections of both the Victoria & Albert Museum and the Design Museum in London. Loved by architects, designers and design aficionados throughout its long history, Bestlite has become a contemporary classic. The Bestlite Collection is one of the most comprehensive and hardworking lighting collections of all time, including 10 different table lamps, floor lamps, wall lamps and pendant lamps, all of which can be adjusted in multiple directions.





BL1 Table Lamp - Ø16, Brass base

By Robert Dudley Best, 1930
Bone China



BL1 Table Lamp - Ø16

Designed by Robert Dudley Best, 1930

Colors Black brass base: black brass, bone china and classic white semi matt shades. Brass base: shiny brass, bone china, grey semi matt, soft black semi matt and soft white semi matt shades. Chrome base: chrome, black semi matt, bone china and soft white semi matt shades. Regional exceptions may apply.

Switch & Cord Switch on 200 cm textile cord. Black brass base: black textile cord. Brass base: cord color matches shade, or is golden with bone china shade. Chrome base: cord color is black with bone china, black and chrome shades or white with soft white shade.

Socket EU: E14, US: E12.

Recommended Bulb 470 Lumen (~ 40W incandescent, ~ 28W halogen, ~ 4-6W LED).

Approvals CE, (C)UL.

Other The height is adjustable and the arm can be tilted 90° from horizontal to vertical, the shade can be tilted 45° and rotated 270°.

Dimensions (cm)

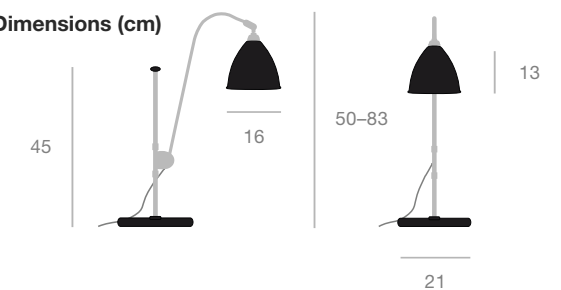



BL2 Table Lamp - Ø16, Brass base (Bone China) By Robert Dudley Best, 1930



BL2 Table Lamp - Ø16

Designed by Robert Dudley Best, 1930

Colors Brass base: shiny brass, bone china, grey semi matt, soft black semi matt and soft white semi matt shades. Black brass base: black brass, bone china and classic white semi matt shades. Chrome base: chrome, black semi matt, bone china ivory white and soft white semi matt shades. Regional exceptions may apply.

Switch & Cord Switch on 200 cm textile cord. Black brass base: black textile cord. Brass base: cord color matches shade, or is golden with bone china shade. Chrome base: cord color is black with bone china, black and chrome shades or white with soft white shade.

Socket EU: E14, US: E12.

Recommended Bulb 470 Lumen (~ 40W incandescent, ~ 28W halogen, ~ 4-6W LED).

Approvals CE, (C)UL.

Other The arm can be tilted 180° from horizontal to vertical, the shade can be tilted 45° and rotated 270°.

Dimensions (cm)

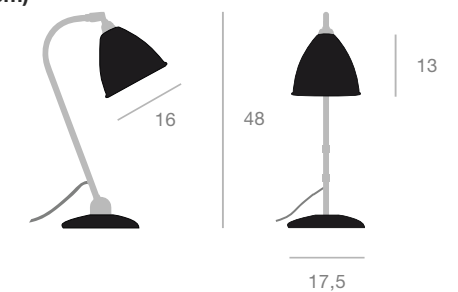

BL3 Floor Lamp - Ø16 (S), Chrome base

*By Robert Dudley Best, 1930
Black Semi Matt*



BL3 Floor Lamp - Ø16 (S)

Designed by Robert Dudley Best, 1930

Colors Chrome base: black semi matt, chrome, bone china and soft white semi matt shades. Black brass base: black brass and bone china shades. Brass base: bone china shade. Regional exceptions may apply.

Switch & Cord Switch on 200 cm textile cord. Black brass base: black textile cord. Brass base: golden textile cord. Chrome base: textile cord color is black with bone china, black and chrome shades or white with soft white shade.

Socket EU: E14, US: E12.

Recommended Bulb 470 Lumen (~ 40W incandescent, ~ 28W halogen, ~ 4-6W LED).

Approvals CE, (C)UL.

Other The height is adjustable and the arm can be tilted 90° from horizontal to vertical, the shade can be tilted 45° and rotated 270°.

Dimensions (cm)

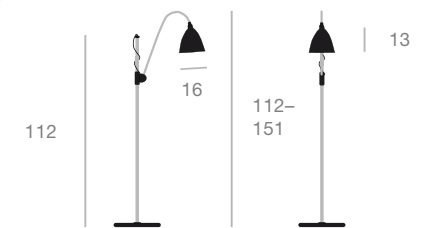



BL3 Floor Lamp - Ø21 (M), Chrome base (Black Semi Matt) By Robert Dudley Best, 1930



BL3 Floor Lamp - Ø21 (M)

Designed by Robert Dudley Best, 1930

Colors Black brass base: classic white semi matt and black brass shades. Brass base: shiny brass, grey semi matt, soft black semi matt and soft white semi matt shades. Chrome base: chrome, black semi matt, and soft white semi matt shades. Regional exceptions may apply.

Switch & Cord Switch on 200 cm textile cord. Black brass base: black cord. Brass base: cord color matches shade. Chrome base: cord color is black with black and chrome shades or white with soft white shade.

Socket EU: E14, US: E12.

Recommended Bulb 470 Lumen (~ 40W incandescent, ~ 28W halogen, ~ 4-6W LED).

Approvals CE, (C)UL.

Other The height is adjustable and the arm can be tilted 90° from horizontal to vertical, the shade can be tilted 45° and rotated 270°.

Dimensions (cm)

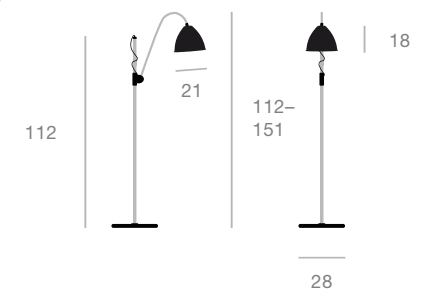



BL4 Floor Lamp - Ø21 (M), Chrome base
By Robert Dudley Best, 1930
Soft White Semi Matt



BL4 Floor Lamp - Ø21 (M)

Designed by Robert Dudley Best, 1930

Colors Brass base: shiny brass, grey semi matt, soft black semi matt and soft white semi matt shades. Black brass base: black brass and classic white semi matt shades. Chrome base: black semi matt and soft white semi matt shades. Regional exceptions may apply.

Switch & Cord Switch on 200 cm textile cord. Black brass base: black cord. Brass base: cord color matches shade. Chrome base: cord color is black with black shade or white with soft white shade.

Socket EU: E14, US: E12.

Recommended Bulb 470 Lumen (~ 40W incandescent, ~ 28W halogen, ~ 4-6W LED).

Approvals CE, (C)UL.

Other The arm has an adjustable weight for balancing and can be tilted 90° from horizontal to vertical. The shade can be tilted 45° and rotated 270°.

Dimensions (cm)

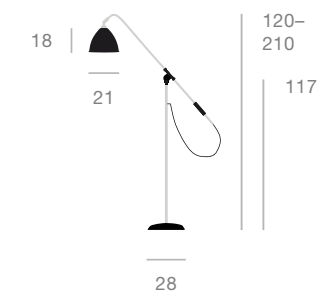

BL5 Wall Lamp - Ø16, Black Brass base
By Robert Dudley Best, 1930
Classic White Semi Matt



BL5 Wall Lamp - Ø16

Designed by Robert Dudley Best, 1930

Colors Chrome base: black semi matt, chrome, bone china and soft white semi matt shades. Black brass base: black brass, bone china and classic white semi matt shades. Brass base: shiny brass, bone china, grey semi matt, soft black semi matt and soft white semi matt shades. Regional exceptions may apply.

Switch & Cord Switch on 200 cm textile cord. Black brass base: black cord. Brass base: cord color matches shade, or is golden with bone china shade. Chrome base: cord color is black with bone china, black and chrome shades or white with soft white shade.

Socket EU: E14, US: E12.

Mounting Wall mounted with optional hardwiring.

Recommended Bulb 470 Lumen (~ 40W incandescent, ~ 28W halogen, ~ 4-6W LED).

Approvals CE, (C)UL.

Other The height is adjustable and the arm can be tilted 90° from horizontal to vertical, the shade can be tilted 45° and rotated 270°.

Dimensions (cm)

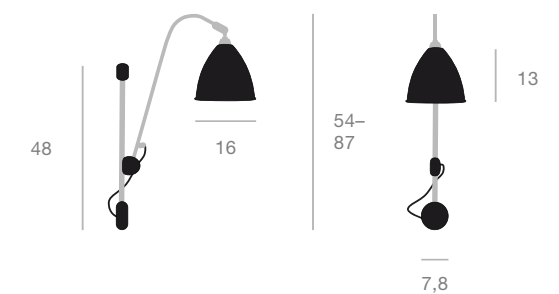



BL6 Wall Lamp - Ø16, Chrome base (Black Semi Matt) By Robert Dudley Best, 1930

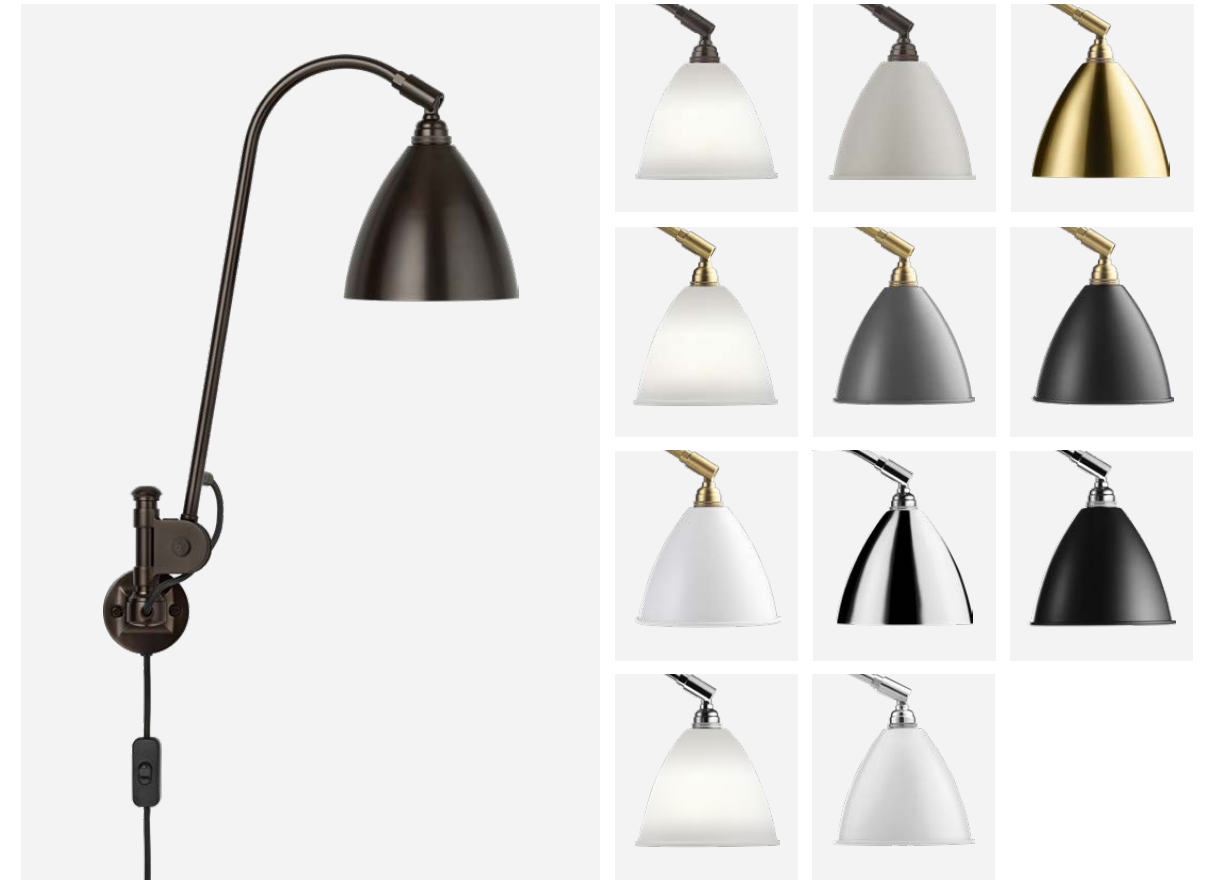

BL6 Wall Lamp - Ø16

Designed by Robert Dudley Best, 1930

Colors Black brass base: black brass, bone china and classic white semi matt shades. Brass base: shiny brass, bone china, grey semi matt, soft black semi matt and soft white semi matt shades. Chrome base: chrome, black semi matt, bone china and soft white semi matt shades. Regional exceptions may apply.

Switch & Cord Switch on 200 cm textile cord. Black brass base: black cord. Brass base: cord color matches shade, or is golden with bone china shade. Chrome base: cord color is black with bone china, black and chrome shades or white with soft white shade.

Socket EU: E14, US: E12.

Mounting Wall mounted with optional hardwiring.

Recommended Bulb 470 Lumen (~ 40W incandescent, ~ 28W halogen, ~ 4-6W LED).

Approvals CE, (C)UL.

Other The arm rotates and can be tilted 90° from horizontal to vertical. The shade can be tilted 45° and rotated 270°.

Dimensions (cm)

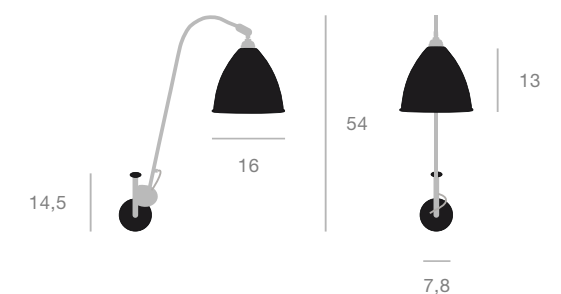

BL7 Wall Lamp - Ø16, Brass base
By Robert Dudley Best, 1930
Bone China



BL7 Wall Lamp - Ø16

Designed by Robert Dudley Best, 1930

Colors Brass base: bone china, shiny brass, grey semi matt, soft black semi matt, soft white semi matt. Black brass base: black brass bone china and classic white semi matt shades. Chrome base: chrome, black semi matt, bone china, soft white semi matt shades. Regional exceptions may apply.

Switch & Cord Switch on back plate. 200 cm textile cord. Black brass base: black cord. Brass base: cord color matches shade, or is golden with bone china shade. Chrome base: cord color is black with bone china, black and chrome shades or white with soft white shade.

Socket EU: E14, US: E12.

Mounting Wall mounted with optional hardwiring.

Recommended Bulb 470 Lumen (~ 40W incandescent, ~ 28W halogen, ~ 4-6W LED).

Approvals CE, (C)UL.

Other The shade can be tilted 45° and rotated 270°.

Dimensions (cm)

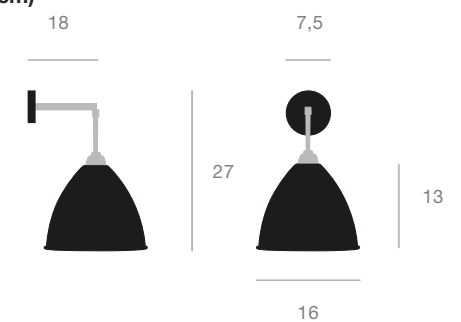



BL9 Pendant - Ø16, Chrome base (Black Semi Matt) By Robert Dudley Best, 1930

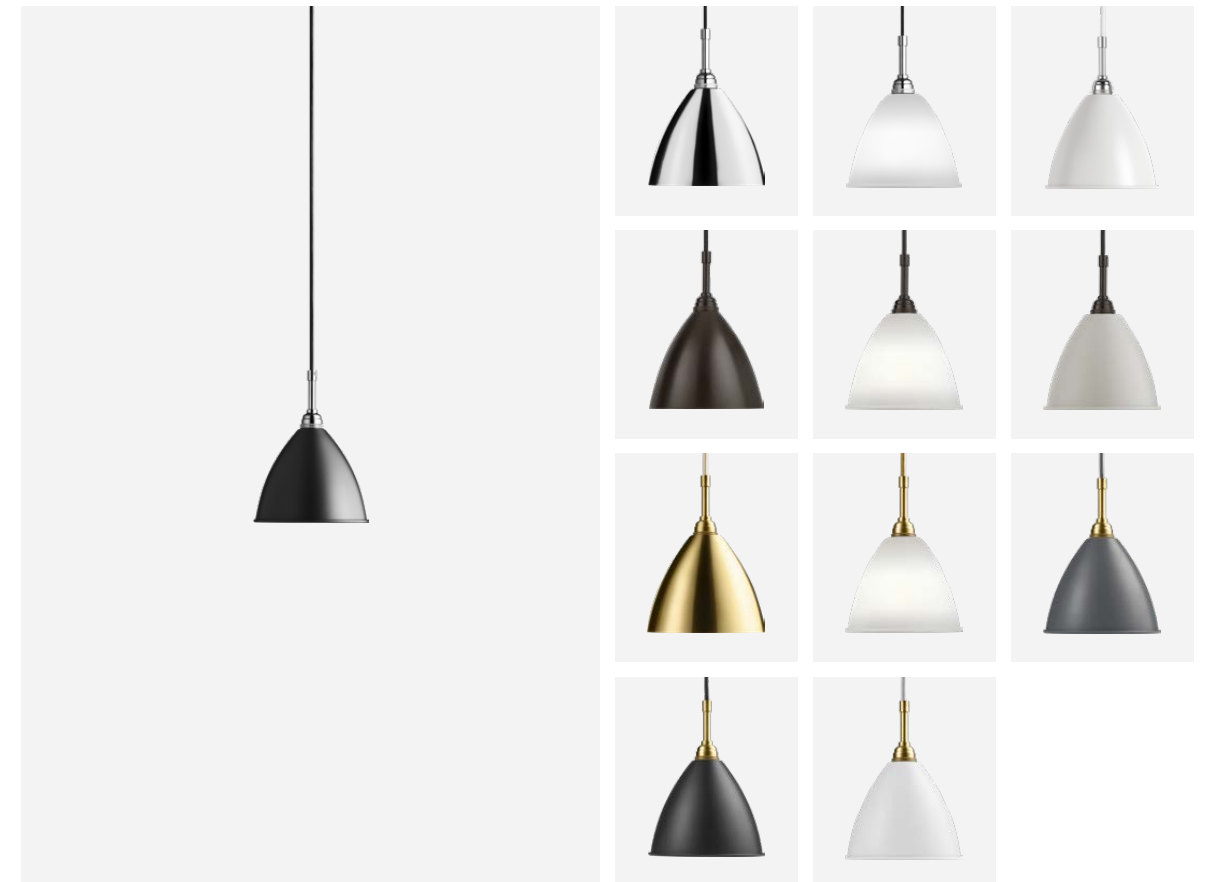

BL9 Pendant - Ø16 (S)

Designed by Robert Dudley Best, 1930

Colors Chrome base: black semi matt, chrome, bone china and soft white semi matt shades. Black brass base: black brass, bone china and classic white semi matt shades. Brass base: shiny brass, bone china, grey semi matt, soft black semi matt and soft white semi matt shades. Regional exceptions may apply.

Switch & Cord Hard-wired 200 cm textile cord. Black brass base: black cord. Brass base: cord color matches shade, or is golden with bone china shade. Chrome base: white cord with soft white shade, black with other shades.

Socket EU: E14, US: E12.

Recommended Bulb 470 Lumen (~ 40W incandescent, ~ 28W halogen, ~ 4-6W LED).

Approvals CE, (C)UL.

Other Ceiling canopy included.

Dimensions (cm)





BL9 Pendant - Ø21 (M), Chrome base
By Robert Dudley Best, 1930
Bone China

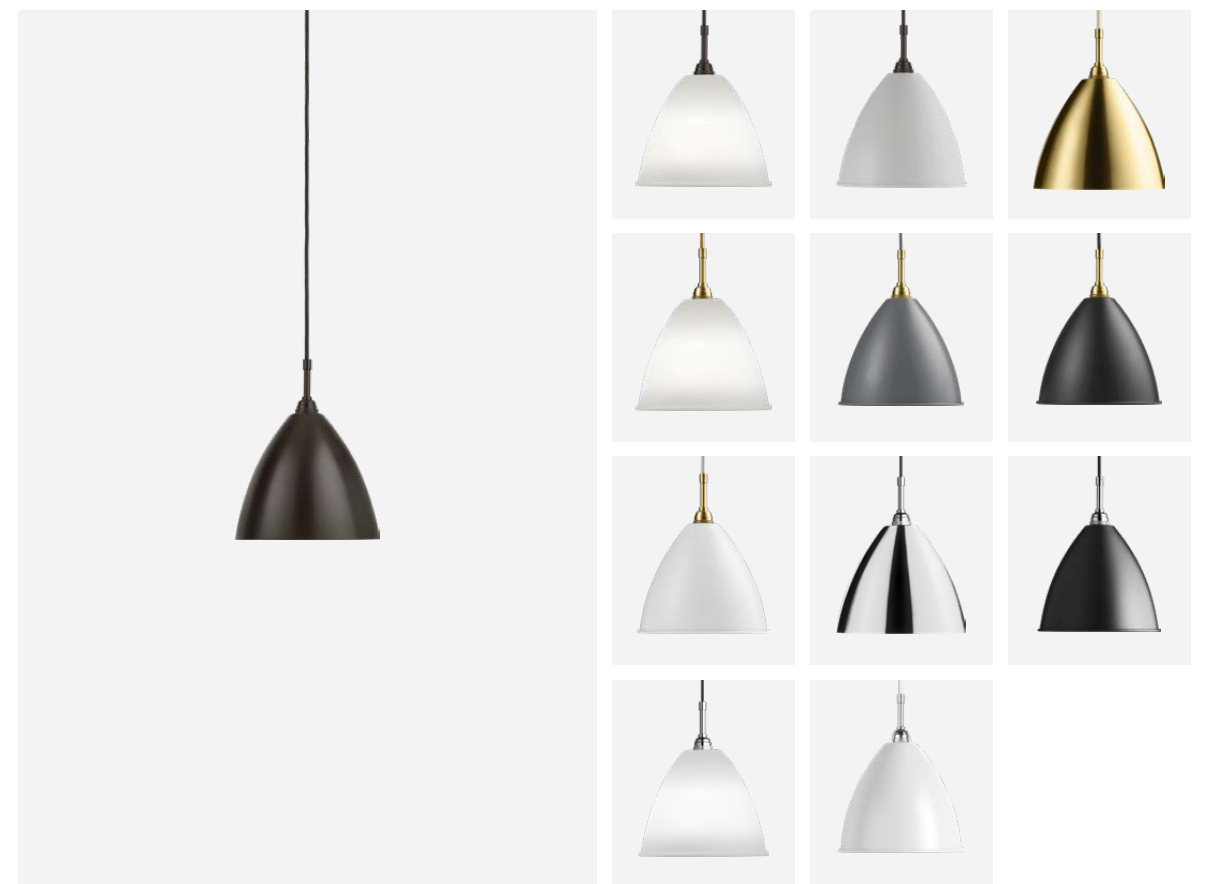

BL9 Pendant - Ø21 (M)

Designed by Robert Dudley Best, 1930

Colors Black brass base: black brass, bone china and classic white semi matt shades. Brass base: shiny brass, bone china, grey semi matt, soft black semi matt and soft white semi matt shades. Chrome base: chrome, black semi matt, bone china and soft white semi matt shades. Regional exceptions may apply.

Switch & Cord Hard-wired 200 cm textile cord. Black brass base: black cord. Brass base: cord color matches shade, or is golden with bone china shade. Chrome base: white cord with soft white shade, black with other shades.

Socket EU: E14, US: E12.

Recommended Bulb 470 Lumen (~ 40W incandescent, ~ 28W halogen, ~ 4-6W LED).

Approvals CE, (C)UL.

Other Ceiling canopy included.

Dimensions (cm)





BL9 Table Lamp - Ø40 (L), Chrome base (Soft White Semi Matt) By Robert Dudley Best, 1930



BL9 Pendant - Ø40 (L)

Designed by Robert Dudley Best, 1930

Colors Brass base: soft black semi matt, grey semi matt and soft white semi matt shades. Chrome base: black semi matt and soft white semi matt shades. Regional exceptions may apply.

Switch & Cord Hard-wired 200 cm textile cord. Brass base: white cord with soft white shade, black with other shades. Chrome base: cord matches shade.

Socket EU: E27, US: E26.

Recommended Bulb 810 Lumen ($\leq 60W$ incandescent, $\leq 46W$ halogen, $\sim 8-10W$ LED Dimmable).

Approvals CE, (C)UL.

Other Ceiling canopy included.

Dimensions (cm)

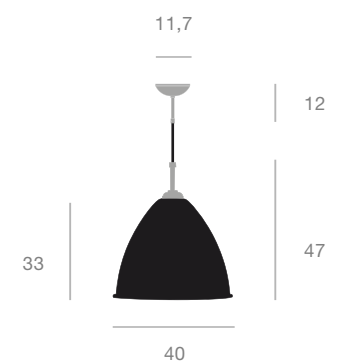

BL9 Table Lamp - Ø60 (XL), Chrome base*By Robert Dudley Best, 1930**Black Semi Matt***BL9 Pendant - Ø60 (XL)***Designed by Robert Dudley Best, 1930*

Colors Chrome base: black semi matt and soft white semi matt shades. Brass base: soft black semi matt, grey semi matt and soft white semi matt shades. Regional exceptions may apply.

Switch & Cord Hard-wired 200 cm textile cord. Brass base: white cord with soft white shade, black with other shades. Chrome base: cord matches shade.

Socket EU: E27, US: E26.

Recommended Bulb 1530 Lumen (~ 100W incandescent, ~ 70-80W halogen, ~ 13-16W LED).

Approvals CE, (C)UL.

Other Ceiling canopy included.

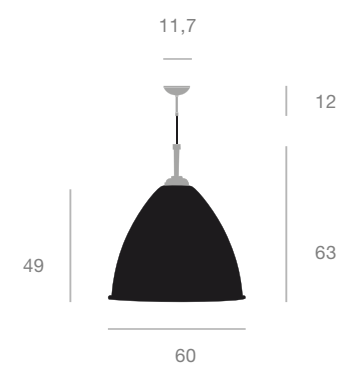
Dimensions (cm)



BL10 Wall Lamp - Ø16, Chrome base (Black Semi Matt) By Robert Dudley Best, 1930



BL10 Wall Lamp - Ø16

Designed by Robert Dudley Best, 1930

Colors Chrome base: black semi matt and soft white semi matt shades. Regional exceptions may apply.

Switch & Cord Hard-wired 230 cm textile cord, color matches shade.

Socket EU: E14, US: E12.

Recommended Bulb 470 Lumen (~ 40W incandescent, ~ 28W halogen, ~ 4-6W LED).

Approvals CE, (C)UL.

Other The arm of the lamp can be tilted and rotated 180° horizontally and vertically. The shade can be tilted 45°.

Dimensions (cm)

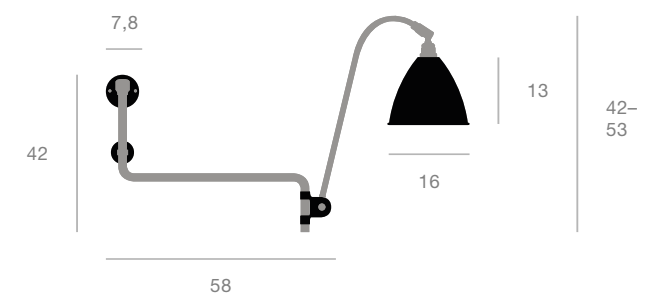

COLLAR COLLECTION

2015

Designed by Sebastian Herkner



The Collar Collection comprises the Collar Pendant in two sizes.

A modern classic is born

The Collar Collection by German designer Sebastian Herkner is a series of pendant lights in which contemporary design meets traditional craft techniques, giving each lamp a distinctive aesthetic. Its strong character is achieved by the combination of rounded mouth-blown glass, with a matte surface, and a steel

'collar' reflector. Together, they gently diffuse a warm light, creating a convivial atmosphere. The pendant makes a striking feature hung alone over a table, and, by mixing colors and large and small Collar Pendants, the collection also offers an opportunity to create personalized and playful installations.





Collar Pendant - Ø30 & Ø42 (Carbone Semi Matt, Soft Fog Matt) By Sebastian Herkner, 2018



Collar Pendant - Ø30

Designed by Sebastian Herkner, 2018

Colors Carbone semi matt, soft fog matt, stone grey soft matt, taupe soft matt, terracotta light matt. Regional exceptions may apply.

Switch & Cord Hard-wired 400 cm black textile cord.

Socket EU: E27, US: E26.

Recommended Bulb 470 Lumen (~ 40W incandescent, ~ 28W halogen, ~ 4-6W LED).

Approvals CE, (C)UL.

Other Ceiling canopy included.

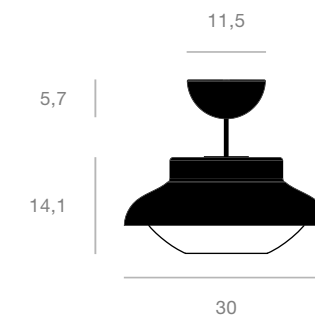

Collar Pendant - Ø42

Designed by Sebastian Herkner, 2018

Colors Carbone semi matt, soft fog matt, stone grey soft matt, taupe soft matt, terracotta light matt. Regional exceptions may apply.

Switch & Cord Hard-wired 400 cm black textile cord.

Socket EU: E27, US: E26.

Recommended Bulb 470 Lumen (~ 40W incandescent, ~ 28W halogen, ~ 4-6W LED).

Approvals CE, (C)UL.

Other Ceiling canopy included.

Dimensions (cm)

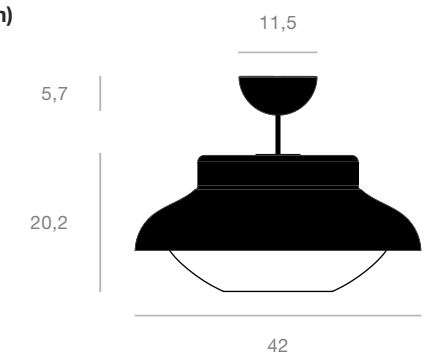

SEMI COLLECTION

1968

Designed by Claus Bonderup & Torsten Thorup



The Semi Collection comprises the Semi Pendant in three sizes.

The icon of balanced proportions

The Semi Pendant's silhouette was conceived by placing two crescent shapes back to back. The shade's distinctive splayed cone is made from enameled metal, making it ideal over a dining table or kitchen work surface. With its lightness of form, unique timeless design and range of colors and sizes, the Semi Pendant is extremely versatile and well suited to both private and public spaces. The Semi Pendant was designed in 1968 and came out of the dynamic creative partnership between Claus Bonderup and

Torsten Thorup. Reacting against the soft organic forms that dominated the so-called 'cozy era' in Denmark at the time, Bonderup and Thorup wanted to create a lamp that incorporated sharp, clean lines and a geometric shape. They submitted the Semi Pendant for a competition at the Royal Danish Academy of Fine Arts, School of Architecture and won first prize. In the 1980s, the pendant became Denmark's best-selling design and gained worldwide recognition.

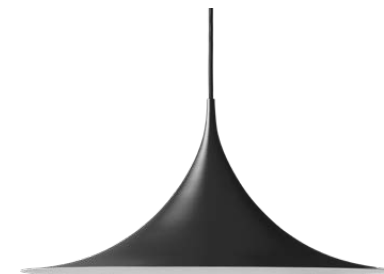
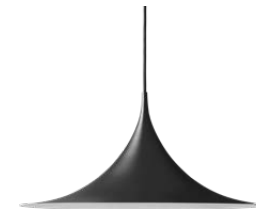
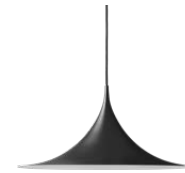



Semi Pendant Ø30 (White Semi Matt) By Bonderup & Thorup, 1968

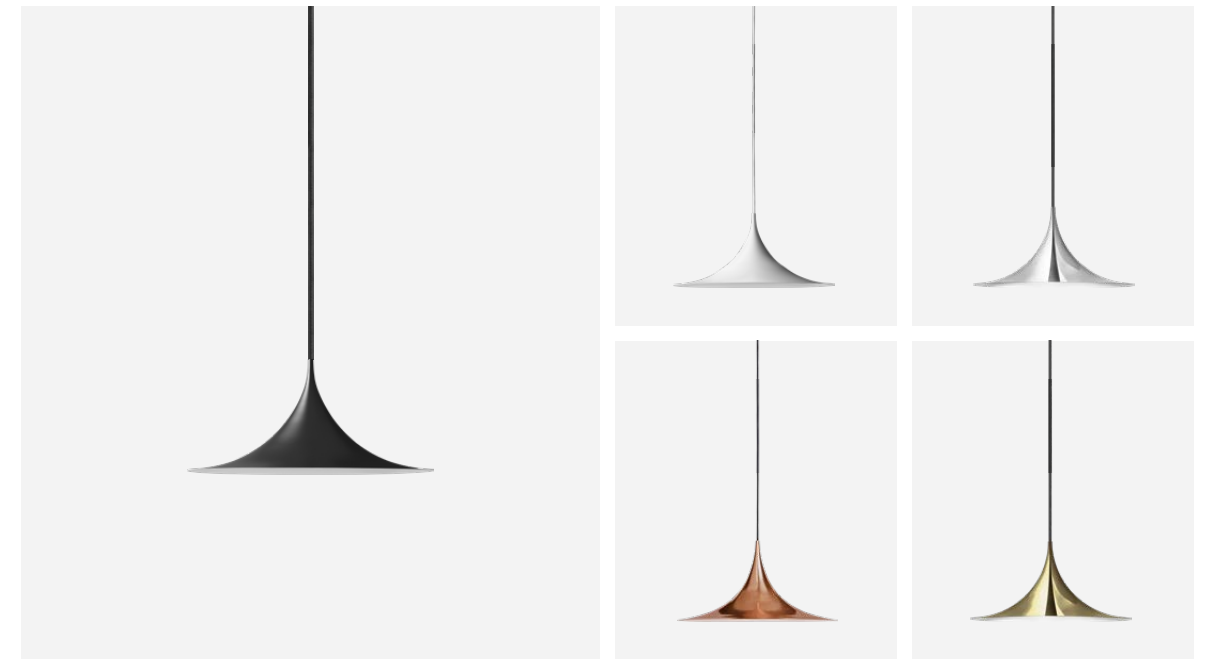

Semi Pendant - Ø30

Designed by Bonderup & Thorup, 1968

Colors Painted: black semi matt and white semi matt shades.
Metal: chrome, copper and polished brass shades. Regional exceptions may apply.

Switch & Cord Hard-wired 400 cm white textile cord with white shade, black with other shades.

Socket EU: E14, US: E12.

Recommended Bulb 470 Lumen (~ 40W incandescent, ~ 28W halogen, ~ 4-6W LED).

Approvals CE, (C)UL.

Other Ceiling canopy included.

Dimensions Metal (cm) Dimensions Painted (cm)

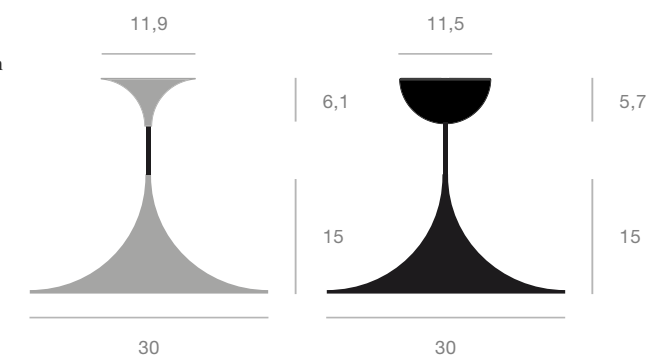

Semi Pendant Ø47
 By Bonderup & Thorup, 1968
 Polished Brass

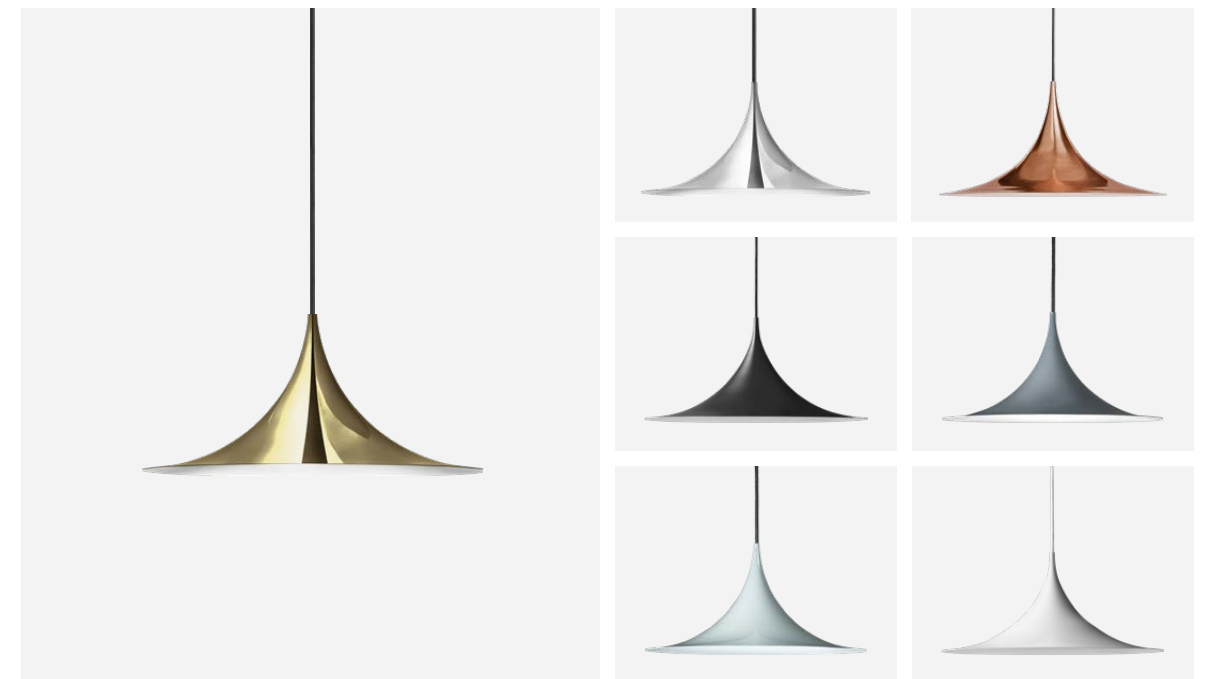

Semi Pendant - Ø47

Designed by Bonderup & Thorup, 1968

Colors Metal: polished brass, chrome and copper and shades.
 Painted: black semi matt, anthracite grey glossy, dusty blue glossy
 and white semi matt shades. Regional exceptions may apply.

Switch & Cord Hard-wired 400 cm white textile cord with
 white shade, black with other shades.

Socket EU: E27, US: E26.

Recommended Bulb 810 Lumen (≤ 60W incandescent,
 ≤ 46W halogen, ~ 8-10W LED Dimmable).

Approvals CE, (C)UL.

Other Ceiling canopy included.

Dimensions Metal (cm) Dimensions Painted (cm)

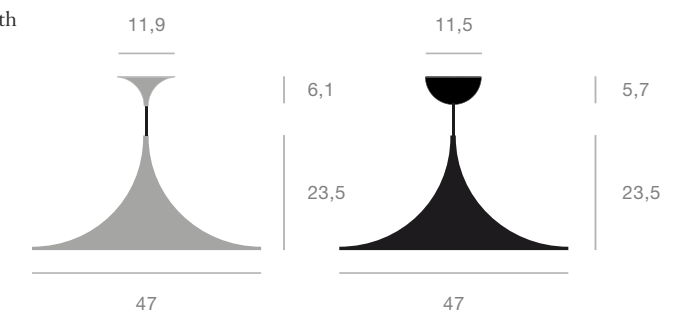



Semi Pendant Ø60 (Black Semi Matt) By Bonderup & Thorup, 1968



Semi Pendant - Ø60

Designed by Bonderup & Thorup, 1968

Colors Painted: black semi matt and white semi matt shades. Metal: chrome, copper and polished brass shades. Regional exceptions may apply.

Switch & Cord Hard-wired 400 cm white textile cord with white shade, black with other shades.

Socket EU: E27, US: E26.

Recommended Bulb 810 Lumen ($\leq 60W$ incandescent, $\leq 46W$ halogen, $\sim 8-10W$ LED Dimmable).

Approvals CE, (C)UL.

Other Ceiling canopy included.

Dimensions Metal (cm) Dimensions Painted (cm)

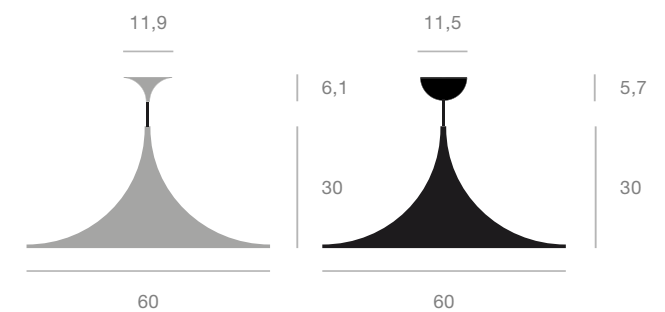

GROSSMAN COLLECTION

1945–1950

Designed by Greta M. Grossman



The Grossman Collection comprises the Gräshoppa Floor Lamp, Table Lamp and Pendant; the Cobra Floor Lamp, Table Lamp and Wall Lamp; the G-10 Floor Lamp and Pendant; and the B-4 Table Lamp.

Pioneering and playful organic modernism

What makes Greta M. Grossman's designs interesting is their sophisticated, yet playful aesthetic; the pieces exhibit an eccentricity of form that is at once organic and classically modernist. Her most well-known products are the Gräshoppa and Cobra lamps. The unmistakable silhouette of the 1947 Gräshoppa Lamp resembles its namesake, the tubular steel tripod base standing at an angle to give the impression of a grasshopper clinging to a blade of

grass. The classic 1950 Cobra Lamp was given its moniker because of its oval shade, reminiscent of a cobra's head. Also designed in 1950, the G-10 Collection is characterized by its distinctive form, tactile surface and satin opal glass interior, all of which contribute to the lamps' bold aesthetic and warm diffused light. The 1945 B-4 Table Lamp, features colorful geometric visors that can be moved to softly diffuse light in any direction.





G-10 Floor Lamp
By Greta M. Grossman, 1950
Black Rough

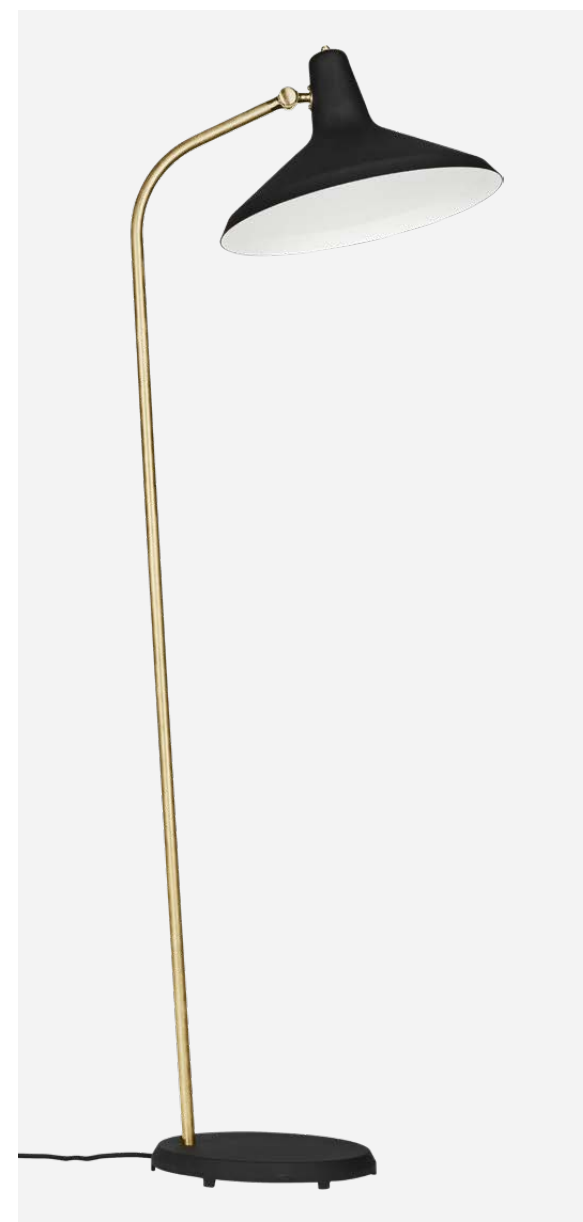

G-10 Floor Lamp

Designed by Greta M. Grossman, 1950

Colors Black rough.

Switch & Cord Switch on 200 cm black textile cord.

Socket EU: E27, US: E26.

Recommended Bulb 470 Lumen (~ 40W incandescent, ~ 28W halogen, ~ 4-6W LED).

Approvals CE, (C)UL.

Other The shade can be tilted.

Dimensions (cm)



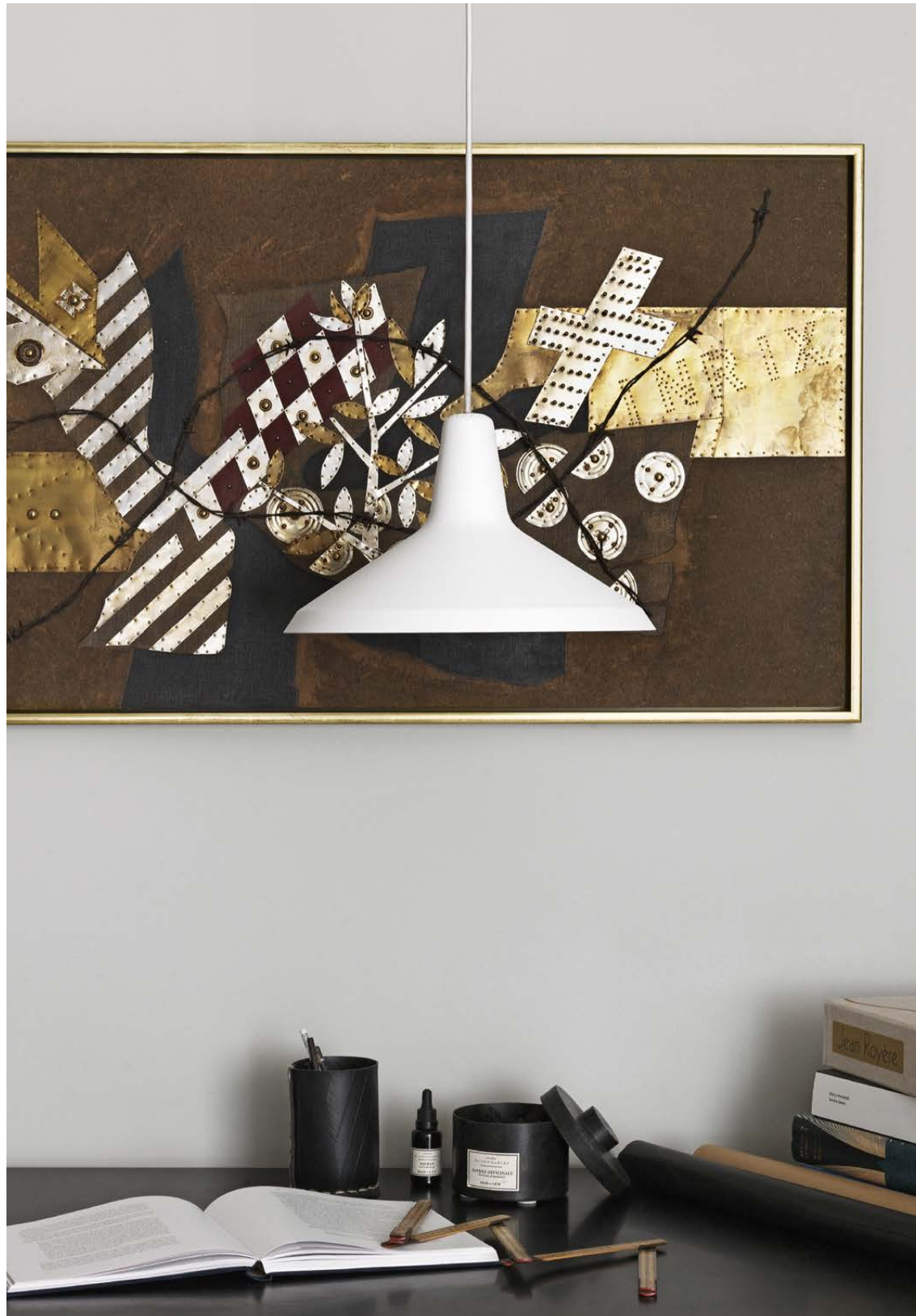

G-10 Pendant (*Pure White Rough*) By Greta M. Grossman, 1950



G-10 Pendant

Designed by Greta M. Grossman, 1950

Colors Black rough, white rough.
Regional exceptions may apply.

Switch & Cord Hard-wired 400 cm textile cord, color matches shade.

Socket EU: E27, US: E26.

Recommended Bulb 470 Lumen (~ 40W incandescent, ~ 28W halogen, ~ 4-6W LED).

Approvals CE, (C)UL.

Other Ceiling canopy included.

Dimensions (cm)

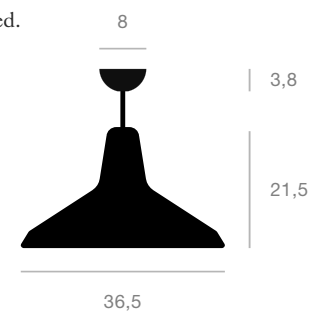



Gräshoppa Floor Lamp
By Greta M. Grossman, 1947
Anthracite Grey Semi Matt



Gräshoppa Floor Lamp

Designed by Greta M. Grossman, 1947

Colors Andorra red semi matt, anthracite grey semi matt, aspen yellow semi matt, black semi matt, dusty blue semi matt, oyster white semi matt, vintage red semi matt, warm grey semi matt, white semi matt. Regional exceptions may apply.

Dimensions (cm)

Switch & Cord Switch on 230 cm white textile cord with white shade, black on others.

Socket EU: E14, US: E12.

Recommended Bulb 470 Lumen (~ 40W incandescent, ~ 28W halogen, ~ 4-6W LED).

Approvals CE, (C)UL.

Other The shade can be tilted horizontally and vertically.

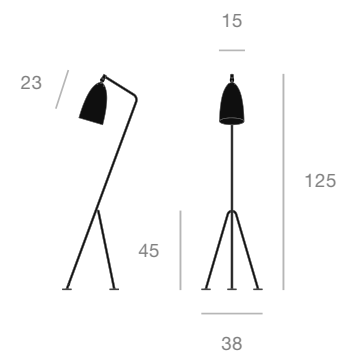



Gräshoppa Pendant
By Greta M. Grossman, 1947
Black Semi Matt



Gräshoppa Pendant

Designed by Greta M. Grossman, 1947

Colors Anthracite grey semi matt, andorra red semi matt, black semi matt, dusty blue semi matt, oyster white semi matt, vintage red semi matt, white semi matt. Regional exceptions may apply.

Switch & Cord Hard-wired 200 cm black textile cord with black, anthracite grey and vintage red shades, white on dusty blue and oyster white shades.

Socket EU: E14, US: E12.

Recommended Bulb 470 Lumen (~ 40W incandescent, ~ 28W halogen, ~ 4-6W LED).

Approvals CE, (C)UL.

Other Ceiling canopy included.

Dimensions (cm)

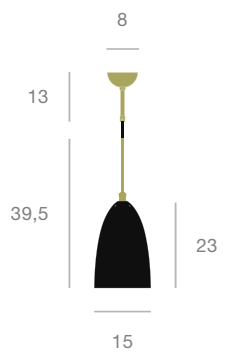



Gräshoppa Table Lamp (*Dusty Blue Semi Matt*) By Greta M. Grossman, 1947

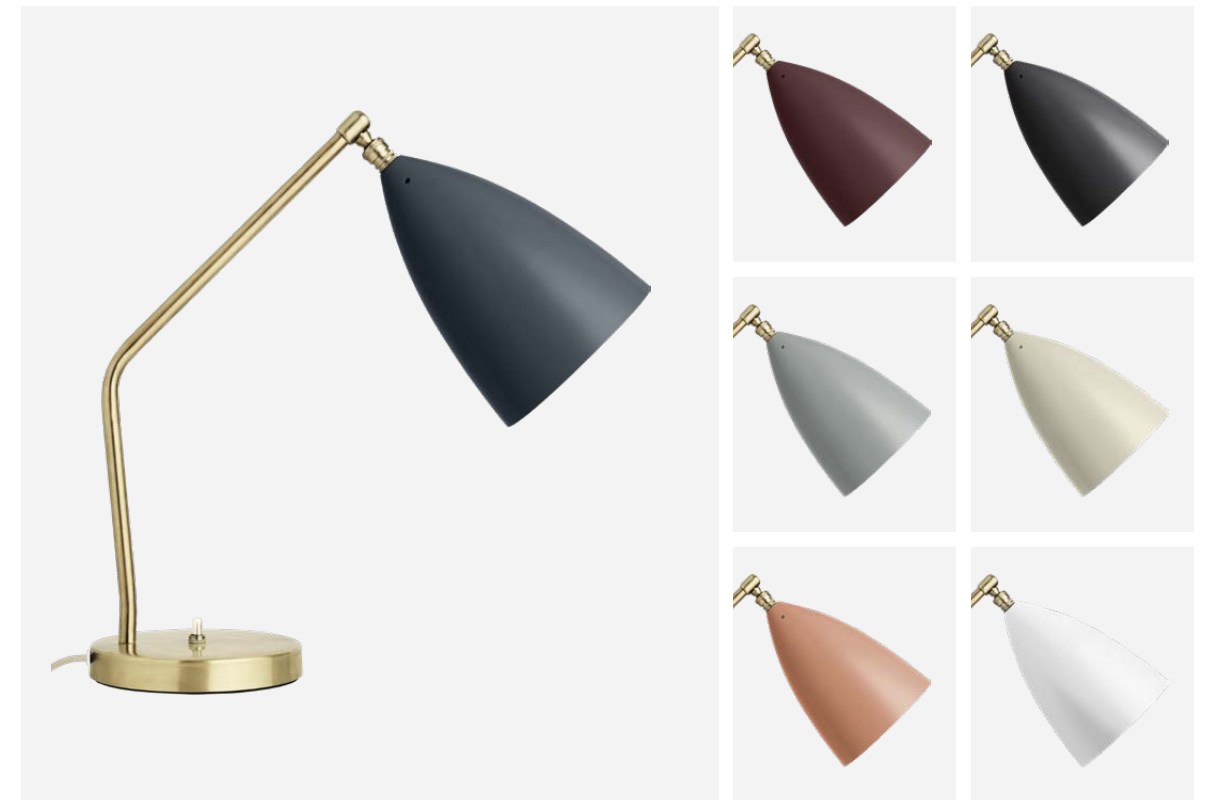

Gräshoppa Table Lamp

Designed by Greta M. Grossman, 1947

Colors Anthracite grey semi matt, andorra red semi matt, black semi matt, dusty blue semi matt, oyster white semi matt, vintage red semi matt, white semi matt. Regional exceptions may apply.

Switch & Cord Switch on base. 230 cm golden textile cord.

Socket EU: E14, US: E12.

Recommended Bulb 470 Lumen (~ 40W incandescent, ~ 28W halogen, ~ 4-6W LED).

Approvals CE, (C)UL.

Other The shade can be tilted horizontally and vertically.

Dimensions (cm)

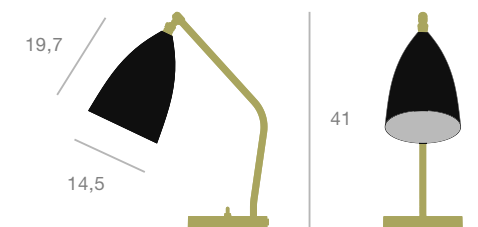



Cobra Wall Lamp

Designed by Greta M. Grossman, 1950

Colors Black semi matt, white semi matt.

Dimensions (cm)

Switch & Cord Switch on back plate. 170 cm textile cord, color matches shade. Regional exceptions may apply.

Socket EU: E14, US: E12.

Mounting Wall mounted with optional hardwiring.

Recommended Bulb 470 Lumen (~ 40W incandescent, ~ 28W halogen, ~ 4-6W LED).

Approvals CE, (C)UL.

Other The lamp can be tilted 90° from horizontal to vertical and the shade can be rotated.

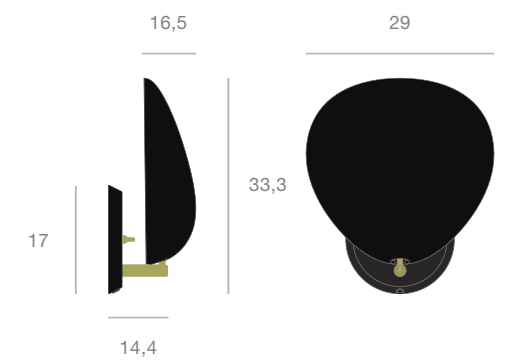

Cobra Wall Lamp
By Greta M. Grossman, 1950
 Black Semi Matt



Cobra Floor Lamp
By Greta M. Grossman, 1950
Anthracite Grey Semi Matt



Cobra Floor Lamp

Designed by Greta M. Grossman, 1950

Colors Anthracite grey semi matt, black semi matt, dusty blue semi matt, vintage red semi matt, warm grey semi matt. Regional exceptions may apply. Regional exceptions may apply.

Switch & Cord Switch on 230 cm white textile cord with warm grey shade, black with others.

Socket EU: E14, US: E12.

Recommended Bulb 470 Lumen (~ 40W incandescent, ~ 28W halogen, ~ 4-6W LED).

Approvals CE, (C)UL.

Other The adjustable flex arm allows for any desired positioning of the shade.

Dimensions (cm)

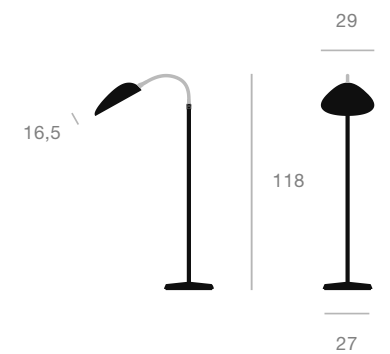

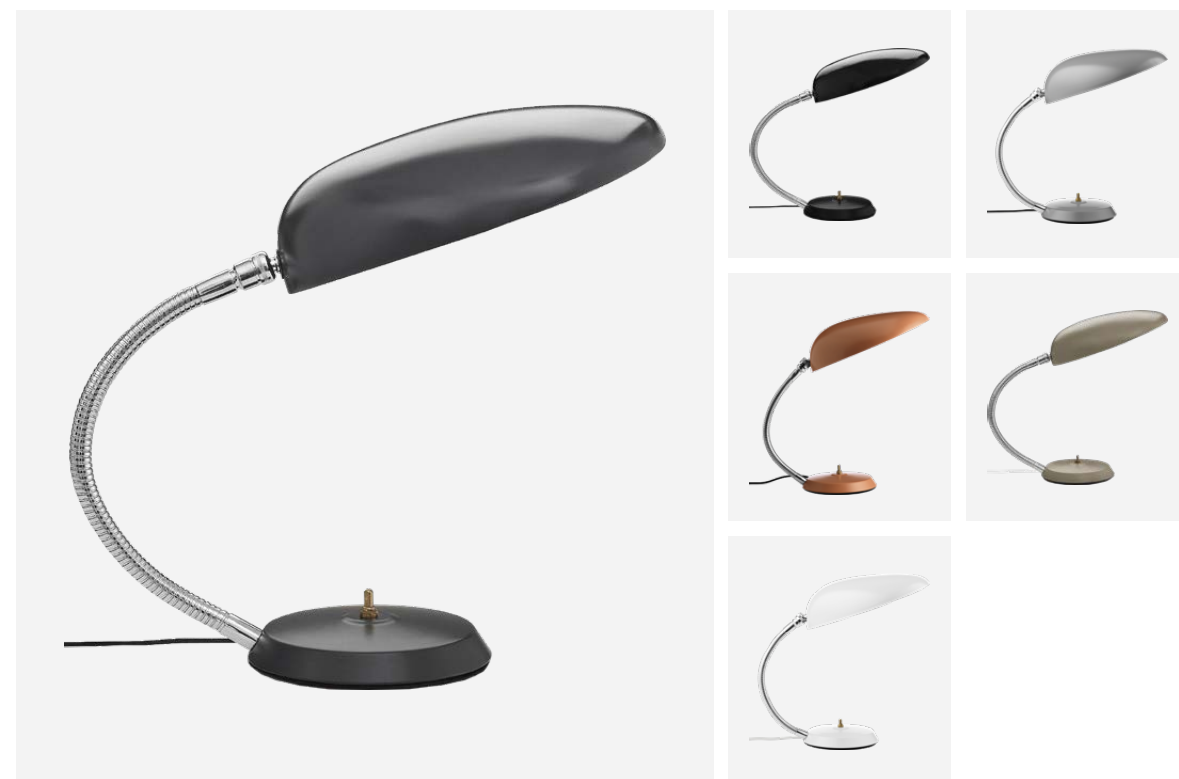
Cobra Table Lamp*By Greta M. Grossman, 1950**Black Semi Matt***Cobra Table Lamp***Designed by Greta M. Grossman, 1950*

Colors Anthracite grey semi matt, black semi matt, dusty blue semi matt, vintage red semi matt, warm grey semi matt, white semi matt. Regional exceptions may apply.

Switch & Cord Switch on base. 170 cm black textile cord.

Socket EU: E14, US: E12.

Recommended Bulb 470 Lumen (~ 40W incandescent, ~ 28W halogen, ~ 4-6W LED).

Approvals CE, (C)UL.

Other The adjustable flex arm allows for any desired positioning of the shade.

Dimensions (cm)

16,5 /



34,5

29

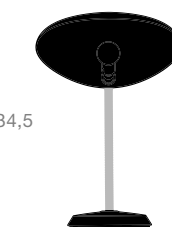

16



B-4 Table Lamp (*Chianti Red Semi Matt*) By Greta M. Grossman, 1945



B-4 Table Lamp

Designed by Greta M. Grossman, 1945

Colors Chianti red semi matt, black & white, French blue semi matt, Italian green semi matt. Regional exceptions may apply. **Dimensions (cm)**

Switch Switch on 200 cm black textile cord.

Socket EU: E27, US: E26.

Recommended Bulb 810 Lumen (~ 60W incandescent, ~ 40-60W halogen, ~ 6-10W LED).

Approvals CE, (C)UL.

Other Movable visors allow light to be directed and diffuse softly in any direction.

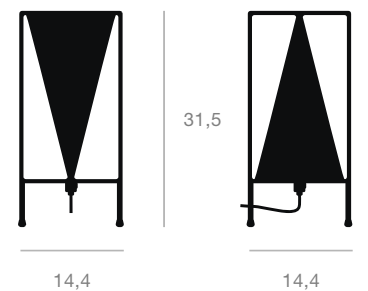

14,4

14,4

PEDRERA COLLECTION

1955

Designed by Barba Corsini & Joaquim Ruiz Millet

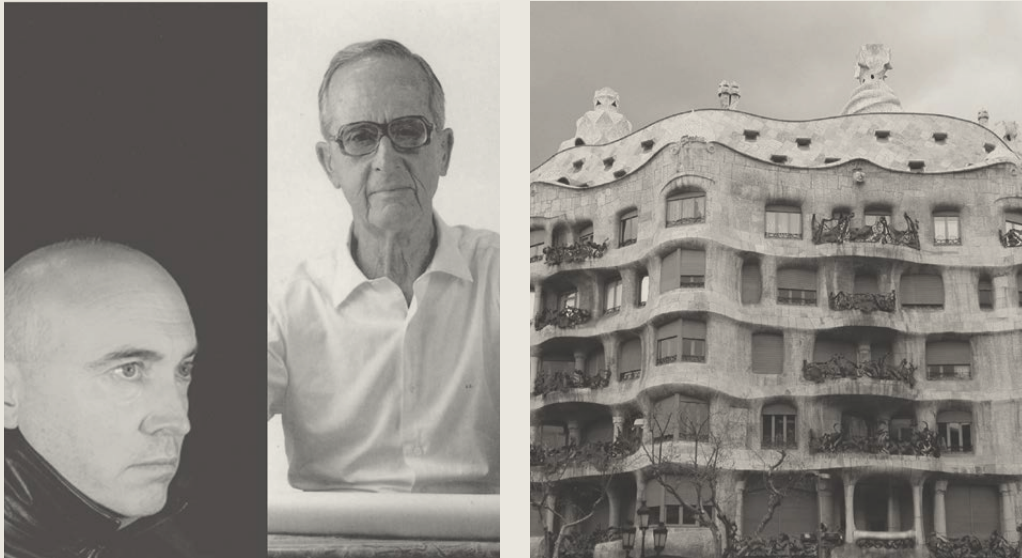

The Pedrera Collection comprises the ABC Table Lamp, PD2 Floor Lamp, ANA Pendant and the H2O Table Lamp and Pendant.

Powerful simplicity inspired by La Pedrera

In 1955, Barba Corsini renovated the loft space at Antoni Gaudí's La Pedrera, transforming a simple laundry room and storage area into 13 apartments. To reinforce the modernist style of the rooms, Corsini populated them with his own designs, including the Pedrera Collection. The base of the lamps was inspired by the vaulted ceilings of La Pedrera, while the building's perforated chimneys

gave the lampshades their form. The entire collection has a powerfully simple character, reflecting Corsini's personal design style, that is perfect for any contemporary home. Barba Corsini designed most of the lamps, others were created in association with his protégé, Joaquim Ruiz Millet and one, the ABC Table Lamp, was designed by Millet as a tribute to Corsini.





PD2 Floor Lamp (Black Semi Matt) By Corsini & Ruiz Millet, 1955



PD2 Floor Lamp

Designed by Barba Corsini, 1955

Colors Black semi matt, white semi matt. Regional exceptions may apply.

Switch & Cord Switch on 300 cm black textile cord with black shade, white with white shade.

Socket EU: E27, US: E26.

Recommended Bulb 1100 Lumen (~ 75W incandescent, ~ 60-70W halogen, ~ 10-12W LED).

Approvals CE, (C)UL.

Dimensions (cm)

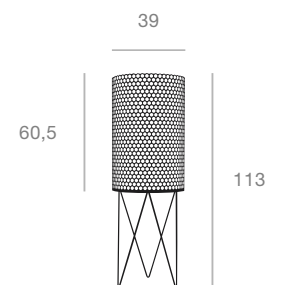

113

ABC Table Lamp

By Corsini & Ruiz Millet, 2009

Black Semi Matt



ABC Table Lamp

Designed by Barba Corsini, 2009

Colors Black semi matt, sky blue semi matt, white semi matt.
Regional exceptions may apply.

Switch & Cord Switch on 200 cm black textile cord with black shade, white with other shades.

Socket EU: E27, US: E26.

Recommended Bulb 470 Lumen (~ 40W incandescent, ~ 28W halogen, ~ 4-6W LED).

Approvals CE, (C)UL.

Dimensions (cm)

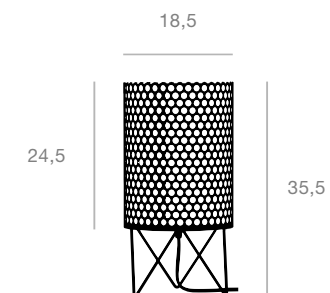

H2O Table Lamp
By Corsini & Ruiz Millet, 1994
Nickel

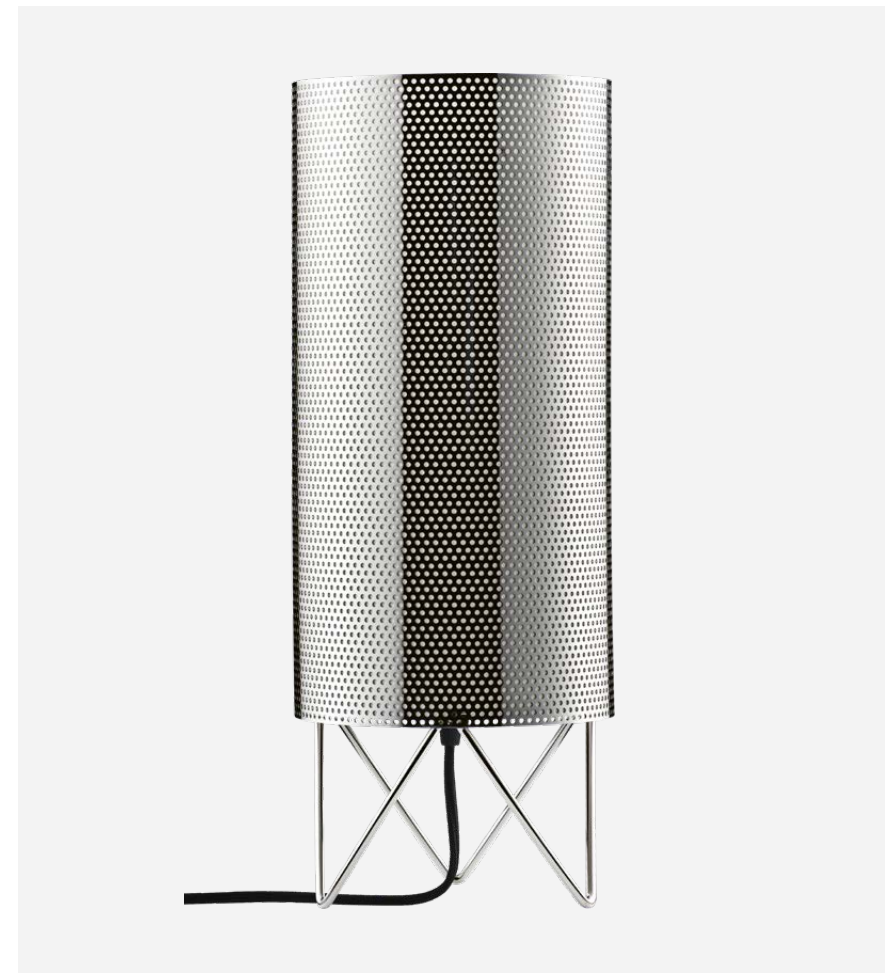

H2O Table Lamp

Designed by Barba Corsini, 1994

Colors Nickel, black semi matt, white semi matt. Regional exceptions may apply.

Switch & Cord Switch on 200 cm white textile cord with white shade, black with other shades.

Socket EU: E27, US: E26.

Recommended Bulb 470 Lumen (~ 40W incandescent, ~ 28W halogen, ~ 4-6W LED).

Approvals CE, (C)UL.

Dimensions (cm)

13



33



H2O Pendant (*Black Semi Matt*) By Corsini & Millet, 1995

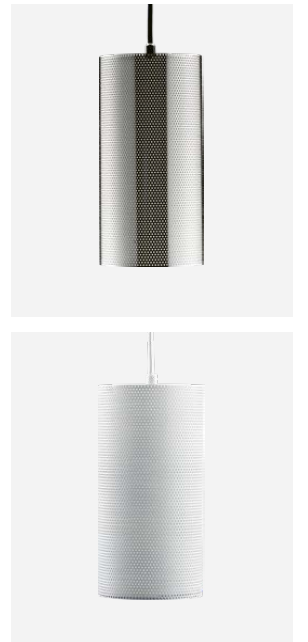

H2O Pendant

Designed by Barba Corsini, 1995

Colors Black semi matt, nickel, white semi matt, sky blue semi matt. Regional exceptions may apply. **Dimensions (cm)**

Switch & Cord Hard-wired 200 cm black textile cord with black and nickel shade, white with other shades.

Socket EU: E27, US: E26.

Recommended Bulb 470 Lumen (~ 40W incandescent, ~ 28W halogen, ~ 4-6W LED).

Approvals CE, (C)UL.

Other Ceiling canopy included.

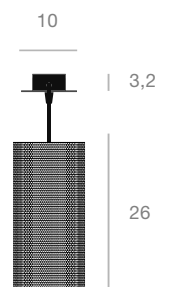

**ANA Pendant**

*Designed by Barba Corsini, 2006
Black Semi Matt*

ANA Pendant

Designed by Barba Corsini, 2006

Colors Black semi matt.

Switch & Cord Hard-wired 200 cm black textile cord.

Socket EU: E27, US: E26.

Recommended Bulb 810 Lumen (≤ 60W incandescent, ≤ 46W halogen, ~ 8-10W LED Dimmable).

Approvals CE, (C)UL.

Other Ceiling canopy included.

**Dimensions (cm)**

10

3,2

63,5

20

20

SATELLITE COLLECTION

1953

Designed by Mathieu Matégot



The Satellite Collection comprises the Satellite Pendant in two sizes.

Light sculpture in Rigitulle metal

The Satellite Pendant was designed in 1953 by Mathieu Matégot, who combined geometrical shapes and an organic-form shade to create outstanding sculptural aesthetics. The name, Satellite, was given by Matégot as a nod to the scientific progress in France in the years after the Second World War. The Satellite Pendant makes use of the distinctive Rigitulle technique, invented by the designer, which makes it possible to bend and fold perforated sheet metal into an original, elliptical form.

The interplay of light and shadow cast by the perforations onto the surrounding walls and floors generates a dramatic and convivial feature in any dining room, hallway or restaurant. The pendant is topped by a lampshade available in five color options; midnight black, white cloud, shy cherry, Venetian gold and rainy grey. Hang the Satellite Pendant alone as a strong solo piece or cluster it in groups to create a visual statement.



Satellite Pendant - Ø22 (M) & Ø27 (L)

By Mathieu Matégot, 1953

*Stone Grey Semi Matt, Cream White Semi Matt,
Soft Black Semi Matt*



Satellite Pendant - Ø22 (M)

Designed by Mathieu Matégot, 1953

Colors Soft black semi matt, cream white semi matt, ruby red semi matt, stone grey semi matt, mustard gold semi matt. Regional exceptions may apply.

Switch & Cord Hard-wired 480 cm black textile cord.

Socket EU: E27, US: E26.

Recommended Bulb Tubular Type T30 or T9. 810 Lumen (≤ 60W incandescent, ≤ 46W halogen, ~ 8-10W LED Dimmable). Max length 185 mm, Ø30 mm.

Approvals CE, (C)UL.

Other Bulb included.

Dimensions (cm)

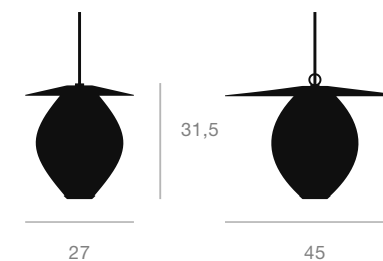

Satellite Pendant - Ø27 (L)

Designed by Mathieu Matégot, 1953

Colors Soft black semi matt, cream white semi matt, ruby red semi matt, stone grey semi matt, mustard gold semi matt. Regional exceptions may apply.

Switch & Cord Hard-wired 480 cm black textile cord.

Socket EU: E27, US: E26.

Recommended Bulb Tubular Type T30 or T9. 810 Lumen (≤ 60W incandescent, ≤ 46W halogen, ~ 8-10W LED Dimmable). Max length 225 mm, Ø30 mm.

Approvals CE, (C)UL.

Other Bulb included.

Dimensions (cm)

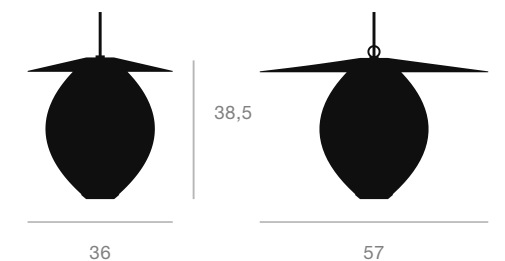

MULTI-LITE COLLECTION

1972

Designed by Louis Weisdorf

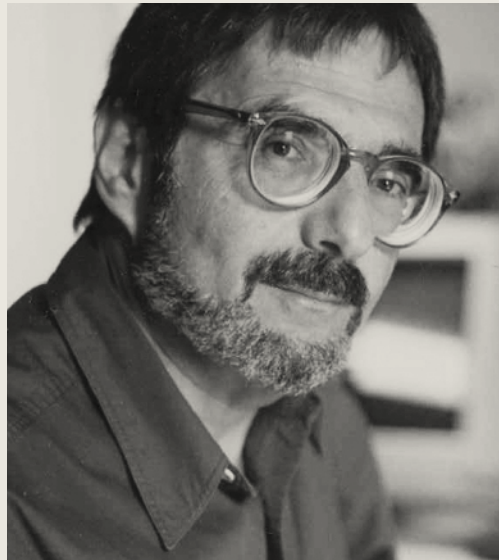

The Multi-Lite Collection comprises two pendants, a floor lamp and a table lamp.

A multi-functional collection that encourages personalization

The 1972 Multi-Lite Collection by Louis Weisdorf represents the 'golden era' of Danish design, featuring two adaptable, characterful shades that are sure to become the focal point of any room. A metal ring, two rotating cylinders and a suspended quarter-sphere shade form the playful and endlessly customizable lamps of the Multi-Lite Collection. Simply adjusting the shades transforms the light, enabling the light to be directed

upwards, downwards or even in asymmetric beams. The Multi-Lite Collection showcases Weisdorf's movement away from his traditional design style to pursue a more diverse aesthetic. Available in brass or chrome, and in a range of colors, this family of highly configurable lights comprises truly striking pieces that combine classic materials with contemporary style. Their eye-catching design would complement any space, public or private.





Multi-Lite Pendant - Small, Brass base (Black Semi Matt) By Louis Weisdorf, 2019

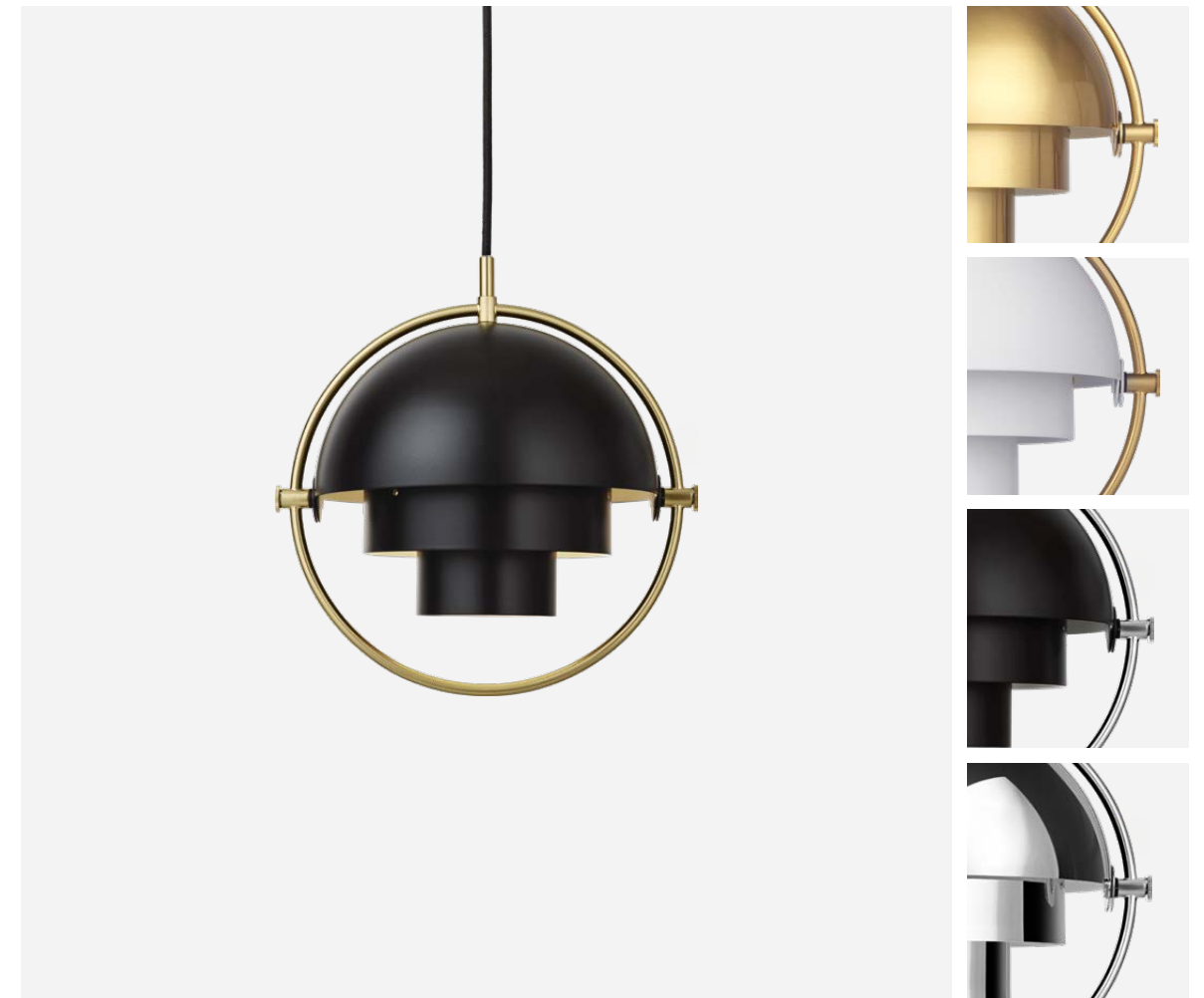

Multi-Lite Pendant - Small

Designed by Louis Weisdorf, 2019

Colors Brass base: soft black semi matt, shiny brass, white semi matt. Chrome base: black semi matt, chrome. Regional exceptions may apply.

Switch & Cord Hard-wired 380 cm black textile cord with black shade and chrome shades, golden with brass shade, white with white shade.

Socket EU: E14, US: E12.

Recommended Bulb 470 Lumen (~ 40W incandescent, ~ 28W halogen, ~ 4-6W LED).

Approvals CE, (C)UL.

Other The shades can be rotated to direct the diffusion of light. Ceiling canopy included.

Dimensions (cm)

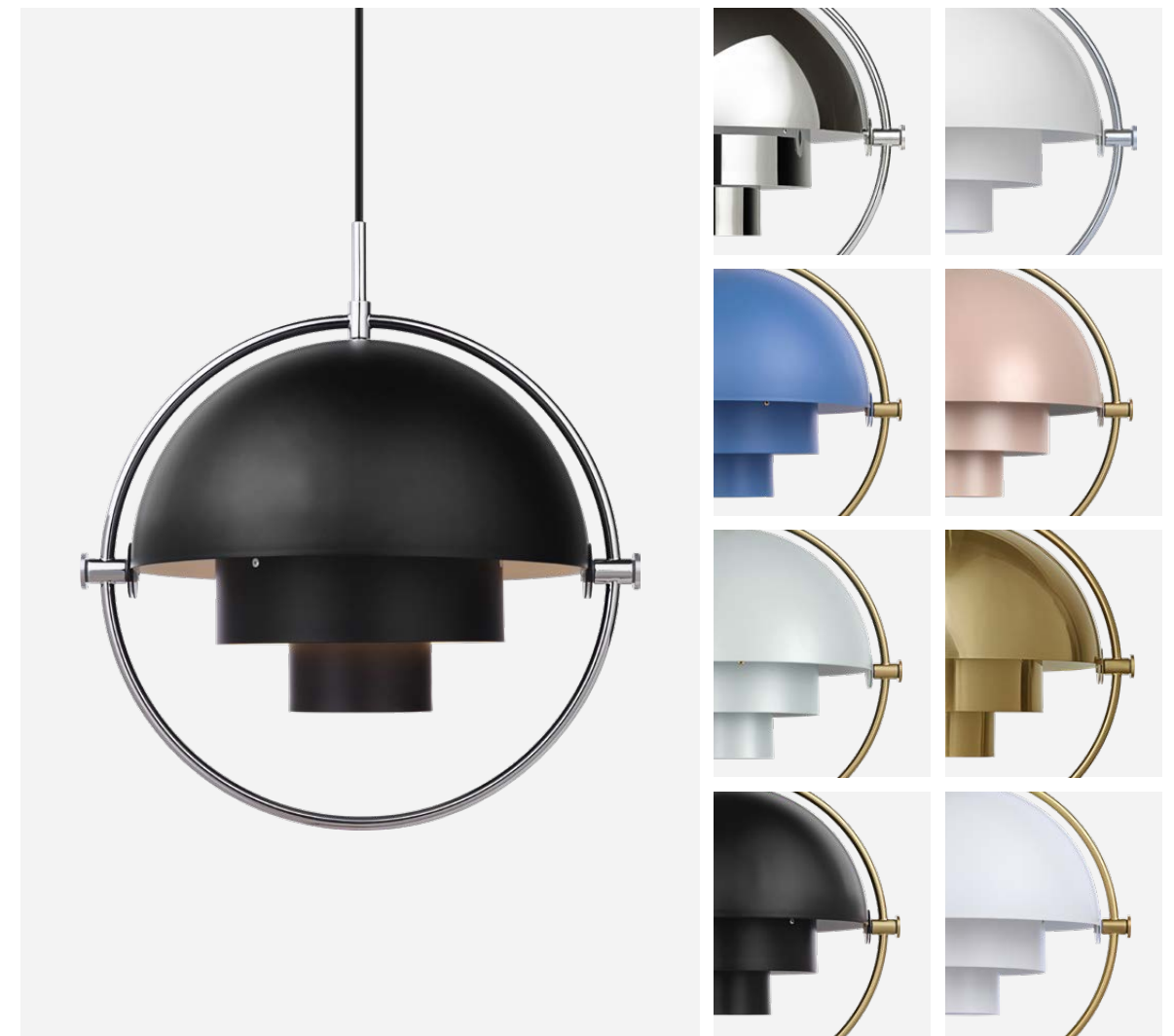

Multi-Lite Pendant, Brass base*Designed by Louis Weisdorf, 1972**Sea Grey Semi Matt***Multi-Lite Pendant***Designed by Louis Weisdorf, 1972*

Colors Chrome base: black semi matt, chrome and white semi matt shades. Brass base: nordic blue matt, rose dust semi matt, sea grey semi matt, shiny brass, soft black semi matt and white semi matt shades. Regional exceptions may apply.

Switch & Cord Hard-wired 380 cm textile cord. Cord color is black with black and chrome shades, golden with brass and blue shades, white with white shade.

Socket EU: E27, US: E26.

Recommended Bulb 810 Lumen ($\leq 60W$ incandescent, $\leq 46W$ halogen, $\sim 8-10W$ LED Dimmable).

Approvals CE, (C)UL.

Other The shades can be rotated to direct the diffusion of light. Ceiling canopy included.

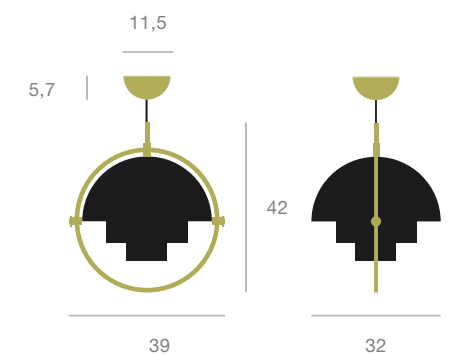
Dimensions (cm)



BL1 Table Lamp - Ø16, Brass base
 By Robert Dudley Best, 1930
 Bone China



Multi-Lite Table Lamp

Designed by Louis Weisdorf, 2019

Colors Brass base: brass shiny and black semi matt shades.
 Chrome base: chrome and white semi matt shades. Regional exceptions may apply.

Switch & Cord Switch on 200 cm golden textile cord with brass base, black with chrome base.

Socket EU: E27, US: E26.

Recommended Bulb 470 Lumen (~ 40W incandescent, ~ 28W halogen, ~ 4-6W LED).

Approvals CE, (C)UL.

Other The shades can be rotated to direct the diffusion of light.

Dimensions (cm)

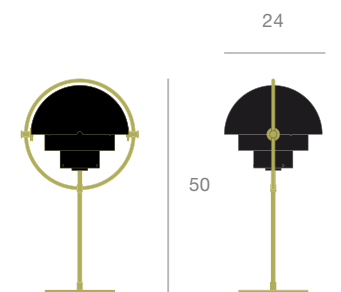



Multi-Lite Floor Lamp, Chrome base (White Semi Matt) By Louis Weisdorf, 2018



Multi-Lite Floor Lamp

Designed by Louis Weisdorf, 2018

Colors Brass base: shiny brass and soft black semi matt shades.
Chrome base: chrome and white semi matt shades. Regional exceptions may apply.

Dimensions (cm)

Switch & Cord Switch on 200 cm golden textile cord with brass base, black with chrome base.

Socket EU: E27, US: E26.

Recommended Bulb 810 Lumen ($\leq 60W$ incandescent, $\leq 46W$ halogen, $\sim 8-10W$ LED Dimmable).

Approvals CE, (C)UL.

Other The shades can be rotated to direct the diffusion of light.



TURBO COLLECTION

1965

Designed by Louis Weisdorf

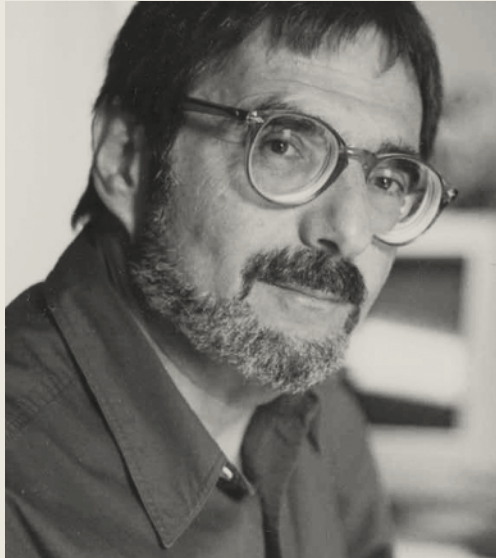

Turbo Collection comprises the Turbo Pendant in two sizes.

Geometry creates sculptural elegance

Louis Weisdorf's Turbo Pendant was designed in 1965, but first put into production in 1967 and has achieved great success since then. It represents design at its best: it is simple in form yet complex in structure, and combines a sense of both strength and spaciousness in a beautiful sculptural whole. The lightness of the Japanese rice paper

that inspired the lamp has been transformed into a more durable and sturdier form. The outer curve of the lamp is made of 12 spiral membranes that form a flower-like globe to shield the light. The Turbo Pendant is a perfect example of how Weisdorf's passion for the repetition of elements characterizes his design.





Turbo Pendant - Ø62 (White) By Louis Weisdorf, 1965

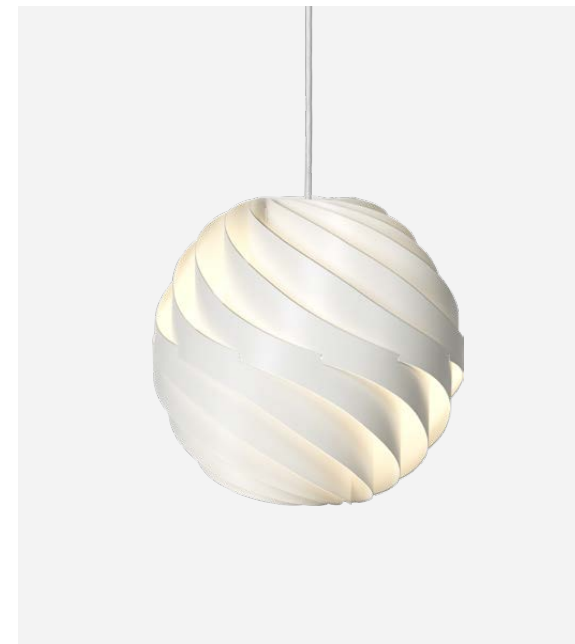

Turbo Pendant - Ø36

Designed by Louis Weisdorf, 1965

Colors White semi matt.

Switch & Cord Hard-wired 380 cm white textile cord.

Socket EU: E27, US: E26.

Recommended Bulb 810 Lumen ($\leq 60W$ incandescent, $\leq 46W$ halogen, $\sim 8-10W$ LED Dimmable).

Approvals CE, (C)UL.

Other Ceiling canopy included.

Dimensions (cm)

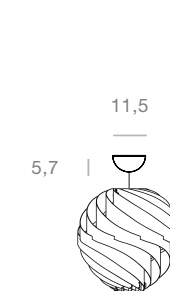

36

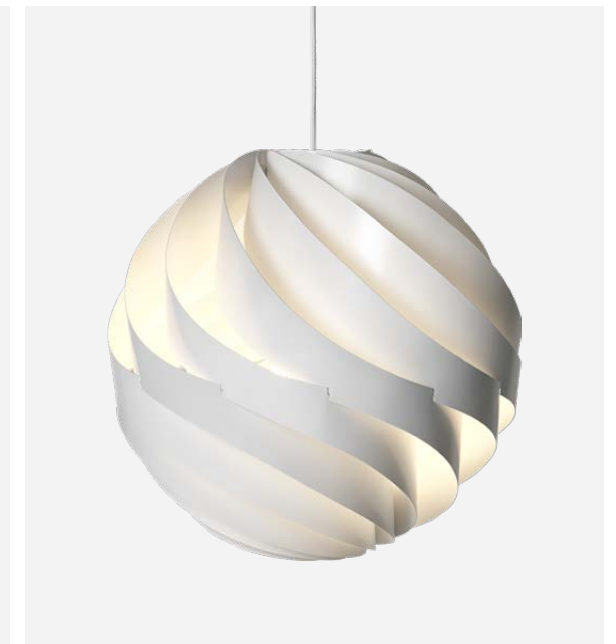

Turbo Pendant - Ø62

Designed by Louis Weisdorf, 1965

Colors White semi matt.

Switch & Cord Hard-wired 380 cm white textile cord.

Socket EU: E27, US: E26.

Recommended Bulb 1100 Lumen ($\sim 75W$ incandescent, $\sim 60-70W$ halogen, $\sim 10-12W$ LED).

Approvals CE, (C)UL.

Other Ceiling canopy included.

Dimensions (cm)

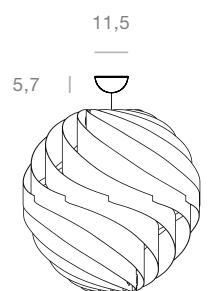

62

RONDE COLLECTION

2013

Designed by Oliver Schick



The Ronde Collection comprises the Ronde Pendant in two sizes.

Organic curves create timeless design

The bell-shaped Ronde Pendant by Oliver Schick references the traditional pendant lamp, a mainstay of the 1970s, but applies a modern twist. The opening at the top is a unique feature of the design, with its overhanging collar reminiscent of a jar, vase or amphora. Whereas conventional pendant lamps direct light downwards, the Ronde Pendant

casts a gentle light above and below, illuminating both the work surface and the space above it. The hand-turned aluminum lampshade has an ultra-matt lacquer that creates a ceramic-like aesthetic. Appropriately, 'ronde' is the word for 'round' or 'rotating' in a number of languages, as well as the name for the dance in which participants move in a circle.



Ronde Pendant - Ø20

By Oliver Schick, 2013

Soft Black, Pigeon Grey Matt, Redwood Matt



Ronde Pendant - Ø20

Designed by Oliver Schick, 2013

Colors Soft black matt, anthracite grey matt, pigeon grey matt, redwood matt, white matt. Regional exceptions may apply.

Switch & Cord Hard-wired 580 cm white textile cord with white shade, black with other shades.

Socket EU: E27, US: E26.

Recommended Bulb 810 Lumen (≤ 60W incandescent, ≤ 46W halogen, ~ 8-10W LED Dimmable).

Approvals CE, (C)UL.

Other Ceiling canopy included.

Dimensions (cm)

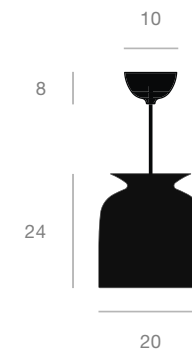

Ronde Pendant - Ø40

Designed by Oliver Schick, 2013

Colors Soft black matt, anthracite grey matt, pigeon grey matt, redwood matt, white matt. Regional exceptions may apply.

Switch & Cord Hard-wired 480 cm white textile cord with white shade, black with other shades.

Socket EU: E27, US: E26.

Recommended Bulb 810 Lumen (≤ 60W incandescent, ≤ 46W halogen, ~ 8-10W LED Dimmable).

Approvals CE, (C)UL.

Other Ceiling canopy included.

Dimensions (cm)

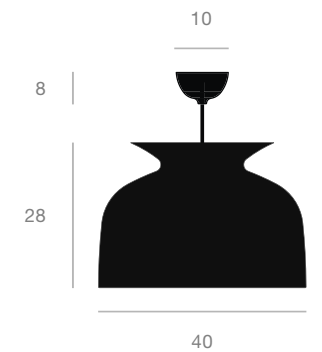

TYNELL COLLECTION

1938–1950

Designed by Paavo Tynell

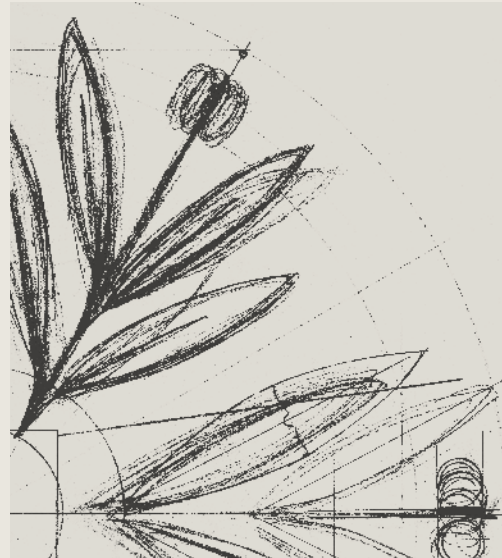

The Tynell Collection comprises the 1965 Pendant, A1965 Pendant, 9602 Floor Lamp, 5321 Table Lamp and 9464 Wall Lamp.

Classic designs of enduring beauty

The Tynell Collection combines a traditional aesthetic with a modern sensibility, demonstrating Paavo Tynell's unparalleled imagination in creating designs of timeless beauty. Tynell originally conceived the 1965 Pendant and A1965 Pendant in 1948. Like many of his best-known designs, the pendants were created for the Finland House in New York – one of the most ambitious and successful international showcases of Finnish design. Characterized by their triangular perforation pattern – an artistic detail featured in several of Tynell's lighting objects – the pendants are considered to be the pinnacle of his mid-century work. The impeccable construction of the A1965 Pendant fully reveals Tynell's ability to elevate

functional light fixtures into works of art. This remarkable style played a significant role in shaping the aesthetic of mid-century lighting. Tynell designed the 9602 Floor Lamp in 1938 for the Aulanko Hotel. It is characterized by its light and elegant lampshade and rattan-covered stem. The 5321 Table Lamp, designed in 1941, reflects the designer's fanciful take on nature. The bulb subtly appears from beneath the distinctive scalloped brass shade; a picturesque detail resembling a seashell concealing a pearl. The 9464 Wall Lamp, designed in the early 1950s, is another great example of the Finnish designer's artistic approach to illumination and is as relevant today as it was when it was first introduced.





9464 Wall Lamp, Brass base (*Polished Brass*) By Paavo Tynell, 1950

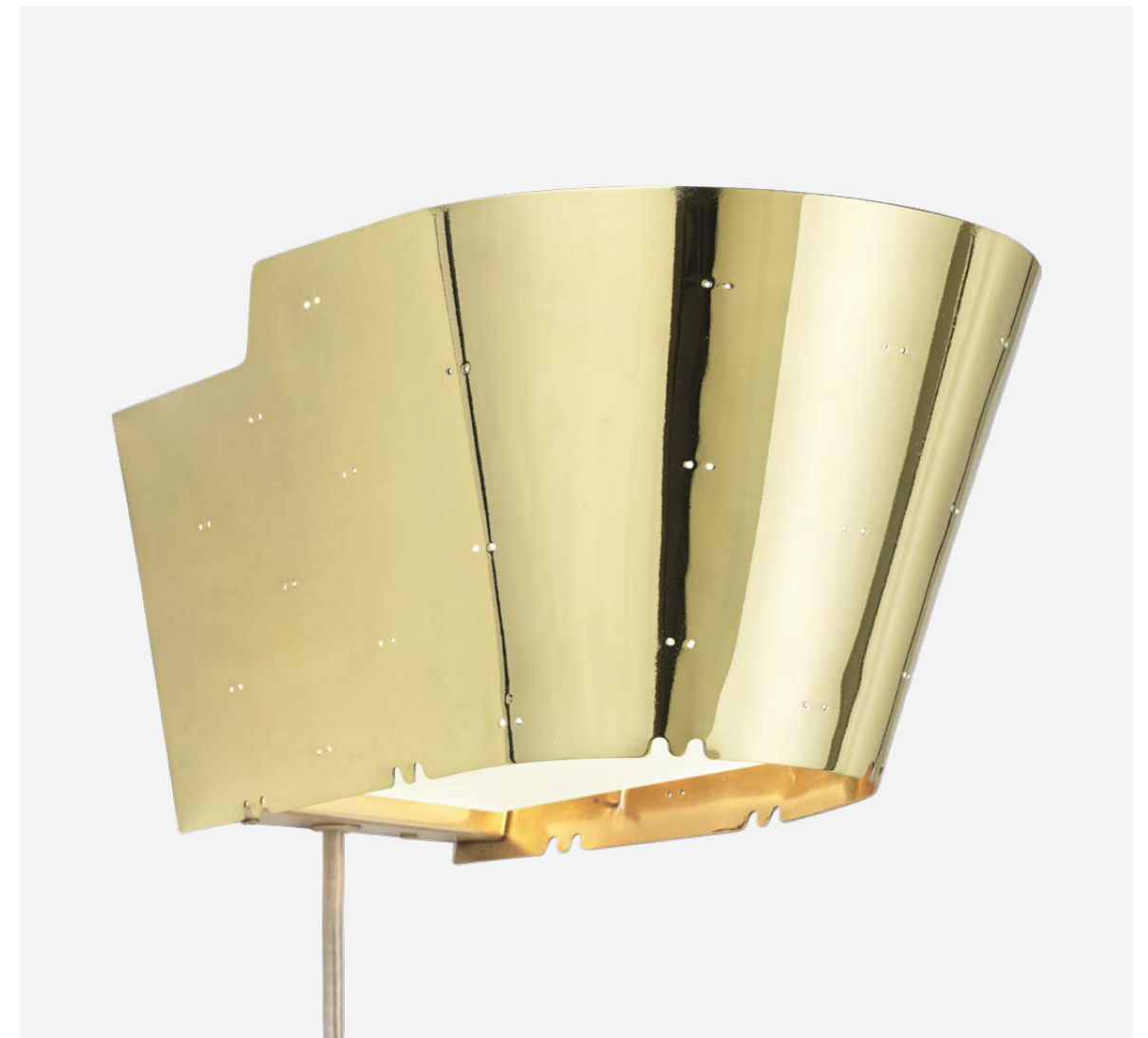

9464 Wall Lamp

Designed by Paavo Tynell, 1950

Colors Polished brass.

Switch & Cord Switch on 200 cm golden textile cord.

Socket EU: E27, US: E26.

Recommended Bulb 810 Lumen ($\leq 60W$ incandescent, $\leq 46W$ halogen, $\sim 8-10W$ LED Dimmable).

Approvals CE, (C)UL.

Dimensions (cm)

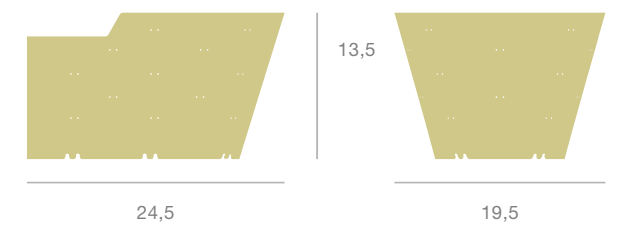

9602 Floor Lamp
By Paavo Tynell, 1938
Canvas

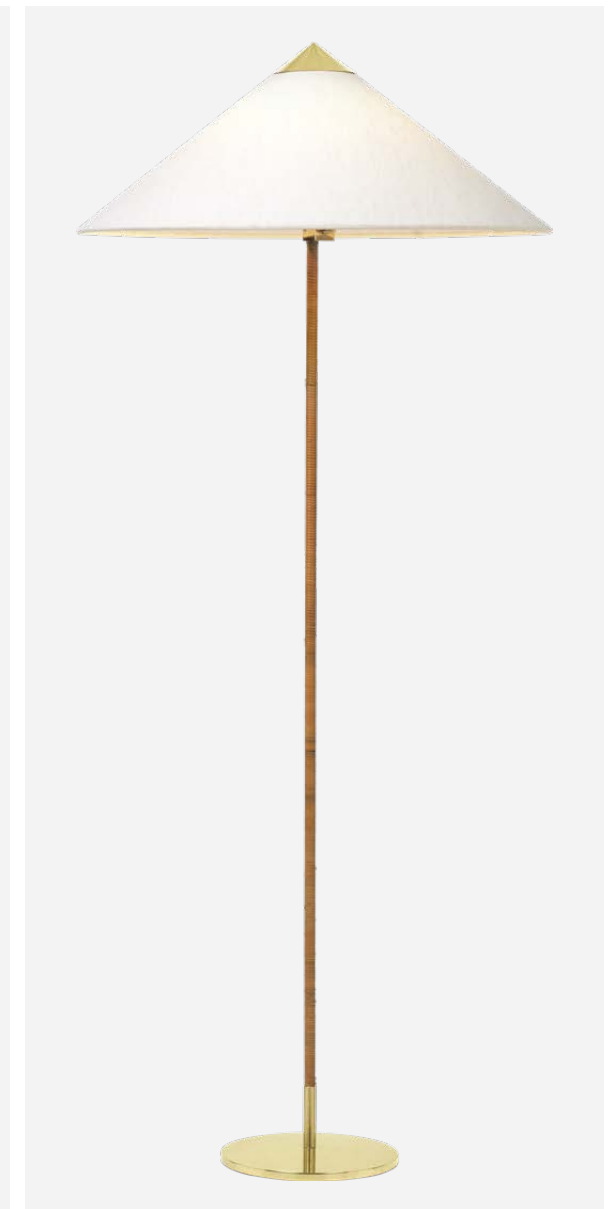

9602 Floor Lamp

Designed by Paavo Tynell, 1938

Colors Wicker willow, canvas. Regional exceptions may apply.

Dimensions (cm)

Switch & Cord Switch on 200 cm golden textile cord.

Socket EU: 2 × E27, US: 2 × E26.

Recommended Bulb 810 Lumen (≤ 60W incandescent, ≤ 46W halogen, ~ 8-10W LED Dimmable).

Approvals CE, (C)UL.

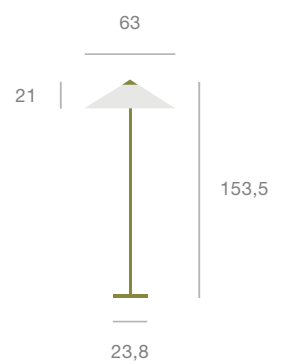



1965 Pendant (Polished Brass) By Paavo Tynell, 1948



1965 Pendant

Designed by Paavo Tynell, 1948

Colors Polished brass, bistro green semi matt, chianti red semi matt, classic white semi matt, soft black semi matt. Regional exceptions may apply.

Switch & Cord Hard-wired 380 cm golden textile cord.

Socket EU: 3 × E27, US: 3 × E26.

Recommended Bulb 810 Lumen (≤ 60W incandescent, ≤ 46W halogen, ~ 8-10W LED Dimmable).

Approvals CE, (C)UL.

Other Ceiling canopy included.

Dimensions (cm)

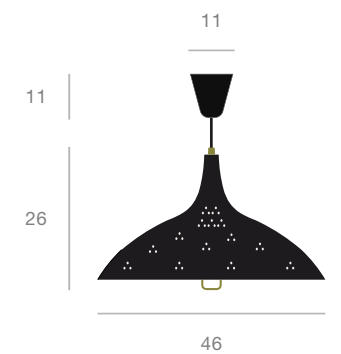



A1965 Pendant
By Paavo Tynell, 1948
Classic White Semi Matt



A1965 Pendant

Designed by Paavo Tynell, 1948

Colors Soft black semi matt, polished brass, classic white semi matt. Regional exceptions may apply.

Dimensions (cm)

Switch & Cord Hard-wired 380 cm golden textile cord.

Socket EU: 3 × E27, US: 3 × E26.

Recommended Bulb 810 Lumen (≤ 60W incandescent, ≤ 46W halogen, ~ 8-10W LED Dimmable).

Approvals CE, (C)UL.

Other Ceiling canopy included. The weight system can be used to adjust the height.

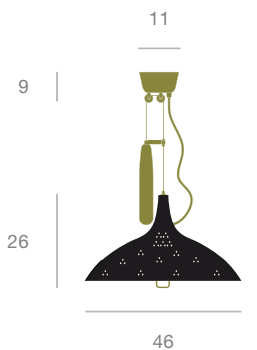



5321 Table Lamp (Polished Brass) By Paavo Tynell, 1941



5321 Table Lamp

Designed by Paavo Tynell, 1941

Colors Polished brass.

Switch & Cord 200 cm golden textile cord.

Socket EU: E27, US: E26.

Recommended Bulb 250 Lumen (~ 25W incandescent, ~ 18W halogen, ~ 2-4W LED)

Approvals CE, (C)UL.

Dimensions (cm)

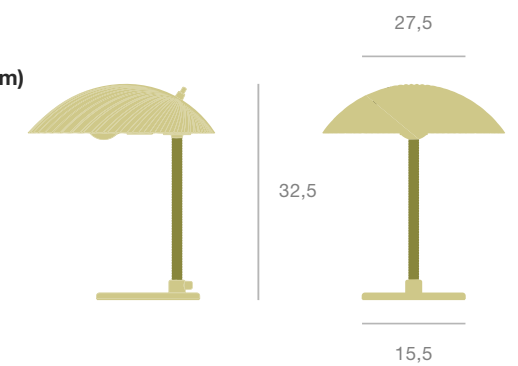

GRAVITY COLLECTION

2018

Designed by Space Copenhagen



The Gravity Collection comprises the Gravity Floor Lamp, Gravity Floor Lamp XL, Gravity Table Lamp, Gravity Pendant and Gravity Wall Lamp.

Strength and delicacy held in balance

The Gravity Collection, designed by Space Copenhagen, contrasts the aesthetics of strength and fragility. Taking its name from the distinctive balance between the anchoring of the heavy, cylindrical base and the lightweight, paper-thin shade, the collection's perfect proportions unite the two

elements into a sculptural whole. Effortlessly blending understated elegance with clean functionality in its own succinct and simple way, the Gravity Collection provides an ambient and subtle light, creating different moods and expressions depending on the choice of size and materials.





Gravity Table Lamp - Small, Grey Marble base
 By Space Copenhagen, 2018
 Canvas



Gravity Table Lamp - Small

Designed by Space Copenhagen, 2018

Colors Bases: grey marble, black marble, white marble, blackened steel. Shades: canvas, white.

Switch & Cord Dimmer switch on base. 200 cm black textile cord.

Socket EU: E27, US: E26.

Recommended Bulb 470 Lumen (~ 40W incandescent, ~ 28W halogen, ~ 4-6W LED).

Approvals CE, (C)UL.

Dimensions (cm)

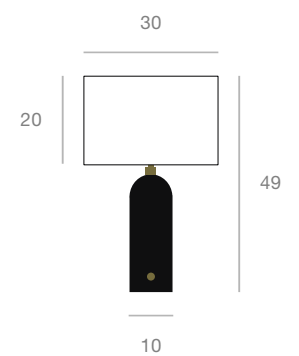



Gravity Table Lamp - Large, Blackened Steel Base (Canvas) By Space Copenhagen, 2018



Gravity Table Lamp - Large

Designed by Space Copenhagen, 2018

Colors Bases: white marble, black marble, grey marble, blackened steel. Shades: white, canvas.

Switch & Cord Dimmer switch on base. 200 cm black textile cord.

Socket EU: E27, US: E26.

Recommended Bulb 810 Lumen ($\leq 60W$ incandescent, $\leq 46W$ halogen, $\sim 8-10W$ LED Dimmable).

Approvals CE, (C)UL.

Dimensions (cm)

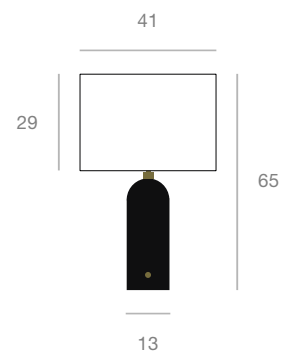

Gravity Floor Lamp, Grey Marble Base
By Space Copenhagen, 2018
Canvas



Gravity Floor Lamp,

Designed by Space Copenhagen, 2018

Colors Bases: blackened steel, black marble, grey marble, white marble. Shades: canvas, white. **Dimensions (cm)**

Switch & Cord Switch in shade, dimmer on 300 cm black textile cord.

Socket EU: 3 × E27, US: 3 × E26.

Recommended Bulb 1100 Lumen (≤ 75W incandescent, ≤ 57W halogen, ~ 10-12W LED Dimmable).

Approvals CE, (C)UL.

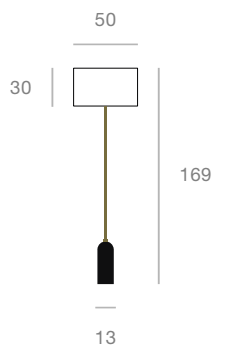



Gravity Floor Lamp - XL High, Grey Marble base (White) By Space Copenhagen, 2018



Gravity Floor Lamp - XL High

Designed by Space Copenhagen, 2018

Colors Bases: grey marble, black marble, white marble.
Shades: white, canvas.

Switch & Cord Dimmer switch on base. 200 cm black textile cord.

Socket EU: E27, US: E26.

Recommended Bulb 1100 Lumen ($\leq 75W$ incandescent, $\leq 57W$ halogen, $\sim 10-12W$ LED Dimmable).

Approvals CE, (C)UL.

Dimensions (cm)

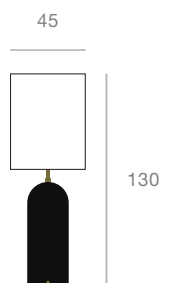

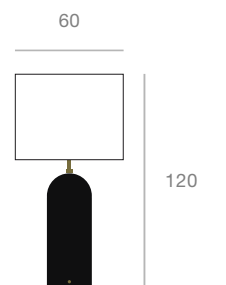
Gravity Floor Lamp - XL Low, White Marble base*By Space Copenhagen, 2018
White***Gravity Floor Lamp - XL Low***Designed by Space Copenhagen, 2018***Colors** Bases: black marble, grey marble, white marble.
Shades: canvas, white.**Switch & Cord** Dimmer switch on base. 200 cm black textile cord.**Socket** EU: E27, US: E26.**Recommended Bulb** 1100 Lumen (≤ 75W incandescent, ≤ 57W halogen, ~ 10-12W LED Dimmable).**Approvals** CE, (C)UL.**Dimensions (cm)**



Gravity Bedside Lamp - Large, Antique Brass base (Canvas) By Space Copenhagen, 2019



Gravity Bedside Lamp - Small

Designed by Space Copenhagen, 2019

Colors Canvas, white.

Switch & Cord Dimmer switch on base. 180 cm black textile cord.

Socket EU: E14, US: E12.

Recommended Bulb 470 Lumen (~ 40W incandescent, ~ 28W halogen, ~ 4-6W LED).

Approvals CE, (C)UL.

Dimensions (cm)

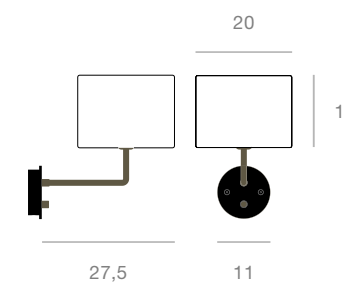

Gravity Bedside Lamp - Large

Designed by Space Copenhagen, 2019

Colors White, canvas.

Switch & Cord Dimmer switch on base. 180 cm black textile cord.

Socket EU: E27, US: E26.

Recommended Bulb 470 Lumen (~ 40W incandescent, ~ 28W halogen, ~ 4-6W LED).

Approvals CE, (C)UL.

Other The arm turns side to side.

Dimensions (cm)

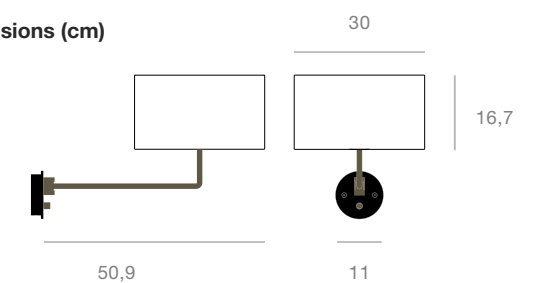



Gravity Pendant - Ø60, Large, Antique Brass
By Space Copenhagen, 2019
White



Gravity Pendant - Ø30, Small

Designed by Space Copenhagen, 2019

Colors White, canvas.

Switch & Cord Hard-wired 400 cm black textile cord.

Socket EU: E27, US: E26.

Recommended Bulb 470 Lumen (~ 40W incandescent, ~ 28W halogen, ~ 4-6W LED).

Approvals CE, (C)UL.

Dimensions (cm)

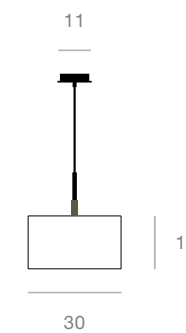

17

30

Gravity Pendant - Ø60, Large

Designed by Space Copenhagen, 2019

Colors Canvas, white.

Switch & Cord Hard-wired 400 cm black textile cord.

Socket EU: 3 x E27, US: 3 x E26.

Recommended Bulb 810 Lumen (≤ 60W incandescent, ≤ 46W halogen, ~ 8-10W LED Dimmable).

Approvals CE, (C)UL.

Dimensions (cm)

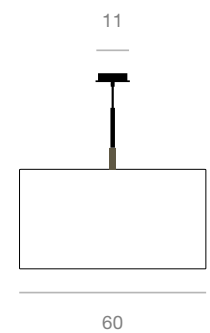

32

60

INDEX

1965 Pendant.....	109	Gräshoppa Floor Lamp.....	55
5321 Table Lamp.....	113	Gräshoppa Pendant.....	57
9464 Wall Lamp.....	105	Gräshoppa Table Lamp.....	59
9602 Floor Lamp.....	107	Gravity Bedside Lamp - Large.....	127
A1965 Pendant.....	111	Gravity Bedside Lamp - Small.....	127
ABC Table Lamp.....	73	Gravity Floor Lamp.....	121
ANA Pendant.....	79	Gravity Floor Lamp - XL High.....	123
B-4 Table Lamp.....	67	Gravity Floor Lamp - XL Low.....	125
BL1 Table Lamp - Ø16.....	11	Gravity Pendant - Ø30, Small.....	129
BL2 Table Lamp - Ø16.....	13	Gravity Pendant - Ø60, Large.....	129
BL3 Floor Lamp - Ø16 (S).....	15	Gravity Table Lamp - Large.....	119
BL3 Floor Lamp - Ø21 (M).....	17	Gravity Table Lamp - Small.....	117
BL4 Floor Lamp - Ø21 (M).....	19	H2O Pendant.....	77
BL5 Wall Lamp - Ø16.....	21	H2O Table Lamp.....	75
BL6 Wall Lamp - Ø16.....	23	Multi-Lite Floor Lamp.....	93
BL7 Wall Lamp - Ø16.....	25	Multi-Lite Pendant.....	89
BL9 Pendant - Ø16 (S).....	27	Multi-Lite Pendant - Small.....	87
BL9 Pendant - Ø21 (M).....	29	Multi-Lite Table Lamp.....	91
BL9 Pendant - Ø40 (L).....	31	PD2 Floor Lamp.....	71
BL9 Pendant - Ø60 (XL).....	33	Ronde Pendant - Ø20.....	101
BL10 Wall Lamp - Ø16.....	35	Ronde Pendant - Ø40.....	101
Cobra Floor Lamp.....	63	Satellite Pendant - Ø22 (M).....	83
Cobra Table Lamp.....	65	Satellite Pendant - Ø27 (L).....	83
Cobra Wall Lamp.....	61	Semi Pendant - Ø30.....	43
Collar Pendant - Ø30.....	39	Semi Pendant - Ø47.....	45
Collar Pendant - Ø42.....	39	Semi Pendant - Ø60.....	47
G-10 Floor Lamp.....	51	Turbo Pendant - Ø36.....	97
G-10 Pendant.....	53	Turbo Pendant - Ø62.....	97

GET INSPIRED

FACEBOOK

gubiofficial

INSTAGRAM

gubiofficial

PINTEREST

gubiofficial

GUBI STORE

Møntergade 19, Copenhagen

GUBI LIBRARY

IMAGE DOWNLOADS

gubi.filecamp.com



GUBI.COM