



Struttura: telaio superiore e appoggio a terra in tubolare di acciaio inox AISI 304 verniciato color Bronzo con finitura lucida anti-touch. La struttura in acciaio è rivestita da un filato di polipropilene intrecciato, che forma un nastro di mm 24x7. Il filato è disponibile nei colori Ecru e Bronzo.

Cornice in massello di teak (Tectona Grandis - First European Quality), finitura naturale, spessore 60 mm, stabilizzato in forni di essiccazione. Lavorazione eseguita su macchina a controllo numerico, assemblaggio a 45° con incastri a pettine e bloccaggio tramite spinature.

Il daybed con schienale reclinabile ha un telaio in metallo verniciato color Bronzo con finitura lucida anti-touch, rivestito con tessuto Batyline.

Cuscinata: cuscini sedile e schienale in poliuretano espanso ad alta resilienza e fibra idrorepellente ecocompatibile. Al fine di migliorare la protezione delle imbottiture da acqua e umidità, tutti i cuscini sono rivestiti con una fodera in poliestere con trattamento idrorepellente. Tutti gli accessori utilizzati per la confezione - cerniere, filo - sono idrorepellenti e pertanto idonei all'utilizzo outdoor.

Sfoderabilità: il rivestimento dei cuscini è completamente sfoderabile.

Scivolante protettivo in polietilene di colore Bronzo.

TAVOLINI

Struttura: tubolare di acciaio inox AISI 304 verniciato color Bronzo con finitura lucida anti-touch.

Piano: in massello di teak (Tectona Grandis - First European Quality), finitura naturale, spessore 60 mm, stabilizzato in forni di essiccazione. Lavorazione eseguita su macchina a controllo numerico, assemblaggio a 45° con incastri a pettine e bloccaggio tramite spinature.

Scivolante protettivo in polietilene di colore Bronzo.

Structure: upper frame and legs in tubular AISI 304 stainless steel varnished Bronze colour with polished anti-fingerprint finish. The steel structure is clad in woven polypropylene fiber that forms a 24x7 mm strip. The woven fiber comes in Ecru and Bronze colours. Frame in 60 mm thick solid teak (Tectona Grandis - First European Quality), natural finish, kiln-dried. Crafted on CNC machines, assembled at 45° with finger joints reinforced with dowel pins.

The daybed with reclinable backrest has a metal frame varnished Bronze colour with polished anti-fingerprint finish, upholstered in Batyline fabric.

Cushions: seat and backrest cushions in high-resilience polyurethane foam and eco-friendly, water-repellent fiber. In order to better protect the padding from water and humidity, all the cushions have a water repellent polyester cover. All the accessories - zips, yarn - are water repellent and therefore suitable for outdoor use.

Covers: completely removable cushion covers.

Bronze colour protective polyethylene glides.

COFFEE TABLES

Structure: in tubular AISI 304 stainless steel varnished Bronze colour with polished anti-fingerprint finish.

Top: in 60 mm thick solid teak (Tectona Grandis - First European Quality), natural finish, kiln-dried.

Crafted on CNC machines, assembled at 45° with finger joints reinforced with dowel pins. Bronze colour protective polyethylene glides.

Gestell: Obergestell und Untergestell aus Edelstahlrohr AISI 304 mit Lackierung in der Farbe Bronze mit glänzender Anti-Touch Oberfläche. Das Stahlgestell ist mit einem geflochtenen Propylengarn bezogen, das ein 24x7 mm großes Band formt. Das Garn ist in den Farben Ecru und Bronze verfügbar. Rahmen aus massivem Teakholz (Tectona Grandis - First European Quality) mit naturbelassener Oberfläche, Stärke 60 mm, im Trocknungssofen stabilisiert. Die Verarbeitung erfolgt auf Maschinen mit CNC-Steuerung und Zusammenbau im 45°-Winkel mit Fingerzinken und Blockierung über Dübelverbindungen.

Das Daybed mit verstellbarer Rückenlehne hat Metallrahmen mit Lackierung in der Farbe Bronze mit glänzender Anti-Touch Oberfläche und Batyline Stoffbezug.

Kissen: Sitzkissen und Rückenkissen aus hochwiderstandsfähigem PU-Schaum und umweltfreundlicher, wasserabweisender Faser. Zum Schutz der Polsterung vor Wasser und Feuchtigkeit verfügen alle Kissen über einen Polyesterbezug mit wasserabweisender Behandlung.

Alle für die Konfektionierung verwendeten Accessoires (Reißverschlüsse, Garn) sind wasserabweisend und daher für den Outdoor-Bereich geeignet. **Abziehbarkeit:** Die Kissenbezüge sind komplett abziehbar. Schutzgleiter aus Polyethylen in der Farbe Bronze.

BEISTELLTISCHE
Gestell: aus Edelstahlrohr AISI 304 mit Lackierung in der Farbe Bronze mit glänzender Anti-Touch Oberfläche.

Platte: aus massivem Teakholz (Tectona Grandis - First European Quality) mit naturbelassener Oberfläche, Stärke 60 mm, im Trocknungssofen stabilisiert. Die Verarbeitung erfolgt auf Maschinen mit CNC-Steuerung und Zusammenbau im 45°-Winkel mit Fingerzinken und Blockierung über Dübelverbindungen. Schutzgleiter aus Polyethylen in der Farbe Bronze.

Structure : châssis supérieur et piètement en tubes d'acier inox AISI 304 laqué de couleur Bronze finition brillante anti-traces de doigt. La structure en acier est recouverte d'un fil de polypropylène tressé qui forme un ruban de 24x7 mm. Le fil est disponible dans les couleurs Ecru et Bronze.

Cadre en teck massif (Tectona Grandis - First European Quality), finition naturelle, 60 mm d'épaisseur, stabilisé dans des fours de séchage. Usinage réalisé sur des machines à commande numérique, assemblage à 45° à queues droites et fixation par tourillons.

Le lit de repos avec dossier inclinable a un châssis en métal peint de couleur Bronze finition brillante anti-traces de doigt, recouvert de tissu Batyline.

Coussins : coussins d'assise et de dossier en polyuréthane expansé haute résilience et viscofibres hydrofuge écologique. Afin d'améliorer la protection des rembourrages contre l'eau et l'humidité, tous les coussins sont recouverts d'une housse en polyester avec traitement déperlant. Tous les accessoires utilisés pour la confection - fermetures à glissière, fil - sont hydrofuges et donc adaptés à une utilisation en extérieur.

Déhoussage : le revêtement des coussins est entièrement déhoussable.

Patins glisseurs en polyéthylène de couleur Bronze.

PETITES TABLES

Structure : en tubes d'acier inox AISI 304 laqué de couleur Bronze finition brillante anti-traces de doigt.

Plateau : en teck massif (Tectona Grandis - First European Quality), finition naturelle, 60 mm d'épaisseur, stabilisé dans des fours de séchage. Usinage réalisé sur des machines à commande numérique, assemblage à 45° à queues droites et fixation par tourillons.

Patins glisseurs en polyéthylène de couleur Bronze.

TAVOLINI | COFFEE TABLES

STRUTTURA E GAMBE
STRUCTURE AND LEGS

RIVESTIMENTO STRUTTURA
STRUCTURE COVER

BASE
BASE

PIANO
TOP

GAMBE
LEGS

ACCIAIO
STEEL

FILATO IN POLIPROPILENE
POLYPROPYLENE FIBER

LEGNO
WOOD

LEGNO
WOOD

ACCIAIO
STEEL

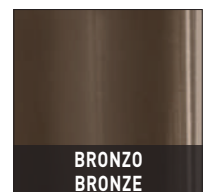
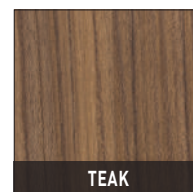
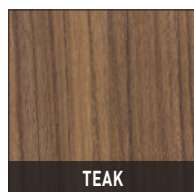
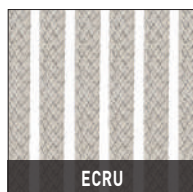
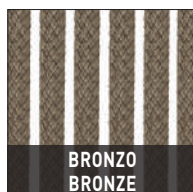
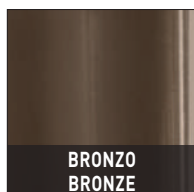

Minotti

POLTRONA | ARMCHAIR

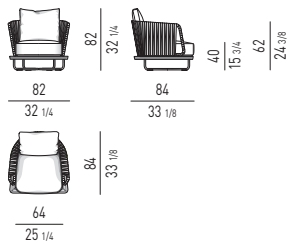

DIVANI | SOFAS

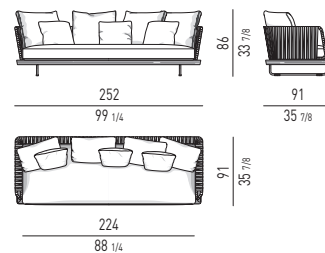
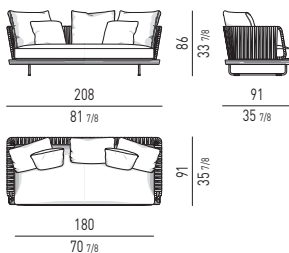
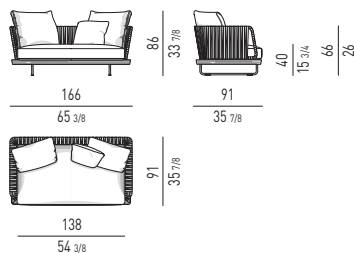

DIVANI INCLINATI | INCLINED SOFAS

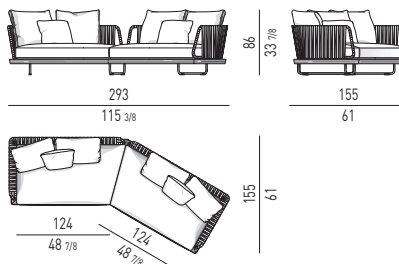
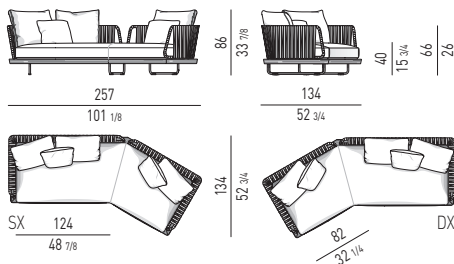

ELEMENTI TERMINALI | ELEMENTS WITH 1 ARMREST

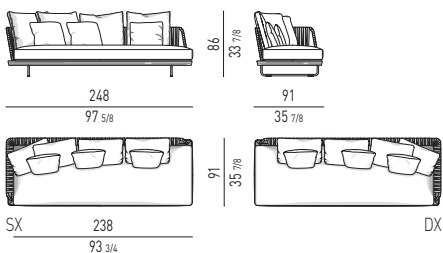
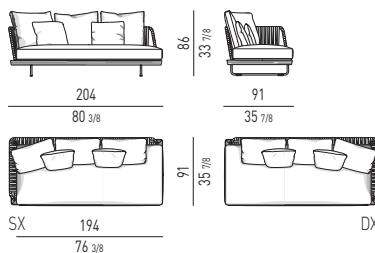
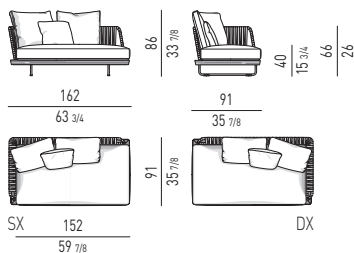

ELEMENTI TERMINALI PENISOLA | OPEN-END ELEMENTS WITH 1 ARMREST

ELEMENTO TERMINALE PENISOLA CM 162 - SCHIENALE CM 110
OPEN-END ELEMENT WITH 1 ARMREST CM 162 - BACKREST CM 110

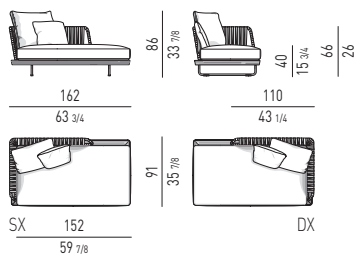

ELEMENTO TERMINALE PENISOLA CM 204 - SCHIENALE CM 110
OPEN-END ELEMENT WITH 1 ARMREST CM 204 - BACKREST CM 110

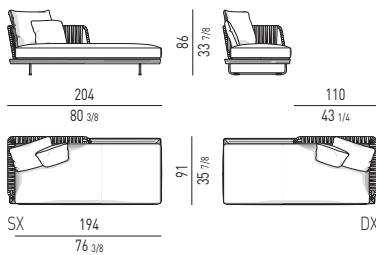

ELEMENTO TERMINALE PENISOLA CM 204 - SCHIENALE CM 154
OPEN-END ELEMENT WITH 1 ARMREST CM 204 - BACKREST CM 154

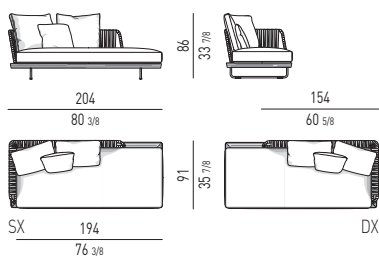

ELEMENTO TERMINALE PENISOLA CM 248 - SCHIENALE CM 154
OPEN-END ELEMENT WITH 1 ARMREST CM 248 - BACKREST CM 154

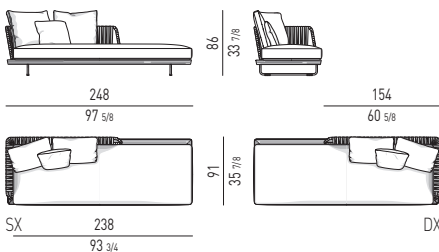

ELEMENTO TERMINALE PENISOLA CM 248 - SCHIENALE CM 197
OPEN-END ELEMENT WITH 1 ARMREST CM 248 - BACKREST CM 197

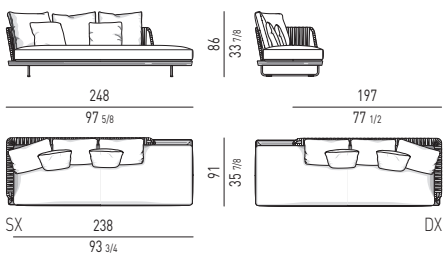

ELEMENTO TERMINALE CON TOP SMALL CM 162
ELEMENT WITH 1 ARMREST AND TOP SMALL CM 162

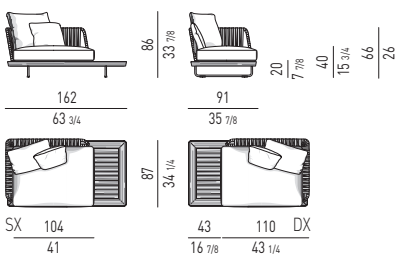

ELEMENTO TERMINALE CON TOP SMALL CM 204
ELEMENT WITH 1 ARMREST AND TOP SMALL CM 204

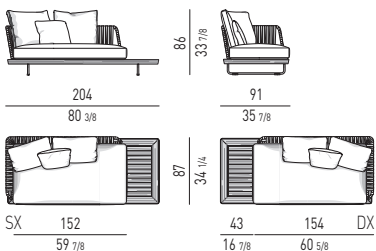

ELEMENTO TERMINALE CON TOP LARGE CM 204
ELEMENT WITH 1 ARMREST AND TOP LARGE CM 204

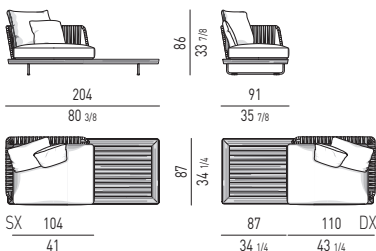

Minotti

ELEMENTO TERMINALE CON **TOP SMALL CM 248**
ELEMENT WITH 1 ARMREST AND **TOP SMALL CM 248**

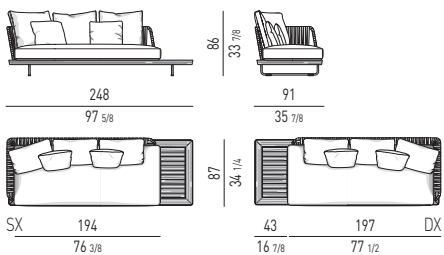

ELEMENTO TERMINALE CON **TOP LARGE CM 248**
ELEMENT WITH 1 ARMREST AND **TOP LARGE CM 248**

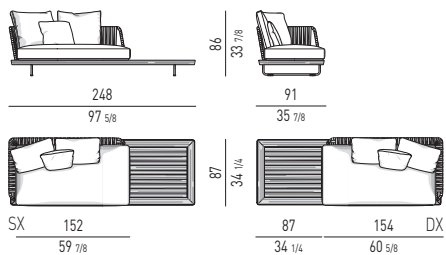

CHAISE-LONGUE

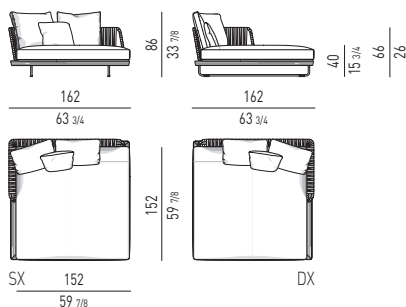

LOVESEAT

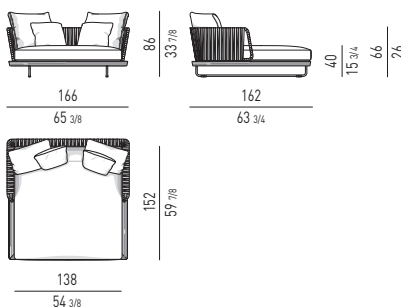

DAYBED CON SCHIENALE RECLINABILE | DAYBED WITH RECLINING BACKREST

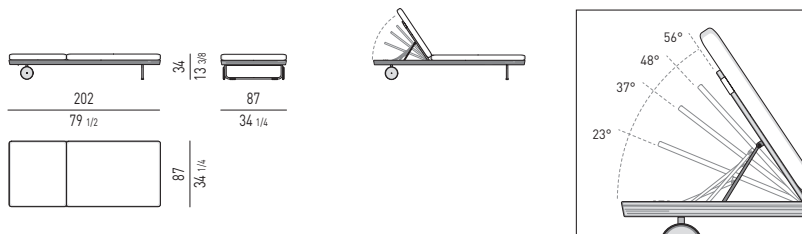

CUSCINO SCHIENALE OPTIONAL OPTIONAL BACKREST CUSHION

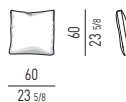

CUSCINO OPTIONAL OPTIONAL CUSHION

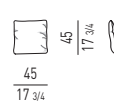

TAVOLINI | COFFEE TABLES

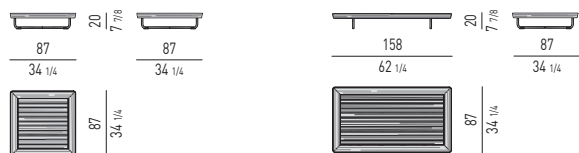

OPTIONAL RAIN COVER



Disponibile per ogni elemento
Available for each element



LA BASE STRUTTURALE IN LEGNO MASSELLO DI TEAK, SU CUI POGGIA LA CUSCINATURA, È RIFINITA CON GRANDE CURA.
GREAT CARE WAS TAKEN IN THE REFINEMENT OF THE STRUCTURAL BASE IN SOLID TEAK WOOD, ON WHICH THE CUSHIONS REST.

I colori stampati sono da considerarsi puramente indicativi | Printed colors are to be considered as purely indicative

Copyright © Minotti SpA 2020 - All rights reserved