

BRASILIA BED CONFIGURATION

1 SCEGLIERE IL **SOMMIER** E LA **TESTATA** CHOOSE THE **SOMMIER** AND **HEADBOARD**

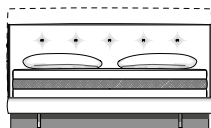

SOMMIER CM 169X230
(MATERASSO | MATTRESS CM 160X200)

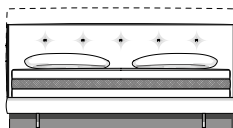

SOMMIER CM 189X230
(MATERASSO | MATTRESS CM 180X200)

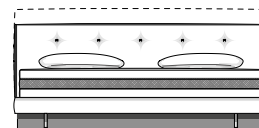

SOMMIER CM 209X230
(MATERASSO | MATTRESS CM 200X200)

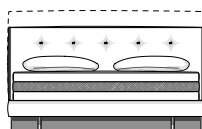

QUEEN SIZE
SOMMIER CM 162X233
(MATERASSO | MATTRESS CM 153X203)

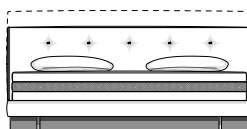

KING SIZE
SOMMIER CM 202X233
(MATERASSO | MATTRESS CM 193X203)

2 SCEGLIERE GLI ELEMENTI (**LARGE O SMALL**) PER LA PARTE **DX** E **SX** DELLA TESTATA LETTO CHOOSE THE **DX** AND **SX** ELEMENTS (**LARGE OR SMALL**) TO PAIR WITH THE HEADBOARD

NB: THE NUMBER OF SLATS SHOWN IN THE DRAWINGS IS PURELY INDICATIVE.

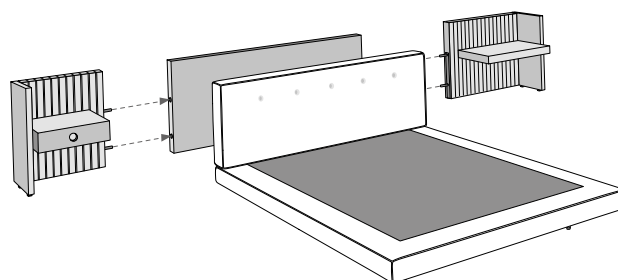
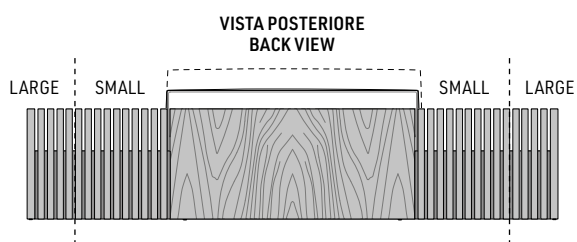
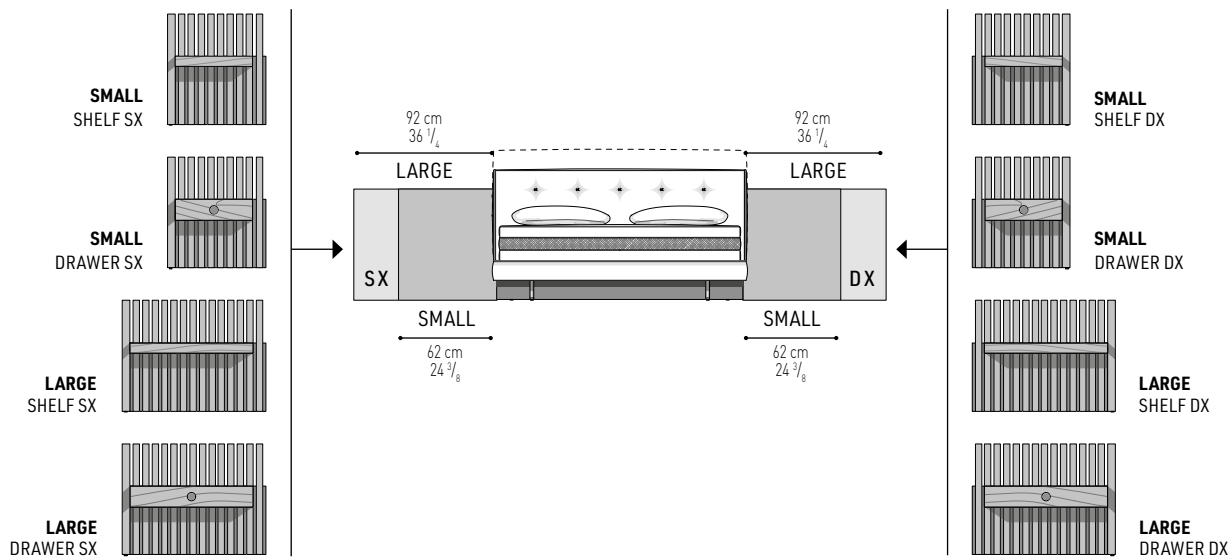

POSSIBLE CONFIGURATIONS (SOMMIER CM 169X230)

SYMMETRIC HEADBOARDS

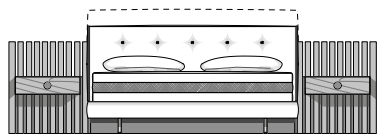

SMALL
DRAWER SX

SMALL
DRAWER DX

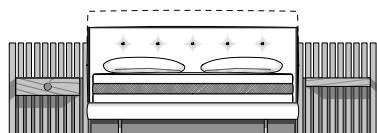

SMALL
DRAWER SX

SMALL
SHELF DX

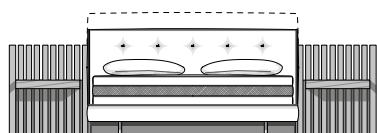

SMALL
SHELF SX

SMALL
SHELF DX

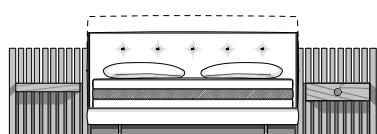

SMALL
SHELF SX

SMALL
DRAWER DX

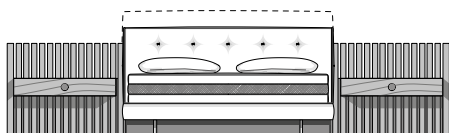

LARGE
DRAWER SX

LARGE
DRAWER DX

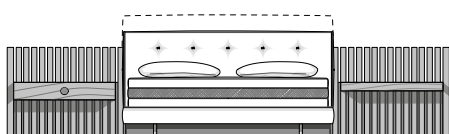

LARGE
DRAWER SX

LARGE
SHELF DX

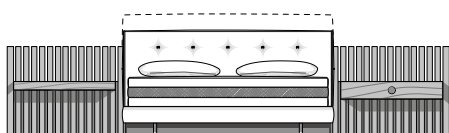

LARGE
SHELF SX

LARGE
DRAWER DX

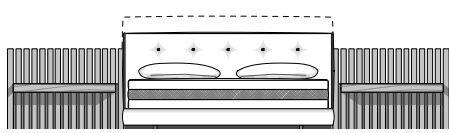

LARGE
SHELF SX

LARGE
SHELF DX

ASYMMETRIC HEADBOARDS

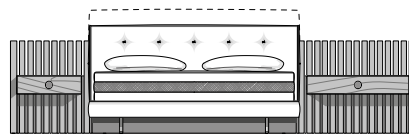

SMALL
DRAWER SX

LARGE
DRAWER DX

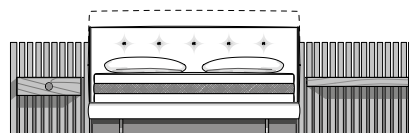

SMALL
DRAWER SX

LARGE
SHELF DX

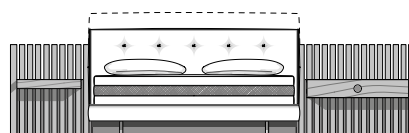

SMALL
SHELF SX

LARGE
DRAWER DX

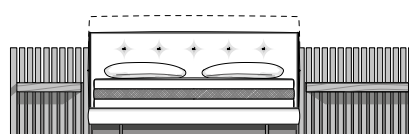

SMALL
SHELF SX

LARGE
SHELF DX

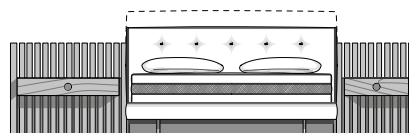

LARGE
DRAWER SX

SMALL
DRAWER DX

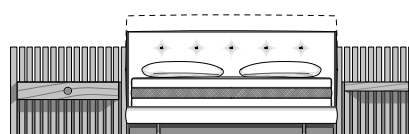

LARGE
DRAWER SX

SMALL
SHELF DX

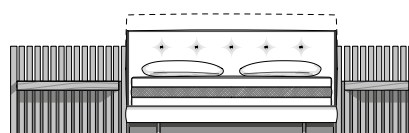

LARGE
SHELF SX

SMALL
SHELF DX

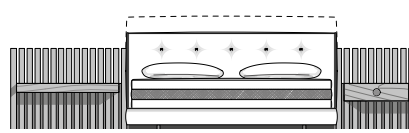

LARGE
SHELF SX

SMALL
DRAWER DX

BED DIMENSIONS: HEADBOARD + ADDITIONAL ELEMENTS

SOMMIER CM 169X230 (MATERASSO | MATTRESS CM 160X200)

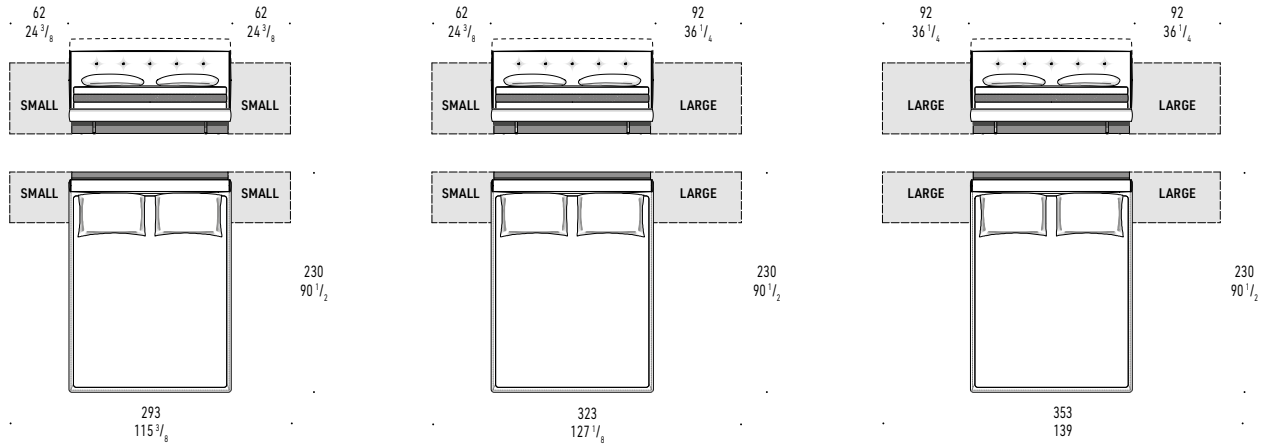

SOMMIER CM 189X230 (MATERASSO | MATTRESS CM 180X200)

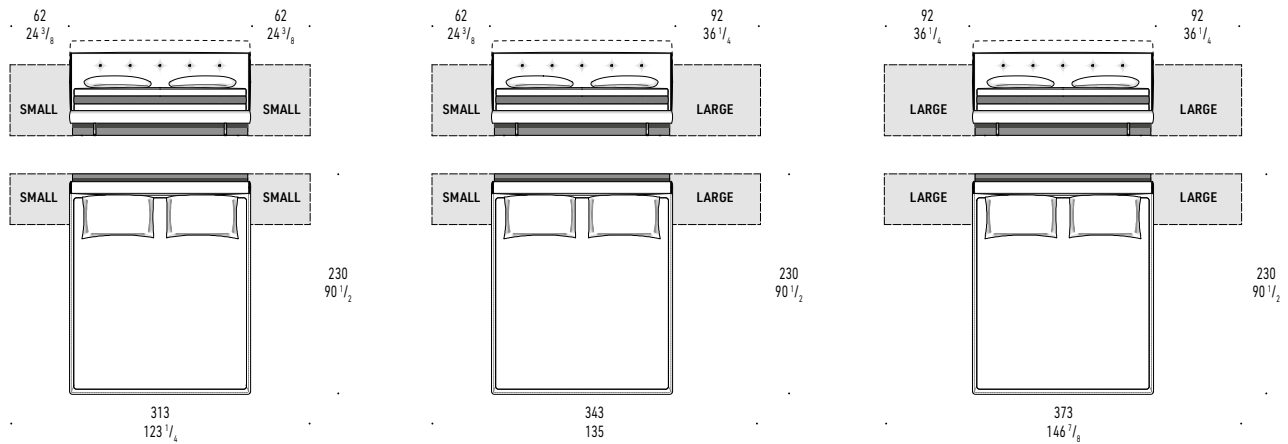

SOMMIER CM 209X230 (MATERASSO | MATTRESS CM 200X200)

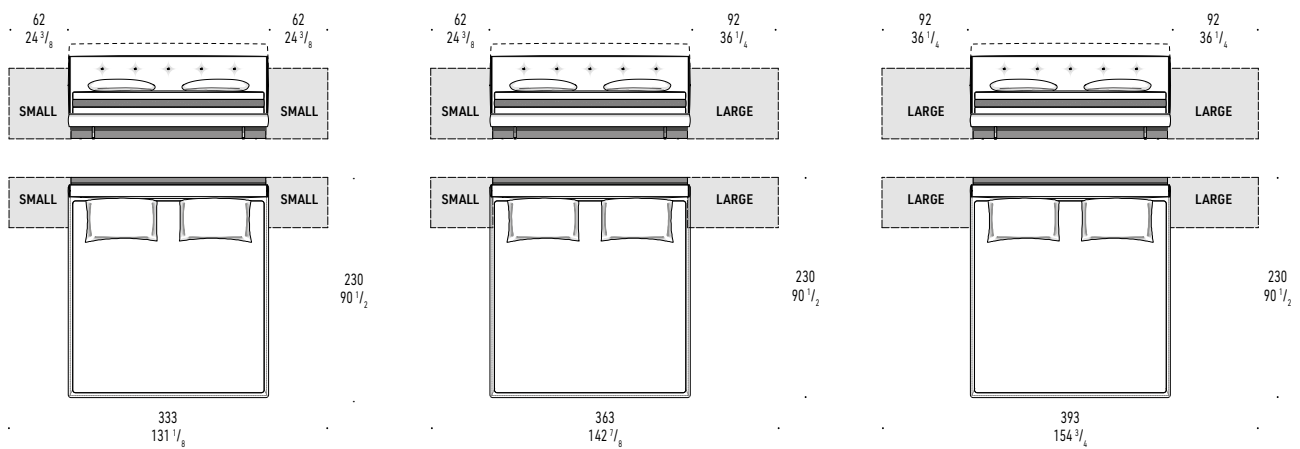

SOMMIER CM 162X233 - QUEEN SIZE (MATERASSO | MATTRESS CM 153X203)

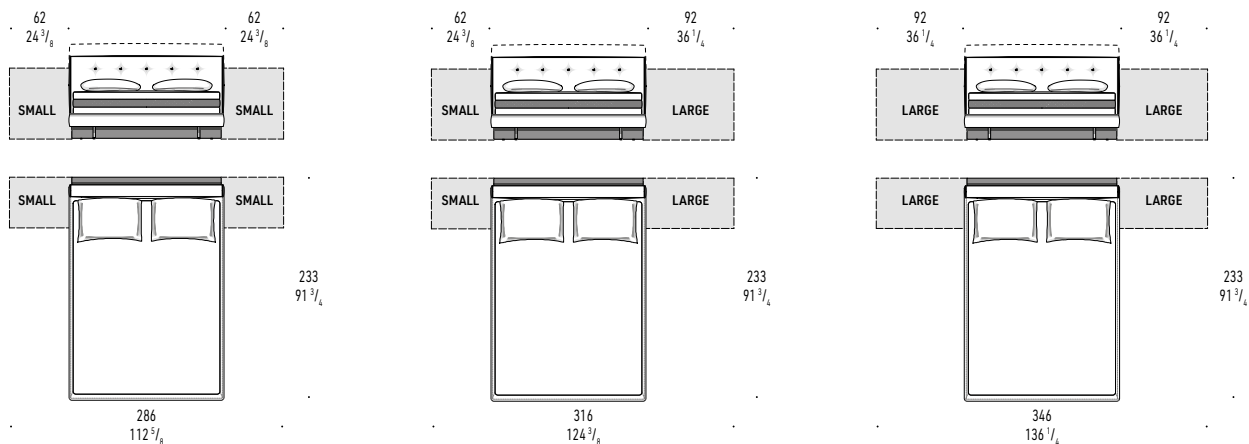

SOMMIER CM 202X233 - KING SIZE (MATERASSO | MATTRESS CM 193X203)

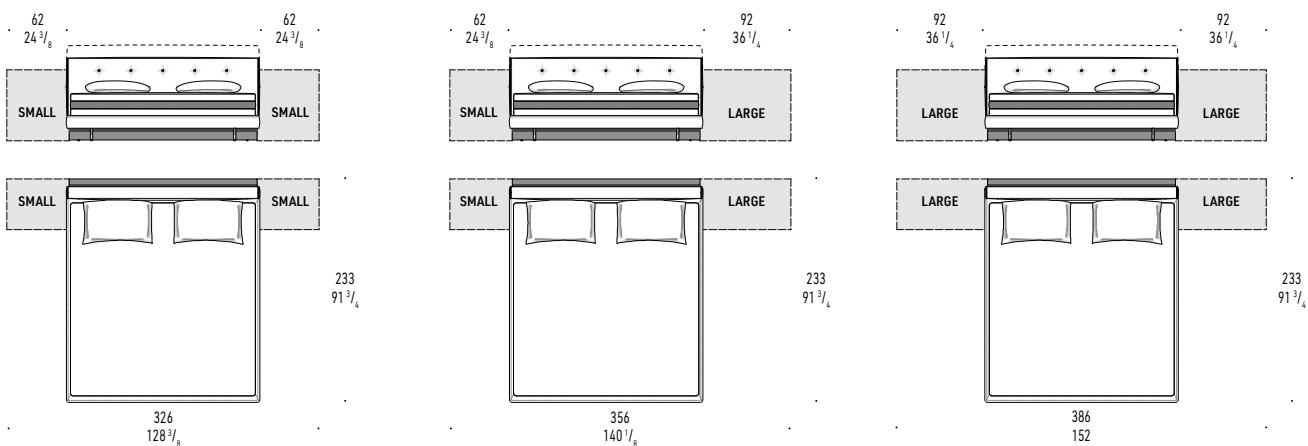

SOMMIER CM 169X230 / SOMMIER CM 189X230 / SOMMIER CM 209X230 / SOMMIER CM 162X233 - QUEEN SIZE / SOMMIER CM 202X233 - KING SIZE

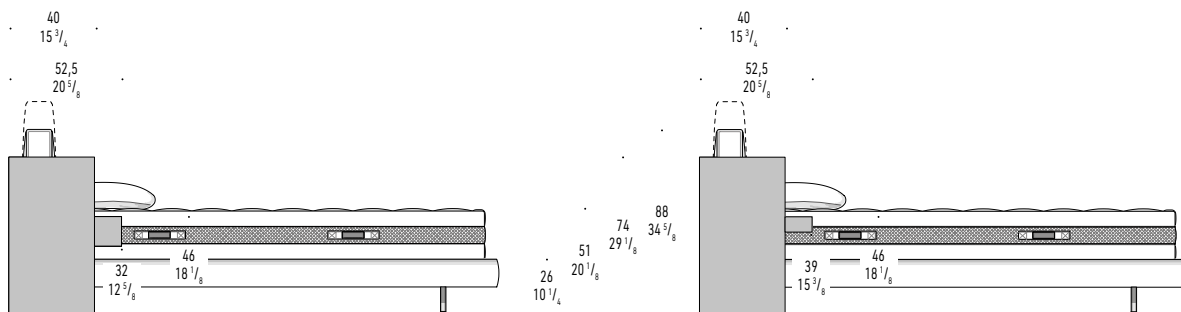

ELEMENTO CON CASSETTO
ELEMENT WITH DRAWER

ELEMENTO CON RIPIANO
ELEMENT WITH SHELF



Struttura: giroletto monoscocca autoportante in legno multistrato di forte spessore. Il giroletto è progettato per accogliere al suo interno molle insacchettate ricoperte in superficie da uno strato di poliuretano espanso ad alta resilienza (esente da CF). Un pannello di legno multistrato forato, posto alla base delle molle, agevola l'aerazione.

Ulteriore rivestimento in tessuto tecnico traforato nella parte superiore del giroletto, che permette una maggiore traspirazione della struttura a molle.

Testata in legno multistrato, imbottita con poliuretano espanso a quote differenziate ad alta densità.

Giroletto e testata rivestiti con fibra termolegata ed accoppiata con tela di cotone bianca che conferisce morbidezza e soffici ta alle imbottiture isolandole dal tessuto, garantendo igiene al prodotto.

La confezione della fodera della testata imbottita   impreziosita da impunture.

Sfoderabilit : rivestimento completamente sfoderabile in tessuto o pelle. Per facilitare la rimozione delle fodere,   possibile sfilare la testata dal giroletto agendo sulle manopole poste sul suo fondo.

Piedi: realizzati con barre piene di metallo satinato,   mm 25, verniciato color Brandy lucido, con puntale in metallo verniciato color Brandy lucido. Scivolanti regolabili in polietilene di colore nero.

N.B.: data la struttura del letto, non   possibile inserire la rete e regolare l'altezza del materasso.

BRASILIA BED

Testata attrezzata

- versione Palissandro Santos* tinto Dark Brown: testata composta da un elemento centrale in tamburato di MDF, spessore mm 81, impiallacciato palissandro Santos* tinto Dark Brown, laccato poliesteropaco, al quale viene agganciata la testata imbottita. Fianchi, cassetti (finitura interna ed esterna) e mensole in MDF impiallacciato palissandro Santos* tinto Dark Brown, laccato poliesteropaco.

Doghe in MDF, sezione mm 81x21, impiallacciato palissandro Santos* tinto Dark Brown, laccato poliesteropaco. Le doghe sono unite tra di loro attraverso barre di alluminio. Cassetti che scorrono su guide a estrazione totale con chiusura Blumotion.

Maniglie in alluminio verniciato lucido color Brandy.

Appoggio a terra mezzo piedini livellatori in ABS.

Structure: one-piece free-standing bed frame in very thick plywood. The bed frame is designed to accommodate pocket springs covered with a surface layer of high-resilience (CF-free) polyurethane foam.

A perforated plywood panel, placed under the springs, facilitates air circulation.

An additional perforated technical fabric covering on the upper part of the bed frame allows greater circulation of air throughout the spring structure.

Headboard in plywood, padded with high-resilience, variable-density polyurethane foam.

Bed frame and headboard are then covered with heat-bonded fibre laminated to white cotton fabric that lends a soft fluffiness to the padding while isolating it from the fabric, ensuring the product is hygienic.

The padded headboard upholstery is embellished with top-stitching.

Covers: completely removable fabric or leather upholstery. To facilitate upholstery removal, the headboard can be lifted out of the bed frame by means of the handles located at the bottom.

Feet: made of 25 mm   satin-finish solid metal rods, varnished polished Brandy colour, with varnished polished Brandy colour metal tip.

Adjustable black polyethylene glides.

N.B.: given the architecture of the bed, it is not possible to insert a slatted base or adjust mattress height.

BRASILIA BED

Accessorized headboard

- in Palissander Santos*, with Dark Brown stained veneer: headboard made up of a central element in 81mm-thick honeycomb MDF, with palissander Santos* veneer, stained Dark Brown and polyester matt lacquer finish, to which the headboard is attached.

Sides, drawers (finished inside and out) and shelves in MDF with palissander Santos* veneer stained Dark Brown and polyester matt lacquer finish.

MDF slats measuring 81x21mm, with palissander Santos* veneer stained Dark Brown and polyester matt lacquer finish. The slats are held together with aluminium rods.

Drawers glide on full-extension runners with Blumotion closure. Aluminium handles with varnished polished Brandy colour finish.

Rests on levelling feet in ABS.

Gestell: Selbsttragender, einteiliger Bettrahmen aus starkem Sperrholz. Der Bettrahmen ist f r die Aufnahme von Taschenfederkernen ausgelegt, die an der Oberfl che mit einer Schicht aus hochelastischem Polyurethanschaum (CF-frei) abgedeckt sind.

Eine perforierte Sperrholzplatte an der Basis der Federn erleichtert die Bel ftung.

Zus tzliche Abdeckung aus perforiertem technischem Gewebe im oberen Teil des Bettrahmens, die eine gr oere Atmungsaktivit t der Federstruktur erm glicht. Kopfteil aus Sperrholz, gepolstert mit PU-Schaum mit differenzierter, hoher Dichte.

Bettrahmen und Kopfteil gepolstert mit atmungsaktiver, thermobondierter Faser kombiniert mit weiem Baumwollstoff, der den Polsterungen Weichheit verleiht und sie von dem Gewebe isoliert, so dass die Produkthygiene garantiert wird.

Die Konfektionierung des Bezugs wird von Steppn hten aufgewertet.

Abziehbarkeit: der Bezug ist komplett abziehbar, sowohl in der Version mit Stoffbezug als auch mit Lederbezug. Um das Abziehen der Bez ge zu erleichtern, ist es m glich, das Kopfteil durch Drehen der Kn pfe an der Unterseite vom Bettrahmen zu entfernen.

Fue: aus satiniertem Metallprofil mit   mm 25 mm und gl nzender Lackierung in der Farbe Brandy mit Gleiter aus lackiertem Metall in der Farbe Brandy gl nzend.

Gleiter aus Polyethylen in Schwarz.

N.B.: Aufgrund des Bettaufbaus ist es nicht m glich, den Lattenrost einzusetzen und die H he der Matratze zu verstellen.

BRASILIA BED

Kopfteil mit ausstattung

- Ausf hrung Santos-Palissander* Dark Brown gebeizt: Kopfteil bestehend aus einem zentralen Element aus verst rker MDF-Wabenplatte, St rke 81 mm, furniert mit Palissander Santos* Dark Brown gebeizt, mit matter Polyesterlackierung, an dem das gepolsterte Kopfteil befestigt wird.

Seiten, Schubladen (Innen- und Auenseite) sowie Regale aus MDF, furniert mit Palissander Santos* Dark Brown gebeizt, mit matter Polyesterlackierung.

Latten aus MDF, Profil 81x21 mm, furniert mit Palissander Santos* Dark Brown gebeizt mit matter Polyesterlackierung.

Die Latten sind durch Aluminiumstreben miteinander verbunden.

Die Schubladen laufen auf F hrungen mit Vollauszug und Blumotion-Verschluss.

Griffe aus Aluminium mit gl nzender Lackierung in der Farbe Brandy. Untergestell mit verstellbaren F en aus ABS.

Structure : cadre de lit mono-coque autoportant en multiplis de forte  paisseur. Le cadre de lit est conu pour accueillir des ressorts ensach s recouverts en surface d'une couche de mousse de polyur thane haute r silience (sans CF).

La ventilation est facilit e par un panneau de multiplis perfor , plac    la base des ressorts.

Dans la partie sup rieure du cadre de lit, un rev tement suppl mentaire en tissu technique perfor  permet une meilleure a ration de la structure   ressorts.

T te de lit en multiplis, rembourr e de mousse de polyur thane   densit  diff renci e haute r silience.

Cadre et t te de lit recouverts de fibre thermol e et coll e   de la toile de coton blanc qui apporte de la souplesse et du moelleux aux rembourrages en les isolant du tissu, assurant ainsi une bonne hygi ne.

La confection de la housse de la t te de lit rembourr e est agr ment e de surpiques.

D houssage : rev tement enti rement d houssable en tissu comme en cuir.

Pour faciliter le retrait des housses, retirer la t te du cadre de lit en agissant sur les poign es situ es sur le fond.

Pieds : r alis s avec des barres pleines en m tal satin ,   mm 25 mm, peint brillant couleur Brandy, avec embout en m tal peint brillant couleur Brandy. Patins glisseurs r glables en poly thyl ne noir.

N.B. : compte tenu de la structure du lit, il n'est pas possible d'ins rer le sommier et de r gler la hauteur du matelas.

BRASILIA BED

T te de lit  quip e

- version Palissandre Santos* teint  Dark Brown : t te de lit compos e d'un  l ment central en nid d'abeille de MDF,  paisseur 81 mm, plaqu  palissandre de Santos* teint  Dark Brown, laqu  polyester mat, auquel est fix e la t te de lit rembourr e.

Flancs, tiroirs (finition int rieure et ext rieure) et  tag res en MDF plaqu  palissandre de Santos* teint  Dark Brown, laqu  polyester mat.

Lattes en MDF, section 81x21 mm, plaqu  palissandre de Santos* teint  Dark Brown, laqu  polyester mat.

Les lattes sont reli es entre elles par des barres en aluminium.

Les tiroirs coulissent sur des glissieres   extension compl te avec fermeture Blumotion.

Poign es en aluminium peint brillant couleur Brandy.

Appui au sol au moyen de pieds niveleurs en ABS.

Minotti

- versione rovere tinto Miele: testata composta da un elemento centrale in tamburato di MDF, spessore mm 81, impiallacciato in rovere tinto a poro aperto color Miele, al quale viene agganciata la testata imbottita. Fianchi, cassetti (finitura interna ed esterna) e mensole in MDF impiallacciato in rovere tinto a poro aperto color Miele. Doghe in MDF, sezione mm 81x21, impiallacciato in rovere tinto a poro aperto color Miele. Le doghe sono unite tra di loro attraverso barre di alluminio. Cassetti che scorrono su guide a estrazione totale con chiusura Blumotion. Maniglie in alluminio verniciato lucido color Brandy. Appoggio a terra mezzo piedini livellatori in ABS.

La testata del letto e gli accessori complementari non necessitano di alcun fissaggio a parete.

*** il palissandro Santos deriva da foreste correttamente gestite.**

- in oak, with honey stained veneer: headboard made up of a central element in 81 mm-thick honeycomb MDF, with a Honey stained open pore oak veneer, to which the headboard is attached. Sides, drawers (finished inside and out) and shelves in MDF with Honey stained open pore oak veneer. MDF slats measuring 81x21 mm, with Honey stained open pore oak veneer. The slats are held together with aluminium rods. Drawers glide on full-extension runners with Blumotion closure. Aluminium handles with varnished polished Brandy colour finish. Rests on levelling feet in ABS.

The headboard and the accessories don't require any wall anchoring.

*** palisander Santos comes from properly managed forests.**

- Ausführung Eiche honigfarben: Kopfteil bestehend aus einem zentralen Element aus verstärkter MDF-Wabenplatte, Stärke 81 mm, furniert mit offenerporiger, honigfarbener gebeizter Eiche, an dem das gepolsterte Kopfteil befestigt wird. Seiten, Schubladen (Innen- und Außenseite) sowie Regale aus MDF, furniert mit honigfarbener, offenerporiger gebeizter Eiche. Die Latten aus MDF, Profil 81x21 mm, furniert in honigfarbener, offenerporiger gebeizter Eiche. Die Latten sind durch Aluminiumstreben miteinander verbunden. Die Schubladen laufen auf Führungen mit Vollauszug und Blumotion-Verschluss. Die Griffe aus Aluminium mit glänzender Lackierung in der Farbe Brandy. Untergestell mit verstellbaren Füßen aus ABS.

Der Bettkopfteil und die Zubehörteile benötigen keine Wandbefestigung.

*** Palisander Santos stammt aus korrekt bewirtschafteten Wäldern.**

- version chêne teinté Miel : tête de lit composée d'un élément central en nid d'abeille de MDF, épaisseur 81 mm, plaqué en chêne teinté à pore ouvert de couleur Miel, auquel est fixée la tête de lit rembourrée. Flancs, tiroirs (finition intérieure et extérieure) et étagères en MDF plaqué chêne teinté à pore ouvert de couleur Miel. Lattes en MDF, section 81x21 mm, plaqué en chêne teinté à pore ouvert de couleur Miel. Les lattes sont reliées entre elles par des barres en aluminium. Les tiroirs coulissent sur des glissières à extension complète avec fermeture Blumotion. Poignées en aluminium peint brillant couleur Brandy. Appui au sol au moyen de pieds niveleurs en ABS.

La tête de lit et les accessoires complémentaires ne nécessitent aucune fixation murale.

*** le palissandre de Santos provient de forêts bien gérées.**

TESTATA / DOGHE / FIANCHI / MENSOLE / CASSETTI - INTERNI ED ESTERNI HEADBOARD / SLATS / SIDES / SHELVES / DRAWERS - INTERNAL AND EXTERNAL

PALISSANDRO SANTOS
PALISANDER SANTOS

ROVERE
OAK

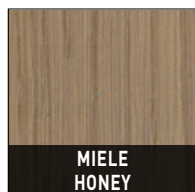
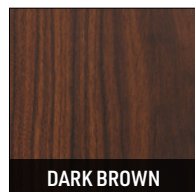

MANIGLIE | HANDLES

ALLUMINIO LUCIDO
POLISHED ALUMINIUM

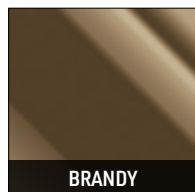

PIEDI | FEET

METALLO SATINATO
SATIN METAL

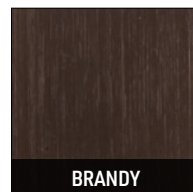

PUNTALE | TIP

METALLO LUCIDO
POLISHED METAL

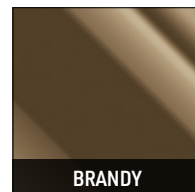

THE BOXSPRING TECHNOLOGY SOMMIER

La base del letto è costituita da un moderno sommier caratterizzato dalla presenza di molle insacchettate che, insieme al materasso "Comfort H20/25", favorisce un'elevata qualità del riposo notturno.

The base of the bed includes the modern base with pocket springs that, along with the "Comfort H20/25" mattress, promises an extremely restful night's sleep.

Das Bettgestell besteht aus einem modernen Polsterbett mit Taschenfedern, das gemeinsam mit der Matratze "Comfort H20/25" eine optimale Qualität des Nachtschlafs garantiert.

La base du lit est constituée d'un moderne sommier caractérisé par la présence de ressorts ensachés qui, alliés au matelas "Comfort H20/25", favorisent un sommeil de bonne qualité.

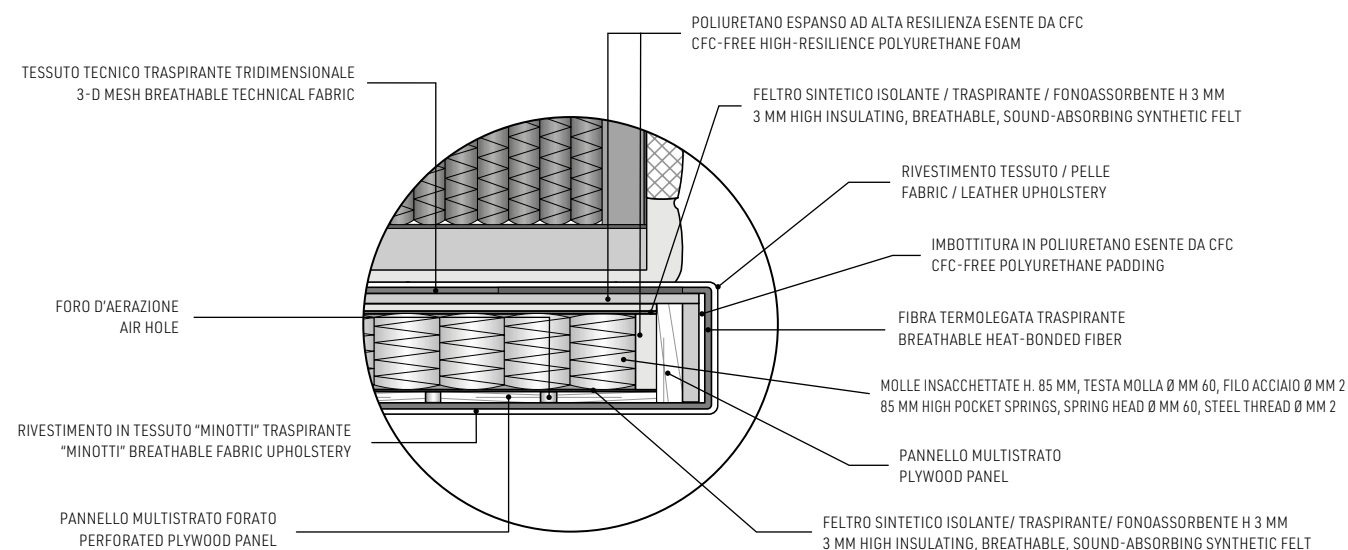
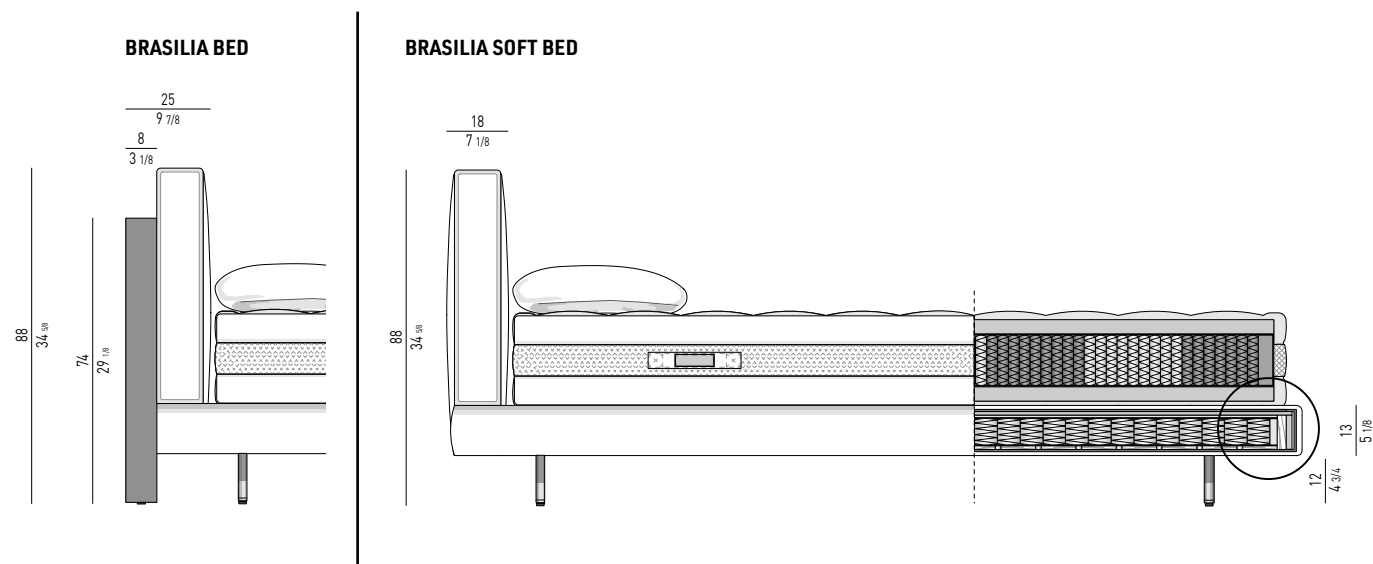

BRASILIA BED

SOMMIER DIVISO | TWO-PIECES SOMMIER

SOMMIER E TESTATA CM **169X230**
SOMMIER AND HEADBOARD CM **169X230**

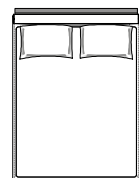
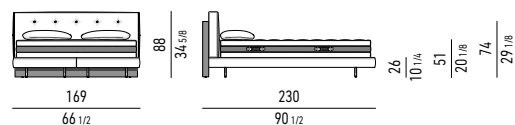

MATERASSO | MATTRESS:
CM 160X200 - 63 X 78 3/4

SOMMIER E TESTATA CM **189X230**
SOMMIER AND HEADBOARD CM **189X230**

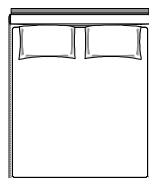
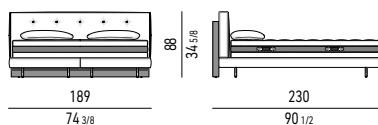

MATERASSO | MATTRESS:
CM 180X200 - 70 7/8 X 78 3/4

SOMMIER E TESTATA CM **209X230**
SOMMIER AND HEADBOARD CM **209X230**

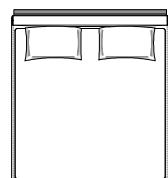
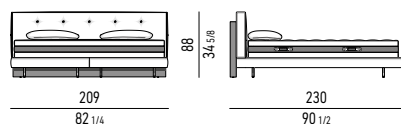

MATERASSO | MATTRESS:
CM 200X200 - 78 3/4 X 78 3/4

SOMMIER E TESTATA **QUEEN SIZE CM 162X233**
SOMMIER AND HEADBOARD **QUEEN SIZE CM 162X233**

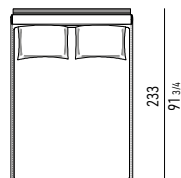
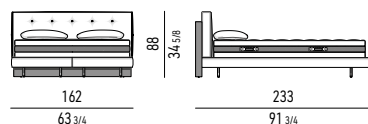

MATERASSO | MATTRESS:
CM 153X203 - 60 1/4 X 79 7/8

SOMMIER E TESTATA **KING SIZE CM 202X233**
SOMMIER AND HEADBOARD **KING SIZE CM 202X233**

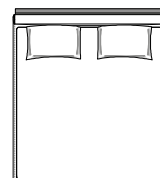
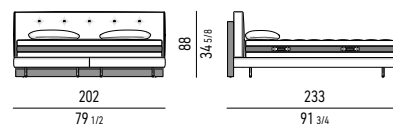

MATERASSO | MATTRESS:
CM 193X203 - 76 X 79 7/8

SOMMIER INTERO | ONE-PIECE SOMMIER

SOMMIER E TESTATA CM **169X230**
SOMMIER AND HEADBOARD CM **169X230**

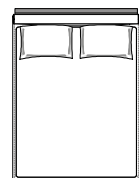
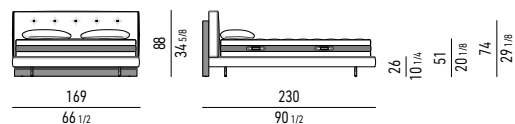

MATERASSO | MATTRESS:
CM 160X200 - 63 X 78 3/4

SOMMIER E TESTATA CM **189X230**
SOMMIER AND HEADBOARD CM **189X230**

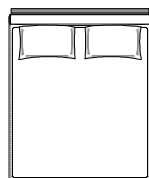
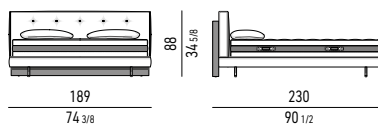

MATERASSO | MATTRESS:
CM 180X200 - 70 7/8 X 78 3/4

SOMMIER E TESTATA CM **209X230**
SOMMIER AND HEADBOARD CM **209X230**

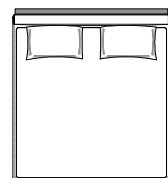
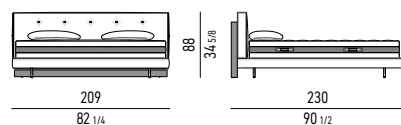

MATERASSO | MATTRESS:
CM 200X200 - 78 3/4 X 78 3/4

SOMMIER E TESTATA **QUEEN SIZE CM 162X233**
SOMMIER AND HEADBOARD **QUEEN SIZE CM 162X233**

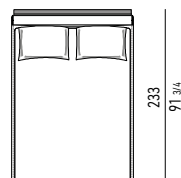
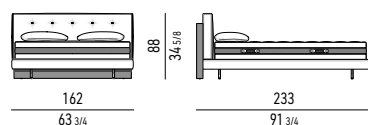

MATERASSO | MATTRESS:
CM 153X203 - 60 1/4 X 79 7/8

SOMMIER E TESTATA **KING SIZE CM 202X233**
SOMMIER AND HEADBOARD **KING SIZE CM 202X233**

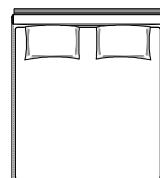
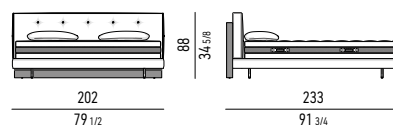

MATERASSO | MATTRESS:
CM 193X203 - 76 X 79 7/8

BRASILIA BED HIGH

SOMMIER DIVISO | TWO-PIECES SOMMIER

SOMMIER E TESTATA CM **169X230**
SOMMIER AND HEADBOARD CM **169X230**

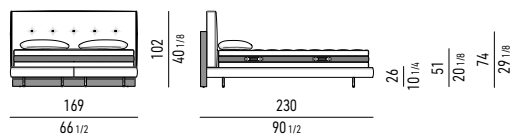

MATERASSO | MATTRESS:
CM 160X200 - 63 X 78 3/4

SOMMIER E TESTATA CM **189X230**
SOMMIER AND HEADBOARD CM **189X230**

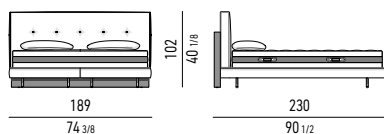

MATERASSO | MATTRESS:
CM 180X200 - 70 7/8 X 78 3/4

SOMMIER E TESTATA CM **209X230**
SOMMIER AND HEADBOARD CM **209X230**

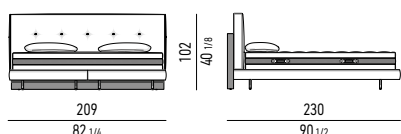

MATERASSO | MATTRESS:
CM 200X200 - 78 3/4 X 78 3/4

SOMMIER E TESTATA **QUEEN SIZE** CM **162X233**
SOMMIER AND HEADBOARD **QUEEN SIZE** CM **162X233**

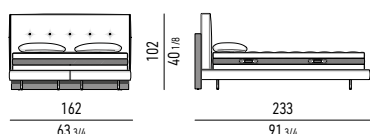

MATERASSO | MATTRESS:
CM 153X203 - 60 1/4 X 79 7/8

SOMMIER E TESTATA **KING SIZE** CM **202X233**
SOMMIER AND HEADBOARD **KING SIZE** CM **202X233**

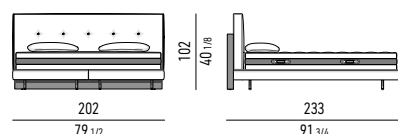

MATERASSO | MATTRESS:
CM 193X203 - 76 X 79 1/8

SOMMIER INTERO | ONE-PIECE SOMMIER

SOMMIER E TESTATA CM **169X230**
SOMMIER AND HEADBOARD CM **169X230**

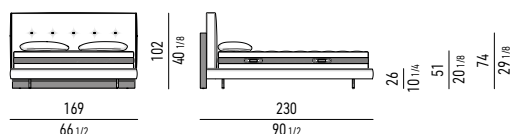

MATERASSO | MATTRESS:
CM 160X200 - 63 X 78 3/4

SOMMIER E TESTATA CM **189X230**
SOMMIER AND HEADBOARD CM **189X230**

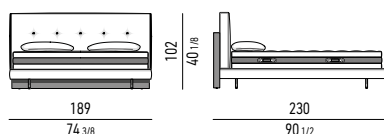

MATERASSO | MATTRESS:
CM 180X200 - 70 7/8 X 78 3/4

SOMMIER E TESTATA CM **209X230**
SOMMIER AND HEADBOARD CM **209X230**

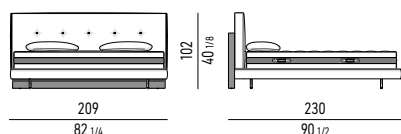

MATERASSO | MATTRESS:
CM 200X200 - 78 3/4 X 78 3/4

SOMMIER E TESTATA **QUEEN SIZE** CM **162X233**
SOMMIER AND HEADBOARD **QUEEN SIZE** CM **162X233**

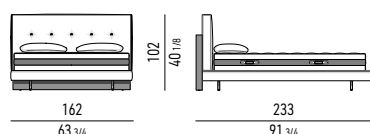

MATERASSO | MATTRESS:
CM 153X203 - 60 1/4 X 79 7/8

SOMMIER E TESTATA **KING SIZE** CM **202X233**
SOMMIER AND HEADBOARD **KING SIZE** CM **202X233**

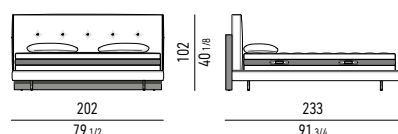

MATERASSO | MATTRESS:
CM 193X203 - 76 X 79 1/8

Minotti

SOMMIER

SOMMIER DIVISO | TWO-PIECES SOMMIER

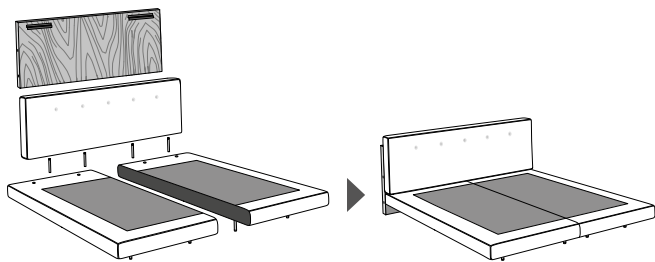

BRASILIA BED

Versione con sommier diviso in due elementi, al fine di facilitare la consegna. I due elementi si congiungono tra loro a mezzo di un'apposita cremagliera. La testata viene agganciata attraverso un sistema di innesto e sgancio rapido. I due elementi sommier vengono consegnati già rivestiti.

To facilitate delivery, a version with the sommier in two pieces is now available. The two pieces are joined by means of a special connecting device. The headboard is fastened through a quick set and release coupling system. The two sommier pieces are delivered with upholstery already in place.

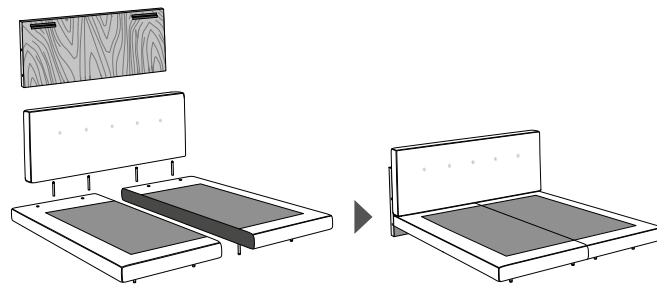

BRASILIA BED HIGH

Variante mit dem Sommier in zwei Teile zerlegt ist, um die Lieferung zu vereinfachen. Die beiden Elemente werden über ein spezifisches, zahnradähnliches Scharnier miteinander verbunden. Das Kopfteil wird mit einem schnellen Stecksystem am Gestell angebracht. Beide Sommier-Teile werden bereits bezogen geliefert.

Versión avec sommier divisé en deux parties afin de faciliter la livraison. Les deux parties s'encastrent à l'aide d'un système de fixation à crémaillère. La tête de lit se fixe à l'aide d'un mécanisme d'enclenchement et déclenchement rapide. Les deux parties du sommier sont livrées avec leur revêtement.

SOMMIER INTERO | ONE-PIECE SOMMIER

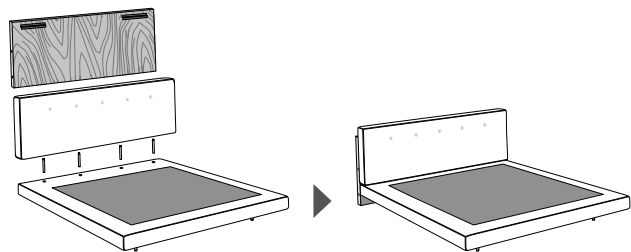

BRASILIA BED

La testata viene agganciata attraverso un sistema di innesto e sgancio rapido.

The headboard is fastened through a quick set and release coupling system.

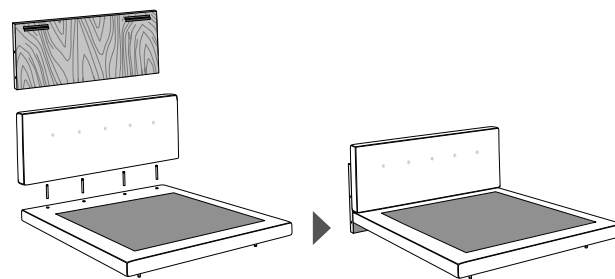

BRASILIA BED HIGH

Das Kopfteil wird mit einem schnellen Stecksystem am Gestell angebracht.

La tête de lit se fixe à l'aide d'un mécanisme d'enclenchement et déclenchement rapide.

ELEMENTI COMPLEMENTARI PER LA TESTATA | HEADBOARD ADDITIONAL ELEMENTS

ELEMENTO **SMALL** CON CASSETTO **SMALL** ELEMENT WITH DRAWER

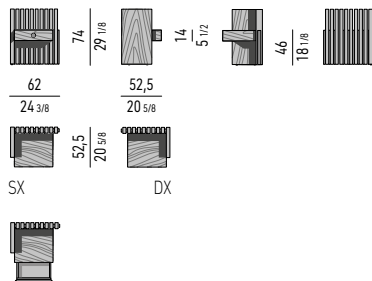

Cassetto che scorre su guide a estrazione totale con chiusura Blumotion.
Portata massima Kg 40.

Spazio utile interno cassetto: cm 39x31 H5

Drawer that glides on fully extractable guides with Blumotion soft-close system.
Maximum load is 40 Kg.

Drawer internal dimension: cm 39x31 H5

ELEMENTO **LARGE** CON CASSETTO **LARGE** ELEMENT WITH DRAWER

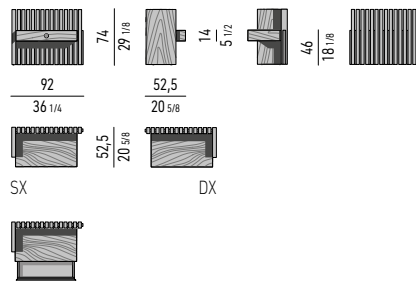

Cassetto che scorre su guide a estrazione totale con chiusura Blumotion.
Portata massima Kg 40.

Spazio utile interno cassetto: cm 69x31 H5

Drawer that glides on fully extractable guides with Blumotion soft-close system.
Maximum load is 40 Kg.

Drawer internal dimension: cm 69x31 H5

ELEMENTO **SMALL** CON RIPIANO **SMALL** ELEMENT WITH SHELF

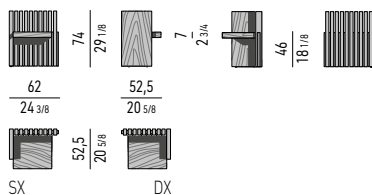

ELEMENTO **LARGE** CON RIPIANO **LARGE** ELEMENT WITH SHELF

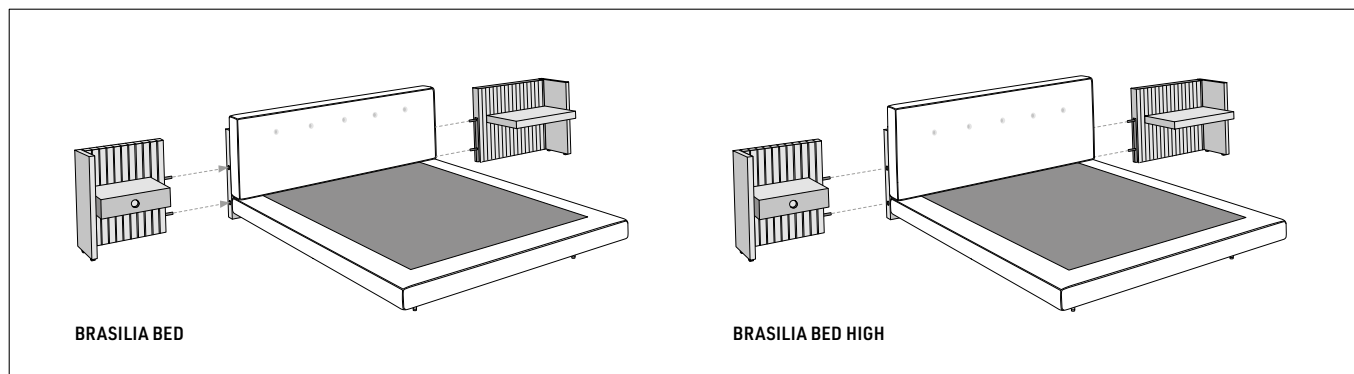
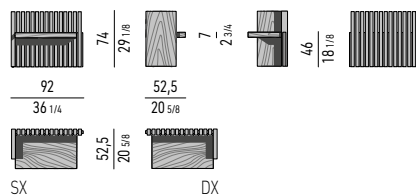

BRASILIA SOFT BED

SOMMIER DIVISO | TWO-PIECES SOMMIER

LETTO CM **169X223**
BED CM **169X223**

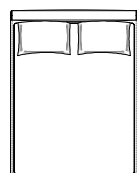
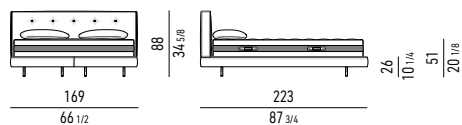

MATERASSO | MATTRESS:
CM 160X200 - 63 X 78 3/4

LETTO CM **189X223**
BED CM **189X223**

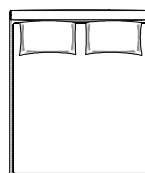
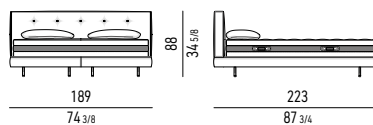

MATERASSO | MATTRESS:
CM 180X200 - 70 7/8 X 78 3/4

LETTO CM **209X223**
BED CM **209X223**

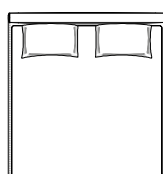
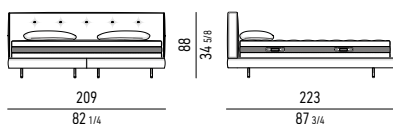

MATERASSO | MATTRESS:
CM 200X200 - 78 3/4 X 78 3/4

LETTO **QUEEN SIZE** CM **162X226**
BED **QUEEN SIZE** CM **162X226**

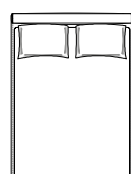
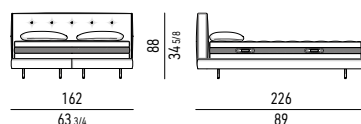

MATERASSO | MATTRESS:
CM 153X203 - 60 1/4 X 79 7/8

LETTO **KING SIZE** CM **202X226**
BED **KING SIZE** CM **202X226**

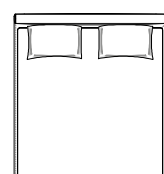
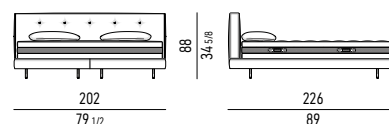

MATERASSO | MATTRESS:
CM 193X203 - 76 X 79 7/8

SOMMIER INTERO | ONE-PIECE SOMMIER

LETTO CM **169X223**
BED CM **169X223**

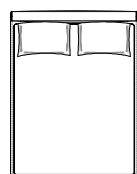
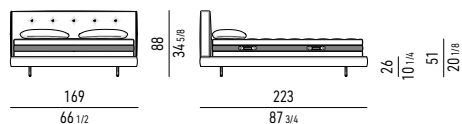

MATERASSO | MATTRESS:
CM 160X200 - 63 X 78 3/4

LETTO CM **189X223**
BED CM **189X223**

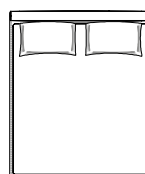
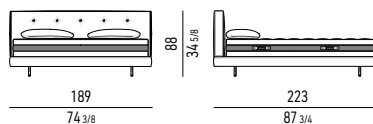

MATERASSO | MATTRESS:
CM 180X200 - 70 7/8 X 78 3/4

LETTO CM **209X223**
BED CM **209X223**

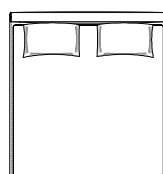
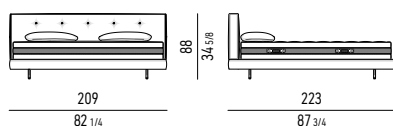

MATERASSO | MATTRESS:
CM 200X200 - 78 3/4 X 78 3/4

LETTO **QUEEN SIZE** CM **162X226**
BED **QUEEN SIZE** CM **162X226**

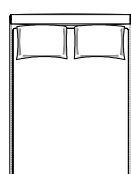
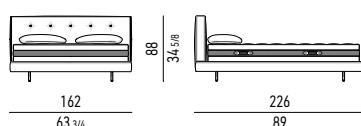

MATERASSO | MATTRESS:
CM 153X203 - 60 1/4 X 79 7/8

LETTO **KING SIZE** CM **202X226**
BED **KING SIZE** CM **202X226**

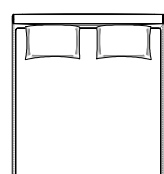
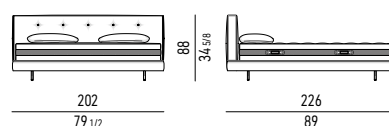

MATERASSO | MATTRESS:
CM 193X203 - 76 X 79 7/8

BRASILIA SOFT BED HIGH

SOMMIER DIVISO | TWO-PIECES SOMMIER

LETTO CM **169X223**
BED CM **169X223**

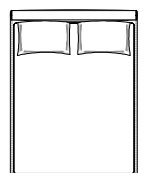
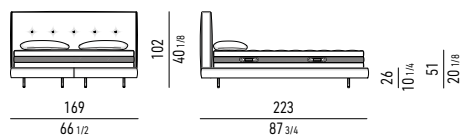

MATERASSO | MATTRESS:
CM 160X200 - 63 X 78 3/4

LETTO CM **189X223**
BED CM **189X223**

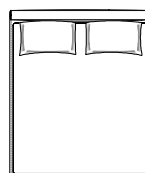
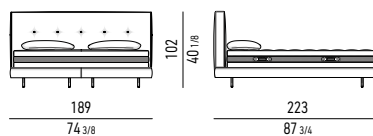

MATERASSO | MATTRESS:
CM 180X200 - 70 7/8 X 78 3/4

LETTO CM **209X223**
BED CM **209X223**

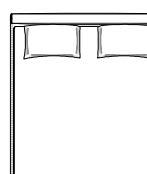
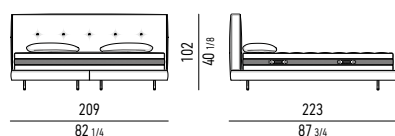

MATERASSO | MATTRESS:
CM 200X200 - 78 3/4 X 78 3/4

LETTO **QUEEN SIZE** CM **162X226**
BED **QUEEN SIZE** CM **162X226**

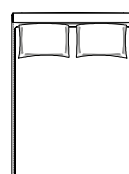
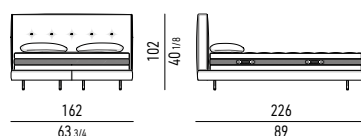

MATERASSO | MATTRESS:
CM 153X203 - 60 1/4 X 79 7/8

LETTO **KING SIZE** CM **202X226**
BED **KING SIZE** CM **202X226**

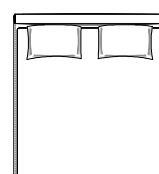
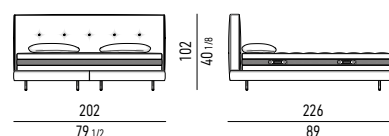

MATERASSO | MATTRESS:
CM 193X203 - 76 X 79 7/8

SOMMIER INTERO | ONE-PIECE SOMMIER

LETTO CM **169X223**
BED CM **169X223**

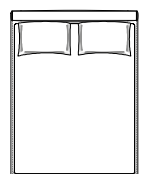
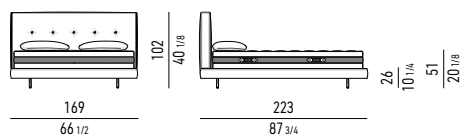

MATERASSO | MATTRESS:
CM 160X200 - 63 X 78 3/4

LETTO CM **189X223**
BED CM **189X223**

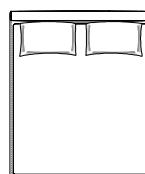
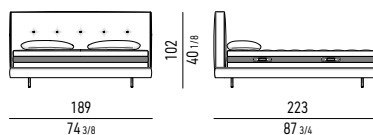

MATERASSO | MATTRESS:
CM 180X200 - 70 7/8 X 78 3/4

LETTO CM **209X223**
BED CM **209X223**

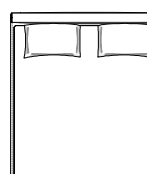
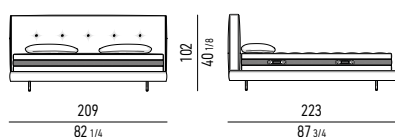

MATERASSO | MATTRESS:
CM 200X200 - 78 3/4 X 78 3/4

LETTO **QUEEN SIZE** CM **162X226**
BED **QUEEN SIZE** CM **162X226**

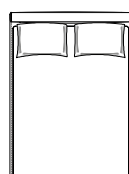
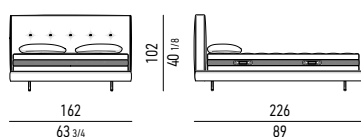

MATERASSO | MATTRESS:
CM 153X203 - 60 1/4 X 79 7/8

LETTO **KING SIZE** CM **202X226**
BED **KING SIZE** CM **202X226**

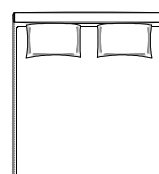
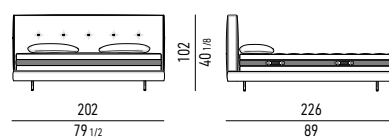

MATERASSO | MATTRESS:
CM 193X203 - 76 X 79 7/8

SOMMIER

SOMMIER DIVISO | TWO-PIECES SOMMIER

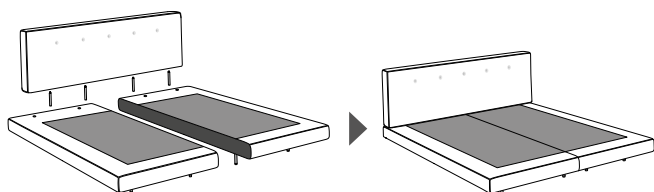

BRASILIA SOFT BED

Versione con sommier diviso in due elementi, al fine di facilitare la consegna.
I due elementi si congiungono tra loro a mezzo di un'apposita cremagliera. La testata viene agganciata attraverso un sistema di innesto e sgancio rapido.
I due elementi sommier vengono consegnati già rivestiti.

To facilitate delivery, a version with the sommier in two pieces is now available.
The two pieces are joined by means of a special connecting device.
The headboard is fastened through a quick set and release coupling system.
The two sommier pieces are delivered with upholstery already in place.

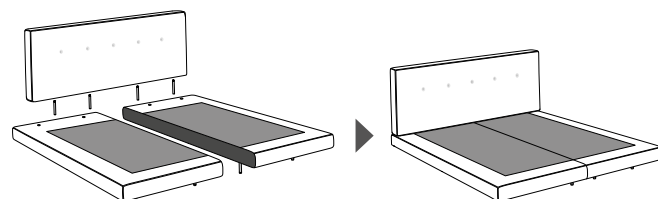

BRASILIA SOFT BED HIGH

Variante mit dem Sommier in zwei Teile zerlegt ist, um die Lieferung zu vereinfachen.
Die beiden Elemente werden über ein spezifisches, zahnradähnliches Scharnier miteinander verbunden.
Das Kopfteil wird mit einem schnellen Stecksystem am Gestell angebracht.
Beide Sommier-Teile werden bereits bezogen geliefert.

Version avec sommier divisé en deux parties afin de faciliter la livraison.
Les deux parties s'encastrent à l'aide d'un système de fixation à crémaillère.
La tête de lit se fixe à l'aide d'un mécanisme d'enclenchement et déclenchement rapide.
Les deux parties du sommier sont livrées avec leur revêtement.

SOMMIER INTERO | ONE-PIECE SOMMIER

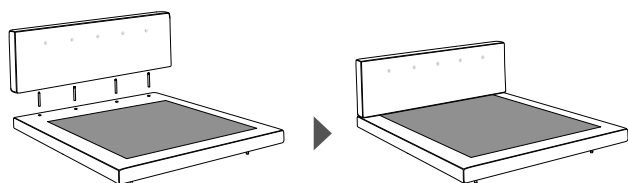

BRASILIA SOFT BED

La testata viene agganciata attraverso un sistema di innesto e sgancio rapido.

The headboard is fastened through a quick set and release coupling system.

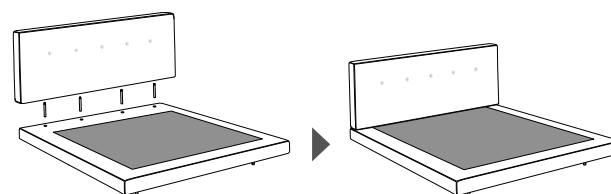

BRASILIA SOFT BED HIGH

Das Kopfteil wird mit einem schnellen Stecksystem am Gestell angebracht.

La tête de lit se fixe à l'aide d'un mécanisme d'enclenchement et déclenchement rapide.



COMODINO

Struttura:

- in MDF impiallacciato palissandro Santos* tinto Dark Brown, laccato poliesteri opaco;
- in MDF impiallacciato rovere tinto a poro aperto color Miele.

Il comodino è disponibile con un cassetto che scorre su guide a estrazione totale con chiusura Blumotion.

Finitura interna uguale alla struttura. Maniglia in alluminio verniciato lucido color Brandy.

Portata massima cassetto Kg 30.

Base: verniciata lucido anti-touch color Black Coffee, composta da lame realizzate con trafilata di alluminio. Scivolanti in polietilene antimacchia oil free.

*** il palissandro Santos deriva da foreste correttamente gestite.**

NIGHTSTAND

Structure:

- in MDF with palisander Santos* veneer, stained Dark Brown, matt polyester lacquer finish;
- in MDF with Honey stained open pore oak veneer.

The nightstand is available with a drawer that glides on full-extension guides with Blumotion closure. Interior finish is the same as the structure.

Aluminium handle with varnished polished Brandy colour finish. Maximum load drawer 30 Kg.

Base: blades made of drawn aluminium, varnished polished anti-fingerprint Black Coffee colour. Oil-free, non-staining polyethylene glides.

*** palisander Santos comes from properly managed forests.**

NACHTTISCH

Außenseite:

- aus MDF, furniert mit Palisander Santos* Dark Brown mit matter Polyesterlackierung;
- aus MDF, furniert mit offenerporiger, honigfarbenen gebeizter Eiche.

Der Nachttisch ist mit einer Schublade, die auf Vollauszugschienen mit Blumotion-Dämpfer läuft, erhältlich. Oberfläche an der Innenseite gleich wie der Außenseite.

Griff aus Aluminium mit glänzender Lackierung in der Farbe Brandy. Maximale Belastbarkeit pro Schublade 30 Kg.

Basis: Kufenfuß aus stranggepresstem Aluminium, mit glänzender Anti Touch-Lackierung in der Farbe Black Coffee. Gleiter aus Polyethylen mit ölfreier Fleckenschutzbehandlung.

*** Palisander Santos stammt aus korrekt bewirtschafteten Wäldern.**

TABLE DE CHEVET

Structure:

- en MDF plaqué palissandre de Santos* teinté Dark Brown, laqué polyester mat;

- en MDF plaqué chêne teinté à pore ouvert de couleur Miel.

La table de chevet est disponible avec un tiroir qui coulisse sur des glissières à extension complète avec fermeture Blumotion. Finition intérieure égale à celle de la structure.

Poignée en aluminium laqué brillant couleur Brandy.

Portée maximale tiroir 30 Kg.

Base : laquée brillant anti-traces couleur Black Coffee, composée de lames réalisées avec une matrice en aluminium. Patins en polyéthylène antitache sans huile.

*** le palissandre de Santos provient de forêts bien gérées.**

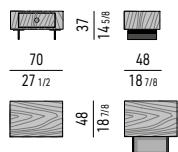

Cassetto che scorre su guide a estrazione totale con chiusura Blumotion. Portata massima Kg 30.

Drawer that glides on fully extractable guides with Blumotion soft-close system. Maximum load is 30 Kg.

SPAZIO UTILE INTERNO CASSETTO | DRAWER INTERNAL DIMENSION:
CM 43X36 H11

STRUTTURA STRUCTURE

PALISSANDRO SANTOS
PALISANDER SANTOS

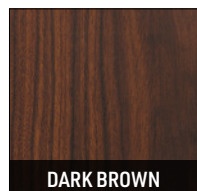

ROVERE
OAK

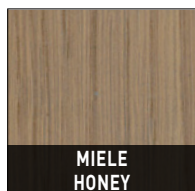

CASSETTO - INTERNO ED ESTERNO DRAWER - INTERNAL AND EXTERNAL

PALISSANDRO SANTOS
PALISANDER SANTOS

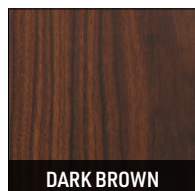

ROVERE
OAK

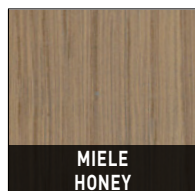

MANIGLIA HANDLE

ALLUMINIO LUCIDO
POLISHED ALUMINIUM

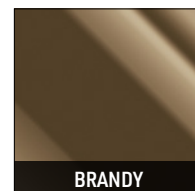

BASE BASE

ALLUMINIO LUCIDO
POLISHED ALUMINIUM

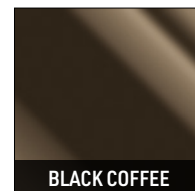

MATERASSO | MATTRESS COMFORT H20/25

Materasso ortopedico H 20/25 cm, con sette zone di portanza differenziata. Il materasso è costituito da molle "Supermicro" (per materasso H25 cm) o "Micropocket" (per materasso H20 cm) insacchettate, ricoperte in superficie da uno strato di poliuretano espanso ad alta resilienza a quote differenziate (Memory Foam). La tasca di contenimento della molla in tessuto anallergico, chiusa con ultrasuoni, rende il molleggio del materasso particolarmente confortevole. Il materasso è rivestito in tessuto jacquard "Minotti", color crema, antiacaro e antibatterico. Rivestimento completamente sfoderabile mediante cerniera. Non lavare in acqua, si consiglia il lavaggio a secco tramite tintoria specializzata.

Orthopedic mattress, H20/25 cm with seven different weight-bearing zones. The mattress is comprised of "Supermicro" (for H25 cm mattress) or "Micropocket" (for H20 cm mattress) pocket springs, covered by a surface layer of high resilience variable-density polyurethane (Memory Foam). Pockets containing the springs are made from hypoallergenic fabric, sealed by ultrasound, providing especially comfortable suspension. The mattress is covered in cream colour "Minotti" jacquard fabric that is mite-proof and antibacterial. Mattress cover has zipper closure and is completely removable and washable. Do not wash with water; professional dry cleaning by a specialist is recommended.

Orthopädische Matratze, Höhe 20/25 cm, mit sieben verschiedenen Belastungszonen. Die Matratze besteht aus einem "Supermicro" (für Matratze H25 cm) oder "Micropocket" (für Matratze H20 cm) Taschenfederkern, mit einem Belag aus verschieden hohem, hochelastischem Polyurethanschaum (Memory Foam). Die Federtaschen sind aus antiallergischem Stoff, geschlossen im Ultraschall-Schweißverfahren, was die Matratze besonders bequem macht. Die Matratze ist mit dem cremefarbenen Jacquard-Stoff "Minotti" bezogen, gegen Milben und antibakterielle behandelt. Der Bezug mit Reißverschluss ist voll abzieh- und waschbar. Nicht mit Wasser waschen, es wird eine chemische Reinigung durch ein spezialisiertes Reinigungsunternehmen empfohlen.

Matelas orthopédique H 20/25 cm, à sept zones de portance différenciée. Le matelas est constitué de ressorts ensachés "Supermicro" (pour matelas H25 cm) ou "Micropocket" (pour matelas H20 cm) recouverts d'une couche de polyuréthane expansé à haute résilience et à hauteurs différentes à mémoire de forme (Memory Foam). Le sachet contenant le ressort, en tissu anallergique et soudé aux ultrasons, rend la suspension du matelas particulièrement confortable. Le matelas est recouvert d'un tissu jacquard "Minotti", couleur crème, traité anti-acariens et anti-bactérien. Revêtement muni de fermeture à glissière, entièrement déhoussable et lavable. Ne pas laver à l'eau, il est recommandé de faire nettoyer à sec par un spécialiste.



DIMENSIONI MATERASSO MATTRESS DIMENSIONS

- 160x200 cm / 63x78³/₄"
- 180x200 cm / 70³/₈x78³/₄"
- 200x200 cm / 78³/₄x78³/₄"
- 153x203 cm / 60¹/₄x79⁷/₈"
- 193x203 cm / 76x79⁷/₈"

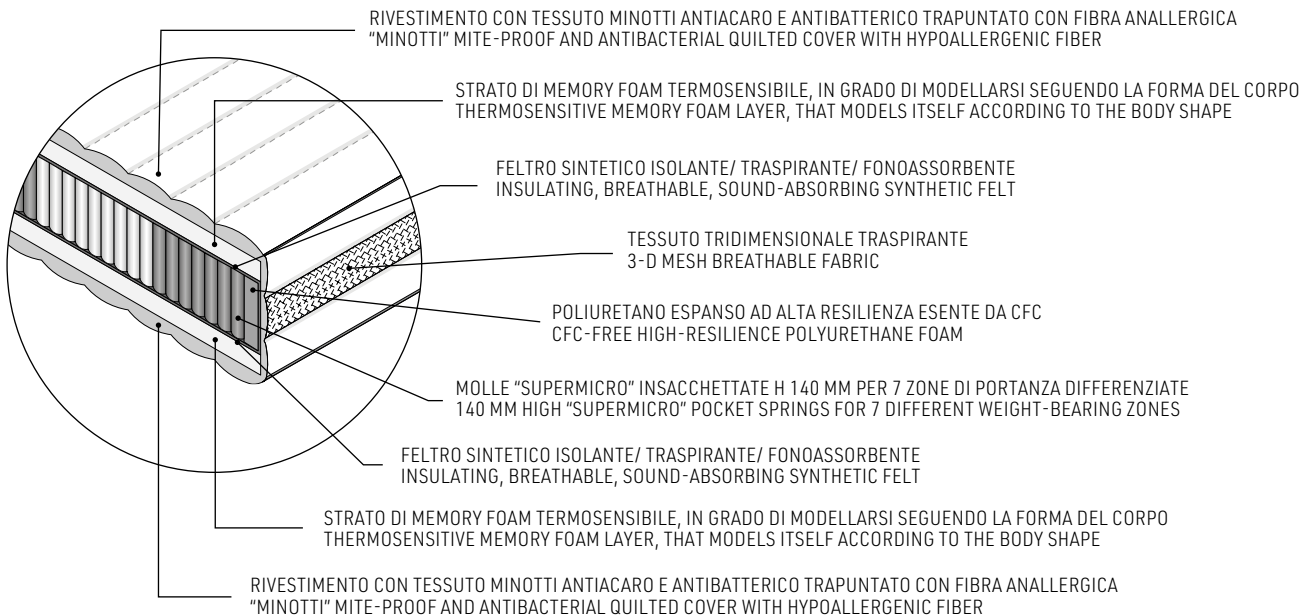
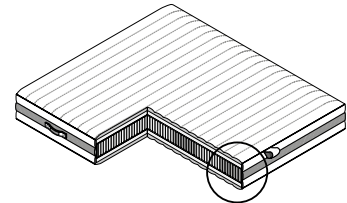
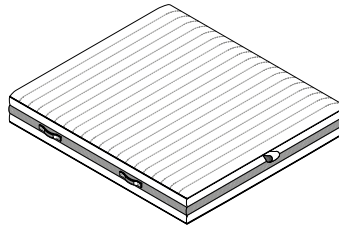

Minore portanza
Lower weight-bearing capacity



Maggiore portanza
Higher weight-bearing capacity



7 zone di portanza differenziate
7 different weight-bearing zones

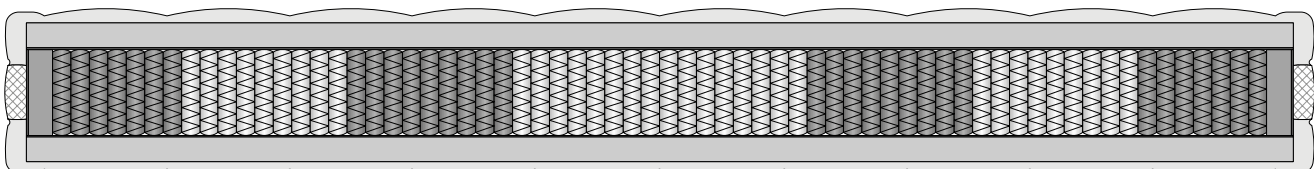

Minotti



MOLLEGGIO MICROPOCKET A 7 ZONE / MICROPOCKET 7-AREA SPRINGS

Morbidezza straordinaria con la molla che si comprime con un dito.

Extraordinary softness of the spring which compresses with the push of a finger.

MATERASSO H20 / MATTRESS H20

N. ZONE DIFFERENZIATE / NO. OF DIFFERENTIATED AREAS

ALTEZZA MOLLA / HEIGHT OF SPRINGS

DIAMETRO TESTA MOLLA / SPRING HEAD DIAMETER

DIAMETRO FILO ACCIAIO / STEEL THREAD DIAMETER

CATEGORIA MOLLE / SPRING CATEGORY

QUANTITÀ / QUANTITY

7

120 mm

40 mm

1,3 - 1,4 mm

1600

600/MQ

MATERASSO H25 / MATTRESS H25

N. ZONE DIFFERENZIATE / NO. OF DIFFERENTIATED AREAS

ALTEZZA MOLLA / HEIGHT OF SPRINGS

DIAMETRO TESTA MOLLA / SPRING HEAD DIAMETER

DIAMETRO FILO ACCIAIO / STEEL THREAD DIAMETER

CATEGORIA MOLLE / SPRING CATEGORY

QUANTITÀ / QUANTITY

7

140 mm

22-28 mm

0,9 - 1,0 mm

3000

1100/MQ

TESSUTO TRIDIMENSIONALE TRASPIRANTE 3-D MESH BREATHABLE FABRIC

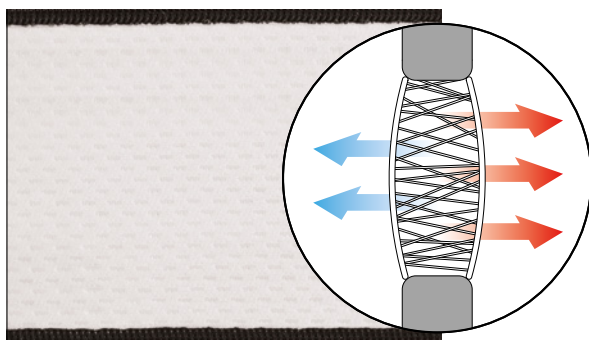

Tessuto tridimensionale composto da tre strati che generano un'intercapedine interna dove circola liberamente l'aria.

Una fascia traspirante continua sul bordo del materasso e permette di mantenerlo fresco e asciutto, grazie al flusso continuo d'aria che ne favorisce il riciccolo.

Three-dimensional material, consisting of three layers which create an internal three-dimensional gap where air can circulate freely.

A transpiring hem runs along the edge of the mattress enabling it to stay fresher and drier, since the continuous airflow helps it recycle.

MATERASSINO | TOPPER COMFORT H5

Materassino imbottito in Dacron 900g/mq, fibra anallergica elastica con basso coefficiente di trasmissione di calore, H cm 5, con elastici agli angoli. Posizionato tra il materasso e il lenzuolo, il topper dona una particolare sensazione di morbidezza e confort.

E' rivestito in tessuto jacquard "Minotti", color crema, antiacaro e antibatterico. Rivestimento completamente sfoderabile mediante cerniera. Non lavare in acqua, si consiglia il lavaggio a secco tramite tintoria specializzata.

Padded mattress topper in Dacron 900g/sq m, H cm 5 made of elastic, non-allergic fibres with low heat transmission, with elastic straps on the corners. Placed between the mattress and the sheet, the topper lends added sensation of softness and comfort. Covered in cream color "Minotti" jacquard fabric that is mite-proof and antibacterial. Topper cover has zipper closure and is completely removable. Do not wash with water; professional dry cleaning by a specialist is recommended.

Matratzenauflage mit Dacron-Füllung 900g/m, aus elastischen antiallergischen Fasern mit geringe Wärmeübertragung, Höhe 5 cm, mit Spanngummis. Die Auflage, zwischen Matratze und Laken, vermittelt ein besonderes Gefühl von Weichheit und Komfort. Mit dem cremefarbenen Jacquard-Stoff "Minotti" bezogen, antibakterielle und gegen Milben behandelt. Bezug mit Reißverschluss vollkommen abziehbar. Nicht mit Wasser waschen, es wird eine chemische Reinigung durch ein spezialisiertes Reinigungsunternehmen empfohlen.

Petit matelas rembourré en Dacron 900g/m², en fibres élastique anallergique, avec faible transmission de la chaleur, H cm 5, avec d'élastiques aux angles. Cette couche de confort, située entre le matelas et le drap, donne une sensation particulière de souplesse et de confort. Elle est recouverte de tissu jacquard "Minotti", couleur crème, traité anti-acariens et antibactérien. Revêtement entièrement déhoussable par fermeture à glissière. Ne pas laver à l'eau, il est recommandé de faire nettoyer à sec par un spécialiste.

DIMENSIONI MATERASSINO TOPPER DIMENSIONS

160x200 cm / 63x78³/₄"

180x200 cm / 70¹/₈x78³/₄"

200x200 cm / 78³/₄x78³/₄"

153x203 cm / 60¹/₄x79⁷/₈"

193x203 cm / 76x79⁷/₈"

