



Struttura: in legno multistrato di vari spessori. Preparazione della struttura in poliuretano espanso a quote differenziate ad alta resilienza. Braccioli e schienali realizzati in legno multistrato con cinghie elastiche ad alta componente di caucciù rivestiti con trapuntino di fibra di poliestere termolegata traspirante accoppiata con tela di cotone bianca anallergica. Il trapuntino include al suo interno una sacca imbottita di microfibra siliconata - con basso coefficiente di attrito - che si adatta completamente alla struttura; tale imbottitura, con elevate caratteristiche di morbidezza e sofficià, è ottenuta da PET 100% riciclato certificato.

Tutti i materiali impiegati per realizzare il trapuntino sono anallergici. La particolare confezione della fodera della base può essere realizzata completamente in tessuto, caratterizzata da un profilo centrale che segna la congiunzione delle due fasce, completamente in pelle assemblando le due fasce con l'ausilio di una fettuccia fissata tramite una doppia cucitura (tecnica di lavorazione usata nella valigeria) oppure con fascia inferiore in pelle e superiore in tessuto, assemblate mezzo zip nascosta che consente la sfoderabilità.

Piani d'appoggio: il sistema di sedute prevede top fissati alla base, disponibili in diverse dimensioni e configurazioni.

"TOP" legno: tamburato di MDF, spessore mm 60, impiallacciato in legno:

- noce Canaletto, tinto Dark Brown, laccato poliestere opaco;
- frassino laccato a poro aperto color Liquirizia.

Pannello distanziale in MDF, spessore mm 20, laccato nero opaco.

"TOP" marmo: tamburato di MDF, spessore mm 44, laccato nero opaco e rivestito con lavorazione folding da una lastra - spessore mm 16, di:

- Nero Marquina, levigato opaco;
- Calacatta;
- Grigio Orobico;
- granito Belvedere, spazzolato.

Pannello distanziale in MDF, spessore mm 20, laccato nero opaco.

Cuscineria: imbottitura cuscini schienali in microfibra siliconata con basso coefficiente di attrito, con riempimento a canali indipendenti, con differenti portate, che garantiscono una localizzazione della fibra netta e duratura. Questa soluzione garantisce un notevole comfort e consente una migliore distribuzione del peso del corpo sulla superficie d'appoggio. Cuscino sedile in poliuretano espanso ad alta resilienza composto da numerosi strati di quote differenziate. Inserto centrale composto da molle d'acciaio insacchettate che garantiscono l'indeformabilità della seduta e un maggiore comfort.

Structure: in plywood of various thicknesses. The structure is coated in high-resilience, variable-density polyurethane foam.

Armrests and backrests in plywood with high-rubber-content elastic webbing, covered with breathable heat-bonded polyester quilted fibre laminated to white hypoallergenic cotton fabric. Inside the quilt is a bag padded with siliconised microfibre - with low coefficient of friction - which completely conforms to the structure; this very soft, fluffy padding is obtained from certified 100% recycled PET.

All of the materials employed in manufacturing the quilt are hypoallergenic. The special upholstery on the base can be crafted in entirely in fabric, featuring an all-leather central trim element that marks the seam between the two sections, which are joined with a strip of double-stitched leather (tailoring technique used in fine luggage); or, with a lower section in leather and upper section in fabric, joined by a hidden zipper that allows the upholstery to be removed.

Table-top surfaces: the seating system includes tops attached to the base, available in various sizes and configurations.

Wood "TOP": honeycomb MDF, 60 mm thick, wood veneer:

- Canaletto walnut stained Dark Brown, matt polyester lacquer finish;
- ash open-pore lacquered Licorice colour.

Spacer panel in MDF, 20 mm thick, matt lacquered black.

Marble "TOP": honeycomb MDF, 44 mm thick, matt lacquered black, clad with a marble slab, mitre-folded - 16 mm thick, in:

- Nero Marquina, smoothed matt;
- Calacatta;
- Grigio orobico;
- Belvedere granit, brushed.

Spacer panel in MDF, 20 mm thick, matt black lacquer finish.

Cushions: padding for backrest cushions in siliconised microfibre with low coefficient of friction, filled in separate channels, with different density, that ensures absolute, lasting localisation of the fibre. This solution guarantees outstanding comfort and allows optimal distribution of body weight over the support surface. Seat cushion made of many layers of variable-density, high resilience polyurethane foam. A core insert made of steel pocket springs ensures non-deformability of the seat and greater comfort.

Encased in breathable heat-bonded polyester quilted fibre laminated to white cotton fabric. Inside the quilt is a bag padded with siliconised microfibre - with a low coefficient of friction - which completely conforms to the structure; this very soft, fluffy padding is obtained from certified 100% recycled PET.

Struktur: Aus Sperrholz mit unterschiedlichen Stärken. Polsterung des Gestells aus hochwiderstandsfähigem PU-Schaum mit differenzierter Dichte. Armlehnen und Rückenlehnen aus Sperrholz mit elastischen Riemen mit hohem Kautschukanteil, bezogen mit gestepter Polsterung aus atmungsaktiver, thermofixierter Faser mit Bezug aus weißer, antiallergischer Baumwolle. In der gesteppten Polsterung befindet sich eine Tasche mit Füllung aus silikonbeschichteter Mikrofaser mit geringem Reibungswiderstand, die sich vollständig an das Gestell anpasst. Diese Polsterung ist besonders weich und flauschig und besteht aus zertifiziertem, zu 100% recyceltem PET. Alle, für die gesteppte Polsterung verwendeten Materialien sind antiallergisch.

Die besondere Konfektionierung des Untergestells kann auch aus Stoff gefertigt werden und zeichnet sich durch ein zentrales Profil aus, das sich an der Verbindungsstelle zwischen den beiden Teilstücken befindet. Die Teilstücke aus Leder werden mit einem Band zusammengesetzt, das mit einer Doppelnäht aufgenäht wird (eine Technik, die auch bei der Lederwarenherstellung eingesetzt wird), oder mit einem unteren Band aus Leder und einem oberen Band aus Stoff, die mit einem verdeckten Reißverschluss verbunden werden, sodass der Bezug abziehbar ist.

Ablageplatte: Das Sofasystem sieht Ablageplatten vor, die an der Basis befestigt werden und in verschiedenen Abmessungen und Konfigurationen verfügbar sind.

Holz "TOP": MDF-Wabenplatte, Stärke 60 mm, Holz furniert:

- Nussbaum Canaletto, gebeizt Dark Brown, matt matter Polyesterbeschichtung;
- Eschenholz mit offener Lackierung in der Farbe Lakritze. Zwischenplatte aus MDF, Stärke 20 mm, matt lackiert in Schwarz.

Marmor "TOP": MDF-Wabenplatte, Stärke 44 mm, matt lackiert in Schwarz, verkleidet mit einer Marmorplatte im Folding-Verfahren, Stärke 16 mm, in:

- Nero Marquina, matt geschliffen;
- Calacatta;
- Grigio orobico;
- Belvedere Granit, gebürstet.

Zwischenplatte aus MDF, Stärke 20 mm, matt lackiert in Schwarz. **Kissen:** Polsterung der Rückenlehnen aus silikonbeschichteter Mikrofaser mit geringem Reibungskoeffizient, mit Füllung in unabhängigen Kammern mit unterschiedlichem Fassungsvermögen, die eine saubere und beständige Verteilung der Faser gewährleisten. Diese Lösung garantiert für hohen Komfort und erlaubt eine bessere Verteilung des Körpergewichts auf der Auflagefläche.

Structure: en bois multiplis de différentes épaisseurs. Préparation de la structure en polyuréthane expansé à densité différenciée haute résilience.

Accoudoirs et dossiers en bois multiplis avec sangles élastiques à haute teneur en caoutchouc, revêtus d'un rembourrage en fibre de polyester thermocollée respirante, contrecollée sur une toile en coton blanc hypoallergénique. Le rembourrage contient une poche garnie de microfibres siliconées - avec un faible coefficient de frottement - qui s'adapte parfaitement à la structure; ce garnissage particulièrement souple et moelleux est issu de PET 100% recyclé certifié. Tous les matériaux utilisés pour réaliser ce rembourrage sont hypoallergéniques.

La confection spéciale du revêtement du piétement peut être entièrement réalisée en tissu, caractérisée par un cordon central qui marque la jonction des deux bandes, entièrement en cuir en assemblant les deux bandes à l'aide d'un ruban fixé par une double couture (technique utilisée en maroquinerie) ou avec une bande inférieure en cuir et une supérieure en tissu, assemblées à l'aide d'une fermeture à glissière cachée qui permet le déhousseage.

Tablettes: le système de sièges prévoit des tablettes fixées sur le piétement, disponibles en différentes tailles et configurations.

« TOP » bois: nid d'abeille de MDF, épaisseur 60 mm, plaqué en bois:

- noyer Canaletto, teinté Dark Brown, laqué polyester mat;
- frêne laqué à pores ouverts couleur Réglette.

Panneau d'espacement en MDF, épaisseur 20 mm, laqué noir mat.

« TOP » marbre: nid d'abeille en MDF, épaisseur 44 mm, laqué Noir mat, recouvert à travers la technique folding d'une plaque - épaisseur 16 mm, de:

- Nero Marquina, poli mat;
- Calacatta;
- Grigio Orobico;
- granit Belvedere, brossé.

Panneau distancier en MDF, épaisseur 20 mm, laqué noir mat. **Coussins:** rembourrage des coussins de dossier en microfibres siliconées à faible coefficient de frottement, avec remplissage cloisonné, de différentes densités, qui garantissent une localisation de la fibre nette et durable. Cette solution assure un confort remarquable et permet une meilleure répartition du poids du corps sur la surface.

Coussin d'assise en polyuréthane expansé haute résilience composé de plusieurs couches à densité différenciée. Insert central composé de ressorts ensachés en acier qui garantissent l'indeformabilité de l'assise et un plus grand confort.

Minotti

Rivestimento con trapuntino di fibra di poliestere termolegata traspirante, accoppiata con tela cotone bianca.

Il trapuntino include al suo interno una sacca imbottita di microfibra siliconata - con basso coefficiente di attrito - che permette di adattarsi completamente alla struttura; tale imbottitura, con elevate caratteristiche di morbidezza e soffici ta,   ottenuta da PET 100% riciclato certificato. Tutti i materiali impiegati per realizzare il trapuntino sono anallergici.

Sfoderabilit : struttura, cuscini sedile e schienale completamente sfoderabili in tutte le versioni (tessuto o pelle).

Base: appoggio a terra tramite base perimetrale, in metallo verniciato Nero opaco con piedini regolabili. Scivolante protettivo in polietilene antimacchia oil free di colore nero.

Per facilitare la sfoderabilit , gli schienali e i braccioli sono facilmente sfilabili dalle loro sedi agendo sulle apposite manopole poste nella parte sottostante i divani. Tale procedura permette di poter facilmente trasportare il divano.

AVVERTENZE SULLA CONFEZIONE DELLA FODERA

A) rivestimento tutto in pelle o tutto in tessuto;

B) rivestimento della base in pelle cat. Pelle Nature, braccioli, cuscini sedile e schienale in tessuto;

C) rivestimento della base MIX (rivestimento della parte superiore in tessuto e della parte inferiore in pelle cat. Pelle Nature), braccioli, cuscini sedile e schienale in tessuto.

In caso di base MIX, il rivestimento in tessuto previsto per la parte superiore sar  il medesimo scelto per l'elemento imbottito.

ATTENZIONE: data la delicatezza dei marmi levigati opachi, si consiglia di non appoggiare oggetti direttamente sul piano.

BASE
BASE

METALLO OPACO
MATT METAL

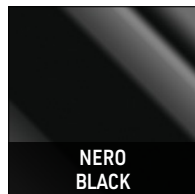

PIANI D'APPOGGIO
TABLE-TOP SURFACES

NOCE CANALETTO
CANALETTO WALNUT

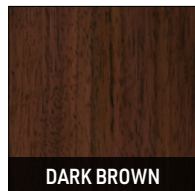

FRASSINO
ASH



MARMO
MARBLE

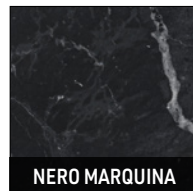
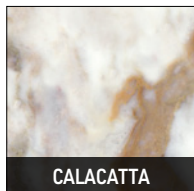

GRANITO
GRANITE

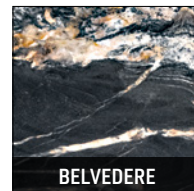

All of the materials employed in manufacturing the quilt are hypoallergenic.

Covers: upholstery for the structure, seat and backrest cushions is completely removable in all versions (fabric or leather).

Base: metal perimeter base with adjustable feet, varnished matt Black. Black, oil-free, non-staining protective polyethylene glides.

To facilitate removal of the upholstery, backrests and armrests can be easily extracted by releasing the levers located underneath the sofa. This procedure allows the sofa to be easily transported.

INFORMATION REGARDING UPHOLSTERY

A) all-fabric or all-leather upholstery;

B) base upholstered in leather cat. Nature Leather, armrests, seat and backrest cushions in fabric;

C) MIX base upholstery (upper part upholstered in fabric and lower part in leather cat. Nature Leather), armrests, seat and backrest cushions in fabric. On the MIX base, the fabric upholstery for the upper part will be the same as that chosen for the upholstered element.

IMPORTANT: given the delicate nature of the marble elements with smoothed matt finish, do not place objects directly onto the surface.

Sitzkissen aus hochwiderstandsf higem PU-Schaum, der aus zahlreichen Schichten mit differenzierter Dichte besteht. Zentraler Einsatz aus Taschenfederkernen aus Stahl, die f r die Formbest ndigkeit der Sitzfl che und einen h heren Sitzkomfort garantieren. Bezug mit gesteppter Polsterung aus atmungsaktiver, thermofixierter Faser mit Bezug aus wei er Baumwolle.

In der gesteppten Polsterung befindet sich eine Tasche mit F llung aus silikonbeschichteter Mikrofaser mit geringem Reibungswiderstand, die sich vollst ndig an das Gestell anpasst. Diese Polsterung ist besonders weich und flauschig und besteht aus zertifiziertem, zu 100% recyceltem PET. Alle, f r die gesteppte Polsterung verwendeten Materialien sind antiallergisch.

Abziehbarkeit: Gestell, Sitzkissen und R ckenkissen sind in allen Versionen (Stoff oder Leder) komplett abziehbar.

Basis: Auflage auf dem Boden mit umlaufendem Untergestell aus Metall mit Lackierung in Mattschwarz und mit h henverstellbaren F u en.

Schutzgleiter aus  lfreiem Polyethylen mit Fleckenschutz in Schwarz.

F r ein einfaches Abziehen vom Bezug lassen sich die R ckenlehnen und Armlehnen einfach aus ihrem Sitz herausziehen. Dazu die entsprechenden Drehkn pfe bet tigen, die sich unter dem Sofa befinden. Mit dieser Prozedur kann das Sofa auch einfach transportiert werden.

HINWEISE ZUR KONFEKTIONIERUNG DES BEZUGS

A) Bezug komplett aus Leder oder komplett aus Stoff;

B) Bezug des Gestells aus Leder Kat. Leder Nature, Armlehnen, Sitzkissen und R ckenkissen mit Stoffbezug;

C) Bezug des Gestells MIX (Bezug des Oberteils aus Stoff und Bezug des Unterteils aus Leder Kat. Leder Nature), Armlehnen, Sitzkissen und R ckenkissen mit Stoffbezug.

Im Fall des Gestells MIX wird f r den Stoffbezug, der f r das Oberteil vorgesehen ist, der gleiche Stoff gew hlt wie f r das gepolsterte Element.

ACHTUNG: Aufgrund der Empfindlichkeit des Marmors mit matt geschliffener Oberfl che ist es ratsam, keine Gegenst nde direkt auf die Platte zu stellen.

Rev tu d'une couche en fibre de polyester thermocoll e respirante, contrecoll e sur une toile en coton blanc. Le rembourrage contient une poche garnie de microfibre silicon e - avec un faible coefficient de frottement - qui s'adapte parfaitement   la structure ; ce garnissage particuli rement souple et moelleux est issu de PET 100% recycl  certifi . Tous les mat riaux utilis s pour r aliser ce rembourrage sont hypoallerg niques.

D houssage : structure, coussins d'assise et de dossier enti rement d houssables dans toutes les versions (tissu ou cuir).

Base : repose sur un pi tement p rim trique en m tal, peint en Noir mat avec embouts de pieds r glables. Patins glisseurs en poly thyl ne antitache oil-free de couleur noire.

Pour faciliter le d houssage, les dossiers et les accoudoirs peuvent  tre facilement retir s de leur logement en tournant les poign es situ es sous les canap s. Cette proc dure permet de transporter facilement le canap .

NOTES SUR L'EMBALLAGE DE LA HOUSSE

A) rev tement tout en cuir ou tout en tissu ;

B) rev tement du pi tement en cuir cat. Cuir Nature, accoudoirs, coussins d'assise et de dossier en tissu ;

C) rembourrage du pi tement MIX (rev tement de la partie sup rieure en tissu et de la partie inf rieure en cuir cat. Cuir Nature), accoudoirs, coussins d'assise et de dossier en tissu.

En cas de pi tement MIX, le rev tement en tissu pr vu pour la partie sup rieure sera le m me que celui qui a  t  choisi pour l' l ment rembourr .

ATTENTION :  tant donn  la d licatesse du marbre   finition poli mat, il est recommand  de ne pas poser d'objets directement sur le plateau.

Minotti

DIVANI | SOFAS

DIVANO CM 254
SOFA CM 254

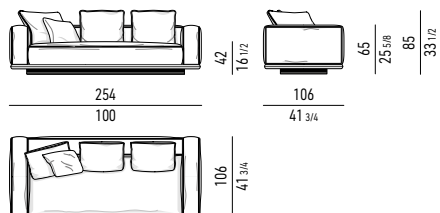

DIVANO CM 280
SOFA CM 280

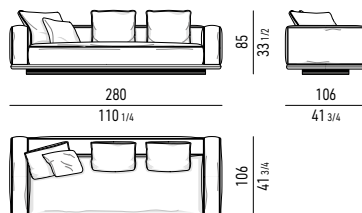

DIVANO CM 306
SOFA CM 306

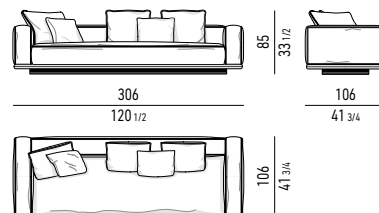

ELEMENTI TERMINALI | ELEMENTS WITH 1 ARMREST

ELEMENTO TERMINALE CM 128
ELEMENT WITH 1 ARMREST CM 128

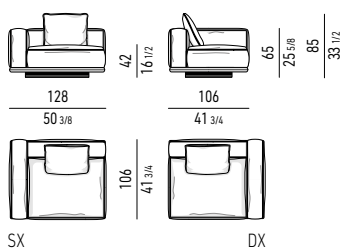

ELEMENTO TERMINALE CM 154
ELEMENT WITH 1 ARMREST CM 154

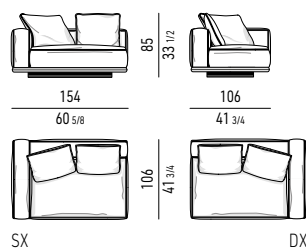

ELEMENTO TERMINALE CM 180
ELEMENT WITH 1 ARMREST CM 180

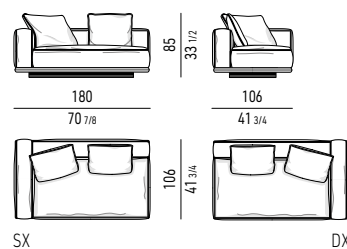

ELEMENTO TERMINALE CM 206
ELEMENT WITH 1 ARMREST CM 206

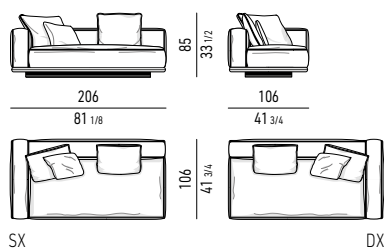

ELEMENTO TERMINALE CM 232
ELEMENT WITH 1 ARMREST CM 232

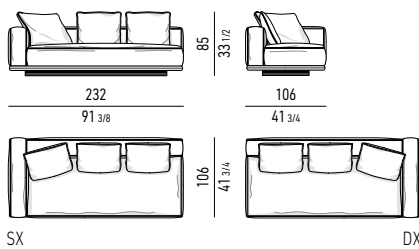

ELEMENTO TERMINALE CM 258
ELEMENT WITH 1 ARMREST CM 258

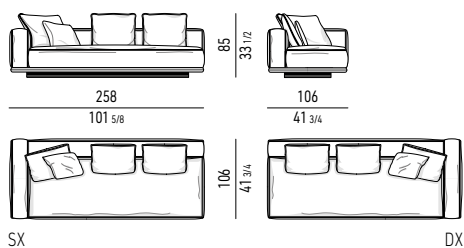

ELEMENTO TERMINALE CM 284
ELEMENT WITH 1 ARMREST CM 284

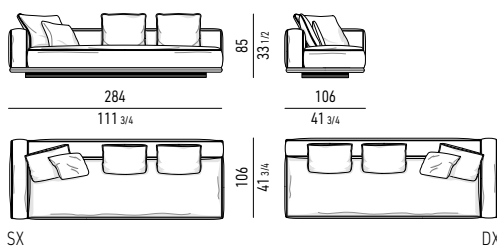

ELEMENTO TERMINALE CM 232 CON TOP SHORT
ELEMENT WITH 1 ARMREST CM 232 WITH TOP SHORT

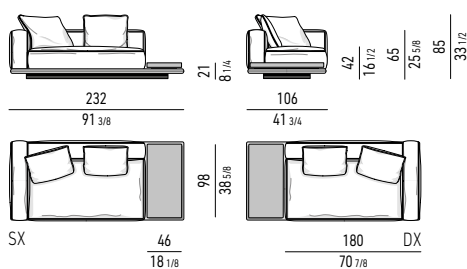

ELEMENTO TERMINALE CM 232 CON TOP SQUARE
ELEMENT WITH 1 ARMREST CM 232 WITH TOP SQUARE

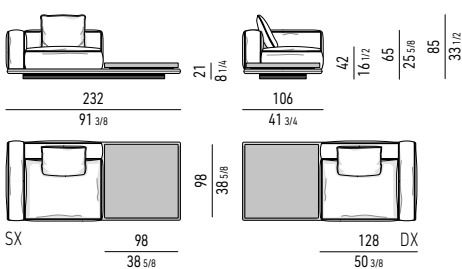

Minotti

ELEMENTO TERMINALE CM 232 CON **POUF**
ELEMENT WITH 1 ARMREST CM 232 WITH **OTTOMAN**

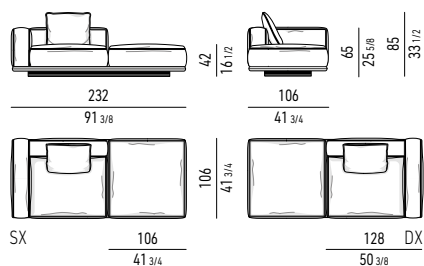

ELEMENTO TERMINALE CM 258 CON **TOP SHORT**
ELEMENT WITH 1 ARMREST CM 258 WITH **TOP SHORT**

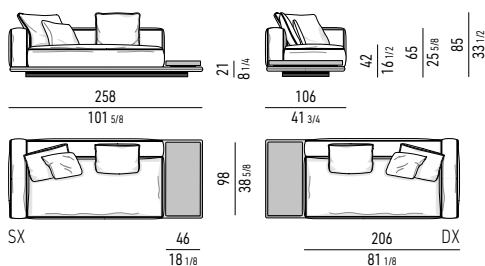

ELEMENTO TERMINALE CM 258 CON **TOP SQUARE**
ELEMENT WITH 1 ARMREST CM 258 WITH **TOP SQUARE**

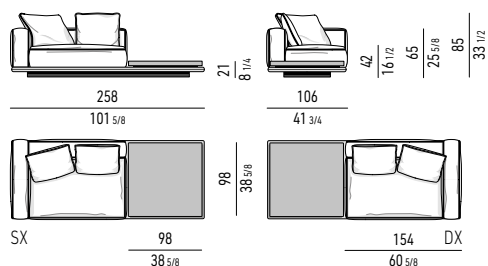

ELEMENTO TERMINALE CM 258 CON **POUF**
ELEMENT WITH 1 ARMREST CM 258 WITH **OTTOMAN**

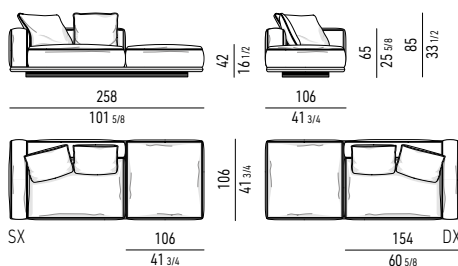

ELEMENTO TERMINALE CM 284 CON **TOP SHORT**
ELEMENT WITH 1 ARMREST CM 284 WITH **TOP SHORT**

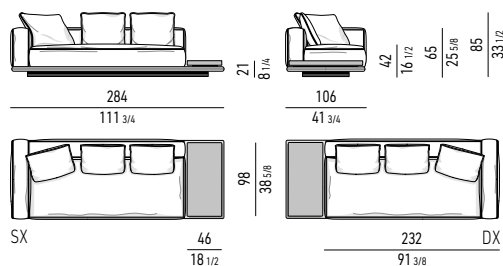

ELEMENTO TERMINALE CM 284 CON **TOP SQUARE**
ELEMENT WITH 1 ARMREST CM 284 WITH **TOP SQUARE**

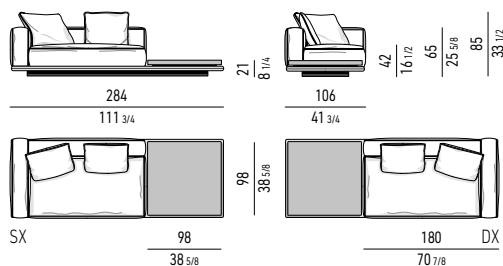

ELEMENTO TERMINALE CM 310 CON **TOP SHORT**
ELEMENT WITH 1 ARMREST CM 310 WITH **TOP SHORT**

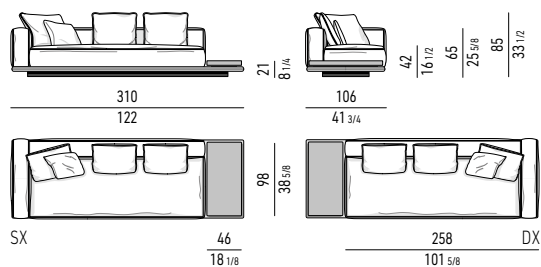

ELEMENTO TERMINALE CM 310 CON **TOP SQUARE**
ELEMENT WITH 1 ARMREST CM 310 WITH **TOP SQUARE**

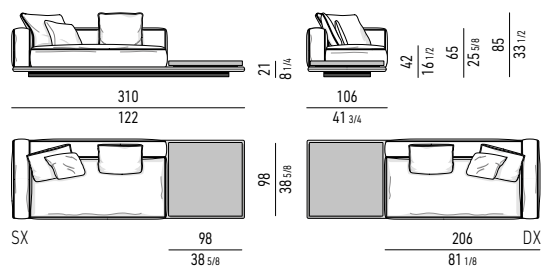

ELEMENTO TERMINALE CM 310 CON **POUF**
ELEMENT WITH 1 ARMREST CM 310 WITH **OTTOMAN**

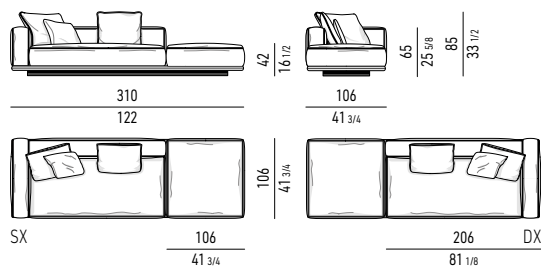

ELEMENTI CENTRALI | CENTRAL ELEMENTS

ELEMENTO CENTRALE CM 106
CENTRAL ELEMENT CM 106

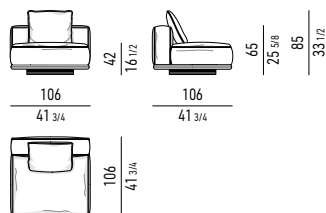

ELEMENTO CENTRALE CM 132
CENTRAL ELEMENT CM 132

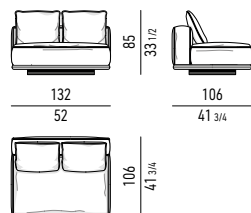

ELEMENTO CENTRALE CM 158
CENTRAL ELEMENT CM 158

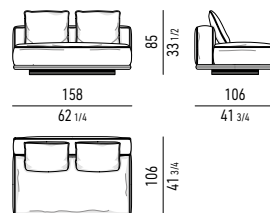

ELEMENTO CENTRALE CM 184
CENTRAL ELEMENT CM 184

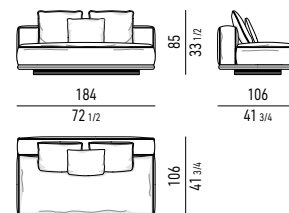

ELEMENTO CENTRALE CM 210
CENTRAL ELEMENT CM 210

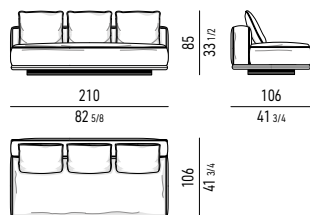

ELEMENTO CENTRALE CM 236
CENTRAL ELEMENT CM 236

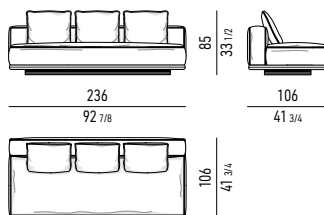

ELEMENTO CENTRALE CM 262
CENTRAL ELEMENT CM 262

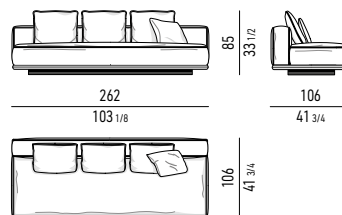

ELEMENTO CENTRALE CM 210 CON TOP SHORT
CENTRAL ELEMENT CM 210 WITH TOP SHORT

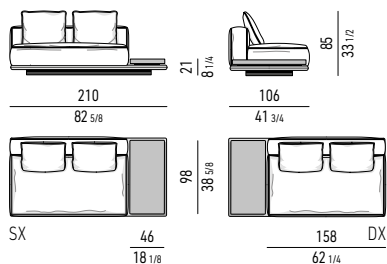

ELEMENTO CENTRALE CM 210 CON TOP SQUARE
CENTRAL ELEMENT CM 210 WITH TOP SQUARE

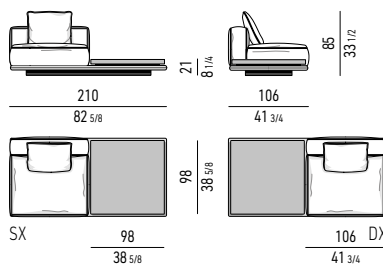

ELEMENTO CENTRALE CM 210 CON POUF
CENTRAL ELEMENT CM 210 WITH OTTOMAN

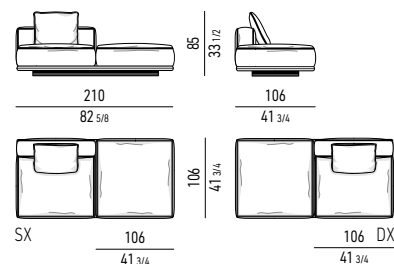

ELEMENTO CENTRALE CM 236 CON TOP SHORT
CENTRAL ELEMENT CM 236 WITH TOP SHORT

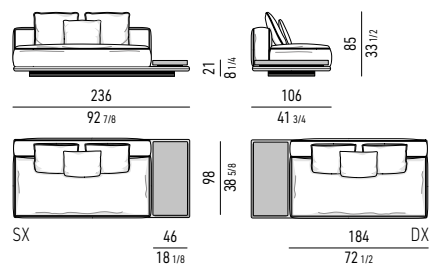

ELEMENTO CENTRALE CM 236 CON TOP SQUARE
CENTRAL ELEMENT CM 236 WITH TOP SQUARE

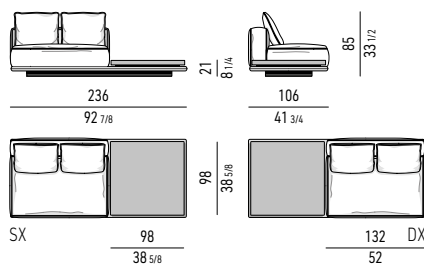

ELEMENTO CENTRALE CM 236 CON POUF
CENTRAL ELEMENT CM 236 WITH OTTOMAN

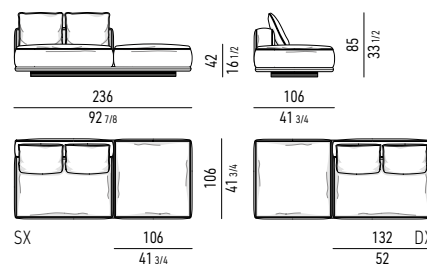

ELEMENTO CENTRALE CM 262 CON TOP SHORT
CENTRAL ELEMENT CM 262 WITH TOP SHORT

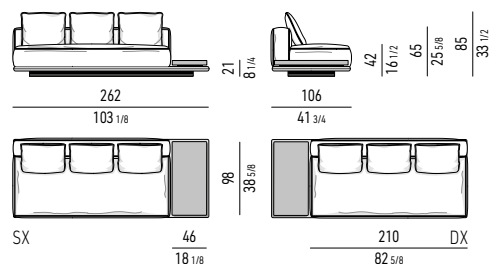

ELEMENTO CENTRALE CM 262 CON TOP SQUARE
CENTRAL ELEMENT CM 262 WITH TOP SQUARE

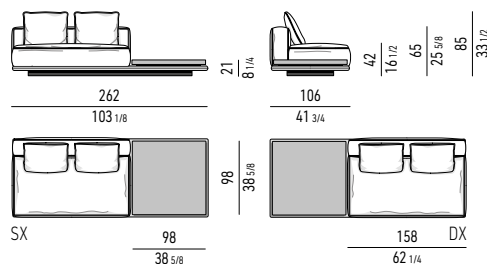

Minotti

ELEMENTO CENTRALE CM 262 CON **POUF**
CENTRAL ELEMENT CM 262 WITH **OTTOMAN**

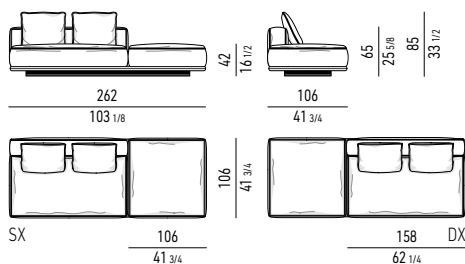

ELEMENTO CENTRALE CM 288 CON **TOP SHORT**
CENTRAL ELEMENT CM 288 WITH **TOP SHORT**

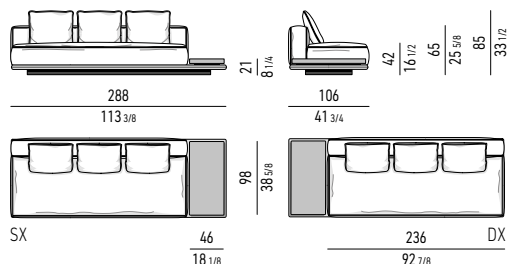

ELEMENTO CENTRALE CM 288 CON **TOP SQUARE**
CENTRAL ELEMENT CM 288 WITH **TOP SQUARE**

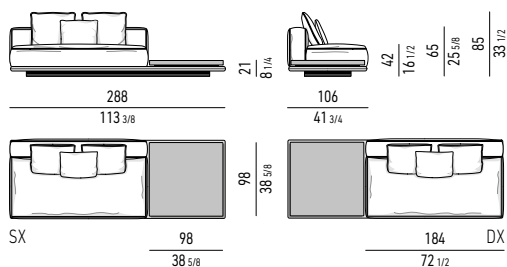

ELEMENTO CENTRALE CM 288 CON **POUF**
CENTRAL ELEMENT CM 288 WITH **OTTOMAN**

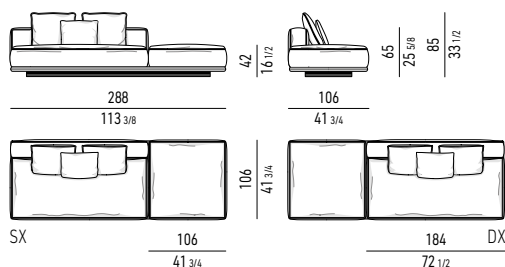

COUCH | COUCHES

COUCH CM 158X158
COUCH CM 158X158

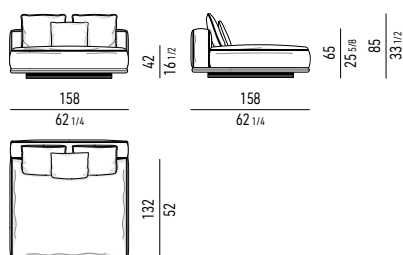

COUCH CM 210X158 CON **TOP LONG**
COUCH CM 210X158 WITH **TOP LONG**

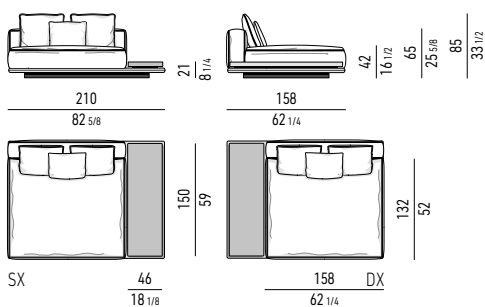

CHAISE-LONGUE | CHAISE-LONGUES

CHAISE-LONGUE CM 158X158
CHAISE-LONGUE CM 158X158

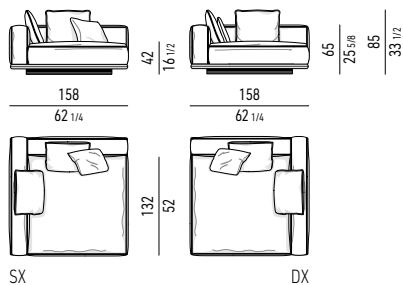

CHAISE-LONGUE CM 158X186
CHAISE-LONGUE CM 158X186

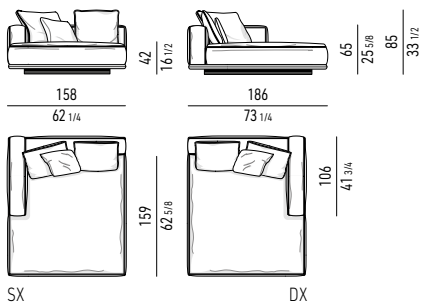

Minotti

ELEMENTI INCLINATI | INCLINED ELEMENTS

ELEMENTO TERMINALE INCLINATO CM 267
INCLINED ELEMENT WITH 1 ARMREST CM 267

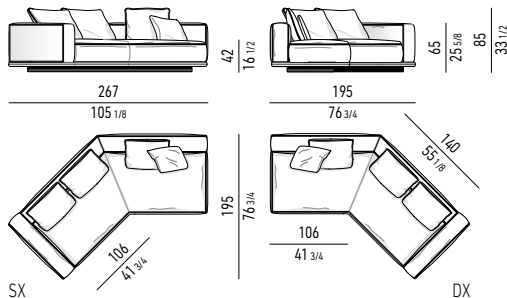

ELEMENTO CENTRALE INCLINATO CM 252
INCLINED CENTRAL ELEMENT CM 252

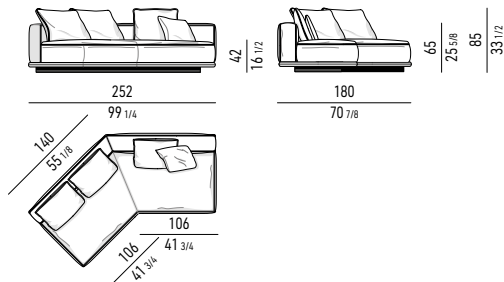

ELEMENTO CENTRALE INCLINATO CM 302 CON TOP SHORT
INCLINED CENTRAL ELEMENT CM 302 WITH TOP SHORT

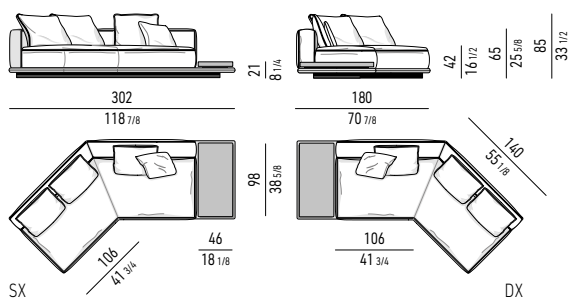

PANCHE | BENCHES

PANCA CM 210X106 CON TOP SQUARE
BENCH CM 210X106 WITH TOP SQUARE

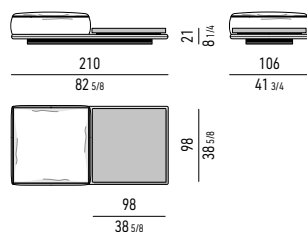

PANCA CM 106X106
BENCH CM 106X106

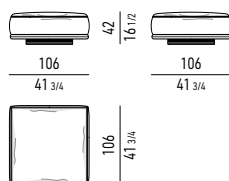

PANCA CM 82X106
BENCH CM 82X106

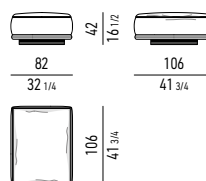

PANCA CM 106X54
BENCH CM 106X54

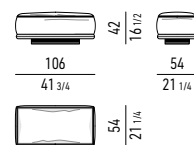

PANCA CM 132X54
BENCH CM 132X54

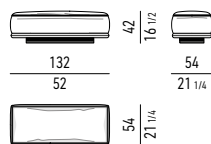

PANCA CM 158X54
BENCH CM 158X54

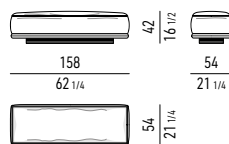

CUSCINI | CUSHIONS

CUSCINO SCHIENALE OPTIONAL CM 60X60
OPTIONAL BACKREST CUSHION CM 60X60

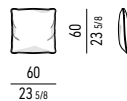

CUSCINO OPTIONAL CM 50X50
OPTIONAL CUSHION CM 50X50

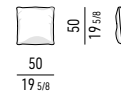

BASE TUTTA IN TESSUTO O PELLE
BASE ALL IN FABRIC OR LEATHER

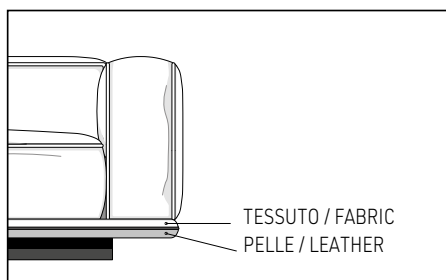

BASE MIX
MIX BASE

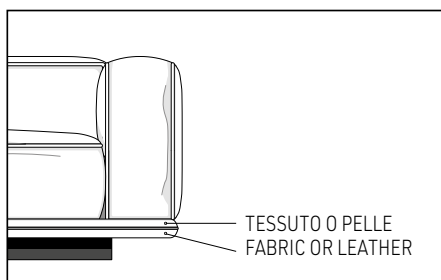

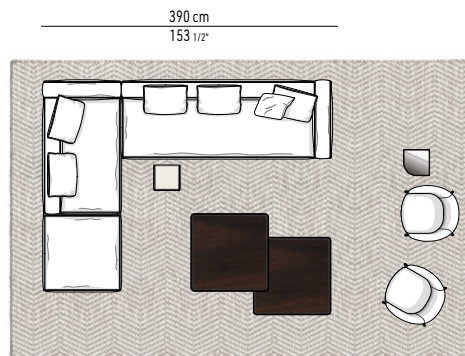

- A**
- 1 Horizonte - elemento terminale dx con pouf cm 284x106 H85
 - 1 Horizonte - elemento terminale dx cm 284x106 H85
 - 1 Horizonte - tavolino cm 104x104 H13
 - 1 Horizonte - tavolino cm 104x104 H21
 - 2 Lido - poltroncine Lounge cm 75x78 H71
 - 1 Solid Saddle-hide - tavolino cm 35x35 H45
 - 1 James - tavolino cm 35x35 H45
 - 1 Osaka Chevron - tappeto cm 616x400
- 1 Horizonte - Endelement mit 1 Armlehne dx mit Hocker cm 284x106 H85
 - 1 Horizonte - Endelement mit 1 Armlehne dx cm 284x106 H85
 - 1 Horizonte - Beistelltisch cm 104x104 H13
 - 1 Horizonte - Beistelltisch cm 104x104 H21
 - 2 Lido - Lounge kleiner Armsessel cm 75x78 H71
 - 1 Solid Saddle-hide - Beistelltisch cm 35x35 H45
 - 1 James - Beistelltisch cm 35x35 H45
 - 1 Osaka Chevron - Teppich cm 616x400
- 1 Horizonte - element with 1 armrest dx with ottoman cm 284x106 H85
 - 1 Horizonte - element with 1 armrest dx cm 284x106 H85
 - 1 Horizonte - coffee table cm 104x104 H13
 - 1 Horizonte - coffee table cm 104x104 H21
 - 2 Lido - Lounge little armchairs cm 75x78 H71
 - 1 Solid Saddle-hide - side table cm 35x35 H45
 - 1 James - side table cm 35x35 H45
 - 1 Osaka Chevron - rug cm 616x400
- 1 Horizonte - élément avec 1 accoudoir dx avec pouf cm 284x106 H85
 - 1 Horizonte - élément avec 1 accoudoir dx cm 284x106 H85
 - 1 Horizonte - petite table cm 104x104 H13
 - 1 Horizonte - petite table cm 104x104 H21
 - 2 Lido - petit fauteuil Lounge cm 75x78 H71
 - 1 Solid Saddle-hide - petite table cm 35x35 H45
 - 1 James - petite table cm 35x35 H45
 - 1 Osaka Chevron - tapis cm 616x400

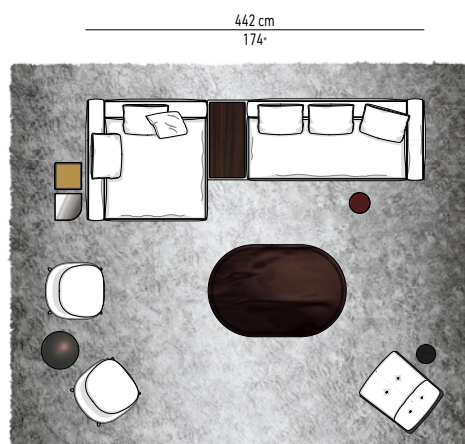

- B**
- 1 Horizonte - Chaise-longue sx cm 158x158 H85
 - 1 Horizonte - elemento terminale dx con TOP SHORT cm 284x106 H85
 - 2 Sendai - poltrone fisse cm 74x76 H72
 - 1 Daiki - poltrona senza braccioli con base girevole cm 73x91 H69
 - 1 Bellagio - tavolino Ø cm 49 H42
 - 1 James - tavolino cm 35x35 H45
 - 1 Solid Saddle-hide - tavolino cm 35x35 H45
 - 1 Louver - tavolino cm 180x120 H25
 - 1 Pilotis - tavolino Ø cm 27 H55
 - 1 Pilotis Wood - tavolino Ø cm 25 H45
 - 1 Wisp Shade - tappeto cm 600x500
- 1 Horizonte - Chaise-longue sx cm 158x158 H85
 - 1 Horizonte - Endelement mit 1 Armlehne dx mit TOP SHORT cm 284x106 H85
 - 2 Sendai - feste Sessel cm 74x76 H72
 - 1 Daiki - Sessel ohne Armlehnen mit drehbar Basis cm 73x91 H69
 - 1 Bellagio - Beistelltisch Ø cm 49 H42
 - 1 James - Beistelltisch cm 35x35 H45
 - 1 Solid Saddle-hide - Beistelltisch cm 35x35 H45
 - 1 Louver - Beistelltisch cm 180x120 H25
 - 1 Pilotis - Beistelltisch Ø cm 27 H55
 - 1 Pilotis Wood - Beistelltisch Ø cm 25 H45
 - 1 Wisp Shade - Teppich cm 600x500
- 1 Horizonte - Chaise-longue sx cm 158x158 H85
 - 1 Horizonte - element with 1 armrest dx with TOP SHORT cm 284x106 H85
 - 2 Sendai - fixed armchairs cm 74x76 H72
 - 1 Daiki - armchair without armrests with swivel base cm 73x91 H69
 - 1 Bellagio - side table Ø cm 49 H42
 - 1 James - side table cm 35x35 H45
 - 1 Solid Saddle-hide - side table cm 35x35 H45
 - 1 Louver - coffee table cm 180x120 H25
 - 1 Pilotis - side table Ø cm 27 H55
 - 1 Pilotis Wood - side table Ø cm 25 H45
 - 1 Wisp Shade - rug cm 600x500
- 1 Horizonte - Chaise-longue sx cm 158x158 H85
 - 1 Horizonte - élément avec 1 accoudoir dx avec TOP SHORT cm 284x106 H85
 - 2 Sendai - fixe fauteuils cm 74x76 H72
 - 1 Daiki - fauteuil sans accoudoirs avec piètement pivotant cm 73x91 H69
 - 1 Bellagio - petite table Ø cm 49 H42
 - 1 James - petite table cm 35x35 H45
 - 1 Solid Saddle-hide - petite table cm 35x35 H45
 - 1 Louver - petite table cm 180x120 H25
 - 1 Pilotis - petite table Ø cm 27 H55
 - 1 Pilotis Wood - petite table Ø cm 25 H45
 - 1 Wisp Shade - tapis cm 600x500

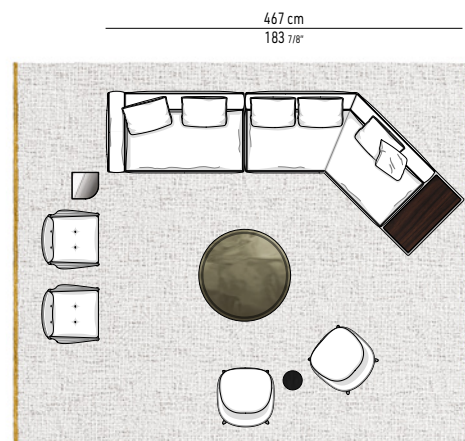

- C**
- 1 Horizonte - elemento terminale sx cm 180x106 H85
 - 1 Horizonte - elemento centrale inclinato sx con TOP SHORT cm 302x180 H85
 - 2 Yoko - poltrone cm 77x75 H73
 - 2 Sendai - poltrone fisse cm 74x76 H72
 - 1 James - tavolino cm 35x35 H45
 - 1 Louver - tavolino Ø cm 120 H25
 - 1 Pilotis Wood - tavolino Ø cm 25 H45
 - 1 Cross - tappeto cm 600x500
- 1 Horizonte - Endelement mit 1 Armlehne sx cm 180x106 H85
 - 1 Horizonte - schräges Mittelelement sx mit TOP SHORT cm 302x180 H85
 - 2 Yoko - Sessel cm 77x75 H73
 - 2 Sendai - feste Sessel cm 74x76 H72
 - 1 James - Beistelltisch cm 35x35 H45
 - 1 Louver - Beistelltisch Ø cm 120 H25
 - 1 Pilotis Wood - Beistelltisch Ø cm 25 H45
 - 1 Cross - Teppich cm 600x500
- 1 Horizonte - element with 1 armrest sx cm 180x106 H85
 - 1 Horizonte - inclined central element sx with TOP SHORT cm 302x180 H85
 - 2 Yoko - armchairs cm 77x75 H73
 - 2 Sendai - fixed armchairs cm 74x76 H72
 - 1 James - side table cm 35x35 H45
 - 1 Louver - coffee table Ø cm 120 H25
 - 1 Pilotis Wood - side table Ø cm 25 H45
 - 1 Cross - rug cm 600x500
- 1 Horizonte - élément avec 1 accoudoir sx cm 180x106 H85
 - 1 Horizonte - élément central incliné sx avec TOP SHORT cm 302x180 H85
 - 2 Yoko - fauteuils cm 77x75 H73
 - 2 Sendai - fauteuils fixe cm 74x76 H72
 - 1 James - petite table cm 35x35 H45
 - 1 Louver - petite table Ø cm 120 H25
 - 1 Pilotis Wood - petite table Ø cm 25 H45
 - 1 Cross - tapis cm 600x500

Minotti

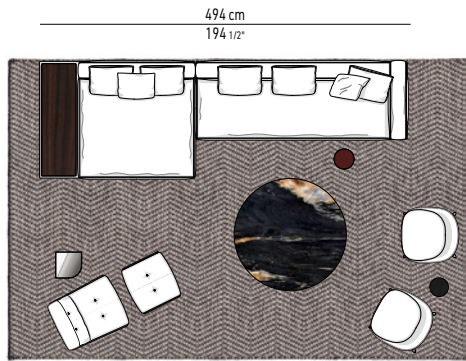

D

- | | | | |
|---|--|---|--|
| 1 | Horizonte - Couch dx con TOP LONG cm 210x158 H85 | 1 | Horizonte - Couch dx mit TOP LONG cm 210x158 H85 |
| 1 | Horizonte - elemento terminale dx cm 284x106 H85 | 1 | Horizonte - Endelement mit 1 Armlehne dx cm 284x106 H85 |
| 1 | Daiki - bergère senza braccioli con base girevole cm 73x94 H93 | 1 | Daiki - Bergère ohne Armlehnen mit drehbar basis cm 73x94 H93 |
| 1 | Daiki - poggiatesta con base cm 68x64 H40 | 1 | Daiki - Hocker mit basis cm 68x64 H40 |
| 2 | Sendai - poltrone fisse cm 74x76 H72 | 2 | Sendai - fest Sessel cm 74x76 H72 |
| 1 | James - tavolino cm 35x35 H45 | 1 | James - Beistelltisch cm 35x35 H45 |
| 1 | Doyle - tavolino Ø cm 150 H25 | 1 | Doyle - Beistelltisch Ø cm 150 H25 |
| 1 | Pilotis - tavolino Ø cm 27 H55 | 1 | Pilotis - Beistelltisch Ø cm 27 H55 |
| 1 | Pilotis Wood - tavolino Ø cm 25 H45 | 1 | Pilotis Wood - Beistelltisch Ø cm 25 H45 |
| 1 | Osaka Chevron - tappeto cm 616x400 | 1 | Osaka Chevron - Teppich cm 616x400 |
| 1 | Horizonte - Couch dx with TOP LONG cm 210x158 H85 | 1 | Horizonte - Couch dx avec TOP LONG cm 210x158 H85 |
| 1 | Horizonte - element with 1 armrest dx cm 284x106 H85 | 1 | Horizonte - élément avec 1 accoudoir dx cm 284x106 H85 |
| 1 | Daiki - bergère without armrests with swivel base cm 73x94 H93 | 1 | Daiki - bergère sans accoudoirs avec piètement pivotant cm 73x94 H93 |
| 1 | Daiki - footstool with base cm 68x64 H40 | 1 | Daiki - repose-pied avec piètement cm 68x64 H40 |
| 2 | Sendai - fixed armchairs cm 74x76 H72 | 2 | Sendai - fauteuils fixem cm 74x76 H72 |
| 1 | James - side table cm 35x35 H45 | 1 | James - petite table cm 35x35 H45 |
| 1 | Doyle - coffee table Ø cm 150 H25 | 1 | Doyle - petite table Ø cm 150 H25 |
| 1 | Pilotis - side table Ø cm 27 H55 | 1 | Pilotis - petite table Ø cm 27 H55 |
| 1 | Pilotis Wood - side table Ø cm 25 H45 | 1 | Pilotis Wood - petite table Ø cm 25 H45 |
| 1 | Osaka Chevron - rug cm 616x400 | 1 | Osaka Chevron - tapis cm 616x400 |

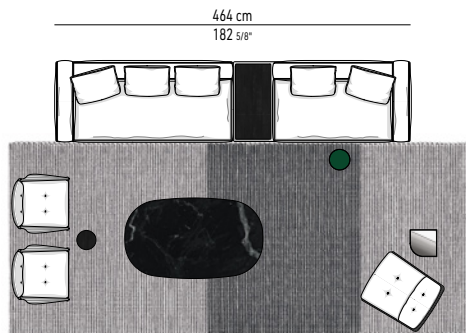

E

- | | | | |
|---|---|---|---|
| 1 | Horizonte - elemento terminale sx cm 232x106 H85 | 1 | Horizonte - Endelement mit 1 Armlehne sx cm 232x106 H85 |
| 1 | Horizonte - elemento terminale dx con TOP SHORT cm 232x106 H85 | 1 | Horizonte - Endelement mit 1 Armlehne dx mit TOP SHORT cm 232x106 H85 |
| 2 | Yoko - poltrone cm 77x75 H73 | 2 | Yoko - Sessel cm 77x75 H73 |
| 1 | Daiki - poltrona senza braccioli con base girevole cm 73x91 H69 | 1 | Daiki - Sessel ohne Armlehnen mit drehbar basis cm 73x91 H69 |
| 1 | Pilotis Wood - tavolino Ø cm 25 H45 | 1 | Pilotis Wood - Beistelltisch Ø cm 25 H45 |
| 1 | Gladstone - tavolino cm 180x105 H25 | 1 | Gladstone - Beistelltisch cm 180x105 H25 |
| 1 | Pilotis - tavolino Ø cm 27 H55 | 1 | Pilotis - Beistelltisch Ø cm 27 H55 |
| 1 | James - tavolino cm 35x35 H45 | 1 | James - Beistelltisch cm 35x35 H45 |
| 1 | Osaka Flag - tappeto cm 600x250 | 1 | Osaka Flag - Teppich cm 600x250 |
| 1 | Horizonte - element with 1 armrest sx cm 232x106 H85 | 1 | Horizonte - élément avec 1 accoudoir sx cm 232x106 H85 |
| 1 | Horizonte - element with 1 armrest dx with TOP SHORT cm 232x106 H85 | 1 | Horizonte - élément avec 1 accoudoir dx avec TOP SHORT cm 232x106 H85 |
| 2 | Yoko - armchairs cm 77x75 H73 | 2 | Yoko - fauteuils cm 77x75 H73 |
| 1 | Daiki - armchair without armrests with swivel base cm 73x91 H69 | 1 | Daiki - fauteuil sans accoudoirs avec piètement pivotant cm 73x91 H69 |
| 1 | Pilotis Wood - side table Ø cm 25 H45 | 1 | Pilotis Wood - petite table Ø cm 25 H45 |
| 1 | Gladstone - coffee table cm 180x105 H25 | 1 | Gladstone - petite table cm 180x105 H25 |
| 1 | Pilotis - side table Ø cm 27 H55 | 1 | Pilotis - petite table Ø cm 27 H55 |
| 1 | James - side table cm 35x35 H45 | 1 | James - petite table cm 35x35 H45 |
| 1 | Osaka Flag - rug cm 600x250 | 1 | Osaka Flag - tapis cm 600x250 |

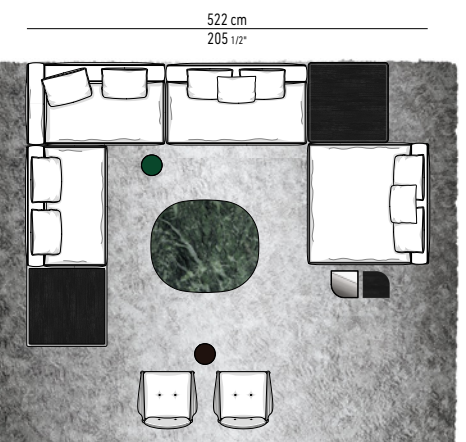

F

- | | | | |
|---|--|---|---|
| 1 | Horizonte - elemento centrale dx con TOP SQUARE cm 262x106 H85 | 1 | Horizonte - Mittelelement dx mit TOP SQUARE cm 262x106 H85 |
| 1 | Horizonte - elemento terminale sx cm 180x106 H85 | 1 | Horizonte - Endelement mit 1 Armlehne sx cm 180x106 H85 |
| 1 | Horizonte - elemento centrale cm 184x106 H85 | 1 | Horizonte - Mittelelement cm 184x106 H85 |
| 1 | Horizonte - side table cm 104x104 H13 | 1 | Horizonte - side table cm 104x104 H13 |
| 1 | Horizonte - couch cm 158x158 H85 | 1 | Horizonte - couch cm 158x158 H85 |
| 2 | Yoko - poltrone cm 77x75 H73 | 2 | Yoko - Sessel cm 77x75 H73 |
| 1 | Pilotis Wood - tavolino Ø cm 25 H45 | 1 | Pilotis Wood - Beistelltisch Ø cm 25 H45 |
| 1 | Gladstone - tavolino cm 140x120 H25 | 1 | Gladstone - Beistelltisch cm 140x120 H25 |
| 1 | Pilotis - tavolino Ø cm 27 H55 | 1 | Pilotis - Beistelltisch Ø cm 27 H55 |
| 2 | James - tavolini cm 35x35 H45 | 2 | James - Beistelltisch cm 35x35 H45 |
| 1 | Wisp Shade - tappeto cm 600x500 | 1 | Wisp Shade - Teppich cm 600x500 |
| 1 | Horizonte - central element dx with TOP SQUARE cm 262x106 H85 | 1 | Horizonte - élément central dx avec TOP SQUARE cm 262x106 H85 |
| 1 | Horizonte - element with 1 armrest sx cm 180x106 H85 | 1 | Horizonte - élément avec 1 accoudoir sx cm 180x106 H85 |
| 1 | Horizonte - central element cm 184x106 H85 | 1 | Horizonte - élément central cm 184x106 H85 |
| 1 | Horizonte - side table cm 104x104 H13 | 1 | Horizonte - side table cm 104x104 H13 |
| 1 | Horizonte - couch cm 158x158 H85 | 1 | Horizonte - couch cm 158x158 H85 |
| 2 | Yoko - armchairs cm 77x75 H73 | 2 | Yoko - fauteuils cm 77x75 H73 |
| 1 | Pilotis Wood - side table Ø cm 25 H45 | 1 | Pilotis Wood - petite table Ø cm 25 H45 |
| 1 | Gladstone - coffee table cm 140x120 H25 | 1 | Gladstone - petite table cm 140x120 H25 |
| 1 | Pilotis - side table Ø cm 27 H55 | 1 | Pilotis - petite table Ø cm 27 H55 |
| 2 | James - side tables cm 35x35 H45 | 2 | James - petite tables cm 35x35 H45 |
| 1 | Wisp Shade - rug cm 600x500 | 1 | Wisp Shade - tapis cm 600x500 |

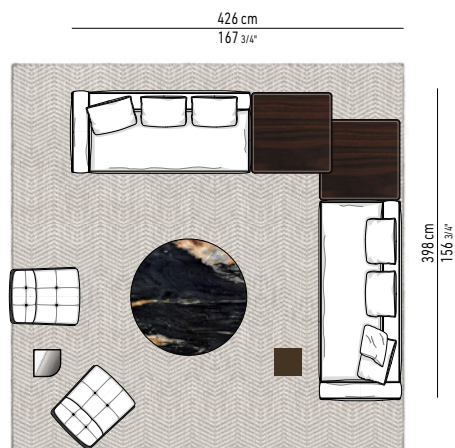

G

- | | |
|---|---|
| <ul style="list-style-type: none"> 1 Horizonte - elemento terminale sx cm 232x106 H85 1 Horizonte - tavolino cm 104x104 H21 1 Horizonte - tavolino cm 104x104 H13 1 Horizonte - elemento terminale dx cm 258x106 H85 2 Daiki - poltrone senza braccioli con base girevole cm 73x91 H69 1 James - tavolino cm 35x35 H45 1 Doyle - tavolino cm Ø 150 H25 1 Solid Saddle-hide - tavolino cm 35x35 H45 1 Osaka Chevron - tappeto cm 504x500 | <ul style="list-style-type: none"> 1 Horizonte - Endelement mit 1 Armlehne sx cm 232x106 H85 1 Horizonte - Beistelltisch cm 104x104 H21 1 Horizonte - Beistelltisch cm 104x104 H13 1 Horizonte - Endelement mit 1 Armlehne dx cm 258x106 H85 2 Daiki - Sessel ohne Armlehnen mit drehbar basis cm 73x91 H69 1 James - Beistelltisch cm 35x35 H45 1 Doyle - Beistelltisch cm Ø 150 H25 1 Solid Saddle-hide - Beistelltisch cm 35x35 H45 1 Osaka Chevron - Teppich cm 504x500 |
| <ul style="list-style-type: none"> 1 Horizonte - element with 1 armrest sx cm 232x106 H85 1 Horizonte - coffee table cm 104x104 H21 1 Horizonte - coffee table cm 104x104 H13 1 Horizonte - element with 1 armrest dx cm 258x106 H85 2 Daiki - armchairs without armrests with swivel base cm 73x91 H69 1 James - side table cm 35x35 H45 1 Doyle - coffee table cm Ø 150 H25 1 Solid Saddle-hide - side table cm 35x35 H45 1 Osaka Chevron - rug cm 504x500 | <ul style="list-style-type: none"> 1 Horizonte - élément avec 1 accoudoir sx cm 232x106 H85 1 Horizonte - petite table cm 104x104 H21 1 Horizonte - petite table cm 104x104 H13 1 Horizonte - élément avec 1 accoudoir dx cm 258x106 H85 2 Daiki - fauteuils sans accoudoirs avec piètement pivotant cm 73x91 H69 1 James - petite table cm 35x35 H45 1 Doyle - petite table cm Ø 150 H25 1 Solid Saddle-hide - petite table cm 35x35 H45 1 Osaka Chevron - tapis cm 504x500 |

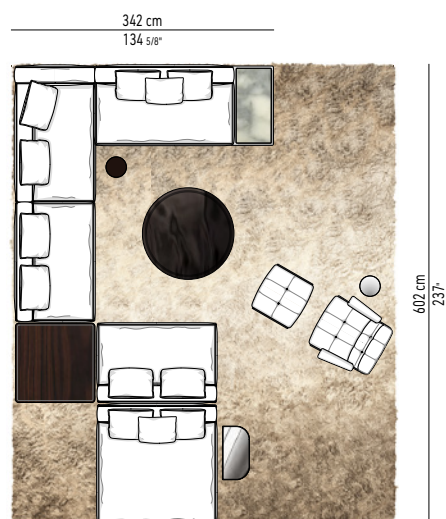

H

- | | |
|---|---|
| <ul style="list-style-type: none"> 1 Horizonte - elemento centrale sx con TOP SHORT cm 236x106 H85 1 Horizonte - elemento terminale dx cm 180x106 H85 2 Horizonte - elementi centrali cm 158x106 H85 1 Horizonte - side table cm 104x104 H13 1 Horizonte - couch cm 158x158 H85 1 Daiki - bergère con base girevole cm 94x94 H93 1 Daiki - poggiatesta con base cm 68x64 H40 2 Pilotis - tavolini Ø cm 27 H45 1 James - tavolino cm 70x35 H45 1 Louver - tavolino cm 120 H25 1 Superquadra - contenitore orizzontale Living/Tv sx cm 273,5x60 H48,5 1 Wisp Shade - tappeto cm 600x500 | <ul style="list-style-type: none"> 1 Horizonte - Mittelelement sx mit TOP SHORT cm 236x106 H85 1 Horizonte - Endelement mit 1 Armlehne dx cm 180x106 H85 2 Horizonte - Mittelelemente cm 158x106 H85 1 Horizonte - Side table cm 104x104 H13 1 Horizonte - Couch cm 158x158 H85 1 Daiki - Bergère mit drehbar basis cm 94x94 H93 1 Daiki - Hocker mit basis cm 68x64 H40 2 Pilotis - Beistelltische Ø cm 27 H45 1 James - Beistelltische cm 70x35 H45 1 Louver - Beistelltische Ø cm 120 H25 1 Superquadra - Living/Tv horizontales Sideboard sx cm 273,5x60 H48,5 1 Wisp Shade - Teppich cm 600x500 |
| <ul style="list-style-type: none"> 1 Horizonte - central element sx with TOP SHORT cm 236x106 H85 1 Horizonte - element with 1 armrest dx cm 180x106 H85 2 Horizonte - central elements cm 158x106 H85 1 Horizonte - side table cm 104x104 H13 1 Horizonte - couch cm 158x158 H85 1 Daiki - bergère with swivel base cm 94x94 H93 1 Daiki - footstool with base cm 68x64 H40 2 Pilotis - side tables Ø cm 27 H45 1 James - side table cm 70x35 H45 1 Louver - side table Ø cm 120 H25 1 Superquadra - Living/Tv horizontal sideboard sx cm 273,5x60 H48,5 1 Wisp Shade - rug cm 600x500 | <ul style="list-style-type: none"> 1 Horizonte - élément central sx avec TOP SHORT cm 236x106 H85 1 Horizonte - élément avec 1 accoudoir dx cm 180x106 H85 2 Horizonte - éléments central cm 158x106 H85 1 Horizonte - side table cm 104x104 H13 1 Horizonte - couch cm 158x158 H85 1 Daiki - bergère avec piètement pivotant cm 94x94 H93 1 Daiki - repose-pied avec piètement cm 68x64 H40 2 Pilotis - petite tables Ø cm 27 H45 1 James - petite table cm 70x35 H45 1 Louver - petite table Ø cm 120 H25 1 Superquadra - bahut horizontal Living/Tv sx cm 273,5x60 H48,5 1 Wisp Shade - tapis cm 600x500 |

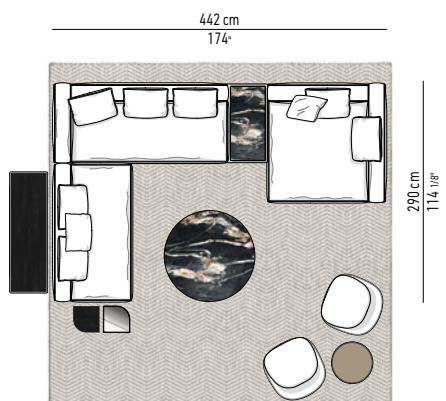
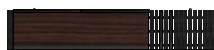

I

- | | |
|--|---|
| <ul style="list-style-type: none"> 1 Horizonte - elemento centrale cm 184x106 H85 1 Horizonte - elemento terminale sx con TOP SHORT cm 284x106 H85 1 Horizonte - Chaise-Longue dx cm 158x158 H85 2 Sendai - poltrone girevoli cm 74x76 H68 1 Lelong - consolle cm 160x50 H59 2 James - tavolini cm 35x35 H45 1 Doyle - tavolino Ø cm 120 H25 1 Lelong - tavolino Ø cm 55 H45 1 Osaka Chevron - tappeto cm 448x450 | <ul style="list-style-type: none"> 1 Horizonte - Mittelelement cm 184x106 H85 1 Horizonte - Endelement mit 1 Armlehne sx mit TOP SHORT cm 284x106 H85 1 Horizonte - Chaise-Longue dx cm 158x158 H85 2 Sendai - Sessel drehbar cm 74x76 H68 1 Lelong - Konsole cm 160x50 H59 2 James - Beistelltische cm 35x35 H45 1 Doyle - Beistelltisch Ø cm 120 H25 1 Lelong - Beistelltisch Ø cm 55 H45 1 Osaka Chevron - Teppich cm 448x450 |
| <ul style="list-style-type: none"> 1 Horizonte - central element cm 184x106 H85 1 Horizonte - element with 1 armrest sx with TOP SHORT cm 284x106 H85 1 Horizonte - Chaise-Longue dx cm 158x158 H85 2 Sendai - swivel armchairs cm 74x76 H68 1 Lelong - console table cm 160x50 H59 2 James - side tables cm 35x35 H45 1 Doyle - coffee table Ø cm 120 H25 1 Lelong - side table Ø cm 55 H45 1 Osaka Chevron - rug cm 448x450 | <ul style="list-style-type: none"> 1 Horizonte - élément central cm 184x106 H85 1 Horizonte - élément avec 1 accoudoir sx avec TOP SHORT cm 284x106 H85 1 Horizonte - Chaise-Longue dx cm 158x158 H85 2 Sendai - fauteuils pivotante cm 74x76 H68 1 Lelong - console cm 160x50 H59 2 James - petite tables cm 35x35 H45 1 Doyle - petite table Ø cm 120 H25 1 Lelong - petite table Ø cm 55 H45 1 Osaka Chevron - tapis cm 448x450 |