





Lounge chair

Hunter





Hunter

HARDWOOD

	Soaped oak
	White oiled oak
	Oiled oak
	Oiled walnut
	Black lacq. oak

ANILINE LEATHER RANGE: SADDLE

	Natural
	Cognac
	Black

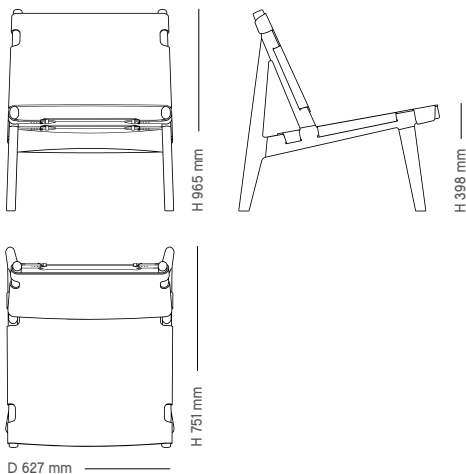

The way that the saddle leather is stretched around the wooden frame with adjustable belts, makes this a perfect example of the category "hunting chairs". These lounge chairs were immensely popular in the 1950s-60s and have now defined themselves as modern-day classics. Afdal graduated from the Norwegian National Academy of Craft and Art Industry in 1946 and worked his whole career for the legendary Tegnkontoret Bruksbo. Afdal designed the frame with a minimalistic aesthetic focusing on a fluid and organic form in contrast to other hunting chairs. "Simplicity" is a good description of the Hunter composition. This can be seen in the double layered leather with its matching edge stitching, together with its solid cast brass buckles. The Hunter lounge chair is a highly detailed piece with craftsmanship to last for generations.

Designed in 1960