

SmartLogger1000

User Manual

Issue 11
Date 2018-03-10

Copyright © Huawei Technologies Co., Ltd. 2018. All rights reserved.

No part of this document may be reproduced or transmitted in any form or by any means without prior written consent of Huawei Technologies Co., Ltd.

Trademarks and Permissions



and other Huawei trademarks are trademarks of Huawei Technologies Co., Ltd.

All other trademarks and trade names mentioned in this document are the property of their respective holders.

Notice

The purchased products, services and features are stipulated by the contract made between Huawei and the customer. All or part of the products, services and features described in this document may not be within the purchase scope or the usage scope. Unless otherwise specified in the contract, all statements, information, and recommendations in this document are provided "AS IS" without warranties, guarantees or representations of any kind, either express or implied.

The information in this document is subject to change without notice. Every effort has been made in the preparation of this document to ensure accuracy of the contents, but all statements, information, and recommendations in this document do not constitute a warranty of any kind, express or implied.

Huawei Technologies Co., Ltd.

Address: Huawei Industrial Base
Bantian, Longgang
Shenzhen 518129
People's Republic of China

Website: <http://e.huawei.com>

About This Document

Purpose

This document introduces the SmartLogger1000 (**SmartLogger** for short) in terms of installation, cable connections, system operation and maintenance, and troubleshooting. Readers should understand the SmartLogger features, functions, and safety precautions provided in this document before installing and operating the SmartLogger.





You can print the document based on your requirements. Save the paper copy properly for future use. You can also download the latest manual from <http://e.huawei.com/>.

Intended Audience

This document is intended for photovoltaic (PV) power plant personnel and qualified electrical technicians.

Symbol Conventions

The symbols that may be found in this document are defined as follows.

Symbol	Overview
 DANGER	Indicates an imminently hazardous situation which, if not avoided, will result in serious injury or death.
 WARNING	Indicates a potentially hazardous situation which, if not avoided, could result in serious injury or death.
 CAUTION	Indicates a potentially hazardous situation which, if not avoided, may result in minor or moderate injury.
 NOTICE	Indicates a potentially hazardous situation which, if not avoided, could result in equipment damage, data loss, performance deterioration, or unanticipated results. NOTICE is used to address practices not related to personal injury.

Symbol	Overview
 NOTE	<p>Calls attention to important information, best practices and tips.</p> <p>NOTE is used to address information not related to personal injury, equipment damage, and environment deterioration.</p>

Change History

Changes between document issues are cumulative. The latest document issue contains all updates made in previous issues.

Issue 11 (2018-03-10)

Updated [3.2 Checking Before Installation](#).

Added [6.2.12 Setting PLC Running Parameters](#).

[7.8.3.2 Setting Running Parameters \(Advanced User\)](#) added related parameters of the 1100 V inverters.

[7.8.3.3 Setting Running Parameters \(Special User\)](#) added related parameters of the 1100 V inverters.

Added [7.10.8 Setting DI Parameters](#).

Added [7.10.9 Setting Export Limitation Parameters](#).

Added [8.3.10 Distributed Power Factor Closed-Loop Control](#).

Issue 10 (2017-08-30)

Added [4.4.2 Connecting the SUN2000L to the SmartLogger](#).

Added [4.5.3 Connecting the SmartLogger to a Split EMI](#).

Updated the LCD screen snapshots in [6 User Interface](#).

Added [6.2.24 Setting the CO2 Emission Reduction Coefficient](#).

Updated the WebUI pages in [7 WebUI](#).

Updated [7.8.3.2 Setting Running Parameters \(Advanced User\)](#).

Updated [7.8.3.3 Setting Running Parameters \(Special User\)](#).

Added [7.10.5 Alarm Output](#).

Added [7.11.7 Managing the License](#).

Issue 09 (2016-08-15)

Added [3.6 Installing the RS485 signal SPD](#).

Added [4.2 Connecting the PE Cable for the RS485 Signal SPD](#).

Added [4.3 Connecting the RS485 Signal SPD](#).

Updated [4.4.1 Connecting the SmartLogger to the SUN2000](#).

Updated [4.5.2 Connecting the SmartLogger to an EMI That Supports Standard Modbus-RTU](#).

Updated [4.8 Connecting an Ethernet Network Cable](#).

Added [6.2.4 Sending a Reset Command to the Inverter](#).

Added [6.2.35 Resetting the System](#).

Added [7.8.3.4 Setting a Tracking System](#).

Added [7.8.3.5 Setting the LVRT Characteristic Curve](#).

Issue 08 (2015-08-20)

Added [6.2.31 Exporting All Files](#).

Added [6.2.32 Importing All Files](#).

Added [7.10.2.6 Setting Modbus TCP Parameters](#).

Issue 07 (2015-01-20)

Added [4.9 Connecting to a PID](#).

Added PLC information query and parameter settings.

Added PID information query and parameter settings.

Added [7.11.6 Site Test](#).

Updated [7.11.8 Device Management](#).

Issue 06 (2014-09-20)

Added [7.8.6 Power Meter](#).

Added [7.10.2.7 Setting IEC103 Parameters](#).

Issue 05 (2014-05-20)

Added [4.6 Connecting the SmartLogger to a Power Meter](#).

Added [6.2.6 Querying Master SmartLogger Information](#).

Added [6.2.7 Querying Slave SmartLogger Information](#).

Added [6.2.8 Querying Information About the Modbus Power Meter](#).

Added [6.2.22 Setting SmartLogger Contrast](#).

Added [7.6 WebUI Layout](#).

Added [7.8.2 SmartLogger](#).

Added [7.10.2.4 Setting Power Meter Parameters](#).

Added [9.3 Alarms](#).

Issue 04 (2013-12-01)

This is the fourth official release.

Added **Server+Client** mode as a NetEco parameter in [6.2.26 Setting Communications Parameters](#).

Added the address allocation in [6.2.33 Managing Devices](#).

Added the setting of USB parameters in [7.10.4.2 Setting USB Parameters](#).

Updated part of the web user interface (WebUI).

Issue 03 (2013-09-10)

This is the third official release.

Compared with the second official release, this document updated some operations and figures for the LCD and WebUI.

Issue 02 (2013-06-06)

This is the second official release.

Issue 01 (2013-04-25)

This is the first official release.

Compared with the original draft, this document updated some operations and figures for the LCD and WebUI.

Contents

About This Document	ii
1 Safety Precautions	1
1.1 Precautions.....	1
1.2 Symbols.....	2
2 Overview	3
2.1 Product Introduction.....	3
2.2 Appearance.....	5
2.3 Monitoring Panel.....	8
2.4 Typical Cable Connection Scenarios.....	11
3 Installation	15
3.1 Installation Process.....	15
3.2 Checking Before Installation.....	17
3.3 Preparing Tools.....	17
3.4 Determining the Installation Position.....	19
3.5 Installing the SmartLogger.....	20
3.5.1 Installing the SmartLogger on a Desk.....	20
3.5.2 Mounting the SmartLogger on a Wall.....	21
3.5.3 Mounting the SmartLogger Along a Guide Rail.....	22
3.6 Installing the RS485 signal SPD.....	24
4 Electrical Connections	26
4.1 Connection Description.....	26
4.2 Connecting the PE Cable for the RS485 Signal SPD.....	27
4.3 Connecting the RS485 Signal SPD.....	28
4.4 Connecting the SmartLogger to Inverters.....	31
4.4.1 Connecting the SmartLogger to the SUN2000.....	31
4.4.2 Connecting the SUN2000L to the SmartLogger.....	37
4.4.3 Connecting Multiple Inverters to the SmartLogger.....	41
4.5 Connecting to an EMI.....	42
4.5.1 Connection Description.....	42
4.5.2 Connecting the SmartLogger to an EMI That Supports Standard Modbus-RTU.....	42
4.5.3 Connecting the SmartLogger to a Split EMI.....	44

4.6 Connecting the SmartLogger to a Power Meter.....	46
4.7 Connecting to a PLC.....	48
4.8 Connecting an Ethernet Network Cable	50
4.9 Connecting to a PID.....	51
4.10 Connecting the SmartLogger to a Ripple Control Receiver	52
5 System Operation.....	55
5.1 Power-on Process.....	55
5.2 Setting Initialization Parameters	56
6 User Interface.....	59
6.1 Monitoring Menu Hierarchy	59
6.2 Monitoring Operations.....	61
6.2.1 Querying Power Station Information	61
6.2.2 Querying Inverter Information.....	66
6.2.3 Manually Powering On or Off the Inverter on the monitoring panel.....	69
6.2.4 Sending a Reset Command to the Inverter.....	71
6.2.5 Querying Information about the EMI	73
6.2.6 Querying Master SmartLogger Information	75
6.2.7 Querying Slave SmartLogger Information	77
6.2.8 Querying Information About the Modbus Power Meter	78
6.2.9 Querying Information About the DL/T645 Power Meter	80
6.2.10 Setting DL/T645 Power Meter Parameters	82
6.2.11 Querying PLC Information	84
6.2.12 Setting PLC Running Parameters	87
6.2.13 Sending a Reset Command to the PLC.....	89
6.2.14 Querying PID Information.....	91
6.2.15 Setting the PID Module Running Parameters	93
6.2.16 Manually Powering On or Off the PID on the monitoring panel.....	97
6.2.17 Clearing Historical PID Information	100
6.2.18 Querying Custom Device Information.....	102
6.2.19 Querying Alarm Records	103
6.2.20 Setting the System Language.....	107
6.2.21 Setting System Time Parameters	108
6.2.22 Setting SmartLogger Contrast.....	110
6.2.23 Setting the Currency and Currency Factor.....	112
6.2.24 Setting the CO ₂ Emission Reduction Coefficient	115
6.2.25 Changing a Password.....	116
6.2.26 Setting Communications Parameters	119
6.2.27 Restoring Factory Settings.....	124
6.2.28 Downloading Device Data Using a USB Flash Drive	126
6.2.29 Upgrading Firmware by Using a USB Flash Drive	128
6.2.30 Batch Upgrade	131

6.2.31 Exporting All Files.....	133
6.2.32 Importing All Files.....	135
6.2.33 Managing Devices	136
6.2.34 Clearing Data.....	145
6.2.35 Resetting the System.....	147
6.2.36 Querying Product Information	149
7 WebUI.....	150
7.1 Note	150
7.2 Preparations for Login	150
7.3 Logging In to the WebUI	154
7.4 WebUI Menu.....	155
7.5 Icon Description.....	160
7.6 WebUI Layout.....	161
7.7 Overview	162
7.7.1 Plant Running Information	162
7.7.2 Active Alarm.....	162
7.7.3 Plant Yield.....	163
7.7.4 Performance Data	164
7.7.5 Device Running Information	164
7.8 Device Monitoring.....	165
7.8.1 Querying Device Status	165
7.8.2 SmartLogger	165
7.8.2.1 Querying Master SmartLogger-Related Information	165
7.8.2.2 Querying Slave SmartLogger-Related Information	166
7.8.3 Inverter.....	167
7.8.3.1 Querying Related Information	167
7.8.3.2 Setting Running Parameters (Advanced User)	168
7.8.3.3 Setting Running Parameters (Special User).....	177
7.8.3.4 Setting a Tracking System	194
7.8.3.5 Setting the LVRT Characteristic Curve.....	194
7.8.4 PLC.....	195
7.8.4.1 Querying Related Information	195
7.8.4.2 Setting the STA List	196
7.8.4.3 Networking Settings	197
7.8.5 EMI.....	199
7.8.5.1 Querying Related Information	199
7.8.6 Power Meter.....	200
7.8.6.1 Querying Related Information	200
7.8.6.2 Setting Running Parameters.....	201
7.8.7 PID.....	202
7.8.7.1 Querying Related Information	202

7.8.7.2 Setting Running Parameters.....	203
7.8.8 Custom Device, IEC103 Device, or IEC104 Device	206
7.8.8.1 Querying Related Information	206
7.8.8.2 Setting Telecontrol Parameters	207
7.8.8.3 Setting Teleadjust Parameters	208
7.9 Querying Historical Data	209
7.9.1 Querying Historical Alarms	209
7.9.2 Querying Operation Logs	209
7.9.3 Exporting Data.....	210
7.10 Settings	212
7.10.1 User Parameters	212
7.10.1.1 Setting the Date and Time.....	212
7.10.1.2 Setting Plant Information.....	213
7.10.1.3 Setting Gain Parameters.....	214
7.10.2 Communications Parameters	215
7.10.2.1 Setting Ethernet Parameters	215
7.10.2.2 Setting RS485 Parameters.....	215
7.10.2.3 Setting EMI Parameters	216
7.10.2.4 Setting Power Meter Parameters.....	218
7.10.2.5 Setting NetEco Parameters	220
7.10.2.6 Setting Modbus TCP Parameters	221
7.10.2.7 Setting IEC103 Parameters	222
7.10.2.8 Setting IEC104 Parameters	223
7.10.3 Extended Parameters.....	224
7.10.3.1 Setting FTP Parameters.....	224
7.10.3.2 Setting Email Parameters.....	225
7.10.4 Port Settings.....	226
7.10.4.1 Setting DO Parameters.....	226
7.10.4.2 Setting USB Parameters.....	229
7.10.5 Alarm Output	231
7.10.6 Setting Extended Ports.....	232
7.10.7 Dry contact remote shutdown	233
7.10.8 Setting DI Parameters	236
7.10.9 Setting Export Limitation Parameters	237
7.11 Maintenance.....	239
7.11.1 Upgrading Firmware	239
7.11.2 Product Information	239
7.11.3 Setting Security Parameters	239
7.11.4 System Maintenance	239
7.11.5 Device Log.....	239
7.11.6 Site Test.....	239
7.11.7 Managing the License	239

7.11.8 Device Management	239
7.11.8.1 Connecting Devices	239
7.11.8.2 Device List	239
7.11.8.3 Exporting Parameters	239
7.11.8.4 Clearing Alarms	239
7.11.8.5 Re-collecting Performance Data	239
7.11.8.6 Correcting the Total Energy Yield.....	239
8 Power Grid Scheduling.....	240
8.1 Power Adjustment Description	240
8.2 Active Power Adjustment	242
8.2.1 Disabling Active Power Derating	242
8.2.2 Dry Contact Remote Control	243
8.2.3 Percentage Fix Limitation.....	244
8.2.4 Remote Scheduling.....	245
8.2.5 AI Remote Control.....	246
8.2.6 Remote Output Control.....	247
8.3 Reactive Power Adjustment	249
8.3.1 Disabling Reactive Power Output.....	249
8.3.2 Dry Contact Remote Control	249
8.3.3 Reactive Power Fix Control.....	250
8.3.4 Power Factor Fix Control	251
8.3.5 Q-U Characteristic Curve	252
8.3.6 cos(Phi)-P/Pn Characteristic Curve	253
8.3.7 Q-U Hysteresis Curve (CEI0-16).....	254
8.3.8 Remote Scheduling.....	255
8.3.9 Power Factor Closed-Loop Control	256
8.3.10 Distributed Power Factor Closed-Loop Control	257
9 Maintenance	259
9.1 Routine Maintenance	259
9.2 Troubleshooting	259
9.3 Alarms.....	261
10 Disposing of the SmartLogger.....	263
11 Technical Specifications	264
A Monitoring User List	266
B Acronyms and Abbreviations	267

1 Safety Precautions

Read the safety precautions carefully. Otherwise, human injury and equipment damage may occur.

1.1 Precautions

This topic describes the precautions for installing and operating the SmartLogger.

Personnel Requirements

- Only qualified and trained electrical technicians are allowed to install and operate the SmartLogger.
- Operation personnel should understand the composition and working principles of the PV grid-tied power generating system and local regulations.



NOTICE

Read this document thoroughly before operations. Huawei shall not be liable for any consequence caused by violation of the storage, transportation, installation, and operation regulations specified in this document.

Identification Protection

- The signs on the SmartLogger shell specify important information about secure operations. Do not damage the signs.
- The nameplate attached to the bottom of the SmartLogger lists the SmartLogger parameters. Do not damage the nameplate.

Installation

- Before installing the SmartLogger, ensure that it is not connected or energized.
- Install the SmartLogger in well-ventilated environments to ensure system performance.
- Ensure that the heat dissipation holes of the SmartLogger are not blocked.

- Do not move the components inside the shelf except for the wiring terminals at the bottom.

Operation



NOTICE

Strictly comply with the safety precautions in this document and associated documents to operate the SmartLogger.

When operating the SmartLogger, follow local laws and regulations.

Maintenance and Replacement

- A faulty SmartLogger requires overall maintenance. Contact the dealer if any fault occurs in the SmartLogger shelf.
- Maintain the SmartLogger after you get familiar with this document and tools and testing equipment are available.
- When maintaining the SmartLogger, wear ESD gloves and comply with ESD precautions.

1.2 Symbols

The following table describes all symbols on the SmartLogger.

Symbol	Name	Meaning
	CE certification label	This product complies with the Conformance Européenne (CE) certification standards.
	VCCI certification label	This product complies with Voluntary Control Council for Interference by Information Technology Equipment (VCCI) certification standards.
	Environmentally friendly use period (EFUP) label	This product does not pollute the environment during a specified period.
	EU waste electrical and electronic equipment (WEEE) label	Do not dispose of the SmartLogger as household garbage. For details about how to deal with the undesirable SmartLogger, refer to 10 Disposing of the SmartLogger .

2 Overview

This topic describes the SmartLogger in terms of functions, networking applications, product features, appearance, and the monitoring panel.

2.1 Product Introduction

This section describes the SmartLogger in terms of functions, networking applications, and product features.

Functions

The SmartLogger is dedicated for monitoring and managing the PV power generating system. It converges all ports, converts protocols, collects and stores data, and centrally monitors and maintains the PV power generating system.

Networking

The SmartLogger applies to a PV system.

- It can monitor Huawei inverters, PID, and other devices.
- It supports third-party devices such as inverters, environment monitoring instruments, box-type transformers, and smart meters that use the standard Modbus protocol or provide RS485 ports.
- It can simultaneously connect to the Huawei and third-party network management systems by using the Modbus-TCP and IEC104 protocols.
- It can connect to a multi-functional power meter over DLT645.

The SmartLogger networking is shown in [Figure 2-1](#).

Figure 2-1 SmartLogger networking

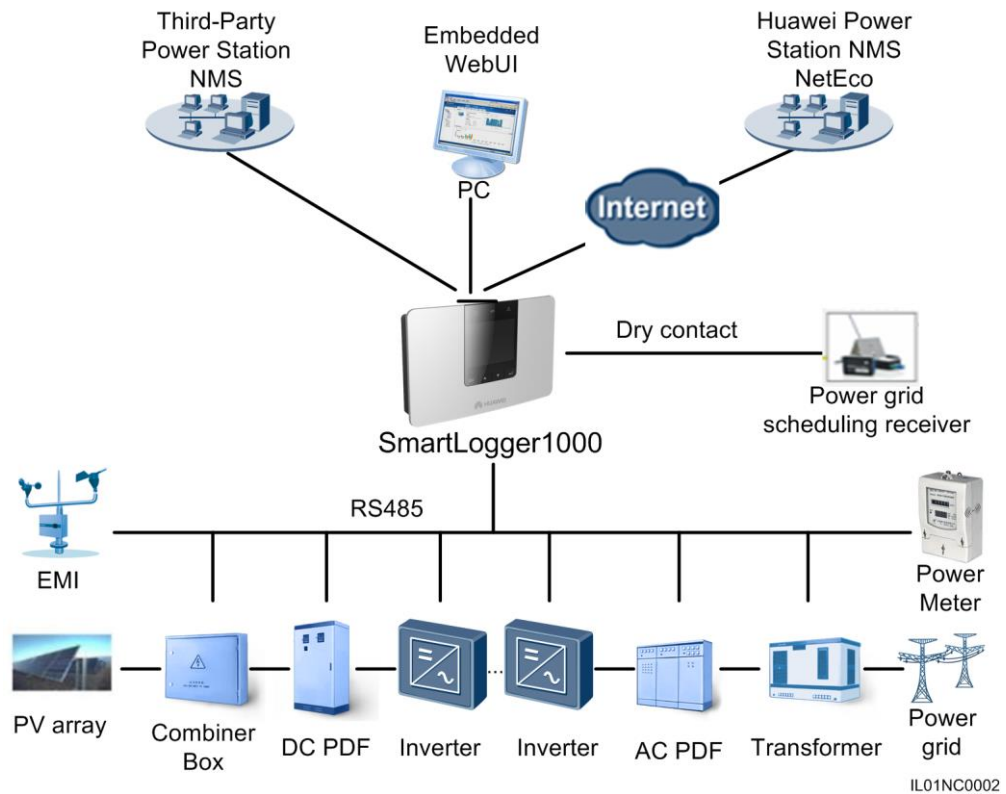

Features

The SmartLogger has the following features:

- Central monitoring
 - Centrally monitors a maximum of 80 devices.
 - Allows users to view information about the power station, devices, products, and alarms, set parameters, and maintain devices on the liquid crystal display (LCD).
 - Allows users to monitor and manage the PV power generating system on the embedded WebUI, for example, viewing real-time information about the power station, devices, and faults, and setting device parameters in remote mode.
- Graphical data
 - Displays energy yields and real-time monitoring information on the LCD in graphics and texts.
 - Displays energy yields, real-time monitoring information, and performance data of the power station and devices on the embedded WebUI in tables and curves.
- Convenient maintenance
 - Allows users to upgrade the firmware of the SmartLogger and inverters and export data by using a USB flash drive.
 - Allows users to upgrade the firmware of the SmartLogger or inverters and export logs over the embedded WebUI.
- Grid dispatching

Supports power grid dispatching: active power reduction and reactive power compensation.

- Intelligent management
 - Automatically scans and identifies Huawei inverters and supports protocol conversion for third-party devices
 - Supports access from third-party devices that use the standard Modbus-RTU protocol.
 - Automatically assigns RS485 addresses to the connected inverters and allows for adjusting RS485 addresses based on device sequence numbers to facilitate remote configuration and maintenance.
 - Supports remote setting of inverter parameters and synchronizes the parameters of one inverter to other inverters in batches.
- Remote maintenance
 - Supports connection to Huawei NetEco and a third-party network management system (NMS) simultaneously using Modbus-TCP and IEC104 to remotely manage all devices.
 - Allows users to access a third-party NMS over the File Transfer Protocol (FTP).
 - Sends energy yield and fault information to users by emails.

2.2 Appearance

This topic describes the SmartLogger in terms of its appearance and specifications.

Front View of the Shell

Figure 2-2 Front view of the SmartLogger

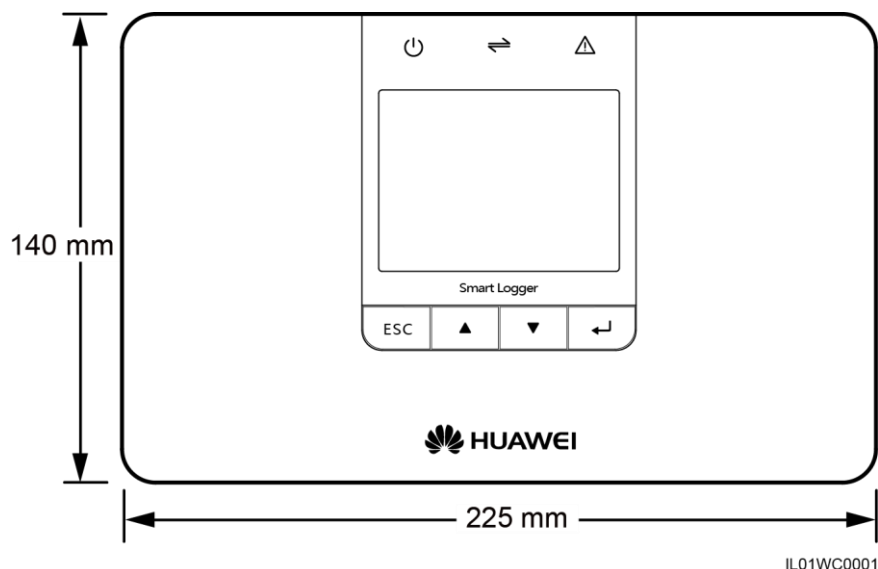



NOTE

The LCD on the SmartLogger monitoring panel displays information about the power site, devices, alarms, and products. This topic describes how to set parameters and maintain devices over the monitoring panel.

Side View of the shell

Figure 2-3 Side view of the SmartLogger

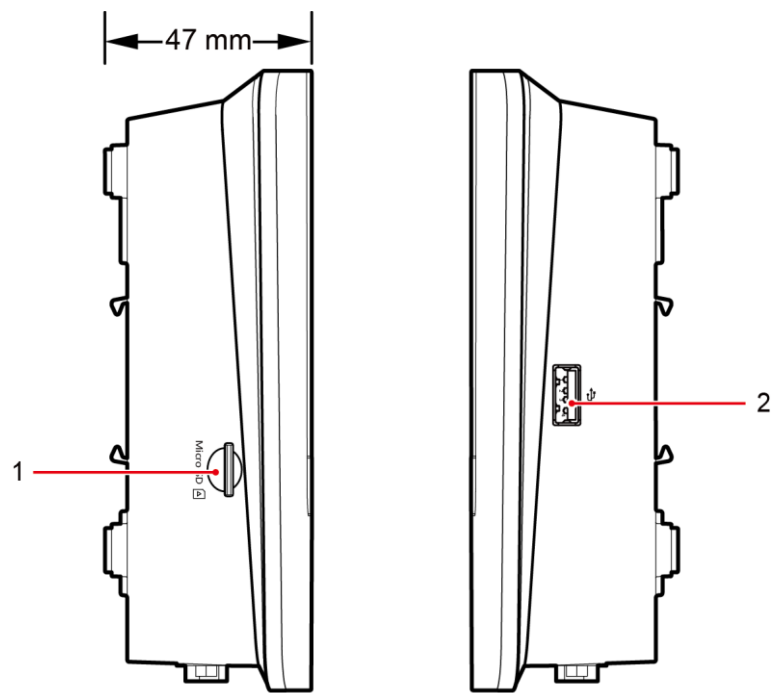

IL01WC0002

1. SD card slot (reserved)

2. USB port

Rear View of the Shell

Figure 2-4 Rear view of the SmartLogger

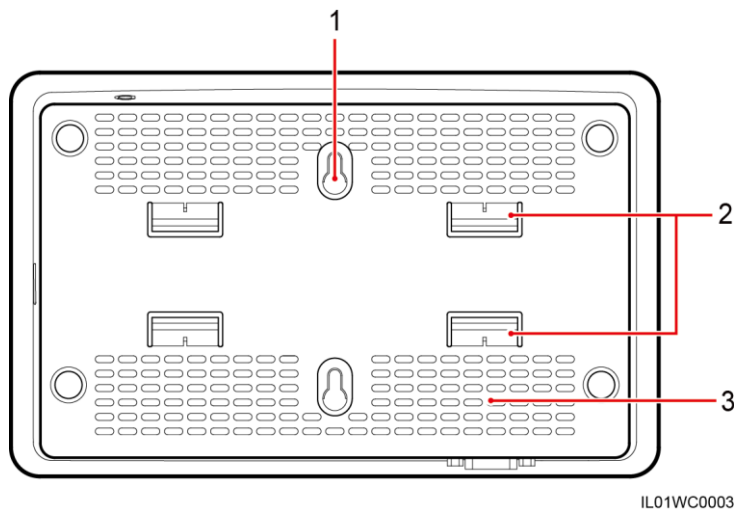

1. Mounting hole

2. Rail snap

3. Heat dissipation hole

Bottom of the Shell

Figure 2-5 Bottom view of the SmartLogger

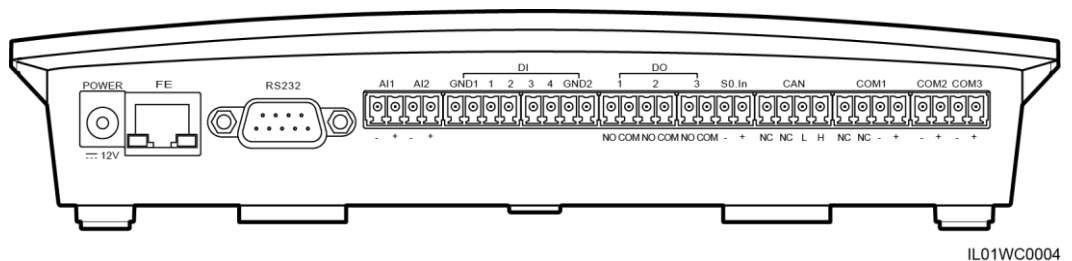

The following table describes functions of each port of the SmartLogger, as shown in [Table 2-1](#).

Table 2-1 Port description

Port (Silk Screen)	Function	Description
POWER	Power supply	12 V DC
FE	Fast Ethernet	Connects to a local area network (LAN) switch, router, power over Ethernet (POE) or PC.
RS232	RS232	Connects to an external RS232 device.

Port (Silk Screen)	Function	Description
AI	Analog input	4–20 mA and 0–20 mA current input (active), reserved.
DI	Digital input	Connects to a dry contact input.
DO	Digital output	Relay output
S0.In	Connects to a pulse output power meter	Reserved
CAN port	CAN port	Reserved
COM1-COM3	RS485	Supports three RS485 ports that can connect to devices such as the inverter and environmental monitoring instrument (EMI).

2.3 Monitoring Panel

This topic describes the monitoring panel, including an LCD, indicators, buttons, and the default page.

Monitoring panel

The monitoring panel provides one LCD, three indicators, and four buttons, as shown in [Figure 2-6](#).

Figure 2-6 Monitoring panel

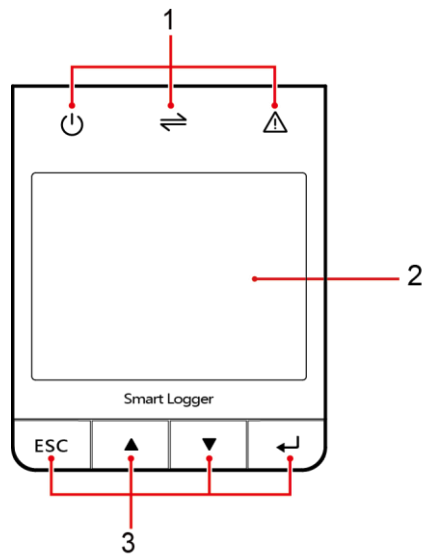

IL01WC0005

1. Indicator

2. LCD



3. Button

Indicators

There are three indicators on the monitoring panel. They are Power indicator, Run indicator, and Alarm indicator from left to right.

[Table 2-2](#) describes the indicators.

Table 2-2 Indicator description

Indicator	Status	Meaning
Power indicator 	Steady green	The power supply is normal.
	Off	There is no power supply.
Run indicator 	Blinking green (on for 1s and then off for 1s)	The SmartLogger is working.
	Off	The SmartLogger stops working.
Alarm indicator 	Steady red	The inverter connected to the SmartLogger generates a major alarm. For details about the alarm, see 6.2.19 Querying Alarm Records .
	Blinking red (on for 0.5s and then off for 0.5s)	The inverter connected to the SmartLogger generates a minor alarm. For details about the alarm, see 6.2.19 Querying Alarm Records .

Indicator	Status	Meaning
	Blinking red (on for 1s and then off for 4s)	The inverter connected to the SmartLogger generates a warning. For details about the warning, see 6.2.19 Querying Alarm Records .
	Off	The inverter connected to the SmartLogger is working normally.

LCD

The LCD displays data in graphics and text, including the information about the site, devices, alarms and products. Users can also set parameters and maintain devices on the LCD.

If you do not press any button within 90s on a non-default page, the LCD returns to the default page automatically, as shown in [Figure 2-7](#).

Figure 2-7 Default page

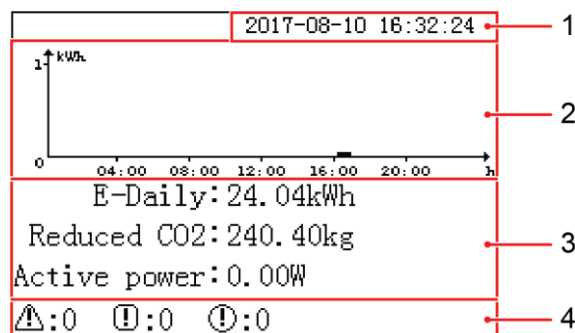

1. Date and time	Allows you to view the date and time.
2. Energy production histogram	Allows you to view the total energy production in each hour by all the inverters connected to the SmartLogger.
3. Energy production data	<ul style="list-style-type: none"> Allows you to view the total energy production from 0:00 to the current time by all the inverters connected to the SmartLogger. Allows you to view the emission reduction of CO₂ corresponding to the energy yield of the current day. Allows you to view the total output power by all the online inverters connected to the SmartLogger at the present.
4. Status information	Allows you to view the number of the major alarms, minor alarms, and warnings of all the inverters connected to the SmartLogger. When remote grid dispatching is enabled, you can view the current status of grid dispatching.

Buttons

There are four buttons on monitoring panel. They are the Return button, Cursor Up button, Cursor Down button, and Confirm button from left to right.

Table 2-3 describes the button functions.

Table 2-3 Button description

Buttons	Name	Functions
ESC	Return button	Allows you to return to the last page or end an operation.
▲	Cursor Down button	Allows you to go to the upper-level menu or set parameters.
▼	Cursor Up button	Allows you to go to the lower-level menu or set parameters.
↵	Confirm button	Allows you to go to the menu or confirm the value.



NOTE

The backlight lasts 120s after you press any button.

2.4 Typical Cable Connection Scenarios

Overview

- The cable from the busbar to the knife switch needs to be prepared by yourself. Recommended cable: three-core multi-wire (L1, L2, and L3) cable with the operating voltage to the ground not less than 600 V and the cross sectional area of a single core wire being 4 mm².
- The cable from the knife switch to the miniature circuit breaker (MCB) needs to be prepared by yourself. Recommended cable: three-core multi-wire (L1, L2, and L3) cable with the operating voltage to the ground not less than 600 V and the cross sectional area of a single core wire being 4 mm².
- If the SmartLogger communicates with the inverter over PLC, a PLC CCO module needs to be connected. If they communicate over RS485, no PLC CCO module is required.

Optical Fiber+RS485/PLC Scenario

Figure 2-8 Cable connections in the optical fiber+RS485/PLC scenario

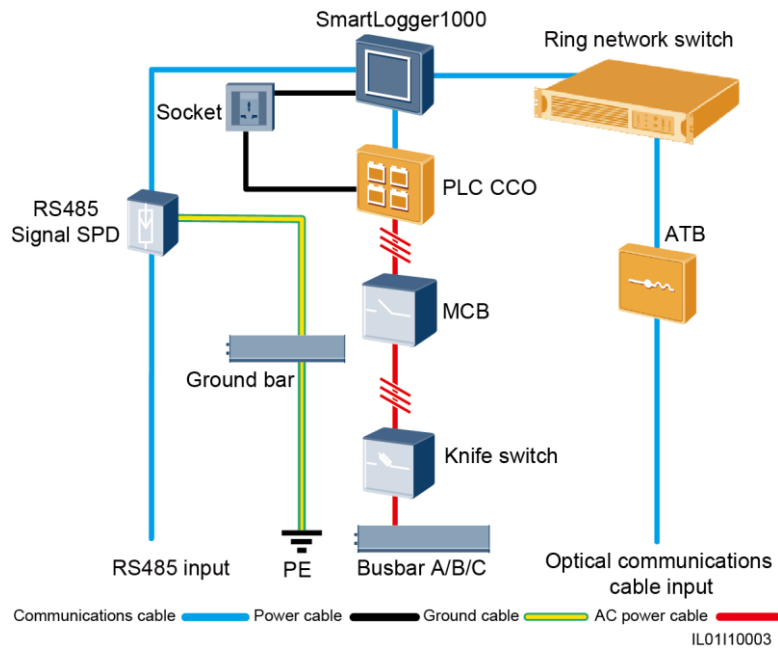

Table 2-4 lists the components required in this scenario.

Table 2-4 Required components

Component	Model or Specifications	Component Source	Quantity
SmartLogger	SmartLogger1000	Can be purchased from Huawei	1 PCS
RS485 signal SPD	PowerSA-5KA-15V	Can be purchased from Huawei	2 PCS
PLC CCO	PLC CCO01A	Can be purchased from Huawei	1 PCS
Ring network LAN switch	AR531 or a ring-network LAN switch of a local type	To be supplied by the customer	1 PCS
Optical module	FTLF1323P1BTR-HW or an optical module of a local model	To be supplied by the customer	2 PCS
ATB	CT-GZF2PJ-8, CT-GPH-A-8, or an ATB of a local model	To be supplied by the customer	1 PCS
MCB	Rated voltage ≥ 500 V; rated current ≥ 6 A	To be supplied by the customer	1 PCS

Component		Model or Specifications	Component Source	Quantity
Knife switch	Fuse	Rated voltage: ≥ 500 V; rated current: 6 A	To be supplied by the customer	3PCS
	Knife switch box	Rated voltage: ≥ 500 V; rated current: ≥ 6 A; number of phases: three	To be supplied by the customer	1 PCS
Socket		Matching with the power adapter	To be supplied by the customer	1 PCS

LTE+RS485/PLC Scenario

Figure 2-9 Cable connections in the LTE+RS485/PLC scenario

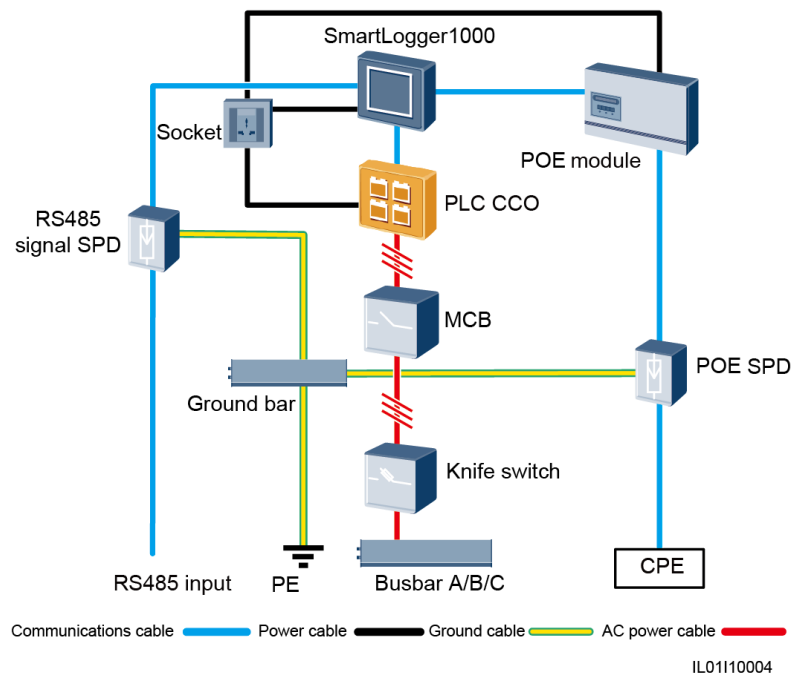

Table 2-5 lists the components required in this scenario.

Table 2-5 Required components

Component	Model or Specifications	Component Source	Quantity
SmartLogger	SmartLogger1000	Can be purchased from Huawei	1 PCS

Component		Model or Specifications	Component Source	Quantity
POE module		POE35-54A or POE85-56A	Can be purchased from Huawei	1 PCS
PLC CCO		PLC CCO01A	Can be purchased from Huawei	1 PCS
RS485 signal SPD		PowerSA-5KA-15V	Can be purchased from Huawei	2 PCS
POE SPD		POE-2	Can be purchased from Huawei	1 PCS
CPE		EG860V2-C71	Can be purchased from Huawei	1 PCS
MCB		Rated voltage: ≥ 500 V; rated current: ≥ 6 A	To be supplied by the customer	1 PCS
Knife switch	Fuse	Rated voltage: ≥ 500 V; rated current: 6 A	To be supplied by the customer	3PCS
	Knife switch box	Rated voltage: ≥ 500 V; rated current: ≥ 6 A; number of phases: three	To be supplied by the customer	1 PCS
Socket		Matching with the power adapter	To be supplied by the customer	1 PCS

3 Installation

This topic describes how to install the SmartLogger.

Context

Install the SmartLogger in an appropriate position and surface.



DANGER

- Do not store the SmartLogger in areas with flammable or explosive materials.
 - Do not install the SmartLogger on flammable building materials.
-

3.1 Installation Process

This topic describes the SmartLogger installation process.

The SmartLogger installation process is shown in [Figure 3-1](#).

Figure 3-1 Installation flowchart

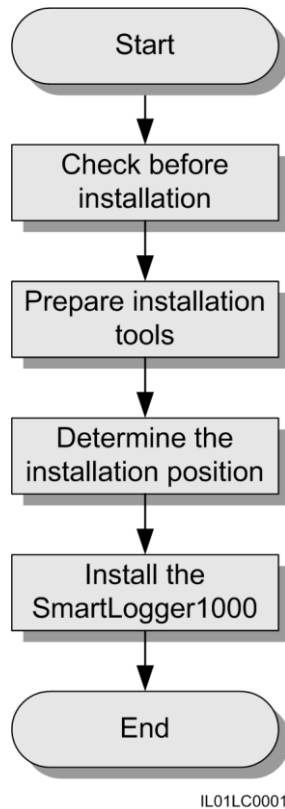

Table 3-1 describes the installation process.

Table 3-1 Description of the installation process

Step	Operation	Description
1	Checking Before Installation	Before unpacking, check that the outer packing materials are intact. After unpacking, check that deliverables are complete and intact.
2	Preparing Tools	Prepare tools required for installation and electrical connections.
3	Determine the installation position.	Before installing the SmartLogger, determine an appropriate position to ensure that the SmartLogger works properly.
4	Installing the SmartLogger	The SmartLogger can be installed on a desk, a wall or along a guide rail.

3.2 Checking Before Installation

Checking Outer Packing Materials

Check the outer packing materials for damage before unpack the SmartLogger, such as holes and cracks. If any damage is found, do not unpack the SmartLogger and contact the dealer as soon as possible.

Checking Deliverables

After unpacking the SmartLogger, check whether deliverables are intact and complete. If any damage is found or any component is missing, contact the dealer.









NOTE

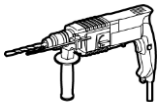
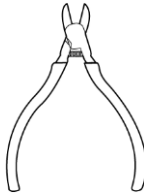
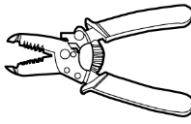

For details about the number of components, see the *Packing List* in the packing case.

3.3 Preparing Tools

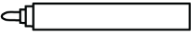
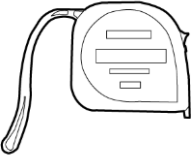
Prepare tools required for installation and electrical connections.

Tool	Model	Function
 Hammer drill	Φ6 drill bit	Drills holes in the wall when the SmartLogger is wall-mounted.
 Diagonal pliers	-	Cuts and tighten cable ties.
 Wire stripper	-	Peels cable jackets.
 Rubber mallet	-	Hammers expansion bolts into holes.

Tool	Model	Function
<p>Guarded blade utility knife</p> 	-	Removes package.
<p>Cable cutter</p> 	-	Cuts cables.
<p>Vacuum cleaner</p> 	-	Cleans up dust after holes are drilled.
<p>Marker</p> 	Diameter: ≤ 10 mm	Marks signs.
<p>Measuring tape</p> 	-	Measures distance
<p>Plumb line</p> 	-	Ensures that the screws are perpendicular to the wall.

Tool	Model	Function
Safety goggles 	-	Protect an operator's eyes during hole drilling.
Anti-dust respirator 	-	Protects an operator from dust inhalation during hole drilling.

3.4 Determining the Installation Position

Before installing the SmartLogger, determine an appropriate position to ensure that the SmartLogger works properly.

Comply with the following requirements when determining the installation position for the SmartLogger:

- Do not install the SmartLogger outdoors because it is protected to IP20.
- Install the SmartLogger in a dry environment to protect it against water.
- Keep the product in an ambient temperature range of -40°C to $+60^{\circ}\text{C}$ and away from direct sunlight.
- The communication distance for the RS485 port should be less than 1000 m and for the Ethernet less than 100 m.
- Install the SmartLogger at an appropriate height for the user's ease to view and operate on the monitoring panel.
- Do not place the SmartLogger upside down. Ensure that the heat dissipation holes are facing upwards, preventing dust from entering the SmartLogger and reducing its service life.
- Choose appropriate installation method and position for the Smart Logger according to its weight and size. For details, refer to [11 Technical Specifications](#).
- If you install the SmartLogger on a wall or along a guide rail, the area for connecting cables should be downwards.
- The SmartLogger is at least 100 mm away from the neighboring objects on both sides, the top side, and the bottom side respectively, as shown in [Figure 3-2](#).

Figure 3-2 Minimum installation clearance

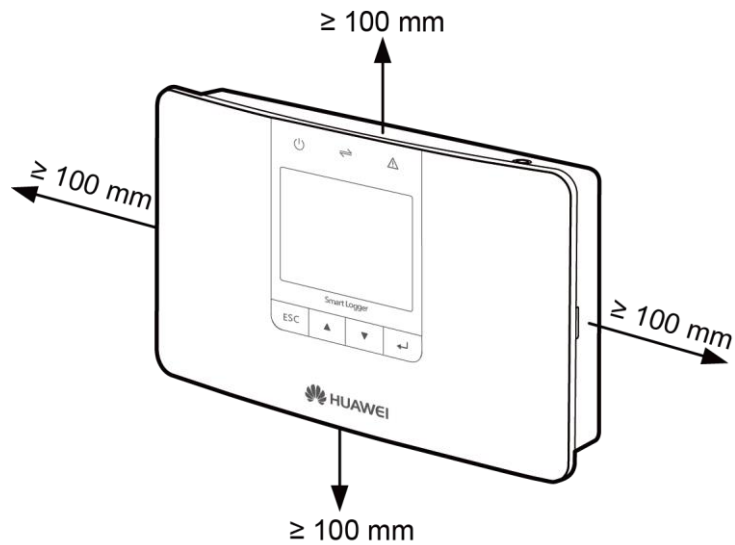

3.5 Installing the SmartLogger

The SmartLogger can be installed on a desk, on a wall, or along a guide rail.

3.5.1 Installing the SmartLogger on a Desk

This topic describes how to install the SmartLogger on a desk.

Context



NOTICE

- Ensure that the desk on which the SmartLogger is installed is horizontal to prevent it from falling down.
 - Install the SmartLogger in places where cables cannot be easily touched to avoid signal disruption.
-

Procedure

Step 1 Take the SmartLogger out from the package.

Step 2 Place the SmartLogger onto a horizontal desk.

----End

3.5.2 Mounting the SmartLogger on a Wall

This topic describes how to mount the SmartLogger on a wall.

Context



NOTICE

- Install the SmartLogger on a solid and smooth wall to ensure that it can be secured on the wall.
 - Before hanging the SmartLogger on the screws, secure the expansion tubes and screws into the wall.
-

Procedure

Step 1 Install the expansion tubes and screws.



NOTICE

If you need to use a ladder to install the SmartLogger on a high position, keep balance to protect yourself from falling down.

1. Use a plumb line to ensure that the line between the centric points of the two holes is vertical to the ground. Use a marker to mark out the holes, as shown in [Figure 3-3](#).

Figure 3-3 Hole positions and dimensions

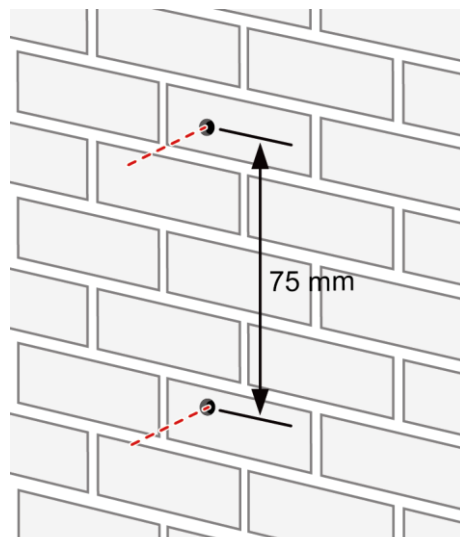

IL01SC0002

2. Drill holes using a hammer drill and install expansion tubes and screws, as shown in Figure 3-4.

Figure 3-4 Drilling a hole and installing an expansion tubes and screws

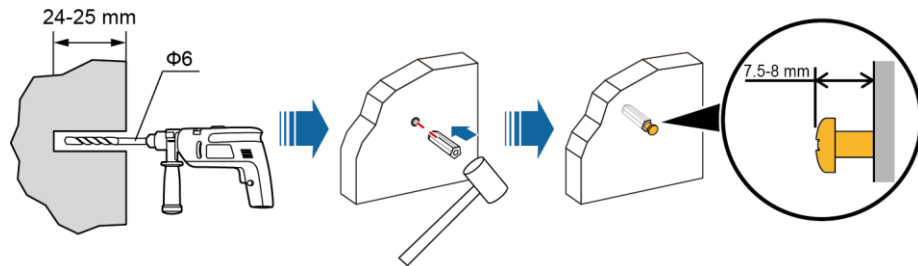

IL01H00001

Table 3-2 describes the operations shown in Figure 3-4.

Table 3-2 Drilling a hole and installing an expansion tubes and screws

Step	Operation
1	Put a hammer drill with a $\Phi 6$ drill bit on a marked hole position perpendicularly against the wall and drill holes with a depth of 24 mm to 25 mm. NOTICE <ul style="list-style-type: none"> • To prevent dust inhalation or contact with eyes, wear safety goggles and an anti-dust respirator when drilling holes. • Wipe away any dust in or around the holes and measure the hole distance. If the holes are inaccurately positioned, drill holes again.
2	Vertically insert an expansion tube into a hole, and knock it completely into the hole by using a rubber mallet.
3	Insert the screws into the expansion tube until the screw heads are 7.5 mm to 8 mm away from the wall.

- Step 2** Hang the SmartLogger onto the secured screws by the mounting holes on the rear of the SmartLogger.



NOTICE

Ensure that the area for connecting cables in the SmartLogger is downwards for the ease of electrical connections and maintenance.

----End

3.5.3 Mounting the SmartLogger Along a Guide Rail

This topic describes how to mount the SmartLogger along a guide rail.

Context

The guide rails are not delivered together with the SmartLogger. If you need to mount the SmartLogger along a guide rail, prepare a 35 mm wide guide rail.



NOTICE

- Choose a guide rail with appropriate lengths to ensure that the SmartLogger can be secured along it.
 - Secure the guide rail before mounting the SmartLogger.
-

Procedure

- Step 1** Hold both sides of the SmartLogger, keep it parallel with the guide rail, and then tilt it slightly to insert its upper hooks into the guide rail, as shown in [Figure 3-5](#).

Figure 3-5 Mounting the SmartLogger Along a guide rail (1)

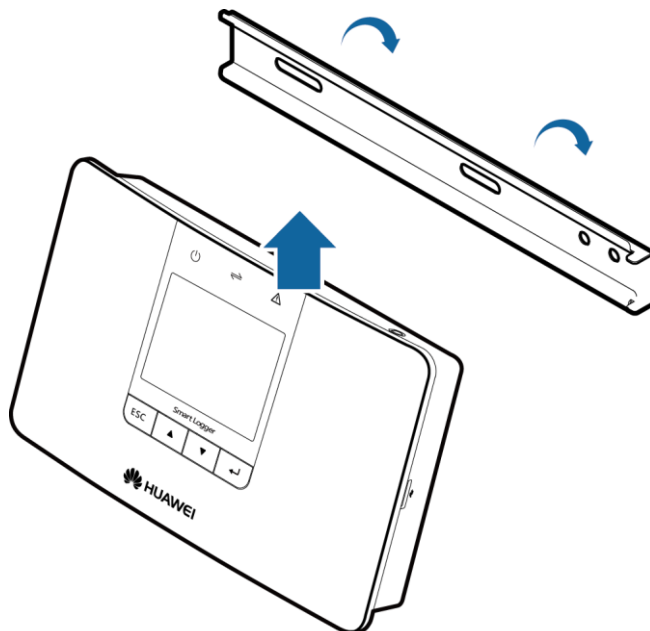

IL01HC0002

- Step 2** Hold the two lower corners of the SmartLogger, pull it downwards appropriately, and then push it towards the guide rail. When you hear a click sound, the SmartLogger is successfully mounted along the guide rail, as shown in [Figure 3-6](#).

Figure 3-6 Mounting the SmartLogger along a guide rail (2)

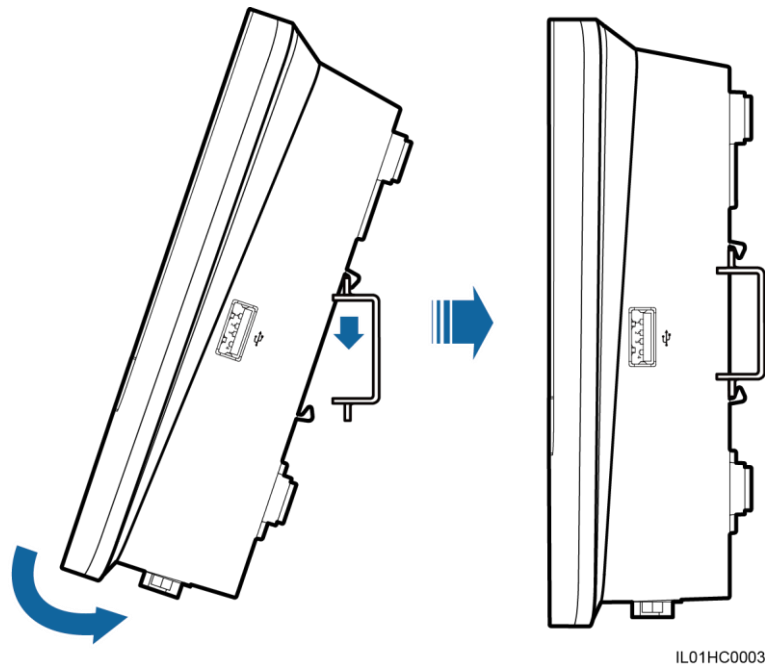

----End

3.6 Installing the RS485 signal SPD

Context

- If the SmartLogger needs to be connected to outdoor equipment through the COM port, it is recommended that an RS485 signal SPD be installed.
- Each SmartLogger can be configured with a maximum of two RS485 signal SPDs.
- The RS485 signal SPD can be mounted on guide rail. No guide rail is delivered with an RS485 signal SPD. If you need to install an RS485 signal SPD on a guide rail, prepare a standard 35 mm wide guide rail with a length no less than 80 mm.



NOTICE

- Secure the guide rail before mounting the RS485 signal SPD.
- If the SmartLogger is installed on a guide rail, the RS485 signal SPD can share the guide rail with the SmartLogger. In this case, the recommended guide rail length is 400 mm or greater.

Procedure

Step 1 Secure the RS485 signal SPD to the guide rail, as shown in [Figure 3-7](#).

Figure 3-7 Securing the RS485 signal SPD to the guide rail

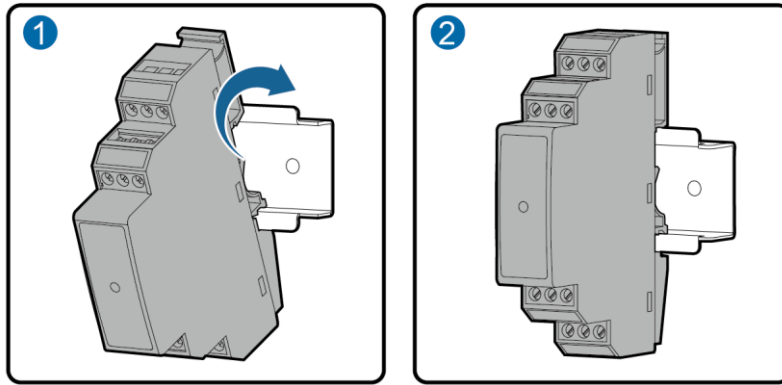

IL02HC0009

----End

4 Electrical Connections

This topic describes how to connect the SmartLogger to the inverters, environmental monitoring instrument, and PCs.

Context



NOTICE

- Ensure that all cables are connected and secured.
 - Do not connect a power adapter to the SmartLogger before the cable connections are complete because the SmartLogger has no startup button.
-

4.1 Connection Description

Port Description

For the bottom view of the SmartLogger and port description, see [Bottom of the Shell](#) in [2.2 Appearance](#).

Device Connection Description

[Figure 4-1](#) shows the recommended method for connecting the SmartLogger to multiple devices through the COM ports. For details, see [4.3 Connecting the RS485 Signal SPD-4.9 Connecting to a PID](#).

Figure 4-1 Connecting the SmartLogger to multiple devices through the COM ports

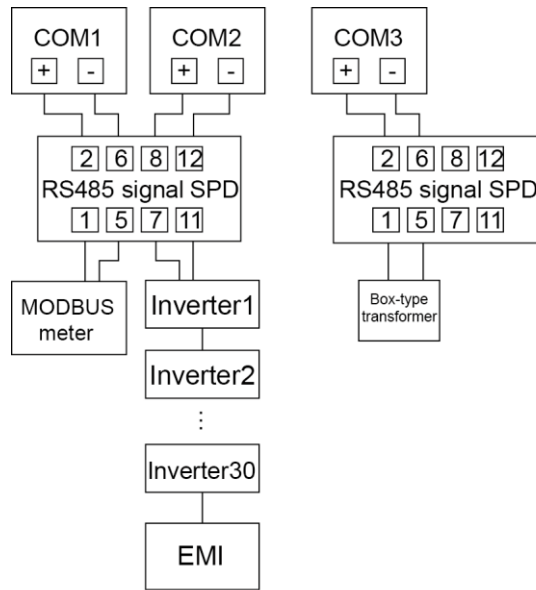

IL01N10007

4.2 Connecting the PE Cable for the RS485 Signal SPD

Prerequisites

The ground cable is available. Outdoor copper-core cables with a cross sectional area of 4 mm² or 12 AWG are recommended.

Procedure

- Step 1** Remove 8 mm of the insulation layer from the ground cable using the wire stripper.
- Step 2** Insert the bare cable cores into port 3 of the RS485 signal SPD, as shown by (1) in [Figure 4-2](#).

Figure 4-2 Connecting the PE cable for the RS485 signal SPD

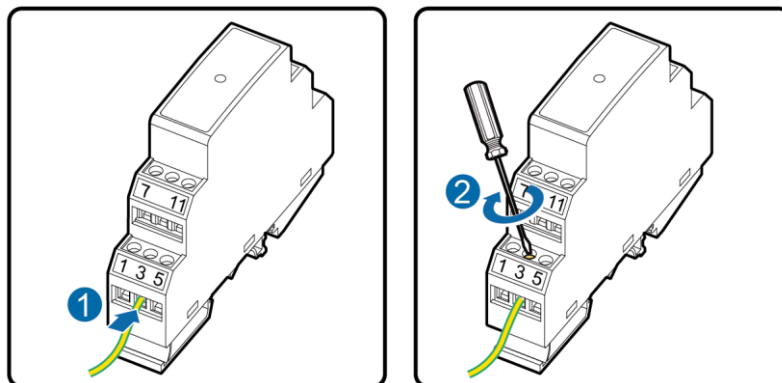

IL02IC1001

Step 3 Use a flat-head screwdriver to tighten the screws on port 3, as shown by (2) in [Figure 4-2](#).



NOTICE

Connect the other end of the PE cable to the ground bar.

----End

4.3 Connecting the RS485 Signal SPD

Prerequisites

The communications cable is prepared. The DJYP2VP2-22 2x2x1 network cable or a communications cable with a cross sectional area of 1 mm² and outer diameter of 14–18 mm is recommended.

Context



NOTE

The way of connecting two RS485 signal SPDs is the same as the way of connecting one RS485 signal SPD.

One RS485 signal SPD provides two RS485 surge protection ports, as shown in [Figure 4-3](#).

Figure 4-3 Ports on an RS485 signal SPD

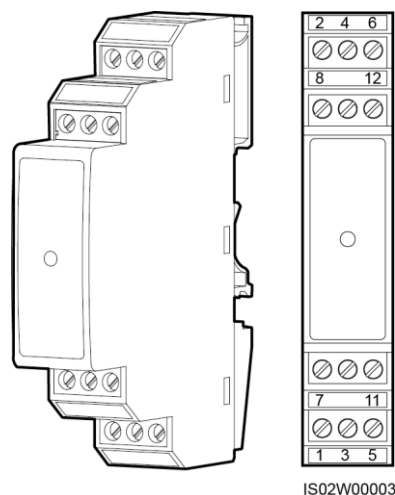

[Table 4-1](#) describes the surge protection ports.

Table 4-1 Port description

RS485 Surge Protection Port	Protection Port	Function	Surge Port	Function
RS485 surge protection port 1	2	RS485A, for RS485 positive differential signaling	1	RS485A, for RS485 positive differential signaling
	6	RS485B, for RS485 negative differential signaling	5	RS485B, for RS485 negative differential signaling
RS485 surge protection port 2	8	RS485A, for RS485 positive differential signaling	7	RS485A, for RS485 positive differential signaling
	12	RS485B, for RS485 negative differential signaling	11	RS485B, for RS485 negative differential signaling

 **NOTE**

- Protection ports are connected to COM ports on the SmartLogger. Port 4 is not connected.
- Surge ports are connected to RS485 ports of other devices. Port 3 is the ground port.
- Protection ports and surge ports must not be reversely connected.
- One RS485 signal SPD can protect two COM ports.
- Protection ports 2 and 6 and surge ports 1 and 5 form an RS485 signal SPD port for protecting one COM port. Protection ports 8 and 12 and surge ports 7 and 11 form another RS485 signal SPD port for protecting one more COM port.

Procedure

- Step 1** Remove an appropriate length of steel armor and insulation layer from the cable using a wire stripper, as shown in [Figure 4-4](#).

Figure 4-4 Stripping an RS485 communications cable (unit: mm)

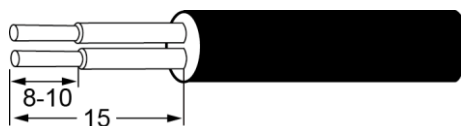

IS012C0036

- Step 2** Remove the terminal block from the SmartLogger COM port, as shown in [Figure 4-5](#).

Figure 4-5 Connecting the terminal block (1)

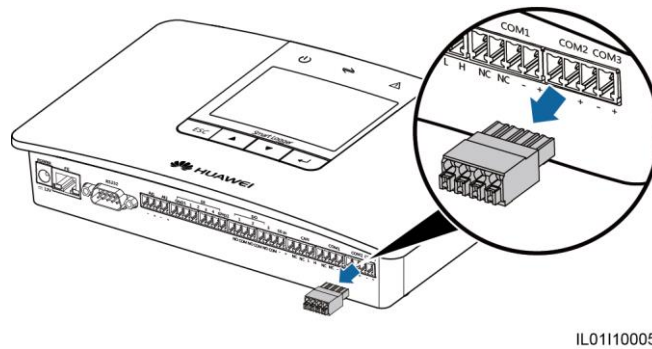

Step 3 Connect the cable to the SmartLogger terminal block, as shown in [Figure 4-6](#).

Figure 4-6 Connecting the terminal block (2)

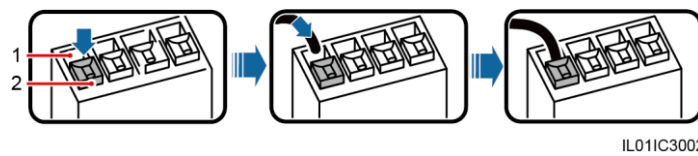

(1) Wiring terminal

(2) White contact plate

1. Press the white contact plate of the corresponding wiring terminal to flip the metal spring inside the wiring terminal.
2. Insert the uninsulated part of the core wire into the wiring terminal.
3. Release the white contact plate to fasten the core wire.

Step 4 Insert the terminal block into the SmartLogger COM port.

Step 5 Insert the bare cable cores at the other end of the cable into a protection port of the RS485 signal SPD, as shown by (1) in [Figure 4-7](#).

Figure 4-7 Wiring diagram for the RS485 signal SPD

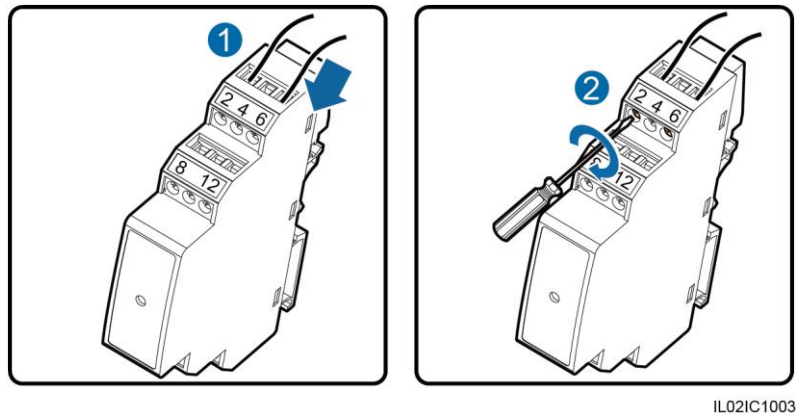

 **NOTICE**

Verify that the **COM+** port on the SmartLogger is connected to protection port 2 or 8 on the RS485 signal SPD, and that the **COM-** port on the SmartLogger is connected to protection port 6 or 12 on the RS485 signal SPD.

Step 6 Use a flat-head screwdriver to tighten the screws on the protection ports, as shown by (2) in [Figure 4-7](#).

----End

Follow-up Procedure

Disconnection can be performed in reverse order.

4.4 Connecting the SmartLogger to Inverters

This topic describes how to connect the SmartLogger to inverters.

4.4.1 Connecting the SmartLogger to the SUN2000

This topic describes how to connect the SmartLogger to the SUN2000 using an RS485 communications cable.

Context

The SmartLogger provides three COM ports for RS485 communication, as shown in [Figure 4-8](#).

Figure 4-8 COM ports on the SmartLogger

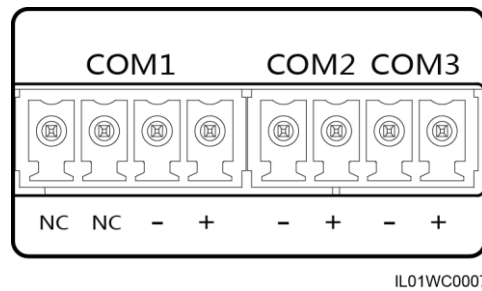

Table 4-2 describes the COM ports.

Table 4-2 COM port description

Port	Identifier	Function
COM1 port	NC	Reserved
	NC	Reserved
	-	RS485B, for RS485 negative differential signaling
	+	RS485A, for RS485 positive differential signaling
COM2 port	-	RS485B, for RS485 negative differential signaling
	+	RS485A, for RS485 positive differential signaling
COM3 port	-	RS485B, for RS485 negative differential signaling
	+	RS485A, for RS485 positive differential signaling

The RS485 terminal block or RJ45 port on the SUN2000 is used for RS485 communication. There are two types of RS485 terminal blocks (1 and 2) located in different models of SUN2000s. All the SUN2000s have RJ45 ports. You are advised to use terminal blocks for connection.

- Terminal block connection
 - **Terminal block 1**

Figure 4-9 shows the position of the terminal block in the SUN2000-50KTL/50KTL-C1. Table 4-3 describes the functions of the terminal block.

Figure 4-9 Position of the terminal block in the SUN2000

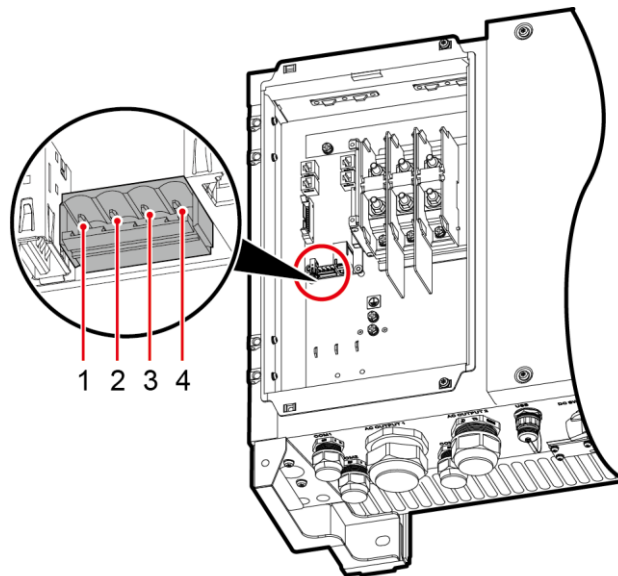

IS03W00003

Table 4-3 Functions of the RS485 terminal block

No.	Port Definition	Function
1	RS485A IN	RS485A, for RS485 positive differential signaling
2	RS485A OUT	RS485A, for RS485 positive differential signaling
3	RS485B IN	RS485B, for RS485 negative differential signaling
4	RS485B OUT	RS485B, for RS485 negative differential signaling

– **Terminal block 2**

Figure 4-10 shows the position of the terminal block in the SUN2000-33KTL/40KTL. Figure 4-11 describes the functions of the terminal block.

Figure 4-10 Position of the terminal block in the SUN2000

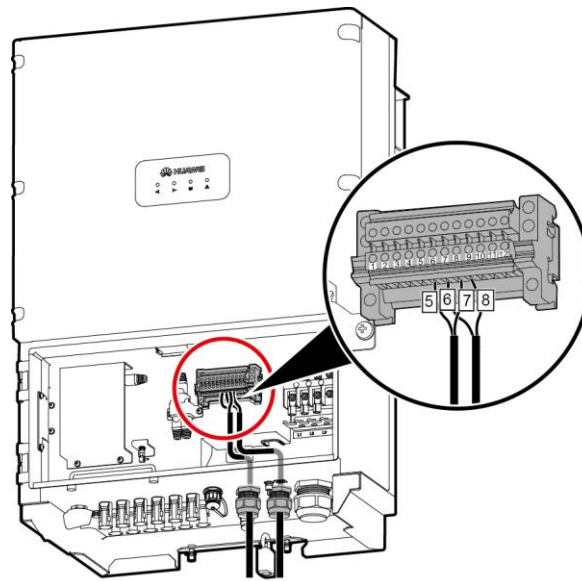

IS011C0025

Figure 4-11 Terminal block

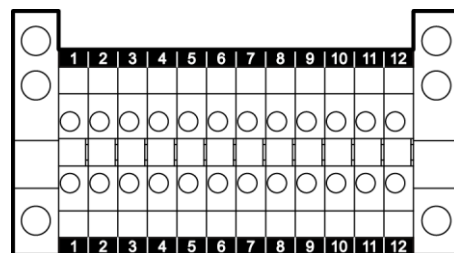

IU012C0001

Table 4-4 Functions of the RS485 terminal block

No.	Port Definition	Function
5	RS485A IN	RS485A, for RS485 positive differential signaling
6	RS485A OUT	RS485A, for RS485 positive differential signaling
7	RS485B IN	RS485B, for RS485 negative differential signaling
8	RS485B OUT	RS485B, for RS485 negative differential signaling

- RJ45 network port connection
The RJ45 port needs to be connected using an RJ45 connector, as shown in [Figure 4-12](#).

Figure 4-12 RS485 crystal plug of the SUN2000 (side view without the fastener)

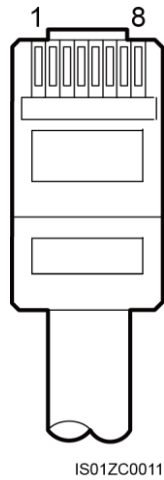

Table 4-5 lists the wire colors and functions.

Table 4-5 Cable colors and functions

Category	Color	Function
1	White and orange	RS485A, for RS485 positive differential signaling
2	Orange	RS485B, for RS485 negative differential signaling
3	White and green	N/A
4	Blue	RS485A, for RS485 positive differential signaling
5	White and blue	RS485B, for RS485 negative differential signaling
6	Green	N/A
7	White and brown	N/A
8	Brown	N/A

Figure 4-13 shows how to connect the SmartLogger to the SUN2000 through an RS485 signal SPD. This section describes how to connect the **SUN2000-33KTL/40KTL** to the SmartLogger through a terminal block.

Figure 4-13 Connecting the SmartLogger to the SUN2000

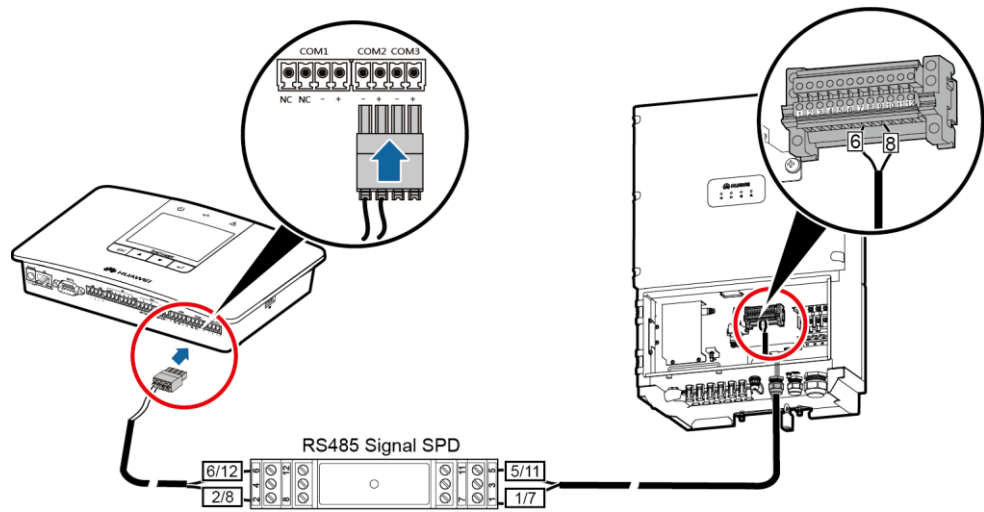

IL011C3001

Procedure

- Step 1** Prepare a cable with an appropriate length, strip a proper part of the insulation layer from one end, and connect the end to the SUN2000 terminal block.
- The DJYP2VP2-22 2x2x1 network cable or a communications cable with a cross sectional area of 1 mm² and outer diameter of 14–18 mm is recommended.
 - For details about how to strip and connect the cable, see the SUN2000 user manual.
- Step 2** Strip an appropriate length from the other end of the cable using a wire stripper, as shown in [Figure 4-14](#).

Figure 4-14 Stripping an RS485 communications cable (unit: mm)

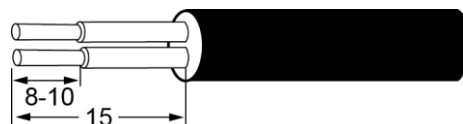

IS012C0036

- Step 3** Insert the bare core wires into the surge port of the RS485 signal SPD, as shown by (1) in [Figure 4-15](#).

Figure 4-15 Connecting the surge port of the RS485 signal SPD

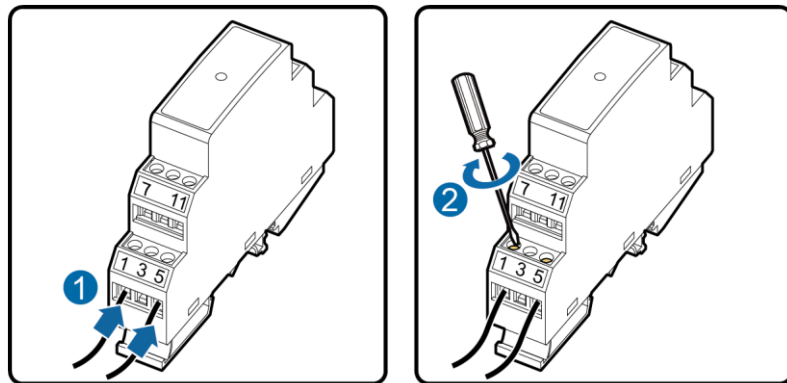

IL021C1002



NOTICE

- The RS485 IN and RS485 OUT ports on the SUN2000 can both connect to the SmartLogger. This document uses the RS485 OUT port as an example to describe the connection between the SUN2000 and the SmartLogger.
- Verify that the RS485A (OUT) port on the SUN2000 connects to surge port 1 or 7 on the RS485 signal SPD, and that the RS485B (OUT) port on the SUN2000 connects to surge port 5 or 11 on the RS485 signal SPD.
- After connecting cables, wrap the part without an insulation layer using PVC insulation tape.

Step 4 Use a flat-head screwdriver to tighten the screws on the surge ports, as shown by (2) in [Figure 4-15](#).

Step 5 Set **Baud Rate** to the same value for the SUN2000 and SmartLogger.

- SmartLogger communications parameters can be set on the LCD or WebUI. For details, see [6.2.26 Setting Communications Parameters](#) or [7.10.2.2 Setting RS485 Parameters](#).
- For details about the communications parameter configurations for the SUN2000, see *SUN2000 APP User Manual*.

----End

Follow-up Procedure

Take operations in reversed order to disconnect the SmartLogger from the SUN2000.

4.4.2 Connecting the SUN2000L to the SmartLogger

Context

The SmartLogger provides three COM ports for RS485 communication, as shown in [Figure 4-16](#).

Figure 4-16 COM ports on the SmartLogger

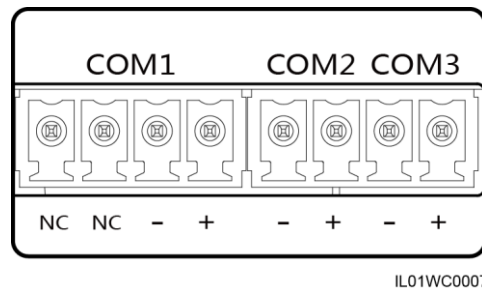

Table 4-6 describes the COM ports.

Table 4-6 COM port description

Port	Identifier	Function
COM1 port	NC	Reserved
	NC	Reserved
	-	RS485B, for RS485 negative differential signaling
	+	RS485A, for RS485 positive differential signaling
COM2 port	-	RS485B, for RS485 negative differential signaling
	+	RS485A, for RS485 positive differential signaling
COM3 port	-	RS485B, for RS485 negative differential signaling
	+	RS485A, for RS485 positive differential signaling

SUN2000L-4.125KTL-JP/4.95KTL-JP connects to the SmartLogger through the bottom COM port.

Figure 4-17 COM port on the SUN2000L

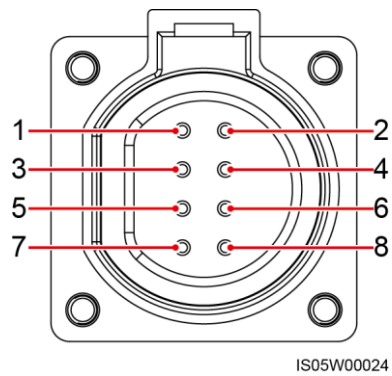

Table 4-7 describes the COM ports.

Table 4-7 COM port pin definitions

No.	Label	Definition
1	485B1	RS485B, RS485 differential signal-
2	485A1	RS485A, RS485 differential signal+
3	485B2	RS485B, RS485 differential signal-
4	485A2	RS485A, RS485 differential signal+
5	N/A	N/A
6	N/A	N/A
7	N/A	N/A
8	PE	Port for grounding the shield layer

Figure 4-18 shows how the SmartLogger connects to the SUN2000L through an RS485 signal SPD.

Figure 4-18 Connection between the SmartLogger and the SUN2000L

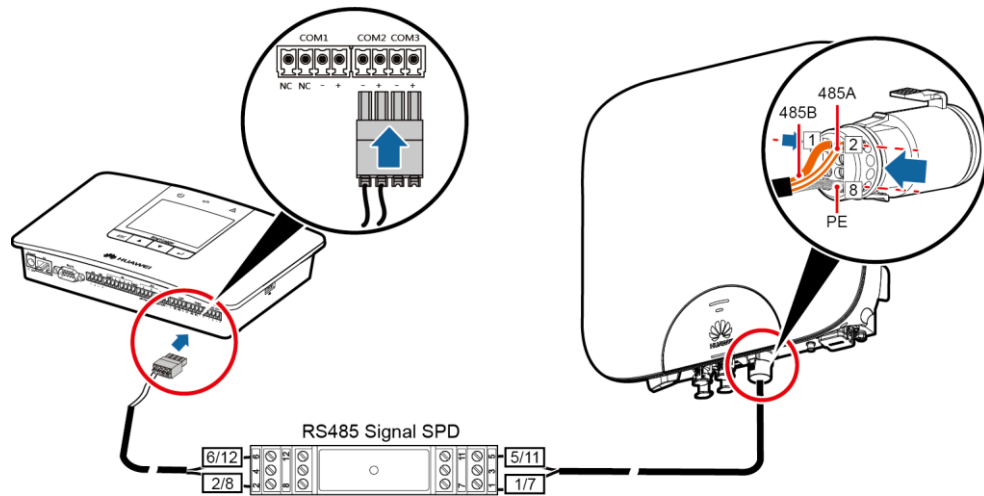

IL01IC3001

Procedure

- Step 1** Prepare a cable with an appropriate length, strip an appropriate length from one end, and connect the end to the SUN2000L terminal block.
- Select a two-core outdoor shielded RS485 communications cable with a cross-sectional area of 0.25–1 mm² (0.9 mm² recommended).
 - For details about how to strip and connect the cable, see the *SUN2000L-(4.125KTL, 4.95KTL)-JP User Manual*.
- Step 2** Strip an appropriate length from the other end of the cable using a wire stripper, as shown in [Figure 4-19](#).

Figure 4-19 Stripping an RS485 communications cable (unit: mm)

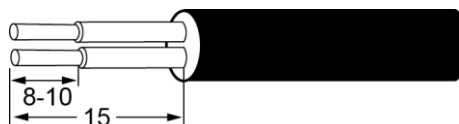

IS01ZC0036

- Step 3** Insert the bare core wires into the surge port of the RS485 signal SPD, as shown by (1) in [Figure 4-20](#).

Figure 4-20 Connecting cables to the surge port of the RS485 signal SPD

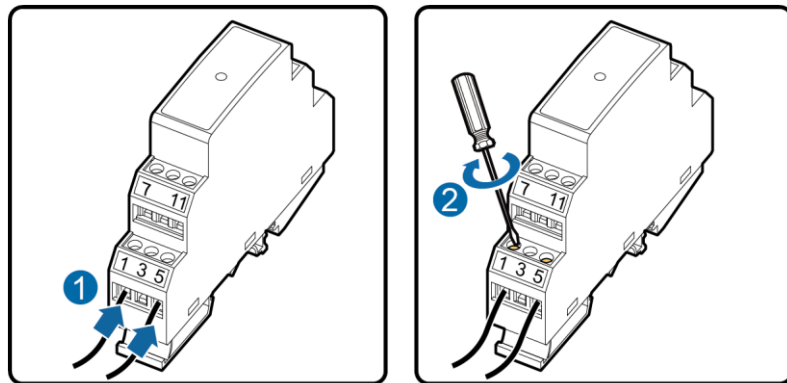

IL021C1002



NOTICE

- Verify that the 485A1 or 485A2 port on the SUN2000L connects to surge port 1 or 7 on the RS485 signal SPD, and that the 485B1 or 485B2 port on the SUN2000L connects to surge port 5 or 11 on the RS485 signal SPD.
- After connecting cables, wrap the part without an insulation layer using PVC insulation tape.

Step 4 Use a flat-head screwdriver to tighten the screws on the surge ports, as shown by (2) in [Figure 4-15](#).

Step 5 Set **Baud rate** to the same value for the SUN2000L and SmartLogger.

SmartLogger communications parameters can be set on the LCD or WebUI. For details, see [6.2.26 Setting Communications Parameters](#) or [7.10.2.2 Setting RS485 Parameters](#).

----End

Follow-up Procedure

Disconnection can be performed in reverse order.

4.4.3 Connecting Multiple Inverters to the SmartLogger

This topic describes how to connect the SmartLogger to multiple inverters.

The SmartLogger can connect to multiple inverters through a daisy chain, as shown in [Figure 4-21](#).

Figure 4-21 Connecting Multiple Inverters to the SmartLogger

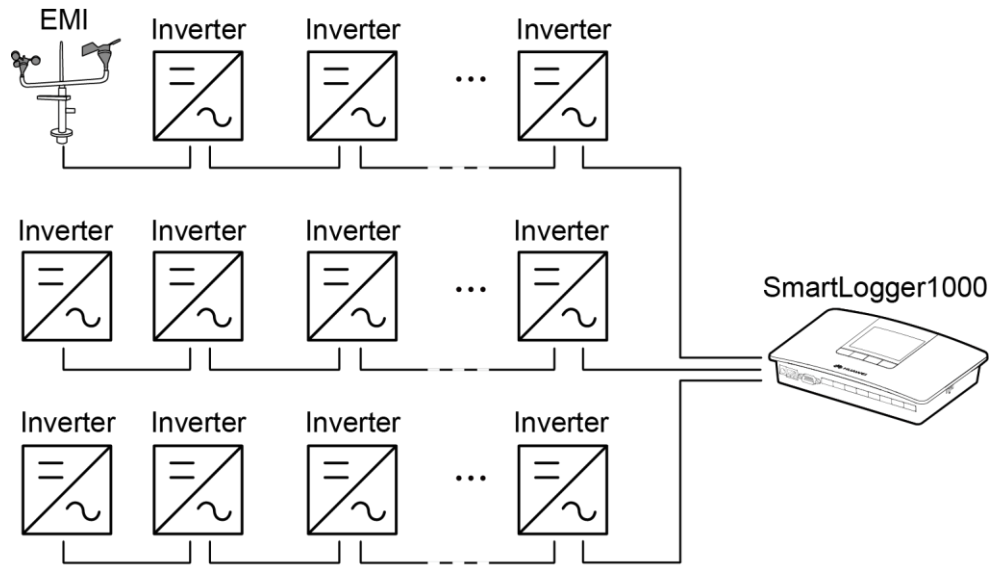

IL01NC0001

NOTE

- A maximum of 80 devices can be connected to one SmartLogger. You are advised to connect fewer than 30 devices to each RS485 route.
- The addresses for all devices in the daisy chain should be within the searching scope set in the SmartLogger and they must differ from each other. Otherwise, the communications would fail between the device and the SmartLogger.
- If the firmware version of the SUN2000 is V100R001C00SPC010 or later, or V100R001C81SPC105 or later, you can perform **Auto Assign Address** on the SmartLogger. If detecting that an RS485 address is repeatedly used, the SmartLogger automatically allocates another address and hence no local operation is required.
- **Baud rate** of all the devices in one daisy chain should stay consistent with those of the SmartLogger.

4.5 Connecting to an EMI

4.5.1 Connection Description

There are two types of EMI. One is the standard EMI that supports the Modbus-RTU protocol, and it can directly connect to the SmartLogger. The other is the EMI that is composed of sensors, whose signals need to be converted into RS485 signals (Modbus-RTU) over an extra analog-to-digital converter before the sensors are connected to the SmartLogger.

4.5.2 Connecting the SmartLogger to an EMI That Supports Standard Modbus-RTU

Context

The SmartLogger can connect to an EMI that supports the standard Modbus-RTU protocol. One SmartLogger can connect to and manage only one EMI.

Devices from different vendors may support different protocols. To normally obtain information from the connected EMI, correctly configure the protocol on the SmartLogger WebUI based on the document delivered by the vendor.

For the definition of the RS485 communications cable for the EMI, see the instructions delivered with the EMI.

There are three RS485 ports in the SmartLogger. For the port descriptions, see **Context** in [4.4.1 Connecting the SmartLogger to the SUN2000](#).

[Figure 4-22](#) shows how to connect the SmartLogger to the EMI.

Figure 4-22 Connecting the SmartLogger to the EMI

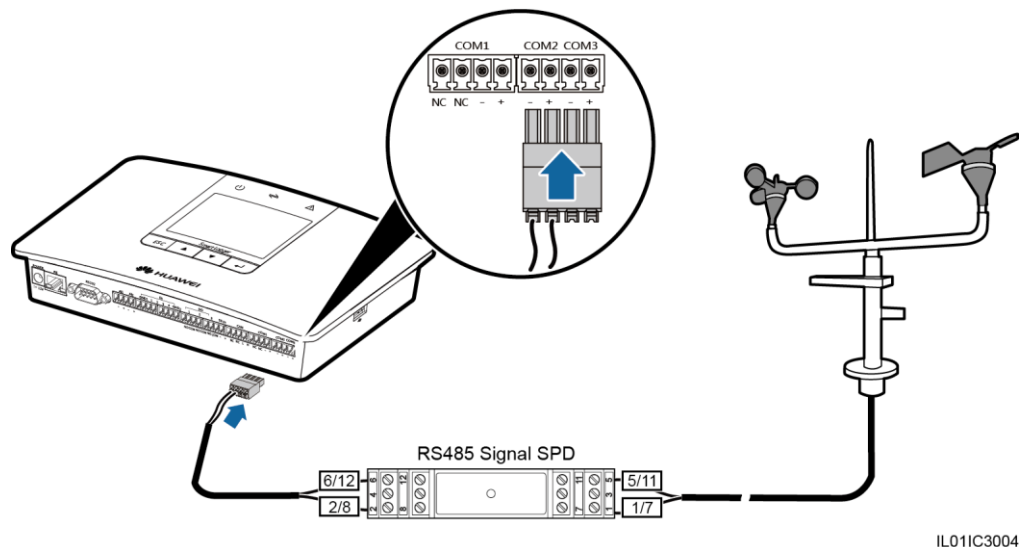

IL011C3004

Procedure

- Step 1** Connect one end of the cable delivered with the EMI to the RS485 port of the EMI.
- Step 2** Connect the other end of the cable to a Surge port of the RS485 signal SPD. For details, see [Step 2–Step 4](#) in **Procedure** in [4.4.1 Connecting the SmartLogger to the SUN2000](#).



NOTICE

Verify that the RS485+ port on the EMI is connected to Surge port **1** or **7** on the RS485 signal SPD, and that the RS485- port on the EMI is connected to Surge port **5** or **11** on the RS485 signal SPD.



NOTE

- The EMI cannot be detected automatically. You need to add this device manually on the LCD or WebUI. For details about this operation, see [6.2.33 Managing Devices](#) or [7.11.8.1 Connecting Devices](#).
- After the EMI is connected, log in to the embedded WebUI and set relevant parameters for the **EMI**. For details, see [7.10.2.3 Setting EMI Parameters](#). Select the specific model of EMI.

- When the SmartLogger is connected to an EMI and multiple inverters at the same time, connect the EMI to the end of the daisy chain. For details, see [4.4.3 Connecting Multiple Inverters to the SmartLogger](#).

----End

Follow-up Procedure

Take the reverse steps to disconnect the SmartLogger from the EMI.

4.5.3 Connecting the SmartLogger to a Split EMI

The EMI used in Europe and Southeast Asia is composed of sensors, whose signals need to be converted into RS485 signals (Modbus-RTU) over an extra analog-to-digital converter before the sensors are connected to the SmartLogger.

The analog-to-digital converter should provide an RS485 port and support the standard Modbus-RTU protocol. This section describes the connection between the SmartLogger and a split EMI through the ADAM4117 that functions as an analog-to-digital converter.

There are three RS485 ports in the SmartLogger. For the port descriptions, see **Context** in [4.4.1 Connecting the SmartLogger to the SUN2000](#).

[Figure 4-23](#) shows how to connect the SmartLogger to a split EMI through an RS485 signal SPD and analog-to-digital converter.

Figure 4-23 Connecting the SmartLogger to a split EMI (1)

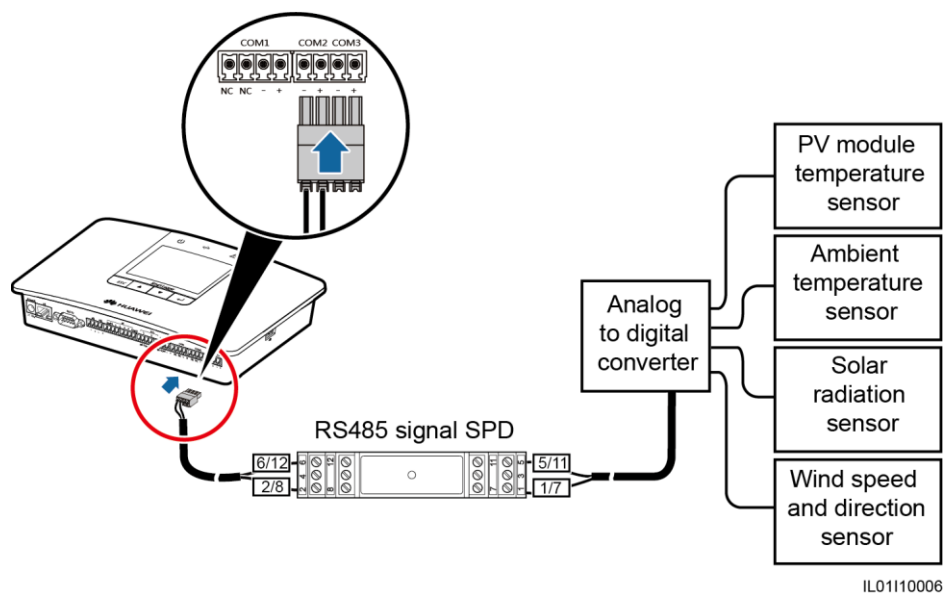

Step 1 Prepare a cable with an appropriate length, strip a proper part of the insulation layer from one end, and connect the end to the port on the analog-to-digital converter.

- The DJYP2VP2-22 2x2x1 computer cable or a communications cable with a conductor cross-sectional area of 1 mm² and outer diameter of 14–18 mm is recommended.
- For detailed operations, see the document delivered with the analog-to-digital converter.

- Step 2** Remove an appropriate length of the steel armor and wire insulation layer from the other end of the cable using a wire stripper, as shown in [Figure 4-24](#).

Figure 4-24 Stripping a cable (unit: mm)

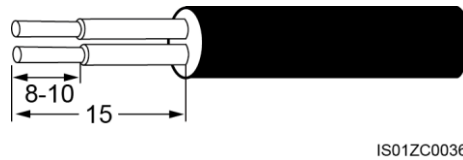

- Step 3** Insert the bare core wires into the surge port of the RS485 signal SPD, as shown by (1) in [Figure 4-25](#).

Figure 4-25 Connecting cables to the surge port of the RS485 signal SPD

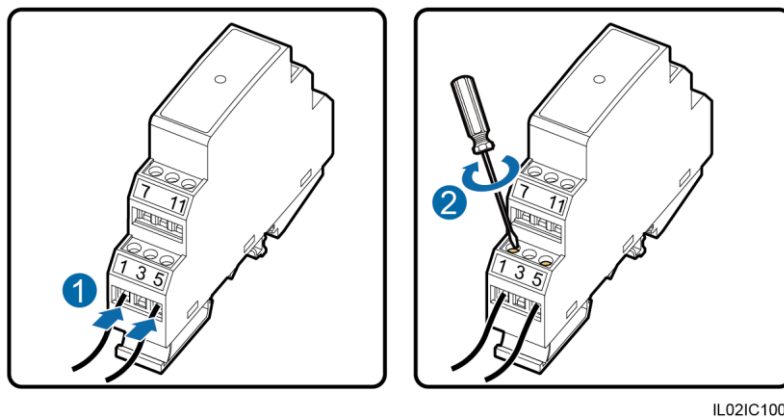

NOTICE

Verify that the RS485+ port on the analog-to-digital converter connects to surge port 1 or 7 on the RS485 signal SPD, and that the RS485- port on the analog-to-digital converter connects to surge port 5 or 11 on the RS485 signal SPD.

- Step 4** Use a flat-head screwdriver to tighten the screws on the surge ports, as shown by (2) in [Figure 4-25](#).
- Step 5** Set **Baud rate** for the analog-to-digital converter to the same value as that for the SmartLogger.
- SmartLogger communications parameters can be set on the LCD or WebUI. For details, see [6.2.26 Setting Communications Parameters](#) or [7.10.2.2 Setting RS485 Parameters](#).
 - For details about the communications parameter configurations for the analog-to-digital converter, see the delivered document.
- Step 6** Connect each sensor to the analog-to-digital converter. For detailed operations, see the documents delivered with the analog-to-digital converter or sensors.

 **NOTE**

- After connecting the cables, log in to the embedded WebUI and set relevant parameters. For details, see [7.10.2.3 Setting EMI Parameters](#). The selected EMI model is **Sensor(ADAM)**.
- The EMI cannot be detected automatically. You need to add this device manually on the LCD or WebUI. For details about this operation, see [6.2.33 Managing Devices](#) or [7.11.8.1 Connecting Devices](#).
- If the SmartLogger needs to connect to an EMI and multiple inverters, connect the EMI at the end of the daisy chain, and verify that other devices connected to the port have different addresses from the EMI. For the daisy chain connection, see [4.4.3 Connecting Multiple Inverters to the SmartLogger](#).

----End

4.6 Connecting the SmartLogger to a Power Meter

This topic describes how to connect the SmartLogger to a power meter.

Context

The SmartLogger can be connected to a power meter that supports the standard Modbus-RTU or DL/T645 protocol.

 **NOTE**

- The SmartLogger can be connected to and manage only one power meter that supports the Modbus-RTU protocol.
- The SmartLogger can be connected to and manage multiple power meters that support the DL/T645 protocol.

The protocol points for Power Meters provided by different vendors are varied. Therefore, to obtain information from a Power Meter, configure the protocol point on the WebUI of the SmartLogger properly based on the document delivered by the vendor.

For details about the definition of the RS485 communications cables for the Power Meter, see the operation manual delivered with the Power Meter.

There are three RS485 ports in the SmartLogger. For details about the port descriptions, see **Context** in [4.4.1 Connecting the SmartLogger to the SUN2000](#).

[Figure 4-26](#) shows how to connect the SmartLogger to the Power Meter.

Figure 4-26 Connecting the SmartLogger to a power meter

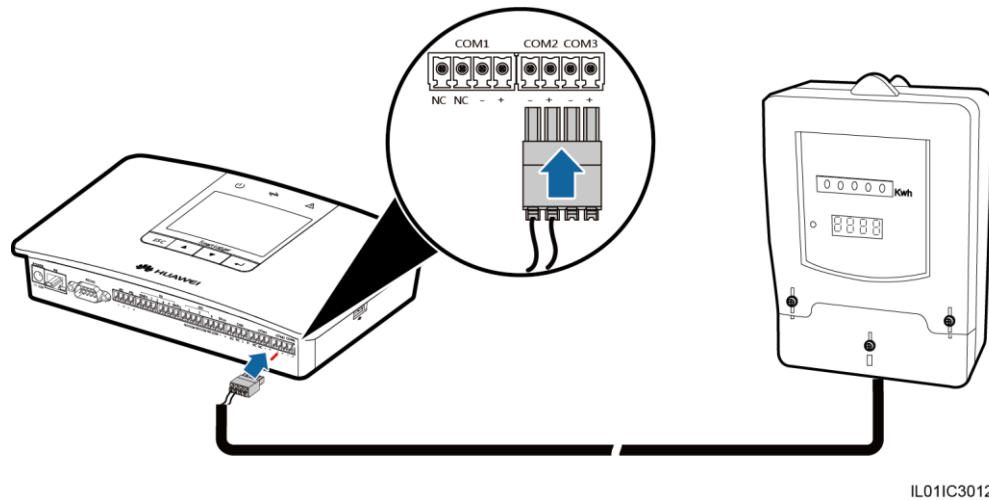

NOTE

A Power Meter is typically installed indoors, and can be connected to the COM port of the SmartLogger without an RS485 signal SPD.

Procedure

- Step 1** Connect one end of the cable delivered with the power meter to the RS485 port of the Power Meter.
- Step 2** Connect the other end of the cable to the COM port of the SmartLogger. For details, see [Step 1–Step 4](#) in **Procedure** in [4.3 Connecting the RS485 Signal SPD](#).



NOTICE

Connect the RS485+ port of the Power Meter to the **COM+** port of the SmartLogger and the RS485- port of the Power Meter to the **COM-** port of the SmartLogger.



NOTE

- After connecting the cable for a power meter that supports the Modbus-RTU protocol, log in to the embedded WebUI and set relevant parameters for the Modbus power meter. For details, see [7.10.2.4 Setting Power Meter Parameters](#).
- Devices connected to a COM port of the SmartLogger must support the same protocol. After connecting the cable, modify the COM port protocol on the LCD or WebUI. For details, see [6.2.26 Setting Communications Parameters](#) or [7.10.2.2 Setting RS485 Parameters](#).
- The power meter cannot be detected automatically. You need to add this device manually on the LCD or WebUI. For details about this operation, see [6.2.33 Managing Devices](#) or [7.11.8.1 Connecting Devices](#).

----End

Follow-up Procedure

Take operations in reversed order to disconnect the SmartLogger from the Power Meter.

4.7 Connecting to a PLC

This topic describes how to connect the SmartLogger to a PLC.

Context

The RS485 port of a PLC is an RJ45 port that should be connected to an RJ45 connector, as shown in [Figure 4-27](#).

Figure 4-27 PLC RS485 port connection (side view without the fastener)

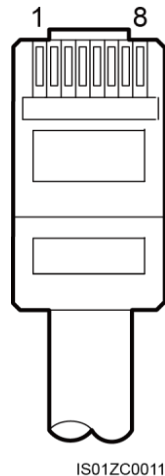

[Table 4-8](#) lists the cable colors and functions.

Table 4-8 Cable colors and functions

No.	Color	Function
1	White and orange	Reserved
2	Orange	Reserved
3	White and green	12 Vin, power
4	Blue	RS485A, and RS485 differential signal +
5	White and blue	RS485B, and RS485 differential signal -
6	Green	Reserved
7	White and brown	Reserved
8	Brown	N/A

There are three RS485 ports in the SmartLogger. For the port descriptions, see **Context** in [4.4.1 Connecting the SmartLogger to the SUN2000](#).

Figure 4-28 shows how to connect the SmartLogger to the PLC.

Figure 4-28 Connecting the SmartLogger to the PLC

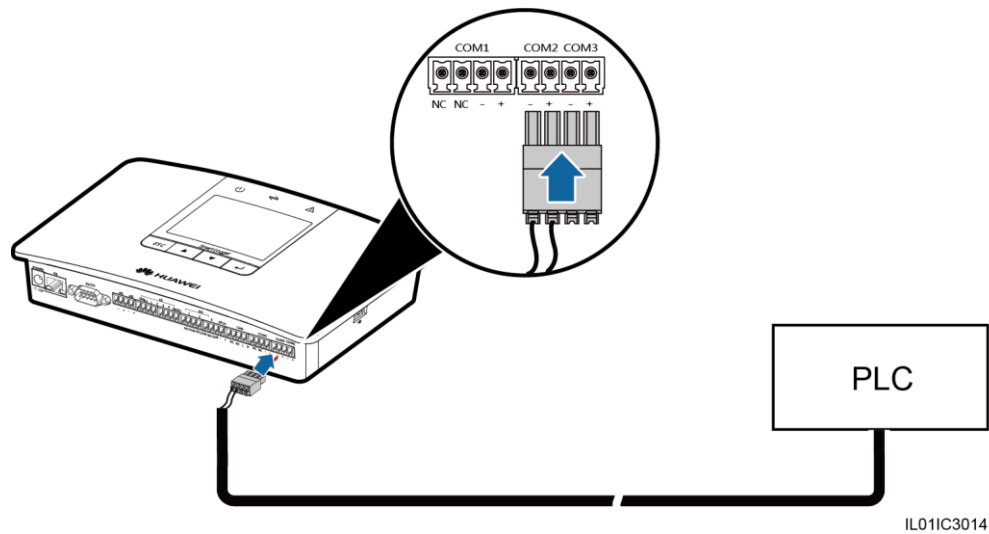

Procedure

- Step 1** Choose a shielded network cable of appropriate length. Crimp an RJ45 connector at one end and connect it to the RS485 port of the PLC.
- Step 2** Connect the other end of the cable to the COM port of the SmartLogger. For details, see [Step 2–Step 4](#) in **Procedure** in [4.3 Connecting the RS485 Signal SPD](#).



NOTICE

- Connect the RS485+ port of the PLC to the **COM+** port of the SmartLogger and connect the RS485- port of the PLC to the **COM-** port of the SmartLogger.
- The PLC cannot be detected automatically. You need to add this device manually on the LCD or WebUI. For details about this operation, see [6.2.33 Managing Devices](#) or [7.11.8.1 Connecting Devices](#).
- The Huawei PLC supports auto-negotiation of baud rate 9600 bps/115200 bps. If the PLC networking is used, you are advised to set **Baud rate** to **115200 bps** for the RS485 ports of the SmartLogger to achieve better communication performance.

----End

Follow-up Procedure

Take the reverse steps to disconnect the SmartLogger from the PLC.

4.8 Connecting an Ethernet Network Cable

Context

The SmartLogger can be connected to an Ethernet switch, router, or POE module. It can also be connected to the Ethernet electrical port of a PC directly or through a hub. Select the connection device based on the actual networking scenario.

Procedure

Step 1 Connect one end of the delivered network cable to the Ethernet electrical port of a device.

 **NOTE**

If the delivered cable is too short, pay attention to the following when preparing a cable:

- Select CAT 5E or a higher-class shielded network cable.
- It is suggested that the cable length is less than or equal to 100 meters.

Step 2 Connect the other end of the network cable to the **FE** port of the SmartLogger, as shown in [Figure 4-29](#).

Figure 4-29 Connecting an Ethernet network cable

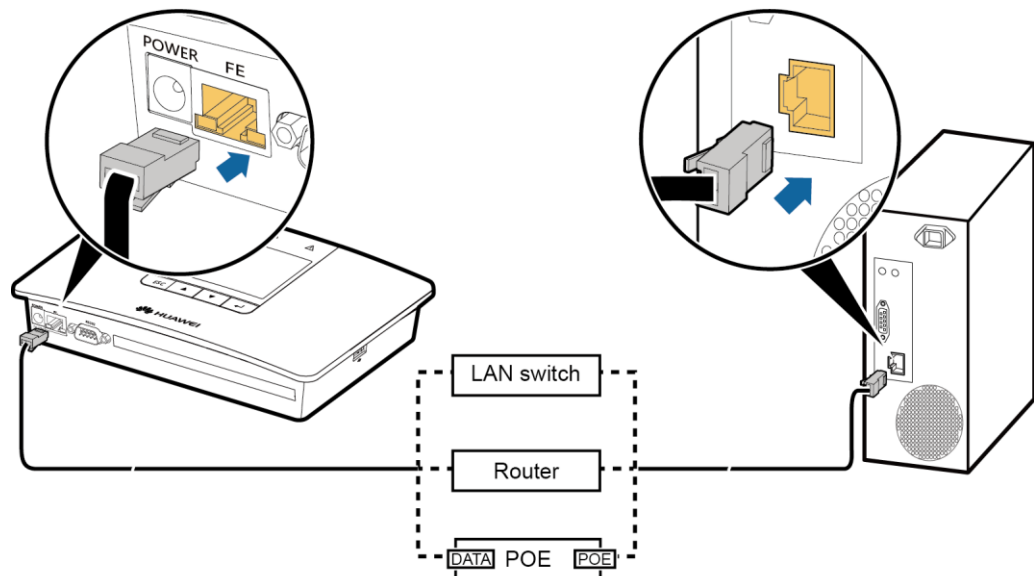

IL011C3005

 **NOTE**

- A POE module can be connected only to the **DATA** port of the SmartLogger.
- The default IP address of the SmartLogger is 192.168.0.10, the default subnet mask is 255.255.255.0, and the default gateway is 192.168.0.1.
- If the SmartLogger is connected to a PC directly or through a hub, the IP addresses of the SmartLogger and PC must be in the same network segment. For example, if the IP address of the SmartLogger is 192.168.0.10, the IP address of the PC can be 192.168.0.11. The subnet mask and the gateway of the PC should be consistent with those of the SmartLogger.

- If the SmartLogger connects to the PC through a network device (for example, a router), set the IP addresses for the SmartLogger and network device to be in the same network segment. Correctly set the gateway of the SmartLogger to ensure that the SmartLogger can normally communicate with the network device.
- To enable communication between the SmartLogger and the NMS (such as the NetEco) on the PC, set the NetEco parameters properly on the LCD or WebUI. For details, see [6.2.26 Setting Communications Parameters](#) or [7.10.2.5 Setting NetEco Parameters](#).

----End

Follow-up Procedure

Take operations in reversed order to disconnect the SmartLogger from the PC.

4.9 Connecting to a PID

This section describes how to connect the SmartLogger to a PID.

Context

There are three RS485 ports in the SmartLogger. For the port descriptions, see **Context** in [4.4.1 Connecting the SmartLogger to the SUN2000](#).

[Figure 4-30](#) shows how to connect the SmartLogger to the PID module.

Figure 4-30 Connecting the SmartLogger to the PID

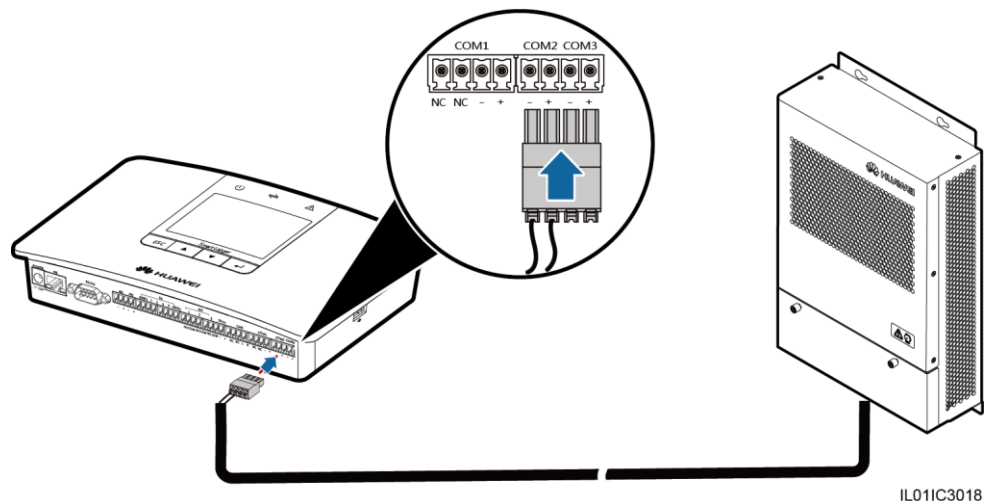

NOTE

In the scenarios with the communication box, the SmartLogger and PID module are installed before delivery, and the PID module is connected to the SmartLogger through the X2 terminal block.

Procedure

Step 1 Connect one end of the cable delivered with the PID to the RS485 port of the PID.

- Step 2** Connect the other end of the cable to a Surge port of the RS485 signal SPD. For details, see [Step 2–Step 4 in Procedure in 4.4.1 Connecting the SmartLogger to the SUN2000](#).



NOTICE

Verify that the brown cable (RS485A) of the PID module is connected to Surge port 1 or 7 on the RS485 signal SPD, and that the black cable (RS485B) is connected to Surge port 5 or 11 on the RS485 signal SPD.

----End

Follow-up Procedure

Take the reverse steps to disconnect the SmartLogger from the PID module.

4.10 Connecting the SmartLogger to a Ripple Control Receiver

This topic describes how to connect the SmartLogger to a ripple control receiver.

Context

In Germany and some European areas, a ripple control receiver is used to convert a power grid scheduling signal to a dry contact signal, in which a dry contact is required.

[Figure 4-31](#) shows the DI ports of the SmartLogger.

Figure 4-31 DI ports of the SmartLogger

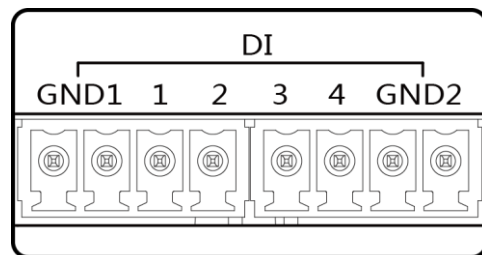

IL01WC0008

[Table 4-9](#) describes the definition of the DI ports.

Table 4-9 DI port description

Port	Functions
GND1	Dry contact input common terminal 1, used for active power derating for DI1–DI4

Port	Functions
1	DI_1
2	DI_2
3	DI_3
4	DI_4
GND2	Dry contact input common terminal 2, used for reactive power compensation for DI1–DI4

Figure 4-32 shows how to connect the Smart Logger to the ripple control receiver.

Figure 4-32 Connecting the SmartLogger to a ripple control receiver

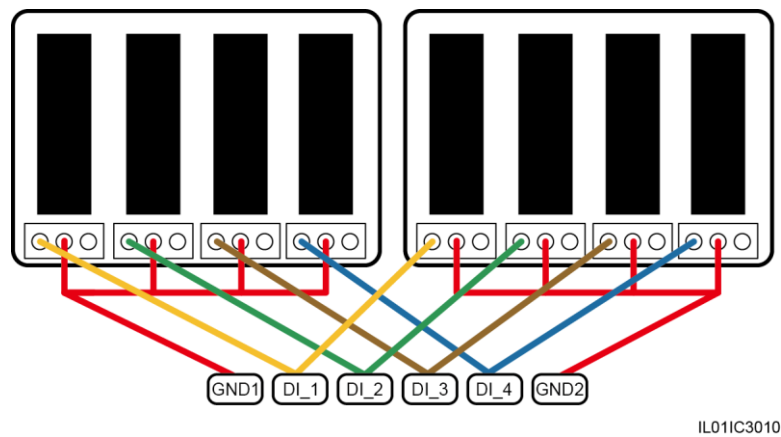

NOTICE

When active power remote control and reactive power remote control are supported, only one out of the four outputs of each ripple control receiver can be closed.

Procedure

- Step 1** Select a cable of appropriate length and connect one end of a cable to the ripple control receiver.
- Step 2** Connect the other end to the DI port in the SmartLogger. For details, see [Step 2–Step 4 in Procedure in 4.3 Connecting the RS485 Signal SPD](#).



NOTICE

To enable a normal power grid scheduling function, you need to set the corresponding parameters (Active Power Control or Reactive Power Control) on the embedded WebUI. For details, see [8 Power Grid Scheduling](#).

----End

Follow-up Procedure

Take operations in reversed order to disconnect the SmartLogger from the ripple control receiver.

5 System Operation

This topic describes how to start the SmartLogger and set the initialization parameters.

5.1 Power-on Process

This section describes how to check the SmartLogger before power-on and how to power on the SmartLogger.

Checking Before Powering On the SmartLogger

Check and ensure the following before powering on the SmartLogger.

- All cables are intact and well insulated.
- All cables are of proper size.
- All cables are correctly connected and secured.

Power-on Process

Power on the devices in the following sequence: Inverter > SmartLogger > PC terminal.



NOTE

The PC terminal refers to a PC where the NetEco1000 is installed.

Step	Operation
1	Perform the requirements mentioned in Checking Before Powering On the SmartLogger .
2	Start the inverter and correctly set the communications parameters (including Address , and Baud rate). For details about how to set the communications parameters, refer to Setting Communications Parameters in the <i>SUN2000 (8KTL-28KTL) User Manual</i> or <i>SUN2000 APP User Manual</i> .
3	Connect the output terminal of the power adapter for the SmartLogger to the power port POWER and the input terminal to the AC socket.

Step	Operation
4	<p>Set the search address segment and baud rate for the RS485 port on the SmartLogger monitoring panel.</p> <p>If the SmartLogger is powered on for the first time, set the search address segment and baud rate for the RS485 port in the Wizard, as shown in 5.2 Setting Initialization Parameters. If it is not powered on for the first time, set the parameters in the Comm. Param. under the Settings, as shown in 6.2.26 Setting Communications Parameters.</p>
5	<p>Wait for the SmartLogger to search for inverters. After the search is completed, the SmartLogger automatically connects to all inverters.</p> <p>Alternatively, you can skip this operation and manually search for, add, or delete inverters in follow-up operations. For details, see 6.2.33 Managing Devices.</p>
6	<p>(Optional) Manually add an environment monitoring instrument, power meter, PLC, or third-party device.</p> <p>For details, see 6.2.33 Managing Devices.</p> <p>NOTICE</p> <p>Before adding an environment monitoring instrument or power meter, log in to the WebUI and correctly set parameters for the device to be added. Before adding a third-party device, import a correct configuration file for the device.</p>
7	<p>(Optional) Start the PC terminal and set Ethernet and NetEco parameters on the SmartLogger.</p>



NOTICE

- Use the delivered 12 V power adapter when starting the SmartLogger. Confirm with the local Huawei engineers if using other types of power adapters.
- Log in to the SmartLogger on the monitoring panel. When you log in to the **Settings** page or **Maintenance** page, an identity authentication is required. The initial password is *000001*. Change the password as soon as possible to ensure the security of the user account. For details about how to change the password, refer to [6.2.25 Changing a Password](#).

5.2 Setting Initialization Parameters

When starting the SmartLogger for the first time, set initialization parameters on the monitoring panel.

Context







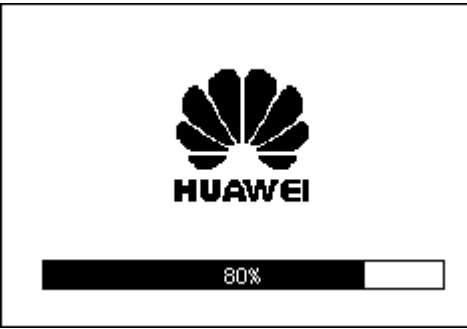
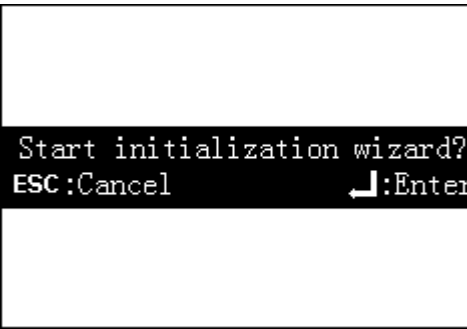

NOTE

If the SmartLogger is started for the first time, set the initialization parameters by referring to this section. If it is not started for the first time, it directly performs the automatic search and then the default page.

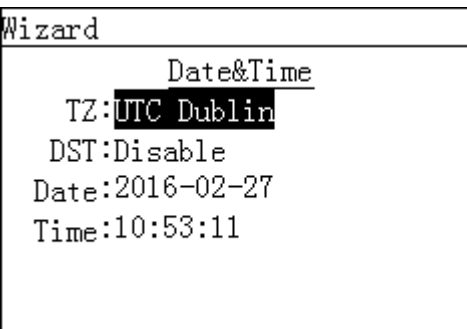
Procedure

- The following table describes the process for setting initialization parameters. The parameter values in the following figures are for reference only.

LCD	Operation Procedure
	<p>1. After startup, the SmartLogger enters the initialization page.</p> <p>The default system language is English.</p>
	<p>2. Press ↵ to enter the Wizard page.</p> <p>To return to the default page, press ESC. If some later re-settings are required, refer to 6.2.20 Setting the System Language, 6.2.21 Setting System Time Parameters, and 6.2.26 Setting Communications Parameters.</p>
	<p>3. Select a display language and then press ↵.</p> <p>The pages will be displayed in the selected language.</p>
	<p>4. Set the correct date and time and then press ↵.</p> <ul style="list-style-type: none"> To select the specific parameter, press ↵. To set the parameter value, press ▲ or ▼. <p>The date and time are displayed in the formats of YYYY-MM-DD and hh:mm:ss respectively. YYYY stands for the year, MM the month, DD the date, hh the hour, mm the minute, and ss the second.</p> <p>NOTICE</p> <p>After the Time is successfully set, this time can be synchronized in all the inverters connected to the SmartLogger.</p>

LCD	Operation Procedure
<pre> Wizard->Ethernet Auto obtain IP:Disable IP address:192.168. 0. 10 Subnet mask:255.255.255. 0 Gateway:192.168. 0. 1 DNS-1:192.168. 0. 1 DNS-2: 0. 0. 0. 0 Submit </pre>	<p>5. Set the Ethernet parameters and then press .</p>
<pre> Wizard Search Address Segments RS485-1:001-100 RS485-2:001-100 RS485-3:001-100 </pre>	<p>6. Set the RS485 search address segment and then press .</p> <p>You need to set the search address segments for RS485-1, RS485-2, and RS485-3 respectively.</p>
<pre> Initialization->Search Devices Search devices now? ESC:Cancel ↓:Enter </pre>	<p>7. On the page, press .</p> <p>After the search is complete, the SmartLogger displays a search result. Press  to end this operation.</p>

 **NOTE**

Visiting some menu requires identity authentication. Therefore, after you set the initialization parameters, change the password immediately to ensure the security of the user account. For details, see [Change the Password](#).

----End

6 User Interface

This topic describes the monitoring menu and operations.

Context

The screenshots shown in this document are from SmartLogger V100R001C00SPC114. Data in the screenshots is for reference only.

6.1 Monitoring Menu Hierarchy

The SmartLogger LCD menus include **Power Station**, **Devices**, **Alarms**, **Settings**, **Maintenance**, and **About**. The **Settings** and **Maintenance** screens vary with the login users.

Table 6-1 LCD monitoring menus

Main Menu	Second-Level Menu	Third-Level Menu
Default screen	Power Station	E-Daily, E-Month, E-Year, E-History, E-Total
	Devices	Logger(Local), Inverter, Logger, Power Meter, PLC, PID, EMI, Custom Device
	Alarms	Active Alarms, Alarm History, Sort By
	Settings	For the user operation permissions of the menu, see Table 6-2 .
	Maintenance	For the user operation permissions of the menu, see Table 6-3 .
	About	-



NOTE

● indicates that the user has permission to operate the menu; ○ indicates that the user does not have permission to operate the menu.

Table 6-2 User operation permissions of the Settings menu

Settings		Common User	Advanced User	Special User
Third-Level Menu	Fourth-Level Menu			
User Param.	Language	●	●	○
	Date&Time	●	●	○
	Date Format	●	●	○
	Contrast	●	●	○
	Currency	●	●	○
	Electricity price/kWh	●	●	○
	CO2 emission reduction	●	●	○
User Password	-	●	●	●
Comm. Param.	RS485-1 to RS485-3	○	●	○
	Ethernet	○	●	○
	NetEco	○	●	○
	Modbus TCP	○	●	○
	IEC103	○	●	○
	SmartLogger Address	○	●	○
Restore Defaults	-	○	●	●

Table 6-3 User operation permissions of the Maintenance menu

Maintenance		Common User	Advanced User	Special User
Third-Level Menu	Fourth-Level Menu			
USB Expansion	Device Logs	○	●	●
	Firmware Upgrade	○	●	●
	Batch Upgrade	○	●	●
	Export all data files	○	●	●

Maintenance		Common User	Advanced User	Special User
Third-Level Menu	Fourth-Level Menu			
	Import all data files	○	●	●
Device Mgmt.	Auto. Search	○	●	●
	Add Manually	○	●	●
	Single Remove	○	●	●
	Batch Remove	○	●	●
	Addr. Allocate	○	●	●
	Config Import	○	●	●
	Alarm Reset	○	●	●
	Batch Power-On/Off	○	●	●
	Batch Reset	○	●	●
Data Clear	-	○	●	●
System Reset	-	○	●	●

6.2 Monitoring Operations

This topic describes how to operate on the monitoring panel, such as querying site and device information and setting system parameters and user parameters.

6.2.1 Querying Power Station Information







This topic describes how to view the power station information on the monitoring panel of the SmartLogger, such as the daily, monthly, yearly, historical, and total energy yield.

Procedure

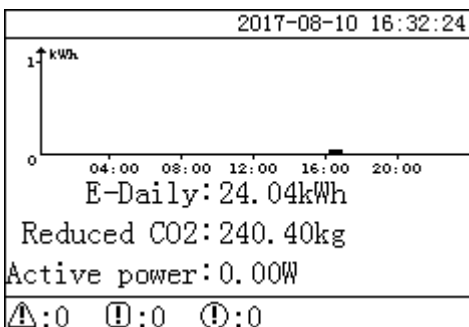
- The following table describes the procedure for viewing power station information. The parameter values in the following figures are for reference only.

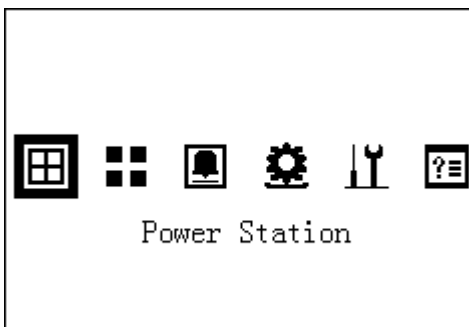
 **NOTICE**

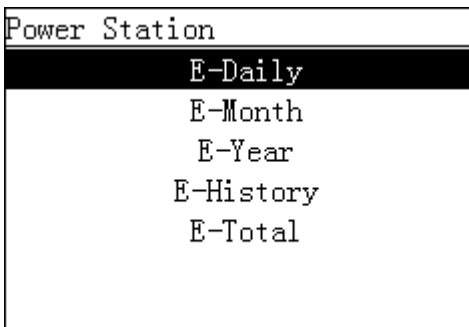

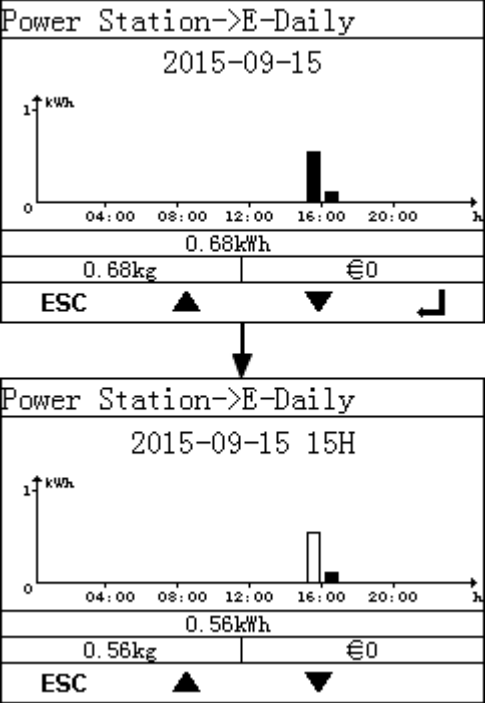

- The daily energy yields can be stored for 30 days on an hourly basis.
- The monthly energy yields can be stored for 1 year on a daily basis.
- The yearly energy yields can be stored for 10 years on a monthly basis.
- The historical energy yields can be stored for 25 years on a yearly basis.

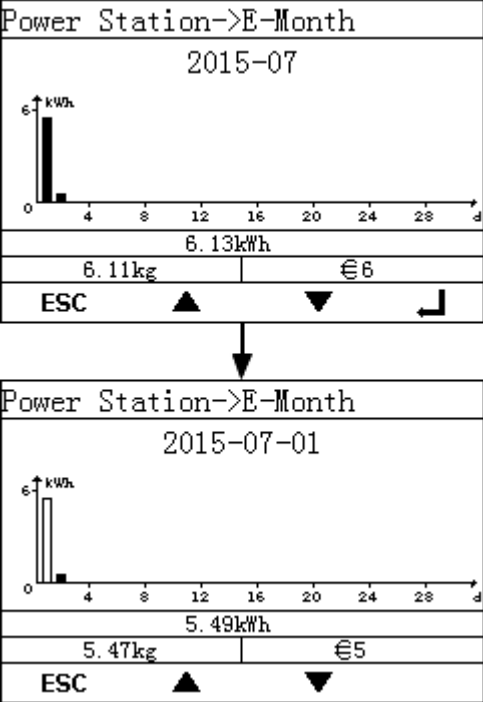
LCD	Operation Procedure
	<p>1. On the default screen, press  to enter the main menu.</p>
	<p>2. Choose  and press .</p>
	<p>3. Press  and  to view the running data of the power station.</p> <p>The running data includes the daily, monthly, yearly, historical, and total energy yield. For details, see step 4 to step 8.</p>

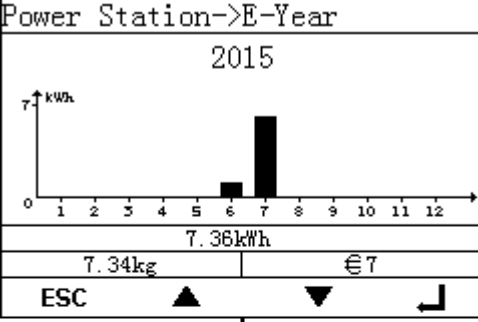
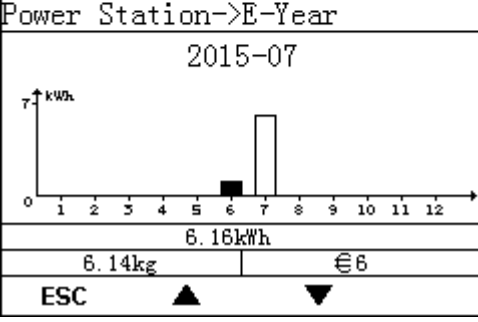
LCD	Operation Procedure
 <p>The LCD displays the following information:</p> <p>Top Screenshot: Title: Power Station->E-Daily Date: 2015-09-15 Histogram: Shows energy yield over time (04:00 to 20:00). A single bar is visible at 16:00. Total Energy Yield: 0.68kWh CO₂ Emission Reduction: 0.68kg Revenue: €0 Navigation: ESC, ▲, ▼, ↵</p> <p>Bottom Screenshot: Title: Power Station->E-Daily Date: 2015-09-15 15H Histogram: Shows energy yield over time (04:00 to 20:00). A single bar is visible at 15:00. Total Energy Yield: 0.56kWh CO₂ Emission Reduction: 0.56kg Revenue: €0 Navigation: ESC, ▲, ▼</p>	<p>4. View the daily energy yield.</p> <p>a. On the E-Daily screen, view the total energy yield and hourly energy yield of the power station on the current day.</p> <p>The displayed information includes the energy yield histogram, date, total energy yield on the current day, CO₂ emission reduction, and revenue.</p> <p>To view the energy yield in the past 30 days (including the current day), press ▲ or ▼.</p> <p>NOTE</p> <p>In the daily energy yield histogram, the abscissa stands for time (each block stands for one hour). The ordinate stands for the total energy yield of all the inverters connected to the SmartLogger (each block stands for the total energy yield during the last hour).</p> <p>b. Press ↵ to view the energy yield of a specific hour on the current day.</p> <p>Press ▲ or ▼ to switch between hours. Then you can view the total energy yield, CO₂ emission reduction, and revenue corresponding to the CO₂ emission reduction during an hour before this sharp time.</p> <p>NOTE</p> <p>The selected block is displayed in white.</p>

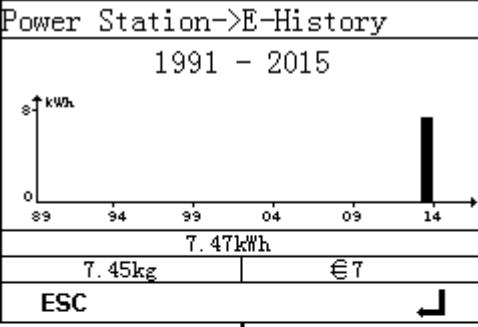
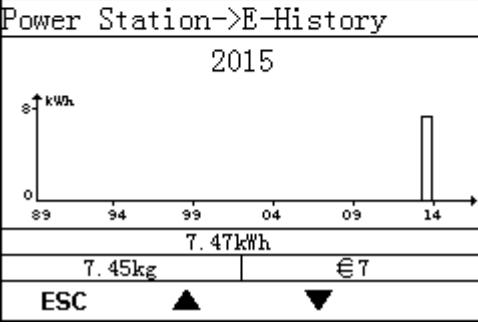
LCD	Operation Procedure
 <p>Power Station->E-Month</p> <p>2015-07</p> <p>6.13kWh</p> <p>6.11kg €6</p> <p>ESC ▲ ▼ ↵</p> <p>Power Station->E-Month</p> <p>2015-07-01</p> <p>5.49kWh</p> <p>5.47kg €5</p> <p>ESC ▲ ▼ ↵</p>	<p>5. View the monthly energy yield.</p> <p>a. On the E-Month screen, view the total energy yield and daily energy yield in the current month.</p> <p>The displayed information includes the energy yield histogram, Month, total energy yield of the current month, CO₂ emission reduction, and revenue.</p> <p>To view the energy yield in the past 12 months (including the current month), press ▲ or ▼.</p> <p>NOTE</p> <p>In the monthly energy yield histogram, the horizontal axis stands for day (each block stands for one day). The vertical axis stands for the total energy yield of all the inverters connected to the SmartLogger (each block stands for the total energy yield on that day).</p> <p>b. Press ↵ to view the energy yield on a specific day of the current month.</p> <p>Press ▲ or ▼ to switch between days. Then you can view the total energy yield, CO₂ emission reduction, and revenue corresponding to the CO₂ emission reduction on the current day.</p> <p>NOTE</p> <p>The selected block is displayed in white.</p>

LCD	Operation Procedure
<div style="border: 1px solid black; padding: 5px; margin-bottom: 10px;"> <p>Power Station->E-Year</p> <p style="text-align: center;">2015</p>  </div> <p style="text-align: center;">↓</p> <div style="border: 1px solid black; padding: 5px;"> <p>Power Station->E-Year</p> <p style="text-align: center;">2015-07</p>  </div>	<p>6. View the yearly energy yield.</p> <p>a. On the E-Year screen, view the total energy yield of the current year and monthly energy yield.</p> <p>The displayed information includes the energy yield histogram, year, total energy yield of the current year, CO₂ emission reduction, and revenue corresponding to the CO₂ emission reduction.</p> <p>To view the energy yield in the past 25 years (including the current year), press ▲ or ▼.</p> <p>NOTE</p> <p>In the yearly energy yield histogram, the horizontal axis stands for month (each block stands for one month). The vertical axis stands for the total energy yield of all the inverters connected to the SmartLogger (each block stands for the total energy yield in that month).</p> <p>b. Press ← to view the monthly energy yield of the current year.</p> <p>Press ▲ or ▼ to switch between months. Then you can view the total energy yield, CO₂ emission reduction, and revenue corresponding to the CO₂ emission reduction in the current month.</p> <p>NOTE</p> <p>The selected block is displayed in white.</p>

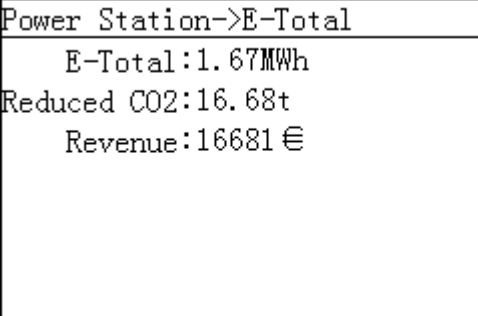
LCD	Operation Procedure
 <p>Power Station->E-History 1991 - 2015</p> <p>7.47kWh 7.45kg €7 ESC</p> <p>↓</p>  <p>Power Station->E-History 2015</p> <p>7.47kWh 7.45kg €7 ESC</p>	<p>7. View the historical energy yield.</p> <p>a. On the E-History screen, view the total energy yield over the past 25 years (including the current year) and yearly energy yield.</p> <p>The displayed information includes the energy yield histogram, Year, total energy yield, CO₂ emission reduction, and revenue.</p> <p>NOTE</p> <p>In the historical energy yield histogram, the horizontal axis stands for year (each block stands for one year). The vertical axis stands for the total energy yield of all the inverters connected to the SmartLogger (each block stands for the total energy yield in that year).</p> <p>b. Press  to view the yearly energy yield over the past 25 years (including the current year).</p> <p>Press  or  to switch between years. Then you can view the total energy yield, CO₂ emission reduction, and revenue corresponding to the CO₂ emission reduction in the current year.</p> <p>NOTE</p> <p>The selected block is displayed in white.</p>
 <p>Power Station->E-Total</p> <p>E-Total:1.67MWh Reduced CO2:16.68t Revenue:16681€</p>	<p>8. On the E-Total screen, view the total energy yield, CO₂ emission reduction, and revenue of all the devices connected to the SmartLogger.</p> <p>The total energy yield of the devices before they connect to the SmartLogger is also counted in the system after they are connected.</p>







----End



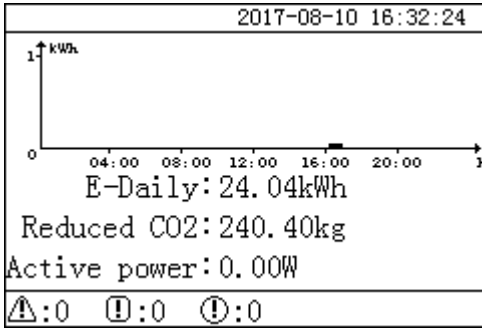

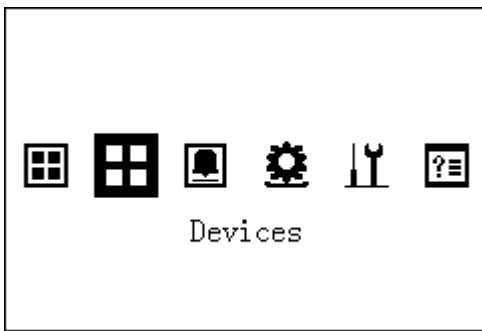

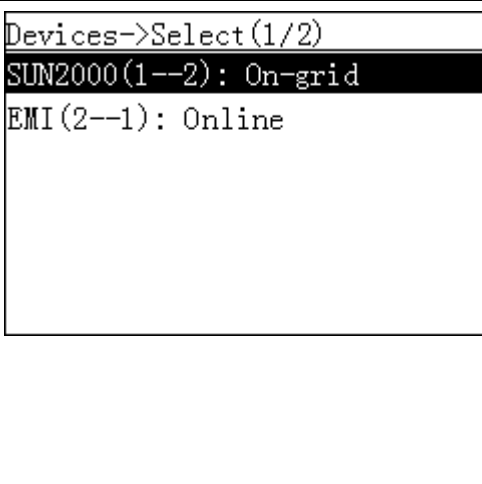
6.2.2 Querying Inverter Information

This topic describes how to query the running information and version of each inverter connected to the SmartLogger.

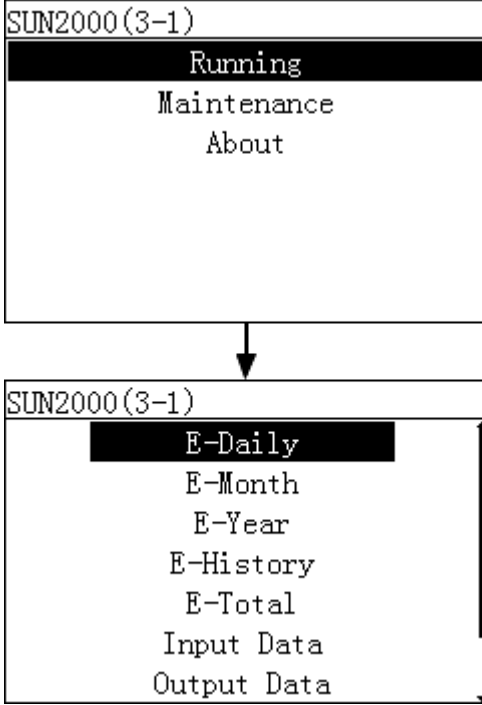
Procedure

- The following table describes the procedure for viewing inverter information. The parameter values in the following figures are for reference only.

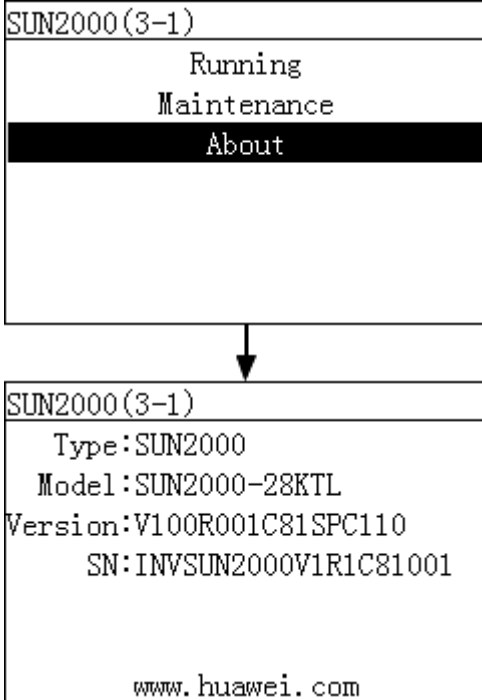
LCD	Operation Procedure
	<p>1. On the default screen, press  to enter the main menu.</p>
	<p>2. Select  and press .</p>
	<p>3. Select an inverter and press .</p> <p>NOTE SUN2000 (1--2) on the left indicates that the inverter connects to Port 1 of the SmartLogger and the communications address of the RS485 port is 2. The device status is displayed behind the device name. The follow-up operations are described as follows:</p> <ul style="list-style-type: none"> • To view the operating data of the inverter, perform step 4. • To view the version of the inverter, perform step 5.

LCD	Operation Procedure
	<p>4. Select Running and press .</p> <p>Press  and  to select the target parameter, and then press .</p>
	<p>5. Select About and press .</p>







----End



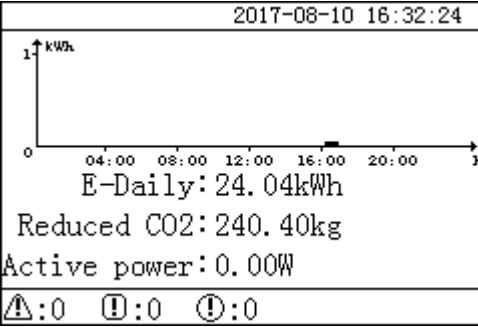

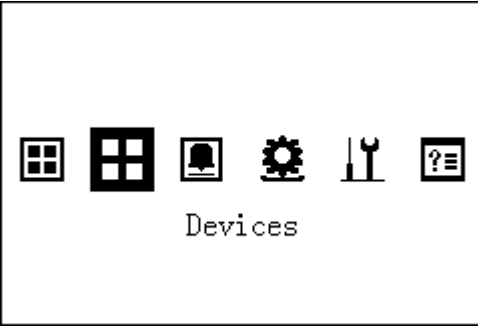
6.2.3 Manually Powering On or Off the Inverter on the monitoring panel

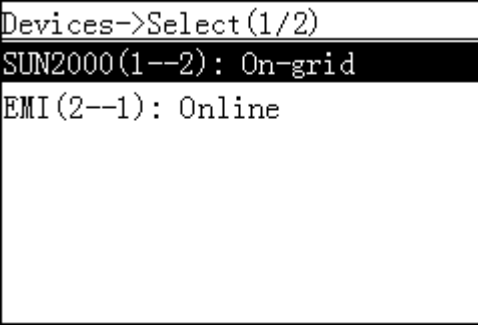

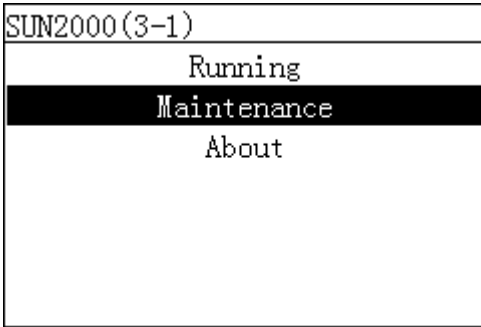

This topic describes how to power on or off the inverter on the monitoring panel.

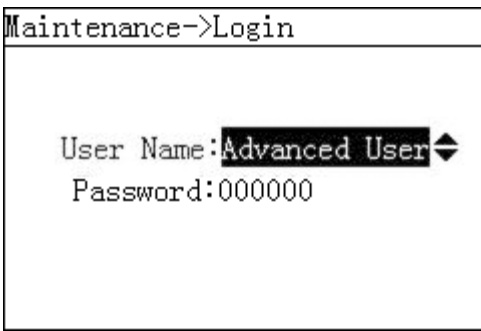
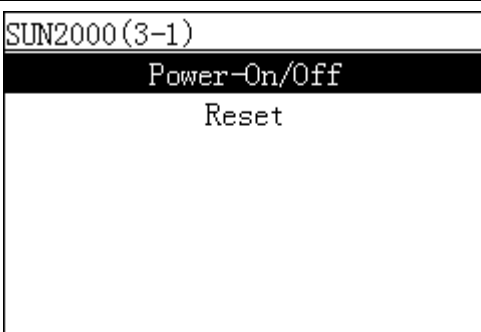
Procedure

- The following table shows the procedure for powering on or off the inverter on the monitoring panel. The parameter values in the following figures are for reference only.

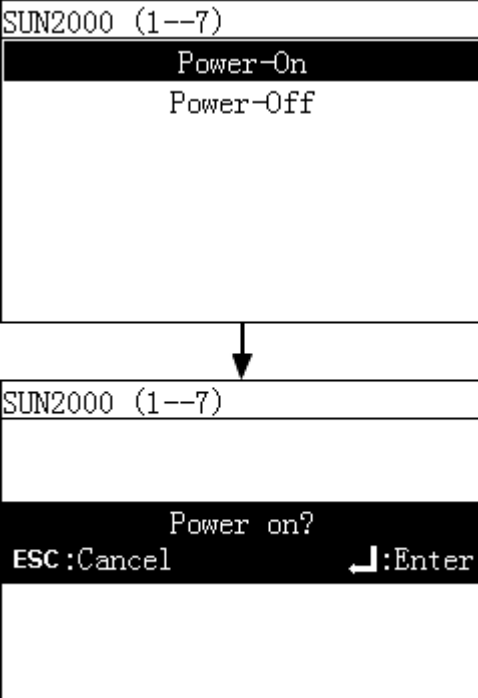
LCD	Operation Procedure
	<p>1. On the default screen, press  to enter the main menu.</p>
	<p>2. Choose  and press .</p>
	<p>3. Select an inverter and press .</p> <p>NOTE SUN2000 (1--2) on the left indicates that the inverter connects to Port 1 of the SmartLogger and the communications address of the RS485 port is 2.</p>

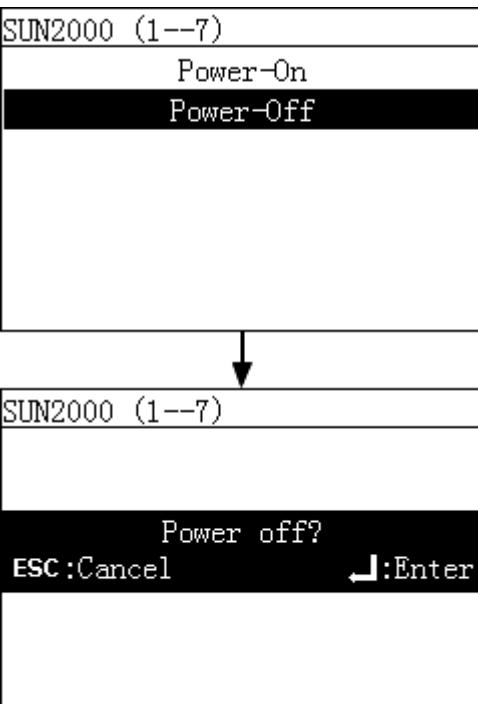
LCD	Operation Procedure
 <p>SUN2000(3-1) Running Maintenance About</p>	<p>4. Choose Maintenance, and press .</p>
 <p>Maintenance->Login User Name: Advanced User Password: 000000</p>	<p>5. Set the specific User Name and Password.</p> <p>NOTE The following user names can be selected: Common User, Advanced User, and Special User. The initial password for Common User, Advanced User and Special User is <i>000001</i>.</p>
 <p>SUN2000(3-1) Power-On/Off Reset</p>	<p>6. Choose Power-On/Off, and press .</p> <ul style="list-style-type: none"> • Perform step 7 if you want to power on the inverter manually. • Perform step 8 if you want to power off the inverter manually.

LCD	Operation Procedure
 <p>SUN2000 (1--7)</p> <p>Power-On</p> <p>Power-Off</p> <p>SUN2000 (1--7)</p> <p>Power on?</p> <p>ESC:Cancel Enter</p>	<p>7. Power on manually.</p> <p>a. Choose Power-On and press .</p> <p>b. Enter  again to verify your settings.</p>
 <p>SUN2000 (1--7)</p> <p>Power-On</p> <p>Power-Off</p> <p>SUN2000 (1--7)</p> <p>Power off?</p> <p>ESC:Cancel Enter</p>	<p>8. Power off manually.</p> <p>a. Choose Power-Off, and press .</p> <p>b. Enter  again to verify your settings.</p>







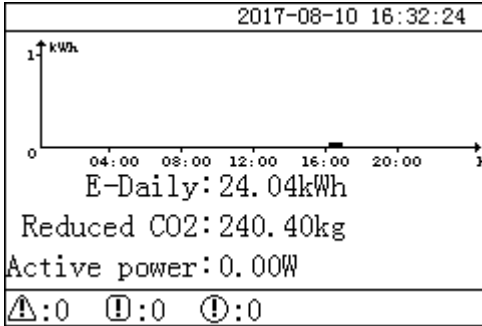

----End

6.2.4 Sending a Reset Command to the Inverter

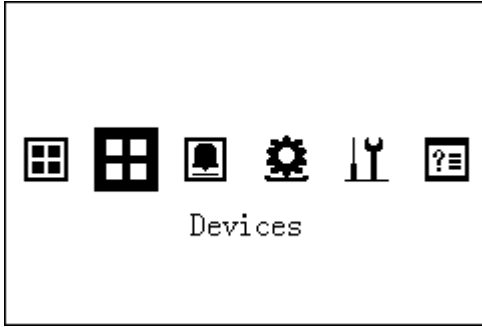
You can send a reset command to the inverter on the LCD.

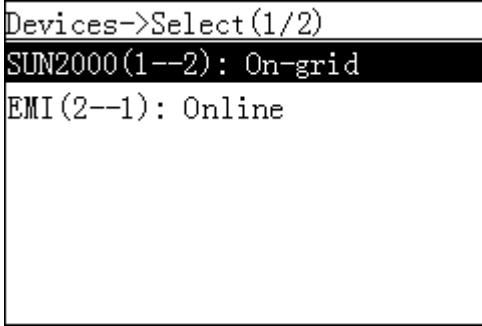
Procedure

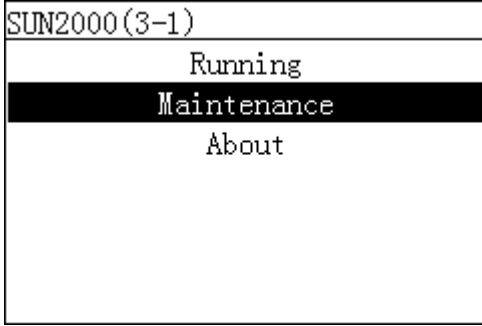
- The following table describes the procedure for sending a reset command to the inverter. The parameter values in the following figures are for reference only.

LCD	Procedure
	<p>1. On the default screen, press  to enter the main menu.</p>
	<p>2. Choose  and press .</p>
	<p>3. Select an inverter and press .</p> <p>NOTE SUN2000 (1--2) on the left indicates that the inverter connects to Port 1 of the SmartLogger and the communications address of the RS485 port is 2.</p>
	<p>4. Choose Maintenance, and press .</p>

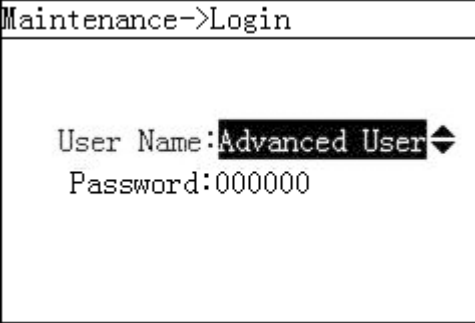
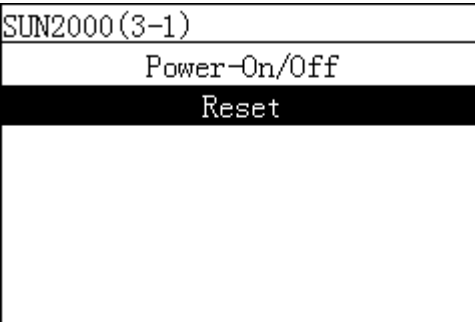
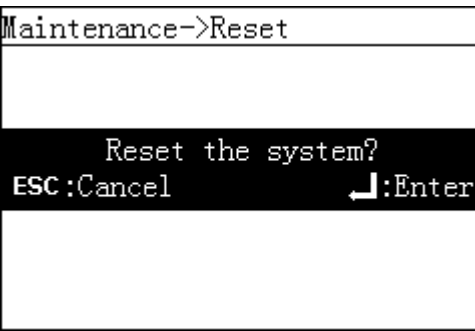
LCD	Procedure
 <p>Maintenance->Login</p> <p>User Name: Advanced User ↕</p> <p>Password: 000000</p>	<p>5. Set User name and Password.</p> <p>NOTE Because of the limited permission, select User name as Advanced User. The initial password for Advanced User is <i>000001</i>.</p>
 <p>SUN2000(3-1)</p> <p>Power-On/Off</p> <p>Reset</p>	<p>6. Choose Reset and press ↵.</p>
 <p>Maintenance->Reset</p> <p>Reset the system?</p> <p>ESC:Cancel ↵:Enter</p>	<p>7. Press ↵.</p>









----End

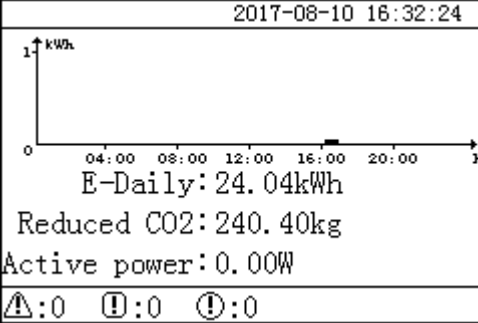

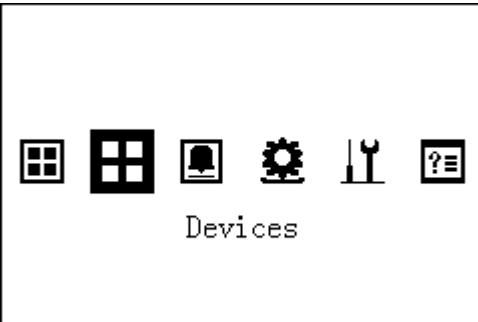
6.2.5 Querying Information about the EMI

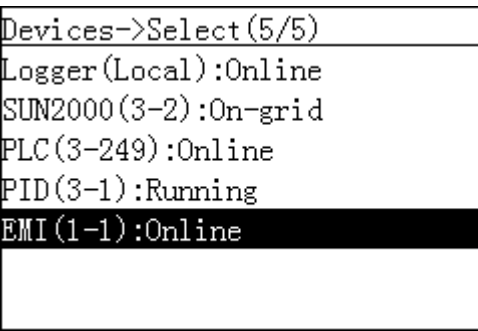
This topic describes how to query the EMI information on the monitoring panel.

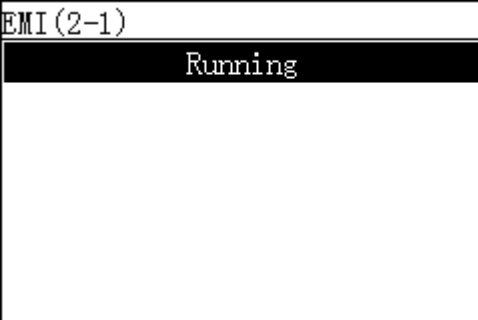
Procedure

- The following table describes the procedure for querying information about the EMI. The parameter values in the following figures are for reference only.

LCD	Operation Procedure
	<p>1. On the default screen, press  to enter the main menu.</p>
	<p>2. Choose  and press .</p>
	<p>3. Choose the name of the EMI and press  to view information about the instrument. The device status is displayed behind the device name.</p>
	<p>4. Choose Running and press .</p> <ul style="list-style-type: none"> • To view the running information of the EMI, perform step 5 only. • To view the communications address of the EMI, perform step 6 only.

LCD	Operation Procedure
<div style="border: 1px solid black; padding: 5px;"> <p>EMI (1-1)</p> <p style="text-align: center;">Running Infomation</p> <p style="text-align: center;">Comm. Address</p> </div> <p style="text-align: center;">↓</p> <div style="border: 1px solid black; padding: 5px;"> <p>EMI (1-1)</p> <p>Total irradi. :220.0W/m²</p> <p>Daily irradiat:0.704kWh/m²</p> <p>PV temperature:39.0degC</p> <p style="padding-left: 20px;">Ambient temp:25.0degC</p> <p style="padding-left: 20px;">Wind speed:23.0m/s</p> <p>Wind direction:45(Northeast)</p> </div>	<p>5. Choose Running Infomation and press </p>
<div style="border: 1px solid black; padding: 5px;"> <p>EMI (1-1)</p> <p style="text-align: center;">Running Infomation</p> <p style="text-align: center;">Comm. Address</p> </div> <p style="text-align: center;">↓</p> <div style="border: 1px solid black; padding: 5px;"> <p>EMI (1-1)</p> <p style="padding-left: 20px;">Port number:1</p> <p style="padding-left: 20px;">Comm. address:1</p> <p>Logical address:9</p> </div>	<p>6. Choose Comm. Address and press </p>







----End

6.2.6 Querying Master SmartLogger Information

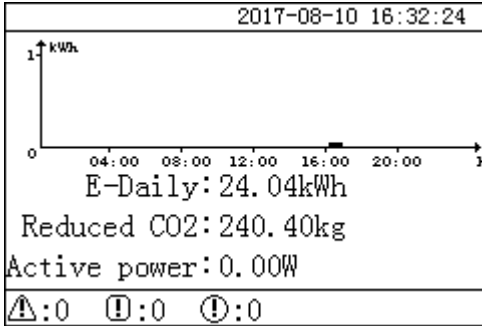
This topic describes how to query Master SmartLogger information.

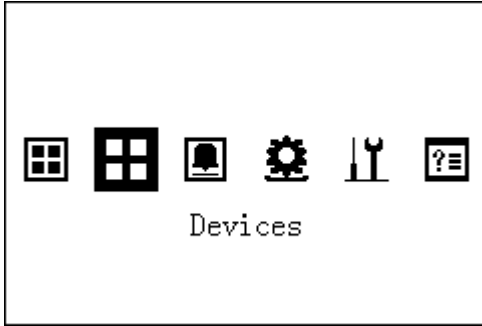
Procedure

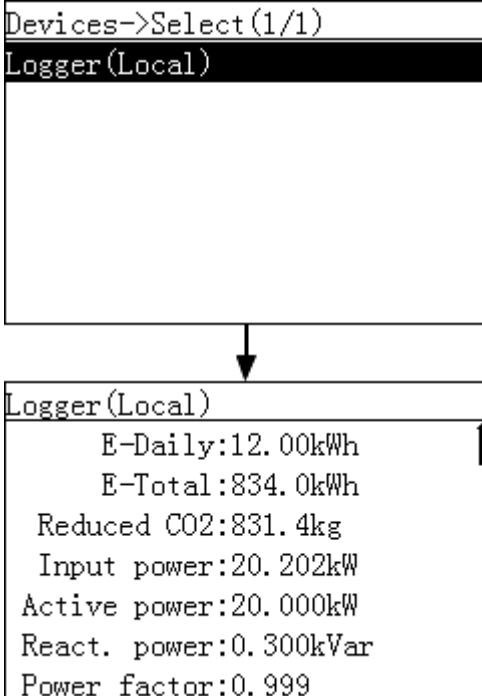
- To query Master SmartLogger information, perform the steps described in the following table. The parameter values in the figures are for reference only.

LCD	Procedure
	<p>1. On the default screen, press  to enter the main menu.</p>
	<p>2. Choose  and press .</p>
	<p>3. Choose Logger (Local) and press  to view the Master SmartLogger information.</p>

----End

6.2.7 Querying Slave SmartLogger Information

This topic describes how to query Slave SmartLogger information on the monitoring panel.

Context

The Slave SmartLogger mainly applies to power grid scheduling of large-sized power stations. One SmartLogger can connect to a maximum of 80 devices. When there are more than 80 inverters in the power station, a certain number of Slave SmartLoggers should be configured. The power grid scheduling command sent to the Master SmartLogger is synchronized to the Slave SmartLogger to enable the centralized power grid scheduling of the power station.

Devices can only be manually added and removed in the Slave SmartLogger on the monitoring panel or the embedded WebUI.





NOTICE

The Slave SmartLogger and the Master SmartLogger should be within the same local area network (LAN).

Procedure

- To query Slave SmartLogger information, perform the steps described in the following table. The parameter values in the figures are for reference only.

LCD	Procedure
	<p>1. On the default screen, press  to enter the main menu.</p>
	<p>2. Select  and press .</p>

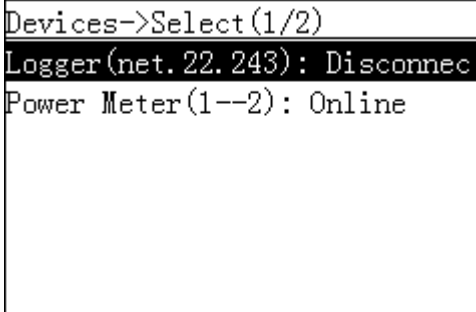
LCD	Procedure
	<p>3. Choose Logger to view the status and IP address of the Slave SmartLogger.</p> <p>The device status is displayed behind the device name.</p>





----End

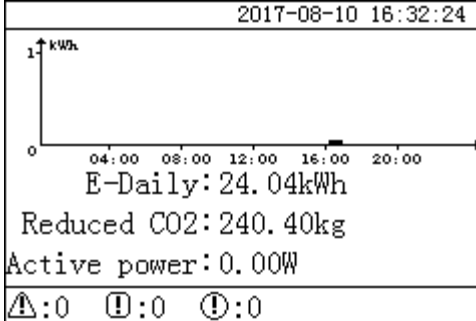

6.2.8 Querying Information About the Modbus Power Meter

You can query information about the Modbus power meter over the LCD.

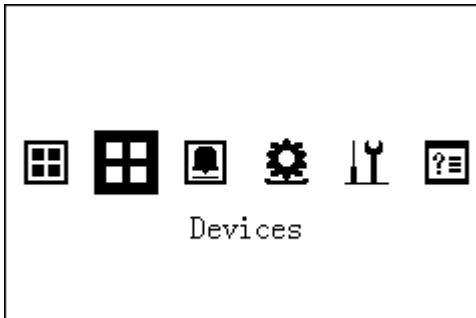
Procedure

- The following table describes the procedure for querying information about the Modbus power meter. The parameter values in the following figures are for reference only.

LCD	Operation Procedure
	<p>1. On the default screen, press  to enter the main menu.</p>
	<p>2. Select  and press .</p>

LCD	Operation Procedure
<pre> Devices->Select(3/3) Logger(Local):Online SUN2000(3-1):On-grid Power Meter(1-1):Online </pre>	<p>3. Choose Power Meter and press  to query the power meter information.</p> <p>NOTE Power Meter (1-1) on the left indicates that the power meter connects to Port 1 of the SmartLogger and the communications address of the RS485 port is 1.</p> <p>The device status is displayed behind the device name.</p>
<pre> Power Meter(1-1) Running </pre>	<p>4. Choose Running and press .</p> <ul style="list-style-type: none"> To view the running information of the power meter, perform step 5 only. To view the communications address of the power meter, perform step 6 only.
<pre> Power Meter(1-1) Running Infomation Comm. Address </pre> <p style="text-align: center;">↓</p> <pre> Power Meter(1-1) A-B line voltage:387.00V B-C line voltage:387.20V C-A line voltage:386.80V Phase A current:23.0A Phase B current:23.0A Phase C current:23.0A Active power:15.000kW </pre>	<p>5. Choose Running Infomation and press .</p>

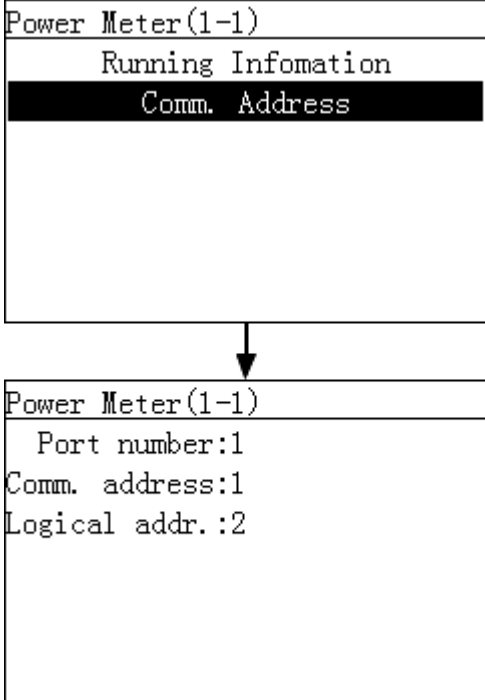
LCD	Operation Procedure
 <p>Power Meter(1-1) Running Infomation Comm. Address</p> <p>↓</p> <p>Power Meter(1-1) Port number:1 Comm. address:1 Logical addr.:2</p>	<p>6. Choose Comm. Address and press ↵.</p>

----End





6.2.9 Querying Information About the DL/T645 Power Meter

You can query information about the DL/T645 power meter information on the LCD.

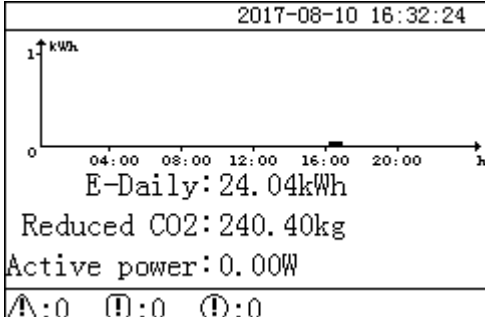
Procedure

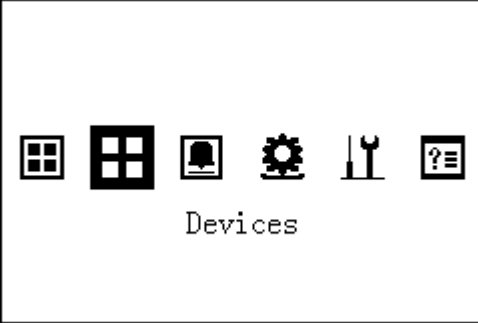
- The following table describes the procedure for querying information about the DL/T645 power meter. The parameter values in the following figures are for reference only.

LCD	Operation Procedure
 <p>2017-08-10 16:32:24</p> <p>↑ kWh</p> <p>0 04:00 08:00 12:00 16:00 20:00 h</p> <p>E-Daily: 24.04kWh Reduced CO2: 240.40kg Active power: 0.00W</p> <p>△:0 □:0 ○:0</p>	<p>1. On the default screen, press ↵ to enter the main menu.</p>

LCD	Operation Procedure
	<p>2. Select  and press .</p>
<pre> Devices->Select (2/2) Logger (Local) :Online Power Meter (3-1) :Online </pre>	<p>3. Choose Power Meter and press .</p> <p>NOTE Power Meter (3-1) on the left indicates that the power meter connects to port 3 of the SmartLogger and its RS485 communications address is 1. The device status is displayed behind the device name.</p>
<pre> Power Meter (3-1) Running Settings </pre>	<p>4. Choose Running and press .</p> <ul style="list-style-type: none"> • To view the running information of the power meter, perform step 5 only. • To view the communications address of the power meter, perform step 6 only.

LCD	Operation Procedure
<div style="border: 1px solid black; padding: 5px; margin-bottom: 10px;"> Power Meter(3-1) Running Infomation Comm. Address </div> <div style="text-align: center; margin-bottom: 10px;">↓</div> <div style="border: 1px solid black; padding: 5px;"> Power Meter(3-1) Power meter No. :00000000 Phase A voltage:0.00V Phase B voltage:0.00V Phase C voltage:0.00V A-B line voltage:0.00V B-C line voltage:0.00V C-A line voltage:0.00V </div>	<p>5. Choose Running Infomation and press .</p>
<div style="border: 1px solid black; padding: 5px; margin-bottom: 10px;"> Power Meter(3-1) Comm. Address </div> <div style="text-align: center; margin-bottom: 10px;">↓</div> <div style="border: 1px solid black; padding: 5px;"> Power Meter(3-1) Port number:3 Comm. address:1 Logical addr.:5 </div>	<p>6. Choose Comm. Address and press .</p>









----End

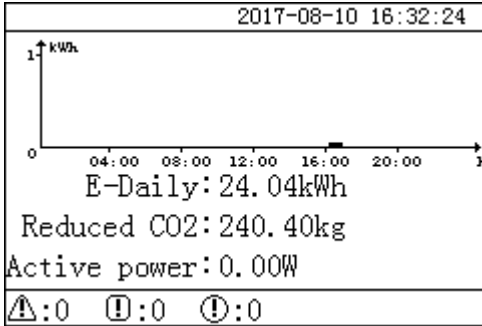

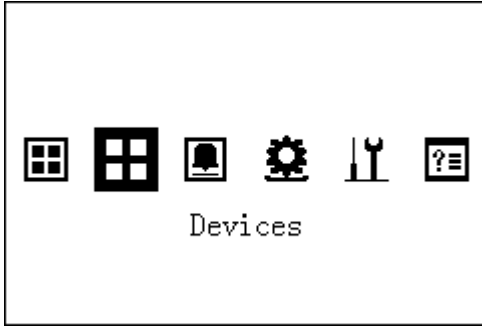
6.2.10 Setting DL/T645 Power Meter Parameters

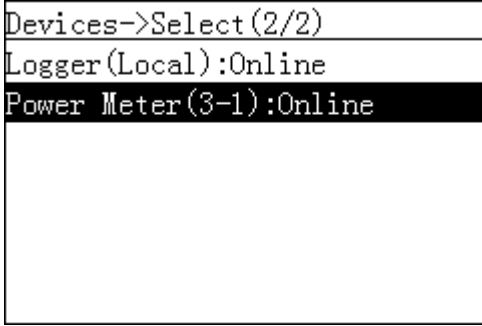
You can set DL/T645 power meter parameters on the LCD.

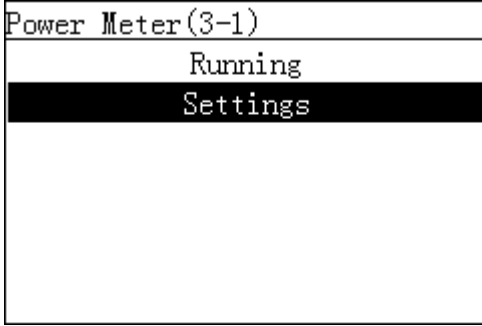
Procedure

- The following table describes the procedure for setting DL/T645 power meter parameters. The parameter values in the following figures are for reference only.

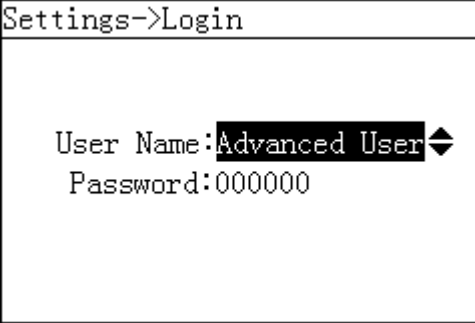
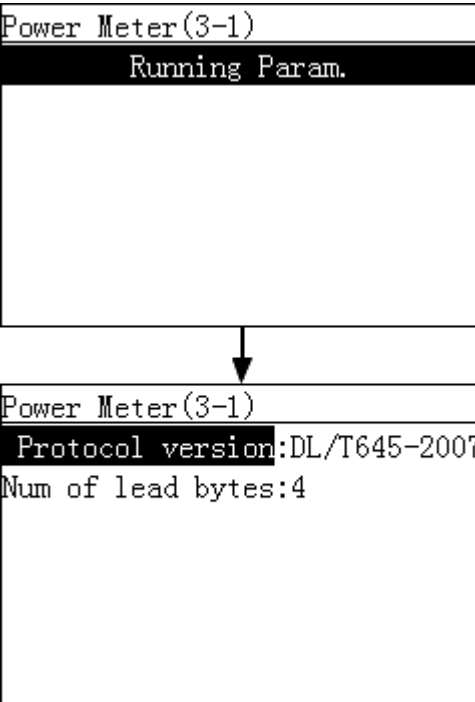
LCD	Operation Procedure
	<p>1. On the default screen, press  to enter the main menu.</p>
	<p>2. Select  and press .</p>
	<p>3. Choose Power Meter and press .</p> <p>NOTE Power Meter (3-1) on the left indicates that the power meter connects to port 3 of the SmartLogger and its RS485 communications address is 1. The device status is displayed behind the device name.</p>
	<p>4. Choose Settings and press .</p>

LCD	Operation Procedure
	<p>5. Set User name and Password.</p> <p>NOTE Because of the limited permission, select User name as Advanced User. The initial password for Advanced User is <i>000001</i>.</p>
	<p>6. Choose Running Param. and press .</p>







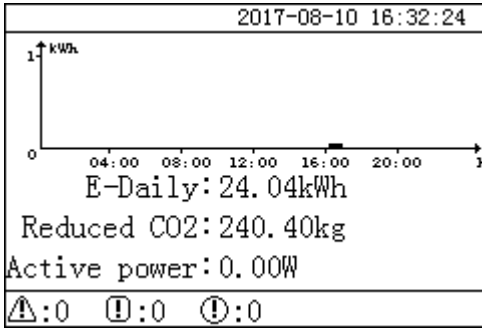

----End

6.2.11 Querying PLC Information

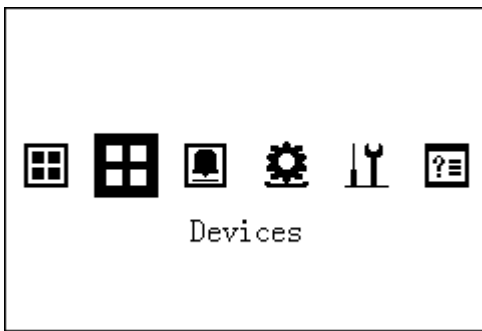
This section describes how to query the running information and version of a PLC connected to the SmartLogger.

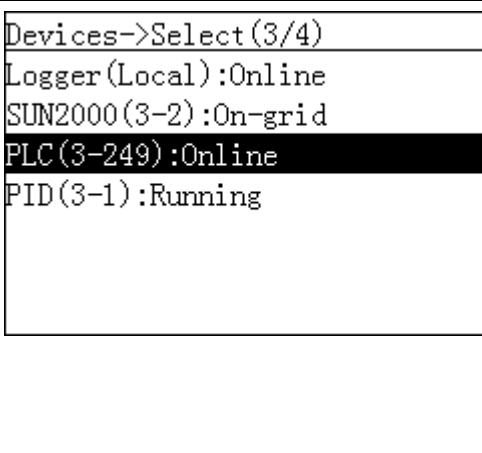
Procedure

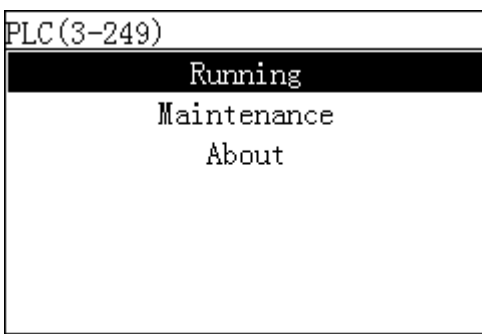
- The following table describes the procedure for viewing the information about a PLC. The parameter values in the figures are for reference only.

LCD	Operation Procedure
	<p>1. On the default screen, press  to enter the main menu.</p>
	<p>2. Select  and press .</p>
	<p>3. Select PLC and press .</p> <p>NOTE PLC (3-249) in the left figure indicates that PLC is connected to Port 3 of the SmartLogger, whose RS485 address is 249. The device status is displayed behind the device name. The subsequent operations are as follows:</p> <ul style="list-style-type: none"> • To view the running information of the PLC, perform step 4 to 6. • To view the version information of the PLC, perform step 7 only.
	<p>4. Select Running and press .</p>

LCD	Operation Procedure
<div style="border: 1px solid black; padding: 5px; margin-bottom: 10px;"> <p>PLC(3-249)</p> <p style="background-color: black; color: white; text-align: center;">Running Infomation</p> <p style="text-align: center;">Comm. Address</p> </div> <p style="text-align: center;">↓</p> <div style="border: 1px solid black; padding: 5px;"> <p>PLC(3-249)</p> <p>CCO net status:networked</p> <p>Device ident.:Search complete</p> <p style="text-align: center;">SNID:1</p> </div>	<p>5. Select Running Infomation and press ↵.</p>
<div style="border: 1px solid black; padding: 5px; margin-bottom: 10px;"> <p>PLC(3-249)</p> <p style="background-color: black; color: white; text-align: center;">Running Infomation</p> <p style="background-color: black; color: white; text-align: center;">Comm. Address</p> </div> <p style="text-align: center;">↓</p> <div style="border: 1px solid black; padding: 5px;"> <p>PLC(3-249)</p> <p>Port number:3</p> <p>Comm. address:249</p> <p>Logical addr.:6</p> </div>	<p>6. Select Comm. Address and then press ↵.</p>

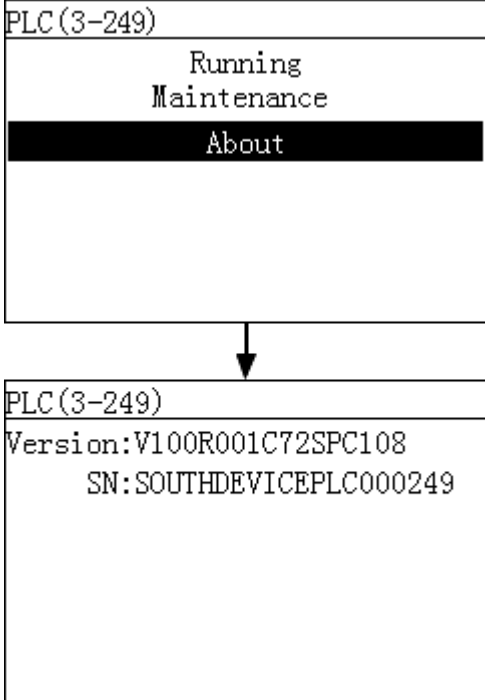
LCD	Operation Procedure
 <p>PLC(3-249)</p> <p>Running Maintenance About</p> <p>↓</p> <p>PLC(3-249) Version:V100R001C72SPC108 SN:SOUTHDEVICEPLC000249</p>	<p>7. Select About and press ↵.</p>

----End





6.2.12 Setting PLC Running Parameters

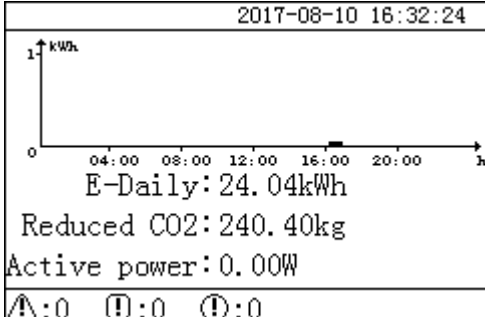

You can set the PLC running parameters on the monitoring panel.

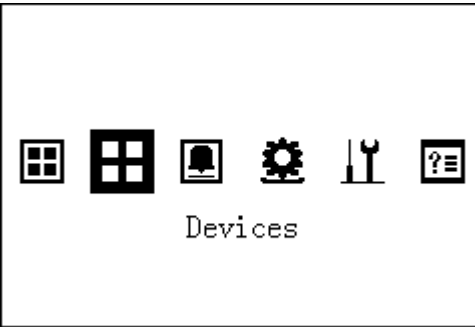
Procedure

- The following table describes the procedure for setting the PLC running parameters. The parameter values in the following figures are for reference only.

LCD	Procedure
 <p>2017-08-10 16:32:24</p> <p>↑ kWh</p> <p>0 04:00 08:00 12:00 16:00 20:00 h</p> <p>E-Daily: 24.04kWh Reduced CO2: 240.40kg Active power: 0.00W</p> <p>⚠:0 ⓘ:0 ⓘ:0</p>	<p>1. On the default screen, press ↵ to enter the main menu.</p>

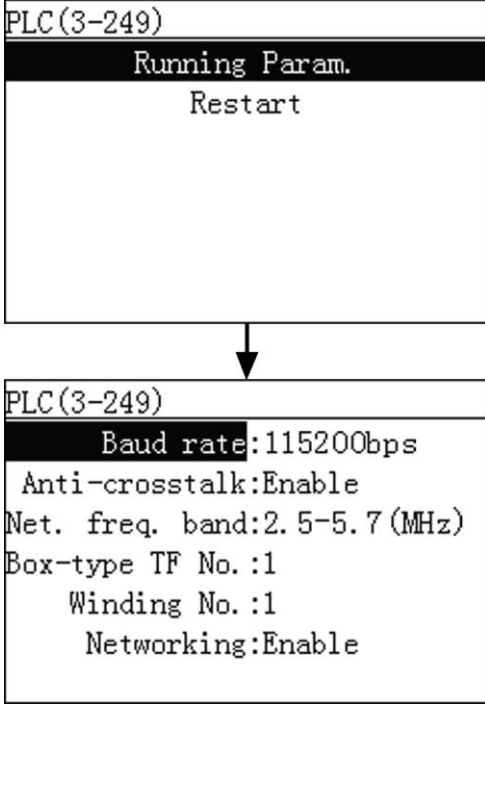
LCD	Procedure
	<p>2. Choose  and press .</p>
<pre>Devices->Select(3/4) Logger(Local):Online SUN2000(3-2):On-grid PLC(3-249):Online PID(3-1):Running</pre>	<p>3. Select PLC and press .</p> <p>NOTE PLC (3-249) in the left figure indicates that PLC is connected to Port 3 of the SmartLogger, whose RS485 address is 249.</p>
<pre>PLC(3-249) Running Maintenance About</pre>	<p>4. Choose Maintenance and press .</p>
<pre>Maintenance->Login User Name:Advanced User Password:000000</pre>	<p>5. Set User name and Password.</p> <p>NOTE Because of the limited permission, select User name as Advanced User. The initial password for Advanced User is 000001.</p>

LCD	Procedure
 <p>The LCD shows the following sequence of screens:</p> <ul style="list-style-type: none"> PLC(3-249) Running Param. Restart Baud rate:115200bps Anti-crosstalk:Enable Net. freq. band:2.5-5.7 (MHz) Box-type TF No.:1 Winding No.:1 Networking:Enable 	<p>6. Choose Running Param. and press .</p> <ul style="list-style-type: none"> • Baud rate is set to 115200 by default, which provides optimal communications performance and does not need to be changed. • When Anti-crosstalk is set to Enable, the inverters equipped with the PLC STA module on the SN list can connect to the network. • When Box-type TF No. and Winding No. of the PLC CCO are consistently set, the inverters equipped with the PLC STA module can be automatically added to the STA list. • When the PLC CCO is SUN2000 V100R001C72SPC104 or later versions, you can set Networking. When the SmartLogger communicates with the SUN2000 over PLC, set Networking to Enable (Enable by default). When the SmartLogger communicates with the inverter over RS485 only, set Networking to Disable.



----End



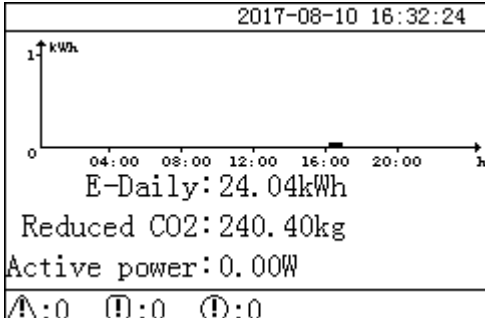

6.2.13 Sending a Reset Command to the PLC

You can send a reset command to the PLC on the monitoring panel.

Procedure

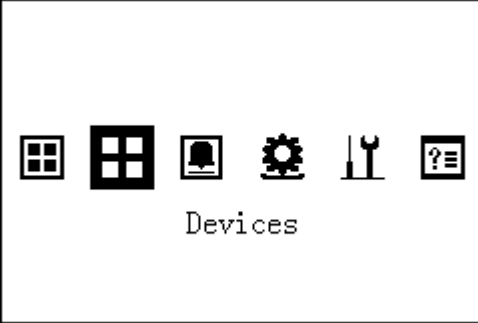
- The following table describes the steps for sending a reset command to the PLC. The parameter values in the following figures are for reference only.

LCD	Operation Procedure
 <p>The LCD displays the following information:</p> <ul style="list-style-type: none"> 2017-08-10 16:32:24 Graph showing power consumption (kW) over time (h) with a peak at 16:00. E-Daily: 24.04kWh Reduced CO2: 240.40kg Active power: 0.00W Alarm indicators: A:0, I:0, O:0 	<p>1. On the default screen, press  to enter the main menu.</p>

LCD	Operation Procedure
 <p>Devices</p>	<p>2. Choose  and press .</p>
<pre> Devices->Select(3/4) Logger(Local):Online SUN2000(3-2):On-grid PLC(3-249):Online PID(3-1):Running </pre>	<p>3. Select PLC and press .</p> <p>NOTE PLC (3-249) in the left figure indicates that PLC is connected to Port 3 of the SmartLogger, whose RS485 address is 249.</p>
<pre> PLC(3-249) Running Maintenance About </pre>	<p>4. Choose Maintenance and press .</p>
<pre> Maintenance->Login User Name:Advanced User Password:000000 </pre>	<p>5. Set User name and Password.</p> <p>NOTE Because of the limited permission, select User name as Advanced User. The initial password for Advanced User is 000001.</p>

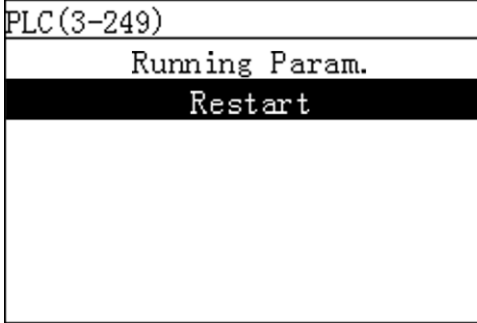
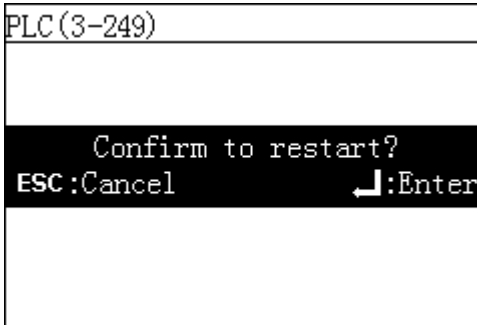
LCD	Operation Procedure
 <p>PLC(3-249) Running Param. Restart</p>	<p>6. Choose Restart and press ↵.</p>
 <p>PLC(3-249) Confirm to restart? ESC:Cancel ↵:Enter</p>	<p>7. Press ↵ to verify your settings.</p>

----End







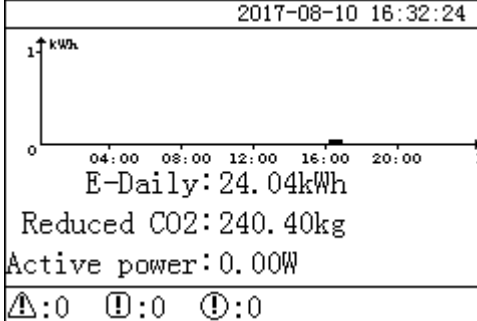

6.2.14 Querying PID Information

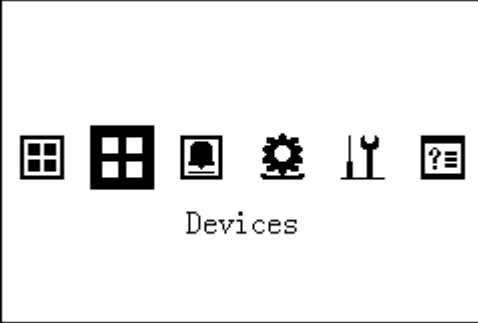
This topic describes how to query the running information and version of a PID connected to the SmartLogger.

Procedure

- The following table describes the procedure for viewing the information about a PID. The parameter values in the figures are for reference only.

LCD	Operation Procedure
 <p>2017-08-10 16:32:24 ↑ kWh 0 04:00 08:00 12:00 16:00 20:00 h E-Daily: 24.04kWh Reduced CO2: 240.40kg Active power: 0.00W ⚠:0 Ⓜ:0 Ⓜ:0</p>	<p>1. On the default screen, press ↵ to enter the main menu.</p>

LCD	Operation Procedure
	<p>2. Select  and press .</p>
<pre> Devices->Select (4/4) Logger (Local) :Online SUN2000 (3-2) :On-grid PLC (3-249) :Online PID (3-1) :Running </pre>	<p>3. Select a PID and press .</p> <p>NOTE PID (3-1) in the left figure indicates that the PID is connected to the Port 3 of the SmartLogger, and its RS485 communications address is 1.</p> <p>The subsequent operations are as follows:</p> <ul style="list-style-type: none"> • To view the operating data of the PID, perform step 4 only. • To view the version information of the PID, perform step 5 only.
<pre> PID (3-1) Running Settings About </pre> <p style="text-align: center;">↓</p> <pre> PID (3-1) Running Infomation Comm. Address </pre>	<p>4. Select Running and press .</p> <p>Press  and  to select Runing Infomation or Comm. Address, and then press .</p>

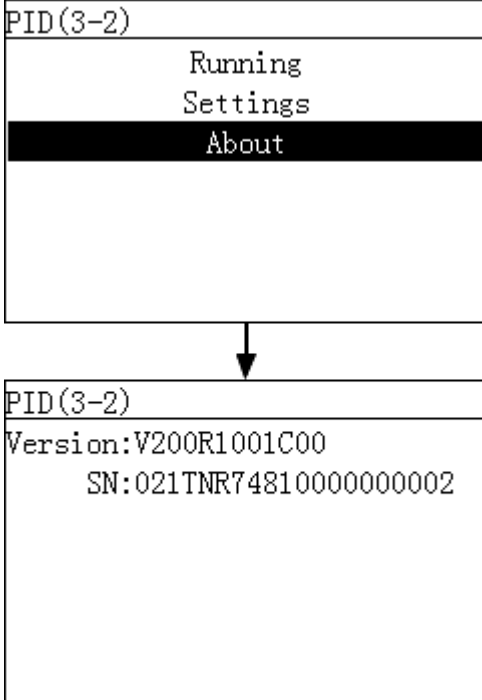
LCD	Operation Procedure
 <p>The image shows two sequential LCD screens. The first screen displays 'PID(3-2)' at the top, followed by three menu options: 'Running', 'Settings', and 'About'. The 'About' option is highlighted with a black bar. A downward arrow indicates the next screen, which shows 'PID(3-2)' at the top, followed by 'Version:V200R1001C00' and 'SN:021TNR74810000000002'.</p>	<p>5. Select About and press ↵.</p>

----End





6.2.15 Setting the PID Module Running Parameters

You can set the PID module running parameters on the LCD.

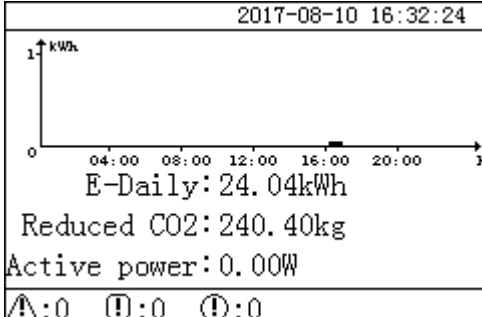
Procedure

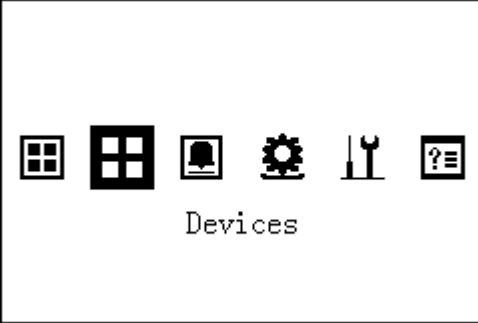
- The following table describes the procedure for setting the PID module running parameters. The parameter values in the figures are for reference only.

LCD	Operation Procedure
 <p>The image shows an LCD screen with a graph at the top. The graph has a y-axis labeled 'kWh' and an x-axis labeled 'h' with time markers at 04:00, 08:00, 12:00, 16:00, and 20:00. The date and time '2017-08-10 16:32:24' are displayed at the top right. Below the graph, the following statistics are shown: 'E-Daily: 24.04kWh', 'Reduced CO2: 240.40kg', and 'Active power: 0.00W'. At the bottom, there are three status indicators: a triangle with an exclamation mark, a circle with an exclamation mark, and another circle with an exclamation mark, all followed by ':0'.</p>	<p>1. On the default screen, press ↵ to enter the main menu.</p>

LCD	Operation Procedure
	<p>2. Choose  and press .</p>
<pre>Devices->Select(4/4) Logger(Local):Online SUN2000(3-2):On-grid PLC(3-249):Online PID(3-1):Running</pre>	<p>3. Select a PID and press .</p> <p>NOTE PID (3-1) in the left figure indicates that the PID is connected to the Port 3 of the SmartLogger, and its RS485 communications address is 1.</p>
<pre>PID(3-2) Running Settings About</pre>	<p>4. Choose Settings and press .</p>
<pre>Settings->Login User Name:Advanced User Password:000000</pre>	<p>5. Set User name and Password.</p> <p>NOTE Because of the limited permission, select User name as Advanced User. The initial password for Advanced User is 000001.</p>

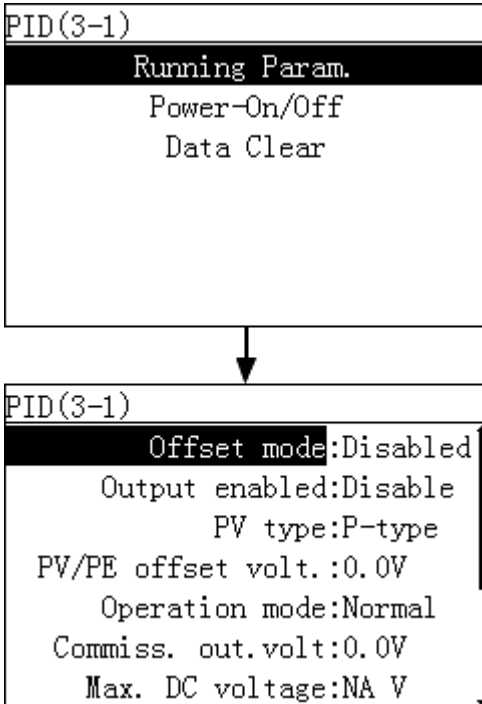
LCD	Operation Procedure
 <p>PID(3-1)</p> <p>Running Param.</p> <p>Power-On/Off</p> <p>Data Clear</p> <p>↓</p> <p>PID(3-1)</p> <p>Offset mode: Disabled</p> <p>Output enabled: Disable</p> <p>PV type: P-type</p> <p>PV/PE offset volt.: 0.0V</p> <p>Operation mode: Normal</p> <p>Commiss. out. volt.: 0.0V</p> <p>Max. DC voltage: NA V</p>	<p>6. Choose Running Param. and press ↵.</p>

----End

Parameter Description

Table 6-4 describes the PID module running parameters.

Table 6-4 Running parameter descriptions

No.	Parameter Name	Function	Parameter Value	Description
1	Offset mode	Specifies the offset mode of the PID module.	Disabled	Set this parameter to Disable if the PID module is not required.
			N/PE	Set this parameter to N/PE if the PID module is required to use voltage output from the inductor virtual midpoint N.
			PV/PE	Set this parameter to PV/PE if the PID module is required to use voltage output from the negative PV terminal. This mode is applicable only to SUN8000.
			Automatic	In the SUN2000, Automatic indicates the N/PE offset mode.
2	Output enabled	Specifies whether the PID module	Enable	Set this parameter to Enable to allow the PID module output.

No.	Parameter Name	Function	Parameter Value	Description
		output is enabled.	Disable	Set this parameter to Disable to forbid the PID module output.
3	PV type	Specifies the type of the PV module used in the power station. For details about the PV module type, consult the manufacturer.	P-type	Set this parameter to P-type if the PV module type is P. In this case, the PID module output voltage is positive.
			N-type	Set this parameter to N-type if the PV module type is N. In this case, the PID module output voltage is negative.
4	PV/PE offset volt.	Specifies the DC voltage when the offset mode is set to PV/PE.	0–200 V	It is recommended that the offset voltage be set to a value ranging from 50 V to 200 V.
5	Operation Mode	Specifies whether the PID module is currently working in normal or commissioning mode.	Commissioning	In commissioning mode, if you need to set the output mode to PV/PE or N/PE , set Output enabled to Enable . The PID module delivers output voltages based on the value of Commiss. out.volt . NOTE Before the first power-on, to check whether the PID functions properly, it is recommended that Operation mode be set to Commissioning .
			Normal	In normal mode, the PID module operates automatically after the PID module, inverter, and SmartLogger communicate with each other properly.
6	Commiss. out.volt	Specifies the output voltage when the PID module works in commissioning mode.	0–500 V	It is recommended that the commissioning voltage for the 1000 V/1100 V inverter be set to a value ranging from 50 V to 400 V. NOTE After this parameter is set and the output from the PID module becomes stable, use a multimeter that is set to the DC position to measure the three-phase (A, B, and C) voltages of the power grid to the ground, and check whether the voltages are the same as the configured values.
7	Max. DC voltage	Specifies the PV-PE voltage when Operation Mode is set to Normal or Commissioning .	500–1500 V	If the PV module type is P, the parameter value indicates the highest DC voltage between PV+ and PE; if the PV module type is N, the parameter value indicates the highest DC voltage between PV- and PE.









No.	Parameter Name	Function	Parameter Value	Description
8	Maximum output voltage	Specifies the maximum output voltage of the PID module when Operation Mode is set to Normal or Commissioning .	0–500 V	If the compensation mode is PV/PE , the parameter value indicates the highest DC output voltage between PV and PE; if the compensation mode is N/PE , the parameter value indicates the highest DC output voltage between N and PE.
9	IMD access	Specifies whether the PID module and insulation monitor device (IMD) can operate in cycle mode.	Enable	Select Enable if you allow the PID module and IMD to operate in cycle mode. Only the IMDs of mainstream suppliers such as DOLD and BENDER are supported, and the IMDs must have enabled dry contacts.
			Disable	Select Disable if you forbid the access of IMDs.
10	Periodic PID runtime	Specifies the operating time segment of the PID module when the PID module and IMD operate in cycle mode.	60–480 min	The IMD device is shut down when the PID module is operating.
11	Periodic IMD runtime	Specifies the operating time segment of the IMD when the PID module and IMD operate in cycle mode.	15–480 min	The PID module is standby when the IMD device is operating.
12	IMD control dry contact	Dry contact No. over which the SmartLogger controls the IMD	DO1, DO2, and DO3	Set appropriate ports based on the cable connections between the IMD and the SmartLogger.

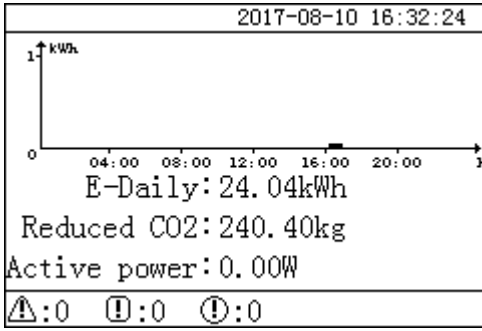

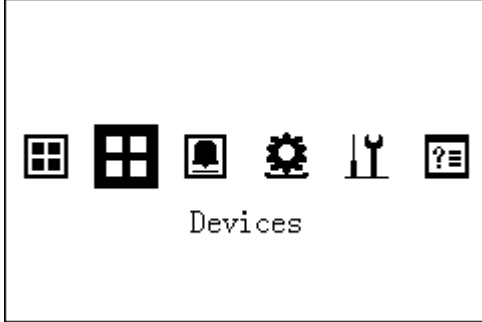

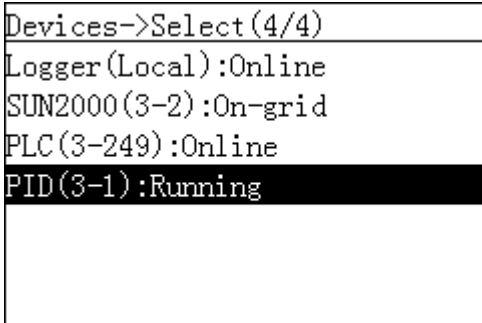
6.2.16 Manually Powering On or Off the PID on the monitoring panel

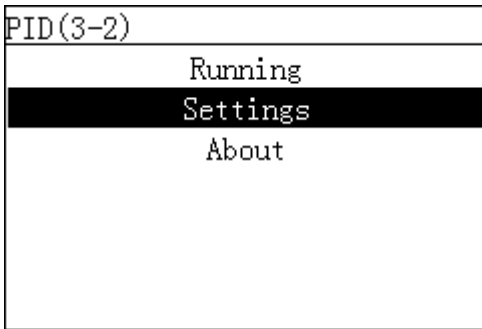
This topic describes how to power on or off the PID on the monitoring panel.

Procedure

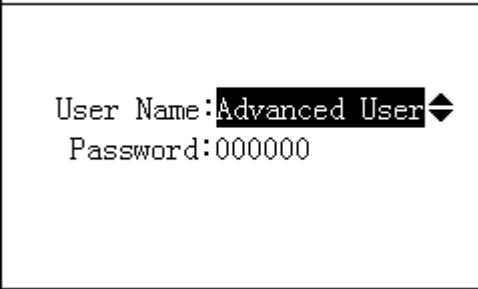
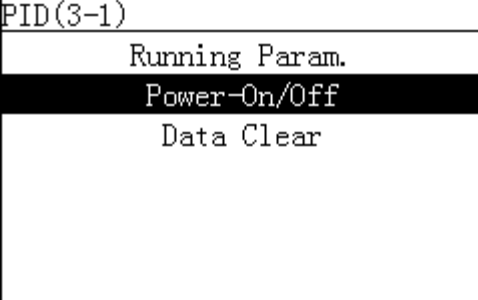
- The following table shows the procedure for powering on or off the PID on the monitoring panel. The parameter values in the following figures are for reference only.

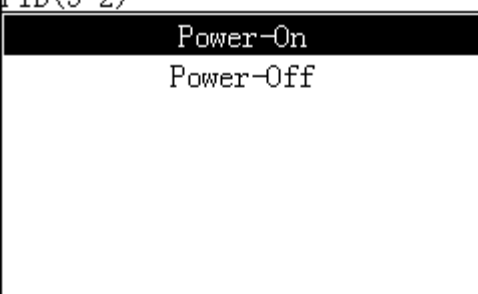
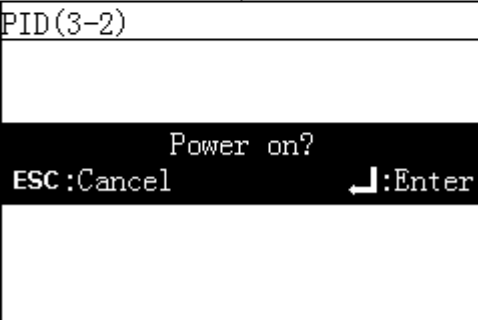
LCD	Operation Procedure
	<p>1. On the default screen, press  to enter the main menu.</p>
	<p>2. Choose  and press .</p>
	<p>3. Select a PID and press .</p> <p>NOTE PID (3-1) in the left figure indicates that the PID is connected to the Port 3 of the SmartLogger, and its RS485 communications address is 1.</p>
	<p>4. Select Settings and press .</p>

LCD	Operation Procedure
<p>Settings->Login</p> 	<p>5. Set User name and Password.</p> <p>NOTE Because of the limited permission, select User name as Advanced User. The initial password for Advanced User is <i>000001</i>.</p>
<p>PID(3-1)</p> 	<p>6. Choose Power-On/Off, and press .</p> <ul style="list-style-type: none"> • Perform step 7 if you want to power on the inverter manually. • Perform step 8 if you want to power off the inverter manually.
<p>PID(3-2)</p>  <p style="text-align: center;">↓</p> <p>PID(3-2)</p> 	<p>7. Power on manually.</p> <p>a. Choose Power-On and press .</p> <p>b. Enter  again to verify your settings.</p>

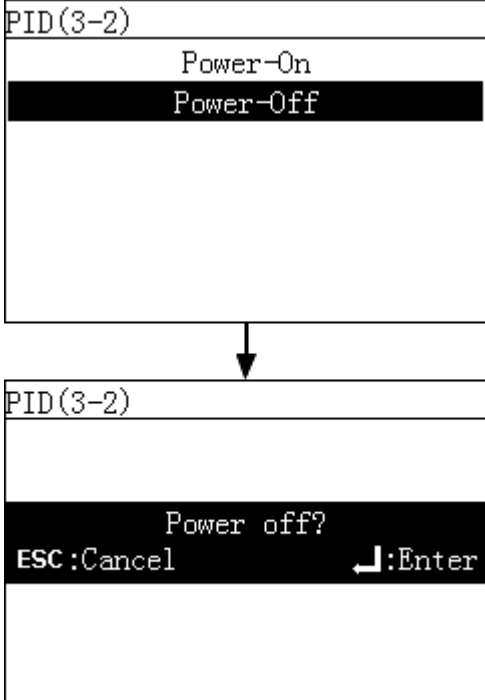
LCD	Operation Procedure
 <p>PID(3-2)</p> <p>Power-On</p> <p>Power-Off</p> <p>↓</p> <p>PID(3-2)</p> <p>Power off?</p> <p>ESC:Cancel ↵:Enter</p>	<p>8. Power off manually.</p> <p>a. Choose Power-Off, and press ↵.</p> <p>b. Enter ↵ again to verify your settings.</p>

----End





6.2.17 Clearing Historical PID Information

You can clear the active alarms and historical alarms stored on the PID module over the LCD.

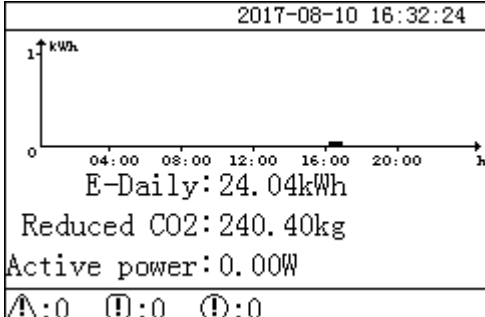
Procedure

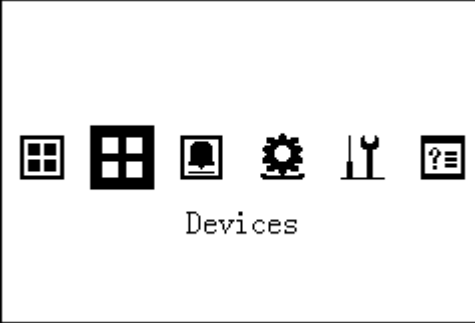
- The following table describes the procedure for clearing historical PID information. The parameter values in the following figures are for reference only.

LCD	Operation Procedure
 <p>2017-08-10 16:32:24</p> <p>↑ kWh</p> <p>04:00 08:00 12:00 16:00 20:00 h</p> <p>E-Daily: 24.04kWh</p> <p>Reduced CO2: 240.40kg</p> <p>Active power: 0.00W</p> <p>⚠:0 ⚠:0 ⚠:0</p>	<p>1. On the default screen, press ↵ to enter the main menu.</p>

LCD	Operation Procedure
	<p>2. Choose  and press .</p>
<pre> Devices->Select(4/4) Logger(Local):Online SUN2000(3-2):On-grid PLC(3-249):Online PID(3-1):Running </pre>	<p>3. Select a PID and press .</p> <p>NOTE PID (3-1) in the left figure indicates that the PID is connected to the Port 3 of the SmartLogger, and its RS485 communications address is 1.</p>
<pre> PID(3-2) Running Settings About </pre>	<p>4. Select Settings and press .</p>
<pre> Settings->Login User Name:Advanced User Password:000000 </pre>	<p>5. Set User name and Password.</p> <p>NOTE Because of the limited permission, select User name as Advanced User. The initial password for Advanced User is 000001.</p>

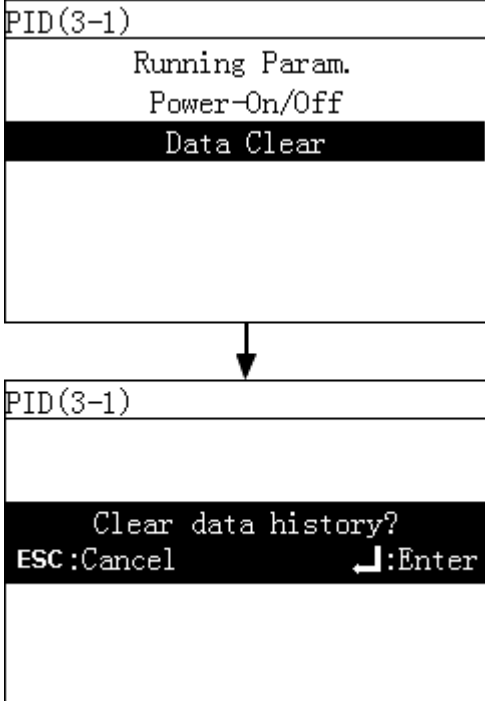
LCD	Operation Procedure
	<p>6. Choose Data Clear and press ↵.</p>

----End





6.2.18 Querying Custom Device Information

This topic describes how to query the running information and version of a custom device connected to the SmartLogger.

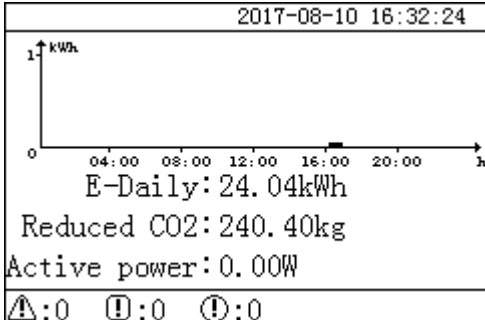
Procedure

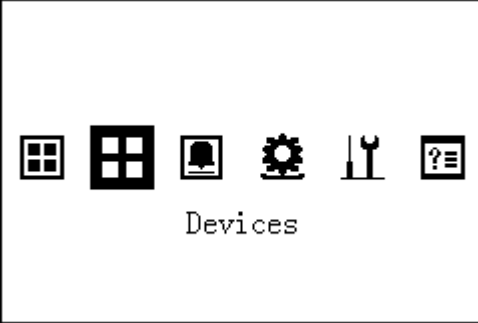
- The following table describes the procedure for viewing the information about a custom device. The parameter values in the figures are for reference only.

LCD	Operation Procedure
	<p>1. On the default screen, press ↵ to enter the main menu.</p>

LCD	Operation Procedure
	<p>2. Select  and press .</p>
<pre> Devices->Select(5/6) Logger(Local):Online SUN2000(3-2):On-grid PLC(3-249):Online PID(3-1):Running Custom Device1(2-1):Online EMI(1-1):Disconnection </pre> <p style="text-align: center;">↓</p> <pre> Custom Device1(2-1) Port number:2 Comm. Address:1 Logical addr.:10 </pre>	<p>3. Select a custom device and press .</p> <p>NOTE Custom Device1 (2-1) in the left figure indicates that the custom device is connected to the Port 2 of the SmartLogger, and its RS485 communications address is 1.</p>

----End

6.2.19 Querying Alarm Records







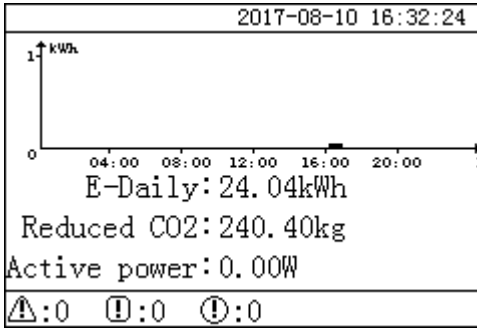

This topic describes how to query active and historical alarms for the SmartLogger and the connected inverters and how to set the alarm record sort mode on the monitoring panel.

Context

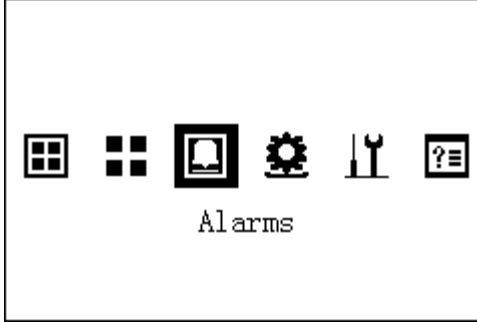
The LCD displays a maximum of 8000 latest alarm records.

Procedure

- The following table describes the procedure for querying active and historical alarms and setting the alarm record sort mode. The parameter values in the figures are for reference only.

LCD	Operation Procedure
	<p>1. On the default screen, press  to enter the main menu.</p>
	<p>2. Choose  and press .</p>
<p>Alarm</p> <ul style="list-style-type: none"> Active Alarms Alarm History Sort By 	<p>3. Press , choose the appropriate menu, and press .</p> <ul style="list-style-type: none"> • Perform step 4 and step 5 to view active alarms. • Perform step 6 and step 7 to view historical alarms. • Perform step 8 to set the alarm sort mode.
<p>Active Alarms->Select(1/1)</p> <p>SUN2000 (1-7) (7)</p>	<p>4. On the Active Alarms screen, select the target device name and press  to view all the active alarms for this device.</p>

LCD	Operation Procedure
<div style="border: 1px solid black; padding: 5px;"> <p>Active Alarms(1/1)</p> <p>ⓘVersion Mismatch/ID:1</p> </div> <p style="text-align: center;">↓</p> <div style="border: 1px solid black; padding: 5px;"> <p>Version Mismatch(1/1)</p> <p>Alarm ID:504</p> <p>Severity:Minor ⓘ</p> <p>Generated:2013-08-13 11:26:18</p> <p>Info:</p> <p>Reason ID = 1</p> </div>	<p>5. Select one of the alarm records by pressing ▲ or ▼, and view the alarm details by pressing ↵.</p> <p>NOTE</p> <ul style="list-style-type: none"> • For details about the alarm list of the SmartLogger1000, see 9.3 Alarms. • For details about the alarm list of the SUN2000, see the Troubleshooting in the SUN2000 series user manual.
<div style="border: 1px solid black; padding: 5px;"> <p>Alarm History->Select(1/1)</p> <p>SUN2000 (1-7) (7)</p> </div>	<p>6. On the Alarm History screen, select the target device name and press ↵ to view all the historical alarms for this device.</p>

LCD	Operation Procedure
<div style="border: 1px solid black; padding: 5px;"> <p>Alarm History(1/4)</p> <p>⚠Grid Volt. Abnormal/ID:29</p> <p>⚠Grid Volt. Abnormal/ID:29</p> <p>⚠Grid Volt. Abnormal/ID:29</p> <p>①Version Mismatch/ID:1</p> </div> <p style="text-align: center;">↓</p> <div style="border: 1px solid black; padding: 5px;"> <p>Grid Volt. Abnormal(1/4)</p> <p>Alarm ID:301</p> <p>Severity:Major ⚠</p> <p>Generated:2013-08-13 11:24:27</p> <p> Cleard:2013-08-13 11:26:45</p> <p> Info:</p> <p> Reason ID = 29</p> </div>	<p>7. Select one of the historical alarms by pressing ▲ or ▼ and view the alarm details by pressing ↵.</p> <p>NOTE</p> <ul style="list-style-type: none"> • For details about the alarm list of the SmartLogger1000, see 9.3 Alarms. • For details about the alarm list of the SUN2000, see the Troubleshooting in the SUN2000 series user manual.
<div style="border: 1px solid black; padding: 5px;"> <p>Alarm</p> <p>Active Alarms</p> <p>Alarm History</p> <p>Sort By</p> </div> <p style="text-align: center;">↓</p> <div style="border: 1px solid black; padding: 5px;"> <p>Alarm</p> <p>Sort By</p> <p>Generation time ✓</p> <p>Alarm severity</p> </div>	<p>8. On the Sort By page, you can select the way of sorting alarms.</p>









----End

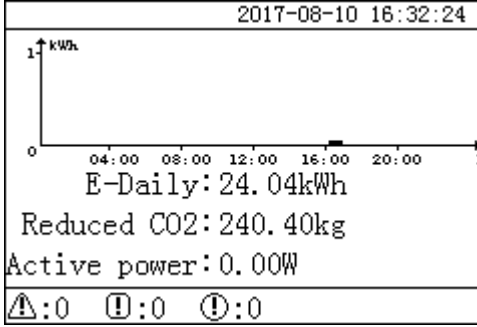

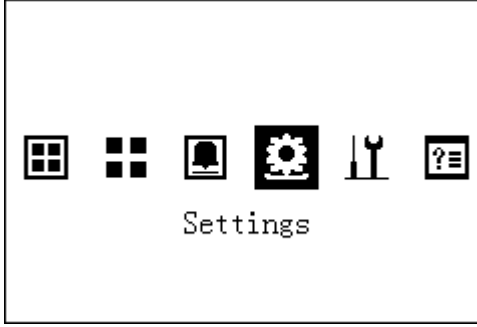

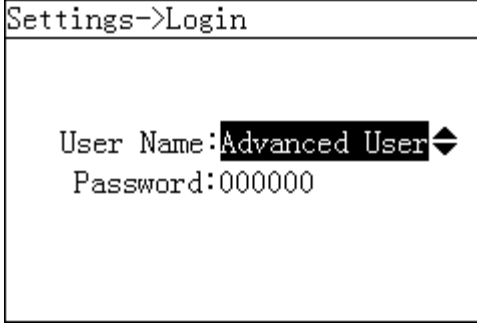

6.2.20 Setting the System Language

This topic describes how to set the display language for the SmartLogger on the monitoring panel.

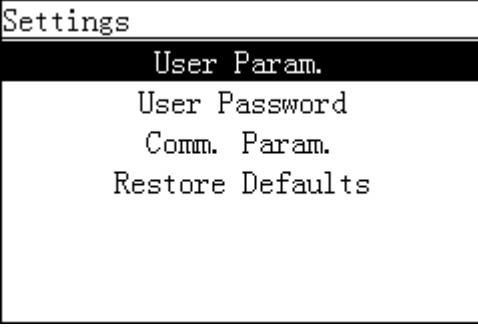
Procedure

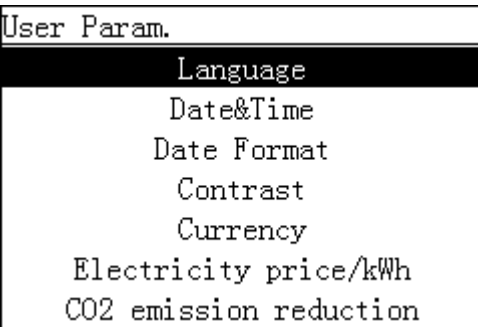
- The following table describes the procedure for setting the display language. The parameter values in the following figures are for reference only.

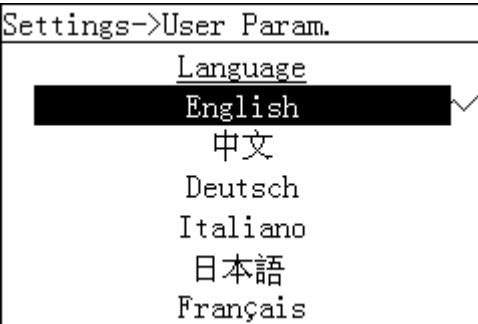
LCD	Operation Procedure
	<p>1. On the default screen, press  to enter the main menu.</p>
	<p>2. Choose  and press .</p>
	<p>3. Specify the User Name and Password by pressing  or , and then press .</p> <p>NOTE</p> <ul style="list-style-type: none"> Because of the limited permission, select the User Name as Common User or Advanced User. The initial password for Common User and Advanced User is <i>000001</i>. After passing the permission validation, the system keeps the authentication information for 30 seconds. If you exit from the Settings page and log in again within 30 seconds, no authentication is required.

LCD	Operation Procedure
 <p>Settings</p> <p>User Param.</p> <p>User Password</p> <p>Comm. Param.</p> <p>Restore Defaults</p> <p>Here use the pages displayed when you log in to the SmartLogger as Advanced User.</p>	<p>4. Choose User Param., and press .</p>
 <p>User Param.</p> <p>Language</p> <p>Date&Time</p> <p>Date Format</p> <p>Contrast</p> <p>Currency</p> <p>Electricity price/kWh</p> <p>CO2 emission reduction</p>	<p>5. Choose Language, and press .</p>
 <p>Settings->User Param.</p> <p>Language</p> <p>English</p> <p>中文</p> <p>Deutsch</p> <p>Italiano</p> <p>日本語</p> <p>Français</p>	<p>6. On the Language page, select a display language, and press .</p> <p>The pages will be displayed in the selected language.</p>









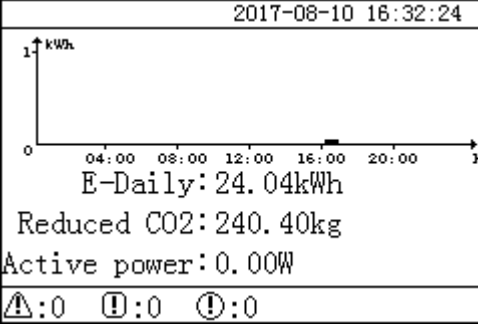

----End

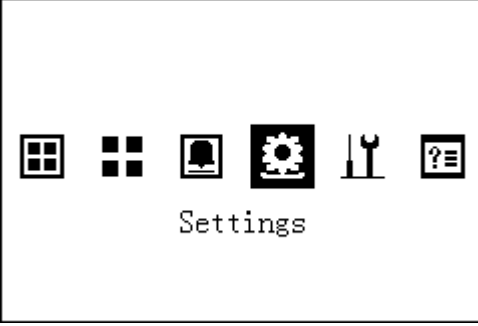

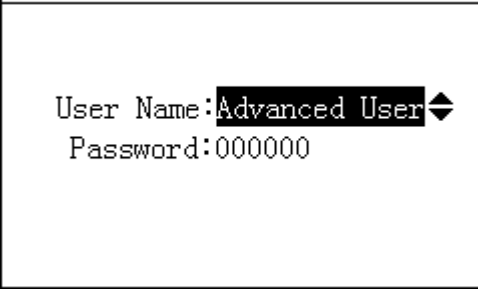
6.2.21 Setting System Time Parameters

This topic describes how to set the date, time and date format for the SmartLogger on the monitoring panel.

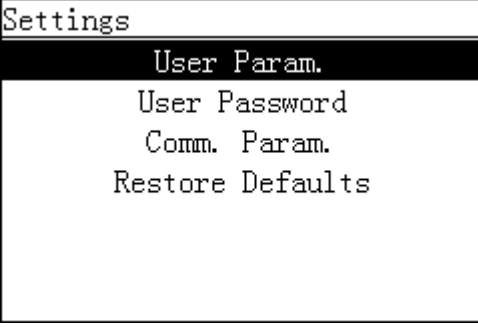
Procedure

- The following table describes the procedure for setting the time and date. The parameter values in the following figures are for reference only.

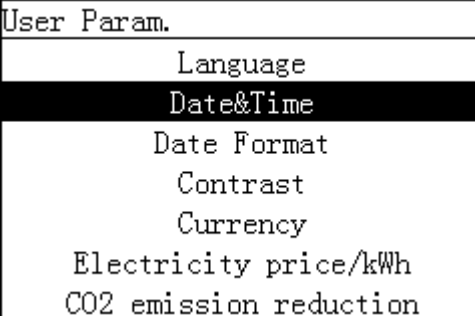
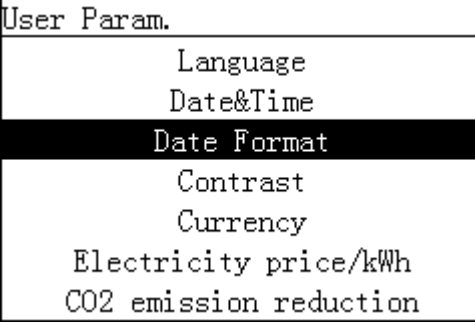
LCD	Operation Procedure
	<p>1. On the default screen, press  to enter the main menu.</p>
	<p>2. Choose  and press .</p>
<p>Settings->Login</p> 	<p>3. Specify the User Name and Password by pressing  or , and then press .</p> <p>NOTE</p> <ul style="list-style-type: none"> Because of the limited permission, select the User Name as Common User or Advanced User. The initial password for Common User and Advanced User is <i>000001</i>. After passing the permission validation, the system keeps the authentication information for 30 seconds. If you exit from the Settings page and log in again within 30 seconds, no authentication is required.
<p>Settings</p>  <p>Here use the pages displayed when you log in to the SmartLogger as Advanced User.</p>	<p>4. Choose User Param., and press .</p>

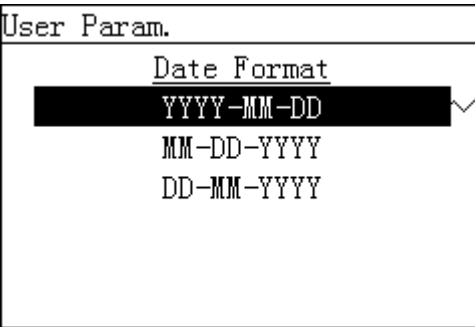
LCD	Operation Procedure
 <p>User Param. Language Date&Time Date Format Contrast Currency Electricity price/kWh CO2 emission reduction</p>	<p>5. Choose Date&Time or Date Format by pressing ▼, and press ↵.</p> <p>NOTICE</p> <ul style="list-style-type: none"> • Modifying Date&Time will affect the integrity of the SmartLogger's energy yield and performance data. Hence, do not change it at will. • After Date&Time is successfully set, this time can be synchronized in all the inverters connected to the SmartLogger.
 <p>User Param. Language Date&Time Date Format Contrast Currency Electricity price/kWh CO2 emission reduction</p>	<p>6. On the Date&Time page, set the date and time, set the time zone, enable or disable the daylight saving time, and press ↵.</p> <p>To select the specific parameter, click ↵. To set the parameter value, set ▲ or ▼.</p>
 <p>User Param. Date&Time TZ:UTC+08:00 Beijing DST:Disable Date:2017-08-10 Time:16:48:02</p>	<p>7. On the Date Format page, select a date format, and press ↵.</p>
 <p>User Param. Date Format YYYY-MM-DD MM-DD-YYYY DD-MM-YYYY</p>	

----End

6.2.22 Setting SmartLogger Contrast

You can set the SmartLogger contrast on the monitoring panel.





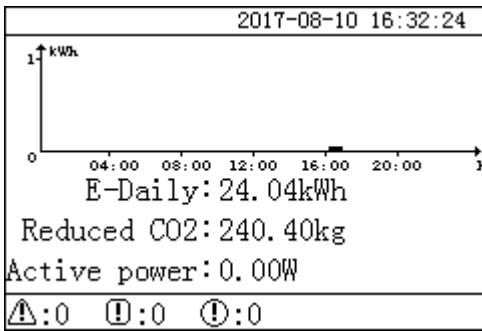
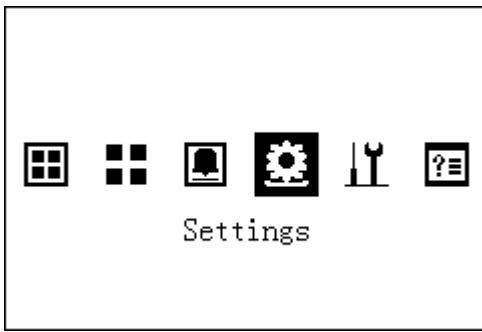
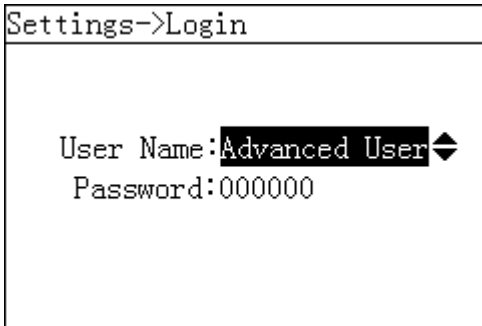

Context

In addition to the method provided in this section, you can also press and hold ▲ or ▼ on the home screen to adjust the contrast.

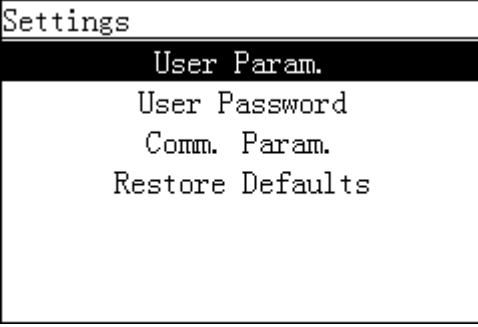
Procedure

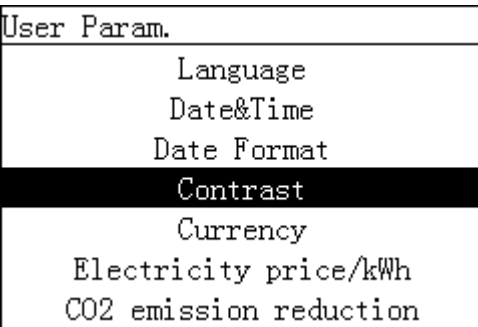
- To set the SmartLogger contrast, perform the steps in the following table: The parameter values in the figures are for reference only.

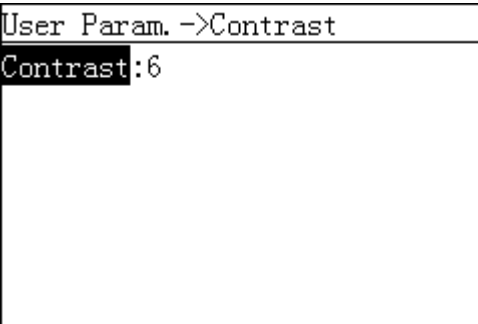
LCD	Procedure
	<p>1. On the default screen, press ↵ to enter the main menu.</p>
	<p>2. Choose ⚙️ and press ↵.</p>
	<p>3. Specify the User Name and Password by pressing ▲ or ▼, and then press ↵.</p> <p>NOTE</p> <ul style="list-style-type: none"> Because of the limited permission, select the User Name as Common User or Advanced User. The initial password for Common User and Advanced User is <i>000001</i>. After passing the permission validation, the system keeps the authentication information for 30 seconds. If you exit from the Settings page and log in again within 30 seconds, no authentication is required.

LCD	Procedure
 <p>Settings</p> <p>User Param.</p> <p>User Password</p> <p>Comm. Param.</p> <p>Restore Defaults</p> <p>Here use the pages displayed when you log in to the SmartLogger as Advanced User.</p>	<p>4. Choose User Param., and press .</p>
 <p>User Param.</p> <p>Language</p> <p>Date&Time</p> <p>Date Format</p> <p>Contrast</p> <p>Currency</p> <p>Electricity price/kWh</p> <p>CO2 emission reduction</p>	<p>5. Select Contrast and press .</p>
 <p>User Param. -> Contrast</p> <p>Contrast:6</p>	<p>6. On the Contrast tab, press  and  to set the contrast.</p> <p>NOTE</p> <p>The contrast value ranges from zero to ten.</p>









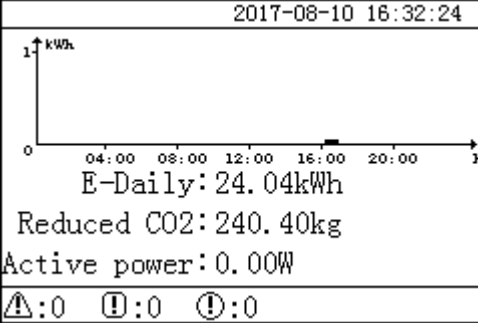

----End

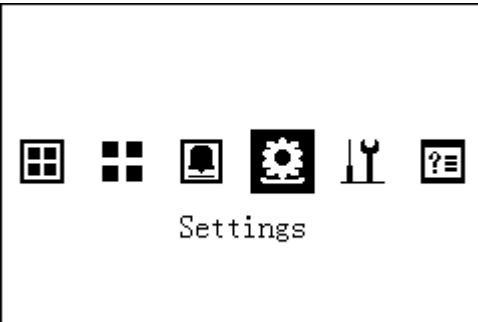
6.2.23 Setting the Currency and Currency Factor

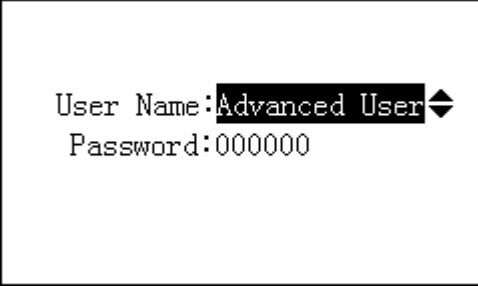
This topic describes how to set the currency and currency factor for the SmartLogger.

Procedure

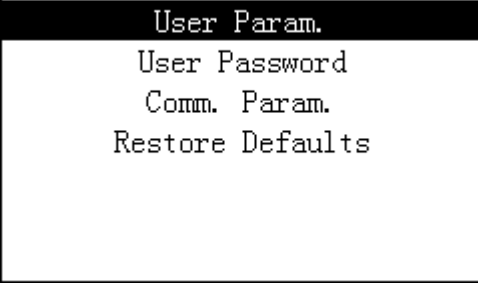
- The following table describes the procedure for setting the currency and currency factor. The parameter values in the following figures are for reference only.

LCD	Operation Procedure
	<p>1. On the default screen, press  to enter the main menu.</p>
	<p>2. Choose  and press .</p>
<p>Settings->Login</p> 	<p>3. Specify the User Name and Password by pressing  or , and then press .</p> <p>NOTE</p> <ul style="list-style-type: none"> Because of the limited permission, select the User Name as Common User or Advanced User. The initial password for Common User and Advanced User is <i>000001</i>. After passing the permission validation, the system keeps the authentication information for 30 seconds. If you exit from the Settings page and log in again within 30 seconds, no authentication is required.
<p>Settings</p>  <p>Here use the pages displayed when you log in to the SmartLogger as Advanced User.</p>	<p>4. Choose User Param., and press .</p> <ul style="list-style-type: none"> Perform step 5 to set the currency. Perform step 6 to set the currency factor.







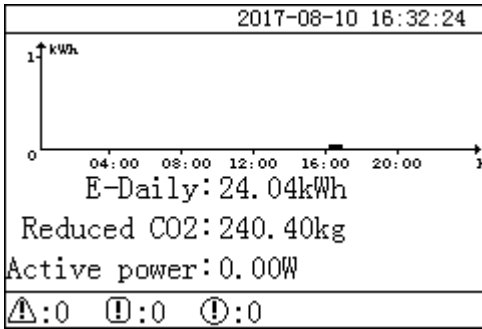

LCD	Operation Procedure
<p>User Param.</p> <p>Language Date&Time Date Format Contrast Currency Electricity price/kWh CO2 emission reduction</p> <p style="text-align: center;">↓</p> <p>User Param.</p> <p>Currency</p> <p>EUR ✓ GBP USD CNY JPY</p>	<p>5. Set the currency.</p> <p>a. Select Currency by pressing ▼, and press ↵.</p> <p>b. Select a currency, and press ↵.</p>
<p>User Param.</p> <p>Language Date&Time Date Format Contrast Currency Electricity price/kWh CO2 emission reduction</p> <p style="text-align: center;">↓</p> <p>User Param.</p> <p><u>Electricity price/kWh</u></p> <p>0 1 0. 0 0 0</p>	<p>6. Set the currency factor.</p> <p>NOTICE Set the currency before you set the currency factor. The currency factor is the electricity price per kWh, which is used to calculate the energy yield revenue.</p> <p>a. Select Electricity price/kWh by pressing ▼, and then press ↵.</p> <p>b. Set the currency factor by pressing ▲ or ▼, and then press ↵.</p>

----End

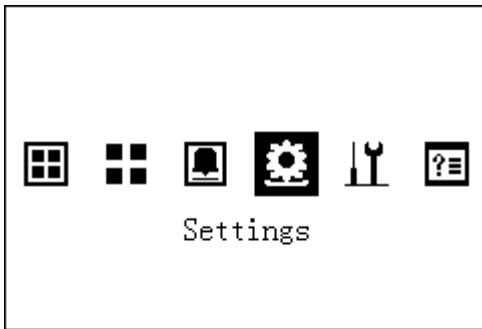
6.2.24 Setting the CO₂ Emission Reduction Coefficient

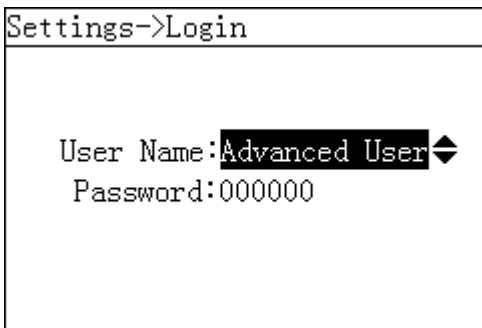
Procedure

- The following table describes the procedure for setting the CO₂ emission reduction coefficient. The data on the following figures are for reference only.

LCD Display	Procedure
	<p>1. On the default screen, press  to enter the main menu.</p>
	<p>2. Choose  and press .</p>
	<p>3. Specify the User Name and Password by pressing  or , and then press .</p> <p>NOTE</p> <ul style="list-style-type: none"> Because of the limited permission, select the User Name as Common User or Advanced User. The initial password for Common User and Advanced User is <i>000001</i>. After passing the permission validation, the system keeps the authentication information for 30 seconds. If you exit from the Settings page and log in again within 30 seconds, no authentication is required.

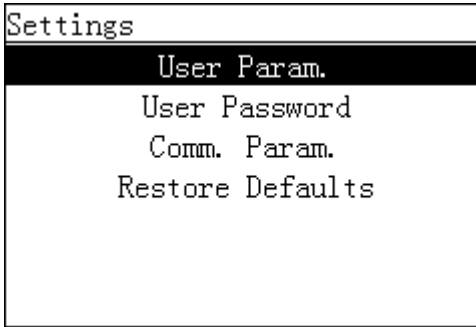
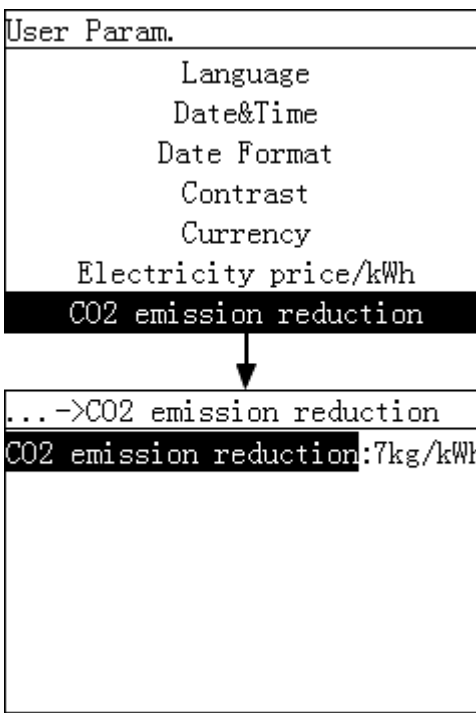
LCD Display	Procedure
 <p>Settings</p> <p>User Param.</p> <p>User Password</p> <p>Comm. Param.</p> <p>Restore Defaults</p> <p>Here use the pages displayed when you log in to the SmartLogger as Advanced User.</p>	<p>4. Choose User Param., and press ↵.</p>
 <p>User Param.</p> <p>Language</p> <p>Date&Time</p> <p>Date Format</p> <p>Contrast</p> <p>Currency</p> <p>Electricity price/kWh</p> <p>CO2 emission reduction</p> <p>↓</p> <p>...->CO2 emission reduction</p> <p>CO2 emission reduction:7kg/kWh</p>	<p>5. Select CO2 emission reduction and press ↵.</p>

----End

6.2.25 Changing a Password

This topic describes how to change a password on the monitoring panel.

Context









- The initial password is 000001 for **Common User**, **Advanced User**, and **Special User**.
- After the first login, it is recommended that you change the initial password immediately to ensure account security.
- You are advised to change the password at least once every half year to prevent unauthorized use of your account, which affects system security.

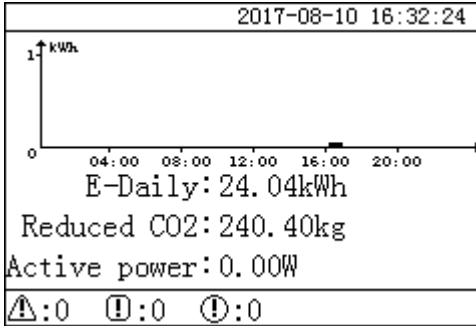

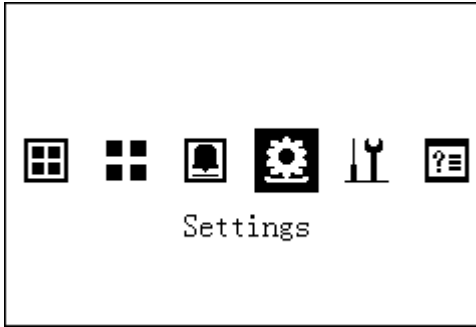
Change the password in compliance with the following principles:

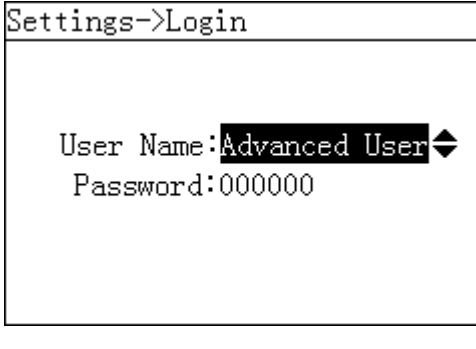
- Six characters are required.
- The password consists of digits, uppercase letters, and lowercase letters.

Procedure

- The following table describes the procedure for changing a password. The parameter values in the following figures are for reference only.

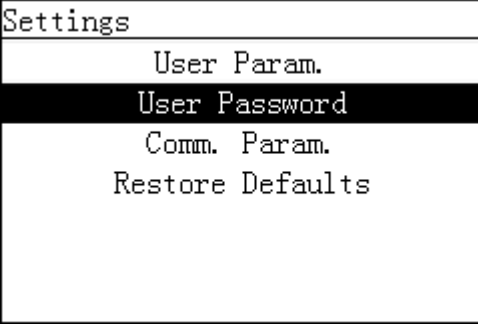
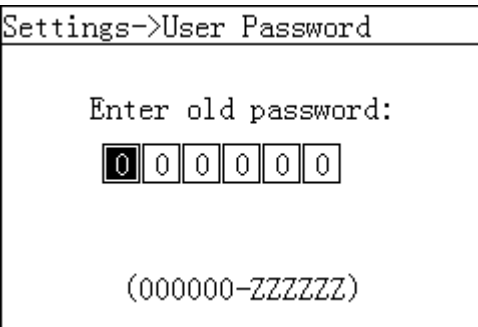
LCD	Procedure
	<p>1. On the default screen, press  to enter the main menu.</p>
	<p>2. Choose  and press .</p>
	<p>3. Set User Name and Password by pressing  or , and press .</p> <p>NOTE</p> <ul style="list-style-type: none"> • User Name can be set to any of the following values: Common User, Advanced User, and Special User. The initial password is 000001. • After the authentication is successful, the system keeps the authentication information for 30 seconds. If you exit from the Settings screen and log in again within 30 seconds, no authentication is required.

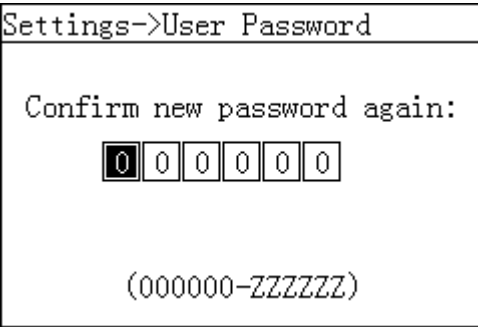
LCD	Procedure
 <p>Settings</p> <p>User Param.</p> <p>User Password</p> <p>Comm. Param.</p> <p>Restore Defaults</p> <p>Here use the pages displayed when you log in to the SmartLogger as Advanced User.</p>	<p>4. Select User Password by pressing ▼, and press ↵.</p>
 <p>Settings->User Password</p> <p>Enter old password:</p> <p>0 0 0 0 0 0</p> <p>(000000-ZZZZZZ)</p>	<p>5. Enter the old password and press ↵. Increase or decrease the value by pressing ▲ or ▼. Switch between data bits by pressing ↵.</p>
 <p>Settings->User Password</p> <p>Enter new password:</p> <p>0 0 0 0 0 0</p> <p>(000000-ZZZZZZ)</p>	<p>6. Enter a new password and press ↵. Increase or decrease the value by pressing ▲ or ▼. Switch between data bits by pressing ↵.</p>
 <p>Settings->User Password</p> <p>Confirm new password again:</p> <p>0 0 0 0 0 0</p> <p>(000000-ZZZZZZ)</p>	<p>7. Enter the new password again and press ↵.</p> <p>NOTE</p> <p>Ensure that you enter the new password twice coherently. Otherwise, an error message is displayed.</p> <p>After the password is changed successfully, the LCD displays operation success information.</p>

 **NOTE**

If you want to change the password for another account, exit from the **Settings** screen (without logging in to the **Maintenance** screen), wait 30 seconds, log in by using the account for which you want to change the password, and perform step 3 to step 7 in the preceding table.

----End

6.2.26 Setting Communications Parameters





You can set the SmartLogger parameters for communication on the monitoring panel.

Context

- Correctly set RS485 parameters to ensure normal communication between the SmartLogger and the inverters and between the SmartLogger and the environmental monitoring instrument.
- Correctly set Ethernet parameters to ensure proper operation of Ethernet ports and functions of logging in to the embedded WebUI, connecting to the element management system, and sending emails.
- Correctly set NetEco parameters to ensure normal communication between the SmartLogger and the NetEco.

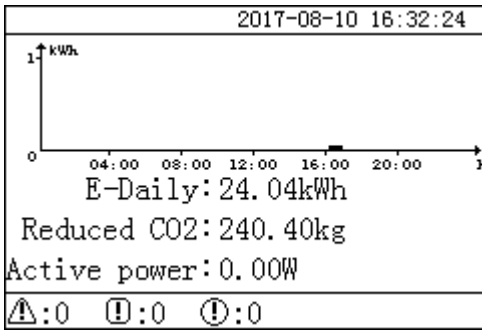

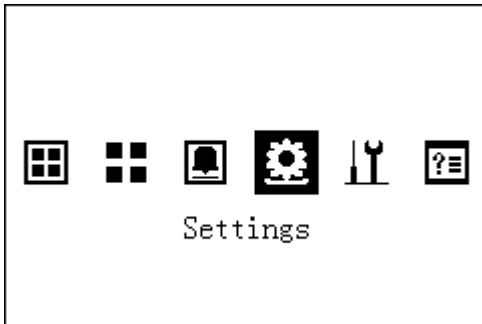
Procedure



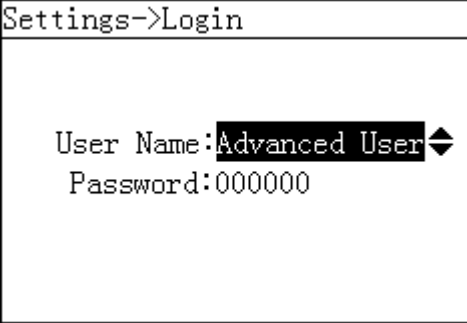
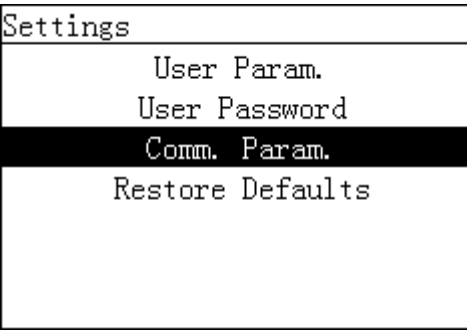
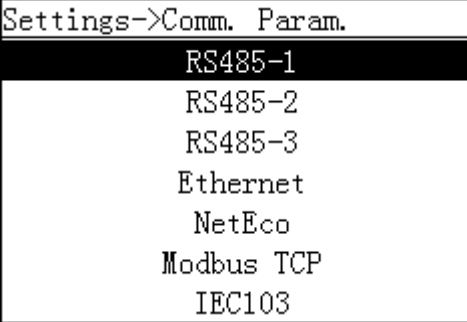
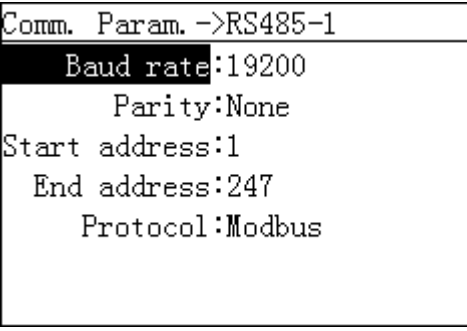

- The following table describes the procedure for setting communications parameters. The parameter values in the following figures are for reference only.



LCD	Operation Procedure
	<p>1. On the default screen, press  to enter the main menu.</p>
	<p>2. Choose  and press .</p>

LCD	Operation Procedure
	<p>3. Set User Name and Password by pressing ▲ or ▼, and press ↵.</p> <p>NOTE</p> <ul style="list-style-type: none"> Set User Name to Advanced User. The initial password for Advanced User is 000001. After passing the permission validation, the system keeps the authentication information for 30 seconds. If you exit from the Settings screen and log in again within 30 seconds, no authentication is required.
 <p>Here use the pages displayed when you log in to the SmartLogger as Advanced User.</p>	<p>4. Select Comm. Param. and press ↵.</p> <ul style="list-style-type: none"> Perform step 5 and step 6 to set the parameters for the RS485. Perform step 7 and step 8 to set the parameters for the Ethernet. Perform step 9 and step 10 to set the parameters for the NetEco. Perform step 11 and step 12 to set the parameters for the Modbus TCP. Perform step 13 and step 14 to set the parameters for the IEC103. Perform step 15 to set the SmartLogger address.
	<p>5. Select an RS485 port by pressing ▲ or ▼ and then press ↵.</p> <p>There are three RS485 ports: RS485-1, RS485-2, and RS485-3. The corresponding port for RS485-1 is COM1; RS485-2 is COM2; RS485-3 is COM3.</p>
	<p>6. Set RS485 parameters and then press ↵.</p> <ul style="list-style-type: none"> The following baud rates are supported: 2400 bps, 4800 bps, 9600 bps, 19200 bps and 115200 bps. 9600 bps is recommended. $1 \leq \text{Start Address} \leq \text{End Address} \leq 247$. The address segments for these three ports can overlap. <p>Set the address scope properly. The broader the scope is, the longer the time is for searching the devices.</p> <ul style="list-style-type: none"> Parity must be set to the same value for all devices connected to the same RS485 port.

LCD	Operation Procedure
<pre>Settings->Comm. Param. RS485-1 RS485-2 RS485-3 Ethernet NetEco Modbus TCP IEC103</pre>	<p>7. Press ▼, select Ethernet, and press ↵.</p>
<pre>Comm. Param. ->Ethernet Auto obtain IP:Disable IP address:192.168. 0. 10 Subnet mask:255.255.255. 0 Gateway:192.168. 0. 1 DNS-1:192.168. 0. 1 DNS-2: 0. 0. 0. 0 Submit</pre>	<p>8. Set Ethernet parameters and then press ↵.</p> <p>NOTE</p> <p>If the SmartLogger connects to the Internet through a router, note the following when setting Ethernet parameters:</p> <ul style="list-style-type: none"> • If you set Auto obtain IP to Enable, the DHCP server on the network assigns IP addresses. In this case, you must ensure that a DHCP server is working on the network. • Set the gateway address to the IP address of the router. • Ensure that the IP address of the SmartLogger is in the same network segment as the gateway address. • Set the domain name server (DNS) address to the IP address of the router or obtain the DNS address from the network provider.
<pre>Settings->Comm. Param. RS485-1 RS485-2 RS485-3 Ethernet NetEco Modbus TCP IEC103</pre>	<p>9. Press ▼, select NetEco, and press ↵.</p>

LCD	Operation Procedure
<pre>Comm. Param. ->NetEco NetEco server:192.168. 8.101 Port number:16100 Address mode:Logical address SSL encrypt. :Enable 2nd challenge:Enable Network Test</pre>	<p>10. Set NetEco parameters and then press .</p> <ul style="list-style-type: none"> • Set NetEco server to the IP address or domain name of the NetEco server. • When the SmartLogger connects to the Huawei NMS, retain the default value 16100 for Port number. When the SmartLogger connects to the third-party NMS, set Port number according to the server port enabled in a third-party NMS. • In most cases, set Address mode to Comm. Address. If the devices connected to the three RS485 ports of the SmartLogger have duplicate addresses, you must set Address mode to Logical address. • If SSL encrypt. is set to Disable, data will be transmitted without being encrypted, which may result in user data theft. Therefore, exercise caution when deciding to set SSL encrypt. to Disable. • If 2nd challenge is set to Disable, the second challenge authentication result will not be verified, which may result in user data theft. Therefore, exercise caution when deciding to set 2nd challenge to Disable.
<pre>Settings->Comm. Param. RS485-1 RS485-2 RS485-3 Ethernet NetEco Modbus TCP IEC103</pre>	<p>11. Press , select Modbus TCP, and press .</p>

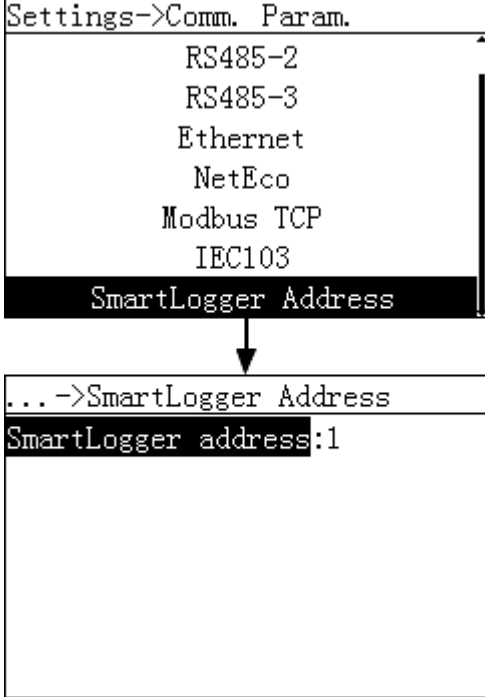
LCD	Operation Procedure
<pre>Comm. Param. ->Modbus TCP Link setting:Disable Client 1 IP: 0. 0. 0. 0 Client 2 IP: 0. 0. 0. 0 Client 3 IP: 0. 0. 0. 0 Client 4 IP: 0. 0. 0. 0 Client 5 IP: 0. 0. 0. 0 Address mode:Logical address</pre>	<p>12. Set Modbus TCP parameters and then press .</p> <ul style="list-style-type: none"> • Modbus-TCP is a general standard protocol without a security authentication mechanism. Therefore, the function of connecting to a third-party NMS using Modbus-TCP is disabled by default to reduce network security risks. Parameters must be set correctly to enable the function. • In most cases, set Address mode to Comm. Address. If the devices connected to the three RS485 ports of the SmartLogger have duplicate addresses, you must set Address mode to Logical addr. • Set the client IP addresses correctly.
<pre>Settings->Comm. Param. RS485-1 RS485-2 RS485-3 Ethernet NetEco Modbus TCP IEC103</pre>	<p>13. Press , choose IEC103, and press .</p>
<pre>Comm. Param. ->IEC103 Port number:No Address:126 IEC103 IP: 0. 0. 0. 0</pre>	<p>14. Set IEC103 parameters and then press .</p> <p>NOTE IEC103 is a general standard protocol without a security authentication mechanism. Therefore, the function of connecting to the NMS using IEC103 is disabled by default to reduce network security risks. Parameters must be set correctly to enable the function.</p>

LCD	Operation Procedure
	<p>15. Select SmartLogger Address and then press .</p>

----End

6.2.27 Restoring Factory Settings

This topic describes how to restore factory settings for the SmartLogger on the monitoring panel. After this operation, all parameters, excluding the current date and time, will restore to the default factory settings. However, the running information, alarm records, and system logs do not change.

Context











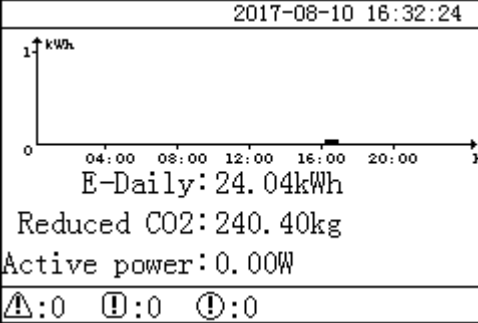

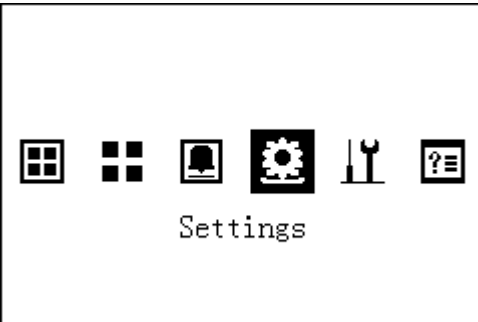

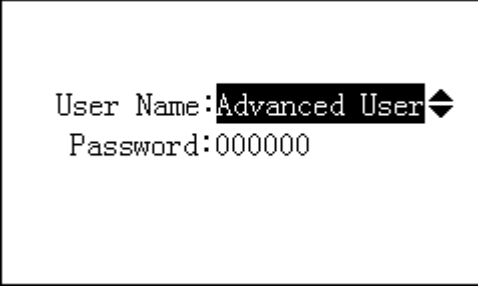

NOTICE

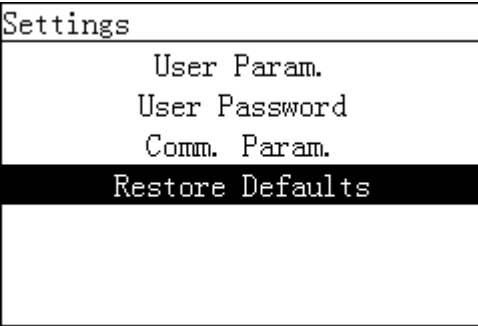
- After restoring factory defaults for the SmartLogger, set the user parameters and communications parameters in time and log in to the WebUI to set the environmental monitoring instrument parameters and power grid dispatching parameters.
- The displayed language is **English** by default.

Procedure

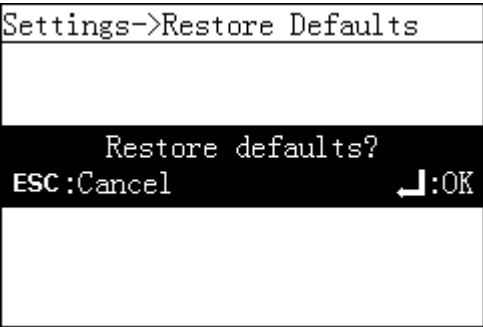
- The following table describes the procedure for restoring factory settings. The parameter values in the following figures are for reference only.

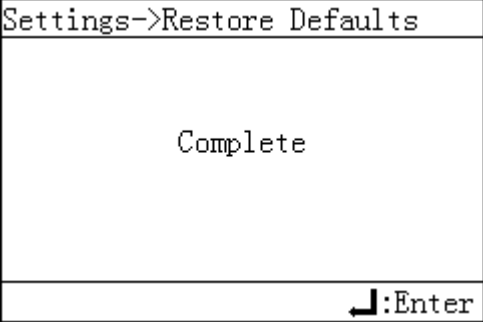
LCD	Operation Procedure
	<p>1. On the default screen, press  to enter the main menu.</p>
	<p>2. Choose  and press .</p>
<p>Settings->Login</p> 	<p>3. Enter the User Name and Password by pressing  or , and then press .</p> <p>NOTE</p> <ul style="list-style-type: none"> Because of the limited permission, select the User Name as Advanced User or Special User. The initial password for Advanced User and Special User is <i>000001</i>. After passing the permission validation, the system keeps the authentication information for 30 seconds. If you exit the screen and log in again within the 30 seconds, no permission authentication is required.
<p>Settings</p>  <p>Here use the pages displayed when you log in to the SmartLogger as Advanced User.</p>	<p>4. Choose Restore Defaults, and press .</p>

LCD	Operation Procedure
	5. On the displayed page, press  .
	6. Press  to complete the settings.

----End

6.2.28 Downloading Device Data Using a USB Flash Drive



You can download device logs using a USB flash drive over the monitoring panel, so that you can use the logs for issue review and troubleshooting.







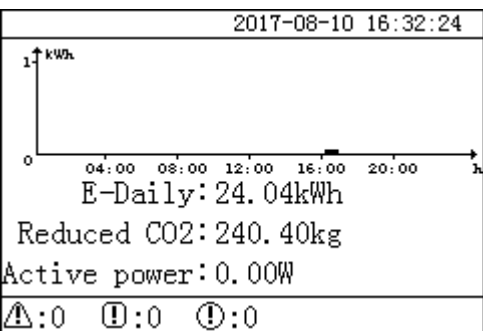

Context

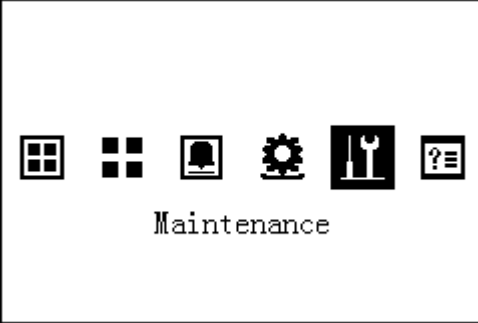
[Side View of the shell](#) shows the USB port in the SmartLogger.

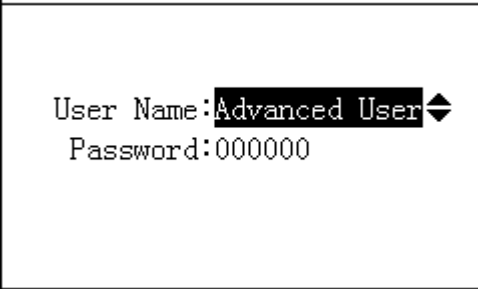
Procedure

- The following table describes the procedure for downloading data using a USB flash drive. The parameter values in the following figures are for reference only.

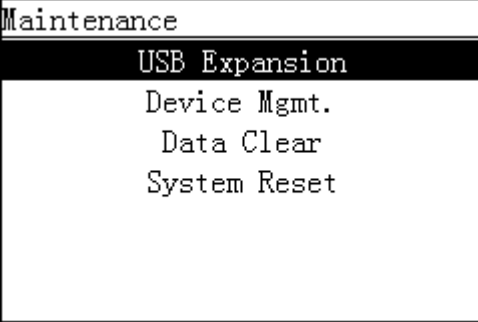
LCD	Operation Procedure
	1. On the default screen, press  to enter the main menu.

LCD	Operation Procedure
 <p>Maintenance</p>	<p>2. Choose  and press .</p>
<p>Maintenance->Login</p>  <p>User Name: Advanced User  Password: 000000</p>	<p>3. Enter the User Name and Password by pressing  or , and then press .</p> <p>NOTE</p> <ul style="list-style-type: none"> • Because of the limited permission, select the User Name as Advanced User or Special User. The initial password for Advanced User and Special User is <i>000001</i>. • After passing the permission validation, the system keeps the authentication information for 30 seconds. If you exit the screen and log in again within the 30 seconds, no permission authentication is required.
<p>Maintenance</p>  <p>USB Expansion Device Mgmt. Data Clear System Reset</p> <p>Here use the pages displayed when you log in to the SmartLogger as Advanced User.</p>	<p>4. Choose USB Expansion and press .</p> <p>NOTE</p> <ul style="list-style-type: none"> • Before this operation, connect the USB flash drive to the USB port. • If no USB flash drive is detected, the LCD displays a message prompting No USB device detected. <p>The system takes 5 to 10 seconds to detect the USB flash drive. Then perform the following steps.</p>

LCD	Operation Procedure
<div style="border: 1px solid black; padding: 5px; margin-bottom: 10px;"> Maintenance->USB Expansion <div style="background-color: black; color: white; text-align: center; padding: 2px;">Device Logs</div> Firmware Upgrade Batch Upgrade Export all data files Import all data files </div> <div style="text-align: center; margin: 5px 0;">↓</div> <div style="border: 1px solid black; padding: 5px;"> Device Logs->Select(1/2) Logger(Local) <div style="background-color: black; color: white; text-align: center; padding: 2px;">SUN2000 (1-7)</div> </div>	5. Choose Device Logs and press  .

----End

6.2.29 Upgrading Firmware by Using a USB Flash Drive

You can upgrade the firmware on the monitoring panel by using a USB flash drive. You can upgrade the firmware of the SmartLogger and devices connected to the SmartLogger.

Context







NOTICE

- You have obtained the upgrade package with the help of the supplier or Huawei engineers.
- Save the package under the root directory and do not extract the package.
- When upgrading the firmware for the SUN2000, change the file name of the package to **sun2000_usb.zip**.
- When upgrading the firmware for the PID, change the file name of the package to **pid_usb.zip**.
- When upgrading the firmware for the PLC, change the file name of the package to **plc_usb.zip**.
- When upgrading the SmartLogger1000, ensure that the file name of the package is **logger_usb.tar.gz**.

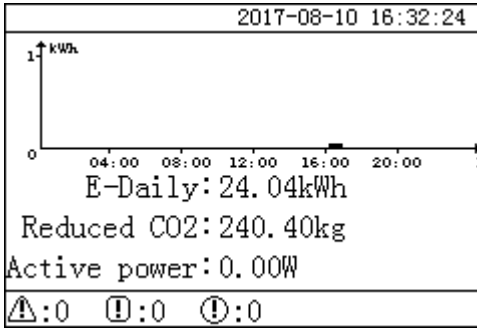
Procedure

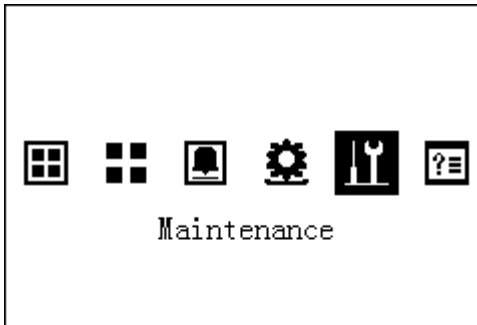
- The following table describes the procedure for upgrading the firmware by using a USB flash drive. The parameter values in the figures are for reference only.

LCD	Operation Procedure
	<p>1. On the default screen, press  to enter the main menu.</p>
	<p>2. Choose  and press .</p>

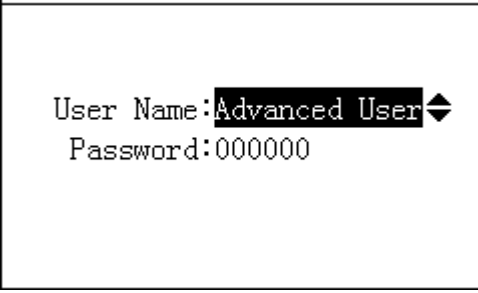
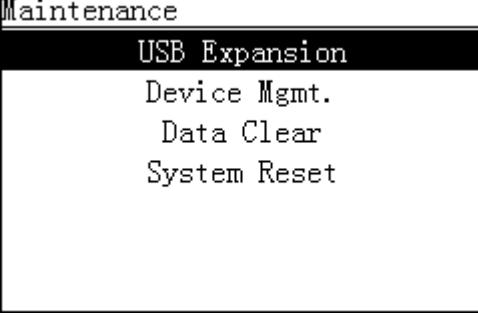
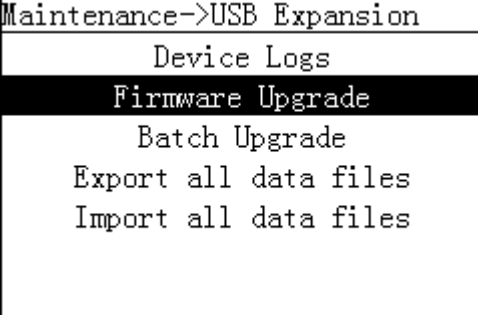
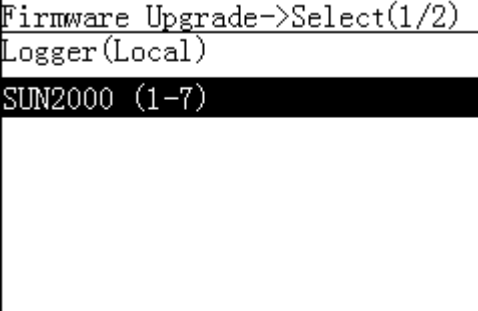
LCD	Operation Procedure
<p>Maintenance->Login</p>  <p>User Name: Advanced User Password: 000000</p>	<p>3. Enter the User Name and Password by pressing ▲ or ▼, and then press ↵.</p> <p>NOTE</p> <ul style="list-style-type: none"> Because of the limited permission, select the User Name as Advanced User or Special User. The initial password for Advanced User and Special User is <i>000001</i>. After passing the permission validation, the system keeps the authentication information for 30 seconds. If you exit the screen and log in again within the 30 seconds, no permission authentication is required.
<p>Maintenance</p>  <p>USB Expansion Device Mgmt. Data Clear System Reset</p> <p>Here use the pages displayed when you log in to the SmartLogger as Advanced User.</p>	<p>4. Choose USB Expansion and press ↵.</p> <p>NOTE</p> <ul style="list-style-type: none"> Before this operation, connect the USB flash drive to the USB port. If no USB flash drive is detected, the LCD displays a message prompting No USB device detected. <p>The system takes 5 to 10 seconds to detect the USB flash drive. Then perform the following steps.</p>
<p>Maintenance->USB Expansion</p>  <p>Device Logs Firmware Upgrade Batch Upgrade Export all data files Import all data files</p>	<p>5. Choose Firmware Upgrade, and press ↵.</p>
<p>Firmware Upgrade->Select(1/2) Logger(Local)</p>  <p>SUN2000 (1-7)</p>	<p>6. Press ↵ to select a specific device.</p> <p>The SmartLogger and the inverters connected to it can be upgraded.</p> <p>The SUN2000 (1-7) on the left indicates that this inverter connects to the Port 1 of the SmartLogger and the communications address for the RS485 port is 7.</p>

LCD	Operation Procedure
<div style="border: 1px solid black; padding: 5px;"> <p>Maintenance->USB Expansion</p> <hr/> <p>Curr. Ver. :V100R001C00SPC002 Target Ver. :V100R001C00SPC003</p> <hr/> <p>ESC :Cancel ↵:Enter</p> </div> <p>(The inverter upgrade screen is used as an example.)</p>	<p>7. After checking that Target Version is correct, press ↵.</p> <p>NOTICE</p> <p>For the SUN2000, its firmware can be upgraded only if the device status is On-grid or Shutdown. Check the device status before firmware upgrade.</p> <p>The SmartLogger, inverter, PLC, or PID will restart after being upgraded.</p>

----End

6.2.30 Batch Upgrade

This topic describes how to perform a batch upgrade for the SUN2000 on the monitoring panel.

Context











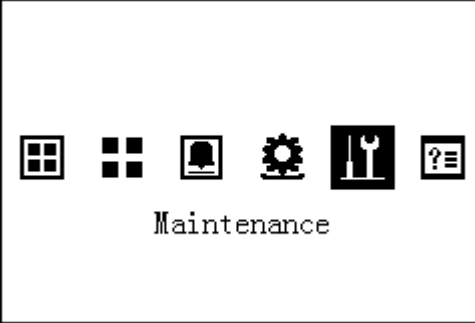

NOTICE

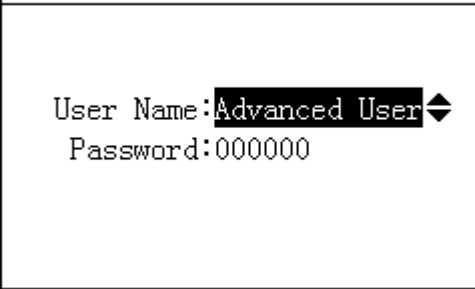

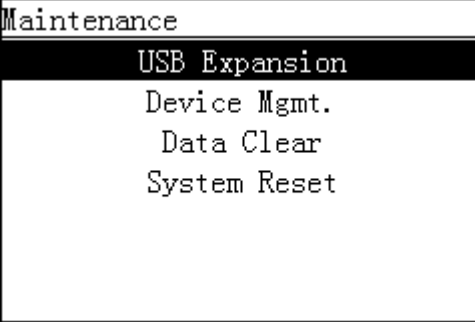

The SUN2000 that can be upgraded in batches on the SmartLogger must be SUN2000 V100R001C11SPC409, SUN2000 V100R001C81SPC101 and its later patch versions, or SUN2000 V200R001C00 and its later patch versions.

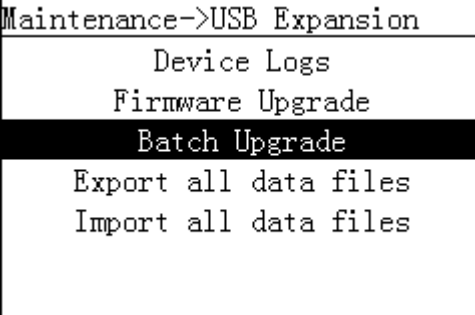
Procedure

- The following table describes the batch upgrade procedure. The parameter values in the figures are for reference only.

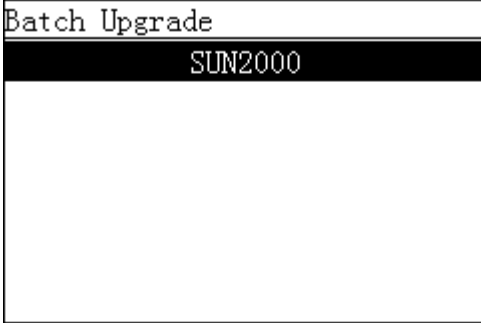
LCD	Procedure
<div style="border: 1px solid black; padding: 5px;"> <p style="text-align: right;">2017-08-10 16:32:24</p> </div>	<p>1. On the default screen, press ↵ to enter the main menu.</p>

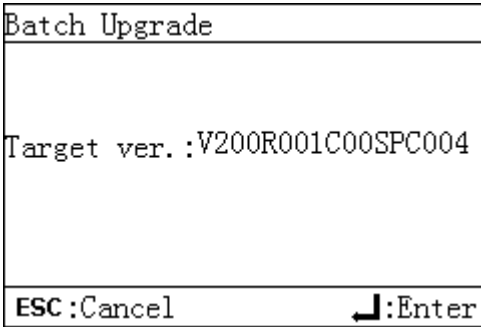
LCD	Procedure
 <p>Maintenance</p>	<p>2. Choose  and press .</p>
<p>Maintenance->Login</p>  <p>User Name: Advanced User </p> <p>Password: 000000</p>	<p>3. Enter the User Name and Password by pressing  or , and then press .</p> <p>NOTE</p> <ul style="list-style-type: none"> Because of the limited permission, select the User Name as Advanced User or Special User. The initial password for Advanced User and Special User is <i>000001</i>. After passing the permission validation, the system keeps the authentication information for 30 seconds. If you exit the screen and log in again within the 30 seconds, no permission authentication is required.
<p>Maintenance</p>  <p>USB Expansion</p> <p>Device Mgmt.</p> <p>Data Clear</p> <p>System Reset</p> <p>Here use the pages displayed when you log in to the SmartLogger as Advanced User.</p>	<p>4. Choose USB Expansion and press .</p> <p>NOTE</p> <ul style="list-style-type: none"> Before this operation, connect the USB flash drive to the USB port. If no USB flash drive is detected, the LCD displays a message prompting No USB device detected. <p>The system takes 5 to 10 seconds to detect the USB flash drive. Then perform the following steps.</p>
<p>Maintenance->USB Expansion</p>  <p>Device Logs</p> <p>Firmware Upgrade</p> <p>Batch Upgrade</p> <p>Export all data files</p> <p>Import all data files</p>	<p>5. Choose Batch Upgrade and press .</p>

LCD	Procedure
 <p>The screenshot shows a terminal window with the text 'Batch Upgrade' at the top. Below it, 'SUN2000' is highlighted with a black background. The rest of the screen is empty.</p>	<p>6. Choose SUN2000 and press .</p>
 <p>The screenshot shows a terminal window with 'Batch Upgrade' at the top. Below it, 'Target ver. :V200R001C00SPC004' is displayed. At the bottom, there are two lines: 'ESC :Cancel' and ':Enter'.</p>	<p>7. After checking that Target ver. is correct, press .</p> <p>NOTICE</p> <ul style="list-style-type: none"> • For the SUN2000, its firmware can be upgraded only if the device status is On-grid or Shutdown. Check the device status before firmware upgrade. • The upgrade takes 20 minutes when the baud rate is 9600 bps. • After the upgrade is successful, the SUN2000 automatically restarts.

----End

6.2.31 Exporting All Files









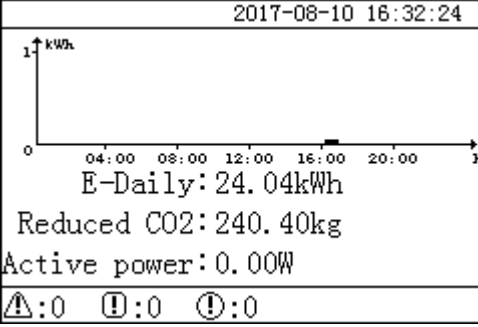

You can export all files from the SmartLogger on the monitoring panel.

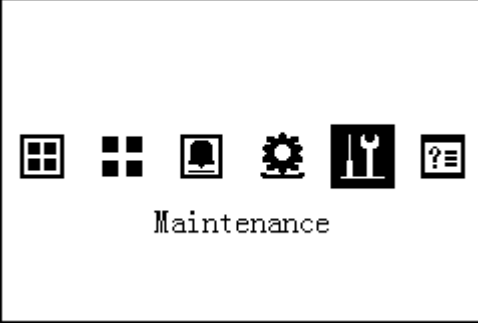

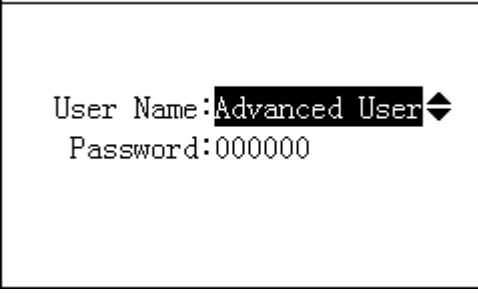
Context

If the SmartLogger needs to be replaced, you can export all files before the replacement and then import the exported files to the new SmartLogger to ensure data integrity.

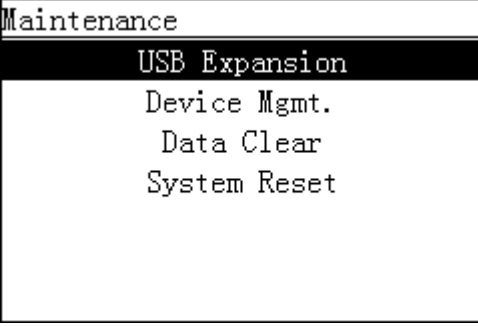
Procedure

- The following table describes the procedure for exporting all files. The parameter values in the figures are for reference only.

LCD	Procedure
	<p>1. On the default screen, press  to enter the main menu.</p>
	<p>2. Choose  and press .</p>
<p>Maintenance->Login</p> 	<p>3. Enter the User Name and Password by pressing  or , and then press .</p> <p>NOTE</p> <ul style="list-style-type: none"> Because of the limited permission, select the User Name as Advanced User or Special User. The initial password for Advanced User and Special User is <i>000001</i>. After passing the permission validation, the system keeps the authentication information for 30 seconds. If you exit the screen and log in again within the 30 seconds, no permission authentication is required.
<p>Maintenance</p>  <p>Here use the pages displayed when you log in to the SmartLogger as Advanced User.</p>	<p>4. Choose USB Expansion and press .</p> <p>NOTE</p> <ul style="list-style-type: none"> Before this operation, connect the USB flash drive to the USB port. If no USB flash drive is detected, the LCD displays a message prompting No USB device detected. <p>The system takes 5 to 10 seconds to detect the USB flash drive. Then perform the following steps.</p>

LCD	Procedure
 <p>Maintenance->USB Expansion</p> <p>Device Logs</p> <p>Firmware Upgrade</p> <p>Batch Upgrade</p> <p>Export all data files</p> <p>Import all data files</p>	<p>5. Select Export all data files and press .</p>

----End

6.2.32 Importing All Files









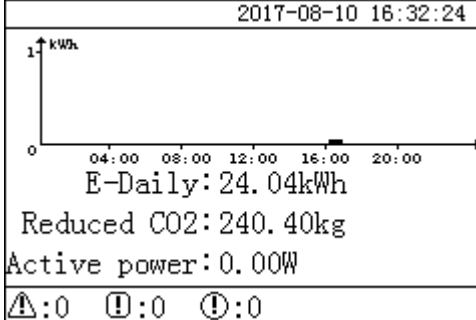

You can import all files to the SmartLogger on the monitoring panel.

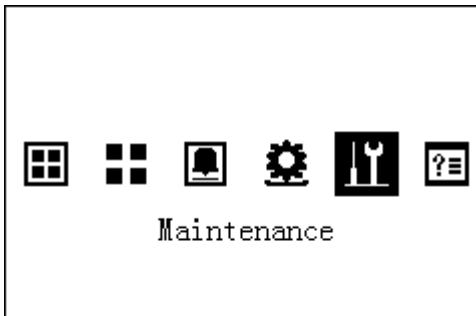
Context

If the SmartLogger needs to be replaced, you can export all files before the replacement and then import the exported files to the new SmartLogger to ensure data integrity.

Procedure

- The following table describes the procedure for importing all files. The parameter values in the figures are for reference only.

LCD	Procedure
 <p>2017-08-10 16:32:24</p> <p>1↑ kWh</p> <p>04:00 08:00 12:00 16:00 20:00 h</p> <p>E-Daily: 24.04kWh</p> <p>Reduced CO2: 240.40kg</p> <p>Active power: 0.00W</p> <p>⚠:0 ⓘ:0 ⓘ:0</p>	<p>1. On the default screen, press  to enter the main menu.</p>
 <p>     </p> <p>Maintenance</p>	<p>2. Choose  and press .</p>

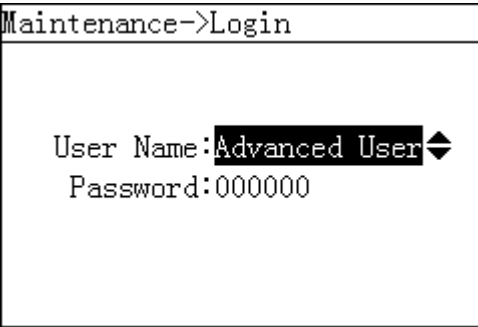
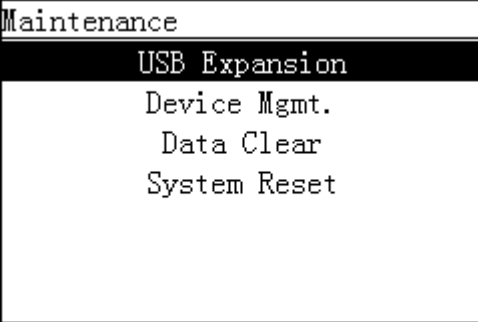
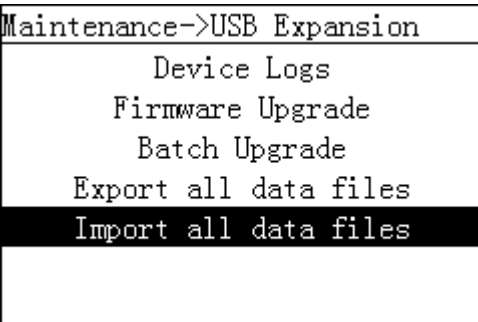
LCD	Procedure
 <p>Maintenance->Login</p> <p>User Name: Advanced User ⬅</p> <p>Password: 000000</p>	<p>3. Enter the User Name and Password by pressing ▲ or ▼, and then press ↵.</p> <p>NOTE</p> <ul style="list-style-type: none"> Because of the limited permission, select the User Name as Advanced User or Special User. The initial password for Advanced User and Special User is <i>000001</i>. After passing the permission validation, the system keeps the authentication information for 30 seconds. If you exit the screen and log in again within the 30 seconds, no permission authentication is required.
 <p>Maintenance</p> <p>USB Expansion</p> <p>Device Mgmt.</p> <p>Data Clear</p> <p>System Reset</p> <p>Here use the pages displayed when you log in to the SmartLogger as Advanced User.</p>	<p>4. Choose USB Expansion and press ↵.</p> <p>NOTE</p> <ul style="list-style-type: none"> Before this operation, connect the USB flash drive to the USB port. If no USB flash drive is detected, the LCD displays a message prompting No USB device detected. <p>The system takes 5 to 10 seconds to detect the USB flash drive. Then perform the following steps.</p>
 <p>Maintenance->USB Expansion</p> <p>Device Logs</p> <p>Firmware Upgrade</p> <p>Batch Upgrade</p> <p>Export all data files</p> <p>Import all data files</p>	<p>5. Select Import all data files and press ↵.</p>

----End

6.2.33 Managing Devices

You can search, add, delete, and assign addresses to devices that are connected to the SmartLogger on the monitoring panel.

Context

- Provided that all the inverters are correctly connected to the SmartLogger and that all the communications parameters are correctly set, the SmartLogger can perform the automatic search and detect all the connected inverters.

- Before you perform the **Auto. Search** operation, if the SmartLogger is connected to devices that no longer exist in the PV power system, remove them from the SmartLogger manually. Otherwise, these devices are still detectable with **Disconnection** status.
- After you add, delete, or replace a device, or change the RS485 address, search for devices again or restart the SmartLogger (the SmartLogger automatically searches for devices after it restarts).
- EMI, slave SmartLogger, power meter, PLC, and third-party devices cannot be automatically recognized, and must be manually added.
- For devices that no longer exist in the PV power system, perform **Single Remove** or **Batch Remove** in time to avoid wasting the system resources.
- The RS485 addresses of all inverters are the same when delivered. If the firmware version of the SUN2000 is V100R001C00SPC010 or later, or V100R001C81SPC105 or later, you can perform automatic address assignment on the SmartLogger and adjust the addresses to realize remote site setup and improve maintenance efficiency.
- When connecting a third-party device, you need to import a configuration file for the device, and then manually add the device.
- If you perform **Alarm Reset**, all active and historical alarms for the selected device will be deleted and the SmartLogger will be enabled to collect new alarm data.









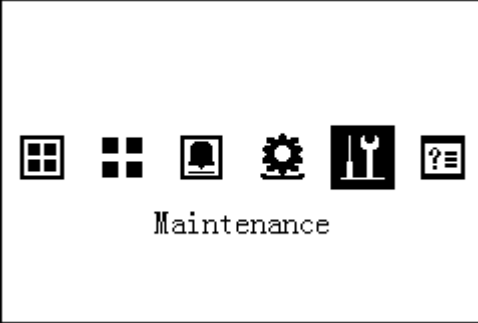

NOTICE

- If **Data Clear** is performed on Huawei devices such as the inverter and PID module, **Alarm Reset** must be performed on the SmartLogger and NMS. Otherwise, the SmartLogger cannot collect alarm information generated by the devices after **Data Clear** is performed.
- If **Alarm Reset** or **Data Clear** is performed on the SmartLogger, **Alarm Reset** must also be performed on the NMS. Otherwise, the NMS cannot obtain alarm information collected by the SmartLogger after **Alarm Reset** or **Data Clear** is performed.

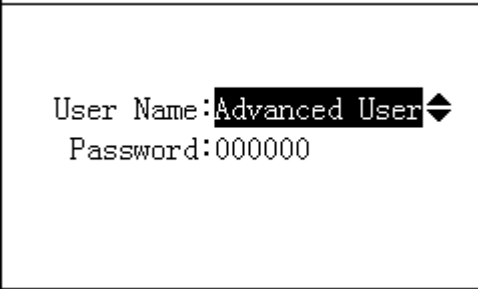



Procedure

- The following table describes the procedure for managing the devices. The parameter values in the following figures are for reference only.

LCD	Operation Procedure
<p>2017-08-10 16:32:24</p> <p>1 kWh</p> <p>04:00 08:00 12:00 16:00 20:00 h</p> <p>E-Daily: 24.04kWh</p> <p>Reduced CO2: 240.40kg</p> <p>Active power: 0.00W</p> <p>A:0 I:0 I:0</p>	<p>1. On the default screen, press to enter the main menu.</p>

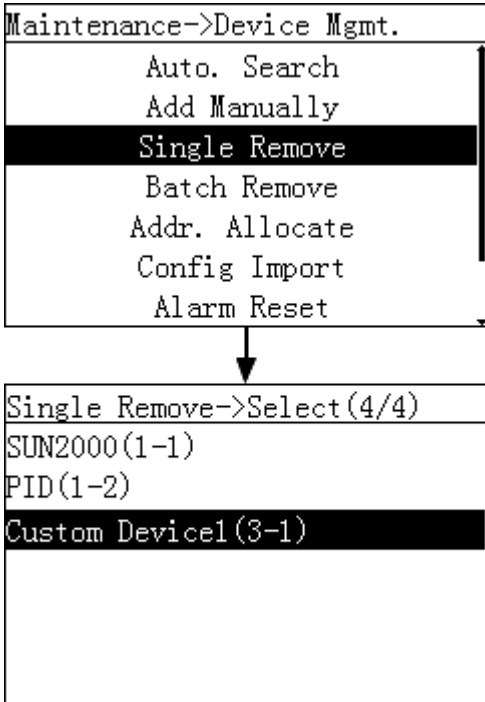
LCD	Operation Procedure
 <p>Maintenance</p>	<p>2. Choose  and press .</p>
<p>Maintenance->Login</p>  <p>User Name: Advanced User  Password: 000000</p>	<p>3. Enter the User Name and Password by pressing  or , and then press .</p> <p>NOTE</p> <ul style="list-style-type: none"> Because of the limited permission, select the User Name as Advanced User or Special User. The initial password for Advanced User and Special User is <i>000001</i>. After passing the permission validation, the system keeps the authentication information for 30 seconds. If you exit the screen and log in again within the 30 seconds, no permission authentication is required.
<p>Maintenance</p> <ul style="list-style-type: none"> USB Expansion Device Mgmt. Data Clear System Reset 	<p>4. Choose Device Mgmt. and press .</p> <ul style="list-style-type: none"> Perform step 5 to enable the SmartLogger to automatically search for devices. Perform step 6 to add devices to the SmartLogger. Perform step 7 to remove a single device. Perform step 8 to remove devices in batches. Perform steps 9-12 to automatically assign addresses. Perform step 13 to import a configuration file. Perform step 14 to reset alarms. Perform steps 15-17 to start or shut down inverters in batches. Perform step 18 to reset inverters in batches.

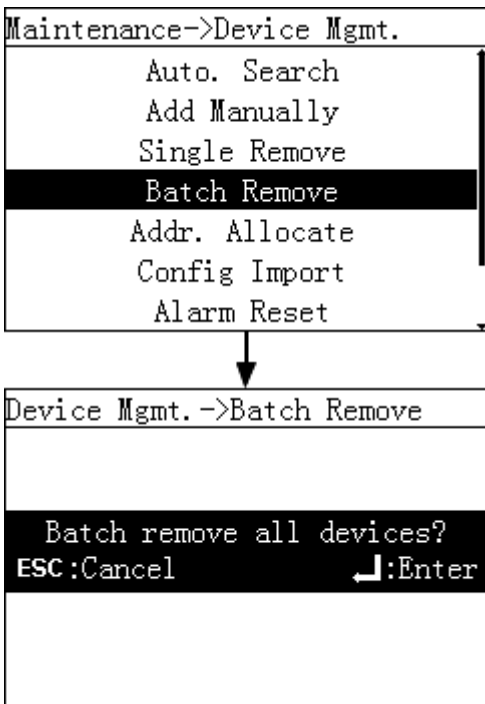

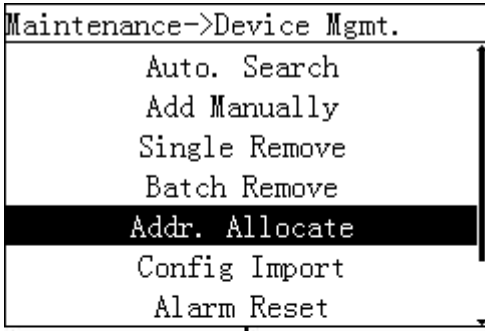
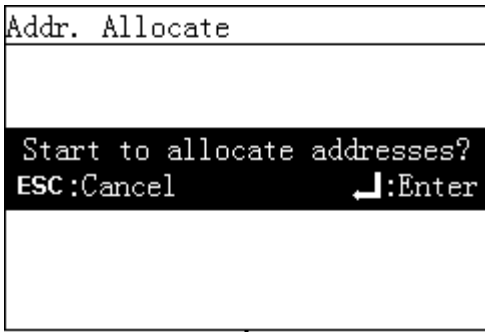

LCD	Operation Procedure
<pre> Maintenance->Device Mgmt. ┌───────────────────────────┐ │ Auto. Search │ │ Add Manually │ │ Single Remove │ │ Batch Remove │ │ Addr. Allocate │ │ Config Import │ │ Alarm Reset │ └───────────────────────────┘ ↓ Device Mgmt.->Auto. Search ┌───────────────────────────┐ │ Devices already exist: 5 │ │ Search again? │ │ ESC:Cancel │ │ │ │ │ └───────────────────────────┘ </pre>	<p>5. Choose Auto. Search and press ↵.</p> <p>Before performing the automatic search, ensure that all the devices can normally communicate with the SmartLogger.</p> <p>NOTE</p> <ul style="list-style-type: none"> • After you add, delete, or replace a device, or change the RS485 address, search for devices again. • If a device is added, search for the device on the SmartLogger or restart the SmartLogger and then search for the device on the NMS.
<pre> Maintenance->Device Mgmt. ┌───────────────────────────┐ │ Auto. Search │ │ Add Manually │ │ Single Remove │ │ Batch Remove │ │ Addr. Allocate │ │ Config Import │ │ Alarm Reset │ └───────────────────────────┘ ↓ Device Mgmt.->Add Manually Device type: SUN2000 Comm. protocol: Modbus-RTU IP address: 0. 0. 0. 0 </pre>	<p>6. Choose Add Manually and press ↵.</p> <p>NOTE</p> <ul style="list-style-type: none"> • EMI, slave SmartLogger, power meter, PLC, and third-party devices must be manually added. • If the communication is abnormal, or the address on the port has been used, the device cannot be added.

LCD	Operation Procedure
 <p>Maintenance->Device Mgmt.</p> <p>Auto. Search Add Manually Single Remove Batch Remove Addr. Allocate Config Import Alarm Reset</p> <p>↓</p> <p>Single Remove->Select(4/4)</p> <p>SUN2000(1-1) PID(1-2) Custom Device1(3-1)</p>	<p>7. Choose Single Remove and press  twice.</p> <p>NOTE For devices that no longer exist in the PV power system, remove them in time to avoid wasting system resources.</p>
 <p>Maintenance->Device Mgmt.</p> <p>Auto. Search Add Manually Single Remove Batch Remove Addr. Allocate Config Import Alarm Reset</p> <p>↓</p> <p>Device Mgmt. ->Batch Remove</p> <p>Batch remove all devices? ESC:Cancel :Enter</p>	<p>8. Choose Batch Remove and press .</p> <p>NOTE For devices that no longer exist in the PV power system, remove them in time to avoid wasting system resources.</p>

LCD	Operation Procedure
 <p>Maintenance->Device Mgmt.</p> <p>Auto. Search</p> <p>Add Manually</p> <p>Single Remove</p> <p>Batch Remove</p> <p>Addr. Allocate</p> <p>Config Import</p> <p>Alarm Reset</p> <p>↓</p> <p>Addr. Allocate->Addr. Allocate</p> <p>Start address:11</p>	<p>9. Select Addr. Allocate, set the start addresses assigned for RS485-1, RS485-2, and RS485-3, and then press ↵ to allocate the addresses.</p>
 <p>Addr. Allocate</p> <p>Start to allocate addresses?</p> <p>ESC:Cancel ↵:Enter</p>	<p>10. Press ↵ to confirm the address assignment.</p>

LCD	Operation Procedure
<p>...->Addr. Adjustment</p> <p>Adjust the address? ESC:Cancel ↵:Enter</p> <p style="text-align: center;">↓</p> <p>...->Addr. Adjustment</p> <p>AM0107164901D2001224:2-002</p>	<p>11. After the setting of Addr. Allocate is completed, press ↵ to adjust addresses.</p>
<p>Device Mgmt.->Auto. Search</p> <p>Devices already exist: 5 Search again? ESC:Cancel ↵:Enter</p> <p style="text-align: center;">↓</p> <p>Device Mgmt.->Auto. Search</p> <p>Search complete. Device found 5 PCS.</p> <p style="text-align: right;">↵:Enter</p>	<p>12. After the setting of Addr. Adjustment is completed, press ↵ to search the devices.</p>

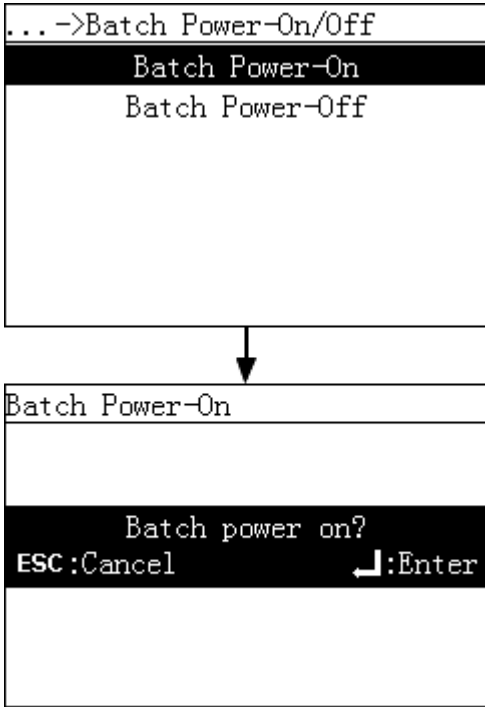
LCD	Operation Procedure
<p>Maintenance->Device Mgmt.</p> <pre> Auto. Search Add Manually Single Remove Batch Remove Addr. Allocate Config Import Alarm Reset </pre> <p style="text-align: center;">↓</p> <p>Device Mgmt. ->Config Import</p> <pre> Custom Device 1 Custom Device 2 Custom Device 3 Custom Device 4 Custom Device 5 </pre>	<p>13. Choose Config Import, select a custom device as required, and press ↵ to import a configuration file.</p> <p>NOTE</p> <ul style="list-style-type: none"> • Before importing a configuration file, you must plug in a USB drive that contains the configuration file. • After importing a configuration file, you need to manually add a third-party device.
<p>Maintenance->Device Mgmt.</p> <pre> Auto. Search Add Manually Single Remove Batch Remove Addr. Allocate Config Import Alarm Reset </pre> <p style="text-align: center;">↓</p> <p>Alarm Reset->Select(1/5)</p> <pre> SUN2000(3-2) PLC(3-249) PID(3-1) Custom Device1(2-1) EMI(1-1) </pre>	<p>14. Choose Alarm Reset, select a device as required, and press ↵.</p>

LCD	Operation Procedure
 <p>Maintenance->Device Mgmt. Add Manually Single Remove Batch Remove Addr. Allocate Config Import Alarm Reset Batch Power-On/Off</p>	<p>15. Choose Batch Power-On/Off and press </p>
 <p>...->Batch Power-On/Off Batch Power-On Batch Power-Off</p> <p style="text-align: center;">↓</p> <p>Batch Power-On</p> <p>Batch power on? ESC:Cancel :Enter</p>	<p>16. Choose Batch Power-On and press </p>

LCD	Operation Procedure
<pre> ... ->Batch Power-On/Off Batch Power-On Batch Power-Off </pre> <p style="text-align: center;">↓</p> <pre> Batch Power-Off </pre> <pre> Batch power off? ESC:Cancel ↵:Enter </pre>	<p>17. Choose Batch Power-Off and press ↵.</p>
<pre> Maintenance->Device Mgmt. Single Remove Batch Remove Addr. Allocate Config Import Alarm Reset Batch Power-On/Off Batch Reset </pre> <p style="text-align: center;">↓</p> <pre> Device Mgmt. ->Batch Reset </pre> <pre> Perform batch reset? ESC:Cancel ↵:Enter </pre>	<p>18. Choose Batch Reset and press ↵ to confirm the batch reset operation.</p>

----End

6.2.34 Clearing Data

This topic describes how to delete alarm and performance data on the monitoring panel.

Context

Clear data if the SmartLogger location changes and its historical data need to be deleted.



NOTICE

- After the data clear operation is performed, all information stored on the SmartLogger, including energy yield, performance data, and alarms, will be removed.
- After the data clear operation is performed, the devices connected to the SmartLogger are not removed. If an original device will not connect to the SmartLogger, remove the device.
- If you perform **Data Clear** on the SmartLogger, you also have to perform **Alarm Reset** on the NMS. Otherwise, the alarm information collected by the NMS and SmartLogger will be different.

Procedure

- The following table describes the procedure for clearing data. The parameter values in the figures are for reference only.

LCD	Operation Procedure
	<p>1. On the default screen, press to enter the main menu.</p>
	<p>2. Choose and press .</p>

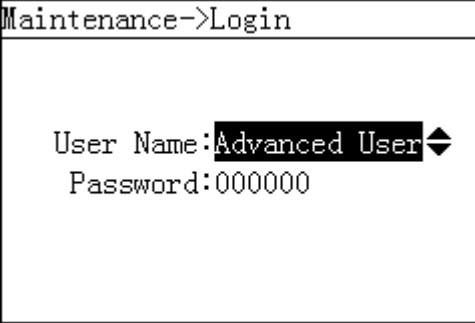
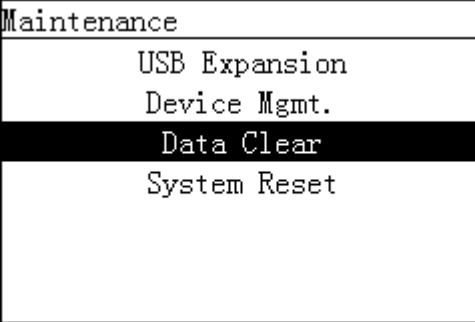
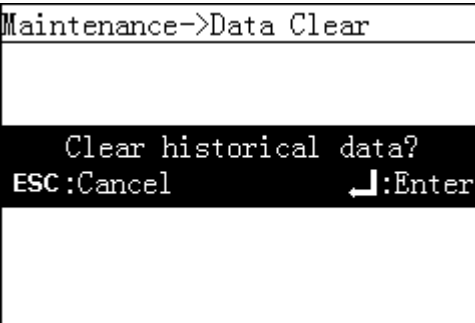
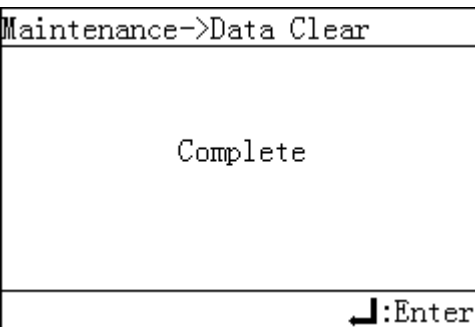
LCD	Operation Procedure
 <p>Maintenance->Login</p> <p>User Name: Advanced User ⬅</p> <p>Password: 000000</p>	<p>3. Enter the User Name and Password by pressing ▲ or ▼, and then press ↵.</p> <p>NOTE</p> <ul style="list-style-type: none"> Because of the limited permission, select the User Name as Advanced User or Special User. The initial password for Advanced User and Special User is <i>000001</i>. After passing the permission validation, the system keeps the authentication information for 30 seconds. If you exit the screen and log in again within the 30 seconds, no permission authentication is required.
 <p>Maintenance</p> <p>USB Expansion</p> <p>Device Mgmt.</p> <p>Data Clear</p> <p>System Reset</p>	<p>4. Press ▼, select Data Clear, and press ↵.</p> <p>NOTICE</p> <p>Cleared data cannot be restored. Therefore, perform this operation with caution.</p>
 <p>Maintenance->Data Clear</p> <p>Clear historical data?</p> <p>ESC:Cancel ↵:Enter</p>	<p>5. On the displayed screen, press ↵.</p>
 <p>Maintenance->Data Clear</p> <p>Complete</p> <p>↵:Enter</p>	<p>6. After the data is cleared, press ↵. No further operation is required.</p>









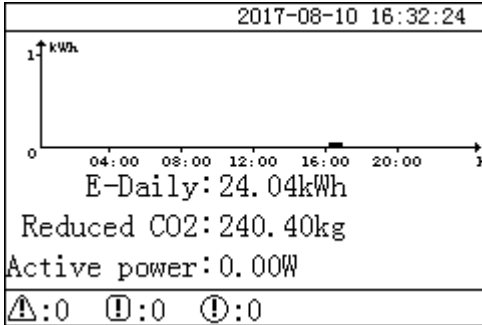

----End

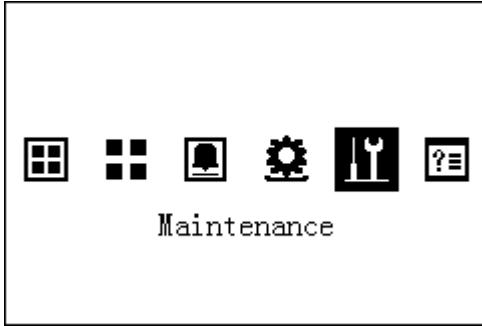
6.2.35 Resetting the System

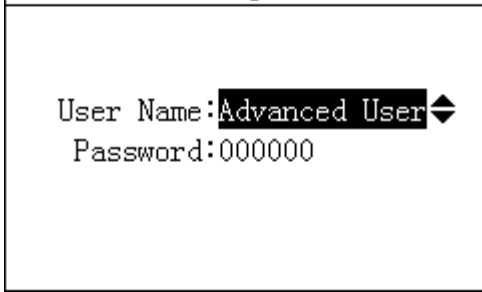
You can reset the system on the LCD.

Procedure

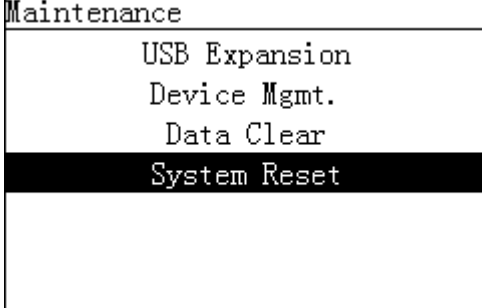
- The following table lists the procedure for resetting the system. The parameter values in the following figures are for reference only.

LCD	Operation Procedure
	<p>1. On the default screen, press  to enter the main menu.</p>
	<p>2. Choose  and press .</p>
<p>Maintenance->Login</p> 	<p>3. Enter the User Name and Password by pressing  or , and then press .</p> <p>NOTE</p> <ul style="list-style-type: none"> Because of the limited permission, select the User Name as Advanced User or Special User. The initial password for Advanced User and Special User is <i>000001</i>. After passing the permission validation, the system keeps the authentication information for 30 seconds. If you exit the screen and log in again within the 30 seconds, no permission authentication is required.
<p>Maintenance</p> 	<p>4. Choose System Reset by pressing , and press .</p>

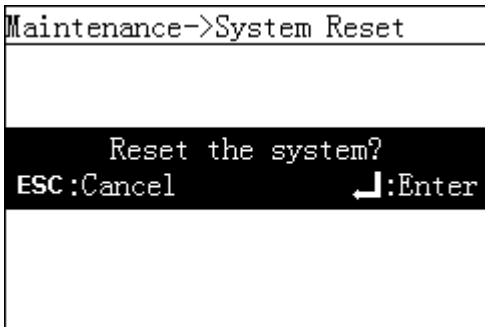
LCD	Operation Procedure
	<p>5. Press ↵.</p>



----End

6.2.36 Querying Product Information

This topic describes how to query the information about the SmartLogger on the monitoring panel.

Procedure

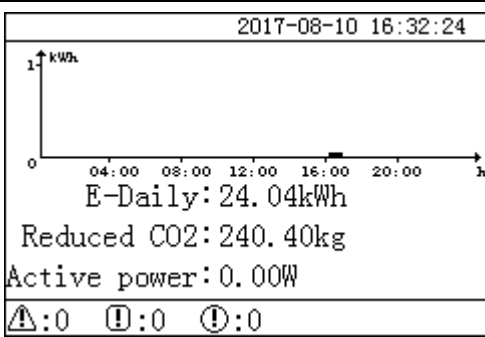
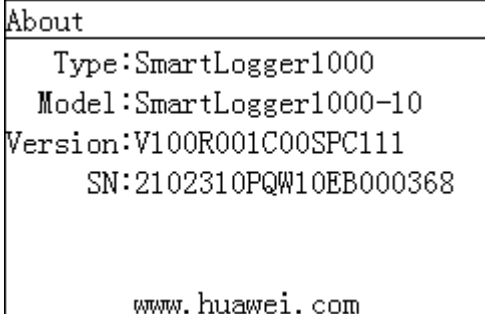
- The following table describes the procedure for querying product information. The parameter values in the following figures are for reference only.

LCD	Operation Procedure
	<p>1. On the default screen, press ↵ to enter the main menu.</p>
	<p>2. Select  and press ↵.</p>

----End

7 WebUI

7.1 Note



NOTICE

- The web software version corresponding to the WebUI snapshots in this document is SmartLogger V100R001C00SPC114. The data on the WebUI snapshots is for reference only.
- Parameters displayed on operation pages vary depending on the role that you use to log in to the WebUI. This document describes the operation pages displayed after you log in as **Advanced User**.
- Configurable parameters vary depending on the device model and grid code. The actual display prevails. The parameter list provided in this document includes all configurable parameters.
- The 600 V and 1000 V inverters refer to the inverters with the maximum input voltage of 600 V and 1000 V respectively. The 1100 V inverters refer to the inverters with the maximum input voltage of 1100 V and the SUN2000-33KTL-US/36KTL-US/40KTL-US. The maximum input voltage can be queried from the product nameplate or the appropriate user manual.

7.2 Preparations for Login

Operating Environment

The operating environment for the WebUI should meet the following requirements:

- Operating system: Windows
- Internet Explorer 8 to Internet Explorer 11, Firefox17–Firefox39, or CHROME41–CHROME45 (Windows 7)
- Minimum resolution: 1024x768



NOTE

- For Internet Explorer 8, the recommended release is 8.0.7601.17514 or later.

- For Internet Explorer 10, the compatible mode is recommended.

Setting the IP Address

Correctly set the IP address, subnet mask, and gateway for the SmartLogger, PC, and network devices (when connected).

Setting the LAN



NOTICE

- If the SmartLogger is connected to a local area network (LAN) and a proxy server has been set, you need to cancel the proxy server settings.
- If the SmartLogger is connected to the Internet and the PC is connected to the LAN, do not cancel the proxy server settings.

- Step 1** Open Internet Explorer.
- Step 2** Choose **Tools > Internet Options**.
- Step 3** Click the **Connections** tab and then click **LAN settings**.

Figure 7-1 LAN setting (1)

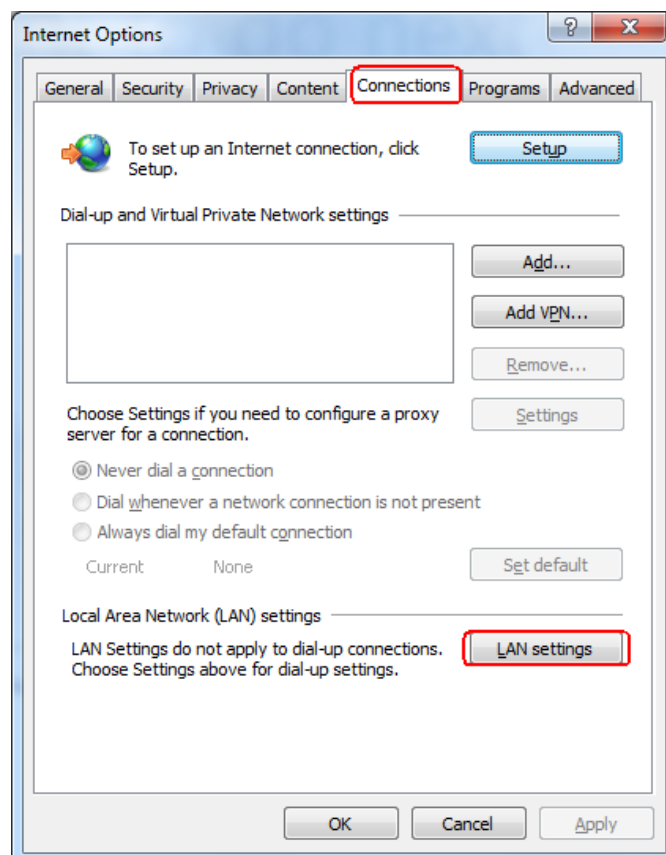

Step 4 Deselect **User a proxy server for your LAN**.

Figure 7-2 LAN setting (2)

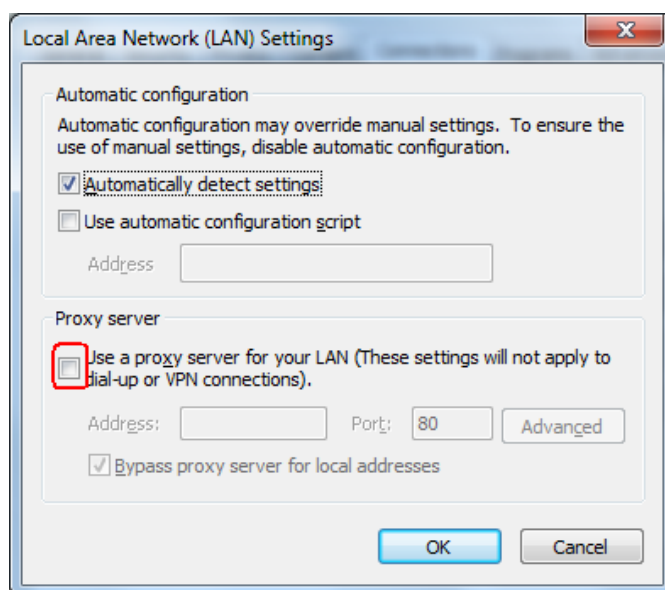

Step 5 Click **OK**.

----End

Setting Internet Explorer Security



NOTICE

To export fault information and operation logs, you need to set the Internet Explorer security.

Step 1 Open Internet Explorer.

Step 2 Choose **Tools > Internet Options**.

Step 3 Click the **Security** tab and then click **Sites** in **Trusted sites**.

Figure 7-3 Internet Explorer security setting (1)

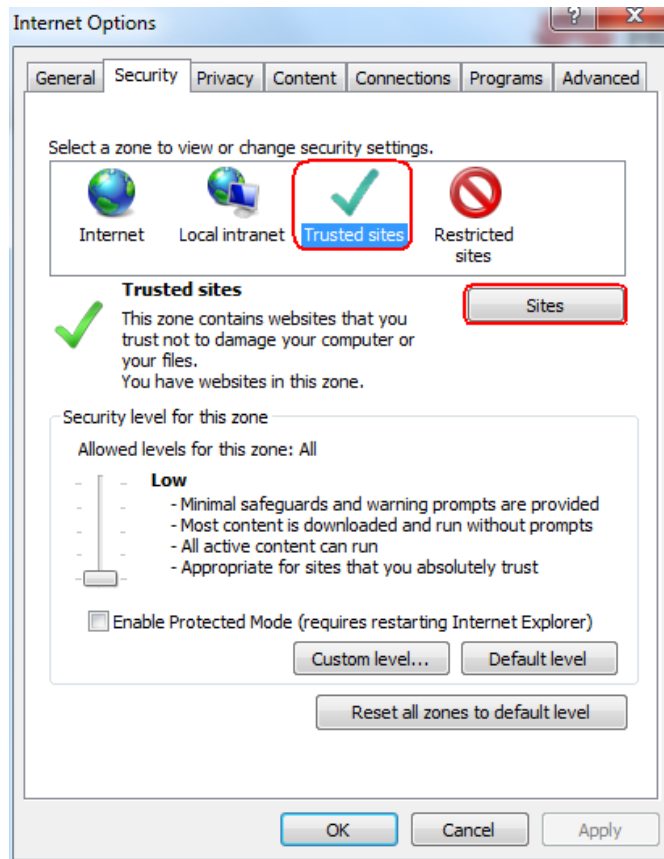

Step 4 Enter the website address of the WebUI (enter the default IP address 192.168.0.10 of the SmartLogger for the first login), click **Add**, and then click **Close**.

Figure 7-4 Internet Explorer security setting (2)

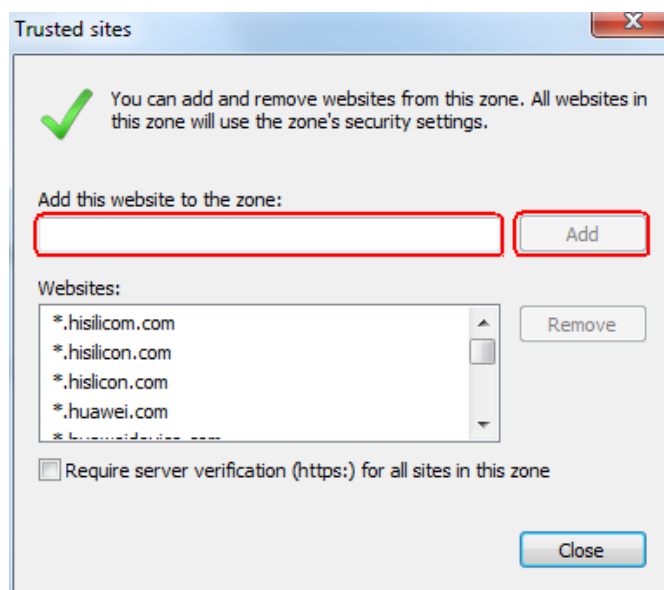

Step 5 Set **Security level for this zone** to **Medium** or **Low**.

----End

7.3 Logging In to the WebUI

Context

The SmartLogger has been connected to a PC directly or over the Ethernet. For details, see [4.8 Connecting an Ethernet Network Cable](#).

If you log in to the WebUI for the first time, a security risk warning shown in [Figure 7-5](#) is displayed. Click **Continue to this website**, to continue the WebUI login.

NOTE

- It is recommended that users use their own certificates. If the certificate is not replaced, the security risk warning will be displayed during each login.
- After logging in to the WebUI, you can import a certificate under **Network Security Certification** on the [7.11.3 Setting Security Parameters](#) page.
- The imported security certificate needs to be bound to the SmartLogger IP address. Otherwise, the security risk warning will still be displayed during login.

Figure 7-5 Security risk warning

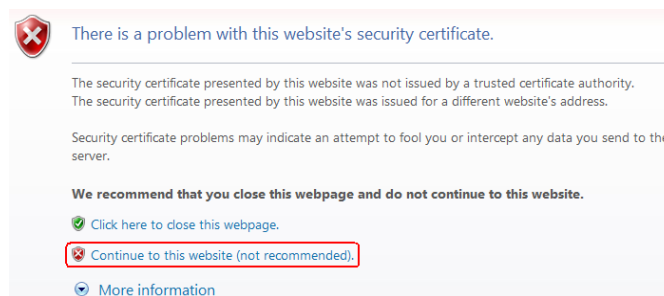

Procedure

Step 1 Enter **https://XX.XX.XX.XX** in the address box of the browser, and press **Enter**. The login page is displayed.

Figure 7-6 Login page

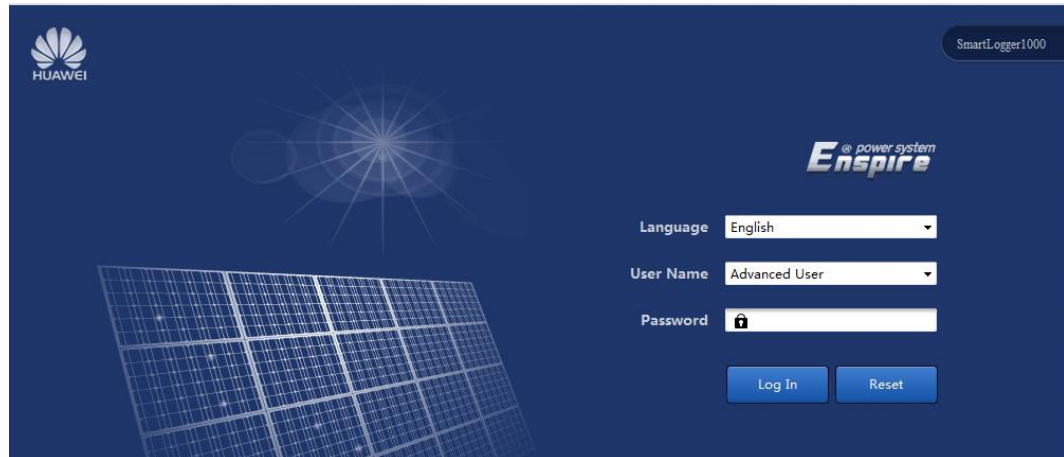

NOTE

XX.XX.XX.XX is the IP address for the SmartLogger. For example, the default IP address for the SmartLogger is **https://192.168.0.10**.

Step 2 Specify **Language**, **User Name**, and **Password**, and then click **Log In**.



NOTE

- The user name is **Common User**, **Advanced User**, or **Special User**. The password is *000001* in V100R001C95SPC010 or earlier and is *ChangeMe* in V100R001C95SPC020 or later.
- After the first login, change the initial password immediately to ensure account security.
- If you enter wrong passwords for five consecutive times in 5 minutes, your account will be locked out. You have to try again with the account 10 minutes later.



NOTICE

If any page is blank or a menu cannot be accessed after you log in to the WebUI, clear the cache, refresh the page, or log in again.

----End

7.4 WebUI Menu

The WebUI varies with the role that you use to log in.



NOTE

- indicates that the user has permission to operate the menu; ○ indicates that the user does not have permission to operate the menu.

Table 7-1 Users and permission on the WebUI

Menu				Common User	Advanced User	Special User	
Main Menu	Second-Level Menu	Third-Level Menu	Fourth-Level Menu				
Over View	Plant Running Info.	-	-	●	●	●	
	Active Alarm	-	-	●	●	●	
	Plant Yield	-	-	●	●	●	
	Performance Data	-	-	●	●	●	
	Device Running Info.	-	-	●	●	●	
Monitoring	SmartLogger 1000	Running Info.	-	●	●	●	
		Active Alarm	-	●	●	●	
		About	-	●	●	●	
	Inverter ^a	Running Info.	-	●	●	●	
		Active Alarm	-	●	●	●	
		Performance Data	-	●	●	●	
		Yield	-	●	●	●	
		Running Param.	Grid Parameters		○	●	●
			Protect Parameters		○	●	●
			Feature Parameters		○	●	●
			Power Adjustment		○	○	●
	Tracking System	-		○	●	○	

Menu				Common User	Advanced User	Special User
Main Menu	Second-Level Menu	Third-Level Menu	Fourth-Level Menu			
		LVRT Characteristic Curve	-	○	○	●
		About	-	●	●	●
	PLC	Running Info.	-	●	●	●
		STA List	-	○	●	○
		Networking Settings	-	○	●	○
		About	-	●	●	●
	EMI	Running Info.	-	●	●	●
		Performance Data	-	●	●	●
		About	-	●	●	●
	Power Meter ^b	Running Info.	-	●	●	●
		Performance Data	-	●	●	●
		Running Param.	-	○	●	○
		About	-	●	●	●
	PID	Running Info.	-	●	●	●
		Active Alarm	-	●	●	●
		Performance Data	-	●	●	●
		Running Param.	-	○	●	○
		About	-	●	●	●
	Custom Device	Running Info.	-	●	●	●
		Teleindication	-	●	●	●











Menu				Common User	Advanced User	Special User	
Main Menu	Second-Level Menu	Third-Level Menu	Fourth-Level Menu				
		Telemetry	-	●	●	●	
		Telecontrol	-	●	●	●	
		Teleadjust	-	●	●	●	
Query	Alarm History	-	-	●	●	●	
	Operation Log	-	-	○	●	●	
	Export Data	-	-	○	●	●	
Settings	User Param.	Date&Time	-	●	●	○	
		Plant	-	●	●	○	
		Currency	-	●	●	○	
	Comm. Param.	Ethernet	-	-	○	●	○
		RS485	-	-	○	●	○
		EMI	-	-	○	●	○
		Power Meter	-	-	○	●	●
		NetEco	-	-	○	●	○
		Modbus TCP	-	-	○	●	○
		IEC103	-	-	○	●	○
		IEC104	-	-	○	●	○
	Extended Param.	FTP	-	-	○	●	○
		Email	-	-	○	●	○
	Port Settings	DO	-	-	○	●	○
		USB	-	-	○	●	○
	Alarm Output	-	-	-	○	●	○
	Extended Port Settings	-	-	-	○	○	●
Active Power Control	-	-	-	○	○	●	

Menu				Common User	Advanced User	Special User	
Main Menu	Second-Level Menu	Third-Level Menu	Fourth-Level Menu				
	Reactive Power Control	-	-	○	○	●	
	Dry Contact Remote Shut	-	-	○	○	●	
	DI Port Settings	-	-	○	○	●	
	Export Limitation	-	-	○	○	●	
Maintenance	Firmware Upgrade	-	-	○	●	●	
	Product Information	-	-	●	●	●	
	Security Settings	-	-	●	●	●	
	System Maint.	-	-	○	●	●	
	Device Log	-	-	○	●	●	
	Onsite Test	Inspection	-	-	○	●	●
		Spot-check ^c	-	-	○	●	●
	License Management	-	-	○	●	●	
	Device Mgmt.	Connect Device	-	-	○	●	●
		Device list	-	-	○	●	●
		Export Param.	-	-	○	●	●
		Alarm Reset	-	-	○	●	●
Collect Perf. Data		-	-	○	●	●	
Adjust total energy yield		-	-	○	●	●	

 **NOTE**

- a: In the inverter, **Tracking System** and **LVRT Characteristic Curve** are only available for the 1100 V inverter.
- b: The power meter can support the standard Modbus-RTU or DL/T645 protocol. **Running Param.** is only available for the power meter that supports DL/T645.
- c: The spot-check function is available only for the inverter for which **Grid Code** is set to **Japan standard**.

7.5 Icon Description

Icon	Description	Icon	Description
	Click the About icon to query the WebUI version information.		Click the Drop-down icon to select a parameter or time.
	Click the Exit icon to log out.		Alarms are classified into major, minor, and warning ones. Click the Alarm icon to query an alarm.
	Click the Increase/Decrease icon to adjust time.		Click the Start icon to start the device.
	The Select icon indicates that a parameter is selected.		Click the Stop icon to shut down the device.
	The Select icon indicates that a parameter is not selected. Click the icon to select a parameter.		Click the Reset icon to reset the device.

7.6 WebUI Layout

Figure 7-7 WebUI layout

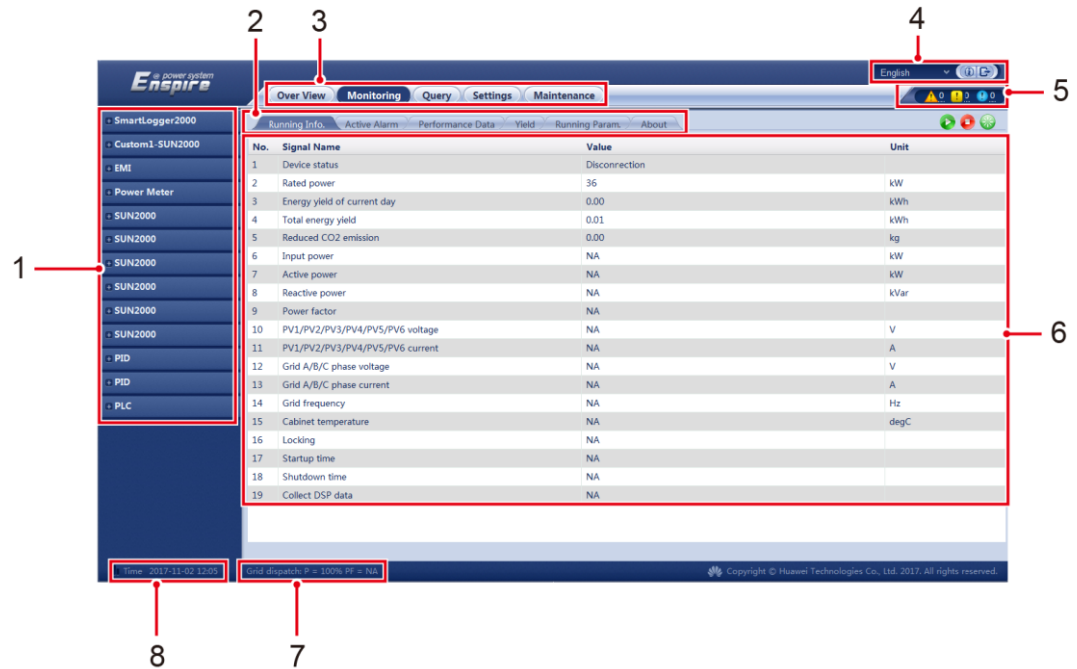

Table 7-2 WebUI layout description

No.	Function	Description
1	Secondary navigation menu	Under the primary navigation menu, choose the device to be queried or the parameter to be set under the secondary navigation menu.
2	Tertiary navigation menu ^a	After choosing a secondary menu, choose a tertiary menu to access the query or setting screen.
3	Primary navigation menu	Click the corresponding primary navigation menu before you perform any operation over the WebUI.
4	Display language	Select the display language or choose to log out.
5	Alarm icon	Displays the severities and number of alarms in the system. You can access the alarm page by clicking the number.
6	Details page	Displays the details of the queried information or parameter settings.
7	Power grid scheduling status	Displays the current power grid scheduling mode of the system.
8	System time	Displays the current system time.

No.	Function	Description
		a: There are no tertiary navigation menus under certain secondary navigation menus.

7.7 Overview

7.7.1 Plant Running Information

Choose **Over View > Plant Running Info.** and query information on the displayed page.

Figure 7-8 Plant running information

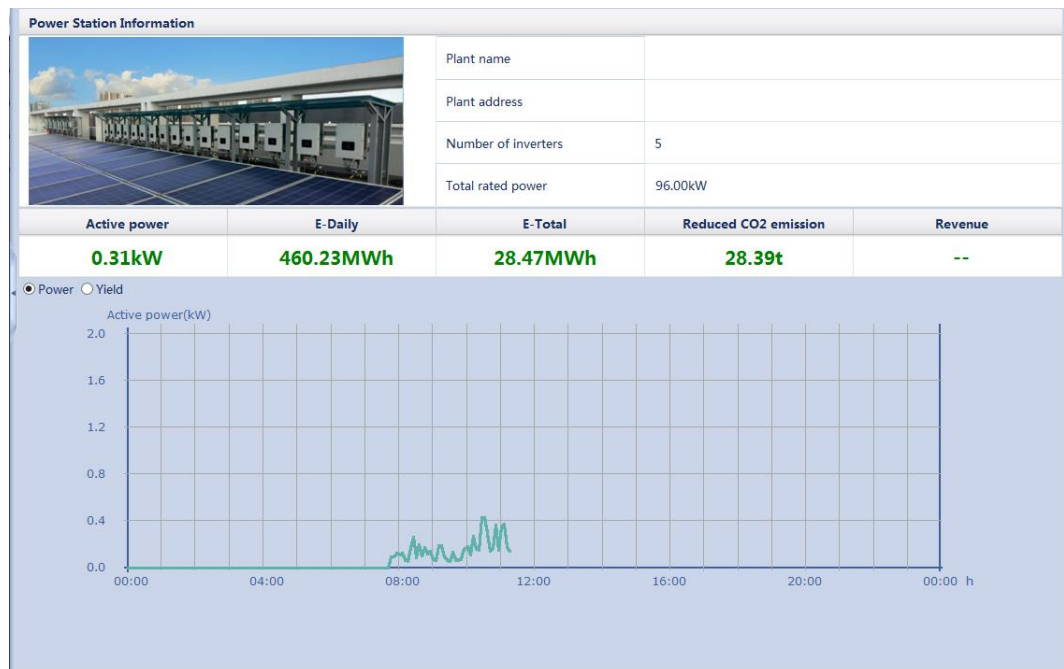

NOTE

The PV plant running information contains only the information about all the Huawei SUN2000s connected to the SmartLogger.

7.7.2 Active Alarm

Choose **Over View > Active Alarm** and query alarms on the displayed page.

Figure 7-9 Active alarm

Active Alm Quantity: 5

Device: All Severity: All Sorting mode: Time Filter

Alarm ID	Severity	Device	Alarm Name	Gen
111	Warning	40KTL-US(COM1-8)	Abnormal String 6	201
109	Warning	40KTL-US(COM1-8)	Abnormal String 4	201
108	Warning	40KTL-US(COM1-8)	Abnormal String 3	201
107	Warning	40KTL-US(COM1-8)	Abnormal String 2	201
106	Warning	40KTL-US(COM1-8)	Abnormal String 1	201

Navigation: << < 1 > >> 1 / 1 Page Go to

7.7.3 Plant Yield

Choose **Over View > Plant Yield** and query energy yield data on the displayed page.

Figure 7-10 Energy yield

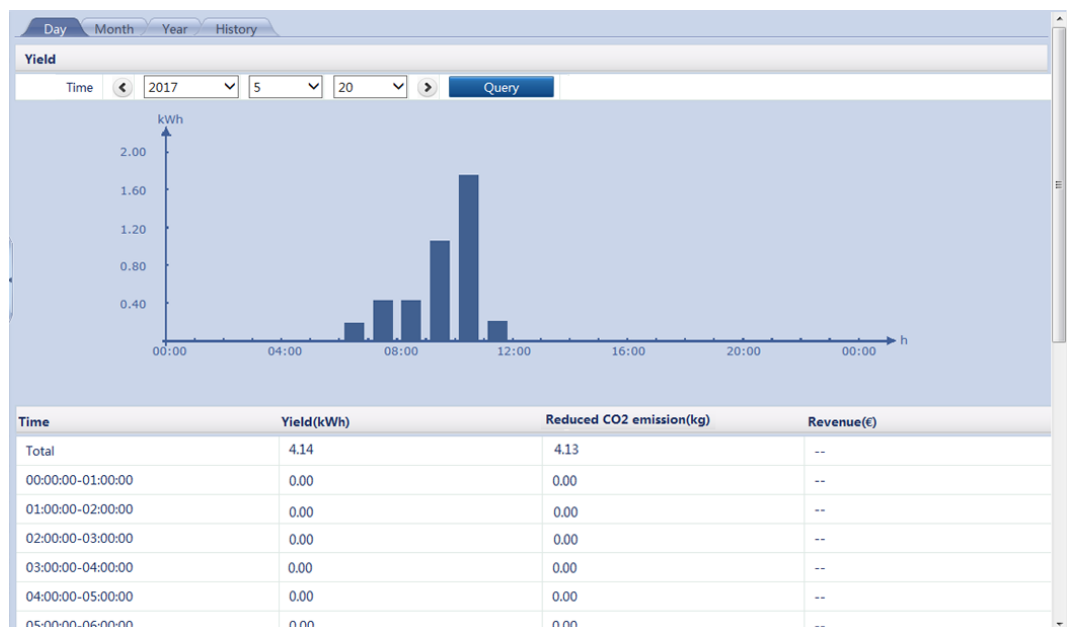

NOTE

You can select a tab on the tertiary navigation tree to query the energy yield data of the specific period.



NOTICE

- The daily energy yields can be stored for 30 days on an hourly basis.
- The monthly energy yields can be stored for 1 year on a daily basis.
- The yearly energy yields can be stored for 10 years on a monthly basis.
- The historical energy yields can be stored for 25 years on a yearly basis.

7.7.4 Performance Data

Choose **Over View > Performance Data** and query related information on the displayed page.

Figure 7-11 Performance data

Generation time	E-Daily(kWh)	Input power(kW)	Active power(kW)
2017-5-20 00:00:00	0.00	3.549	3.415
2017-5-20 00:05:00	2.68	3.548	3.449
2017-5-20 00:10:00	5.37	3.582	3.407
2017-5-20 00:15:00	8.07	3.493	3.359
2017-5-20 00:20:00	10.76	3.476	3.402
2017-5-20 00:25:00	13.46	3.478	3.374
2017-5-20 00:30:00	16.17	3.466	3.421
2017-5-20 00:35:00	18.86	3.542	3.397
2017-5-20 00:40:00	21.57	3.535	3.440
2017-5-20 00:45:00	24.27	3.506	3.412
2017-5-20 00:50:00	26.94	3.581	3.447
2017-5-20 00:55:00	29.64	3.582	3.418



NOTE

- You can click an option in the upper left corner of the page to display the data in the specified format or export the data.
- When changing the name of the exported file after data is exported, retain the extension **.tar.gz**. Otherwise, the file will be unusable.

7.7.5 Device Running Information

Choose **Over View > Device Running Info.** to enter the page. You can check or import the device running information here.





Figure 7-12 Device running information

Total Device Qty.:6					
Device	Address	Device status	E-Daily(kWh)	Active power(kW)	Reactive power(kVar)
28KTL(COM6-1)	6-1	Disconnection	0.00	0.000	0.000
40KTL(COM6-2)	6-2	Disconnection	0.00	0.000	0.000
30KTL-US(COM6-3)	6-3	Disconnection	0.00	0.000	0.000
50KTL(COM6-4)	6-4	Disconnection	0.00	0.000	0.000
40KTL-US(COM6-5)	6-5	Disconnection	0.00	0.000	0.000
45KTL-US(COM6-7)	6-7	Disconnection	0.00	0.000	0.000

7.8 Device Monitoring

7.8.1 Querying Device Status

The indicator in front of the device name indicates the current status of a device.

- If the indicator is , the inverter is in the **On-grid** state, the EMI, power meter, slave SmartLogger, or PLC module is in the **Online** state, and the PID module is the **Running** state.
- If the indicator is , the inverter, EMI, power meter, slave SmartLogger, PLC module, or PID module is in the **Disconnection** state.
- If the indicator is , the inverter is in the **Loading** state.
- If the indicator is , the inverter is in the **Initializing, Power-Off, Idle**, or any other state in which it does not feed power to the power grid.



NOTE

If a device is in the **Disconnection** state, its parameters cannot be set.

7.8.2 SmartLogger

7.8.2.1 Querying Master SmartLogger-Related Information

Choose **Monitoring > Logger(Local)** and query master SmartLogger-related information on the displayed page.

Figure 7-13 Querying master SmartLogger-related information

No.	Signal Name	Value	Unit
1	Energy yield of current day	0.00	kWh
2	Total energy yield	0.00	kWh
3	Reduced CO2 emission	0.00	kg
4	Input power	0.000	kW
5	Active power	0.000	kW
6	Reactive power	0.000	kVar
7	Power factor	0.000	
8	Inverter efficiency	0.00	%
9	DC current	0.0	A
10	Ia	0	A
11	Ib	0	A
12	Ic	0	A
13	Locked	Locked	
14	Max. value for reactive adjustment	0.0	kVar
15	Min. value for reactive adjustment	0.0	kVar
16	Max. value for active adjustment	0.0	kW
17	Remote scheduling (P)	NA	kW
18	Remote scheduling (Q)	NA	kVar
19	Remote scheduling (P)	NA	%
20	Remote scheduling (PF)	NA	
21	NetEco server	10.21.219.181	
22	NMS1 IP	NA	
23	NMS2 IP	NA	



NOTE

You can click a tab on the tertiary navigation menu to query master SmartLogger-related information.

7.8.2.2 Querying Slave SmartLogger-Related Information

Select a slave SmartLogger on the **Monitoring** tab page to query its information.

Figure 7-14 Querying slave SmartLogger-related information

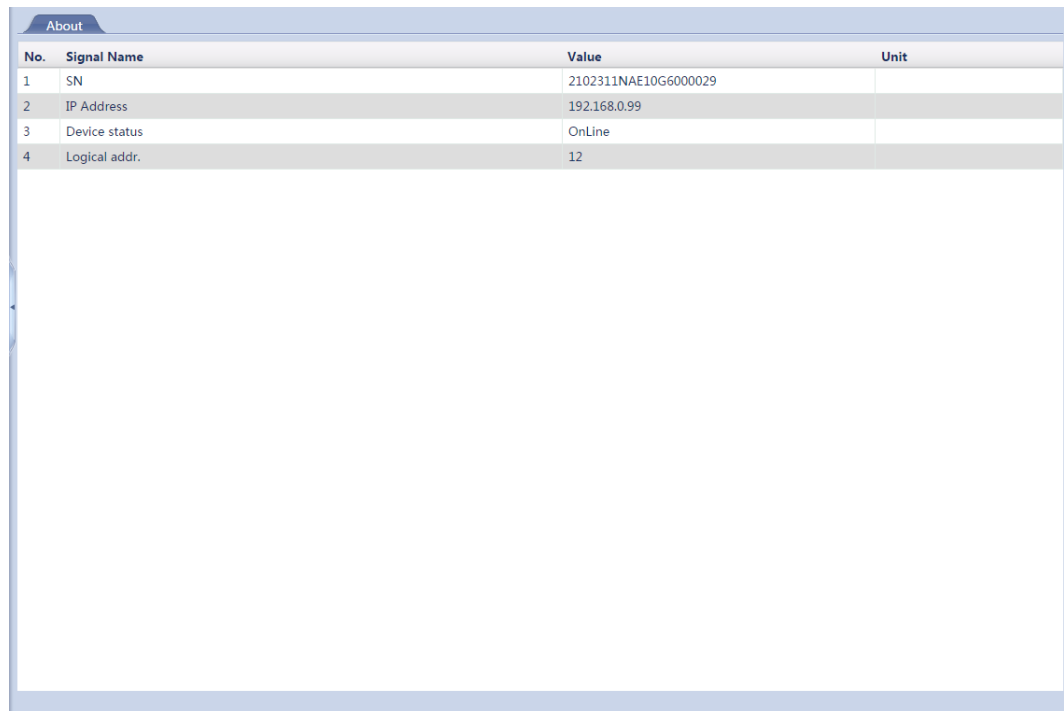

The screenshot shows a web interface with a tab labeled 'About'. Below the tab is a table with four columns: 'No.', 'Signal Name', 'Value', and 'Unit'. The table contains four rows of data:

No.	Signal Name	Value	Unit
1	SN	2102311NAE10G6000029	
2	IP Address	192.168.0.99	
3	Device status	OnLine	
4	Logical addr.	12	

7.8.3 Inverter

7.8.3.1 Querying Related Information

On the **Monitoring** tab page, select the inverter to be queried and access the query page to query related information.

Figure 7-15 Querying inverter-related information

No.	Signal Name	Value	Unit
1	Device status	Disconnection	
2	Rated power	36	kW
3	Energy yield of current day	0.00	kWh
4	Total energy yield	0.01	kWh
5	Reduced CO2 emission	0.00	kg
6	Input power	NA	kW
7	Active power	NA	kW
8	Reactive power	NA	kVar
9	Power factor	NA	
10	PV1/PV2/PV3/PV4/PV5/PV6 voltage	NA	V
11	PV1/PV2/PV3/PV4/PV5/PV6 current	NA	A
12	Grid A/B/C phase voltage	NA	V
13	Grid A/B/C phase current	NA	A
14	Grid frequency	NA	Hz
15	Cabinet temperature	NA	degC
16	Locking	NA	
17	Startup time	NA	
18	Shutdown time	NA	
19	Collect DSP data	NA	

NOTE

- You can click the , , , or tab on the tertiary navigation menu to query inverter-related information.
- You can click the Start, Stop, or Reset icon to send the corresponding command to the inverter. The login password is required if you need to send a command.

7.8.3.2 Setting Running Parameters (Advanced User)

Settings Page

Because of permission restriction, log in as **Advanced User**. Select the inverter to be set on the **Monitoring** page and click the **Running Param.** tab.

Figure 7-16 Running Param. (advanced user)

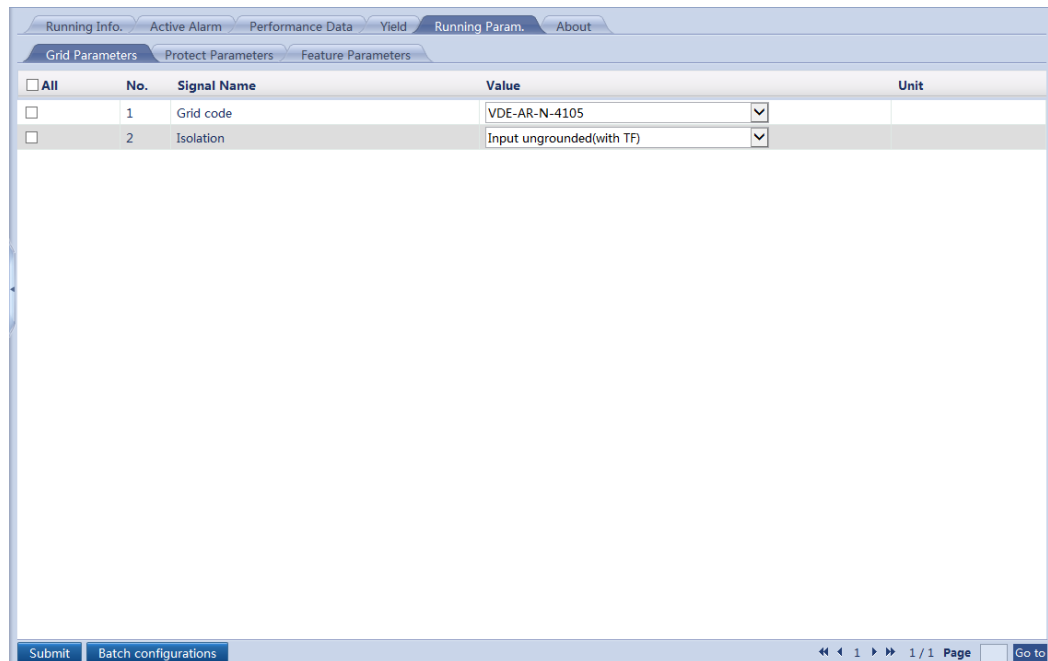

NOTICE

The parameter list provided in this document includes all configurable parameters. Configurable parameters vary with the device model and grid code. The actual screen prevails.

Grid Parameters

Table 7-3 Parameter description

No.	Parameter	Description	Value Range
1	Grid code	Set this parameter based on the grid code of the country or region where the inverter is used and the inverter application scenario.	N/A
2	Isolation	Specifies the inverter working mode based on the grounding status at the DC side and the connection to the power grid.	<ul style="list-style-type: none"> • Input grounded (with TF) • Input ungrounded (without TF) • Input ungrounded (with TF)

Protection Parameters

Table 7-4 Parameter description

No.	Parameter	Description	Unit	Value Range
1	Insulation resistance protection	To ensure device safety, the inverter detects the insulation resistance of the input side to the ground when it starts a self-check. If the detected value is less than the preset value, the inverter does not export power to the power grid.	MΩ	The value range for the 600 V inverter is [0.02, 1.5], that for the 1000 V inverter is [0.033, 1], and that for the 1100 V inverter is [0.033, 1.5].

Feature Parameters

Table 7-5 Parameter description

No.	Parameter	Description	Unit	Value Range	Remarks
1	MPPT multi-peak scanning	When the inverter is used in scenarios where PV strings are obviously shaded, enable this function. Then the inverter will perform MPPT scanning at regular intervals to locate the maximum power.	N/A	<ul style="list-style-type: none">• Disable• Enable	The scan interval is set through MPPT scanning interval .
2	MPPT scanning interval	Specifies the MPPT scan interval.	min	[5, 30]	This parameter is displayed only when MPPT multi-peak scanning is set to Enable .
3	RCD enhancing	RCD refers to the residual current of the inverter to the ground. To ensure device security and personal safety, RCD should comply with the standard. If an AC switch with a residual current detection function is installed outside the inverter, this function should be enabled to reduce the residual current generated during inverter running, thereby preventing the AC switch from misoperations.	N/A	<ul style="list-style-type: none">• Disable• Enable	N/A

No.	Parameter	Description	Unit	Value Range	Remarks
4	Reactive power output at night	In some specific application scenarios, a power grid company requires that the inverter can perform reactive power compensation at night to ensure that the power factor of the local power grid meets requirements.	N/A	<ul style="list-style-type: none">• Disable• Enable	For the inverters except the 600 V inverter, this parameter is available only when Isolation is set to Input ungrounded (with TF) .
5	Strong adaptability	If the value of power grid short circuit capacity/power plant installed capacity is less than 3 and the power grid impedance exceeds the upper threshold, the power grid quality will be affected and the inverter may be unable to run properly. Set Strong adaptability to Enable .	N/A	<ul style="list-style-type: none">• Disable• Enable	N/A
6	Power quality optimization mode	If Power quality optimization mode is set to Enable , the inverter output current harmonics will be optimized.	N/A	<ul style="list-style-type: none">• Disable• Enable	N/A

No.	Parameter	Description	Unit	Value Range	Remarks
7	PV module type	<p>This parameter is used to set different types of PV modules and the shutdown time of the concentration PV modules. If the concentration PV modules are shaded, the power drops drastically to 0 and the SUN2000 shuts down. The energy yield would be affected since it takes too long for the power to resume and SUN2000 to restart. The parameter does not need to be set for crystalline silicon and filmy PV modules.</p> <ul style="list-style-type: none"> • If PV module type is set to Crystalline silicon or Film, the SUN2000 automatically detects the power of PV modules when they are shaded and shuts down if the power is too low. • When the concentration PV modules are used: <ul style="list-style-type: none"> – If PV module type is set to CPV 1, the inverter can quickly restart in 60 minutes when the input power of PV modules drops drastically due to shading. – If PV module type is set to CPV 2, the inverter can quickly restart in 10 minutes when the input power of PV modules drops drastically due to shading. 	N/A	<ul style="list-style-type: none"> • Crystalline silicon • Film • CPV 1 • CPV 2 	N/A
8	Crystalline silicon PV compensation mode	<p>This parameter reduces the DC voltage of PV modules to the PE by reducing the impedance of the inverter input side to the PE, thereby effectively reducing PID effect of PV modules.</p>	N/A	<ul style="list-style-type: none"> • Output disabled • P-type output • N-type output 	<p>This parameter is displayed if PV module type is set to Crystalline silicon. Set this parameter to P-type output for P-type PV modules and N-type output for N-type PV modules.</p>

No.	Parameter	Description	Unit	Value Range	Remarks
9	Communication interrupt shutdown	The standards of certain countries and regions require that the inverter must shut down after the communication is interrupted for a certain time.	N/A	<ul style="list-style-type: none"> • Disable • Enable 	If Communication interrupt shutdown is set to Enable and the inverter communication has been interrupted for a specified time (set by Communication interruption duration), the inverter will automatically shut down.
10	Communication interruption duration	Specifies the duration for determining communication interruption, and is used for automatic shutdown for protection in case of communication interruption.	min	[1, 120]	N/A
11	Communication resumed startup	If this parameter is enabled, the inverter automatically starts after communication recovers. If this parameter is disabled, the inverter needs to be started manually after communication recovers.	N/A	<ul style="list-style-type: none"> • Disable • Enable 	For the 600 V inverter, this parameter is displayed when Communication interrupt shutdown is set to Enable .
12	Soft start time	Specifies the duration for the power to gradually increase when the inverter starts.	s	[20, 1800]	This parameter is set to 360 by default if the Australian AS4777 grid code is selected, to 300 by default if the Italian CEI0-21 or CEI0-16 grid code is selected, and to 600 by default if the Egyptian EGYPT grid code is selected.
13	AFCI	The North American standard requires the inverter to provide the DC arc detection function.	N/A	<ul style="list-style-type: none"> • Disable • Enable 	This parameter is supported by only the products marked -US . Arc detection adaptation mode and AFCI self-test are displayed only when AFCI is set to Enable .
14	Arc detection adaptation mode	Adjusts the sensitivity of arc detection.	N/A	<ul style="list-style-type: none"> • High • Moderate • Low 	
15	AFCI self-test	Send the AFCI self-test command manually.	N/A	N/A	

No.	Parameter	Description	Unit	Value Range	Remarks
16	Current error during scanning	When the IV curves of PV strings are being scanned, the current change of PV strings operating properly should be monitored to avoid inaccurate scanning caused by sunlight change. If the current exceeds the specified value, it is determined that the sunlight changes, and the IV curves should be scanned again.	A	[0.00, 2.00]	N/A
17	OVGR linked shutdown	If this parameter is set to Enable , the inverter shuts down after receiving the OVGR signal. If this parameter is set to Disable , the inverter does not shut down after receiving the OVGR signal.	N/A	<ul style="list-style-type: none"> • Disable • Enable 	This parameter is displayed after the Japanese grid code is selected.
18	Dry contact function	Identifies the dry contact signals from the SmartLogger.	N/A	<ul style="list-style-type: none"> • NC • OVGR 	Set this parameter to OVGR for OVGR signals, and set it to NC for other signals. This parameter is displayed after the Japanese grid code is selected.
19	Hibernate at night	The inverter monitors PV strings at night. If Hibernate at night is set to Enable , the monitoring function of the inverter will hibernate at night, reducing power consumption.	N/A	<ul style="list-style-type: none"> • Disable • Enable 	N/A
20	PLC communication	For inverter models that support both RS485 and PLC communication, when RS485 communication is used, you are advised to set PLC communication to Disable to reduce power consumption.	N/A	<ul style="list-style-type: none"> • Disable • Enable 	<ul style="list-style-type: none"> • If Tracker controller is set to a model, this parameter cannot be set to Enable. • If the inverter communicates with the SmartLogger over PLC, this parameter cannot be set to Enable on the WebUI.

No.	Parameter	Description	Unit	Value Range	Remarks
21	Upgrade delay	This parameter is mainly used in the upgrade scenarios where the PV power supply is disconnected at night due to no sunlight or unstable at dawn or dusk due to poor sunlight.	N/A	<ul style="list-style-type: none"> • Disable • Enable 	After the inverter upgrade starts, if Upgrade delay is set to Enable , the upgrade package is loaded first. After the PV power supply recovers and the activation conditions are met, the inverter automatically activates the upgrade.
22	String monitor	The inverter monitors PV strings in real time. If any PV string is abnormal (such as being shaded or with decreased energy yields), the inverter generates an alarm to remind maintenance personnel of timely maintenance.	N/A	<ul style="list-style-type: none"> • Disable • Enable 	If PV strings are easily shaded, you are advised to set String monitor to Disable to prevent false alarms.
23	String detection low power delay	Specifies the delay time for generating abnormal string alarms when the inverter detects that a PV string is working with low power. This parameter is mainly used in the scenario where PV strings are shaded for a long time in the morning and evening, and is used to prevent false alarms.	min	[2, 720]	This parameter is displayed when String monitor is set to Enable .
24	String detection high power delay	Specifies the delay time for generating abnormal string alarms when the inverter detects that a PV string is working with high power.	min	[2, 720]	
25	String detection power segment division percentage	Specifies the thresholds for determining whether a PV string is working with high power or low power. This parameter is used to distinguish the working status of PV strings.	%	[1, 100]	
26	String detection reference asymmetric coefficient	Specifies the threshold for determining PV string exception. The false alarms caused by fixed shadow shading can be controlled by changing this parameter.	N/A	<ul style="list-style-type: none"> • SUN2000-(8KTL-28 KTL): [0.05, 1] • Others: [5, 100] 	This parameter is displayed when String monitor is set to Enable .

No.	Parameter	Description	Unit	Value Range	Remarks
27	String detection starting power percentage	Specifies the threshold for starting PV string exception detection. The false alarms caused by fixed shadow shading can be controlled by changing this parameter.	%	[1, 100]	
28	Shutdown at 0% power limit	If this parameter is set to Enable , the inverter shuts down after receiving the 0% power limit command. If this parameter is set to Disable , the inverter does not shut down after receiving the 0% power limit instruction.	N/A	<ul style="list-style-type: none">• Disable• Enable	N/A
29	Maximum apparent power	Specifies the output upper threshold for the maximum apparent power to adapt to the capacity requirements for standard and customized transformers.	kVA	[Maximum active power, Smax_limit]	If the maximum active power equals Smax_limit, this parameter is not displayed.
30	Maximum active power	Specifies the output upper threshold for the maximum active power to adapt to various market requirements.	kW	[0.1, Pmax_limit]	For 1000 V inverters, this parameter is configurable only for the SUN2000-25KTL-US, and the maximum value is 27.5 kW.
31	Tracking system controller	Selects a controller vendor.	N/A	<ul style="list-style-type: none">• No tracking controller• Each controller vendor	N/A
32	Commanded shutdown hold after power recovery	The standards of certain countries and regions require that if the inverter is shut down based on a command and powers on again after power recovers, it should still be in commanded shutdown state.	N/A	<ul style="list-style-type: none">• Disable• Enable	N/A
33	Grounding abnormal shutdown	If this parameter is set to Enable , the inverter shuts down after receiving the grounding error signal. If this parameter is set to Disable , the inverter does not shut down after receiving the grounding error signal.	N/A	<ul style="list-style-type: none">• Disable• Enable	N/A

No.	Parameter	Description	Unit	Value Range	Remarks
34	String connection mode	<p>Specifies the connection mode of PV strings.</p> <ul style="list-style-type: none"> When the PV strings connect to the inverter separately (fully separate connection), there is no need to set this parameter. The inverter can automatically detect the connection mode of the PV strings. When the PV strings connect to one another in parallel outside the inverter and then connect to the inverter independently (fully parallel connection), set this parameter to All PV strings connected. 	N/A	<ul style="list-style-type: none"> Automatic detection All PV strings separated All PV strings connected 	N/A
35	PID protection at night	<ul style="list-style-type: none"> When PID protection at night is set to Enable, the SUN2000 will shut down automatically if it detects abnormality in PID voltage compensation during the reactive power compensation at night. When PID protection at night is set to Disable, the SUN2000 will operate in grid-tied mode if it detects abnormality in PID voltage compensation during the reactive power compensation at night. 	N/A	<ul style="list-style-type: none"> Disable Enable 	N/A
36	RS485-2 communication	<p>If this parameter is set to Enable, the RS485-2 port can be used. If the port is not used, it is recommended that this parameter be set to Disable to reduce power consumption.</p>	N/A	<ul style="list-style-type: none"> Disable Enable 	N/A

7.8.3.3 Setting Running Parameters (Special User)

Settings Page

Because of permission restriction, log in as **Special User**. Select the inverter to be set on the **Monitoring** page and click the **Running Param.** tab.

Figure 7-17 Running Param. (special user)

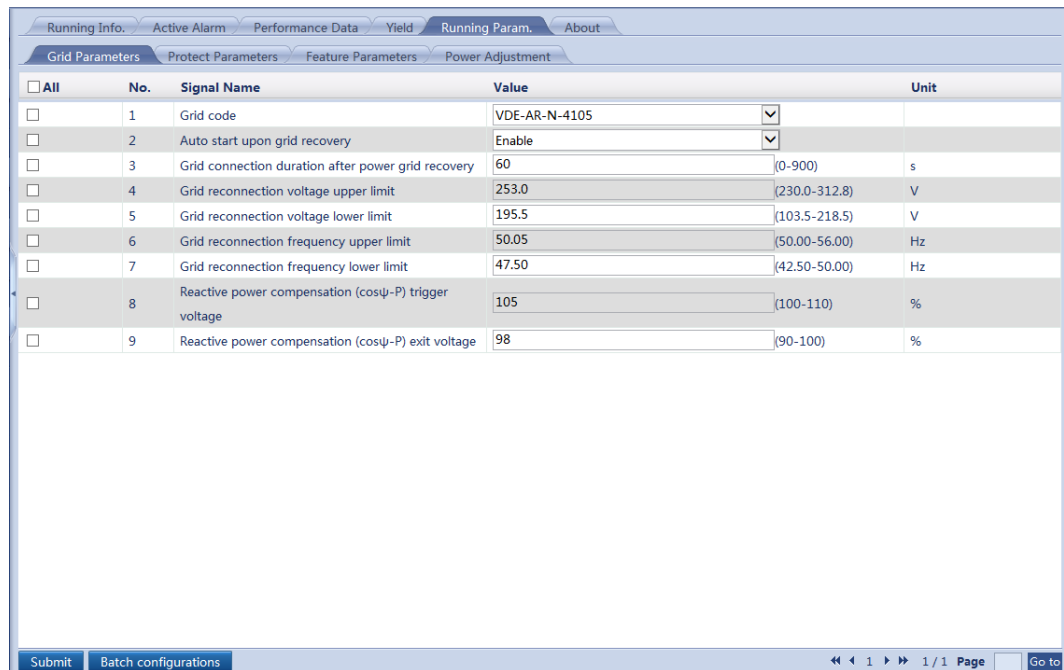

NOTICE

The parameter list provided in this document includes all configurable parameters. Configurable parameters vary with the device model and grid code. The actual screen prevails.

Grid Parameters

Table 7-6 Parameter description

No.	Parameter	Description	Unit	Value Range	Remarks
1	Grid code	Set this parameter based on the grid code of the country or region where the inverter is used and the inverter application scenario.	N/A	N/A	N/A
2	Output mode	Specifies whether the inverter has an output neutral wire based on the inverter application scenario.	N/A	<ul style="list-style-type: none"> Three-phase three-wire Three-phase four-wire 	This parameter is supported by the SUN2000-33KTL, SUN2000-33KTL-A, SUN2000-36KTL, SUN2000-50KTL-M0, SUN2000-60KTL-M0, and the inverters named with -US.

No.	Parameter	Description	Unit	Value Range	Remarks
3	PQ mode	If PQ mode 1 is selected, the maximum AC output power equals the maximum apparent power. If PQ mode 2 is selected, the maximum AC output power equals the rated output power.	N/A	<ul style="list-style-type: none"> SUN2000-36K TL: PQ mode 1 (Pmax = 40 kW), PQ mode 2 (Pmax = 36 kW) SUN2000-42K TL: PQ mode 1 (Pmax = 47 kW), PQ mode 2 (Pmax = 42 kW) SUN2000-50K TL-M0, SUN2000-60K TL-M0: PQ mode 1, PQ mode 2 	This parameter is supported by the SUN2000-36KTL, SUN2000-42KTL, SUN2000-50KTL-M0, and SUN2000-60KTL-M0.
4	Auto start upon grid recovery	Specifies whether to allow the inverter to automatically start after the power grid recovers.	N/A	<ul style="list-style-type: none"> Disable Enable 	This parameter is set to Disable by default if the Japanese grid code is selected.
5	Grid connection duration after power grid recovery	Specifies the waiting time for inverter restart after the power grid recovers.	s	[0, 900]	This parameter can be set to [150, 900] for the 1000 V and 1100 V inverters under the Japanese grid codes.
6	Grid reconnection voltage upper limit	The standards of certain countries and regions require that the inverter must not connect to the power grid when the power grid voltage is higher than the upper limit.	V	[100% Vn, 136% Vn]	In 1000 V inverters, the SUN2000-(8KTL-28K TL) does not support this parameter. Vn represents the rated voltage.
7	Grid reconnection voltage lower limit	The standards of certain countries and regions require that the inverter must not connect to the power grid when the power grid voltage is lower than the lower limit.	V	[45% Vn, 95% Vn]	

No.	Parameter	Description	Unit	Value Range	Remarks
8	Grid reconnection frequency upper limit	The standards of certain countries and regions require that the inverter must not connect to the power grid when the power grid frequency is higher than the upper limit.	Hz	[100%Fn, 112%Fn]	In 1000 V inverters, the SUN2000-(8KTL-28KTL) does not support this parameter. Fn represents the rated frequency.
9	Grid reconnection frequency lower limit	The standards of certain countries and regions require that the inverter must not connect to the power grid when the power grid frequency is lower than the lower limit.	Hz	[85%Fn, 100%Fn]	
10	Reactive power compensation (cosψ-P) trigger voltage	Specifies the voltage threshold for triggering reactive power compensation when LVRT occurs.	%	[100, 110]	N/A
11	Reactive power compensation (cosψ-P) exit voltage	Specifies the voltage threshold for exiting reactive power compensation when the inverter recovers from LVRT.	%	[90, 100]	N/A

Protection Parameters

Table 7-7 Parameter description

No.	Parameter	Description	Unit	Value Range	Remarks
1	Unbalance voltage protection	Specifies the inverter protection threshold in the case of unbalanced power grid voltage.	%	[0.0, 50.0]	N/A
2	Phase protection point	The Japanese standard requires that during passive islanding detection, protection should be triggered if an abrupt voltage phase change is detected.	°	[3, 15]	Configurable abruptly changed phase angles are 3°, 6°, 9°, 12°, and 15°, which are displayed after the Japanese grid code is selected.

No.	Parameter	Description	Unit	Value Range	Remarks
3	Phase angle offset protection	The standards of certain countries and regions require that the inverter needs to be protected when the three-phase angle offset of the power grid exceeds a certain value.	N/A	<ul style="list-style-type: none"> • Disable • Enable 	N/A
4	10 minute OV protection	Specifies the 10-minute overvoltage protection threshold.	V	[1 x Vn, 1.36 x Vn]	Vn represents the rated voltage.
5	10 minute OV protection time	Specifies the 10-minute overvoltage protection duration.	ms	<ul style="list-style-type: none"> • 1000 V inverter: [50, 600000] • Others: [50, 7200000] 	
6	Level-1 OV protection	Specifies the level-1 overvoltage protection threshold.	V	[1 x Vn, 1.36 x Vn]	Vn represents the rated voltage.
7	Level-1 OV protection time	Specifies the level-1 overvoltage protection duration.	ms	<ul style="list-style-type: none"> • 1000 V inverter: [50, 600000] • Others: [50, 7200000] 	
8	Level-2 OV protection	Specifies the level-2 overvoltage protection threshold.	V	<ul style="list-style-type: none"> • SUN2000-65KTL-C1 /70KTL-C1: [1 x Vn, 1.5 x Vn] • Others: [1 x Vn, 1.36 x Vn] 	Vn represents the rated voltage.
9	Level-2 OV protection time	Specifies the level-2 overvoltage protection duration.	ms	<ul style="list-style-type: none"> • 1000 V inverter: [50, 600000] • Others: [50, 7200000] 	
10	Level-1 UV protection	Specifies the level-1 undervoltage protection threshold.	V	[0.15 x Vn, 1 x Vn]	Vn represents the rated voltage.
11	Level-1 UV protection time	Specifies the level-1 undervoltage protection duration.	ms	<ul style="list-style-type: none"> • 1000 V inverter: [50, 600000] • Others: [50, 7200000] 	
12	Level-2 UV protection	Specifies the level-2 undervoltage protection threshold.	V	[0.15 x Vn, 1 x Vn]	Vn represents the rated voltage.
13	Level-2 UV protection time	Specifies the level-2 undervoltage protection duration.	ms	<ul style="list-style-type: none"> • 1000 V inverter: [50, 600000] • Others: [50, 7200000] 	

No.	Parameter	Description	Unit	Value Range	Remarks
14	Level-1 OF protection	Specifies the level-1 overfrequency protection threshold.	Hz	[1 x Fn, 1.15 x Fn]	Fn represents the rated frequency.
15	Level-1 OF protection time	Specifies the level-1 overfrequency protection duration.	ms	<ul style="list-style-type: none"> 1000 V inverter: [50, 600000] Others: [50, 7200000] 	
16	Level-2 OF protection	Specifies the level-2 overfrequency protection threshold.	Hz	[1 x Fn, 1.15 x Fn]	Fn represents the rated frequency.
17	Level-2 OF protection time	Specifies the level-2 overfrequency protection duration.	ms	<ul style="list-style-type: none"> 1000 V inverter: [50, 600000] Others: [50, 7200000] 	
18	Level-1 UF protection	Specifies the level-1 underfrequency protection threshold.	Hz	[0.85 x Fn, 1 x Fn]	Fn represents the rated frequency.
19	Level-1 UF protection time	Specifies the level-1 underfrequency protection duration.	ms	[50, 7200000]	
20	Level-2 UF protection	Specifies the level-2 underfrequency protection threshold.	Hz	[0.85 x Fn, 1 x Fn]	Fn represents the rated frequency.
21	Level-2 UF protection time	Specifies the level-2 underfrequency protection duration.	ms	<ul style="list-style-type: none"> 1000 V inverter: [50, 600000] Others: [50, 7200000] 	
22	Level-3 OV protection	Specifies the level-3 overvoltage protection threshold.	V	<ul style="list-style-type: none"> SUN2000-65KTL-C1 /70KTL-C1: [1 x Vn, 1.5 x Vn] Others: [1 x Vn, 1.36 x Vn] 	<ul style="list-style-type: none"> In 1000 V inverters, only the inverters marked "-US" support this parameter. Vn represents the rated voltage.
23	Level-3 OV protection time	Specifies the level-3 overvoltage protection duration.	ms	<ul style="list-style-type: none"> 1000 V inverter: [50, 600000] Others: [50, 7200000] 	
24	Level-4 OV protection	Specifies the level-4 overvoltage protection threshold.	V	<ul style="list-style-type: none"> SUN2000-65KTL-C1 /70KTL-C1: [1 x Vn, 1.5 x Vn] Others: [1 x Vn, 1.36 x Vn] 	<ul style="list-style-type: none"> In 1000 V inverters, only the inverters marked "-US" support this parameter. Vn represents the rated voltage.
25	Level-4 OV protection time	Specifies the level-4 overvoltage protection duration.	ms	<ul style="list-style-type: none"> 1000 V inverter: [50, 600000] Others: [50, 7200000] 	

No.	Parameter	Description	Unit	Value Range	Remarks
26	Level-3 UV protection	Specifies the level-3 undervoltage protection threshold.	V	[0.15 x Vn, 1 x Vn]	<ul style="list-style-type: none"> In 1000 V inverters, only the inverters marked "-US" support this parameter. Vn represents the rated voltage.
27	Level-3 UV protection time	Specifies the level-3 undervoltage protection duration.	ms	<ul style="list-style-type: none"> 1000 V inverter: [50, 600000] Others: [50, 7200000] 	
28	Level-4 UV protection	Specifies the level-4 undervoltage protection threshold.	V	[0.15 x Vn, 1 x Vn]	<ul style="list-style-type: none"> In 1000 V inverters, only the inverters marked "-US" support this parameter. Vn represents the rated voltage.
29	Level-4 UV protection time	Specifies the level-4 undervoltage protection duration.	ms	<ul style="list-style-type: none"> 1000 V inverter: [50, 600000] Others: [50, 7200000] 	
30	Level-5 OV protection	Specifies the level-5 overvoltage protection threshold.	V	[1 x Vn, 1.5 x Vn]	Vn represents the rated voltage.
31	Level-5 OV protection time	Specifies the level-5 overvoltage protection duration.	ms	[50, 7200000]	
32	Level-6 OV protection	Specifies the level-6 overvoltage protection threshold.	V	[1 x Vn, 1.5 x Vn]	Vn represents the rated voltage.
33	Level-5 OV protection time	Specifies the level-6 overvoltage protection duration.	ms	[50, 7200000]	
34	Level-5 UV protection	Specifies the level-5 undervoltage protection threshold.	V	[0.15 x Vn, 1 x Vn]	Vn represents the rated voltage.
35	Level-5 UV protection time	Specifies the level-5 undervoltage protection duration.	ms	[50, 7200000]	
36	Level-6 UV protection	Specifies the level-6 undervoltage protection threshold.	V	[0.15 x Vn, 1 x Vn]	Vn represents the rated voltage.
37	Level-6 UV protection time	Specifies the level-6 undervoltage protection duration.	ms	[50, 7200000]	
38	Level-3 OF protection	Specifies the level-3 overfrequency protection threshold.	Hz	[1 x Fn, 1.15 x Fn]	Fn represents the rated frequency.

No.	Parameter	Description	Unit	Value Range	Remarks
39	Level-3 OF protection time	Specifies the level-3 overfrequency protection duration.	ms	[50, 7200000]	
40	Level-4 OF protection	Specifies the level-4 overfrequency protection threshold.	Hz	[1 x Fn, 1.15 x Fn]	Fn represents the rated frequency.
41	Level-4 OF protection time	Specifies the level-4 overfrequency protection duration.	ms	[50, 7200000]	
42	Level-5 OF protection	Specifies the level-5 overfrequency protection threshold.	Hz	[1 x Fn, 1.15 x Fn]	Fn represents the rated frequency.
43	Level-5 OF protection time	Specifies the level-5 overfrequency protection duration.	ms	[50, 7200000]	
44	Level-6 OF protection	Specifies the level-6 overfrequency protection threshold.	Hz	[1 x Fn, 1.15 x Fn]	Fn represents the rated frequency.
45	Level-6 OF protection time	Specifies the level-6 overfrequency protection duration.	ms	[50, 7200000]	
46	Level-3 UF protection	Specifies the level-3 underfrequency protection threshold.	Hz	[0.85 x Fn, 1 x Fn]	Fn represents the rated frequency.
47	Level-3 UF protection time	Specifies the level-3 underfrequency protection duration.	ms	[50, 7200000]	
48	Level-4 UF protection	Specifies the level-4 underfrequency protection threshold.	Hz	[0.85 x Fn, 1 x Fn]	Fn represents the rated frequency.
49	Level-4 UF protection time	Specifies the level-4 underfrequency protection duration.	ms	[50, 7200000]	
50	Level-5 UF protection	Specifies the level-5 underfrequency protection threshold.	Hz	[0.85 x Fn, 1 x Fn]	Fn represents the rated frequency.
51	Level-5 UF protection time	Specifies the level-5 underfrequency protection duration.	ms	[50, 7200000]	
52	Level-6 UF protection	Specifies the level-6 underfrequency protection threshold.	Hz	[0.85 x Fn, 1 x Fn]	Fn represents the rated frequency.

No.	Parameter	Description	Unit	Value Range	Remarks
53	Level-6 UF protection time	Specifies the level-6 underfrequency protection duration.	ms	[50, 7200000]	
54	Overfrequency protection threshold	Specifies the grid overfrequency protection threshold.	Hz	<ul style="list-style-type: none"> 50 Hz: 50.5 Hz, 51.0 Hz, 51.5 Hz, and 52.0 Hz 60 Hz: 60.6 Hz, 61.2 Hz, 61.8 Hz, and 62.4 Hz 	N/A
55	Overfrequency protection duration	Specifies the grid overfrequency protection duration.	s	0.5s, 1.0s, 1.5s, and 2.0s	N/A
56	Underfrequency protection threshold	Specifies the grid underfrequency protection threshold.	Hz	<ul style="list-style-type: none"> 50 Hz: 49.5 Hz, 49.0 Hz, 48.5 Hz, 48.0 Hz, 47.5 Hz, and 47.0 Hz 60 Hz: 59.6 Hz, 59.0 Hz, 58.4 Hz, 57.8 Hz, and 57.2 Hz 	N/A
57	Underfrequency protection duration	Specifies the grid underfrequency protection duration.	s	0.5s, 1.0s, 1.5s, and 2.0s	N/A
58	AC overvoltage protection threshold	Specifies the grid overvoltage protection threshold.	V	110.0 V, 112.5 V, 115.0 V, and 120.0 V	N/A
59	AC overvoltage protection duration	Specifies the grid overvoltage protection duration.	s	0.5s, 1.0s, 1.5s, and 2.0s	N/A
60	AC undervoltage protection threshold	Specifies the grid undervoltage protection threshold.	V	80.0 V, 82.5 V, 85.0 V, 87.5 V, and 90.0 V	N/A
61	AC undervolt	Specifies the grid undervoltage protection duration.	s	0.5s, 1.0s, 1.5s, and 2.0s	N/A
62	AC overvoltage protection enable	Specifies the level-1 overvoltage protection.	N/A	<ul style="list-style-type: none"> Disable Enable 	N/A

No.	Parameter	Description	Unit	Value Range	Remarks
63	FRT	When the power grid voltage is abnormally low for a short time, the inverter cannot disconnect from the power grid immediately and has to work for some time. This is called LVRT.	N/A	<ul style="list-style-type: none"> • Disable • Enable 	N/A
64	Active islanding protection enable	Specifies whether to enable the active islanding protection function.	N/A	<ul style="list-style-type: none"> • Disable • Enable 	N/A
65	Passive islanding protection enable	Specifies whether to enable the passive islanding protection function.	N/A	<ul style="list-style-type: none"> • Disable • Enable 	N/A
66	Voltage phase jump detection value for passive islanding	The Japanese standard requires that during passive islanding detection, protection should be triggered if an abrupt voltage phase change is detected.	°	3°, 6°, 9°, 12°, and 15°	N/A
67	Frequency feedback module	Refers to a control module that calculates the reactive power based on the offset deviation of grid frequency and promotes frequency offset when islanding occurs.	N/A	<ul style="list-style-type: none"> • Disable • Enable 	N/A
68	Step injection module	Refers to a control module that injects step reactive power to promote frequency offset when the offset deviation of grid voltage and frequency is very small. When islanding occurs, the inverter and load reaches balance.	N/A	<ul style="list-style-type: none"> • Disable • Enable 	N/A
69	Frequency feedback module K1 value	Specifies level-1 gain of the frequency feedback module.	N/A	[0, 100]	N/A

No.	Parameter	Description	Unit	Value Range	Remarks
70	Frequency feedback module K2 value	Specifies level-2 gain of the frequency feedback module.	N/A	[0, 100]	N/A
71	Restart mode after grid failure	Specifies how the inverter restarts after a grid fault is rectified.	N/A	<ul style="list-style-type: none">ManualAutomatic	N/A
72	Restart duration after grid failure	Specifies the delay before restart after a grid fault is rectified.	s	6s, 150s, 180s, 240s, and 300s	N/A
73	System soft start time	Specifies the duration for the power to gradually increase when the inverter starts.	s	[20, 800]	N/A
74	Voltage rise suppression	The Japanese standard requires that the inverter should control the active power and reactive power when the output voltage exceeds a certain value to ensure the grid voltage stability.	N/A	<ul style="list-style-type: none">DisableEnable	N/A
75	Voltage rise suppression reactive adjustment point	The Japanese standard requires that the inverter should adjust the reactive power to prevent the grid voltage from rising when the output voltage exceeds a certain value.	V	107.0 V, 107.5 V, 108.0 V, 108.5 V, 109.0 V, 109.5 V, 110.0 V, 110.5 V, 111.0 V, 111.5 V, 112.0 V, and 112.5 V	N/A

No.	Parameter	Description	Unit	Value Range	Remarks
76	Voltage rise suppression active derating point	The Japanese standard requires that the inverter should derate the active power to prevent the grid voltage from rising when the output voltage exceeds a certain value.	V	109.0 V, 109.5 V, 110.0 V, 110.5 V, 111.0 V, 111.5 V, 112.0 V, 112.5 V, 113.0 V, 113.5 V, 114.0 V, and 114.5 V	<ul style="list-style-type: none"> The parameter value is automatically displayed after Voltage rise suppression reactive adjustment point is set. The value of Voltage rise suppression active derating point must be greater than that of Voltage rise suppression reactive adjustment point.

Feature Parameters

Table 7-8 Parameter description

No.	Parameter	Description	Unit	Value Range	Remarks
1	LVRT	When the power grid voltage is abnormally low for a short time, the inverter cannot disconnect from the power grid immediately and has to work for some time. This is called LVRT.	N/A	<ul style="list-style-type: none"> Disable Enable 	This parameter is set to Enable by default if the German BDEW-MV grid code is selected.
2	LVRT threshold	Specifies the threshold for triggering LVRT.	V	[50% Vn, 92% Vn]	<p>This parameter is displayed when LVRT is set to Enable.</p> <p>In 1000 V inverters, the SUN2000-(8KTL-28K TL) does not support this parameter.</p> <p>Vn represents the rated voltage.</p>

No.	Parameter	Description	Unit	Value Range	Remarks
3	LVRT undervoltage protection shield	Specifies whether to shield the undervoltage protection function during LVRT.	N/A	<ul style="list-style-type: none">• Disable• Enable	This parameter is displayed when LVRT is set to Enable .
4	LVRT reactive power compensation power factor	During LVRT, the inverter needs to generate reactive power to support the power grid. This parameter is used to set the reactive power generated by the inverter.	N/A	[0, 3]	This parameter is displayed when LVRT is set to Enable . This parameter is set to 2.5 by default if the South African grid code is selected. For example, if you set LVRT reactive power compensation power factor to 2 , the reactive power generated by the inverter is 20% of the rated power when the AC voltage drops by 10% during LVRT.
5	HVRT	When the power grid voltage is abnormally high for a short time, the inverter cannot disconnect from the power grid immediately and has to work for some time. This is called HVRT.	N/A	<ul style="list-style-type: none">• Disable• Enable	N/A
6	HVRT triggering threshold	Specifies the threshold for triggering the HVRT. The threshold settings should meet the local grid standard.		[105% Vn, 130% Vn]	This parameter is displayed when HVRT is set to Enable .
7	Active islanding	Specifies whether to enable the active islanding protection function.	N/A	<ul style="list-style-type: none">• Disable• Enable	N/A
8	Passive islanding	Specifies whether to enable the passive islanding protection function.	N/A	<ul style="list-style-type: none">• Disable• Enable	This parameter is displayed after the Japanese grid code is selected.

No.	Parameter	Description	Unit	Value Range	Remarks
9	Voltage rise suppression	The standards of certain countries and regions require that the active power of the inverter be derated according to a certain gradient when the output voltage exceeds a certain value.	N/A	<ul style="list-style-type: none"> • Disable • Enable 	This parameter is set to Enable by default if the Italian grid code CEIO-16 is selected.
10	Voltage rise suppression reactive adjustment point	The standards of certain countries and regions require that the inverter must generate a certain amount of reactive power when the output voltage exceeds a certain value.	%	[100, 115]	<ul style="list-style-type: none"> • This parameter is displayed when Voltage rise suppression is set to Enable. • The value of Voltage rise suppression active derating point must be greater than that of Voltage rise suppression reactive adjustment point.
11	Voltage rise suppression active derating point	The standards of certain countries and regions require that the active power of the inverter be derated according to a certain gradient when the output voltage exceeds a certain value.	%	[100, 115]	
12	Frequency change rate protection	The inverter triggers protection when the power grid frequency changes too fast.	N/A	<ul style="list-style-type: none"> • Disable • Enable 	N/A
13	Frequency change rate protection point	Specifies the frequency change rate protection threshold.	Hz/s	<ul style="list-style-type: none"> • 1000 V inverter: [0.1, 2.5] • Others: [0.1, 5] 	This parameter is displayed if Frequency change rate protection is set to Enable .
14	Frequency change rate protection time	Specifies the frequency change rate protection duration.	s	[0.2, 20.0]	
15	Soft start time after grid failure	Specifies the time for the power to gradually increase when the inverter restarts after the power grid recovers.	s	[20, 800]	This parameter is set to 360 by default if the Australian AS4777 grid code is selected, and to 300 by default if the Brazilian ABNT NBR 16149 or South African SA_RPPs grid code is selected.

Power Adjustment Parameters

Table 7-9 Parameter description

No.	Parameter	Description	Unit	Value Range	Remarks
1	Active power change gradient	Adjusts the change speed of the inverter active power.	%/s	<ul style="list-style-type: none"> 1000 V inverter: [0.1, 50] Others: [0.1, 1000] 	N/A
2	Fixed active power derated	Adjusts the active power output of the inverter in fixed values.	<ul style="list-style-type: none"> 600 V inverter: W Others: kW 	<ul style="list-style-type: none"> 1000 V inverter: [0, Pmax] Others: [0, Pmax_limit] 	<p>Pmax represents the maximum active power.</p> <p>In the 1000 V inverter, the upper threshold for the SUN2000-25KTL-US is 27.5 kW, and the upper threshold for other models of inverters is Pmax.</p>
3	Active power percentage derating	Adjusts the active power output of the inverter in percentages.	%	[0, 100]	If this parameter is set to 100 , the inverter delivers the maximum output power.
4	Reactive power change gradient	Adjusts the change speed of the inverter reactive power.	%/s	[0.1, 1000]	N/A
5	Power factor	Adjusts the power factor of the inverter.	N/A	(-1.000, -0.800]U[0.800, 1.000]	N/A
7	Overfrequency derating	If this parameter is enabled, the active power of the inverter will be derated according to a certain slope when the grid frequency exceeds the value that triggers overfrequency derating.	N/A	<ul style="list-style-type: none"> Disable Enable 	N/A
8	Trigger frequency of over frequency derating	The standards of certain countries and regions require that the output active power of the inverter should be derated when the power grid frequency exceeds a certain value.	Hz	<p>When the output frequency is 50 Hz, the value range is [45.00, 55.00].</p> <p>When the output frequency is 60 Hz, the value range is [55.00, 65.00].</p>	<ul style="list-style-type: none"> This parameter is for the inverters except the 1000 V ones. It is displayed when Overfrequency derating is set to Enable.

No.	Parameter	Description	Unit	Value Range	Remarks
9	Quit frequency of over frequency derating	Specifies the frequency threshold for exiting overfrequency derating.	Hz	When the output frequency is 50 Hz, the value range is [45.00, 55.00]. When the output frequency is 60 Hz, the value range is [55.00, 65.00].	<ul style="list-style-type: none"> The parameter setting should meet the following condition: Quit frequency of over frequency derating \leq Trigger frequency of over frequency derating $<$ Cutoff frequency of overfrequency derating.
10	Cutoff frequency of overfrequency derating	Specifies the frequency threshold for cutting off overfrequency derating.	Hz	When the output frequency is 50 Hz, the value range is [45.00, 55.00]. When the output frequency is 60 Hz, the value range is [55.00, 65.00].	<ul style="list-style-type: none"> This parameter is displayed when Overfrequency derating is set to Enable. The parameter setting should meet the following condition: Quit frequency of over frequency derating \leq Trigger frequency of over frequency derating $<$ Cutoff frequency of overfrequency derating.
11	Cutoff power of overfrequency derating	Specifies the power threshold for cutting off overfrequency derating.	%	[5, 20]	<ul style="list-style-type: none"> The parameter setting should meet the following condition: Quit frequency of over frequency derating \leq Trigger frequency of over frequency derating $<$ Cutoff frequency of overfrequency derating.
12	Power recovery gradient of overfrequency derating	Specifies the power recovery gradient for overfrequency derating.	%/min	[5, 20]	This parameter is set to 16 by default if the Australian AS4777 grid code is selected, and to 15 by default if the Italian CEIO-21 or CEIO-16 grid code is selected.

No.	Parameter	Description	Unit	Value Range	Remarks
13	Remote power schedule	If this parameter is set to Enable , the inverter responds to the scheduling instruction from the remote port. If this parameter is set to Disable , the inverter does not respond to the scheduling instruction from the remote port.	N/A	<ul style="list-style-type: none">• Disable• Enable	N/A
14	Schedule instruction valid duration	Adjusts the duration within which the scheduling instruction is valid.	s	[0, 86400]	If this parameter is set to 0 , the instruction is valid permanently.
15	Maximum apparent power	Specifies the output upper threshold for the maximum apparent power to adapt to the capacity requirements for standard and customized inverters.	kVA	[Maximum active power, Smax_limit]	If the maximum active power equals Smax_limit, this parameter is not displayed.
16	Maximum active power	Specifies the output upper threshold for the maximum active power to adapt to various market requirements.	kW	[0.1, Pmax_limit]	N/A
17	Shutdown at 0% power limit	If this parameter is set to Enable , the inverter shuts down after receiving the 0% power limit instruction. If this parameter is set to Disable , the inverter does not shut down after receiving the 0% power limit instruction.	N/A	<ul style="list-style-type: none">• Disable• Enable	N/A
18	Reactive power compensation (Q/S)	Adjusts the inverter output reactive power.	N/A	(-1.000, 1.000]	N/A
19	Reactive power compensation (PF)	Adjusts the power factor of the inverter.	N/A	(-1.000, -0.800]U[0.800, 1.000]	N/A

7.8.3.4 Setting a Tracking System

If a PV string uses a tracking system with controllers, you can set parameters for the tracking system over the WebUI.

 **NOTE**

- The parameters vary depending on the controller manufacturer. Set parameters based on site requirements.
- This function applies only to the 1100 V SUN2000.

Because of permission restriction, log in as **Advanced User**. Choose **Monitoring > SUN2000 > Tracking System** to access the target page.

Figure 7-18 Setting a tracking system

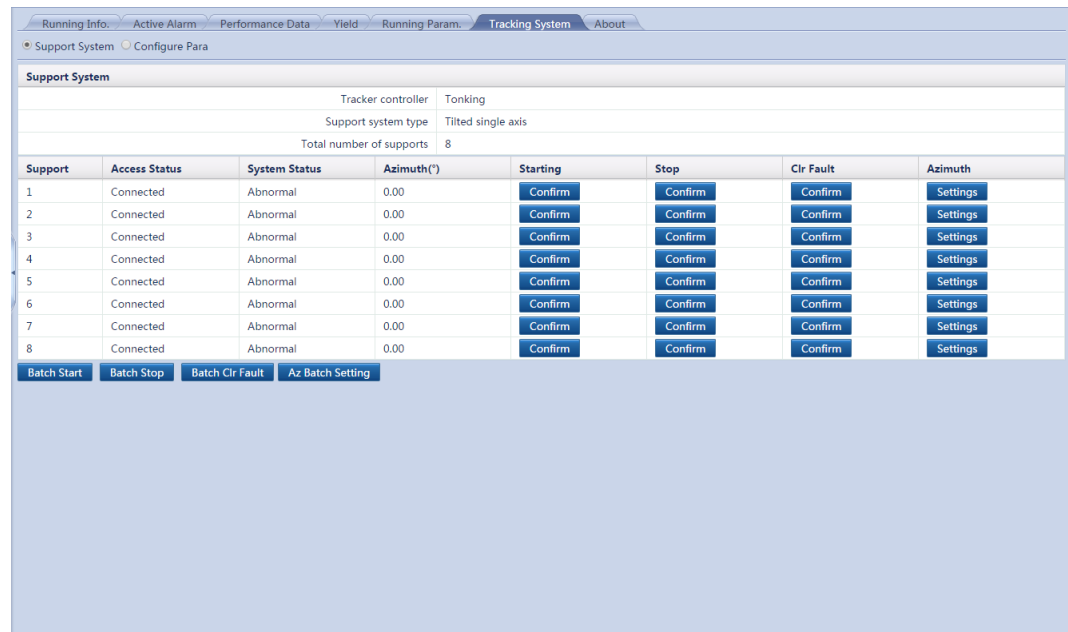

 **NOTE**

You can click the Select icon in the upper left corner of the page to select a setting page.

7.8.3.5 Setting the LVRT Characteristic Curve

 **NOTE**

Only the 1100 V SUN2000 supports the LVRT characteristic curve, and other models of SUN2000s do not have this function.

Because of permission restriction, log in as **Special User**. Choose **Monitoring > SUN2000 > LVRT Characteristic Curve** and set the characteristic curve on the displayed page.

Figure 7-19 Setting the LVRT characteristic curve

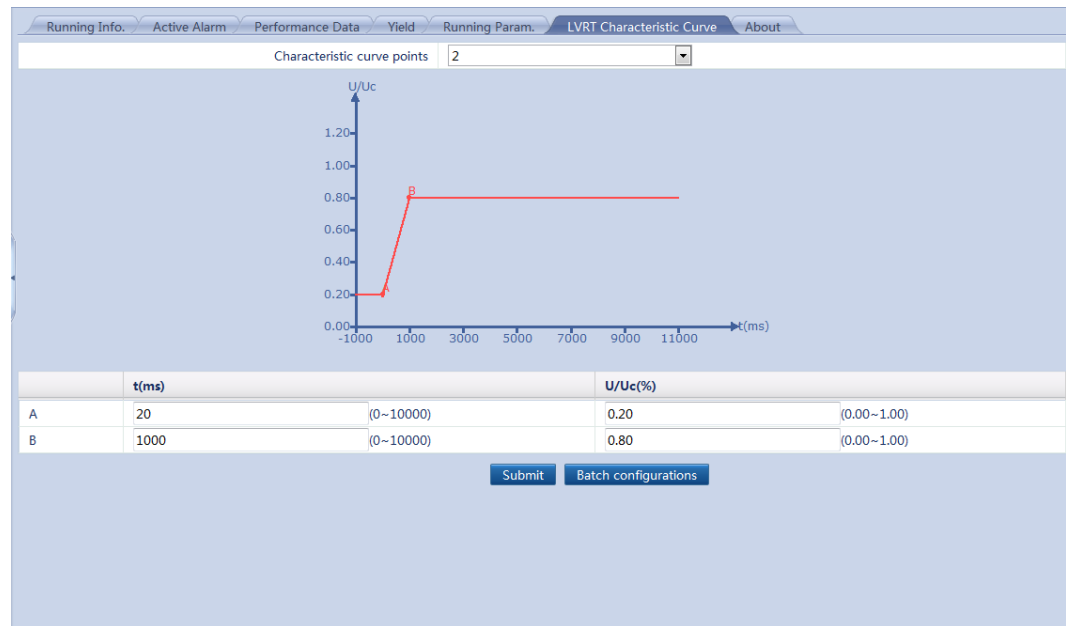

NOTE

After you set the LVRT characteristic curve for one SUN2000, click **Batch configurations** to synchronize the LVRT characteristic curve settings to other SUN2000s.

7.8.4 PLC

The SmartLogger is integrated with the PLC CCO and connected to the SUN2000 that supports the PLC function over an AC power cable. Data is transmitted over the power cable to implement PLC networking.

7.8.4.1 Querying Related Information

Choose **Monitoring > PLC** and query related information on the displayed page.

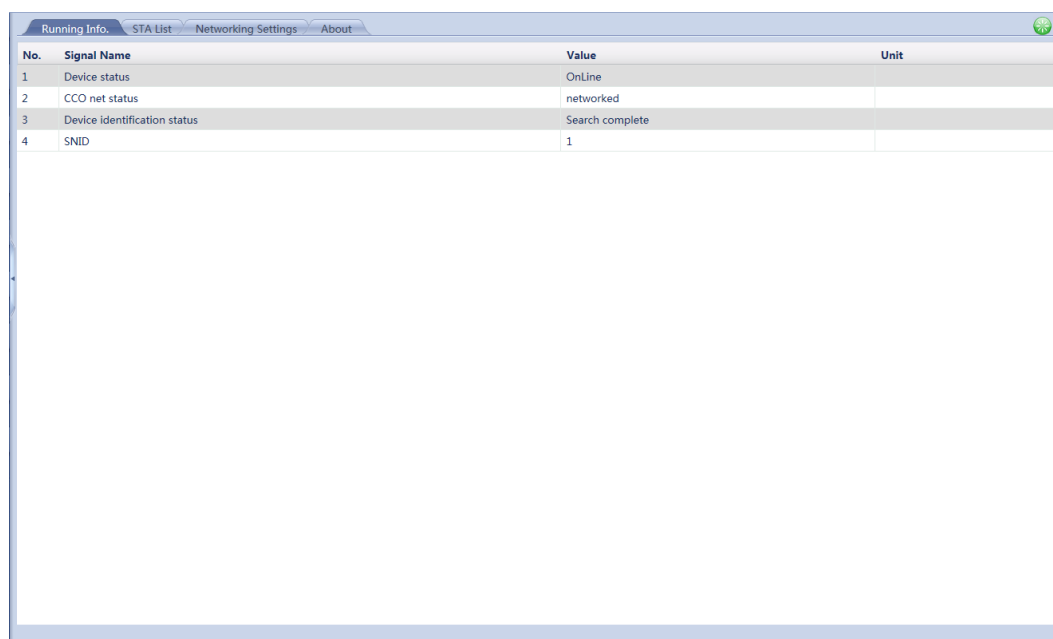
Figure 7-20 Querying PLC-related information

The screenshot shows the 'Running Info.' tab in the SmartLogger1000 WebUI. The table displays the following data:

No.	Signal Name	Value	Unit
1	Device status	OnLine	
2	CCO net status	networked	
3	Device identification status	Search complete	
4	SNID	1	

NOTE

You can click the **Running Info.** or **About** tab on the tertiary navigation menu to query PLC-related information.

7.8.4.2 Setting the STA List

Because of permission restriction, log in as **Advanced User**. Choose **Monitoring > PLC > STA List** and set **Baud rate** for the listed devices on the displayed page.

Figure 7-21 Setting the STA list

No.	MAC Address	Device	SN	Comm Address	Baud rate
1	2c:d7:d7:2f:b2:01	40KTL(COM3-1)	INV_2000V2R1C00_0001	1	115200
2	2c:d7:d7:2f:b2:02	40KTL(COM3-2)	INV_2000V2R1C00_0002	2	115200
3	2c:d7:d7:2f:b2:03	40KTL(COM3-3)	INV_2000V2R1C00_0003	3	115200



NOTE

- The STA list displays information about the SUN2000 equipped with the PLC STA module that is being connected.
- When changing the name of the exported file after the STA list is exported, retain the extension **.tar.gz**. Otherwise, the file will be unusable.

7.8.4.3 Networking Settings

Because of permission restriction, log in as **Advanced User**. Choose **Monitoring > PLC > Networking Settings**.

Running parameters

Figure 7-22 Running parameters

<input type="checkbox"/> All	No.	Signal Name	Value	Unit
<input type="checkbox"/>	1	Baud rate	9600	
<input type="checkbox"/>	2	Anti-crosstalk	Disable	
<input type="checkbox"/>	3	Network frequency band	2-12 (MHz)	
<input type="checkbox"/>	4	Box-type transformer No.	0	(0-511)
<input type="checkbox"/>	5	Winding No.	0	(0-7)

NOTE

- **Baud rate** is set to **115200** by default, which provides optimal communications performance and does not need to be changed.
- If **Anti-crosstalk** is set to **Enable**, the inverter with a PLC STA in the SN list can access networking.
- Parameters **Box-type transformer No.** and **Winding No.** can be set for the PLC CCO with SUN2000 V100R001C72SPC100 or later versions. In multi-split transformer scenarios, specify **Winding No.** based on the actual winding number of the SmartLogger connected to the transformer. When the box-type transformer and winding numbers of the inverter with an STA are consistent with those of the PLC CCO, the inverter can access networking.

SN List

Figure 7-23 SN list

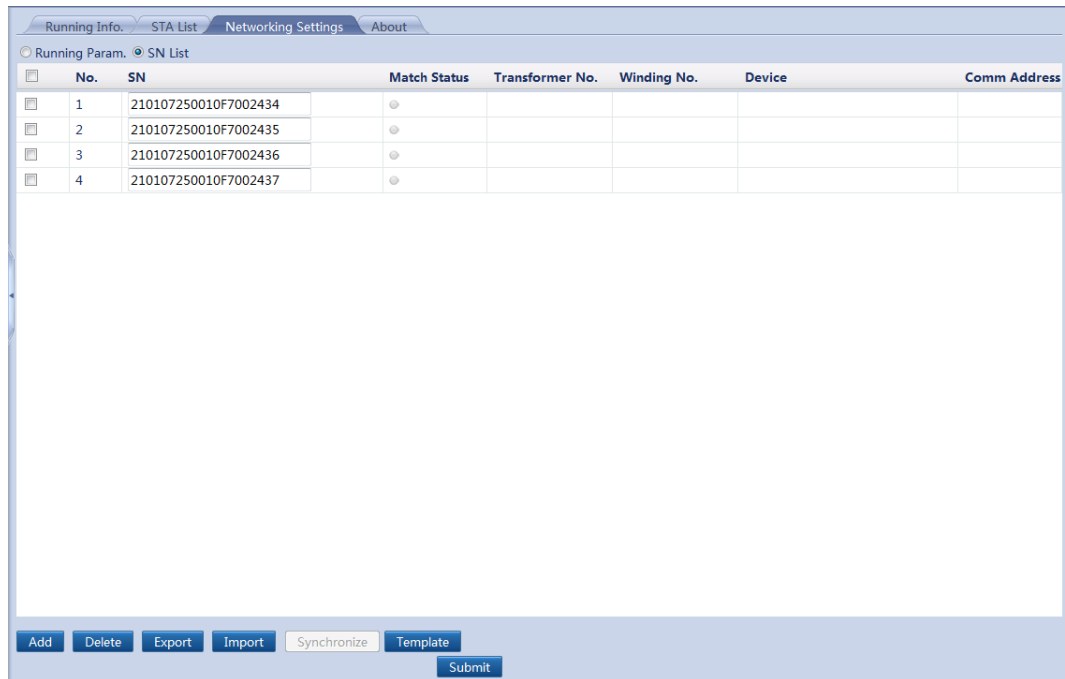

No.	SN	Match Status	Transformer No.	Winding No.	Device	Comm Address
1	210107250010F7002434	●				
2	210107250010F7002435	●				
3	210107250010F7002436	●				
4	210107250010F7002437	●				



NOTE

- The SN list displays the relevant information of the inverters with PLC STAs that can be connected.
- Tap **Synchronize**, and synchronize the box-type transformer and winding numbers of the PLC CCO to the inverter.

7.8.5 EMI

7.8.5.1 Querying Related Information

Choose **Monitoring** > **EMI** and query related information on the displayed page.

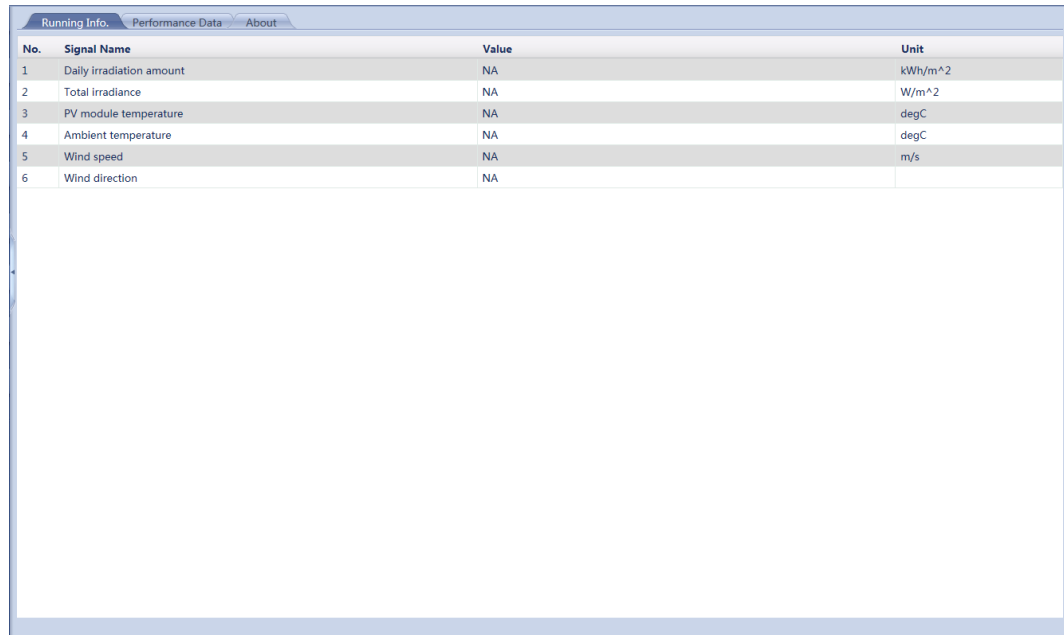
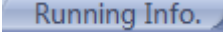
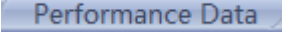

Figure 7-24 Querying EMI-related information



The screenshot shows the 'Running Info.' tab selected in the tertiary navigation menu. Below the menu is a table with the following data:

No.	Signal Name	Value	Unit
1	Daily irradiation amount	NA	kWh/m^2
2	Total irradiance	NA	W/m^2
3	PV module temperature	NA	degC
4	Ambient temperature	NA	degC
5	Wind speed	NA	m/s
6	Wind direction	NA	

 **NOTE**

- You can click the , , or  tab on the tertiary navigation menu to query EMI-related information.
- EMI performance data can be stored for a month and exported. When changing the name of the exported file, retain the extension **.tar.gz**. Otherwise, the file will be unavailable.

7.8.6 Power Meter

7.8.6.1 Querying Related Information

Choose **Monitoring > Meter** and query related information on the displayed page.

Figure 7-25 Querying the meter information

No.	Signal Name	Value	Unit
1	Device status	OnLine	
2	Line voltage between phases A and B	0.00	V
3	Line voltage between phases B and C	0.00	V
4	Line voltage between phases C and A	0.00	V
5	Phase A current	0.0	A
6	Phase B current	0.0	A
7	Phase C current	0.0	A
8	Active power	0.000	kW
9	Reactive power	0.000	kVar
10	Active electricity	0.0	kWh
11	Power factor	0.000	

 **NOTE**

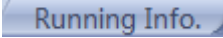
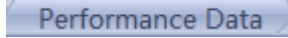
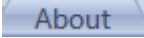
- You can click the , , or  tab on the tertiary navigation menu to query meter information.
- The performance data of the meter can be exported. When changing the name of the exported file, retain the extension **.tar.gz**. Otherwise, the file will be unusable.

7.8.6.2 Setting Running Parameters

Because of permission restriction, log in as **Advanced User**. Choose **Monitoring > Meter > Running Param.** to access the target page.

 **NOTE**

Set running parameters only for the power meter that supports the DL/T645 protocol.

Figure 7-26 Setting running parameters

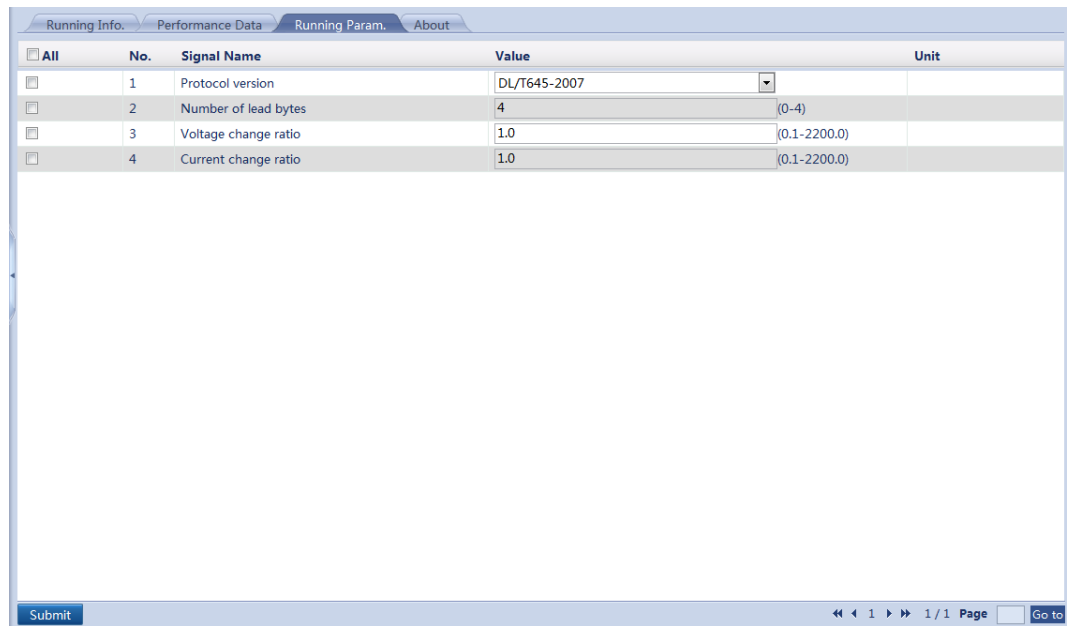

7.8.7 PID

7.8.7.1 Querying Related Information

Choose **Monitoring > PID** and query related information on the displayed page.



NOTE

This document describes the page displayed when the PID01 module is connected as an example.

Figure 7-27 Querying PID module-related Information

No.	Signal Name	Value	Unit
1	Device status	Disconnection	
2	Output voltage	NA	V
3	Output current	NA	mA
4	Cabinet temperature	NA	degC
5	PV1 voltage	NA	V
6	PV2 voltage	NA	V
7	Grid AB line voltage	NA	V
8	Grid BC line voltage	NA	V
9	Grid CA line voltage	NA	V
10	Grid frequency	NA	Hz
11	Power grid imbalance	NA	%
12	Voltage harmonic	NA	%

 **NOTE**

- You can click the **Running Info.**, **Active Alarm**, **Performance Data**, or **About** tab on the tertiary navigation menu to query PID module-related information.
- Performance data of the PID module can be exported. When changing the name of the exported file, retain the extension **.tar.gz**. Otherwise, the file will be unavailable.

7.8.7.2 Setting Running Parameters

Because of permission restriction, log in as **Advanced User**. Choose **Monitoring > PID > Running Param.** to access the target page.

Figure 7-28 Setting running parameters

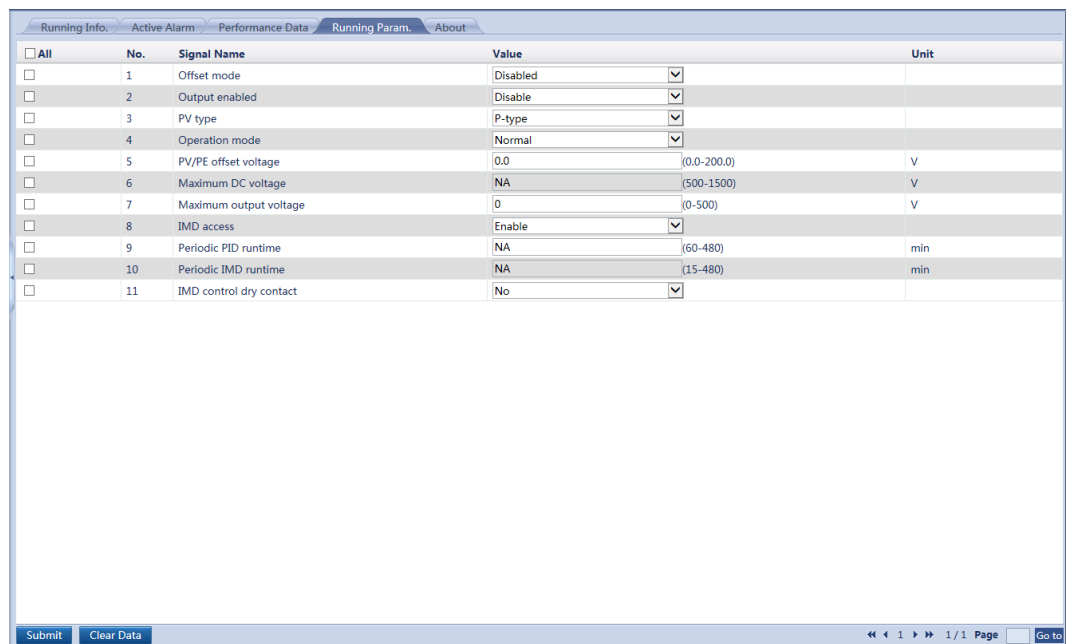

NOTICE

The parameter list provided in this document includes all configurable parameters. Configurable parameters vary depending on the device model. The actual screen prevails.

Table 7-10 Parameter description

No.	Parameter Name	Function	Parameter Value	Description
1	Offset mode	Specifies the offset mode of the PID module.	Disabled	Set this parameter to Disable if the PID module is not required.
			N/PE	Set this parameter to N/PE if the PID module is required to use voltage output from the inductor virtual midpoint N.

No.	Parameter Name	Function	Parameter Value	Description
			PV/PE	Set this parameter to PV/PE if the PID module is required to use voltage output from the negative PV terminal. This mode is applicable only to SUN8000.
			Automatic	In the SUN2000, Automatic indicates the N/PE offset mode.
2	Output enabled	Specifies whether the PID module output is enabled.	Enable	Set this parameter to Enable to allow the PID module output.
			Disable	Set this parameter to Disable to forbid the PID module output.
3	PV type	Specifies the type of the PV module used in the power station. For details about the PV module type, consult the manufacturer.	P-type	Select this value if the PV module type is P. In this case, the PID module output voltage is positive.
			N-type	Select this value if the PV module type is N. In this case, the PID module output voltage is negative.
4	PV/PE offset volt.	Specifies the DC voltage when the offset mode is set to PV/PE.	0–200V	It is recommended that the offset voltage be set to a value ranging from 50 V to 200 V.
5	Operation Mode	Specifies whether the PID module is currently working in normal or commissioning mode.	Commissioning	In commissioning mode, if you need to set the output mode to PV/PE or N/PE , set Output enabled to Enable . The PID module delivers output voltages based on the value of Commissioning output voltage . NOTE To check whether the PID module functions properly, it is recommended that Operation mode be set to Commissioning upon first power-on.
			Normal	In normal mode, the PID module operates automatically after the PID module, inverter, and SmartLogger communicate with each other properly.
6	Commissioning output voltage	Specifies the output voltage when Operation Mode is set to Commissioning .	0–500 V	It is recommended that the commissioning voltage for the 1000 V/1100 V inverter be set to a value ranging from 50 V to 400 V. NOTE After this parameter is set and the output from the PID module becomes stable, use a multimeter that is set to the DC position to measure the three-phase (A, B, and C) voltages of the power grid to the ground, and check whether the voltages are the same as the configured values.

No.	Parameter Name	Function	Parameter Value	Description
7	Maximum DC voltage	Specifies the PV-PE voltage when Operation Mode is set to Normal or Commissioning .	500–1500 V	If the PV module type is P, the parameter value indicates the highest DC voltage between PV+ and PE. If the PV module type is N, the parameter value indicates the highest DC voltage between PV– and PE.
8	Maximum output voltage	Specifies the highest output voltage of the PID module when Operation Mode is set to Normal or Commissioning .	0–500 V	If the offset mode is PV/PE , the parameter value indicates the highest DC output voltage between PV and PE. If the offset mode is N/PE , the parameter value indicates the highest DC output voltage between N and PE.
9	IMD access	Specifies whether the PID module and insulation monitor device (IMD) can operate in cycle mode.	Enable	Select Enable if you allow the PID module and IMD operate in cycle mode. Only the IMDs of mainstream suppliers such as DOLD and BENDER are supported, and the IMDs must have enabled dry contacts. NOTICE Only when IMD access is set to Enable , can you set Periodic PID runtime , Periodic IMD runtime , and IMD control dry contact .
			Disable	Select Disable if you forbid the access of IMDs.
10	Periodic PID runtime	Specifies the operating time segment of the PID module when the PID module and IMD operate in cycle mode.	60–480 minutes	The IMD is shut down when the PID module is operating.
11	Periodic IMD runtime	Specifies the operating time segment of the IMD when the PID module and IMD operate in cycle mode.	15–480 minutes	The PID module is standby when the IMD is operating.
12	IMD control dry contact	Dry contact No. over which the SmartLogger controls the IMD	DO1, DO2, and DO3	PID01: Set appropriate ports based on the cable connections between the IMD and the SmartLogger.

No.	Parameter Name	Function	Parameter Value	Description
13	Clear Data	Clears the active alarms and historical alarms stored on the PID module.	N/A	You can select Clear Data to clear active alarms and historical alarms for the PID module.

7.8.8 Custom Device, IEC103 Device, or IEC104 Device

Custom Device: The SmartLogger can connect to the third-party devices supporting the Modbus-RTU protocol, such as the box-type transformer and environmental monitoring instrument (EMI). Since the protocol information points vary depending on vendors, you need to obtain a protocol information file in **.cfg** format from Huawei and import the file into the SmartLogger for successfully connecting to a third-party device.

IEC103 Device: The SmartLogger can connect to the third-party devices supporting IEC103, such as the relay protection or monitoring device like the box-type transformer. Since the protocol information points vary depending on vendors, you need to obtain a protocol information file in **.cfg** format from Huawei and import the file into the SmartLogger for successfully connecting to a third-party device.

IEC104 Device: The SmartLogger can connect to the third-party devices supporting IEC104, such as the relay protection or monitoring device like the box-type transformer. Since the protocol information points vary depending on vendors, you need to obtain a protocol information file in **.cfg** format from Huawei and import the file into the SmartLogger for successfully connecting to a third-party device.



NOTE

- Custom, IEC103, or IEC104 devices cannot be detected automatically and need to be added manually. For details, see [7.11.8.1 Connecting Devices](#).
- The SmartLogger can connect to a maximum of five types of custom, IEC103, or IEC104 devices and can connect to multiple devices of the same type.



7.8.8.1 Querying Related Information

Select a device on the **Monitoring** page and query related information on the displayed page.

Figure 7-29 Querying device information

No.	Signal Name	Value	Unit
1	SN	CT02311HJB00GB001486	
2	Port number	6	
3	Comm Address	1	
4	Logical address	146	
5	Device status	Online	

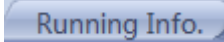
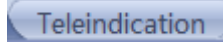
 **NOTE**

Click the , , or  tab on the tertiary navigation menu to query device information.

7.8.8.2 Setting Telecontrol Parameters

Select a device on the **Monitoring** page, and select **Telecontrol** to go to the page.

Figure 7-30 Setting telecontrol parameters

<input type="checkbox"/> All	No.	Signal Name	Value	Unit
<input type="checkbox"/>	1	Power-On	0	
<input type="checkbox"/>	2	Power-Off	0	

7.8.8.3 Setting Teleadjust Parameters

Select a device on the **Monitoring** page, and select **Teleadjust** to go to the page.

Figure 7-31 Setting teleadjust parameters

<input type="checkbox"/> All	No.	Signal Name	Value	Unit
<input type="checkbox"/>	1	Protec. OV niveau-1	0	
<input type="checkbox"/>	2	Durée protec. OV niv.1	0	

7.9 Querying Historical Data

7.9.1 Querying Historical Alarms

Choose **Query > Alarm History** and query alarms on the displayed page.

Figure 7-32 Historical alarms

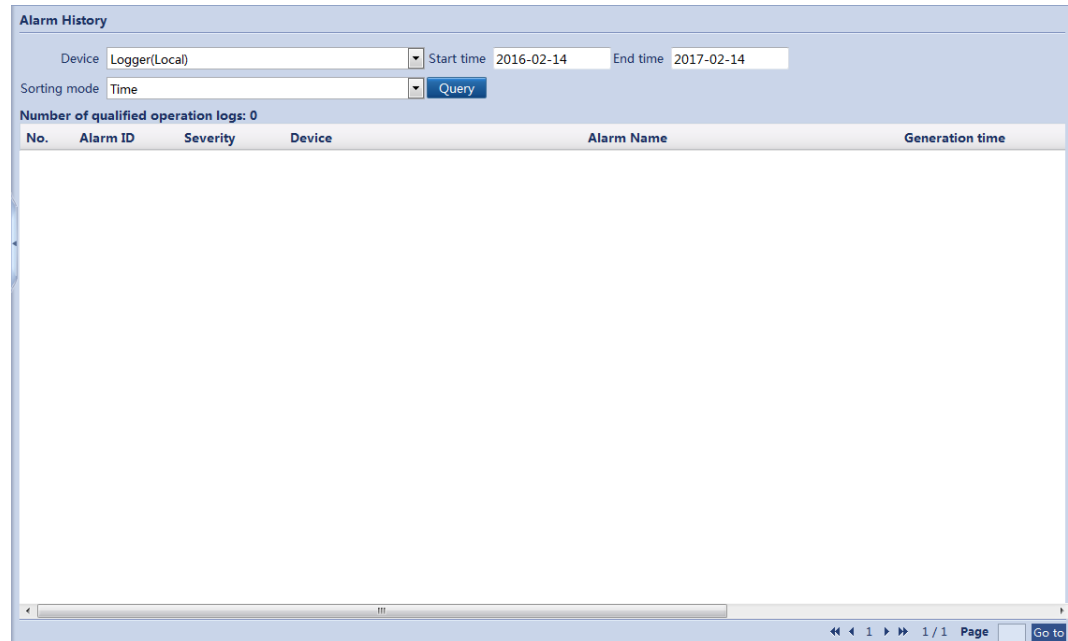

7.9.2 Querying Operation Logs

Because of permission restriction, log in as **Advanced User** or **Special User**. Choose **Query > Operation Log** and query logs on the displayed page.

Figure 7-33 Operation log

Operation Log				
Number of qualified operation logs : 175				
No.	User Name	Operation Time	Operation Source	Content
1	Advanced User	2017-02-14 06:56:40	WEB	Login IP: 192.168.0.2
2	Special User	2017-02-14 06:56:33	WEB	Logout IP: 192.168.0.2
3	Special User	2017-02-14 06:55:13	WEB	Login IP: 192.168.0.2
4	Advanced User	2017-02-14 06:54:53	WEB	Logout IP: 192.168.0.2
5	Advanced User	2017-02-14 06:53:22	WEB	Login IP: 192.168.0.2
6	Special User	2017-02-14 06:53:15	WEB	Logout IP: 192.168.0.2
7	Special User	2017-02-14 06:41:20	WEB	Login IP: 192.168.0.2
8	Advanced User	2017-02-14 06:41:14	WEB	Logout IP: 192.168.0.2
9	Advanced User	2017-02-14 06:31:35	WEB	Login IP: 192.168.0.2
10	Advanced User	2017-02-14 06:31:35	WEB	Logout: due to user login
11	Advanced User	2017-02-14 06:30:43	WEB	Login IP: 192.168.0.1
12	Advanced User	2017-02-14 06:30:43	WEB	Logout: due to user login
13	Advanced User	2017-02-14 06:26:39	WEB	Local Time:2017-02-13 06:26:46->2017-02-14 06:26:39
14	Advanced User	2017-02-13 06:18:58	WEB	Add Meter(COM4-1)
15	Advanced User	2017-02-13 06:18:38	WEB	Logger(Local)-End address-> 247
16	Advanced User	2017-02-13 06:18:37	WEB	Logger(Local)-Start address-> 1
17	Advanced User	2017-02-13 06:18:37	WEB	Logger(Local)-Baud rate-> 9600
18	Advanced User	2017-02-13 06:18:37	WEB	Logger(Local)-Parity-> None
19	Advanced User	2017-02-13 06:18:37	WEB	Logger(Local)-0x2556-> Modbus
20	Advanced User	2017-02-13 06:18:37	WEB	Logger(Local)-End address-> 247

7.9.3 Exporting Data

Because of permission restriction, log in as **Advanced User** or **Special User**. Choose **Query > Export Data** and export data on the displayed page.

Figure 7-34 Exporting data

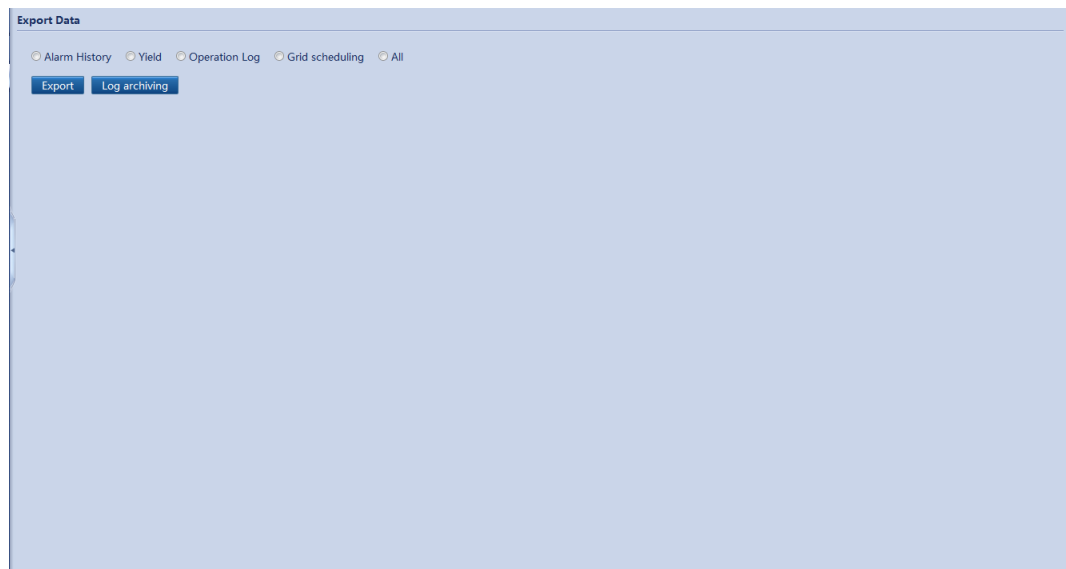

 **NOTE**

When changing the name of the exported file, do not change the file name extension. Otherwise, the file may be unavailable.

Opening the Exported File

The exported file is in CSV format and can be opened in Excel. After opening the file in Excel, the cells may not be neatly organized. Set **List separator** to ,.

To view and change the list separator, perform the following steps:

1. Open **Control Panel** and choose **Region and Language**.
2. Under **Formats**, click **Additional settings**.

Figure 7-35 Viewing and changing the list separator (1)

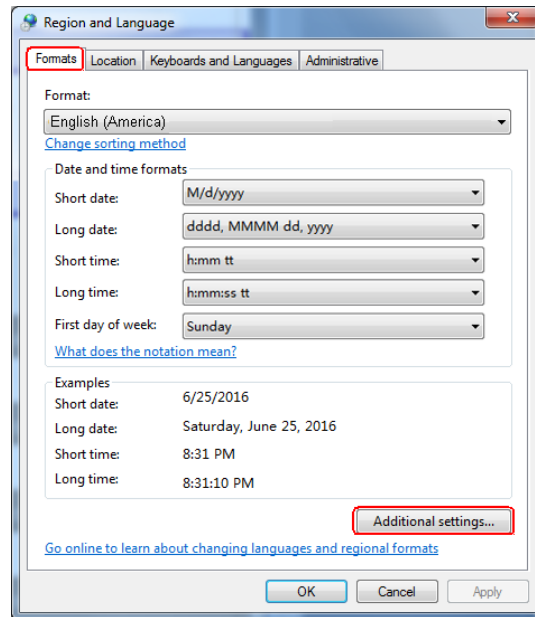

3. View and change the list separator.
 - If **List separator** is ,, click **OK**.
 - If **List separator** is not ,, change it to ,, and click **OK**.

Figure 7-36 Viewing and changing the list separator (2)

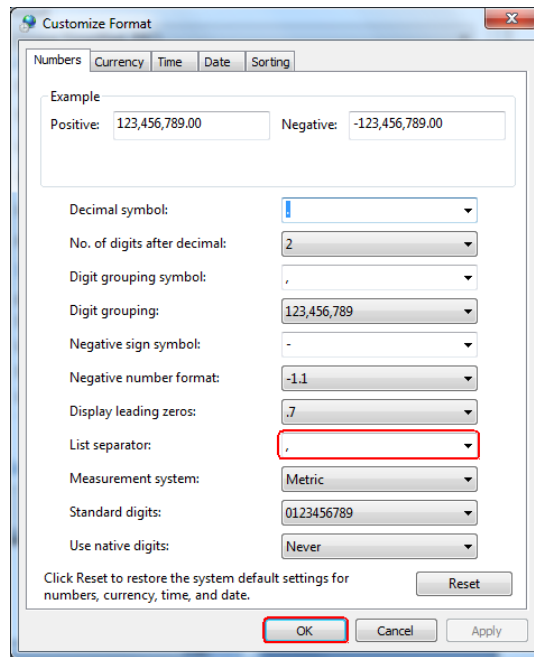

7.10 Settings

7.10.1 User Parameters

7.10.1.1 Setting the Date and Time

Because of permission restriction, log in as **Common User** or **Advanced User**. Choose **Settings > Date&Time** to access the target page.

Figure 7-37 Setting the date and time

The screenshot displays a web interface for configuring system time. It is divided into three sections: 'Time Zone', 'Date', and 'Time Synchronization'.
1. **Time Zone**: A dropdown menu is set to '(UTC+08:00)Beijing'. A 'Submit' button is located below the dropdown.
2. **Date**: Two input fields are present. The first is labeled 'Date' and contains '2017-04-10' with a format hint '(YYYY-MM-DD)'. The second is labeled 'Time' and contains '15:13:36' with a format hint '(HH:MM:SS)'. A 'Submit' button is located below these fields.
3. **Time Synchronization**: A dropdown menu is set to 'NetEco'. A 'Submit' button is located below the dropdown.



NOTICE

- The **Local time zone** parameter is unavailable for zones without DST.
- After **Date&Time** is set, the date and time of all the inverters connected to SmartLogger are updated accordingly. Ensure that the settings are correct.
- Modification of **Date&Time** may affect the recording of energy yield and performance data. Therefore, do not change the time zone or system time arbitrarily.

7.10.1.2 Setting Plant Information

After you set plant information, a plant configuration file can be generated. You can upload this file to a third-party hosting website to implement remote monitoring.

Because of permission restriction, log in as **Common User** or **Advanced User**. Choose **Settings > Plant** to access the target page.

Figure 7-38 Setting plant information

Plant Info.	
Plant name	<input type="text"/>
Plant address	<input type="text"/>
Plant owner	<input type="text"/>
Plant owner address	<input type="text"/>
Country	CN(China, People's Republic of) <input type="button" value="v"/>

 **NOTE**

When setting plant information, you cannot successfully enter any character such as "<>,'?()#&\\\$|%+;~^" in the English half-width status.

7.10.1.3 Setting Gain Parameters

Because of permission restriction, log in as **Common User** or **Advanced User**. Choose **Settings > Revenue** to access the target page.

Figure 7-39 Setting gain parameters

Gain Parameters	
Currency	EUR <input type="button" value="v"/>
Electricity price/kWh	10.000 (0.000-999.999)
CO2 emission reduction coefficient	10.000 kg/kWh (0.000-10.000)

**NOTE**

Electricity price/kWh indicates the local power price, and is used to calculate the translation gain of the energy yield.

7.10.2 Communications Parameters

7.10.2.1 Setting Ethernet Parameters

Because of permission restriction, log in as **Advanced User**. Choose **Settings > Ethernet** to access the target page.

Figure 7-40 Setting Ethernet parameters

Auto obtain IP	
Auto obtain IP	Disable (configurable on the LCD)

IP address	
IP address	192, 168, 0, 12
Subnet mask	255, 255, 255, 0
Default gateway	192, 168, 0, 1

DNS Server Address	
Primary DNS server	192, 168, 0, 1
Secondary DNS server	0, 0, 0, 0

**NOTICE**

If the SmartLogger connects to the Internet through a router, note the following when setting Ethernet parameters:

- Set the gateway address to the IP address of the router.
- Ensure that the IP address of the SmartLogger is in the same network segment as the gateway address.
- Set the domain name server (DNS) address to the IP address of the router or obtain the DNS address from the network provider.

**NOTE**

If the IP address is changed, you need to use the new IP address to log in to the system.

7.10.2.2 Setting RS485 Parameters

Because of permission restriction, log in as **Advanced User**. Choose **Settings > RS485** to access the target page.

Figure 7-41 RS485 parameters

RS485	Protocol	Parity	Baud rate	Start address	End address
RS485-1	Modbus	None	9600	1 (1-247)	247 (1-247)
RS485-2	Modbus	None	9600	1 (1-247)	247 (1-247)
RS485-3	Modbus	None	9600	1 (1-247)	247 (1-247)

Night Comm. Settings	
Night silent	Disable
Enter time	18:00 (HH:MM)
Exit time	05:00 (HH:MM)
Wakeup period	60 min(30-1440)

 **NOTE**

- **RS485-1** to **RS485-3** correspond to the communications ports **COM1** to **COM3**, and the default baud rate is 9600 bps. The baud rates for devices connected to the same RS485 port must be the same.
- Set the protocol supported by the RS485 port based on either the protocol supported by the connected device or the status of the device in the network. When the SmartLogger serves as a slave node to interconnect with a third-party device over Modbus-RTU, set **Protocol** to **Modbus-Slave**. When the connected SUN2000 performs rapid power grid scheduling using both PLC and RS485, set **Protocol** to **Modbus-Control**.
- **Protocol** and **Parity** must be set to the same values for all devices connected to the same RS485 port.
- $1 \leq \text{start address} \leq \text{end address} \leq 247$. The address segments for each RS485 port from **RS485-1** to **RS485-3** can overlap.

Set the address range as required. A larger address range requires a longer searching time. The start and end addresses have no impact on the devices that have been connected.

7.10.2.3 Setting EMI Parameters

The SmartLogger can connect to an EMI that supports the standard Modbus-RTU/RS485 protocol. One SmartLogger can connect to and manage only one EMI.

Devices from different vendors may support different protocol specifications. To normally obtain information from the connected EMI, correctly configure the protocol specifications over the SmartLogger WebUI based on the protocol specifications delivered by the vendor.

After the SmartLogger connects to the EMI, manually add the device. For details, see [7.11.8.1 Connecting Devices](#). **Device Type** should be set to **EMI**.

Devices from different vendors may support different protocol specifications. To normally obtain information from the connected EMI, correctly configure the protocol specifications over the SmartLogger WebUI based on the protocol specifications delivered by the vendor.

Because of permission restriction, log in as **Advanced User**. Choose **Monitoring > EMI** and set EMI parameters.

- If you use a specific model of EMI, select the model from the drop-down list box.

Figure 7-42 EMI (1)

The screenshot shows the 'Environmental Monitoring Instrument' configuration page. The 'EMI model' dropdown menu is open, displaying a list of options: ABB VSN800-12, ABB VSN800-14, Gill MetPak Pro, Hukseflux SRx, Ingenieurbüro SI-RS485TC, Kipp&Zonen SMPx, Luftt WSx-UMB, Luftt WSx-UMB(external sensors), Meier-NT ADL-SR, Meteo control SR20-D2, Rainwise PVmet-150, Rainwise PVmet-200, Jingzhou Yangguang(PC-4), Handan(RYQ-3), Sensor (ADAM), and Other.

NOTE

Synchronize Environment Data: If **Enable** is selected, wind speed and direction data will be sent to the inverter in a PV plant with the tracking system.

- If you use a split EMI that is connected through an analog-to-digital converter, choose **Sensor (ADAM)** from the drop-down list box.

Figure 7-43 EMI (2)

The screenshot shows the 'Environmental Monitoring Instrument' configuration page with various parameters set. The 'EMI model' is 'Sensor (ADAM)', 'Synchronize Environment Data' is 'Disable', 'Read function code' is 'Read holding register 03H', 'Data report mode' is 'Integer', 'Word ordering' is 'Big endian', and 'Read mode' is 'Multiple read'. The 'Start address' is 0 and 'End address' is 8. Below these are fields for 'Upper Thres.' and 'Spec' for each signal. A table lists the signals and their parameters:

No.	Signal Name	Signal address	Lower Thres.	Upper Thres.	Spec	Start (mV/mA)	End (mV/mA)
1	Total irradiance	7	0.0	0.0	0-20mA	0.0	20.0
2	Ambient temperature	1	0.0	0.0	0-20mA	0.0	20.0
3	PV module temperature	2	0.0	0.0	0-20mA	0.0	20.0
4	Wind direction	6	0.0	0.0	0-20mA	0.0	20.0
5	Wind speed	3	0.0	0.0	0-20mA	0.0	20.0

A 'Submit' button is located at the bottom of the configuration area.

NOTE

Correctly set the parameters in accordance with the Modbus parameters provided by the EMI manufacturers. Otherwise, the EMI data cannot be successfully read.

- **Synchronize Environment Data:** If **Enable** is selected, wind speed and direction data will be sent to the inverter in a PV plant with the tracking system.
- Set **Read Mode** based on the mode supported by the EMI.
If **Multiple read** is selected, set **Start address** and **End address** based on the acquired Modbus signal address range on the EMI.

- If the EMI can collect a certain signal, set **Signal address** for the signal to the corresponding register address. If the EMI cannot collect a certain signal, set **Signal address** for the signal to **65535**.
- If you use any other model of EMI, select **Other** from the drop-down list box and set the EMI parameters.

Figure 7-44 EMI (3)

No.	Signal Name	Signal address	Gain	Offset
1	Total irradiance	7	1	
2	Ambient temperature	1	10	0.0
3	PV module temperature	2	10	0.0
4	Wind direction	6	1	
5	Wind speed	3	10	



NOTE

Correctly set the parameters in accordance with the Modbus parameters provided by the EMI manufacturers. Otherwise, the EMI data cannot be successfully read.

- **Synchronize Environment Data:** If **Enable** is selected, wind speed and direction data will be sent to the inverter in a PV plant with the tracking system.
- **Set Read Mode** based on the mode supported by the EMI.
If **Multiple read** is selected, set **Start address** and **End address** based on the acquired Modbus signal address range on the EMI.
- If the EMI can collect a certain signal, set **Signal address** for the signal to the corresponding register address. If the EMI cannot collect a certain signal, set **Signal address** for the signal to **65535**.

7.10.2.4 Setting Power Meter Parameters

Because of permission restriction, log in as **Advanced User** or **Special User**. Choose **Settings > Power Meter** to access the target page.

Power Meter Without Feedback of Grid Connection Data

If a power meter connected in the PV plant does not need to provide feedback of the grid connection data, set **Meter feedback output** to **Disable**.

- If the connected power meter model is in the drop-down list box of **Intelligent Power Meter Type**, select it, as shown in [Figure 7-45](#).
- If the connected power meter model is not in the drop-down list box of **Intelligent Power Meter Type**, select **Other**, and set related parameters, as shown in [Figure 7-46](#).

Figure 7-45 Power meter 1

Power Meter Param. Settings(Modbus-RTU)	
Intelligent Power Meter Type	Acrel PZ96L
Meter feedback output	Disable
Voltage change ratio	1.0 (0.1-65535.0)
Current change ratio	1.0 (0.1-65535.0)
Submit	

Figure 7-46 Power meter 2

Power Meter Param. Settings(Modbus-RTU)	
Intelligent Power Meter Type	Other
Read function code	Read holding register 03H
Read mode	Multiple read
Data reporting mode	Floating point
Meter feedback output	Disable
Start address	19000 (0-65535)
End address	19099 (0-65535)
Voltage change ratio	1 (1-65535)
Current change ratio	1 (1-65535)

No.	Signal Name	Signal address	Number of Registers	Gain
1	Phase A voltage	19000 (0-65535)	2	1.0 (0-10000)
2	Phase B voltage	19002 (0-65535)	2	1.0 (0-10000)
3	Phase C voltage	19004 (0-65535)	2	1.0 (0-10000)
4	A-B line voltage	19006 (0-65535)	2	1.0 (0-10000)
5	B-C line voltage	19008 (0-65535)	2	1.0 (0-10000)
6	C-A line voltage	19010 (0-65535)	2	1.0 (0-10000)
7	Phase A current	19012 (0-65535)	2	1.0 (0-10000)
8	Phase B current	19014 (0-65535)	2	1.0 (0-10000)
9	Phase C current	19016 (0-65535)	2	1.0 (0-10000)
10	Active power	19026 (0-65535)	2	1.0 (0-10000)
11	Reactive power	19042 (0-65535)	2	1.0 (0-10000)
12	Active electricity	19060 (0-65535)	2	1.0 (0-10000)
13	Reactive electricity	19092 (0-65535)	2	1.0 (0-10000)
14	Power factor	65535 (0-65535)	2	1.0 (0-10000)
15	Apparent power	19034 (0-65535)	2	1.0 (0-10000)

Power Meter with Feedback of Grid Connection Data

If a power meter connects to the PV plant and the power meter needs to report the data at the grid-connected point through the AO port on the SmartLogger, the primary SmartLogger needs to expand the AI/AO port by connecting to an ADAM. After correctly configuring expanded ports (see [7.10.6 Setting Extended Ports](#) for details), set **Meter feedback output** to **Enable** and set the parameters for each port as required.

Figure 7-47 Setting parameters for grid connection data feedback

Power Meter Param. Settings(Modbus-RTU)

Intelligent Power Meter Type: UMG604

Meter feedback output: Enable

Feedback GCP Param. Settings

port	Feedback Parameter	Start Current (mA)	End Current (mA)	Start Data	End Data	Unit
AO1	No	4.000 (0-20)	20.000 (0-20)	0.000	0.000	
AO2	No	4.000 (0-20)	20.000 (0-20)	0.000	0.000	
AO3	No	4.000 (0-20)	20.000 (0-20)	0.000	0.000	
AO4	No	4.000 (0-20)	20.000 (0-20)	0.000	0.000	



NOTE

- **Start current** and **End current** indicate the valid value range of signals carried by the analog output loop. The current range is less than or equal to the current range specified in the AO specifications. **Start Data** corresponds to **End Data**.
- **Start Data** and **End Data** are the valid signal value range of the selected **Feedback Parameter**. Set the two parameters based on site requirements. An excessive range results in low precision of the feedback while an insufficient range results in the incompleteness of the feedback.
- **Unit** is the unit for the selected **Feedback Parameter**. When setting **Start Data** and **End Data**, note the unit selected. Otherwise, false input and output may be generated.

7.10.2.5 Setting NetEco Parameters

To set parameters correctly, ensure that the SmartLogger can connect to the Huawei NMS such as NetEco and FusionSolar, or a third-party NMS.

You need to log in as **Advanced User** that has the permission to set the parameters. Choose **Settings > NetEco** to enter the page.

Figure 7-48 Setting NetEco parameters

NetEco	
NetEco server	<input type="text"/>
Port number	<input type="text" value="16100"/> (1~65535)
Address mode	Logical address
SSL encryption	Enable
Second challenge authentication	Disable

Submit Network Test

Security Certificate	
Upload CA certificate file	<input type="text"/> Browse... Upload
Upload local certificate file	<input type="text"/> Browse... Upload
Upload key file	<input type="text"/> Browse... Upload

Enable key password

Submit

 **NOTE**

- Set **NetEco server** to the IP address or domain name of the NetEco server.
- When the SmartLogger connects to the Huawei NMS, retain the default value 16100 for **Port number**. When the SmartLogger connects to the third-party NMS, set **Port number** according to the server port enabled in a third-party NMS.
- In most cases, set **Address mode** to **Comm. Address**. If the devices connected to the three RS485 ports of the SmartLogger have duplicate addresses, you must set **Address mode** to **Logical address**.
- If **SSL encryption** is set to **Disable**, data will be transmitted without being encrypted, which may result in user data theft. Therefore, exercise caution when deciding to set **SSL encryption** to **Disable**.

7.10.2.6 Setting Modbus TCP Parameters

Set Modbus TCP parameters for the SmartLogger to communicate with a third-party NMS.

Because of permission restriction, log in as **Advanced User**. Choose **Settings > Modbus TCP** to access the target page.

Figure 7-49 Setting Modbus TCP parameters

Modbus TCP	
Link setting	Enable(Limited) ▾
Client 1 IP Address	10. 142. 57. 148
Client 2 IP Address	0. 0. 0. 0
Client 3 IP address	0. 0. 0. 0
Client 4 IP address	0. 0. 0. 0
Client 5 IP address	0. 0. 0. 0
Address mode	Comm. Address ▾
SmartLogger address	0 (0-247)

 **NOTE**

- Modbus TCP is a general standard protocol without a security authentication mechanism. To reduce network security risks, the function of connecting to a third-party NMS using Modbus TCP is disabled by default. To use this function, set **Link setting** to **Enable(Limited)** or **Enable(Unlimited)**. If you select **Enable(Limited)**, the SmartLogger can communicate with up to five third-party NMSs whose IP addresses are set under **Modbus TCP**. If you select **Enable(Unlimited)**, the SmartLogger can communicate with all third-party NMSs with valid IP addresses.
- If the function of connecting to a third-party NMS using Modbus TCP is enabled, data will be transmitted without being encrypted, which may result in user data theft. Therefore, exercise caution when deciding to enable this function.
- In most cases, set **Address mode** to **Comm. Address**. If the devices connected to the COM ports of the SmartLogger have duplicate communications addresses, you must set **Address mode** to **Logical address**.

7.10.2.7 Setting IEC103 Parameters

Third-party devices that use the standard IEC103 interface protocol may be connected to a PV plant. The SmartLogger can read the information about such third-party devices and upload the information to the NetEco, thereby enhancing the PV plant solutions.

As Huawei inverter devices (such as SUN2000s) support protocols different from third-party devices that use standard IEC103 (such as box-type transformers, combiner boxes, and inverters), they cannot be connected in series on the same RS485 bus.

If the SmartLogger connects to the NetEco, it transparently transmits IEC103 device information to the NetEco.

Because of permission restriction, log in as **Advanced User**. Choose **Settings > IEC103** to access the target page.

Figure 7-50 Setting IEC103 parameters

IEC103	
IEC103 port No.	No <input type="text"/>
IEC103 address	126 <small>(1-255)</small>
IEC103 IP	0. 0. 0. 0

**NOTE**

- Third-party devices and Huawei devices must be connected to different ports of the SmartLogger. Otherwise, the communication will be abnormal.
- The value of **IEC103 IP** must be consistent with the NetEco IP address.

7.10.2.8 Setting IEC104 Parameters

If the SmartLogger connects to a third-party NMS over the IEC104 protocol, IEC104 parameters must be correctly set to enable the third-party NMS to monitor the running status of devices connected to the SmartLogger.

Because of permission restriction, log in as **Advanced User**. Choose **Settings > IEC104** to access the target page.

Figure 7-51 Setting IEC104 parameters

IEC104 Parameter Settings	
Link setting	Enable(Limited) ▼
IEC104-1 IP	0, 0, 0, 0
IEC104-2 IP	0, 0, 0, 0
IEC104-3 IP	0, 0, 0, 0
IEC104-4 IP	0, 0, 0, 0
IEC104-5 IP	0, 0, 0, 0
Public IP address	1 (1-65534)
Teleindication default segment	50 (1-100)
Telemetry default segment	50 (1-100)
Control mode	Control after sele ▼

NOTE

- IEC104 is a general standard protocol without a security authentication mechanism. To reduce network security risks, the function of connecting to a third-party NMS using IEC104 is disabled by default. To use this function, set **Link setting** to **Enable**. To use this function, set **Link setting** to **Enable(Limited)** or **Enable(Unlimited)**. If you select **Enable(Limited)**, the SmartLogger can communicate with up to five third-party NMSs whose IP addresses are set under **IEC104**. If you select **Enable(Unlimited)**, the SmartLogger can communicate with all third-party NMSs with valid IP addresses.
- You can click the Select icon in the upper left corner of the page to access the required setting page.
- You can export an IEC104 configuration file in CSV format.

After the IEC104 configuration file exported from the SmartLogger and the device type IEC104 information files delivered with devices are correctly configured on a third-party NMS, the third-party NMS will be able to monitor the devices connected to the SmartLogger over the IEC104 protocol.

7.10.3 Extended Parameters

7.10.3.1 Setting FTP Parameters

The FTP function is used to access a third-party NMS. The SmartLogger can report the configuration information and running data of the managed plant system through FTP. A third-party NMS can access Huawei devices after being configured.

Because of permission restriction, log in as **Advanced User**. Choose **Settings > FTP** to access the target page.

Figure 7-52 Setting FTP parameters

Basic parameters	
FTP server	<input type="text"/>
User name	<input type="text"/>
Password	<input type="text"/>
Remote directory	<input type="text"/>
Report Settings	
Data export	Disable <input type="button" value="v"/>
FTP file format	Format 1 <input type="button" value="v"/>
Export mode	Cyclic <input type="button" value="v"/>
Export interval	30 min (5~1440)
File mode	Accumulated data <input type="button" value="v"/>
Latest Report Status	
Transfer status	Success
Last transmission	2000-01-01 00:00:00



NOTE

- **FTP server** can be set to the domain name or IP address of the FTP server. If **FTP server** is set to the domain name of the FTP server, ensure that the address of the DNS server on the [Ethernet](#) page is set correctly.
- **User name** and **Password** indicate the user name and password that need to be entered when you log in to the FTP server.
- After setting **Remote directory**, you can create a subdirectory in the default data upload directory (specified by the FTP server).
- If **Data export** is set to **Enable**, you can set the SmartLogger to report data regularly or at a specified time. If you set the SmartLogger to report data regularly, you can choose whether to report all data or only the incremental data of a day each time.
- In **FTP file format**, the **Format 2** file contains two more information points than the **Format 1** file, namely, E-Day (energy yield of current day) and E-Total (total energy yield).

7.10.3.2 Setting Email Parameters

The SmartLogger can send emails to inform users of the energy yield, alarm, and equipment status information of the PV plant system, helping users to know the running conditions of the PV plant system in time.

When using this function, ensure that the SmartLogger can be connected to the configured email server and that the Ethernet parameters and email parameters for the SmartLogger are correctly set. Ensure that no password is set between the SmartLogger and the email server.

Because of permission restriction, log in as **Advanced User**. Choose **Settings > Email** to access the target page.

Figure 7-53 Setting email parameters

Basic parameters	
SMTP server	<input type="text"/>
User name	<input type="text"/>
Password	<input type="text"/>
SMTP port	25 (0-65535)
Email language	English
Send address	<input type="text"/>
Receive address 1	<input type="text"/>
Receive address 2	<input type="text"/>
Receive address 3	<input type="text"/>
Receive address 4	<input type="text"/>
Receive address 5	<input type="text"/>
Yield	
Send Email	Disable
Sent on schedule	22:00 (HH:MM)
Alarms	
Send Email	Disable
Alarm level	Major
Latest Report Status	
Transfer status	Success
Last transmission	2000-01-01 00:00:00

**NOTE**

- **SMTP Server** can be set to the domain name or IP address of the SMTP server.
If it is set to the domain name of the SMTP server, ensure that the address of the DNS server is set correctly.
- Set **Encryption mode** to encrypt the mails. Currently, the following types of mail addresses support encryption: Outlook, @qq.com, @126.com, @163.com, and @sina.com, of which only Outlook supports TLS encryption.
- **SMTP Port** specifies the port used for sending emails.
- **User name** and **Password** specify the user name and password used for logging in to the SMTP server.
- **Send address** specifies the sender's email address. Ensure that the sender's email server is the same as the server specified by **SMTP server**.
- You can click **Send test mail** to check whether the SmartLogger can successfully send emails to users.

7.10.4 Port Settings

7.10.4.1 Setting DO Parameters

This topic describes how to set DO configuration parameters for resetting an external 3G router over the WebUI.

Context

The SmartLogger provides three DO ports. You can connect one DC power cable of the 3G router to one DO port of the SmartLogger in series and power on or off the wireless module by disconnecting or connecting the DO dry contact to control the reset of the 3G router.

Considering the restrictions on the current that can pass the DO port of the SmartLogger, you need to determine the number of DO ports to be used for the control based on the maximum

power supply current of the 3G router (the maximum power supply current can be calculated based on the maximum power consumption and DC power supply voltage).

- When the power supply current is smaller than 1 A, use one DO port.
- When the power supply current is larger than 1 A but smaller than 1.6 A, use two DO ports.
- When the power supply current is larger than 1.6 A but smaller than 2.4 A, use three DO ports.
- When the power supply current is larger than 2.4 A, access is not allowed because the current exceeds the upper limit.

Connecting a 3G Router to the SmartLogger Over a DO Port

Before connecting a 3G router to the SmartLogger, cut off a DC power cable of the connector, and then connect the cable cut to the DO port on the SmartLogger.

- [Figure 7-54](#) shows the connection when one DO port is used.

Figure 7-54 Connecting one DO port

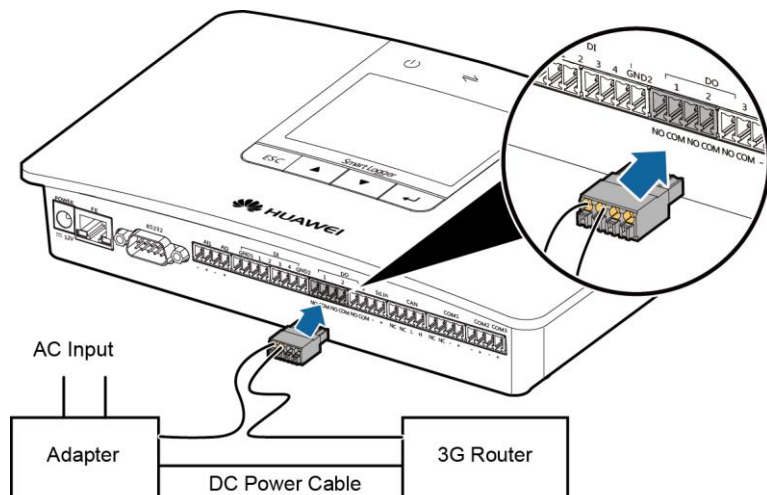

IL011C3007

- [Figure 7-55](#) shows the connection when two DO ports are used.

Figure 7-55 Connecting two DO ports

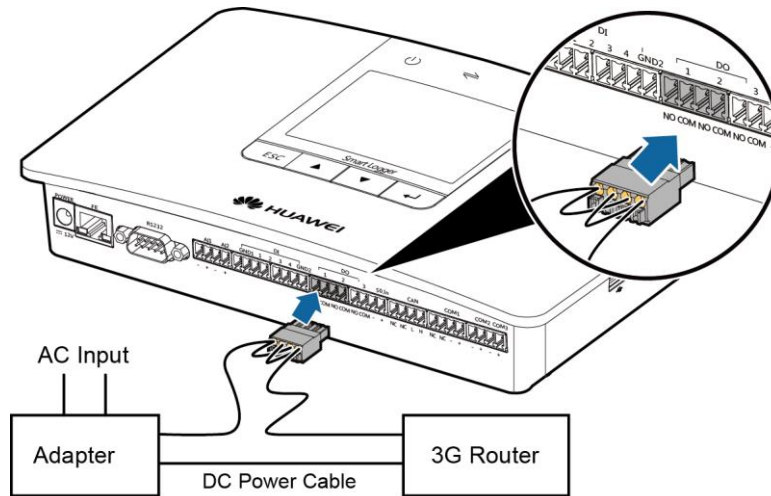

IL011C3008

- [Figure 7-56](#) shows the connection when three DO ports are used.

Figure 7-56 Connecting three DO ports

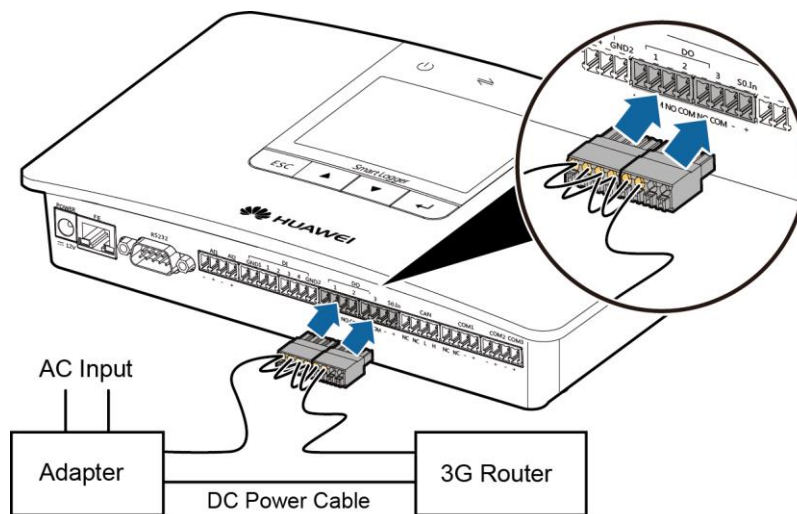

IL011C3009

DO Configuration

After connecting the 3G router to the SmartLogger properly, you can set DO configuration parameters over the WebUI to make the external 3G router automatically reset if the SmartLogger fails to connect to the NetEco, email server, or FTP server within 30 minutes.

Because of permission restriction, log in as **Advanced User**. Then choose **Settings > DO**.

Figure 7-57 DO configuration

DO Configuration	
DO1	Reset the external router ▾
DO2	No control ▾
DO3	No control ▾

 **NOTE**

Set **DO1**, **DO2**, and **DO3** to **Reset the external router** or **No control** based on the connections between the router and the three DO ports of the SmartLogger.

7.10.4.2 Setting USB Parameters

This topic describes how to set USB parameters for resetting an external 3G router over the WebUI.

Context

The SmartLogger provides a USB port, which has a power capacity of 5 V/1 A. If the DC power cable of the 3G router has a standard USB connector and has a maximum current of less than 1 A, it can directly connect to the USB port on the SmartLogger. Hence the SmartLogger can power on or off the 3G router, which allows the SmartLogger to control the reset of the 3G router when the communication link is interrupted.



NOTICE

- Only the SmartLoggers in versions later than V100R001C90SPC300 enjoy this function.
- If the maximum working current of the 3G router is greater than 1 A, it cannot be connected over a USB port.

Connecting a 3G Router over a USB

Connect the USB connector of the DC power cable of the 3G router to the USB port on the SmartLogger, as shown in [Figure 7-58](#).

Figure 7-58 Connecting the 3G router and the SmartLogger

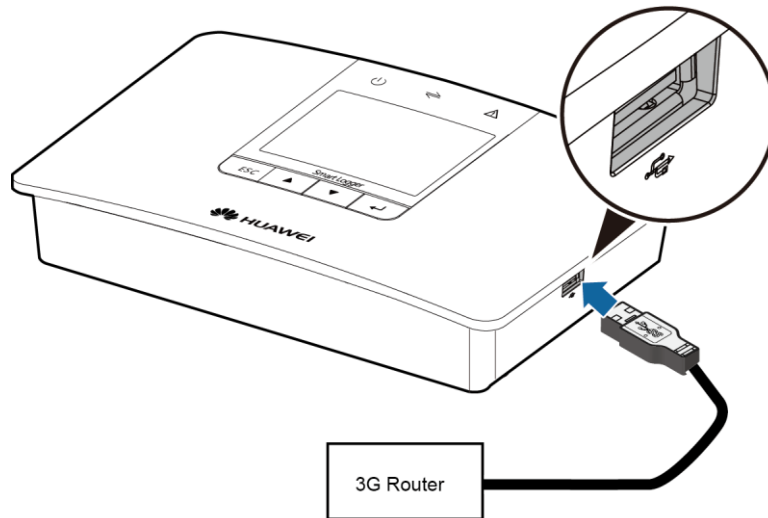

IL01IC3011

USB configuration

After connecting the 3G router to the SmartLogger properly, you can set USB configuration parameters over the WebUI to make the external 3G router automatically reset if the SmartLogger fails to connect to the NetEco, email server, or FTP server within 30 minutes.

Because of permission restriction, log in as **Advanced User**. Then choose **Settings > USB**.

Figure 7-59 USB configuration

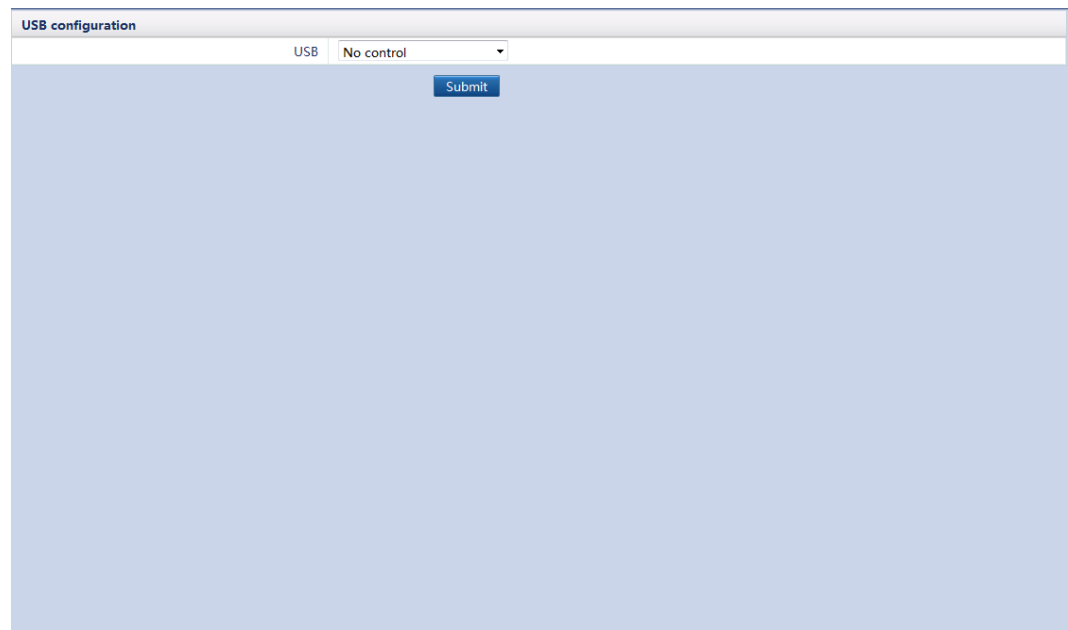

7.10.5 Alarm Output

After an inverter alarm is linked to a DO port, the alarm signal is delivered from the DO port when the inverter generates the alarm.

Because of permission restriction, log in as **Advanced User**. Choose **Settings > Alarm Output**.

NOTE

- Before linking an inverter alarm to a DO port, ensure that the DO port is not set for other purposes. Otherwise, the setting will fail.
- After the function is enabled, the DO port status may change and the alarm output may be abnormal if the SmartLogger restarts or powers off.

Figure 7-60 Alarm output

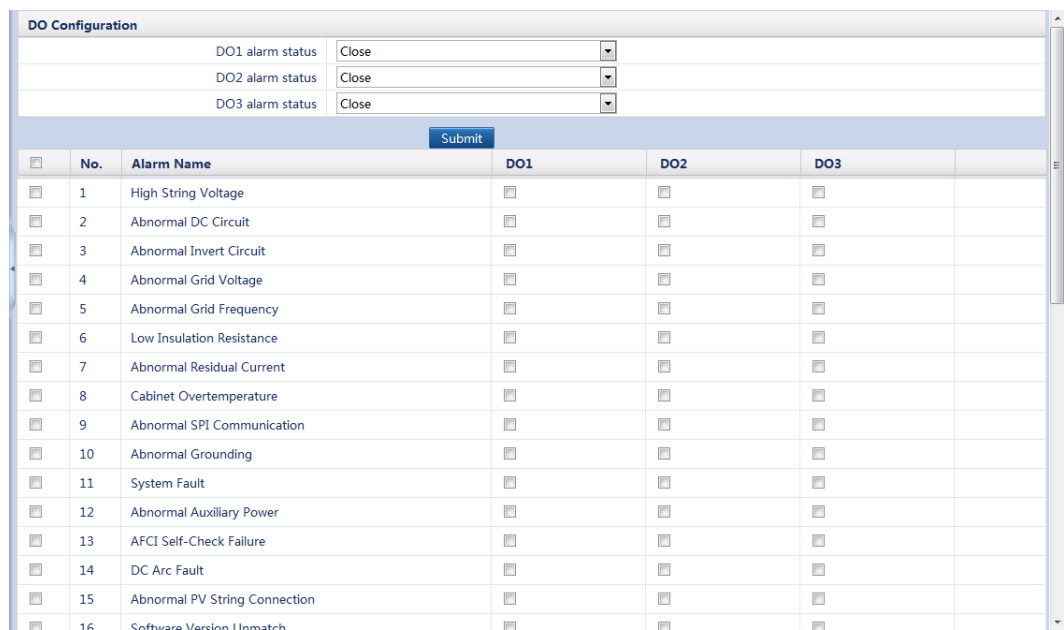

DO Configuration						
		DO1 alarm status	Close			
		DO2 alarm status	Close			
		DO3 alarm status	Close			
<input type="button" value="Submit"/>						
<input type="checkbox"/>	No.	Alarm Name	DO1	DO2	DO3	
<input type="checkbox"/>	1	High String Voltage	<input type="checkbox"/>	<input type="checkbox"/>	<input type="checkbox"/>	
<input type="checkbox"/>	2	Abnormal DC Circuit	<input type="checkbox"/>	<input type="checkbox"/>	<input type="checkbox"/>	
<input type="checkbox"/>	3	Abnormal Invert Circuit	<input type="checkbox"/>	<input type="checkbox"/>	<input type="checkbox"/>	
<input type="checkbox"/>	4	Abnormal Grid Voltage	<input type="checkbox"/>	<input type="checkbox"/>	<input type="checkbox"/>	
<input type="checkbox"/>	5	Abnormal Grid Frequency	<input type="checkbox"/>	<input type="checkbox"/>	<input type="checkbox"/>	
<input type="checkbox"/>	6	Low Insulation Resistance	<input type="checkbox"/>	<input type="checkbox"/>	<input type="checkbox"/>	
<input type="checkbox"/>	7	Abnormal Residual Current	<input type="checkbox"/>	<input type="checkbox"/>	<input type="checkbox"/>	
<input type="checkbox"/>	8	Cabinet Overtemperature	<input type="checkbox"/>	<input type="checkbox"/>	<input type="checkbox"/>	
<input type="checkbox"/>	9	Abnormal SPI Communication	<input type="checkbox"/>	<input type="checkbox"/>	<input type="checkbox"/>	
<input type="checkbox"/>	10	Abnormal Grounding	<input type="checkbox"/>	<input type="checkbox"/>	<input type="checkbox"/>	
<input type="checkbox"/>	11	System Fault	<input type="checkbox"/>	<input type="checkbox"/>	<input type="checkbox"/>	
<input type="checkbox"/>	12	Abnormal Auxiliary Power	<input type="checkbox"/>	<input type="checkbox"/>	<input type="checkbox"/>	
<input type="checkbox"/>	13	AFCI Self-Check Failure	<input type="checkbox"/>	<input type="checkbox"/>	<input type="checkbox"/>	
<input type="checkbox"/>	14	DC Arc Fault	<input type="checkbox"/>	<input type="checkbox"/>	<input type="checkbox"/>	
<input type="checkbox"/>	15	Abnormal PV String Connection	<input type="checkbox"/>	<input type="checkbox"/>	<input type="checkbox"/>	
<input type="checkbox"/>	16	Software Version Mismatch	<input type="checkbox"/>	<input type="checkbox"/>	<input type="checkbox"/>	

Table 7-11 Mapping between alarm names and inverter alarms

No.	Alarm Name	Inverter Alarm	No.	Alarm Name	Inverter Alarm
1	High String Voltage	<ul style="list-style-type: none"> • High String Voltage • High DC Input Voltage 	2	Abnormal DC Circuit	Abnormal DC Circuit
3	Abnormal Invert Circuit	Abnormal Inv. Circuit	4	Abnormal Grid Voltage	Abnormal Grid Voltage
5	Abnormal Grid Frequency	Abnormal Grid Freq.	6	Low Insulation Resistance	Low Insulation Resistance
7	Abnormal Residual Current	Abnormal Residual Current	8	Cabinet Overtemperature	Overtemperature

No.	Alarm Name	Inverter Alarm	No.	Alarm Name	Inverter Alarm
9	Abnormal SPI Communication	Abnormal SPI Communication	10	Abnormal Grounding	Abnormal Grounding
11	System Fault	System Fault	12	Abnormal Auxiliary Power	Abn. Auxiliary Power
13	AFCI Self-Check Failure	AFCI Self-Check Failure	14	DC Arc Fault	DC Arc Fault
15	Abnormal PV String Connection	Abnormal PV String Connection	16	Software Version Unmatch	Software Ver. Unmatch
17	Upgrade Failed	Upgrade Failed	18	License Expired	License Expired
19	String Reverse Connection	<ul style="list-style-type: none">String ReversedString 1–8 Reversed	20	String Backfeed	<ul style="list-style-type: none">String BackfeedString 1–8 Reversed
21	Abnormal String Power	<ul style="list-style-type: none">Abnormal String PowerAbnormal String 1–8	22	Phase Wire Short-Circuited to PE	Phase Wire Short-Circuited to PE
23	Grid Loss	Grid Failure	24	Grid Undervoltage	Grid Undervoltage
25	Grid Overvoltage	Grid Overvoltage	26	Grid Voltage Imbalance	Grid Voltage Imbalance
27	Grid Overfrequency	Grid Overfrequency	28	Grid Underfrequency	Grid Underfrequency
29	Unstable Grid Frequency	Unstable Grid Frequency	30	Output Overcurrent	Output Overcurrent
31	Output DC Component Overhigh	Output DC Component Overhigh	32	Device Fault	Device Fault
33	Faulty Power Collector	Faulty Power Collector	34	Abnormal Battery	Abnormal Battery
35	Faulty Monitoring Unit	<ul style="list-style-type: none">Monitoring Unit FaultyFlash Fault	36	Active Islanding	Active Islanding
37	Passive Islanding	Passive Islanding	38	Transient AC Overvoltage	Transient AC Overvoltage

7.10.6 Setting Extended Ports



NOTICE

Before setting extended ports, ensure that the SmartLogger connects to an analog-to-digital converter (for example, ADAM4117) that supports the Modbus-RTU protocol.

Because of permission restriction, log in as **Special User**. Choose **Settings > Extended Port Settings** to access the target page.

Figure 7-61 Setting extended ports

Port d'expansion AI					
No.	Port	485Port	485Address	Register Address	Port Specifications
1	AI3	<input type="text" value="0"/> (0~3,0:Disable)	<input type="text" value="247"/> (0~247)	<input type="text" value="5"/> (0~7)	(0~20mA) <input type="button" value="v"/>
2	AI4	<input type="text" value="0"/> (0~3,0:Disable)	<input type="text" value="247"/> (0~247)	<input type="text" value="5"/> (0~7)	(0~20mA) <input type="button" value="v"/>

AO Expansion Port					
No.	Port	485Port	485Address	Register Address	Port Specifications
1	AO1	<input type="text" value="0"/> (0~3,0:Disable)	<input type="text" value="247"/> (0~247)	<input type="text" value="5"/> (0~7)	(0~20mA) <input type="button" value="v"/>
2	AO2	<input type="text" value="0"/> (0~3,0:Disable)	<input type="text" value="247"/> (0~247)	<input type="text" value="5"/> (0~7)	(0~20mA) <input type="button" value="v"/>
3	AO3	<input type="text" value="0"/> (0~3,0:Disable)	<input type="text" value="247"/> (0~247)	<input type="text" value="5"/> (0~7)	(0~20mA) <input type="button" value="v"/>
4	AO4	<input type="text" value="0"/> (0~3,0:Disable)	<input type="text" value="247"/> (0~247)	<input type="text" value="5"/> (0~7)	(0~20mA) <input type="button" value="v"/>
5	AO5	<input type="text" value="0"/> (0~3,0:Disable)	<input type="text" value="247"/> (0~247)	<input type="text" value="5"/> (0~7)	(0~20mA) <input type="button" value="v"/>

7.10.7 Dry contact remote shutdown

You can remotely shut down dry contacts on the WebUI.

The SmartLogger provides eight DI ports, that is, DI1 (GND1) to DI4 (GND1) and DI1 (GND2) to DI4 (GND2). The OVGR can be connected to any DI port, as shown in [Figure 7-62](#).

Figure 7-62 Networking

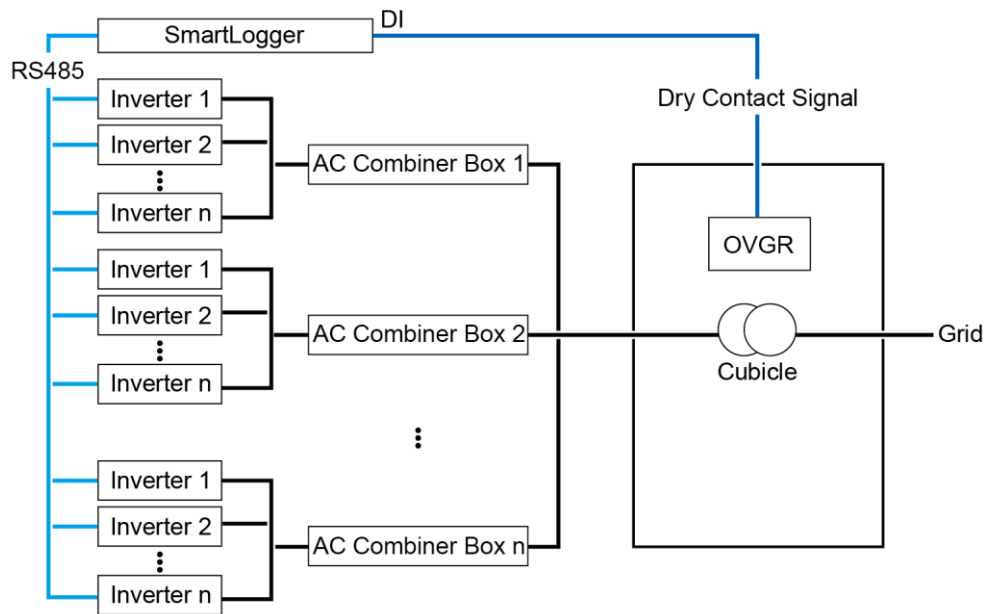

IL01IC3020

Figure 7-63 shows the DI ports of the SmartLogger.

Figure 7-63 DI ports of the SmartLogger

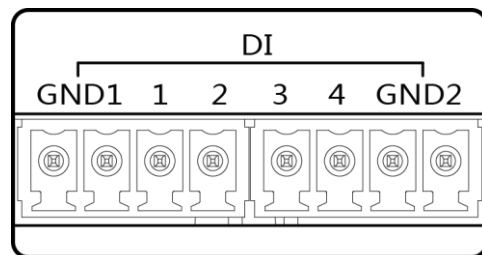

IL01WC0008

Table 7-12 describes the DI ports.

Table 7-12 DI port description

Port	Functions
GND1	Dry contact input common terminal 1, used for active power derating for DI1–DI4
1	DI_1
2	DI_2
3	DI_3
4	DI_4

Port	Functions
GND2	Dry contact input common terminal 2, used for reactive power compensation for DI1–DI4



NOTICE

Before setting the function of remote shutdown over dry contacts in the following method, ensure that **Dry contact remote control** is not set in [8 Power Grid Scheduling](#).

On the **Settings** tab page, select **Dry Contact Remote Shut** and set relevant parameters, as shown in [Figure 7-64](#). Because of permission restriction, log in as **Special User**.

Figure 7-64 Dry contact remote shutdown

Dry Contact Remote Shutdown	
connection port	None
Effective dry contact status	Open
OVGR Shutdown Setting	Disable
Cubicle alarm enabling	Disable



NOTE

- The OVGR sends dry contact signals and can be connected to any DI port of the SmartLogger. Set related parameters based on the actual connection between the OVGR and the SmartLogger. Otherwise, the dry contact remote shutdown function cannot be implemented.
- Set **Connection port** based on the actual connection between the OVGR and the SmartLogger.
- **Effective dry contact status** can be set to **Close** or **Open**. If **OVGR Shutdown Setting** is set to **Enable** and **Effective dry contact status** is set to **Close**, the SmartLogger sends the inverter remote shutdown command only when the DI port specified by **connection port** is closed.
- **OVGR Shutdown Setting** can be set to **Enable** or **Disable**. Set **OVGR Shutdown Setting** as required.
- **Cubicle alarm enabling** can be set to **Enable** or **Disable**. If **Cubicle alarm enabling** is set to **Enable**, if the dry contact signal is effective and the Cubicle is abnormal, an alarm indicating abnormal Cubicle is generated.

7.10.8 Setting DI Parameters

You can configure parameters for DI ports over the WebUI.

- When a valid level is delivered into a DI port, an alarm is generated. You can set the alarm name and severity.
- A DI port starts or shuts down the inverter using OVGR signals.

The SmartLogger provides eight DI ports, that is, DI1 (GND1) to DI4 (GND1) and DI1 (GND2) to DI4 (GND2). For the connection method, see [4.10 Connecting the SmartLogger to a Ripple Control Receiver](#).

Because of permission restriction, log in as **Special User**. Choose **Settings > DI** to access the target page.

Figure 7-65 Setting DI parameters

DI Port Configuration							
DI	Activation Status	Dry Contact Status	Alarm Generation	Alarm Severity	Trigger Shutdown	Trigger Startup	Alarm Name
DI1(GND1)	Disable	Open	Disable	Major	Disable	Disable	
DI2(GND1)	Disable	Open	Disable	Major	Disable	Disable	
DI3(GND1)	Disable	Open	Disable	Major	Disable	Disable	
DI4(GND1)	Disable	Open	Disable	Major	Disable	Disable	
DI1(GND2)	Disable	Open	Disable	Major	Disable	Disable	
DI2(GND2)	Disable	Open	Disable	Major	Disable	Disable	
DI3(GND2)	Disable	Open	Disable	Major	Disable	Disable	
DI4(GND2)	Disable	Open	Disable	Major	Disable	Disable	

Startup Delay	
Startup delay	<input type="text" value="300"/> (0-1800)s

NOTE

If a DI port is activated, **Dry contact remote control** in [7.10.7 Dry contact remote shutdown](#), [8 Power Grid Scheduling](#), and [7.10.9 Setting Export Limitation Parameters](#) cannot be set again. If a DI port has been set to **Dry contact remote control** in [7.10.7 Dry contact remote shutdown](#) or [7.10.7 Dry contact remote shutdown](#), or has been set in [7.10.9 Setting Export Limitation Parameters](#), it cannot be set here again.

- To enable the DI port function, set **Activation Status** to **Activated**, and set **Alarm Generation**, **Power off**, **Power on** to **Enable**.
- When **Dry Contact Status** is set to **Close**, the SmartLogger sends a shutdown or alarm command to the inverter if the external input dry contact is closed. It sends a start command to the inverter if the external input dry contact is open.
- When **Dry Contact Status** is set to **Open**, the SmartLogger sends a shutdown or alarm command to the inverter if the external input dry contact is open. It sends a start command to the inverter if the external input dry contact is closed.
- **Startup delay**: specifies the time for the SmartLogger to send a start command to the inverter.

NOTE

When using multiple DI ports, ensure that the shutdown signal of each port and OVGR shutdown in [7.10.7 Dry contact remote shutdown](#) have recovered. The SmartLogger then sends a start command to the inverter.

Alarm Name is set to **DI X (GND X) custom alarm** by default on the SmartLogger WebUI and LCD, which can be changed by the user. If **Alarm Name** has been changed by the user, the new name is displayed on the WebUI but the default name is displayed on the LCD.

7.10.9 Setting Export Limitation Parameters

Network Application

When the PV plant itself generates power for private use only, the loads cannot consume all the power and countercurrent may feed into the power grid. Therefore, users need to set the export limitation parameters over the WebUI to prevent countercurrent.

- Scenario without a circuit breaker: The countercurrent feeding into the power grid can be eliminated by sending a command from the SmartLogger to lower the inverter output power.
- Scenario with a circuit breaker: When the countercurrent feeding into the power grid cannot be eliminated by sending a command from the SmartLogger to lower the inverter output power, and the **Maximum protection time** is exceeded, the SmartLogger drives the relay to switch off the circuit breaker by controlling the DO port. When the DI port detects that the circuit breaker is open, the DO port and relay on the SmartLogger will be switched off, and the SmartLogger will restore to the initial state.

Figure 7-66 Network diagram (without a circuit breaker)

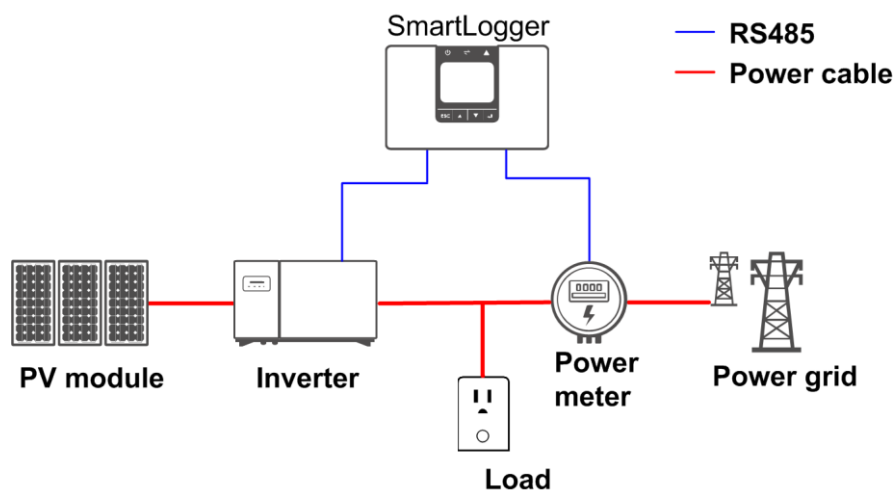
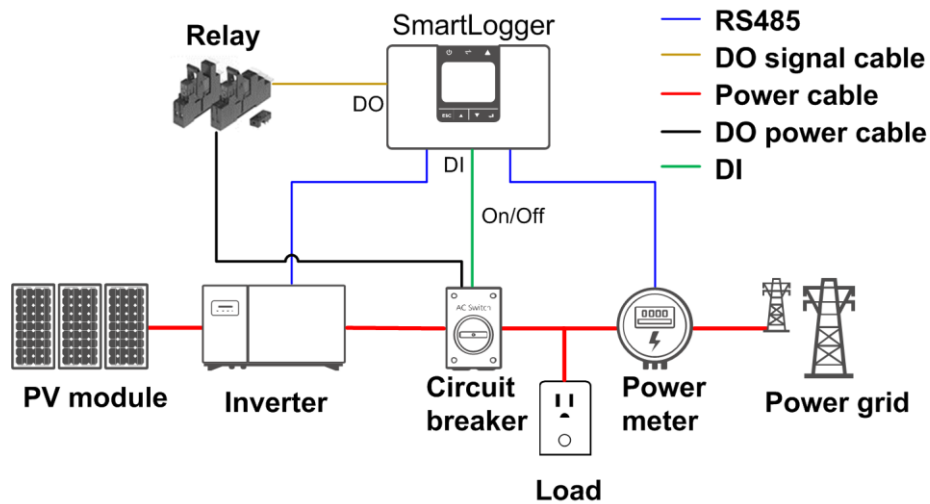

Figure 7-67 Network diagram (with a circuit breaker)



NOTICE

In the scenario with circuit breaker, put the power supply position of the SmartLogger before the circuit breaker to avoid the SmartLogger power-off after the DO control circuit breaker is switched off.

Setting Parameters



NOTE

Before setting the parameters, ensure that the Modbus power meter and inverter are connected to the WebUI. Then take the following steps to complete the settings.

1. Log in as **Advance User**, and choose **Monitoring > SUN2000 > Running Param. > Feature Parameters**. On the displayed page, set **Communication interrupt shutdown** and **Communication resumed startup** to **Enable**, and set **Communication interruption duration** as required.
2. Log in as **Special User**, and choose **Monitoring > SUN2000 > Running Param. > Power Adjustment**. On the displayed page, set **Active power change gradient**. If the maximum parameter is 50%/s, set to the maximum. If it is 1000%/s, set to 125%/s.
3. Log in as **Special User**, and choose **Settings > Active power control** to go to the page. Ensure that **Active power control** is set to **Disable**.

Because of permission restriction, log in as **Special User**. Choose **Settings > Export Limitation** to go to the page.

Figure 7-68 Setting export limitation parameters

Export Limitation		
Export Limitation	Enable	▼
Control policy	Strategy 1	▼
Status	Normal	
Common Parameters		
Power Meter	Smart meter	▼
Electric meter power direction	Positive	▼
Maximum grid feed-in power	0.000	(0.000-1000.000)kW
Power lowering adjustment period	0.5	(0.2-300.0)s
Maximum protection time	3.0	(2.0-300.0)s
Power raising threshold	5.000	(0.001-50.000)kW
Power raising gradient	5.0	(0.1-100.0)%/s
Power raising adjustment period	1.0	(0.2-999.9)s
Extended Param.		
Power limit for abnormal electric meter	100.0	(0.0-100.0)%
Switch-off with 0% power limit	Disable	▼
Switch-off control port	No	▼
Switch-on control port	No	▼
Switch-off state feedback port	No	▼
Switch-on state feedback port	No	▼
<input type="button" value="Submit"/>		
Circuit breaker operation		
<input type="button" value="Switch off"/> <input type="button" value="Switch on"/>		

Parameter	Description
Power Meter	If Export Limitation is set to Enable , set Power Meter to Smart meter . Otherwise the function would not take effect.
Electric meter power direction	When the inverter has no output power, set this parameter to positive if the active power reading of the power meter is positive. Otherwise, set this parameter to reverse.
Maximum grid feed-in power	Setting the maximum power that the inverter can feed into the power grid. Suggestion: Set this parameter based on the countercurrent threshold allowed by the power grid company.
Power lowering adjustment period	Setting the inverter output power lowering period.
Maximum protection time	Setting the maximum duration from the time the SmartLogger detects countercurrent to the time it controls the inverter output power to reach 0. Suggestion: Set this parameter based on the maximum countercurrent duration allowed by the power grid company.
Power raising threshold	Setting the inverter output power raising threshold.
Power raising gradient	Setting the inverter output power raising speed.

Parameter	Description
Power raising adjustment period	Setting the inverter output power raising period.
Power limit for abnormal electric meter	Setting the inverter output power percentage controlled by the SmartLogger when communication between the SmartLogger and the power meter is abnormal.
Switch-off with 0% power limit	Setting whether to switch off the DO port. When this parameter is set to Enable , the settings of the Switch-off control port , Switch-on control port , Switch-off state feedback port , and Switch-on state feedback port are also enabled.

7.11 Maintenance

7.11.1 Upgrading Firmware

You can upgrade the firmware of the SmartLogger, inverter, PLC module, or PID module over the WebUI.

Because of permission restriction, log in as **Advanced User** or **Special User**. Choose **Maintenance > Firmware Upgrade** to access the target page.

Figure 7-69 Firmware upgrade

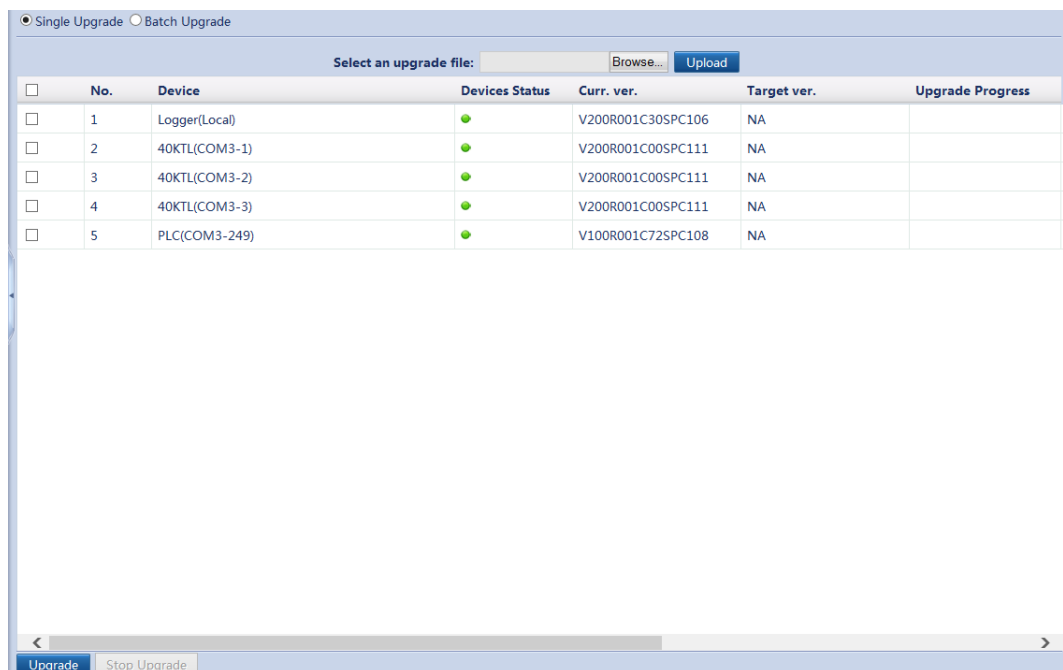

Single Upgrade

1. Click **Single Upgrade**.
2. Select the name of the device that requires a firmware upgrade.



NOTICE

The Single Upgrade mode does not apply to two or more types of devices each time. For example, you cannot select both the inverter and PLC module.

-
3. Select the upgrade file.
 4. Click **Upgrade**.



NOTE

The **Stop Upgrade** function is only effective for the devices waiting to be upgraded.

Batch Upgrade



NOTE

- The inverter that can be upgraded in batches on the SmartLogger must be SUN2000 V100R001C11SPC409, SUN2000 V100R001C81SPC101 and its later patch versions, or SUN2000 V200R001C00 and its later patch versions.
- Besides the 1000 V inverters, other inverters can also be upgraded with the rest of the devices one by one or in batches on the **Batch Upgrade** page.

1. Click **Batch Upgrade**.
2. Select the upgrade file.
3. Click **Upgrade**.

7.11.2 Product Information

Choose **Maintenance > Product Information** and query SmartLogger information on the displayed page.

Figure 7-70 Product information



Product Information	
SN	2102310PQW10EB000368
Device Type	SmartLogger1000
Firmware Version	V100R001C005PC111

7.11.3 Setting Security Parameters

Choose **Maintenance > Security Settings** to access the target page.

Figure 7-71 Setting security parameters

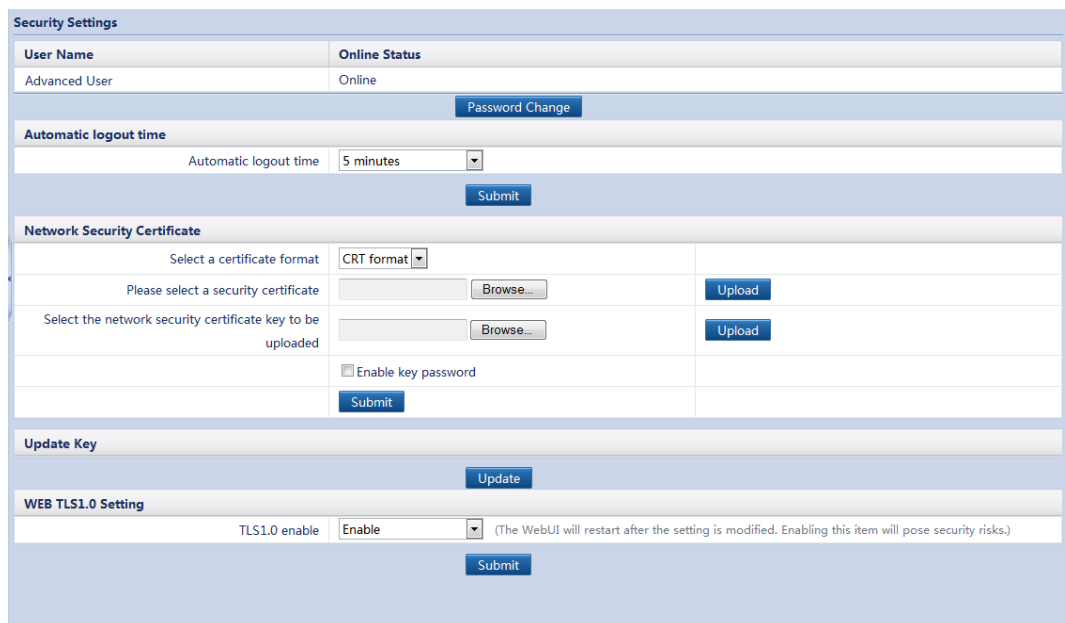

Security Settings	
User Name	Advanced User
Online Status	Online
Password Change	
Automatic logout time	
Automatic logout time	5 minutes
Submit	
Network Security Certificate	
Select a certificate format	CRT format
Please select a security certificate	<input type="text"/> Browse... Upload
Select the network security certificate key to be uploaded	<input type="text"/> Browse... Upload
<input type="checkbox"/> Enable key password	
Submit	
Update Key	
Update	
WEB TLS1.0 Setting	
TLS1.0 enable	Enable
(The WebUI will restart after the setting is modified. Enabling this item will pose security risks.)	
Submit	



NOTE

- The initial password is *Changeme* for system users **Common User**, **Advanced User**, and **Special User**.

- After the first login, change the initial password immediately to ensure account security.
- You are advised to change the password at least once every half a year to prevent unauthorized use of your account and impact on system security.
- After **Automatic logout time** is set, a user is automatically logged out if the user does not perform any operation within the specified time period.
- You are advised to use the existing network security certificate and key.

Change the password in compliance with the following rules:

- Containing 6 to 20 characters
- A combination of at least two types of digits, uppercase letters, and lowercase letters
- Different from the old password

7.11.4 System Maintenance

Because of the permission restriction, log in as **Advanced User** or **Special User**. Choose **Maintenance > System Maint.**

Figure 7-72 System maintenance

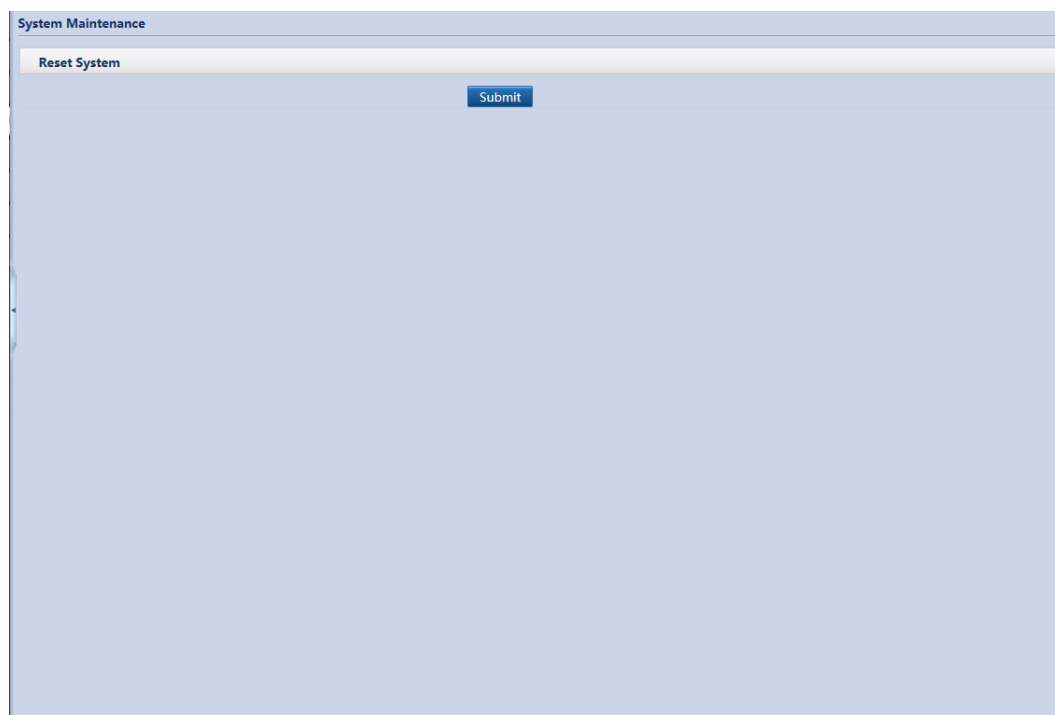

 **NOTE**

The login password is required if you need to send a system maintenance command.

7.11.5 Device Log

Because of permission restriction, log in as **Advanced User** or **Special User**. Choose **Maintenance > Device Log** to access the target page.

Figure 7-73 Device log

Select	No.	Device	SN	Devices Status	Progress	Execution Status
<input type="checkbox"/>	1	Logger(Local)	2102311HJ810G5000169	●		
<input type="checkbox"/>	2	PLC(COM0-249)	PLC002311HJ8G5000169	●		
<input type="checkbox"/>	3	33KTL(COM1-1)	21010729676TGC901210	●		
<input type="checkbox"/>	4	V2R1-40K(COM1-2)C	21010725036TF9906250	●		

Export Log Stop Export Log archiving

7.11.6 Site Test

After a inverter is put into use, it should be inspected periodically to detect any potential risks and problems. The SmartLogger can inspect inverters over the WebUI.

Because of permission restriction, log in as **Advanced User** or **Special User**. Choose **Maintenance > Onsite Test** to access the target page.

Figure 7-74 Site test

	No.	Device	SN	Devices Status	Progress	Execution Status	Start time
<input type="checkbox"/>	1	20KTL(COM1-1)	INV_2000V1R1C00_0001	●			
<input type="checkbox"/>	2	40KTL(COM1-2)	INV_2000V2R1C00_0002	●			
<input type="checkbox"/>	3	28KTL(COM1-3)	INV_2000V1R1C81_0003	●			
<input type="checkbox"/>	4	50KTL(COM1-4)	INV_2000V2R2C00_0004	●			
<input type="checkbox"/>	5	40KTL-JP(COM1-5)	INV_2000V2R2C01_0005	●			
<input type="checkbox"/>	6	40KTL-US(COM1-6)	INV_2000V2R2C20_0006	●			
<input type="checkbox"/>	7	60KTL(COM1-7)	INV_20HAV1R1C00_0007	●			



NOTE

- The spot-check function is available only for the inverter for which **Grid Code** is set to **Japan standard**.
- You can click the Select icon in the upper left corner of the page to select an inspection mode.

7.11.7 Managing the License

You can view the inverter license information and manage the license on the WebUI.

Because of permission restriction, log in as **Advanced User** or **Special User**. Choose **Maintenance > License Management**.

- To view the inverter license information, tap **License information**.
- To apply for a license, tap **License application** and export a license application file, as shown in [Figure 7-75](#).
- To load the obtained license to the inverter, tap **License loading**, as shown in [Figure 7-76](#).
- To revoke the license or export the revocation code file, tap **License revocation**.

Figure 7-75 Applying for a license

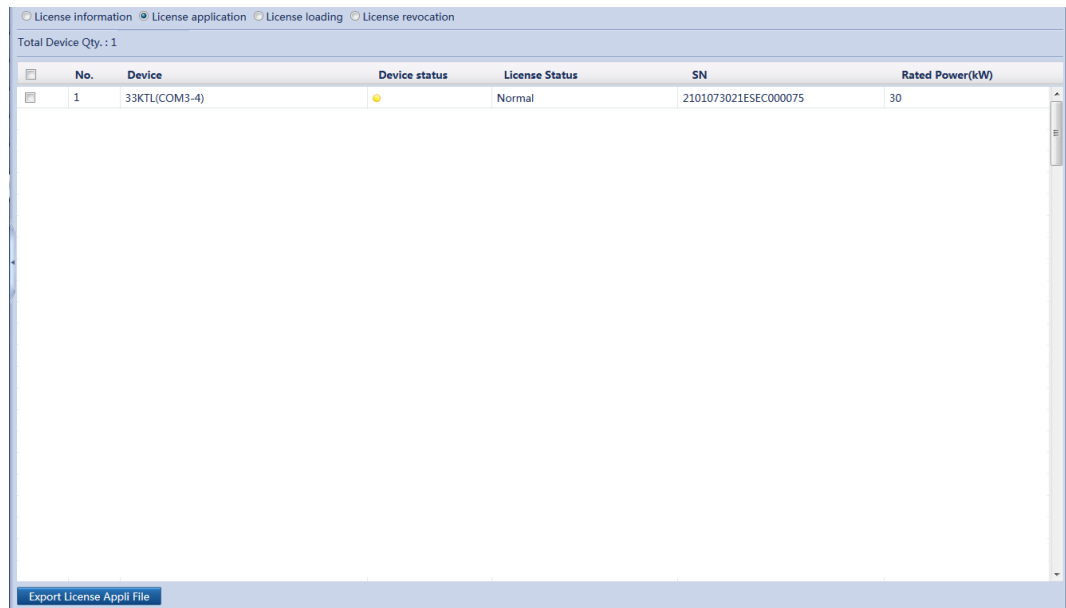

For the inverter with no license, you can export the application file and apply for a license on the Electronic Software Delivery Platform (ESDP).

Figure 7-76 Loading a license

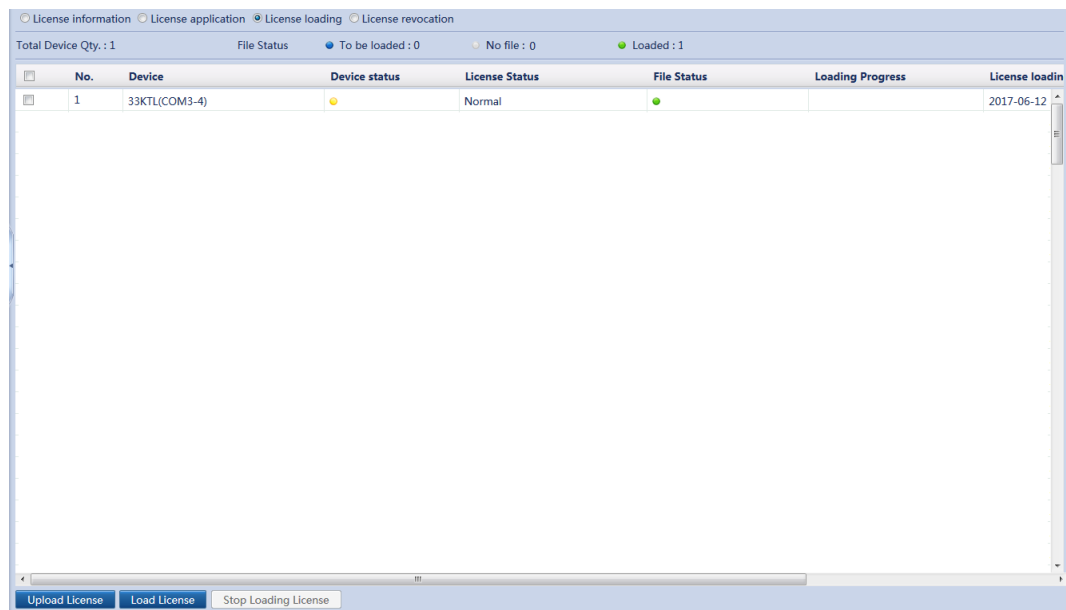

To load a license to the inverter, perform the following steps:

1. Import the license file.
2. Select the inverter whose **File Status** is **To be loaded**.
3. Load the license.

**NOTE**

Ensure that the extension of the license file to be imported is .dat or .zip.

7.11.8 Device Management

7.11.8.1 Connecting Devices

Because of permission restriction, log in as **Advanced User** or **Special User**. Choose **Maintenance > Connect Device** to access the target page.

Figure 7-77 Connecting devices

No.	Device	Port-Comm Addr./IP address	SN	Devices Status
1	Meter(COM3-1)	3-1	AM1V20064900hwappyan	●
2	PID(COM3-2)	3-2	SOUTH_DEVICE_PID_002	●
3	28KTL(COM3-3)	3-3	INV_2000V1R1C81_0003	●
4	40KTL(COM3-4)	3-4	INV_2000V2R2C00_0004	●
5	50KTL(COM3-5)	3-5	INV_2000V2R2C00_0005	●
6	40KTL-JP(COM3-6)	3-6	INV_2000V2R2C01_0006	●
7	EMI(COM3-7)	3-7	EM1V20064900hwappyan	●
8	PLC(COM3-249)	3-249	SOUTH_DEVICE_PLC_249	●

**NOTE**

- Huawei devices can be automatically detected or manually added. The EMI, power meter, slave SmartLogger, and third-party devices cannot be automatically detected. You need to add them manually.
- Before manually adding an EMI connected over the COM port, set RS485 parameters correctly by following the instructions in [7.10.2.2 Setting RS485 Parameters](#). When adding an EMI, set **Device Type** to **EMI**. After adding an EMI manually, correctly set the EMI parameters. For details, see [7.10.2.3 Setting EMI Parameters](#).
- Before manually adding the Modbus or DL/T645 power meter, set RS485 parameters correctly by following the instructions in [7.10.2.2 Setting RS485 Parameters](#). Before manually adding the Modbus power meter, correctly set the power meter parameters. For details, see [7.10.2.4 Setting Power Meter Parameters](#). When adding a power meter, set **Device Type** to **Power Meter** and **Comm.protocol** to the protocol supported by the power meter.
- When manually adding a slave SmartLogger, correctly set Modbus TCP parameters. Set **Link setting** to **Enable**, and set the client IP address to the IP address for the slave SmartLogger. For details, see [7.10.2.6 Setting Modbus TCP Parameters](#). When adding a slave SmartLogger, set **Device Type** to **SmartLogger** and set **IP Address** to the IP address of the slave SmartLogger.
- When connecting a third-party device, you need to import a configuration file for the device and then manually add the device.
- An accessed device can be removed manually, and a removed device can be added again.

- **Auto Assign Address** allows you to adjust device addresses based on serial numbers. If a device cannot access due to address conflict, perform this operation to assign a new device address and then access the device.
- After a device is connected, you can export the configurations for the device. If you need to change the name of the exported file, retain the extension **.cfg**. Otherwise, the file will be unavailable.
- You can click the Start, Stop, or Reset icon to send the corresponding command to all SUN2000s connected to the SmartLogger. The login password is required if you need to send a command.

7.11.8.2 Device List

Because of permission restriction, log in as **Advanced User** or **Special User**. Choose **Maintenance > Device list** to access the target page.

Figure 7-78 Device list

No.	Device	port	Comm Address	Logical addr.	Transformer No.	Winding No.	SN	Device status
1	PLC(COM0-249)	0	249	1	511	6	PLC002311WSWG4654123	●



NOTE

You can modify the device name and address on the WebUI, or export a device information file in CSV format and import the CSV file into the WebUI after modification.

7.11.8.3 Exporting Parameters

Because of permission restriction, log in as **Advanced User** or **Special User**. Choose **Maintenance > Export Param.** to access the target page.

Figure 7-79 Exporting data

Total Device Qty.:1				
☑ SUN2000				
No.	Device	SN	Devices Status	
1	33KTL(COM1-1)	21010729676TGC901210		

Export Log archiving



NOTE

You can export configuration parameters of multiple inverters to a .csv file. Site engineers can then check whether the inverter configurations are correct in the exported file.

7.11.8.4 Clearing Alarms

If you need to clear the active and historical alarms of certain or all devices connecting to the SmartLogger, and re-collect alarm data, perform this operation.

Because of permission restriction, log in as **Advanced User** or **Special User**. Choose **Maintenance > Alarm Clear** to access the target page.

Figure 7-80 Clearing alarms

Total Device Qty.:2				
<input type="checkbox"/> All	No.	Device	SN	Device status
<input type="checkbox"/>	1	Logger(Local)	2102311RTD10GB000012	●
<input type="checkbox"/>	2	60KTL(PLC-1)	21010735286TG8900003	●



NOTICE

- By clearing alarms, users can clear all active and historical alarms for the selected device and enable the SmartLogger to re-collect alarm data.
- By clearing alarms, users can clear the local SmartLogger alarms or device storage alarms. If the version of the SUN2000-(8KTL-28KTL) is earlier than SUN2000 V100R001C81, users can only clear local SmartLogger alarms by performing the operation.
- If **Alarm Clear** is performed for the Huawei devices such as the inverter and PID, **Alarm Reset** must be performed on the NMS. Otherwise the SmartLogger cannot collect alarm data from the devices after alarms are cleared.
- If **Alarm Clear** is performed for the SmartLogger, **Alarm Reset** must be performed on the NMS. Otherwise the SmartLogger cannot collect alarm data from the devices after **Alarm Reset** is performed.

7.11.8.5 Re-collecting Performance Data

You can re-collect previous performance data and energy yield over the WebUI.



NOTE

This function is not applicable to the SUN2000-(8KTL-28KTL) inverter.

Because of permission restriction, log in as **Advanced User** or **Special User**. Choose **Maintenance > Collect Perf. Data** to access the target page.

Figure 7-81 Re-collecting performance data

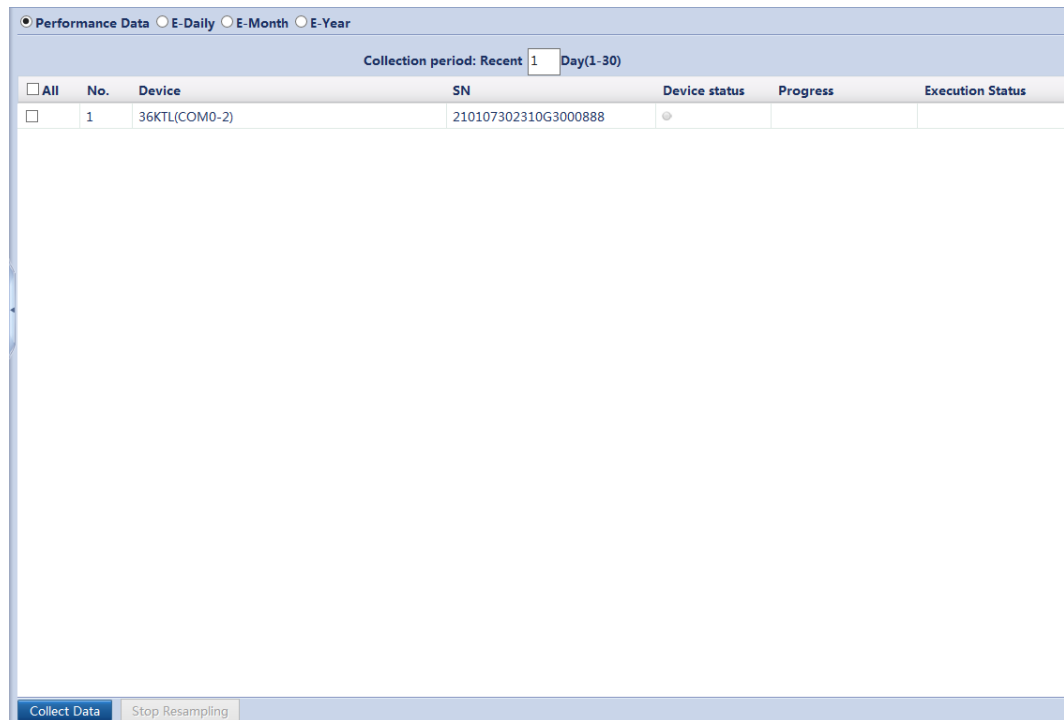

 **NOTE**

You can re-collect the performance data of devices on the **Performance Data** page. You can re-collect the energy yields of devices by **E-Daily**, **E-Month**, or **E-Year**. Set **Collection period** before re-collecting them. You can query the re-collection results on the **Monitoring** page.



NOTICE

When the performance data is being re-collected after the software version of the SUN2000-33KTL/40KTL upgrades from SUN2000 V200R001C00SPCXXX to SUN2000 V200R001C90SPCXXX, you cannot query the daily energy yield generated before the upgrade of the software version.

7.11.8.6 Correcting the Total Energy Yield

Because of permission restriction, log in as **Advanced User** or **Special User**. Choose **Maintenance > Adjust total energy yield** to access the target page.

Figure 7-82 Correcting the total energy yield

<input type="checkbox"/> All	No.	Device	Device status	E-Total(kWh)	Adjust total energy yield(kWh)	
<input type="checkbox"/>	1	36KTL(COM0-2)	●	2256.10	<input type="text" value="0.00"/>	(0-42949600)

8 Power Grid Scheduling

8.1 Power Adjustment Description

According to standard requirements, the SmartLogger can reliably adjust power for the connected inverters in real time to ensure that the PV plant can respond to requirements of the power grid company in a timely manner.

Two power grid scheduling modes are available: active power control and reactive power control.



NOTICE

To ensure that the SmartLogger will deliver scheduling commands to the connected inverters, you must enable active or reactive power control before adjusting the active or reactive power for a PV plant. If you disable active or reactive power control, the SmartLogger will not deliver scheduling commands to the connected inverters and the inverters will retain their status after the previous change.

Active Power Control

If the PV plant has requirements of power limitation, the power grid scheduling personnel should limit the active power or disable all the active power for the PV plant, that is, to enable the active power derating mode.

Because of permission restriction, log in as **Special User**. Choose **Settings > Active power control** to access the target page.

Figure 8-1 Active power control

Active power control	
Active power control	Enable
Active power control mode	Disable active power reduction

Reactive Power Control

Large-scale PV plants are required to adjust the voltage at the grid-tied point. Power grid scheduling personnel enable the PV plant to absorb or add the reactive power at the grid-tied point, that is, to enable the reactive power compensation, based on the real-time reactive power transmission status in the power grid.

Because of permission restriction, log in as **Special User**. Choose **Settings > Reactive power control** to access the target page.

Figure 8-2 Reactive power control

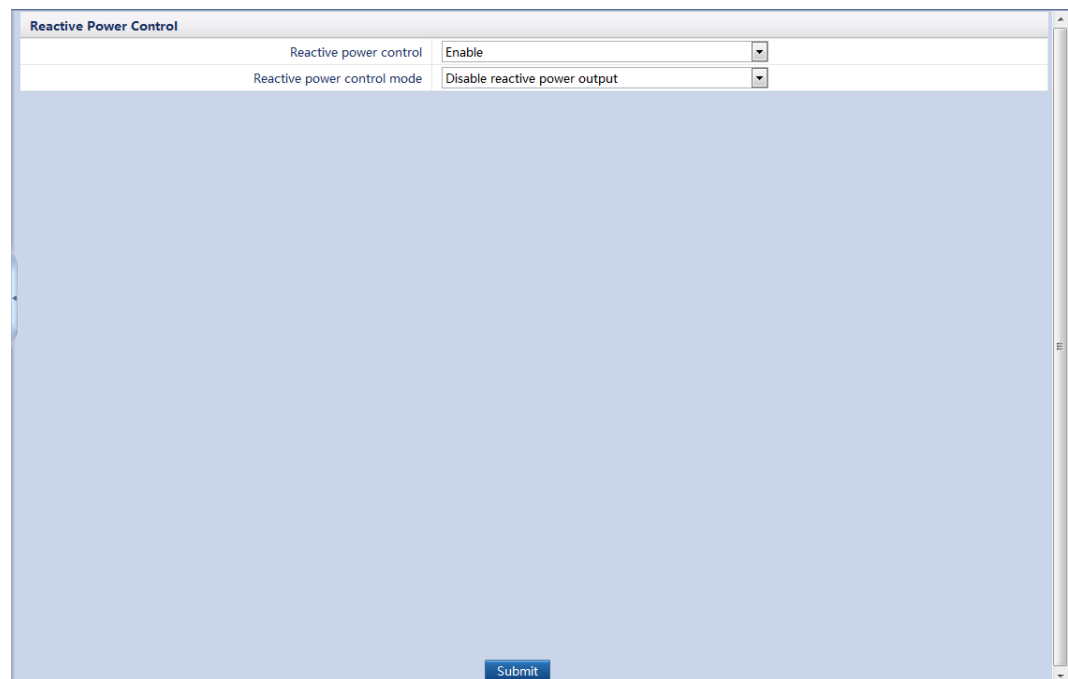

8.2 Active Power Adjustment



NOTICE

Before setting **Active power control mode**, set **Active power control** to **Enable**.

8.2.1 Disabling Active Power Derating

If the inverter is required to run full load, set **Active power control mode** to **Disable active power reduction**.

Figure 8-3 Disabling active power derating

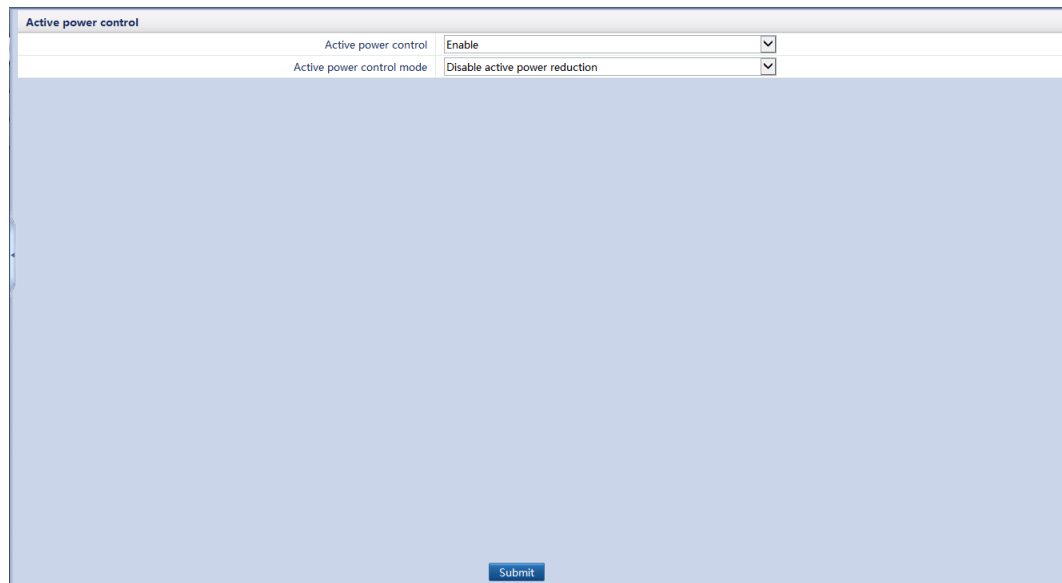

Active power control	
Active power control	Enable
Active power control mode	Disable active power reduction

Submit

8.2.2 Dry Contact Remote Control



NOTICE

- If ports of DI1–DI4 have been configured in [7.10.7 Dry contact remote shutdown](#), **Dry contact remote control** is unavailable.
- Before setting dry contact remote control, ensure that the SmartLogger connects to a correct ripple control receiver. For details, see [4.10 Connecting the SmartLogger to a Ripple Control Receiver](#).

Set **Active power control mode** to **Dry contact remote control**.

Figure 8-4 Dry contact remote control

No.	DI1(GND1)	DI2(GND1)	DI3(GND1)	DI4(GND1)	Percentage(%)
1	<input type="checkbox"/>	<input type="checkbox"/>	<input type="checkbox"/>	<input type="checkbox"/>	<input type="text" value=""/>



NOTE

- A maximum of 16 levels are supported for the percentages.
- "√" indicates a low level. When connecting to GND1, the four DI ports of the SmartLogger are low-level ports. If not connected, the ports are high-level ports.
- The status combination of DI1(GND1)–DI4(GND1) should differ from each other. Otherwise, abnormal command parsing will occur.
- If the actual input DI signal is inconsistent with that configured on the WebUI, the SmartLogger controls the SUN2000 to work at full power and the **Abnormal Active Schedule** alarm is generated.

8.2.3 Percentage Fix Limitation

The SmartLogger provides simplified active power percentage configuration as well as power control automation, that is, to automatically adjust the active power derating percentage in different periods of the day.

If the maximum power output of the inverter needs to be controlled, set **Active power control mode** to **Percentage fix limitation**.

Figure 8-5 Percentage fix limitation

No.	Start time	Percentage(%)
1	00:00:00	100
2	12:00:00	70

NOTE

- If the inverter needs to run with specified maximum power in certain periods of a day, add setting records based on site requirements.
- When multiple time points are set, the inverter will run with the maximum power specified for the time point that is earlier than and the closest to the system current time point. For example, if you add 00:00:00 and 12:00:00 on the WebUI and the system current time point is 14:30:00, the inverter will run with the maximum power specified for 12:00:00.

8.2.4 Remote Scheduling

The NMS or independent power adjustment device sends scheduling commands over the communications port that works with Modbus-TCP or IEC104, without the need of user configuration or operation. The SmartLogger can automatically switch between scheduling modes and send scheduling commands.

When **Active power control mode** is set to **Remote scheduling**, the SmartLogger receives the scheduling commands from the upstream NMS, converts them into valid command data identifiable to the inverters, and then sends the data to all the connected inverters. Based on the principle of preference of remote scheduling, the SmartLogger sets **Active power control mode** to **Remote scheduling** after receiving a scheduling command from the upstream NMS.

Figure 8-6 Remote scheduling

Active power control	
Active power control	Enable
Active power control mode	Remote scheduling
Schedule strategy	Strategy 1
Adjustment coefficient	1.000 (0.900 ~ 1.100)



NOTE

Disable, Strategy 1, and Strategy 2 are available for **Schedule strategy**.

- **Disable:** The SmartLogger controls the inverter to work at full load and will not receive scheduling commands sent by the NMS.
- **Strategy 1:** Open-loop scheduling policy. That is, the SmartLogger evenly allocates the power value from the scheduling and delivers the average values to each inverter, which then operates with the specific power. The adjustment value delivered by the SmartLogger is constant.
- **Strategy 2:** The customized function is provided for a site.

Adjustment coefficient: The power value will be sent to the inverter after being multiplied by the preset coefficient.

8.2.5 AI Remote Control

The remote scheduling command sent by the SmartLogger controls the active power output of the PV plant in analog input mode. Set **Active power control mode** to **AI remote control**.



NOTICE

Before setting this parameter, ensure that the SmartLogger connects to the telecontrol system.

Figure 8-7 AI remote control

Active power control	
Active power control	Disable
Active power control mode	AI remote control
Derated command input port	No
Derated command feedback port	No
Value identification precision	1 %
Power station total rated power (Pn)	6000 kW
Plant overload power (Pmax)	6300 kW
Active control parameters	<input type="button" value="Setting"/>

 **NOTE**

- **Value identification precision** identifies the remote scheduling command variation threshold in the case of active power adjustment to prevent frequent control command sending due to the sampling deviation. Its value range is 1% to 100%.
- **Power station total rated power (Pn)** is the maximum power capacity of the PV plant agreed by the PV plant and the power grid company. Confirm this parameter value with the power grid company and set it correctly.
- If **Reactive power control** is set to **Dry contact remote control**, **AI remote control** is unavailable for **Active power control**.

8.2.6 Remote Output Control



NOTICE

Before setting the parameters for remote output control, synchronize the clock source of the server. For details, see [7.10.1.1 Setting the Date and Time](#).

Figure 8-8 Synchronizing the clock source

Time Synchronization	
Clock source	NTP
Server	
Server2	
Port	123 (1~65535)
Synchronization time interval	1440 min (1~1440)
Latest synchronization status	Success
Latest synchronization time	2000-01-01 00:00:00

1. **Clock source:** Set NTP.
2. **Server:** Set the server IP address or domain name.
3. **NTP synchronization test:** Check the time synchronization status.

Set Active power control mode to Remote output control.

Figure 8-9 Remote Output Control

Active power control	
Active power control	Enable
Active power control mode	Remote output control
Output control duration	10 min(0%->100%)
PV plant ID	
Remote output control server	
PV module capacity	0.000 kW(0~200000)
Latest connection status	Success
Latest connection time	2000-01-01 00:00:00
Present control percentage	0.0 %

 **NOTE**

- **Output control duration:** Set the time required for the inverter to change its output power from 0% to 100% or from 100% to 0%.
- **PV plant ID:** Set the ID assigned by the power company to the SmartLogger.
- **Remote output control server:** Set the server IP address or domain name.
- If the connection between the SmartLogger and the server is abnormal, obtain the output control file in .data format from the website of the power company and import the file.
- After the SmartLogger connects to the server, you can export the relevant file.

8.3 Reactive Power Adjustment



NOTICE

Before setting **Reactive power control mode**, set **Reactive power control** to **Enable**.

8.3.1 Disabling Reactive Power Output

If the PV plant is not required to adjust the voltage at the grid-tied point or perform reactive power compensation, the inverter can run with pure active power output. In this case, set **Reactive power control mode** to **Disable reactive power output**.

Figure 8-10 Reactive power control

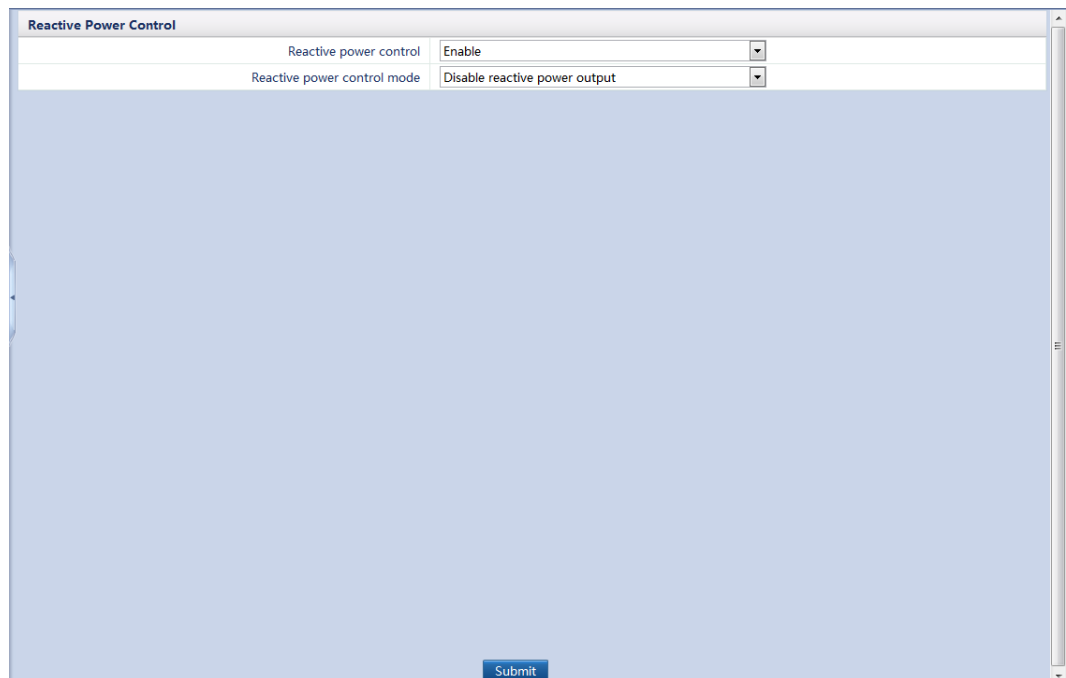

8.3.2 Dry Contact Remote Control



NOTICE

- If ports of DI1–DI4 have been configured in [7.10.7 Dry contact remote shutdown](#), **Dry contact remote control** is unavailable.
- Before setting dry contact remote control, ensure that the SmartLogger connects to a correct ripple control receiver. For details, see [4.10 Connecting the SmartLogger to a Ripple Control Receiver](#).

Set **Reactive power control mode** to **Dry contact remote control**.

Figure 8-11 Dry contact remote control

No.	DI1(GND2)	DI2(GND2)	DI3(GND2)	DI4(GND2)	PF
1	<input type="checkbox"/>	<input type="checkbox"/>	<input type="checkbox"/>	<input type="checkbox"/>	[-1.000~-0.800]U[0.800~1.000]

NOTE

- A maximum of 16 levels are supported for power factors.
- "√" indicates low level. When connecting to GND2, the four DI ports of the SmartLogger are low-level ports. If not connected, the ports are high-level ports.
- The status combination of DI1(GND2)–DI4(GND2) should differ from each other. Otherwise, abnormal command parsing will occur.
- If the actual input DI signal is inconsistent with that configured on the WebUI, the SmartLogger does not allow the SUN2000 to generate reactive power and the **Abnormal Reactive Schedule** alarm is generated.
- If **Active Power Control** is set to **AI remote control**, **Dry contact remote control** is unavailable for **Reactive Power Control**.

8.3.3 Reactive Power Fix Control

If the PV plant is required to generate at the grid-tied point specified constant reactive power within the power factor range, set **Reactive power control mode** to **Reactive power fix control**.

Figure 8-12 Reactive power fix control

No.	Start time	Reactive power(kVar)
1	00:00:00	0.0
2	12:00:00 (HH:MM:SS)	10.0 (-1008.0~1008.0)

NOTE

- If the inverter needs to run with specified maximum power in certain periods of a day, add setting records based on site requirements.
- The range specified for **Reactive Power** is relevant with the grid code and the model.
- When multiple time points are set, the inverter will run with the maximum power specified for the time point that is earlier than and the closest to the system current time point. For example, if you add 00:00:00 and 12:00:00 on the WebUI and the system current time point is 14:30:00, the inverter will run with the maximum power specified for 12:00:00.

8.3.4 Power Factor Fix Control

If the PV plant is required to generate a constant power factor at the grid-tied point and the inverter is required to adjust the real-time reactive power based on the preset power factor, set **Reactive power control mode** to **Power factor fix control**.

Figure 8-13 Power factor fix control

No.	Start time	PF
<input type="checkbox"/> 1	00:00:00	1.000
<input type="checkbox"/> 2	12:00:00 (HH:MM:SS)	0.950 [-1.000~-0.800]U[0.800~1.000]

Buttons: Add, Delete, Modify, Submit, Confirm, Cancel

NOTE

- If the inverter is required to run with a specified power factor in certain periods of a day, add setting records based on site requirements.
- When multiple time points are set, the inverter will run with the maximum power specified for the time point that is earlier than and the closest to the system current time point. For example, if you add 00:00:00 and 12:00:00 on the WebUI and the system current time point is 14:30:00, the inverter will run with the maximum power specified for 12:00:00.

8.3.5 Q-U Characteristic Curve

If you do not need the SmartLogger to send remote reactive power control commands, you can configure the characteristic curve on the SmartLogger as a substitute. The SmartLogger delivers the values configured for the characteristic curve to the inverter, which then operates in compliance with the configuration. The SmartLogger no longer adjusts the values.



NOTICE

Configure the characteristic curve under instructions from professionals to ensure that the SUN2000 works properly.

The Q-U characteristic curve control mode is to dynamically adjust the ratio Q/S of output reactive power to apparent power in accordance with the ratio U/Un(%) of the actual grid voltage to the rated grid voltage.

Set **Reactive power control mode** to **Q-U characteristic curve**.

Figure 8-14 Q-U characteristic curve

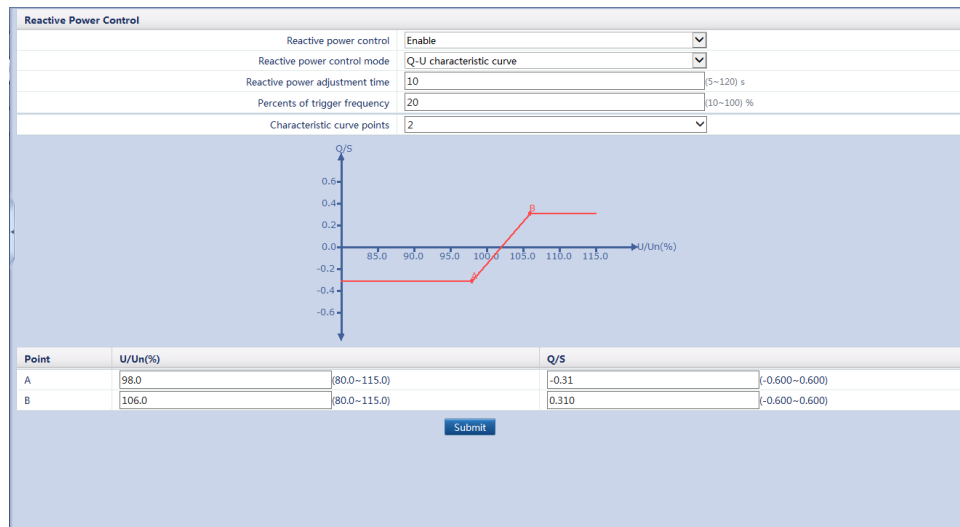

- When configuring the curve, ensure that the **U/Un(%)** value of a point is greater than the **U/Un(%)** value of the previous point. Otherwise, the **Invalid input** message will be displayed.
- The Q-U characteristic curve supports a maximum of 10 valid points.
- **Reactive power adjustment time** allows you to control the change interval of the reactive power for a grid-tied point.
- Under a specific grid code, after you set **Percents of trigger frequency**, the characteristic curve takes effect only when the actual output active power of the inverter is greater than the preset value.

8.3.6 cos(Phi)-P/Pn Characteristic Curve

If you do not need the SmartLogger to send remote reactive power control commands, you can configure the characteristic curve on the SmartLogger as a substitute. The SmartLogger delivers the values configured for the characteristic curve to the inverter, which then operates in compliance with the configuration. The SmartLogger no longer adjusts the values.



NOTICE

Configure the characteristic curve under instructions from professionals to ensure that the SUN2000 works properly.

The cos(Phi)-P/Pn characteristic curve control mode is to dynamically adjust the power factor cos(Phi) in accordance with the P/Pn (%) based on the VDE-4105\BDEW German standard.

Set **Reactive power control mode** to **cos(Phi)-P/Pn characteristic curve**.

Figure 8-15 cos(Phi)-P/Pn characteristic curve

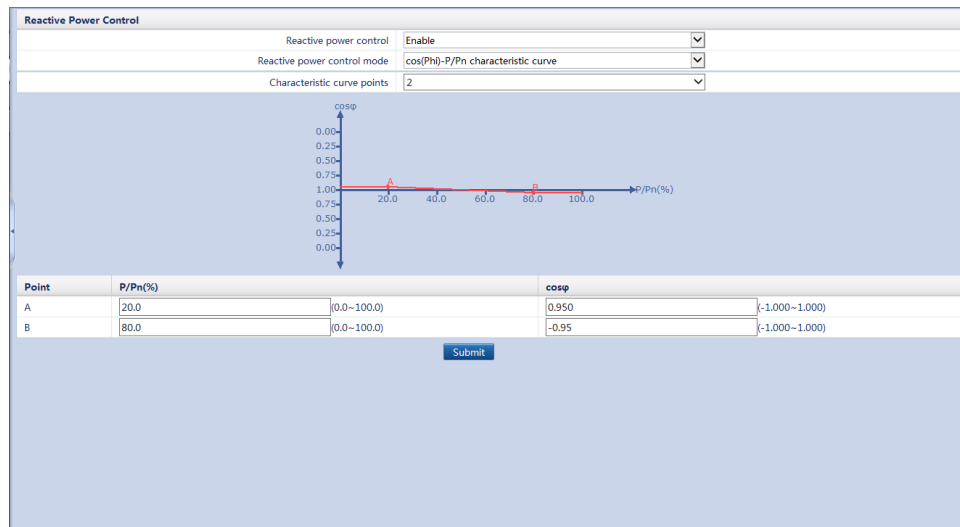

- When you set the curve, ensure that the **P/Pn(%)** value of a point is greater than the **P/Pn(%)** value of the previous point. Otherwise, the **Invalid input** message will be displayed.
- The cos(Phi)-P/Pn characteristic curve can support a maximum of 10 valid points.

8.3.7 Q-U Hysteresis Curve (CEI0-16)

If you do not need the SmartLogger to send remote reactive power control commands, you can configure the characteristic curve on the SmartLogger as a substitute. The SmartLogger delivers the values configured for the characteristic curve to the inverter, which then operates in compliance with the configuration. The SmartLogger no longer adjusts the values.



NOTICE

Configure the characteristic curve under instructions from professionals to ensure that the SUN2000 works properly.

The Q-U hysteresis curve (CEI0-16) control mode is the Italian standard CEI0-16 version of the Q-U characteristic curve. It dynamically adjusts the output reactive power of the inverter in accordance with the ratio of the actual voltage to the rated voltage. The final value should be in the form of Q/S.

Set **Reactive power control mode** to **Q-U hysteresis curve(CEI0-16)**.

Figure 8-16 Q-U hysteresis curve (CEI0-16)

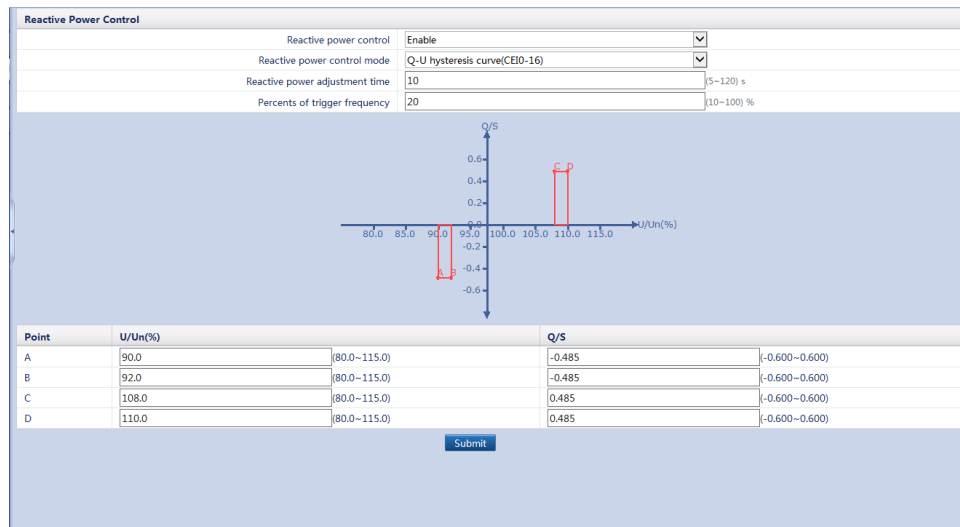

NOTE

- When configuring the curve, ensure that the **U/Un(%)** value of a point is greater than the **U/Un(%)** value of the previous point. Otherwise, the **Invalid input** message will be displayed.
- When configuring the curve, ensure that the values of **A** and **B** for **Q/S** are consistent and set in sequence, and that the values of **C** and **D** are consistent and set in sequence. Otherwise, the **Invalid input** message will be displayed.
- Under a specific grid code, after you set **Percents of trigger frequency**, the characteristic curve takes effect only when the actual output active power of the inverter is greater than the preset value.

8.3.8 Remote Scheduling

The NMS or independent power adjustment device sends scheduling commands over the communications port that works with Modbus-TCP or IEC104, without the need of user configuration or operation. The SmartLogger can automatically switch between scheduling modes and send scheduling commands.

When **Reactive power control mode** is set to **Remote scheduling**, the SmartLogger receives the scheduling commands from the upstream NMS, converts them into valid command data identifiable to the inverters, and then sends the data to all the connected inverters. Based on the principle of preference of remote scheduling, the SmartLogger sets **Reactive power control mode** to **Remote scheduling** after receiving a scheduling command from the upstream NMS.

Figure 8-17 Remote scheduling

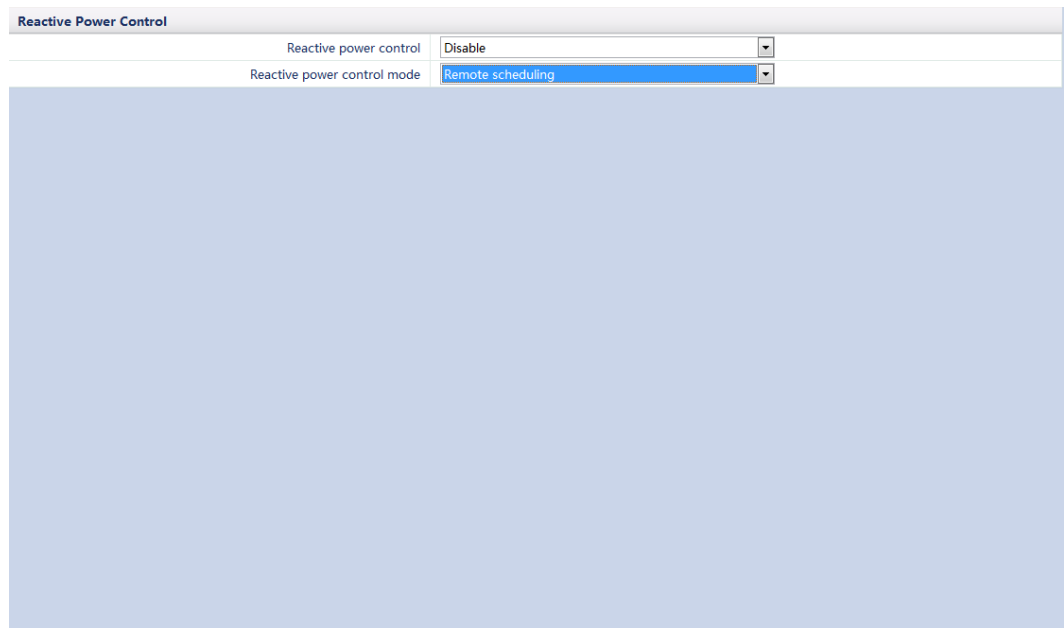

8.3.9 Power Factor Closed-Loop Control



NOTICE

Before setting the parameters for power factor closed-loop control, ensure that the power meter is connected to the SmartLogger. For details, see [4.6 Connecting the SmartLogger to a Power Meter](#).

Set **Reactive power control mode** to **Pwr factor closed-loop control**.

Figure 8-18 Power factor closed-loop control

Reactive Power Control	
Reactive power control	Enable
Reactive power control mode	Pwr factor closed-loop control
Target power factor	0.900 (0.900~1.000)
Adjustment interval	2.0 (1.0~10.0) s
Adjustment deadband	0.005 (0.000~1.000)

[Submit](#)

- **Target power factor:** indicates the target value for the adjustment power factor of the power meter.
- **Adjustment interval:** indicates the interval for sending adjustment commands by the SmartLogger.
- **Adjustment deadband:** indicates the adjustment power factor precision.



NOTE

The specified value of **Adjustment deadband** takes effect only if the power factor for the power meter exceeds 0.9.

8.3.10 Distributed Power Factor Closed-Loop Control

To improve the revenue, a distributed PV plant needs to reduce or avoid the power factor surcharge by performing the distributed reactive power compensation. To enable the function, set the related parameters over the WebUI.



NOTICE

Before setting the parameters, ensure that the power meter is connected to the SmartLogger. For details, see [4.6 Connecting the SmartLogger to a Power Meter](#).

Set **Reactive power control mode** to **Distributed power factor closed-loop control**.

Figure 8-19 Distributed power factor closed-loop control

Reactive Power Control		
Reactive power control	Enable	▼
Reactive power control mode	Distributed power factor closed-loop control	▼
Power Meter	Smart meter	▼
Electric meter power direction	Positive	▼
Target power factor	0.950	(0.900~1.000)
Adjustment period	2.0	(1.0~10.0) s
Adjustment deadband	0.005	(0.000~1.000)
Reactive compensation delay	0.0	(0.0~60.0) s

- **Power Meter:** When this parameter is set to **Smart meter**, the distributed power factor closed-loop control takes effect.
- **Electric meter power direction:** Set this parameter to positive if the active power reading of the power meter is positive when the inverter has no power output. Otherwise, set this parameter to reverse.
- **Target power factor:** Indicates the target value for the adjustment power factor of the power meter, which should be larger than the appraisal value of the PV plant power factor.
- **Adjustment period:** Indicates the interval for sending adjustment commands by the SmartLogger.
- **Adjustment deadband:** Indicates the adjustment power factor precision, which takes effect when the power factor on the gateway meter is larger than 0.9.
- **Reactive compensation delay:** Indicates the delay time for starting the distributed power compensation if the current power factor is lower than the target value.



NOTE

When the SmartLogger receives a remote reactive power scheduling command by the PV plant, **Reactive power control mode** automatically switches to **Remote scheduling**. To re-perform the distributed reactive power compensation, set **Reactive power control mode** to **Distributed power factor closed-loop control** and set **Target power factor** correctly.

9 Maintenance

This topic describes how to perform daily maintenance and troubleshooting to ensure long-term proper operation of the SmartLogger.

9.1 Routine Maintenance

- Check that the SmartLogger is free from strong electromagnetic interference.
- Check that the SmartLogger is free from heat sources.
- Check that the heat dissipation holes are not blocked.
- Clean up the dirt and dust for the SmartLogger periodically.
- Check that the cables are secured periodically.

9.2 Troubleshooting

This topic describes the common faults in the SmartLogger and the troubleshooting measures.

[Table 9-1](#) describes the common faults and the troubleshooting measures.

Table 9-1 Common fault list

No.	Symptom	Possible Cause	Measures
1	The SmartLogger cannot be powered on.	<ol style="list-style-type: none">1. The DC output terminal of the power adapter does not connect to the Power port of the SmartLogger.2. The AC input terminal of the power adapter does not connect to the AC power port.3. Power adapter is faulty.4. The SmartLogger is faulty.	<ol style="list-style-type: none">1. Connect the DC output of the power adapter to the Power port of the SmartLogger.2. Connect the AC input of the power adapter to the AC power port.3. Replace the power adapter.4. Contact the supplier or Huawei Customer Service Dept.
2	The LCD is off.	<ol style="list-style-type: none">1. The LCD is faulty.2. The SmartLogger is faulty.	Contact the supplier or Huawei Customer Service Dept.

No.	Symptom	Possible Cause	Measures
3	The LCD does not respond when a button is pressed.	<ol style="list-style-type: none"> The button is faulty. The SmartLogger is faulty. 	Contact the supplier or Huawei Customer Service Dept.
4	Devices cannot be searched.	<ol style="list-style-type: none"> The COM ports are not connected to devices, or the cables are loose, disconnected, or reversely connected. The communications parameters for the RS485 port are incorrect. No EMI is manually added. The communications parameters for the EMI are incorrect. The address for the inverter is not within the search address segment set for the SmartLogger. 	<ol style="list-style-type: none"> Check the RS485 communications cable connection. If any cable is loose, drops off, or is reversely connected, rectify the connection. Correctly set the RS485 communications parameters, and ensure that the baud rate and the communications address are correctly set. Add the EMI manually. Correctly set the EMI parameters Set the address of the inverter to be within the search address segment set for the SmartLogger.
5	Devices Status is Disconnection on the SmartLogger.	<ol style="list-style-type: none"> The cable between the device and the SmartLogger is loose or disconnected. The device is powered off. The baud rate or RS485 address of the device is changed. The device is replaced. The device is no longer connected. 	<ol style="list-style-type: none"> Verify that the cable between the device and the SmartLogger is properly connected and tightened. Power on the device. Verify the baud rate and RS485 address of the device. If a device is replaced, search for or manually add the device. If the device is removed, remove the device on the SmartLogger.
6	The EMI cannot be added.	<ol style="list-style-type: none"> The RS485 communications cable between the EMI and the SmartLogger is not properly connected, or the RS485 communications cable is loose or disconnected. The EMI is powered off. The baud rate of the EMI is inconsistent with that of the SmartLogger. Parameter settings of the EMI are incorrect. 	<ol style="list-style-type: none"> Verify that the RS485 communications cable is properly connected and tightened. Power on the EMI. Verify the baud rate of the EMI. Log in to the WebUI and verify the parameter settings of the EMI.
7	The SmartLogger cannot communicate with the NetEco in the PC.	<ol style="list-style-type: none"> The SmartLogger is not connected to the PC, or the cable between the SmartLogger and the PC is loose or disconnected. Ethernet parameters are not properly set. NetEco parameters are not properly set. 	<ol style="list-style-type: none"> Connect the Ethernet network port of the SmartLogger to the PC or router. Check that the Ethernet parameters are correctly set. Check that the NetEco parameters are correctly set.

No.	Symptom	Possible Cause	Measures
8	Emails cannot be received.	<ol style="list-style-type: none"> 1. The SmartLogger cannot communicate with the email server. 2. Ethernet parameters are not properly set. 3. Email parameters are not properly set. 	<ol style="list-style-type: none"> 1. Connect the Ethernet network port of the SmartLogger to the PC or router. 2. Check that the Ethernet parameters are correctly set. 3. Check that the Email parameters are correctly set.

9.3 Alarms

This topic describes the common faults in the SmartLogger and the troubleshooting measures.

[Table 9-2](#) describes the common faults and the troubleshooting measures.

Table 9-2 Alarms

Alarm ID	Alarm	Alarm Severity	Alarm Sub-ID	Causes	Measure
1100	Abnormal P-Control	Major	1	Under the active power AI remote control mode, the feedback command data of the AO port cannot be read due to the ADAM fault, power disconnection, or abnormal link.	<ol style="list-style-type: none"> 1. Check whether the cable connections to the DI ports are correct. 2. Enter the active power Dry contact remote control configuration page and check the mapping table of the current DI signal configuration. Contact the power grid company to check the completeness of the combination configurations in the mapping table and check whether the configurations comply with the requirements of the power grid company.
1101	Abnormal Q-Control	Major	1	Under the reactive power Dry contact remote control mode, the four DI ports read commands beyond the configuration.	<ol style="list-style-type: none"> 1. Check whether the cable connections to the DI ports are correct. 2. Enter the reactive power Dry contact remote control configuration page and check the mapping table of the current DI signal configuration. Contact the power grid company to check the completeness of the combination configurations in the mapping table and check whether the configurations comply with the requirements of the power grid company.

Alarm ID	Alarm	Alarm Severity	Alarm Sub-ID	Causes	Measure
1102	Abnormal Meter Data	Major	1	The power meter cannot properly send feedback signals to a third-party scheduling device due to the ADAM fault, power disconnection, or abnormal link.	<ol style="list-style-type: none">1. Check whether the communications cable connection between the ADAM4024 and the SmartLogger is correct, whether the RS485 address conflicts with the addresses of other devices, whether the baud rate is consistent with that set for the corresponding SmartLogger port.2. Check whether the auxiliary power supply for the ADAM4024 is normal.
1103	Breaker Disconnect	Major	1	The general AC circuit breaker at the grid-tied point is OFF.	Check whether the disconnection of the circuit breaker is a normal operation. Otherwise, contact the service engineer to restore the connection.

10 Disposing of the SmartLogger

This topic describes how to dispose the SmartLogger.

If the service life of the SmartLogger expires, dispose of the SmartLogger according to the local disposal act for waste electric appliances.

11 Technical Specifications

This topic describes the SmartLogger technical specifications.

Device management

Specifications	SmartLogger1000
Number of managed devices	80
Communications mode	Three RS485 ports
The maximum communication distance	RS485: 1000 m; Ethernet: 100 m

Display

Specifications	SmartLogger1000
LCD	3.5-inch LCD
LED	Three LED indicators
WEB	Embedded

Common parameters

Specifications	SmartLogger1000
Power supply	100 V AC to 240 V AC, 50 Hz or 60 Hz
Power consumption	Normal: 3 W; maximum: 7 W
Storage capacity	Stores historical inverter performance data of the last month
Language	English, Chinese, German, Italian, Japanese, French
Dimensions (W x H x D)	225 mm x 140 mm x 50 mm

Specifications	SmartLogger1000
Weight	500 g
Operating temperature	-20°C to +60°C
Relative humidity (non-condensing)	5%-95%
Protection level	IP20
Installation mode	Installed on a wall, desk, or along a guide rail.

Port

Specifications	SmartLogger1000
Ethernet	10/100M, Modbus-TCP
RS485	Modbus-RTU
USB	Supported
Digital parameter input	4
Analog input	2
Relay output	3

A Monitoring User List

Table A-1 Monitoring User List

Login Mode	User Name	Initial Password
LCD	Common User	000001
	Advanced User	000001
	Special User	000001
WEB	Common User	Changeme
	Advanced User	Changeme
	Special User	Changeme
SSH	root	Changeme
NetEco	emscomm	/EzFp+2%r6@IxSCv

B Acronyms and Abbreviations

A

AC	Alternating Current
AI	Analog Input
AO	Analog Output
APP	Application

C

CCO	Central Coordinator
COM	Communication

D

DI	Digital Input
DO	Digital Output

E

EMI	Environmental Monitoring Instrument
ETH	Ethernet

L

LED	Light-emitting Diode
------------	----------------------

P

PLC	Power Line Communication
------------	--------------------------

R

RSTP Rapid Spanning Tree Protocol

S

SFP Small Form-factor Pluggable

SPD Surge Protective Device

STA Station

STP Spanning Tree Protocol

W

WEEE Waste Electrical and Electronic Equipment