



User Manual

-Installation
-Operation

Omniksol-2k-TL3-S
Omniksol-2.5k-TL3-S
Omniksol-3k-TL3-S

Omnik New Energy Co.,Ltd

Catalog

1. Notes on this manual	3
1.1 Scope of Validation	3
1.2 Symbols Used	3
1.3 Target Group	4
2. Preparation	5
2.1 Safety Instructions	5
2.2 Explanations of Symbols on Inverter	6
3. Product Information	8
3.1 Overview	8
3.2 Major Characteristics	9
3.3 Datasheet	10
4. Packing checklist	12
4.1 Assembly parts	12
4.2 Product Appearance	13
4.3 Product Identification	14
4.4 Further Information	14
5. Installation	15
5.1 Safety	15
5.2 Mounting Instructions	16
5.3 Safety Clearance	17
5.4 Mounting Procedure	17
5.5 Safety lock	19
6. Electrical Connection	20
6.1 Safety	20
6.2 AC Side Connection	20
6.3 DC Side Connection	23
7. Display	28
7.1 LCD Panel	28
7.2 LCD Display	29
7.3 Instructions of Safety Standard selection when power-up	30

7.4 State Information	31
8. Recycling and Disposal.....	32
9. Troubleshooting	33
10. Abbreviation.....	34
11. Contact	35

1. Notes on this manual

1.1 Scope of Validation

The main purpose of this User's Manual is to provide instructions and detailed procedures for installing, operating, maintaining, and troubleshooting the following three types of Omnik New Energy-Solar Inverters:

- Omniksol-2k-TL3-S
- Omniksol-2.5k-TL3-S
- Omniksol-3K-TL3-S

Please keep this user manual all time available in case of emergency.

1.2 Symbols Used



DANGER

DANGER indicates a hazardous situation which, if not avoided, will result in death or serious injury.



WARNING

WARNING indicates a hazardous situation which, if not avoided, can result in death or serious injury or moderate injury.



CAUTION

CAUTION indicates a hazardous condition which, if not avoided, can result in minor or moderate injury.



NOTICE

NOTICE indicates a situation that can result in property damage, if not avoided.

1.3 Target Group

- Chapter 1, 2, 3, 4, 7, 8, 9, 10 and Chapter 11 are intended for anyone who is intended to use Omnik Grid Tie Solar Inverter. Before any further action, the operators must first read all safety regulations and be aware of the potential danger to operate high-voltage devices. Operators must also have a complete understanding of this device's features and functions.



WARNING

Do not use this product unless it has been successfully installed by qualified personnel in accordance with the instructions in Chapter 5, "Installation".

- Chapter 5 and Chapter 6 are only for qualified personnel who are intended to install Or uninstall the Omnik Grid Tie Solar Inverter.



NOTICE

Hereby qualified personnel means he/she has the valid license from the local authority in:

- Installing electrical equipment and PV power systems (up to 1000 V).
- Applying all applicable installation codes.
- Analyzing and reducing the hazards involved in performing electrical work.
- Selecting and using Personal Protective Equipment (PPE).

2. Preparation

2.1 Safety Instructions



DANGER

DANGER due to electrical shock and high voltage **DO NOT** touch the operating component of the inverter, it might result in burning or death. **TO** prevent risk of electric shock during installation and maintenance, please make sure that all AC and DC terminals are plugged out. **DO NOT** stay close to the instruments while there is severe weather conditions including storm, lightning etc.



WARNING

The installation, service, recycling and disposal of the inverters must be performed by qualified personnel only in compliance with national and local standards and regulations. Please contact your dealer to get the information of authorized repair facility for any maintenance or repairmen.

Any unauthorized actions including modification of product functionality of any form will affect the validation of warranty service; Omnik may deny the obligation of warranty service accordingly.



NOTICE

Public utility only







The PV inverter designed to feed AC power directly into the public utility power grid, do not connect AC output of the device to any private AC equipment.









CAUTION

The PV inverter will become hot during operation; please don't touch the heat sink or peripheral surface during or shortly after operation. Risk of damage due to improper modifications. Never modify or manipulate the inverter or other components of the system.

2.2 Explanations of Symbols on Inverter

Symbol	Description
	Dangerous electrical voltage This device is directly connected to public grid, thus all work to the inverter shall only be carried out by qualified personnel.
	DANGER to life due to high electrical voltage! There might be residual currents in inverter because of large capacitors. Wait 10 MINUTES before you remove the front lid.
	NOTICE, danger! This device directly connected with electricity generators and public grid.
	Danger of hot surface The components inside the inverter will release a log of heat during operation, DO NOT touch aluminum housing during operating.
	An error has occurred Please go to Chapter 9 "Trouble Shooting" to remedy the error.
	This device SHALL NOT be disposed of in residential waste Please go to Chapter 8 "Recycling and Disposal" for proper treatments.

	<p>Without Transformer This inverter does not use transformer for the isolation function.</p>
	<p>German mark of conformity The inverter complies with the requirement of the German Grid Regulations.</p>
	<p>Certified Safety The inverter complies with the requirements of the Equipment and Product Safety Act in Europe.</p>
	<p>Standards Association of Australian The inverter complies with the requirement of the AS4777.</p>
	<p>CE Mark Equipment with the CE mark fulfils the basic requirements of the Guideline Governing Low-Voltage and Electromagnetic Compatibility.</p>
	<p>No unauthorized perforations or modifications Any unauthorized perforations or modifications are strictly forbidden, if any defect or damage (device/person) is occurred, Omnik shall not take any responsibility for it.</p>

3. Product Information

3.1 Overview

- Industrial Layout



- Excellent Heat Elimination



3.2 Major Characteristics

Omnik inverter has following characteristics which make Omnik inverter “High Efficiency, High Reliability, High Cost Effective Ratio”

- Wide DC input voltage and current ranges, enables more PV panels connected.
- Wide MPP voltage range ensure high yield under various weather conditions.
- High MPP tracking accuracy, ensure the minimum power loses during converting.
- Complete set of protection methods.

Also, following protection methods are integrated in Omnik inverter:

- Internal overvoltage
- DC insulation monitoring
- Ground fault protection
- Grid monitoring
- Ground fault current monitoring
- DC current monitoring
- Integrated DC switch (Optional)

3.3 Datasheet

Omniksol-2k-TL3-S/ Omniksol-2.5k-TL3-S/Omniksol-3k-TL3-S

Type	Omniksol-2k-TL3-S	Omniksol-2.5k-TL3-S	Omniksol-3k-TL3-S
Input (DC)			
Max. PV Power	2100W	2650W	3200W
Max DC Voltage	500V	500V	500V
Operating MPPT Voltage Range	120-450V	120-450V	120-450V
MPPT Voltage Range at Nominal Power	210-450V	260-450V	320-450V
Start up DC Voltage	150V	150V	150V
Turn off DC Voltage	120V	120V	120V
Max. DC Current	10A	10A	10A
Max. Short Circuit Current for each MPPT	14A	14A	14A
Number of MPP trackers	1	1	1
Number of DC Connection for each MPPT	1	1	1
DC Connection Type	MC4 Connector	MC4 Connector	MC4 Connector
Output (AC)			
Nominal AC Power(cos phi = 1)	2000W	2500W	3000W
Nominal Grid Voltage	220V/230V/240V	220V/230V/240V	220V/230V/240V
Nominal Grid Frequency	50Hz/60Hz	50Hz/60Hz	50Hz/60Hz
Max. AC Current	10.0A	12.5A	15.0A
Grid Voltage Range*	185-276V	185-276V	185-276V
Grid Frequency Range*	45-55Hz/55-65Hz	45-55Hz/55-65Hz	45-55Hz/55-65Hz
Power Factor	0.9i_1_0.9c	0.9i_1_0.9c	0.9i_1_0.9c
Total Harmonic Distortion (THD)	<3%	<3%	<3%
Feed in Starting Power	30W	30W	30W
Night time Power Consumption	<1W	<1W	<1W
Standby Consumption	6W	6W	6W
AC Connection Type	Plug-in connector	Plug-in connector	Plug-in connector
Efficiency			
Max. Efficiency (at 360Vdc)	97.2%	97.2%	97.2%
Euro Efficiency (at 360Vdc)	96.6%	96.6%	96.6%
MPPT Efficiency	99.9%	99.9%	99.9%
Safety and Protection			
DC Insulation Monitoring	Yes		
DC Switch	Optional		
Residual Current Monitoring Unit (RCMU)	Integrated		
Grid Monitoring with Anti-islanding	Yes		
Protection Class	I (According to IEC 62103)		
Overvoltage Category	PV II / Mains III (According to IEC 62109-1)		

*The AC voltage and frequency range may vary depending on specific country grid

Type	Omniksol-2k-TL3-S	Omniksol-2.5k-TL3-S	Omniksol-3k-TL3-S
Reference Standard			
Safety Standard	EN 62109, AS/NZS3100		
EMC Standard	EN 61000-6-1, EN 61000-6-3, EN 61000-6-2, EN 61000-6-4, EN61000-3-2, EN61000-3-3		
Grid Standard	VDE 0126-1-1, RD1663, C10/11, G83/2, UTE C15-712-1, AS4777, CQC,CEI0-21, EN50438		
Physical Structure			
Dimensions (WxHxD)	245x346x123mm		
Weight	8kg		
Environmental Protection Rating	IP 65 (According to IEC 60529)		
Cooling Concept	Natural convection		
Mounting Information	Wall bracket		
General Data			
Operating Temperature Range	-25°C to +60°C(derating above 45°C)		
Relative Humidity	0% to 100%, no condensation		
Max. Altitude (above sea level)	2000m		
Noise Level	< 40dB		
Isolation Type	Transformerless		
Display	2 LED, Backlight, 16*2 Character LCD		
Data Communication Interfaces	RS485 / WIFI / GPRS optional		
Guarantee	5 - 25 years optional		

4. Packing checklist

4.1 Assembly parts

After you receive the Omnik inverter, please check if there is any damage on the carton, and then check the inside completeness for any visible external damage on the inverter or any accessories. Contact your dealer if anything is damaged or missing.



A



B



C



D

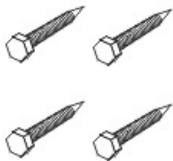

E

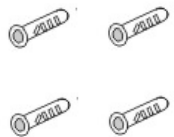

F

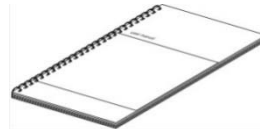

G

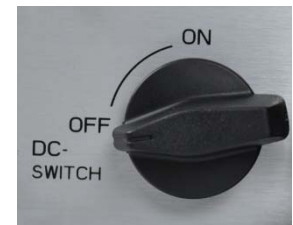

H

Object	Quantity	Description
A	1	Omnik inverter
B	1 pair	DC connector
C	1	AC connector
D	1	Mounting bracket
E	4	Screw (ST6x50)
F	4	Expansion tube
G	1	Installation and operating instructions
H	1	DC Switch(Optional)

4.2 Product Appearance

- Front

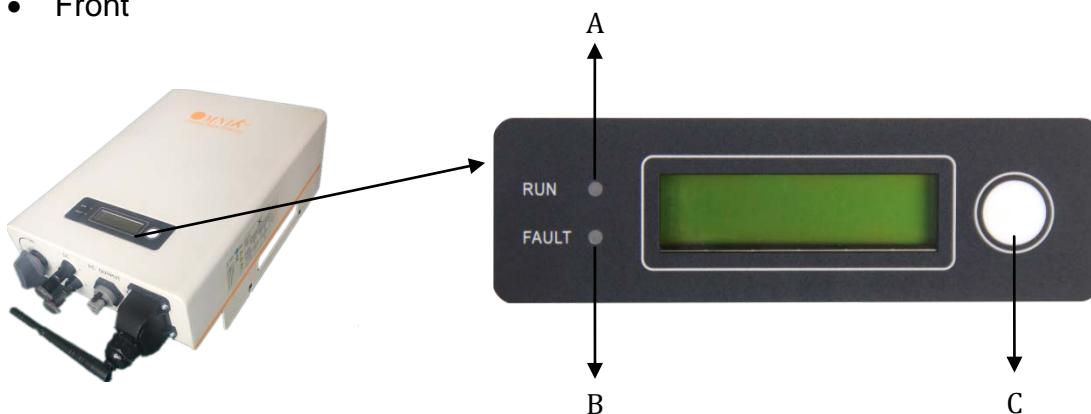

Object	Description
A	LED light(Green) – RUN
B	LED light(Red) – FAULT
C	Function key for displays and choice of language

- Bottom

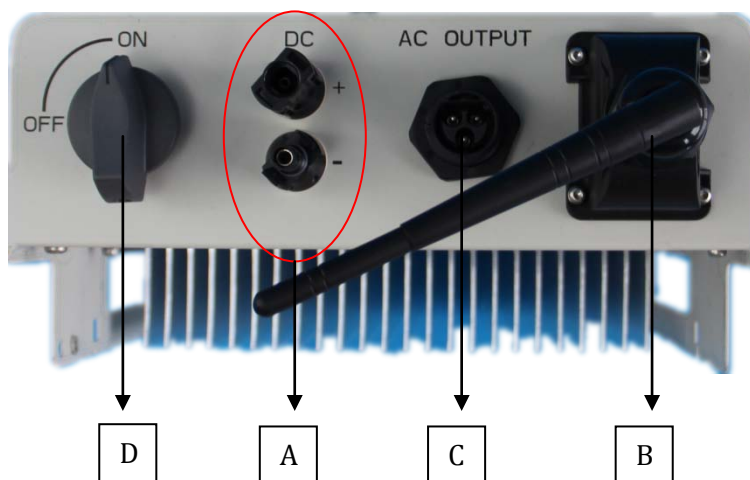

Object	Description
A	Plug connectors for DC input.
B	WiFi/GPRS/RS485 interface
C	Terminal for grid connection (AC output)
D	DC switch (optional)

4.3 Product Identification

You can identify the inverter by the side nameplate. Information such as type of the inverter and inverter specifications are specified on the sidename plate. The name plate is on the middle part of the right side of the inverter housing. And the following figure is the sidename plate example as on **Omniksol-3k-TL3-S**.

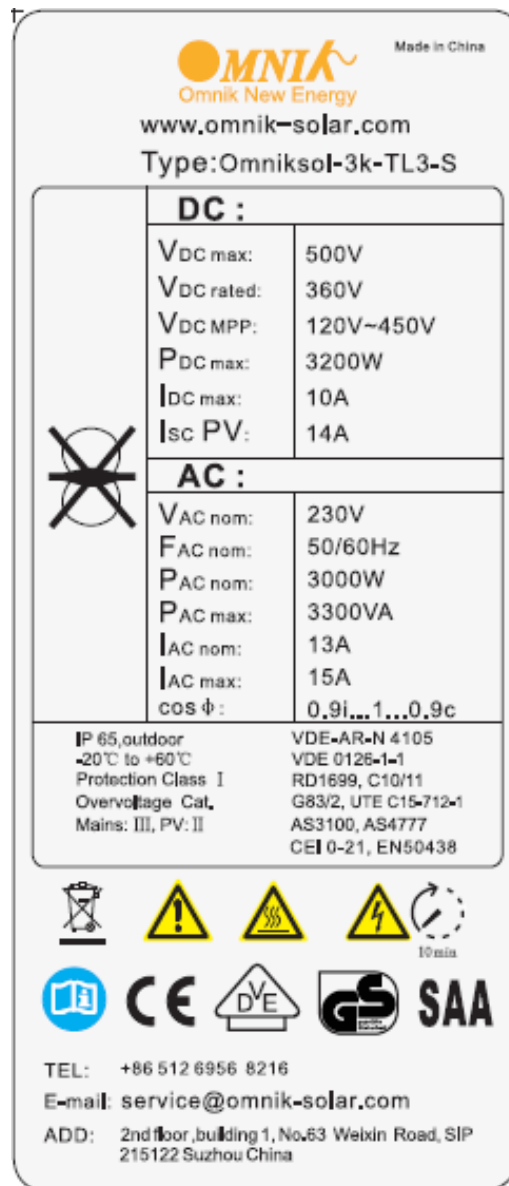

4.4 Further Information

If you have any further questions concerning the type of accessories or installation, please check our website www.omnik-solar.com or contact our service hotline.

5. Installation

5.1 Safety



DANGER

DANGER to life due to potential fire or electricity shock.
DO NOT install the inverter near any inflammable or explosive items. This inverter will be directly connected with HIGH VOLTAGE power generation device; the installation must be performed by qualified personnel only in compliance with national and local standards and regulations.



NOTICE

NOTICE due to the inappropriate or the harmonized installation environment may jeopardize the life span of the inverter.

Do not expose to direct sunlight to avoid power derating due to increase in the internal temperature of the inverter.

Do not expose to rain and snow cover to enhance inverter life time.
The installation site MUST have good ventilation condition.



5.2 Mounting Instructions

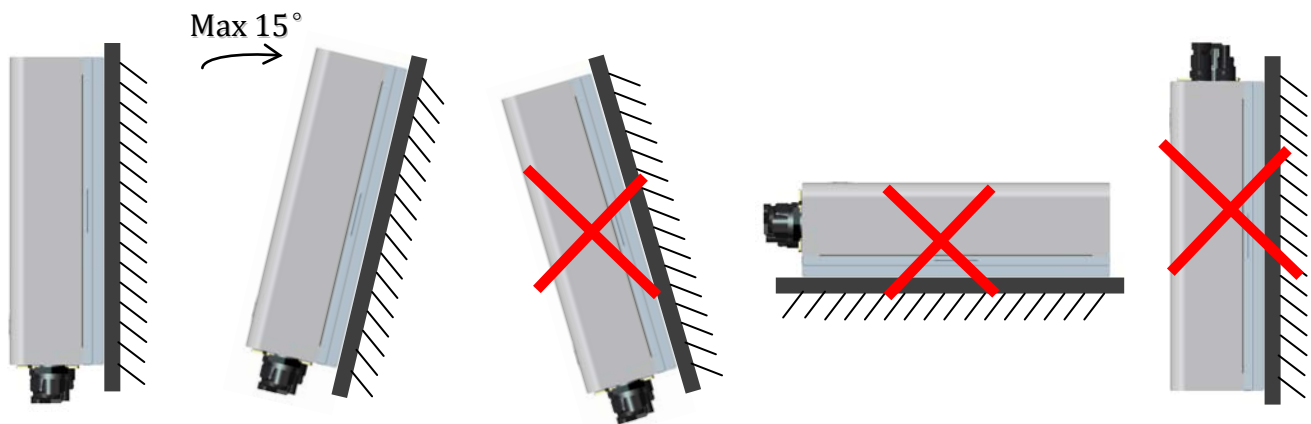

- Omnik inverter is designed for indoors and outdoors installation
- Please mount the inverter in the direction as illustrated above
- Install the inverter in the vertical direction is recommended, with a max.15 degrees backwards.
- For the convenience of checking the LCD display and possible maintenance activities, please install the inverter at eye level.
- Make sure the wall you selected is strong enough to handle the screws and bear the weight of the inverter
- Ensure the device is properly fixed to the wall
- It is not recommended that the inverter is exposed to the strong sunshine, because the excess heating might lead to power reduction
- The ambient temperature of installation site should be between -25 °C and +60 °C
- Make sure the ventilation of the installation spot, not sufficient ventilation may reduce the performance of the electronic components inside the inverter and shorten the life of the inverter

5.3 Safety Clearance

Observe the following minimum clearances to walls, other devices or objects to guarantee sufficient heat dissipation and enough space for pulling the electronic solar switch handle.



Direction	Minimum clearance
Above	30 cm
Below	40 cm
Sides	10 cm

5.4 Mounting Procedure

1. Mark 4 positions of the drill holes on the wall according to the wall mounting bracket in the carton box.

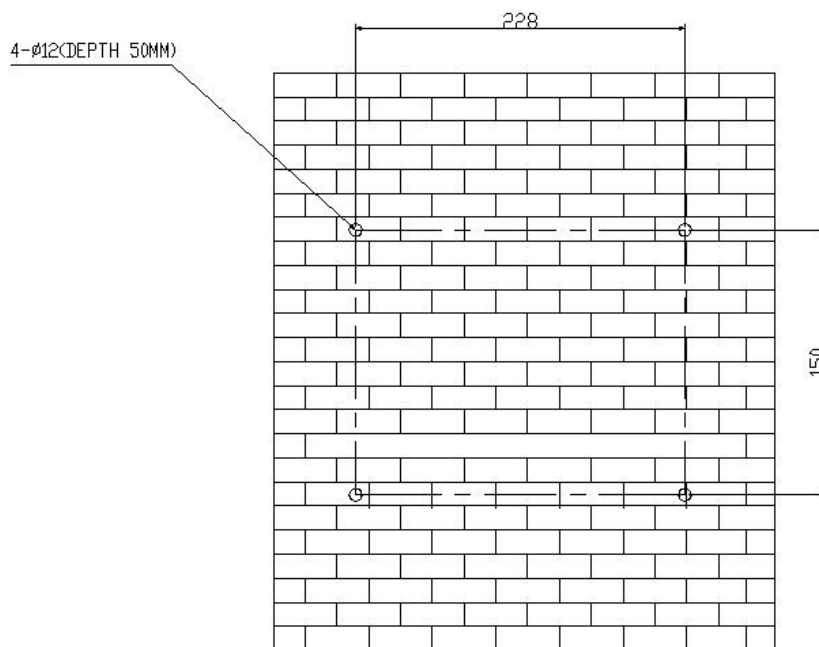

2. First, according to the marks, drill 4 holes in the wall. Then, place 4 expansion tubes in the holes using a rubber hammer. Next, make 4 screws through the mounting holes in the bracket, then tighten the screws into the expansion tubes. So far, the wall mounting bracket is fixed already.

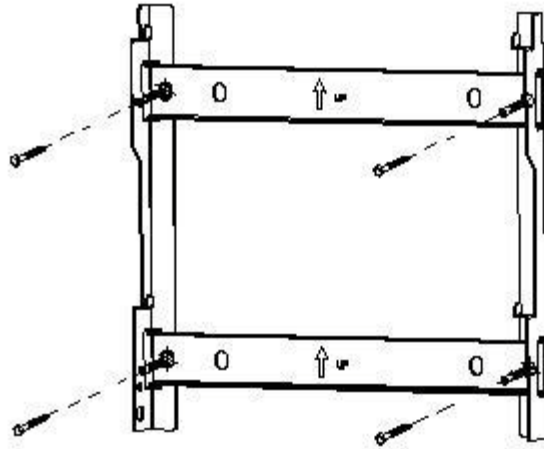

3. Align both sides of the radiator on the hooks of the back panel, move the inverter until the hooks completely into the slot of the radiator.



5.5 Safety lock

After the inverter is hanging up on the bracket, lock up the device and the bracket together at the Lower Left Corner of the inverter (as the picture showed below).

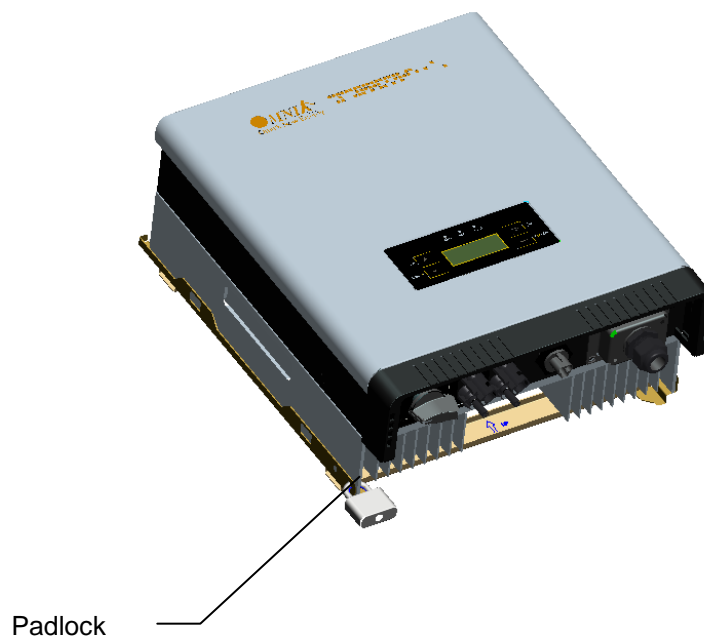

Recommended padlock dimension:

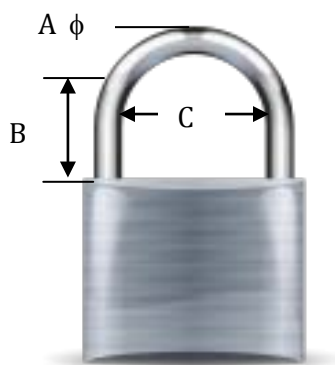

A. Shackle Diameter	5~7 mm
B. Vertical Clearance	8~15 mm
C. Horizontal Clearance	12~20 mm
Stainless, solid hanger and secured lock cylinder	



NOTICE

For further maintenance and possible repair, please keep the key of the padlock in a safe place.

6. Electrical Connection

6.1 Safety



DANGER

DANGER to life due to potential fire or electricity shock. With the inverter powered, comply with all prevailing national regulations on accidents prevention. This inverter will be directly connected with HIGH VOLTAGE power generation device; the installation must be performed by qualified personnel only in compliance with national and local standards and regulations.



NOTICE

Electrical connections shall be carried out in accordance with the applicable regulations, such as conductor sections, fuses, PE connection.

6.2 AC Side Connection



DANGER

DANGER to life due to potential fire or electricity shock.

NEVER connect or disconnect the connectors under load.

6.2.1 Integrated RCD and RCM

The Omniksol inverter is equipped with integrated RCD (Residual Current Protective Device) and RCM(Residual Current Operated Monitor). The current sensor will detect the volume of the leakage current and compare it with the pre-set value, if the leakage

current exceeds the permitted range, the RCD will disconnect the inverter from the AC load.

6.2.2 Assembly Instructions



NOTICE

Use **12-10AWG (4 – 6 mm²)** copper wire for all AC wiring connections to Omnik inverter. Use only solid wire or stranded wire.

- 1) Remove length y of **N, L** conductor 35mm (1.38")/**PE** conductor 40mm (1.57") sheath of AC cable terminal, length x about 14mm (0.55") of the inner wrapper, then dress the conductor terminals with ferrules or tin soldering.

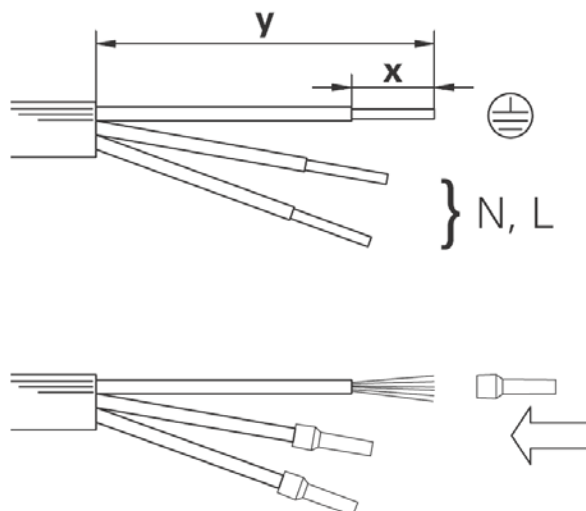

- 2) Check that all parts of AC connector are present. Then slide hex nut onto the cable and insert the cable end through clamp ring.

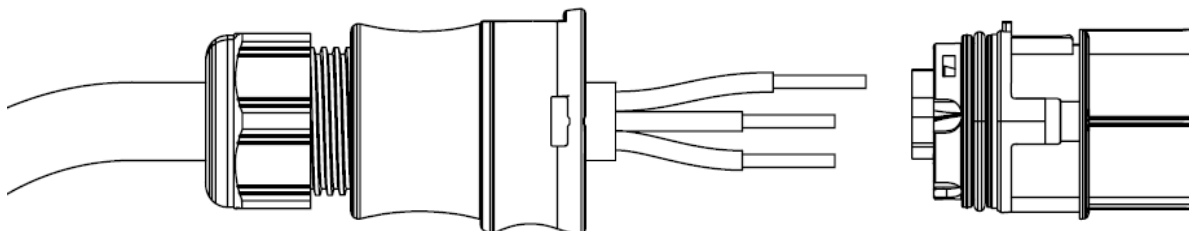

- 3) Insert the **stripped N, L and PE conductor terminal** to the appointed holes, use a cross screwdriver to tighten it with tightening torque 1Nm.

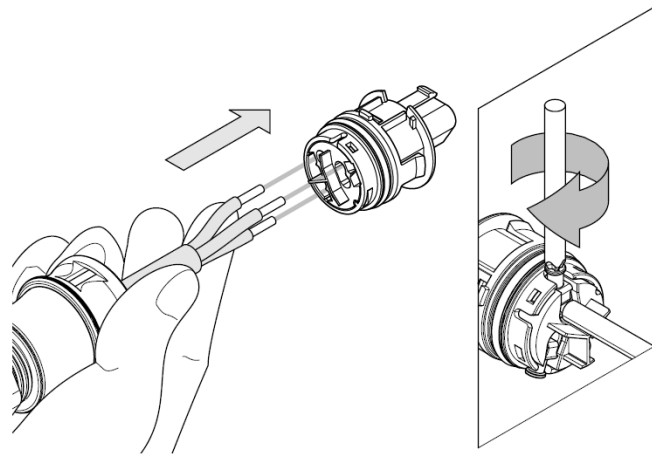

- 4) Insert the connector to clamp ring with two click sound and then tighten the hex nut with tightening torque 4Nm.

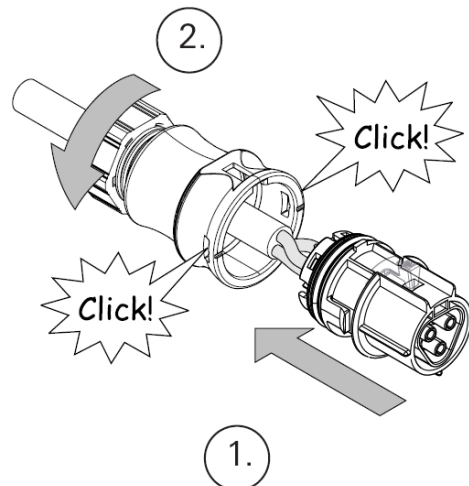

- 5) Finally push the straight plug to the AC terminal on inverter , then rotate the locker according to the direction instructed by the marks on the locker.

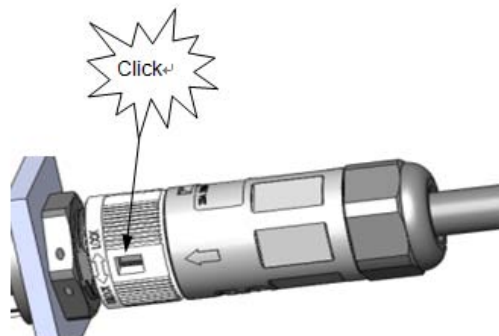

- 6) If you need to separate the connectors, please use a screwdriver to press the lock tongue, rotate the locker according to the direction instructed by the marks on the locker, and then pull down the plug.

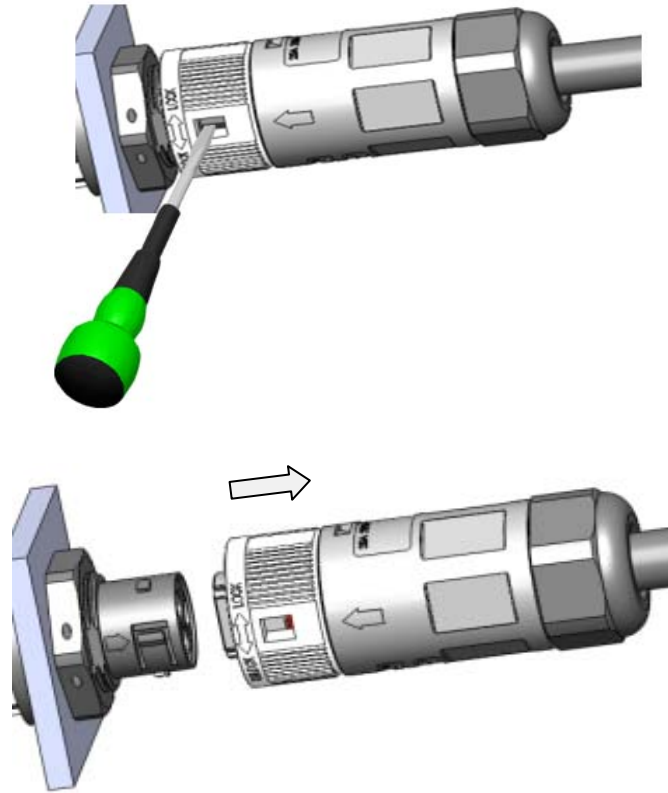

6.3 DC Side Connection



DANGER

DANGER to life due to potential fire or electricity shock.

NEVER connect or disconnect the connectors under load.



NOTICE

DC Switch (**Optional**) may be integrated or external to Inverter, and it can be used to connect or disconnect the DC source from Inverter.

For Omniksol-2k/2.5k/3K-TL3-S, there is only one MPP Tracker, and the DC characteristics of the mare illustrated as the following table.

Inverter Type	MPP Tracker	Max. DC Power	Max. DC Voltage	Max. DC Current
Omniksol-2k-TL3-S	1	2100W	480V	10A
Omniksol-2.5k-TL3-S		2650W	480V	10A
Omniksol-3k-TL3-S		3200W	480V	10A

MC4 Assembly instructions

 If, during self assembly, parts and tools other than those stated by MC are used or if the preparation and assembly instructions described here are disregarded then neither safety nor compliance with the technical data can be guaranteed.

 For protection against electric shock, PV-connectors must be isolated from the power supply while being assembled or disassembled.

 The end product must provide protection from electric shock.

 The use of PVC cables is not recommended.

 Unplugging under load: PV plug connections must not be unplugged while under load. They can be placed in a no load state by switching off the DC/AC converter or breaking the DC circuit interrupter. Plugging and unplugging while under voltage is permitted.

 It is unadvisable to use non-tinned cables of type H07RN-F, since with oxidised copper wires the contact resistances of the crimp connection may exceed the permitted limits.

 Disconnected connectors should be protected from dirt and water with sealing caps.

 Plugged parts are watertight IP67. They can not be used permanently under water. Do not lay the MC-PV connectors on the roof surface.

 See the MC catalogue 2 Solar line for technical data and assembled parts.

PV-Female cable coupler



PV-KBT4/...

PV-Male cable coupler



PV-KST4/...

Optional



PV-SSH4

Touch protection, mated/unmated	IP67/IP2X	Rated current	17A(1,5mm ² /14AWG) 22A(2,5mm ² / 12AWG) 30A(4mm ² ,6mm ² / 10AWG)
Ambient temperature range	-40°C...90°C (IEC/CEI) -40°C ...75°C(UL) -40°C ...70°C(UL/AWG14)	Rated voltage	1000V (IEC/CEI) 600V (UL)
Upper limiting temperature	105°C (IEC/CEI)	Safety class	II

Tools required



ill.1

(ill.1) Crimping tool incl. locator and built-in crimping insert.

Type: PV-ES-CZM-18100
PV-ES-CZM-19100

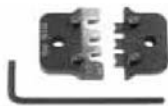

ill.2

(ill.2) Interchangeable crimping inserts incl. hexagonal screwdriver A/F 2,5.

Type: PV-ES-CZM-18100
PV-ES-CZM-19100



ill.3

(ill.3) Open-end spanner PV-MS 1 set = 2 pieces
Order No. 32.6024



ill.4

(ill.4) PV-WZ-AD/GWD socket wrench insert to tighten, Order No. 32.6006



ill.5

(ill.5) PV-SSE-AD4 socket wrench insert to secure PV-SSE-AD4, Order No. 32.6026



ill.6

(ill.6) Open-end spanner A/F 15 mm



ill.7

(ill.7) Torque screwdriver A/F 12 mm



ill.8

(ill.8) Test plug PV-PST
Order No.: 32.6028



ill.9

Cable preparation

(ill.9) Important: Cables with class 2, 5 or 6 construction can be connected. It is advantageous to use tinned conductors. It is inadvisable to use non-tinned cables of type H07RN-F, since with oxidized copper wires the contact resistances of the crimp connection may exceed the permitted limits.

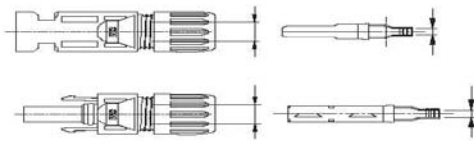

Check dimension b according to the following table:

Type	A = Ø-range of cable		b control dimension		Conductor cross section	
	mm	mm	mm	mm ²	AWG	
PV-K...T4/...2,5I	3 - 6		3	1,5 - 2,5	14	
PV-K...T4/...2,5II	5,5 - 9		3	1,5 - 2,5	14	
PV-K...T4/...6I	3 - 6		5	4 - 6	12/10	
PV-K...T4/...6II	5,5 - 9		5	4 - 6	12/10	⇒

care not to cut individual strands.

Recommended tool:

Stripping pliers PV-AZM, Order No.32.6027



ill.10

Crimping

(ill.11) Notes to the operation of the crimping pliers, see-MA251-def (www.multicontact.com)



ill.11



ill.12

(ill.12) Push the crimped contact into the socket resp. plug insulator until it engages. Pull lightly on the lead to check that the metal part has engaged.



ill.13

Assembly control
 (ill.13) Insert the test pin with the corresponding side into the socket or plug to the end position. If the contact is correctly assembled, the white marking on the test pin must be still visible.



ill.14

(ill.14) Screw on the cable gland, hand-tight, with the tools PV-MS. Or
 Screw on the cable gland, with the tools PV-WZ-AD/GWD and PV-SSE-AD4
 In any case:
 The tightening torque must be adapted to the solar cables used in each specific case. Typical values lie in a range between 2,5 Nm to 3 Nm.

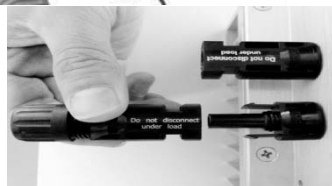

Plugging and unplugging the cable coupler without safety lock clip PV-SSH4



Plugging
 (ill.15)
 Plug the coupling together until they engage. Check correct engagement by pulling on the coupling.

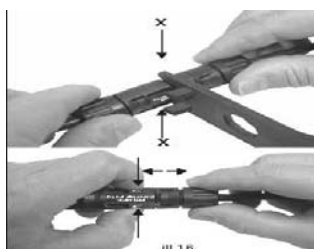

Unplugging
 (ill.16)
 Compress the two snap-in springs (X) by hand or with the PV-MS tool and separate the coupling. Plugging and unplugging the cable coupler without safety lock clip PV-SSH4



Refer to cable manufactures specification for minimum bending radius.

7. Display

7.1 LCD Panel

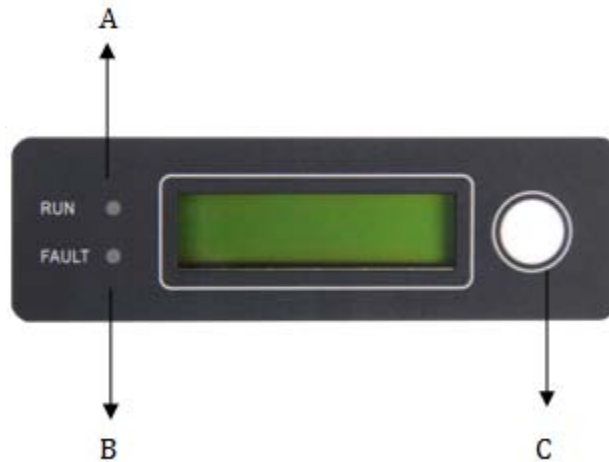

Object	Description
A	LED light(Green) – RUN
B	LED light(Red) – FAULT
C	Function key for displays and choice of language

The LCD panel is integrated in the front lid of the inverter, so it is easy for user to check and set the data. In addition, the user can press the function key to illuminate the LCD screen.



NOTICE

Omnik inverter is not an aligned measuring instrument for current, voltage or power consumption. A slight deviation of a few percent points is intrinsic to the system; the results from the inverter cannot be used for grid balance calculations. An aligned meter will be required to make calculations for the utility company.

7.2 LCD Display

The display content consists of 2 lines. The bottom line (Line 2) always displays the output power ($P_{ac} = xxxW$). The top line (Line 1) shows current state information by default, and by pressing function key it will display different operating information as the following flow chart and table.

LCD setup.

execution sequence	name	LCD example
1	Day total energy/kWh	E-Today = xx.x kWh
2	Total energy /kWh	E-Total = xxxxx kWh
3	PV Voltage/V	$V_{pv} = xxx.xV$
4	PV Current/A	$I_{pv} = xx.xA$
5	Grid voltage/V	$V_{ac} = xxx.xV$
6	Grid current/A	$I_{ac} = xx.xA$
7	Grid frequency /Hz	Frequency = xx.xHz
8	Models	2k-TL3-S
9	Standard	Italy
10	Version	Version
11	Temperature	Temperature
12	Language	Language: English
13	Grid setting	Set V/F Value
14	Protect setting	Protect: xx
15	Coefficient setting	Coefficient
16	Self Test(for Italy)	SelfTest
17	S/N and IP address	SN/IP
18	P(f)and Q(v)	P(f)&Q(v)
19	Time setting	Data: 20xx-xx-xx Time:xx:xx:xx
20	Error Record	Error Record

Line 1	Description
State information	Current state information
E-today	The energy generated today in kilo watt hours (kWh)
E-total	The energy generated since starting up the inverter (kWh)
Vpv	The present voltage of the solar generator
Ipv	The present current of the solar generator
Iac	The present grid current
Frequency	The grid frequency
Model	The type of the inverter
Ver	The Firmware version
Set Language	Several languages are provided for users
Vac	The grid voltage

7.3 Instructions of Safety Standard selection when power-up

7.3.1 Attentions before the operation:

Only perform this operation when the accumulative generated electricity is less than 1KWh.

7.3.2 Operation steps are as following:

- a) Power on the inverter with AC side connected.
- b) Press the Function button until the LCD displays “ Standard ” and hold the button for 5 seconds or more when the LCD displays the current Safety Standard. Change the standard by pressing the Function button one at a time.



- c) When the LCD displays your desired Safety Standard, hold the Function button for 5 seconds or more until it shows "Safety Standard OK".

7.4 State Information

State	Display	State information
Wait	Waiting	Initialization & waiting
	Reconnect s	Reconnect
	Checking s	Checking
Normal	Normal	Normal state
Fault	Ground I Fault	GFCI failure oversized leakage current
	Fac Failure	Grid frequency failure
	Vac Failure	Grid voltage failure
	Utility Loss	No Utility & Island
	PV Over Voltage	Input voltage too high
	Over Temperature	Temperature abnormal
	Isolation Fault	Isolation failure
	Relay-Check Fail	Output relay failure
	DC INJ High	Output DC injection too high
	EEPROM R/W Fail	EEPROM problem
	SCI Failure	Serial communication interface failure
	AC HCT Failure	Output AC sensor abnormal
	GFCI Failure	GFCI testing device abnormal
Flash	F/W Updating	Update

About the further information for each fault, please reference to Chapter “9.TROUBLESHOOTING”.

8. Recycling and Disposal

To comply with European Directive 2012/19/EU on waste Electrical and Electronic Equipment and its implementation as national law, electrical equipment that has reached the end of its life must be collected separately and returned to an approved recycling facility. Any device that you no longer required must be returned to your dealer or you must find an approved collection and recycling facility in your area.

Ignoring this EU Directive may have severe affects on the environment and your health.



WARNING



This device **SHALL NOT** be disposed of in residential waste.

9. Troubleshooting

	LCD display	Possible actions
Resumable Fault	Isolation Fault	<ol style="list-style-type: none"> 1. Check the impedance between PV (+) & PV (-) and the inverter is earthed. The impedance must be greater than 2MΩ. 2. Check whether the AC-side has contacts with earth.
	Ground I Fault	<ol style="list-style-type: none"> 1. The ground current is too high. 2. After cut off the AC side connection, unplug the inputs from the PV generator and check the peripheral AC system. 3. After the cause is cleared, re-plug the PV panel and AC connection, and check PV-Inverter status.
	Grid Fault Fac Over Range Vac Over Range	<ol style="list-style-type: none"> 1. Wait for a moment, if the grid returns to normal, PV-Inverter automatically restarts. 2. Make sure grid voltage and frequency meet the specifications.
	Utility Loss	<ol style="list-style-type: none"> 1. Grid is not connected. 2. Check grid connection cables. 3. Check grid usability. 4. If grid is ok, and the problem persists, maybe the fuse in the inverter is open, please call service.
	Over Temperature	<ol style="list-style-type: none"> 1. The internal temperature is higher than specified normal value. 2. Find a way to reduce the ambient temperature. 3. Or move the inverter to a cooler environment.
	PV over Voltage	<ol style="list-style-type: none"> 1. Check the open PV voltage, see if it is greater than or too close to 500VDC 2. If PV voltage is less than 500VDC, and the problem still occurs, please call local service.
	Permanent Fault	Consistent Fault
Relay-Check Fail		<ol style="list-style-type: none"> 1. Disconnect ALL PV (+) or PV (-). 2. Wait for a few seconds. 3. After the LCD switches off, reconnect and check again. 4. If the problems remain please call local service.
DC INJ High		
EEPROM R/W Fail		
SCI Failure		
AC HCT Fault		
GFCI Failure		

10. Abbreviation

LCD	Liquid Crystal Display
LED	Light Emitting Diode
MPPT	Maximum Power Point Tracking
PV	Photovoltaic
Vdc	Voltage at the DC side
Vac	Voltage at the AC side
Vmpp	Voltage at the Maximum Power Point
I _{mp}	Amperage at Maximum Power Point
AC	Alternating Current (Form of electricity supplied by Utility Company)
DC	Direct Current (Form of electricity generated by PV modules)
DC Switch	Switch in the DC Circuit. Disconnects DC source from Inverter. May be integrated or external to Inverter.

11. Contact

Omnik New Energy Co.,Ltd.(Headquarters)

Address: Third Floor,Building 3,No.63 Weixin Road,SIP,Suzhou,China

Tel: +86-512-6956-8216

Fax: +86-512-6295-6682

E-mail: sales@omnik-solar.com

sevice@omnik-solar.com

Website: www.omniksolar.com

Omnik German branch

Address: Omnik GmbH Forsthausstr.8A 65479 Raunheim

Tel: +49(0) 1799762654

Mobile: +49(176) 30743149

E-mail: jingjing.zhang@omnik-solar.com

Omnik UK Service Partner

Address: 3 More London Riverside SE1 2RE,London

Tel: +86 512 69568216 8833

E-mail: Frank.Liu@omnik-solar.com

OmnikItaly Srl

Address: Via Francesco Baracca, 500043 Ciampino(Roma)

Tel: +39 06 211.26.522

Fax: +39 06 565.616.46

E-mail: info@omniksolar.it

Website: www.omniksolar.it

Omnik Netherlands Office

Address: Goudstraat 65,2718RD Zoetermeer, The Netherlands

Tel: +31 30265 7845

E-mail: lena.wang@omnik-solar.com