

**Panasonic**



**The Power of Partnership**

**Panasonic Solar**



# 44

years experience in photovoltaics

## A quick history of reliability.

Investing in photovoltaic modules is a long-term commitment. Ideally a solar module has a life span of 25 years and over. That makes the relationship with your PV manufacturer almost as durable as the one with your life partner. In order to keep this relationship successful and enjoyable, your PV manufacturer needs to be a partner you can rely on. With 44 years of expertise and experience, Panasonic Solar is a pioneer and technology leader with a unique track record in reliability. Starting in 1975 with the development and early commercial production of amorphous solar cells for industrial and domestic use, no one has spent more time on solar technology research and development than Panasonic.



Panasonic



1975  
Begin research and development of amorphous solar cells

1980  
First commercialization of amorphous solar cells

1993  
Installation of world's first domestic grid connected photovoltaic system

1994  
Start of sales of photovoltaic systems for individual homes

1997  
Start of mass production and sales of photovoltaic module HIT®

2000  
Launch of the world's first bifacial photovoltaic module

2001  
Begin construction of Solar Ark, the world's largest photovoltaic power generation system at that time



2003  
Launch of the 200W module featuring the world's highest conversion efficiency

2004  
Start of production in Nishikinohama factory

2005  
Begin production of HIT® Europe in Hungary

2008  
Begin production of photovoltaic HIT® at Shiga Factory

2011  
Tokai University's solar car, powered by Panasonic HIT® modules, wins the 2011 World Solar Challenge

2012  
Begin production of photovoltaic module HIT® in Malaysia

2014  
Achieve the world's highest cell conversion efficiency of 25,6% at R&D level. Cumulative production of 1 billion solar cells

2017  
20 years of mass production of photovoltaic module HIT®

2018  
100 year anniversary of Panasonic corporation



# Solar Power

for everyone

## A vision for life.

Reliability is essential for a good partnership between customer and PV manufacturer. But it's not the only thing that keeps a relationship going. There's no progress in business or in a relationship without a vision. A vision keeps things fresh and exciting. Only visions advance our civilization. Panasonic have the vision to make the world a better place. That's why we're continuously looking for fresh and innovative ways to improve our services, throw our know-how into exhilarating and ground-breaking projects to explore untrodden paths and make life more liveable for everyone.



**Fujisawa SST** (sustainable smart town) is Panasonic's answer to the world's demand for sustainable living. Planned for 1000 households, Fujisawa opened in 2014 with an ultimate goal of being fully self-sustainable for at least 100 years. With the help of Panasonic products, CO<sub>2</sub> emissions will be reduced by 70% and water consumption cut by 30%. Furthermore, the town has been designed for residents to provide constant feedback, allowing the town to continually evolve and meet its sustainable goals. Ultimately Fujisawa SST has become an example of what modern and smart living can be.

**Berlin Adlershof** will be another smart city project by Panasonic and the first of its kind in Europe. Planned are 6 twin housing blocks with 67 apartments, where people of all ages will live together with the help of modern technology. Panasonic will equip the area with solar modules, batteries, safety and building infrastructure technology as well as assisted living technologies, including our latest Smart Home innovations with heating, cooling and ventilation components.



## A better life, A better world

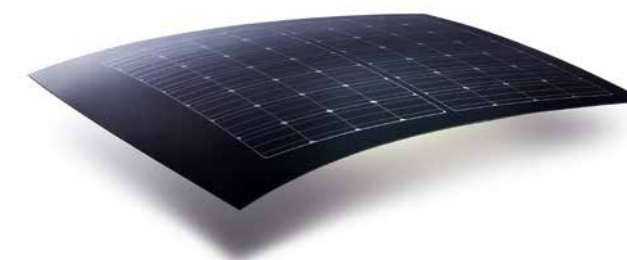

**Panasonic HIT<sup>®</sup> adopted for Toyota Motor's New Prius PHV:** Our newly developed photovoltaic module HIT<sup>®</sup> for cars has been adopted for the new Prius PHV which was released in February 2017 by the Toyota Motor Corporation. Panasonic's solar cells allow a high output (approx. 180 W) on a limited area on a car's roof, enabling the charging of the lithium-ion car batteries as well as 12 V batteries, resulting in a possible extension of an EV's travel distance and increase in fuel economy.



**Solar car:** The "Tokai challenger" is Tokai University's record breaking solar car powered by Panasonic lithium-ion batteries and HIT<sup>®</sup> solar modules. Both technologies are optimal for solar car races because of their resilience to high temperatures and their high power output per unit area. We proudly helped the "Tokai challenger" win the 2009 and 2011 World Solar Challenge in Australia, along with the Sasoi Solar Challenge, South Africa 2012 and the Carrera Solar Atacama, Chile in 2014.



**100 Thousand Solar Lantern Project:** 1.2 billion people in the world do not have access to electricity. This has various negative influences on quality of life. Without light, people are unable to cook, work, or receive medical treatment at night. And without light, children's education is limited to daytime hours. In order to make the world a better place, Panasonic Solar gave 100,000 solar lanterns to off-grid communities by 2018, the year of our 100th anniversary.

# “Panasonic gives you the highest energy yield”

I. Meijer, Germany, 6.48 kWp facility owner

## 100% Panasonic for 100% performance.

At Panasonic Solar we have the highest standards on all levels of production. In order not to corrupt these standards, we produce everything from wafer to module ourselves. Our originality guarantees maximum performance with minimum degradation and is one of the reasons for our success. The manufacturing process of a Panasonic photovoltaic module HIT® can be divided into 3 steps.

## Better performance Less degradation

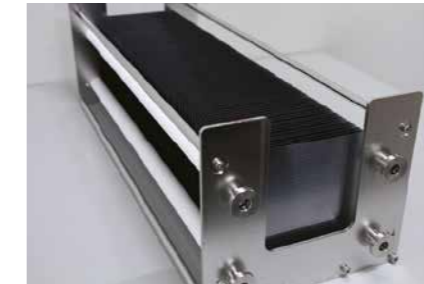

### 1. Wafers

Diamond wire saws slice the highly pure monocrystalline silicon ingot into silicon wafers thinner than a postcard. Each sliced wafer becomes a substrate for heterojunction cells.



### 2. Cell

The silicon wafers are cleaned of impurities and texturized. Amorphous silicon layers then form **heterojunctions**. Transparent electrode layers and charge collecting grid electrodes are formed, resulting in **heterojunction** cells with the world's highest level of power generation. Performance, appearance and other characteristics of each cell are then inspected.

### Heterojunction technology

Amorphous layer reduces the electrons lost on the surface resulting in high efficiency.

#### Heterojunction cell

Thin monocrystalline silicon wafer  
Ultra-thin amorphous silicon layer

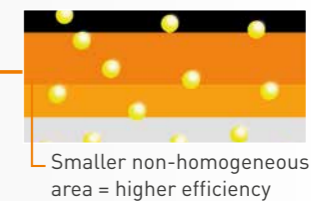
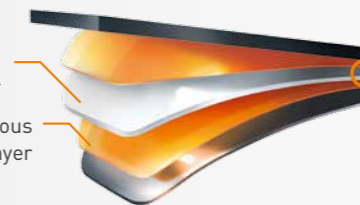

Smaller non-homogeneous area = higher efficiency

#### Conventional crystalline solar cell

Crystalline silicon wafer

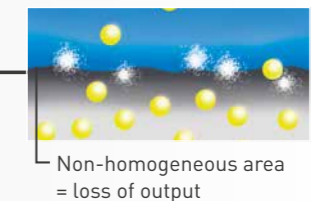

Non-homogeneous area = loss of output



### 3. Module

The cells are connected in series by wiring material to form 'strings' and later laminated. Our special curing process hardens the material and improves the water tightness as well as insulation to prolong the lifetime of the module.

After the installation of frames and a junction box, we conduct multiple inspections which exceed international standards. Passing these inspections is essential for our products to be shipped to our customers all over the world.

# Quality

verified by internal and external tests

## Come rain or shine.

During ideal conditions it's easy to get along. The true quality of a partnership shows when the going gets tough. At Panasonic Solar, we are there for you in good days and in bad days. However, it will rarely be the case that our customers require help with their Panasonic HIT® modules because all of our products are built and tested to withstand even the worst case scenarios. To guarantee the best possible reliability, efficiency and safety of our HIT® modules, we conduct over 20 internal tests above and beyond required international standard tests.

## Panasonic internal tests



### Wind resistant test

Simulates the conditions modules are exposed to during a super typhoon.

### Forced burning test

While standard burning tests only evaluate flammability in case of an external fire, our internal tests also simulate a fire outbreak from inside the module. Even under temperatures as high as 1000°C no fire spreads from the module.

### Severe damp heat test

The material is exposed to a high pressure steam test and a temperature and humidity test that is 3 times longer than required by the IEC (International Electrotechnical Commission).

### Cold heat shock test

With shorter cycle times and greater temperature differences durability is tested under more severe conditions than the IEC requires.



### Durability test

Replicates the harshest conditions seen in the natural environment by combining strong light and high temperatures.

### Reliability Test Result IEC61215 Thermal Cycle Test (300 % IEC Testing)

### Thermal cycle test

The module is subjected to fast changes in temperature from 85°C to -40°C and thus tested on its ability to withstand significant stress on the material.

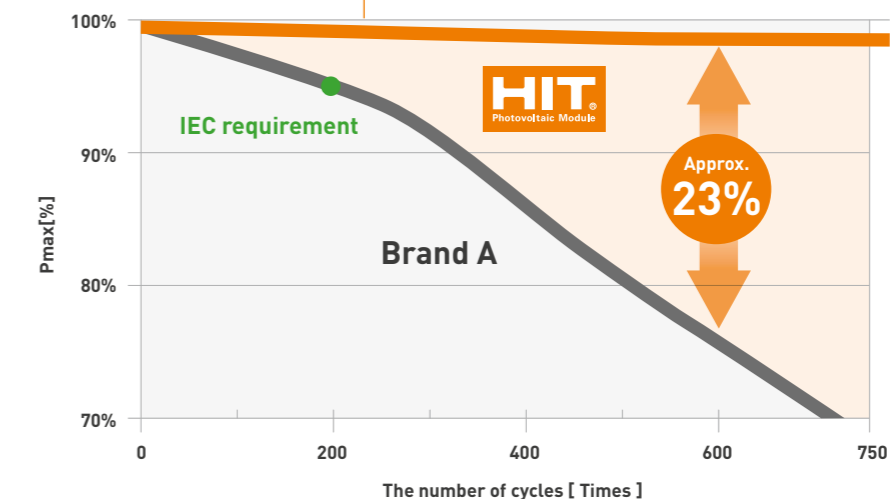

The outstanding Panasonic quality is also approved by third-party certificates

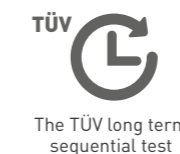

# 25

guarantee

years

## Proof not promises.

It's one of the world's undisputed truths that deeds are more persuasive than words. That's why we choose to prove our quality with facts instead of promising you the moon. We have more experience in the photovoltaic business than all of our competitors and are very proud of being able to present you with an unprecedented track record of case studies.

We have countless success stories over many years of fruitful relationships with people who made the decision to install a Panasonic solar system and who continue to be rewarded with reliable performance and stable output over decades of running time.



No downtime in over 10 years.

"I am really happy to see that our PV system is so clearly above the expected levels, working flawlessly every day after so many years" – Peter Wagner, owner.

Location: Köngen, Germany  
Installation: Winter 2005

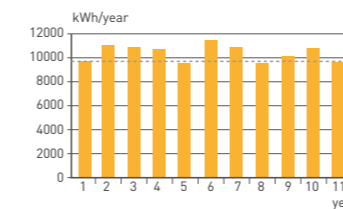

Location: Gunzenhausen, Germany  
Installation: 2004

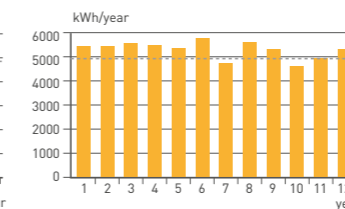

Location: Osaka, Japan  
Installation: March 1993

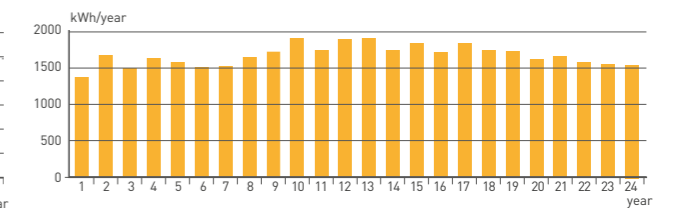

# 25

fully operational after

years

# 0.0044%

failure rate out of almost 4 mio modules

Januar 2019

**Linear Power output guarantee**

**25 years linear**

First year 97 %, from second year -0.45 %/year, in 25th year 86.2 %  
+ - 3 % Tolerance, 10 cm space between back sheet and roof

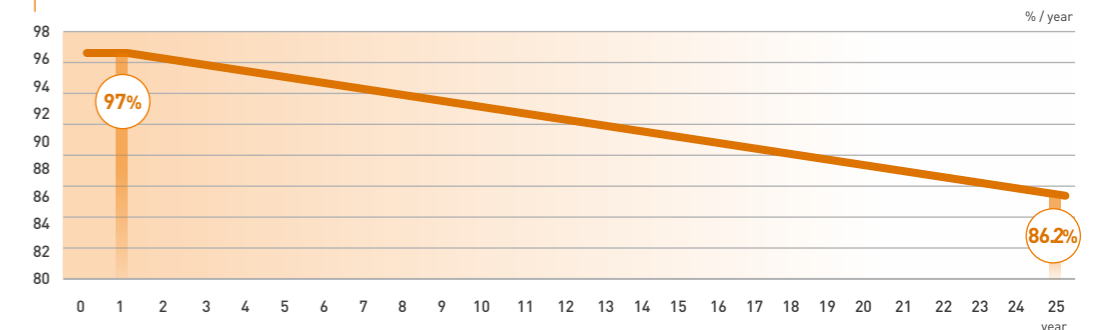

\* compared to calculation by PVGIS (Free online calculation and simulation of solar photovoltaic electrical power)

# Sustainable

products and production

## A partner to you. A friend to nature.

At Panasonic Solar, a good partnership is not exclusively reserved for clients. It is something we want to share with the whole planet because we believe all of our actions have consequences in this connected world. That's why we have the policy to make all of our production processes as environmentally friendly and sustainable as possible and to make sure we refrain from using ecologically harmful materials.



Photovoltaic modules on the roof generate sustainable energy for production facilities and office buildings.

## Green factory in Malaysia

One example of our responsible way of working is our green factory in Malaysia. It has been designed to have minimum environmental impact by using a wide range of environmentally friendly technologies.

### Intelligent architecture

allows the use of natural light in offices and lobbies and thus reduces the use of artificial illumination.



### No toxic materials

The RoHS directive restricts the use of hazardous materials in the production process. Though solar modules are not included in this directive, Panasonic ensures all products meet RoHS requirements.

### PV Cycle

This voluntary agreement commits us to a return and recycling programme for end-of-life-modules and to take responsibility for solar modules throughout their entire value chain.



### Recycling of waste heat

from the cooling tower significantly reduces power consumption.



### Wastewater purification facilities

help save precious water.



### Waste reduction measures

help sorting and managing a variety of waste that arise during production and reduce the volume of sludge by up to 50%. All measures result in a combined CO<sub>2</sub> reduction of 2,254.5 tonnes per year.



# Public Commercial Residential

## The universal attraction of competence.

Know-how, experience, innovation, quality, reliability, responsibility and good service are the pillars of successful ventures and held in high esteem all around the world. That's why Panasonic Solar is appealing to so many people and our products and expertise are chosen for a wide variety of projects and fields of application all around the globe. Be it for residential or commercial use or ambitious, large scale public developments, we can deliver the most energy efficient solutions for the most diverse requirements.



### Blackfriars Bridge London

In January 2014, Network Rail cut the ribbon on the world's largest solar-powered bridge at Blackfriars Bridge across the River Thames. The solar roof is fitted with 4400 Panasonic photovoltaic modules that cover an area of over 6000 m<sup>2</sup>. The modules generate 900,000kWh of electricity every year, saving over 500 tonnes of CO<sub>2</sub> and providing 50% of Blackfriars Station's electricity consumption. In addition to further reducing the carbon footprint of train routes to the South East of England, the distinctive roof has also turned the station into an iconic landmark.

### German Federal Environment Agency

The annex to the Federal Environment Agency was planned to be a net zero building, generating all the energy it required on a day-to-day basis. Given the limited roof space available, Panasonic HIT<sup>®</sup> were the only modules that could make this a reality. Furthermore the modules are also powering heating and cooling, hot water supply and indoor climate regulation in the building.



### Sakura project in Izmir Turkey

With 11.7 MW, this on ground solar energy installation is the biggest HIT<sup>®</sup> project in the world to date. Because of its geographical location, Turkey is in a very favorable position compared to many other countries in terms of benefiting from solar energy.

### Bislett Olympic stadium in Oslo Norway

The PV installation on the famous stadium is supposed to have a signal effect for more climate protection in Norway. The solar energy of about 150,000 kWh per year will be completely used in the stadium. The ventilation and cooling of the buildings need a lot of electricity. The lighting uses lots of electricity as well, particularly the indoor running site but also the flood lights in the stadium.





# Residential

## Aesthetic

## Powerful

More energy from the sun.

Every free space on your roof is valuable because you can harvest energy from the sun. That is why our modules are very popular among home owners. With the same number of solar panels, the highly efficient HIT® modules can help you to maximize the system capacity on your roof and reduce the monthly cost for electricity. So why not make the most out of your roof and of the sunlight that shines on it!



### PV system with fuel cell in Germany

The family, which lives in a former, restored three-sided courtyard, wanted to generate solar power for their own household and consume as much of it as possible themselves. The combination of photovoltaics and fuel cells with a storage tank ensures a high degree of self-sufficiency. The family has opted for this solution and now achieves a continuous degree of self-sufficiency of over 85 percent per year in power supply.



### High performance system in the UK

This high performance 5.39kW PV system consists of 22 245W HIT® panels and power optimisers and has been installed in the North of London. The system generated over 850kWh during June 2018 and has therewith exceeded all expectations.

### KURO installation in Italy

This is the case of a professional photographer who wanted to make a choice capable of bringing together aspects of economy, respect for the environment and visual pleasantness. In detail, in addition to the quality of the panels, the photographer sought a design solution, requiring that the modules be placed in a totally black context. The project fulfilled his desire to install an integrated system consisting of photovoltaic modules on the roof, thus exploiting a favorable orientation to the east, in combination with a heat pump.



### Rietendak installation in the Netherlands

On this building, which is used as a garage and a barn, the roof with the photovoltaic modules also serves as a patio cover. To tackle the challenge of fixing the modules onto the Rietendak (thatched roof), the installer Ewell worked closely together with a thatched roof specialist and the building contractor. In the end, they used a custom-made multi-layer mounting system. The first roof layer is for water resistance, followed by two layers to level up with the thatched roof. The modules are then fixed with a custom-made insertion system. Thanks to the efficient collaboration between all parties this unique project was made possible.



What can be better than HIT<sup>®</sup>?

That would be HIT<sup>®</sup>+

## We are always striving to improve.

We are active in the photovoltaic business since 1975 and we are strongly investing in R&D to keep improving not only our technology, but to advance the research on photovoltaic energy in general. This helps to bring forward renewable energy and lowers our dependency on fossil fuels. Our latest success is what we call „HIT<sup>®</sup>+“. It stands for a big leap forward in increasing the efficiency of our modules and thus getting even more energy out of your roof.



# 20%+ module efficiency

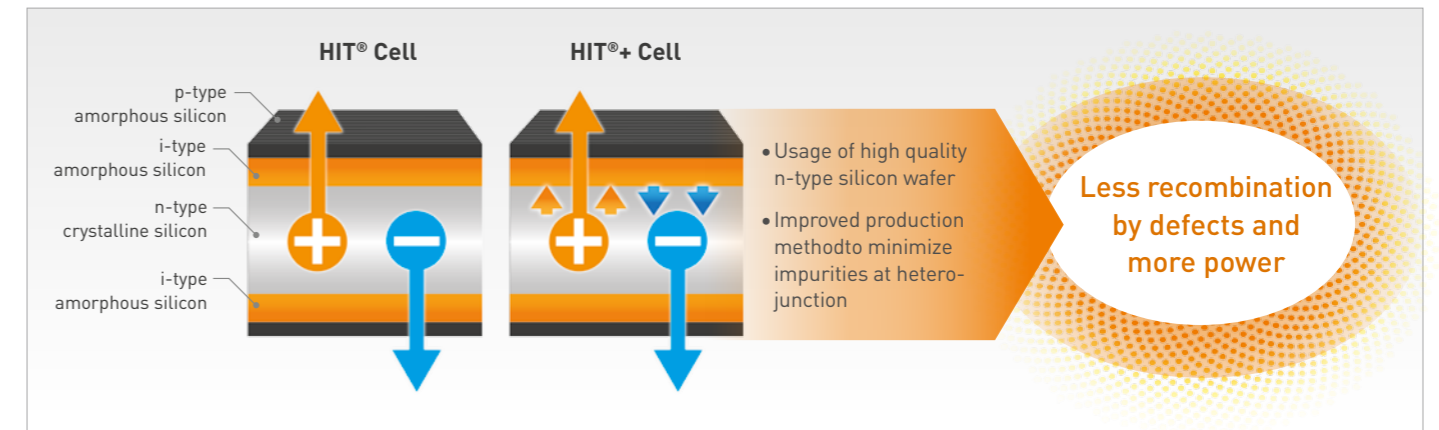

Clamping on short side and long side possible

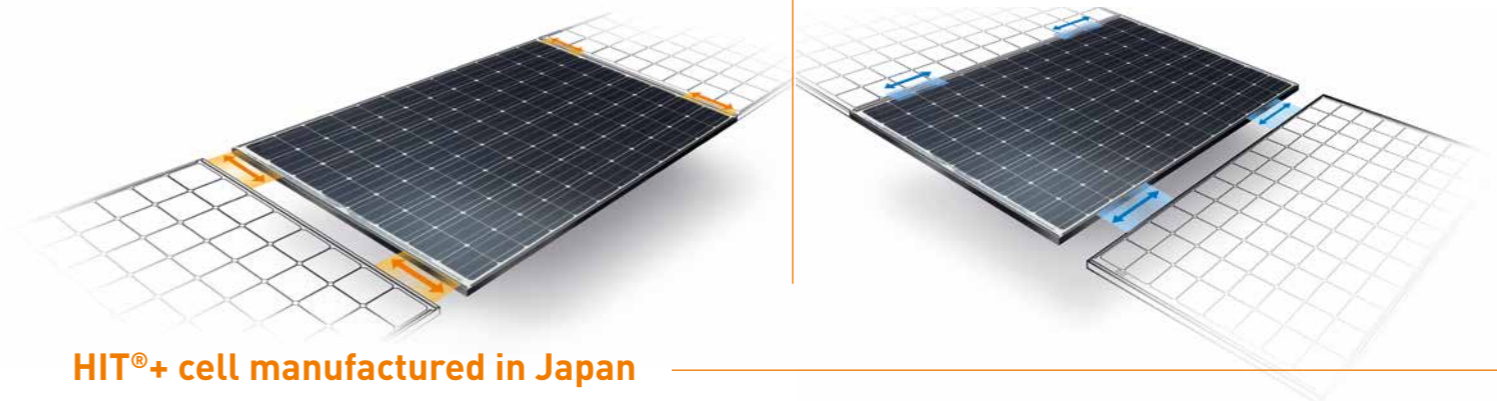

HIT<sup>®</sup>+ cell manufactured in Japan

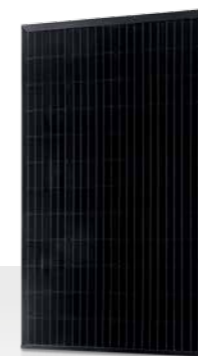

**Kuro - Black**  
N335K

Not only the cells and back sheet, but also the frame is completely black. The better aesthetical integration on the roof guarantees a higher degree of acceptance of solar photovoltaics and hence helps maximise the potential number of customers.



**Powerful**  
N340

With 20.3% module efficiency, these modules are among the most efficient on the market. Installation costs are lower too, and the BoS (balance of system) costs can be 24% less than with conventional modules.

Snow and wind load:  
**5400 PA**

**40mm** Frame with

# “The efficiency convinced me”

K. Fischer, Germany, 9.4 kWp facility owner

## Our adaptability is your power.

People are different and their individuality shows in their homes. As a result, there is no standard solution when it comes to fitting a roof with the most efficient solar system. Every PV solution has to be the answer to a specific problem and this requires the utmost flexibility from a PV provider. With a range of module sizes, we deliver this flexibility that allows our customers to generate the maximum power possible out of their roof.

## The 3 different HIT<sup>®</sup> modules for more power on any roof.



It rarely happens that the dimensions of a roof can be evenly divided by the length and width of a solar module. When covering a roof with standard sized modules you will most likely end up with remaining space too narrow for another row of modules no matter if you install them in a vertical or horizontal format. However with flexible Panasonic HIT<sup>®</sup> modules this problem won't occur.

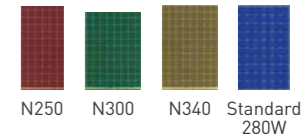

### Portrait



**Standard sized modules** can't entirely cover the roof in its width.

**The slim N250 module** perfectly fits in the remaining tight space.

### Landscape



**Standard sized modules** can cover the roof in its width, but not in its height.

**The slim N250 module** perfectly fits in the remaining tight space.

### Complicated



The space between dormer and roof edge is too narrow for another row of **regular sized modules**.

**The slim N250 module** is the perfect solution.

### Portrait



**Standard sized modules** can cover the roof in its width but not in its height.

**The compact N300** helps getting the best out of your roof when there's too much remaining space for a slim module.

### Landscape



**Standard sized modules** can't entirely cover the roof in its width.

**The compact N300** helps getting the best out of your roof when there's too much remaining space for a slim module.

### Extremely complicated



In this case the combination of **all three Panasonic modules** gets the most power, even out of an extremely complicated roof.

\* Simulation in Germany. This value is not guaranteed.



### Slim N250

This module is very versatile to install and is particularly suited to narrow, awkward roofs. This allows maximum energy output per unit of surface area.



### Compact N300

The low height of this module makes it perfectly suitable for roofs with a length of 6m. It also extracts more energy from flat roofs than conventional modules due to the smaller minimum spacing between rows of modules.



### Powerful N340

With 20.3% module efficiency, these modules are among the most efficient on the market. Installation costs are lower too, and the BoS (balance of system) costs can be 24% less than with conventional modules.





# Photovoltaic modules HIT®

# The powerful components of a lifelong relationship.

## Slim Photovoltaic module HIT® N250

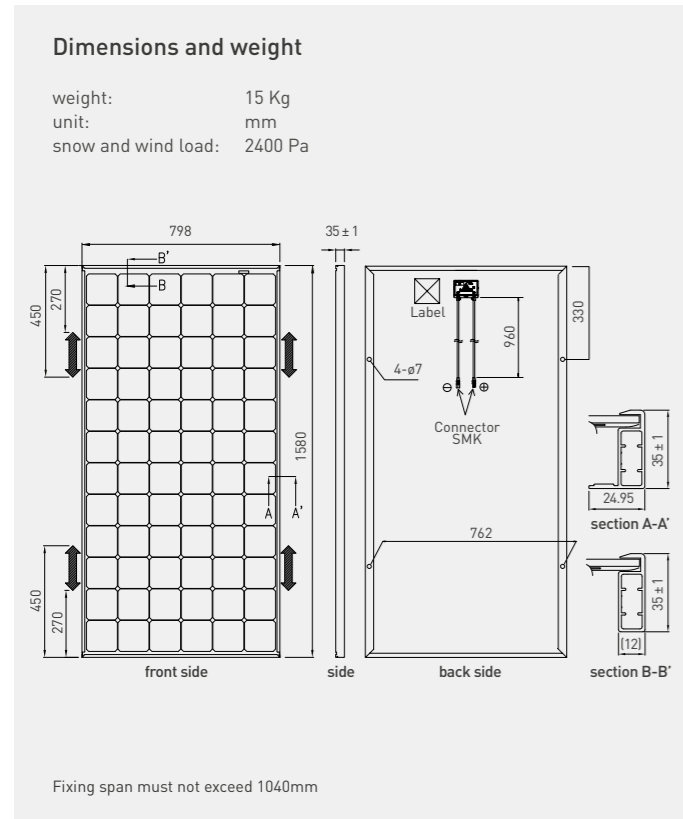

## Photovoltaic module HIT® N340

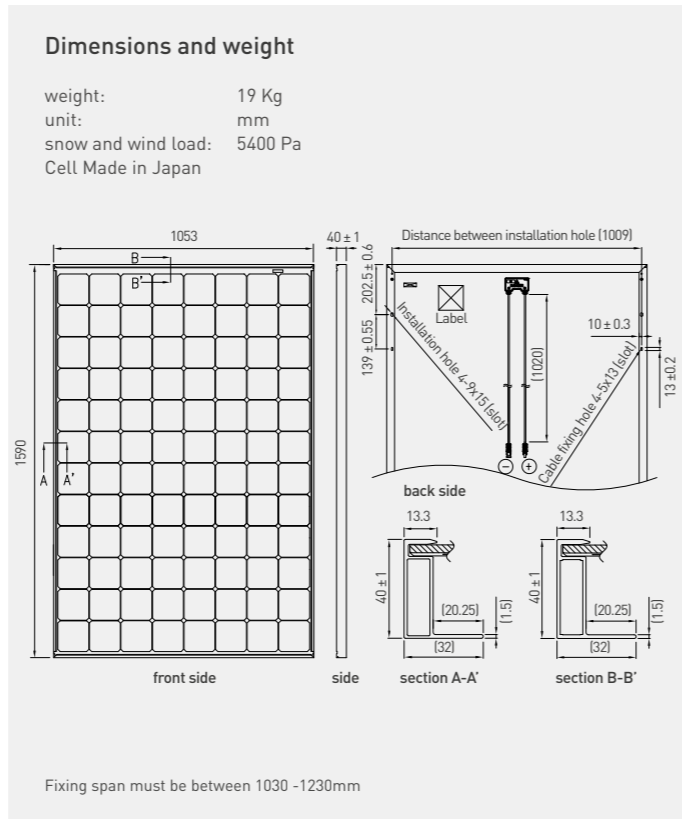

## Compact Photovoltaic module HIT® N300

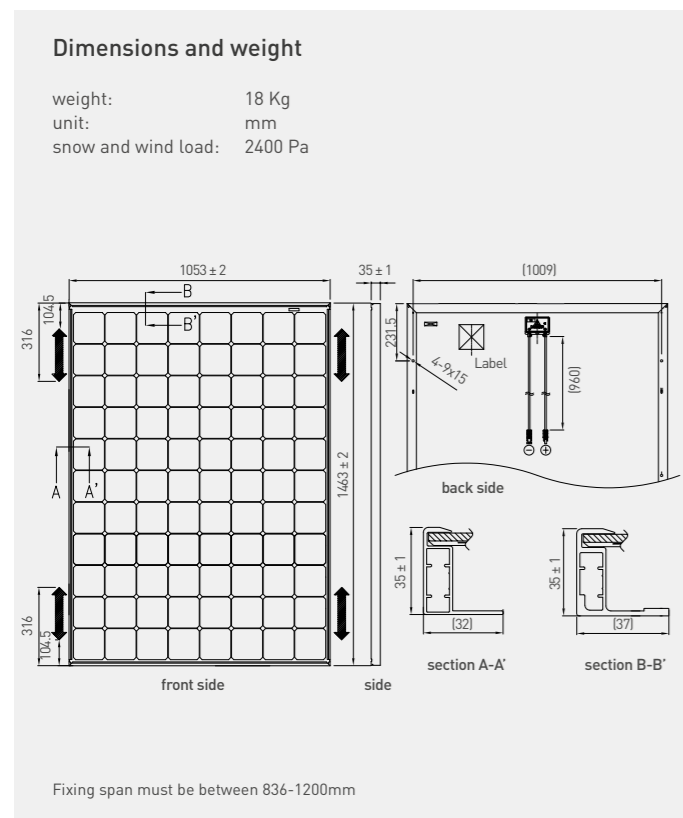

## Photovoltaic module HIT® N335K

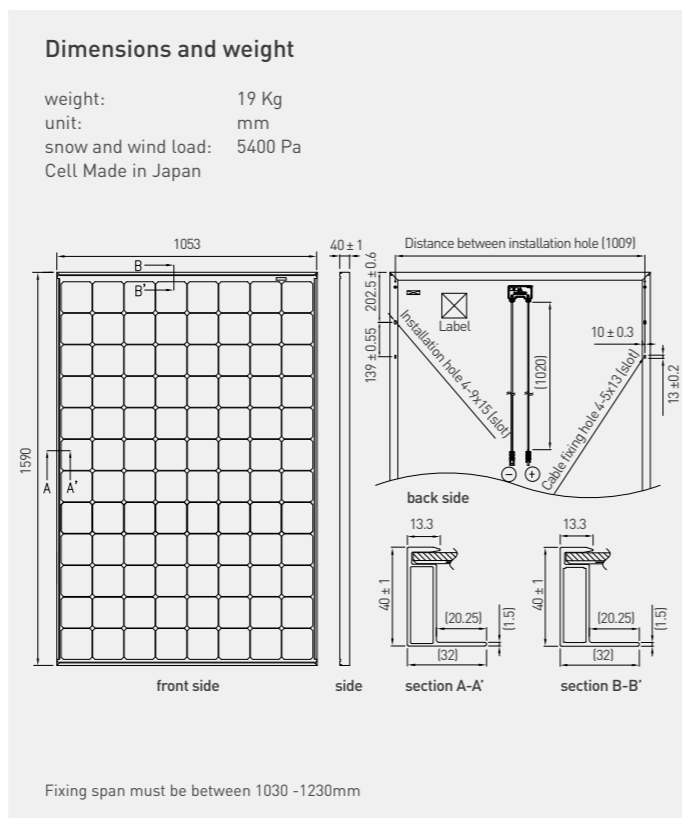

Electrical data (at STC)	Slim VBHN250SJ25	Compact VBHN300SJ46	HIT+ VBHN340SJ53	HIT+ VBHN335KJ01
Max. power (Pmax) [W]	250	300	340	335
Max. power voltage (Vpmax) [V]	44.3	53.1	59.7	59.9
Max. power current (Ipmax) [A]	5.65	6.65	5.7	5.6
Open circuit voltage (Voc) [V]	53.2	63.8	71.3	71.5
Short circuit current (Isc) [A]	6.03	6.04	6.13	6.05
Max. over current rating [A]	15	15	15	15
Power tolerance [%] *	10/0	10/0	10/0	10/0
Max. system voltage [V]	1000	1000	1000	1000
Solar Panel efficiency [%]	19.8	19.5	20.3	20.0

Note: Standard Test Conditions: Air mass 1.5; Irradiance = 1000W/m<sup>2</sup>; cell temp. 25°C.  
\* Maximum power at delivery. For guarantee conditions, please check our guarantee document.

### Temperature characteristics

Temperature (NOCT) [°C]	44.0	44.0	44.0	44.0
Temp. coefficient of Pmax [%/°C]	-0.258	-0.258	-0.258	-0.258
Temp. coefficient of Voc [%/°C]	-0.235	-0.235	-0.235	-0.235
Temp. coefficient of Isc [%/°C]	0.055	0.055	0.055	0.055

### At NOCT (Normal Operating Conditions)

Max. power (Pmax) [W]	191.2	229.5	260.2	255.8
Max. power voltage (Vpmax) [V]	42.0	50.7	56.8	56.8
Max. power current (Ipmax) [A]	4.55	4.52	4.58	4.50
Open circuit voltage (Voc) [V]	50.4	60.4	67.5	67.6
Short circuit current (Isc) [A]	4.88	4.88	4.96	4.89

Note: Normal Operating Cell Temp.: Air mass 1.5; Irradiance = 800W/m<sup>2</sup>; Air temperature 20°C; wind speed 1 m/s

### At low irradiance (20%)

Max. power (Pmax) [W]	47.3	58.0	63.3	63.8
Max. power voltage (Vpmax) [V]	42.0	52.1	57.7	57.7
Max. power current (Ipmax) [A]	1.12	1.11	1.13	1.11
Open circuit voltage (Voc) [V]	49.4	60.1	66.8	66.9
Short circuit current (Isc) [A]	1.21	1.21	1.23	1.21

Note: Low irradiance: Air mass 1.5; Irradiance = 200W/m<sup>2</sup>; cell temp. = 25°C

### Guarantee

Power output: 25 years linear (1st year 97 %, from 2nd year -0.45 %/year, in 25th year 86.2 %)  
Product workmanship: 25 years  
registration necessary on [www.eu-solar.panasonic.net](http://www.eu-solar.panasonic.net), otherwise 15 years apply based on guarantee

### Materials

Cell material: 5 inch photovoltaic cells  
Glass material: AR coated tempered glass  
Frame materials: Black anodized aluminium  
Connectors type: SMK

# This catalogue ends. Our partnership continues.

Find a Panasonic Solar Premium Installer in your area:

[bit.ly/panasonicsolar](http://bit.ly/panasonicsolar)

To become a Panasonic Solar Premium Installer, please register here:

[www.eu-solar.panasonic.net/en/premium-installer-register.htm](http://www.eu-solar.panasonic.net/en/premium-installer-register.htm)

**Panasonic**<sup>®</sup>

**Panasonic Life Solutions Europe**

**Panasonic Electric Works Europe AG**

Robert-Koch-Straße 100 · 85521 Ottobrunn · Germany

Tel. +49 89 45354-1000 · Fax +49 89 45354-2111

[info.solar@eu.panasonic.com](mailto:info.solar@eu.panasonic.com)

[www.eu-solar.panasonic.net](http://www.eu-solar.panasonic.net)

