

SmartPSB2000L Smart PV Safety Box Quick Guide

Issue: 06
Part Number: 31509508
Date: 2019-07-08

HUAWEI TECHNOLOGIES CO., LTD.



NOTICE

- The information in this document is subject to change due to version upgrades or other reasons. Every effort has been made in the preparation of this document to ensure accuracy of the contents, but all statements, information, and recommendations in this document do not constitute a warranty of any kind, express or implied.
- Only qualified and trained electrical technicians are allowed to operate the device.
- Carefully read this document and the precautions before installing the device. Failure to comply with the storage, installation, and operation regulations specified in this document may cause device damage, which is not covered by Huawei's warranty.
- If the equipment is used in a manner not specified by the manufacturer, the protection provided by the equipment may be impaired.
- Use insulated tools when installing the device. For personal safety, wear proper personal protective equipment (PPE).

1 Overview

The SmartPSB2000L smart PV safety box (safety box for short) is a key component that implements rapid shutdown and module monitoring for Huawei SUN2000P-375W smart PV optimizers. The safety box is easy to install, operate, and maintain.

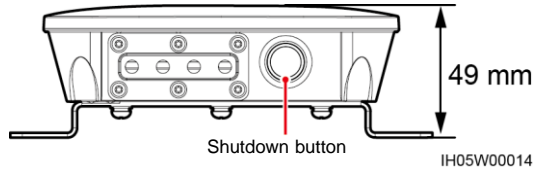
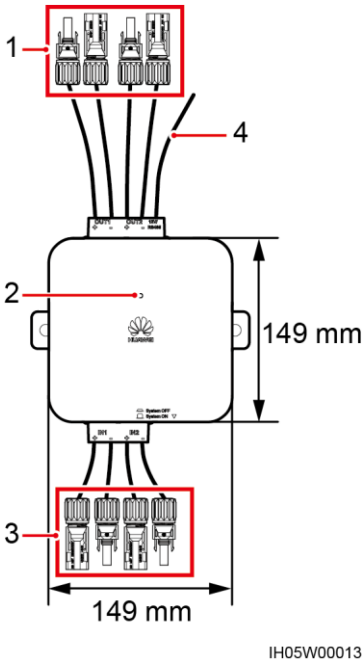

Rapid shutdown means that the power generation system consisting of optimizers, smart PV safety boxes, and inverters decreases the DC voltage to the safe voltage range (≤ 30 V) within the specified period (≤ 30 s).

| | |
|--------------------------|--|
| Prerequisites | An optimizer is installed for each PV module, and the rapid shutdown function of the safety box is enabled. |
| Trigger by button press | If the shutdown button (■) is pressed, the safety box enters the rapid shutdown state. The LED indicator is steady red, and the inverter turns off the AC output. This product cannot be used as a substitute for the emergency stop switch. |
| | If the shutdown button (■) is released, the safety box exits the rapid shutdown state. The output voltages of the optimizer and inverter are restored. The LED indicator changes from steady red to steady green. |
| Trigger by power failure | If the AC power fails, the safety enters the rapid shutdown state. The inverter and optimizer stop output and communication. The LED indicator changes from steady green to steady red, and then off. |
| | If the AC power resumes, the inverter, optimizer, and safety box restore to the normal state. |

| No. | Description |
|-----|---|
| 1 | Two routes of output terminals, cable length (including terminals) 250 mm |
| 2 | An LED indicator showing the running status of the safety box |
| 3 | Two routes of input terminals, cable length (including terminals) 150 mm |
| 4 | RS485 communication, PE, and 12 V power cables, 340 mm long |

2 Installation and Cable Connections

1. Install the safety box under or on a side of an inverter with the delivered M6x60 expansion bolts. It is recommended that an M8 drill bit be used to drill holes. The torque should be 4.5–5.5 N·m.
2. Connect the RS485 communications, PE, and 12 V power cables from the safety box to the corresponding port on the inverter.
3. Connect the output terminals of the safety box to the DC input ports of the inverter (one route is used as an example in the right figure).
4. Connect the input terminals of the safety box to the output ports of the optimizer string (one route is used as an example in the right figure).

NOTE

1. Each input of the safety box supports serial connection of up to 15 optimizers, and the string voltage should be less than 600 V DC.
2. After the cord end terminal is removed, the PE cable of the safety box and the communication PE cable of the power meter can be connected together to the communication terminal (pin 8) of the inverter.

Installation Mode 1 (Recommended Distance)

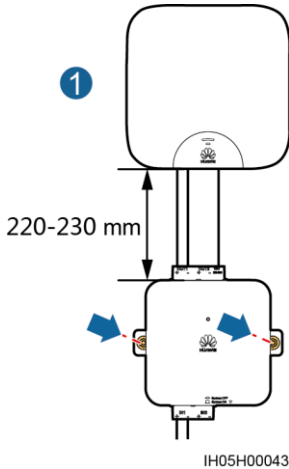

Installation Mode 2 (Recommended Distance)

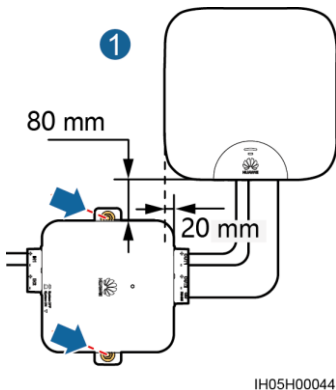

Wiring Diagram

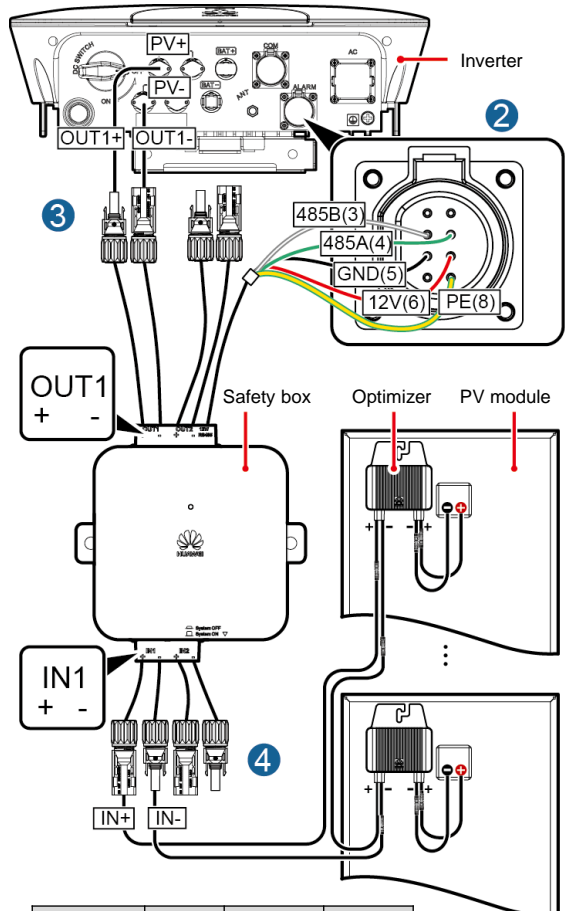

| Cable | Color | Cable | Color |
|---------|-------|--------|--------------|
| 485B(3) | White | 12V(6) | Red |
| 485A(4) | Green | PE(8) | Yellow-Green |
| GND(5) | Black | N/A | N/A |

IH05H00041

NOTE

Depending on the inverter model, the RS485 communications, PE, and 12 V power cables need to be connected to the COM or ALARM port of the inverter. The pins are wired in the same way.

| Port | Inverter Model |
|-------|---|
| COM | SUN2000L-3KTL-CN, SUN2000L-4KTL-CN, SUN2000L-5KTL-CN |
| ALARM | SUN2000L-2KTL, SUN2000L-3KTL, SUN2000L-3.68KTL, SUN2000L-4KTL, SUN2000L-4.6KTL, SUN2000L-5KTL |

COM or ALARM Terminal Connection

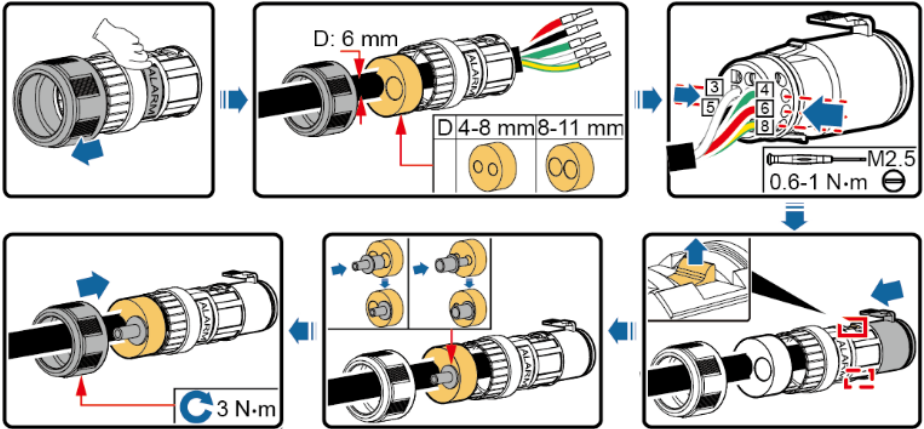

IH05I40001

3 Powering On the Safety Box

NOTICE

1. Check whether all cables to the safety box are properly connected.
2. Input and output terminals are correctly paired, and no crossover exists.

1. Switch on the AC circuit breaker between the inverter and the power grid (the AC voltage of the power grid should be in the range allowed by the inverter).
2. Turn the DC switch at the bottom of the inverter to the ON position.
3. Observe the LED indicator on the safety box. The status change sequence should be: blinking green at long intervals > blinking green at short intervals. If the LED indicator is abnormal, check whether cables are connected correctly and securely.

| LED Status | Description |
|--|--|
| Blinking green at long intervals | Power on self test. |
| Blinking green at short intervals | Communicating with the inverter properly and not communicating with the optimizer. |
| Steady green | Communicating with the inverter and optimizer properly. |
| Steady red | Shutdown. |
| Blinking green at long intervals: on for 1s and then off for 1s | |
| Blinking green at short intervals: on for 0.2s and then off for 0.2s | |

4 Adding the Smart PV Safety Box

NOTE

1. The inverter and Smart PV Safety Box cannot perform any commissioning tasks when the AC power is disconnected.
2. The inverter software version matching the smart PV safety box must be V100R001C00SPC317 or later. The FusionSolar app version must be 2.1.11.302 or later.
3. The app screen snapshots provided in this document correspond to FusionSolar 2.3.0. The figures are for reference only.
4. The initial password for connecting the inverter WiFi is Changeme. The initial password of the installer is 00000a. Use the initial password upon first power-on and change it immediately after login. To ensure account security, change the password periodically and keep the new password in mind. Not changing the initial password may cause password disclosure. A password left unchanged for a long period of time may be stolen or cracked. If a password is lost, devices cannot be accessed. In these cases, the user is liable for any loss caused to the PV plant.

4.1 Adding the Smart PV Safety Box

1. Access the **Device commissioning**.

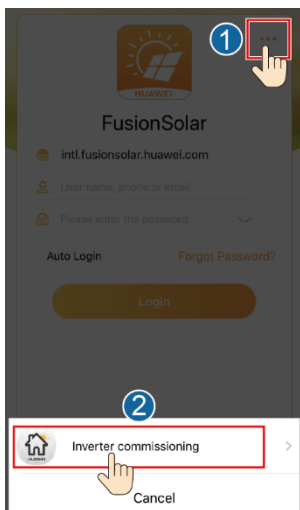

2. Connect to the inverter WiFi. Log in as **installer**, and choose **Home > Device maintenance > Add/Delete device**.

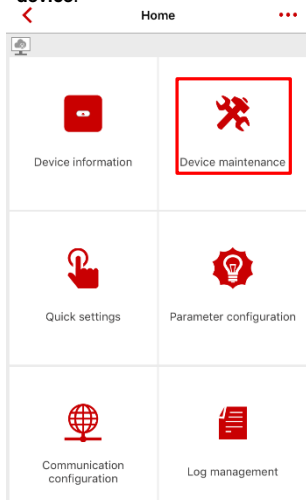

3. Tap **+** of the **Smart PV safety box**.

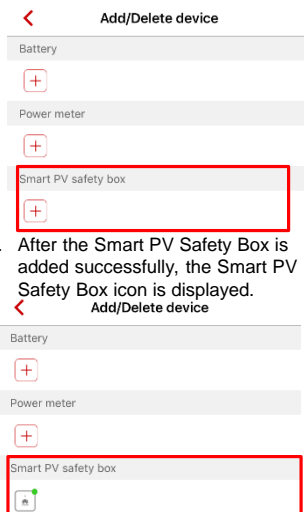

4. After the Smart PV Safety Box is added successfully, the Smart PV Safety Box icon is displayed. **Add/Delete device**

NOTE

1. If the Smart PV Safety Box icon is green, the Smart PV Safety Box is running properly.
2. If the Smart PV Safety Box icon is yellow, the Smart PV Safety Box is in standby state.
3. If the Smart PV Safety Box icon is gray, the Smart PV Safety Box is abnormal in communication. Check whether its cable connections and communications parameters are correct.
4. If the Smart PV Safety Box icon is red, the Smart PV Safety Box is in rapid shutdown check state.

4.2 Performing Rapid Shutdown Check

Tap the shutdown box icon to access the screen for enabling **Rapid shutdown** or performing rapid shutdown check.

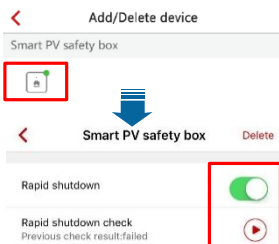

NOTE

1. You need to enable **Rapid shutdown** and start **Rapid shutdown check** only if an optimizer is installed for each PV module. To support the rapid shutdown function, enable **Rapid shutdown** (disabled by default) for the Smart PV Safety Box. If **Rapid shutdown** is disabled, the rapid shutdown function is ineffective.
2. If optimizers are installed only for certain PV modules, the rapid shutdown function is ineffective no matter whether you enable **Rapid shutdown** or press the shutdown button.
3. **Rapid shutdown check** is displayed only if **Rapid shutdown** is enabled.

5 FAQ

5.1 Upgrading the Software

NOTE

1. Obtain the upgrade file from your dealer or Huawei engineers.
2. On the Android system, you can copy the upgrade file to the mobile phone. The upgrade file name extension must be .zip, the file can be flexibly stored, and **Manually select** is supported.
3. On the iOS system, you can import the upgrade file to the app through a mailbox. The upgrade file name extension must be .zip, and **Manually select** is not supported.
4. Upgrading the Smart PV Safety Box or optimizer lasts for 10–20 minutes.

1. Access **Inverter commissioning**
2. Choose **Home > Device maintenance > Upgrade device**.
3. Tap **upgrade** of the Smart PV Safety Box.

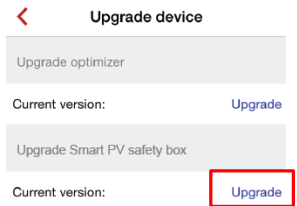
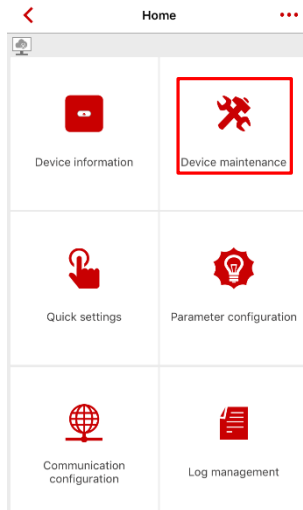
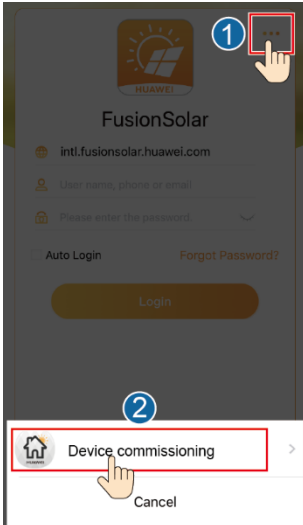

4. Select the appropriate upgrade package and finish the upgrade.

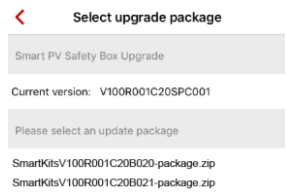

5.2 Replacing the Smart PV Safety Box

Replace the Smart PV Safety Box if any of the following faults occurs.

- The appearance is seriously damaged.
- Cables are seriously damaged.
- The LED indicator status does not match the actual status.
- The key button is damaged and fails.
- The key button is not damaged, but the shutdown function fails.

1. Turn off the DC input switch on the inverter and the switch on the AC output loop.
2. Remove the old Smart PV Safety Box.
3. Install a new Smart PV Safety Box, as shown in the chapter 2.
4. Turn on the DC input switch on the inverter and the switch on the AC output loop.
5. Unlock optimizers. Access the Device commissioning. Log in as installer, choose **Home > Parameter configuration > Expert > Feature parameters**, and enable **Unlock optimizer**. Unlock the optimizer and the original Smart PV Safety Box.
6. Choose **Home > Device maintenance > Add/Delete device > Optimizer**, and tap **Auto search** to search for the optimizer. You need to perform this step when replacing the Smart PV Safety Box, optimizer, or inverter.

NOTICE

- Obtain the user's consent before replacing the Smart PV Safety Box, as the inverter may have no output during the replacement.
- The Smart PV Safety Box can be replaced only 30 seconds after you turn off the DC input switch on the inverter and the switch on the AC output loop.

6 Technical Specifications

| Item | Specifications |
|-------------------------------------|--|
| Maximum input voltage | 600 V DC |
| Maximum input current | 15 A |
| Maximum short-circuit current | 15 A |
| Maximum number of inputs | 2 |
| Maximum output voltage | 600 V DC |
| Maximum output current | 15 A |
| Maximum number of outputs | 2 |
| DC power supply | 12 V DC |
| Protection level | IP65 |
| Power consumption | < 3 W |
| Noise | < 35 dB |
| Cooling mode | Natural cooling |
| Display | LED |
| Installation mode | Wall-mounted |
| Dimensions | 149 mm x 149 mm x 49 mm (excluding cables) |
| Weight | 0.8 kg (including cables) |
| Input and output terminals | H4 x 2/H4 x 2 |
| Operating temperature | -30°C to +55°C |
| Operating humidity | 5%–95% RH |
| Operating altitude | 0–4000 m (≥ 2000 m: 1°C/200 m derating) |
| Storage temperature | -40°C to +70°C |
| Storage humidity | 5%–95% RH |
| Networking mode | RS485 |
| Safety compliance | IEC62109 |
| Electromagnetic compatibility (EMC) | IEC61000-6-2, IEC61000-6-3 |
| Mean time between failures (MTBF) | 500,000 hours |
| Design life | 25 years (excluding field replaceable parts) |
| Environmental protection | RoHS |

Huawei Technologies Co., Ltd.
Huawei Industrial Base, Bantian, Longgang
Shenzhen 518129 People's Republic of China
www.huawei.com