

Technical Information

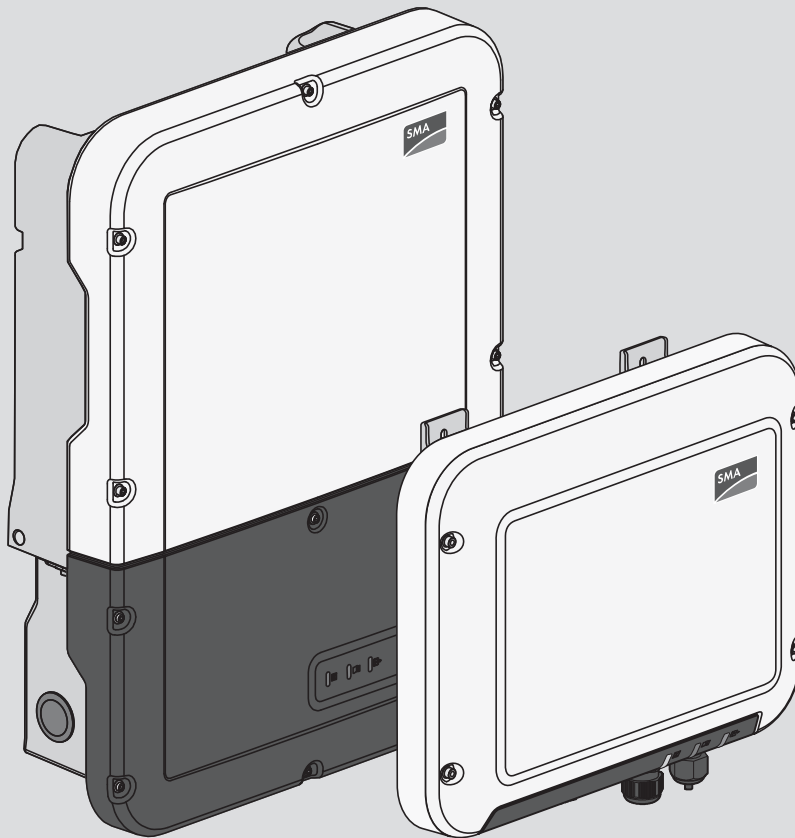

# SUNNY BOY STORAGE

Approved Batteries and Information on Battery  
Communication Connection



# Table of Contents

<b>1</b>	<b>Approved Batteries .....</b>	<b>3</b>
1.1	SBS2.5-1VL-10 / SBS3.7-10 / SBS5.0-10 / SBS6.0-10 .....	3
1.2	SBS3.8-US-10 / SBS5.0-US-10 / SBS6.0-US-10.....	7
<b>2</b>	<b>Battery Communication Connection .....</b>	<b>9</b>
2.1	Cable Requirements.....	9
2.1.1	SBS2.5-1VL-10.....	9
2.1.2	SBS3.7-10 / SBS5.0-10 / SBS6.0-10 .....	9
2.1.3	SBS3.8-US-10 / SBS5.0-US-10 / SBS6.0-US-10 .....	10
2.2	Cabling Plan.....	10
2.2.1	SBS2.5-1VL-10.....	10
2.2.2	SBS3.7-10 / SBS5.0-10 / SBS6.0-10 / SBS3.8-US-10 / SBS5.0-US-10 / SBS6.0-US-10.....	12
<b>3</b>	<b>Information about the electrical connection .....</b>	<b>16</b>

# 1 Approved Batteries

## 1.1 SBS2.5-1VL-10 / SBS3.7-10 / SBS5.0-10 / SBS6.0-10

In the tables you will find the batteries which are approved for operation with the following battery inverters of SMA Solar Technology AG (status: 2020/08):

- SBS2.5-1VL-10 (Sunny Boy Storage 2.5)
- SBS3.7-10 (Sunny Boy Storage 3.7)
- SBS5.0-10 (Sunny Boy Storage 5.0)
- SBS6.0-10 (Sunny Boy Storage 6.0)

Type (Manufacturer)	Modules	Required battery firmware version for:		Required inverter firmware version for:	
		SBS2.5-1VL-10	SBS3.7-10, SBS5.0-10, SBS6.0-10	SBS2.5-1VL-10	SBS3.7-10, SBS5.0-10, SBS6.0-10
RESU7H / EH111063P3S3 Type C (LG Chem)	Not modular	≥ 15.02.4.R	≥ 16.02.6 R	≥ 2.04.23.R	≥ 1.00.20.R
RESU10H / 15563P3SDLT Type C (LG Chem)	Not modular	≥ 13.13.0.R	≥ 16.13.6 R	≥ 2.04.14.R	≥ 1.00.20.R
RESU10M (LG Chem)	Not modular	Not released	≥ 1.01.1 R	Not released	≥ 3.11.03.R
Battery-Box H 5.1-10.2 (BYD Company Limited)	4-8	3.00.04.R to 3.00.11.R	3.00.04.R to 3.00.11.R	≥ 2.04.23.R	≥ 1.00.20.R
Battery-Box Pre- mium HVS 5.1-10.2 (BYD Company Limited)	2-4	Not released	BMU 3.13 BMS.B-3.19	Not released	≥ 3.11.10.R
Battery-Box Pre- mium HVM 8.3-22.1 (BYD Company Limited)	3-8	Not released	BMU 3.12 BMS.B-3.18	Not released	≥ 3.11.03.R

Type (Manufacturer)	Modules	Required battery firmware version for:		Required inverter firmware version for:	
		SBS2.5-1VL-1 0	SBS3.7-10, SBS5.0-10, SBS6.0-10	SBS2.5-1VL-1 0	SBS3.7-10, SBS5.0-10, SBS6.0-10
Hyperion 7.5-15 (BMZ GmbH)	3-6	Not released	≥ 0.03.07.R	Not released	≥ 3.11.10.R
era:powerbase 7.5-15 (IBC SOLAR AG)	3-6	Not released	≥ 0.03.07.R	Not released	≥ 3.11.10.R
AXIstorage Li SH 7.5-15 (AXITEC)	3-6	Not released	≥ 0.03.07.R	Not released	≥ 3.11.10.R

The firmware version of the battery can be accessed via the user interface of the inverter. The firmware version of the BYD batteries can also be accessed via the user interface of the battery (see manufacturer's manual). With the exception of the BYD Battery-Box (H, Premium HVS and HVM), the battery firmware is automatically updated via the inverter. The firmware version of the inverter can also be accessed via the user interface of the inverter.

When using the BYD Battery-Box Premium HVS and HVM with the Sunny Boy Storage 3.7/ 5.0/ 6.0, note the "Information on Commissioning" in the download area of our homepage under <http://www.SMA-Solar.com>.

### Synchronizing the battery and battery inverter

All batteries mentioned supply a defined nominal current. Please pay attention to the battery manufacturer's recommendation regarding the suitable dimensioning of the battery in order to achieve the nominal and overload currents of the systems stated in the datasheet with a Sunny Boy Storage. Only if the dimensioning of the battery size is synchronized (battery capacity, battery currents, number of battery modules if necessary), the full functionality and power incl. overload can be guaranteed for the PV storage system with the respective battery inverter in use.

### Recommendations for the use in various systems for SBS2.5-1VL-10:

Type	Use in systems for increased self- consumption	Use in systems with secure power supply operation	Use in battery- backup systems
RESU7H type C	✓	✗	✗
RESU10H type C	✓	✗	✗
Battery-Box H 5.1	✓	✗	✗
Battery-Box H 6.4	✓	✗	✗
Battery-Box H 7.7	✓	✗	✗

Type	Use in systems for increased self-consumption	Use in systems with secure power supply operation	Use in battery-backup systems
Battery-Box H 9.0	✓	✗	✗
Battery-Box H 10.2	✓	✗	✗

✓ = Yes, ✗ = No

### Recommendations for the use in various systems for SBS3.7-10 / SBS5.0-10 / SBS6.0-10:

Battery type (module configuration)	Use in systems for/with				
	Increased self-consumption	secure power supply operation	battery-backup operation	with multi-battery operation of the <u>same</u> type	with multi-battery operation of other types*
RESU7H Type C	✓	✓	✓**	✓	✓ RESU10H Battery-Box H
RESU10H Type C	✓	✓	✓**	✓	✓ RESU7H Battery-Box H
RESU10M	✓	✓	✓	✓	✗
Battery-Box H (5.1 - 10.2)	✓	✓	✓	✓	✓ RESU7H und 10H, HVS, HVM
Battery-Box Premium HVS (5.1-10.2)	✓	✓	✓	✓	✓ HVM Battery-Box H
Battery-Box Premium HVM (8.3-22.1)	✓	✓	✓	✓	✓ HVS Battery-Box H
Hyperion (7.5-15)	✓	✓	✓	✗ in planning	✗
era:powerbase (7.5-15)	✓	✓	✓	✗ in planning	✗

Battery type (module configuration)	Use in systems for/with				
	Increased self-consumption	secure power supply operation	battery-backup operation	with multi-battery operation of the <u>same</u> type	with multi-battery operation of other types*
AXIstorage Li SH (7.5-15)	✓	✓	✓	✗ in planning	✗

\* Note that the displayed state of charge may jump when using multi-battery operation with batteries of different capacities. It is therefore recommended to select batteries of similar capacity.

\*\* Depending on the state of charge in terms of battery and PV generation, it can happen that the battery-backup grid is interrupted for a few seconds in battery-backup operation mode during load changes and then restarts again. With an additional parameter setting, it will be possible in future to limit the output power of the PV inverter dynamically or to limit to 0 W or to deactivate the PV inverter. This parameter setting is expected to be available after a firmware update in Q2/2019.

✓ = Yes, ✗ = No

### Recommendations for use for SBS3.7-10 / SBS5.0-10 / SBS6.0-10:

Type	Module configuration		SBS 3.7	SBS 5.0	SBS 6.0
	Capacity (kWh)	Modules			
RESU7H type C	Not modular		✓	✓	✓
RESU10H type C	Not modular		✓	✓	✓
RESU10M	Not modular		✓	(✓)	(✓)
Battery-Box H	5.1	4	✓	(✓)	(✓)
	6.4	5	✓	✓	(✓)
	7.7	6	✓	✓	✓
	9.0	7	✓	✓	✓
	10.2	8	✓	✓	✓
Battery-Box Premium HVS	5.1	2	✓	(✓)	(✓)
	7.7	3	✓	✓	✓
	10.2	4	✓	✓	✓
Battery-Box Premium HVM	8.3	3	✓	(✓)	(✓)
	11.0	4	✓	✓	(✓)
	13.8	5	✓	✓	✓
	16.6	6	✓	✓	✓
	19.3	7	✓	✓	✓
	22.1	8	✓	✓	✓

Type	Module configuration		SBS 3.7	SBS 5.0	SBS 6.0
	Capacity (kWh)	Modules			
Hyperion	7.5	3	✓	(✓)	(✓)
era:powerbase	10	4	✓	✓	✓
AXIstorage Li SH	12.5	5	✓	✓	✓
	15	6	✓	✓	✓

✓ = Yes, (✓) = Limited approval

Background information on the limited approval of some inverter/battery combinations

Example: In the worst-case scenario, the BYD Battery-Box Premium HVM 8.3 can only provide a maximum output power of 3700 W, depending on the SOC. For this application, the SBS3.7 is completely sufficient. Operation with the SBS5.0/6.0 is technically possible, but does not make economic sense due to oversizing.

## 1.2 SBS3.8-US-10 / SBS5.0-US-10 / SBS6.0-US-10

In the tables you will find the batteries which are approved for operation with the following battery inverters of SMA Solar Technology AG (status: 2020/07):

- SBS3.8-US-10 (Sunny Boy Storage 3.8-US)
- SBS5.0-US-10 (Sunny Boy Storage 5.0-US)
- SBS6.0-US-10 (Sunny Boy Storage 6.0-US)

Type (Manufacturer)	Required battery firmware version for:*	Required inverter firmware version for:**
RESU10H*** / R15563P3SDLT (LG Chem)	≥ 16.13.6 R****	≥ 1.00.20.R
Battery-Box H (5.0)*** (BYD Company Limited)	≥ 3.00.04R	≥ 1.00.20.R
Battery-Box H (7.5)*** (BYD Company Limited)	≥ 3.00.04R	≥ 1.00.20.R

Type (Manufacturer)	Required battery firmware version for:*	Required inverter firmware version for:**
Battery-Box H (10.0)*** (BYD Company Limited)	≥ 3.00.04R	≥ 1.00.20.R

\* The firmware version of the battery can be accessed via the user interface of the inverter. The firmware version of the BYD batteries can also be accessed via the user interface of the battery (see manufacturer's manual).

\*\* The firmware version of the inverter can be accessed via the user interface of the inverter.

\*\*\* This battery is certified for the operation with the Sunny Boy Storage in SMA Energy Storage systems according to UL 9540. The battery is listed within the SMA Energy Storage systems according to UL 9540.

\*\*\*\* The firmware version of the battery can be updated via the user interface of the inverter.

### Synchronizing the battery and battery inverter

All batteries mentioned supply a defined nominal current. Please pay attention to the battery manufacturer's recommendation regarding the suitable dimensioning of the battery in order to achieve the nominal and overload currents of the systems stated in the datasheet with a Sunny Boy Storage. Only if the dimensioning of the battery size is synchronized (battery capacity, battery currents, number of battery modules if necessary), the full functionality and power incl. overload can be guaranteed for the PV storage system with the respective battery inverter in use.

### Recommendations for the use in various systems for SBS3.8-US-10 / SBS5.0-US-10 / SBS6.0-US-10:

Type (module configuration)	for increased self-consumption	with secure power supply operation	Use in battery-backup systems	Use in systems with multi-battery operation with batteries	
				of the <u>same</u> type	of other types*
RESU10H type C	✓	✓	✓**	✓	✓ Battery-Box H
Battery-Box H (5.0)	✓	✓	✓	✓	✓ RESU10H
Battery-Box H (7.5)	✓	✓	✓	✓	✓ RESU10H



Type (module configuration)	for increased self-consumption	with secure power supply operation	Use in battery-backup systems	Use in systems with multi-battery operation with batteries	
				of the <u>same</u> type	of other types*
Battery-Box H (10.0)	✓	✓	✓	✓	RESU10H ✓

\* Note that the displayed state of charge may jump when using multi-battery operation with batteries of different capacities. It is therefore recommended to select batteries of similar capacity.

\*\* Depending on the state of charge in terms of battery and PV generation, it can happen that the battery-backup grid is interrupted for a few seconds in battery-backup operation mode during load changes and then restarts again. With an additional parameter setting, it will be possible in future to limit the output power of the PV inverter dynamically or to limit to 0 W or to deactivate the PV inverter. This parameter setting is expected to be available after a firmware update in Q2/2019.

✓ = Yes, ✗ = No

## 2 Battery Communication Connection

### 2.1 Cable Requirements

#### 2.1.1 SBS2.5-1VL-10

- Twisted pair conductors
- Cable category: minimum CAT5e
- Shielding: yes
- Conductor cross-section: 0.25 mm<sup>2</sup> to 0.34 mm<sup>2</sup> (24 AWG to 16 AWG)
- Recommended number of conductor pairs: 4
- Maximum cable length: 10 m (33 ft)
- The cable has to be insulated for 600 V.
- UV-resistant for outdoor use. SMA Solar Technology AG recommends the cable "UC900 SS23 Cat.7 PE"
- Comply with the requirements of the battery manufacturer.

#### 2.1.2 SBS3.7-10 / SBS5.0-10 / SBS6.0-10

- Twisted pair conductors
- Cable category: minimum CAT5e
- Shielding: yes
- Conductor cross-section: 0.25 mm<sup>2</sup> to 0.34 mm<sup>2</sup> (24 AWG to 16 AWG)
- External diameter: 6 mm to 8.5 mm (0.24 in to 0.33 in)
- Recommended number of conductor pairs: 4

- Maximum cable length between battery and inverter and, in battery-backup systems, between automatic transfer switch and inverter: 10 m (33 ft)
- The cable has to be insulated for 600 V.
- UV-resistant for outdoor use.
- Comply with the requirements of the battery manufacturer.

### 2.1.3 SBS3.8-US-10 / SBS5.0-US-10 / SBS6.0-US-10

- Twisted pair conductors
- Cable category: minimum CAT5e
- Shielding: yes
- Conductor cross-section: 0.25 mm<sup>2</sup> to 0.34 mm<sup>2</sup> (24 AWG to 16 AWG)
- External diameter: 6 mm to 8.5 mm (0.24 in to 0.33 in)
- Recommended number of conductor pairs: 4
- Maximum cable length between battery and inverter and, in battery-backup systems, between automatic transfer switch and inverter: 10 m (33 ft)
- If the cables are routed together with the DC conductors in a conduit, each cable has to be insulated for 600 V.
- UV-resistant for outdoor use.
- Comply with the requirements of the battery manufacturer.

## 2.2 Cabling Plan

### 2.2.1 SBS2.5-1VL-10

#### Sunny Boy Storage with LG Chem RESU7H / RESU10H

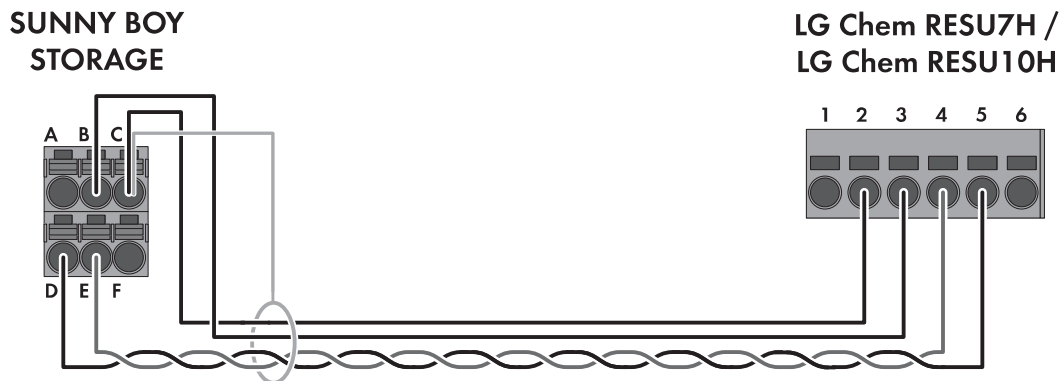

Figure 1: Cabling plan SBS2.5-1VL-10 with RESU7H / RESU10H

Clamping position	Assignment	Clamping position	Assignment
A	Not assigned	-	-
B	Enable	3	BAT EN

Clamping position	Assignment	Clamping position	Assignment
C	GND and shielding	2	GND - AUX
D	CAN L (twisted pair conductors, at least CAT5e)	5	CAN - L
E	CAN L (twisted pair conductors, at least CAT5e)	4	CAN - H
F	Not assigned	-	-

### Sunny Boy Storage (SBS2.5-1VL-10) with BYD Battery-Box H



Figure 2: Cabling plan SBS2.5-1VL-10 with Battery-Box H

Clamping position	Assignment	Clamping position	Assignment
A	Not assigned	-	-
B	Enable	2	EN 11 V +
C	GND and shielding	4	EN 11 V-
D	CAN L (twisted pair conductors, at least CAT5e)	8	CANL
E	CAN L (twisted pair conductors, at least CAT5e)	6	CANH
F	Not assigned	-	-

## 2.2.2 SBS3.7-10 / SBS5.0-10 / SBS6.0-10 / SBS3.8-US-10 / SBS5.0-US-10 / SBS6.0-US-10

### Sunny Boy Storage with LG Chem RESU7H / RESU10H

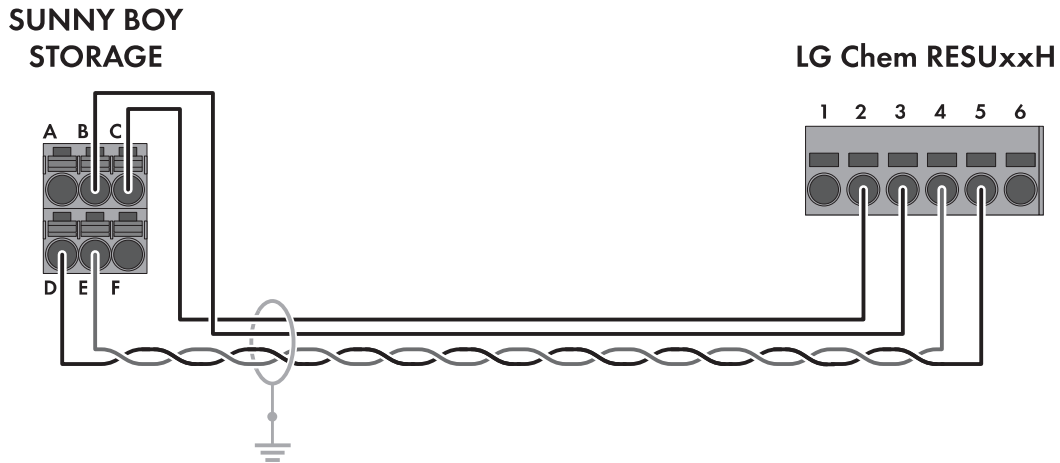

Figure 3: Cabling plan SBS3.7-10 / SBS5.0-10 / SBS6.0-10 / SBS3.8-US-10 / SBS5.0-US-10 / SBS6.0-US-10 with RESU7H / RESU10H

Clamping position	Assignment	Clamping position	Assignment
A	Not assigned	-	-
B	Enable	3	BAT EN
C	GND	2	GND - AUX
D	CAN L (twisted pair conductors, at least CAT5e)	5	CAN - L
E	CAN L (twisted pair conductors, at least CAT5e)	4	CAN - H
F	+12V supply for automatic transfer switching device	-	-

## Sunny Boy Storage 3.7 with LG Chem RESU10M

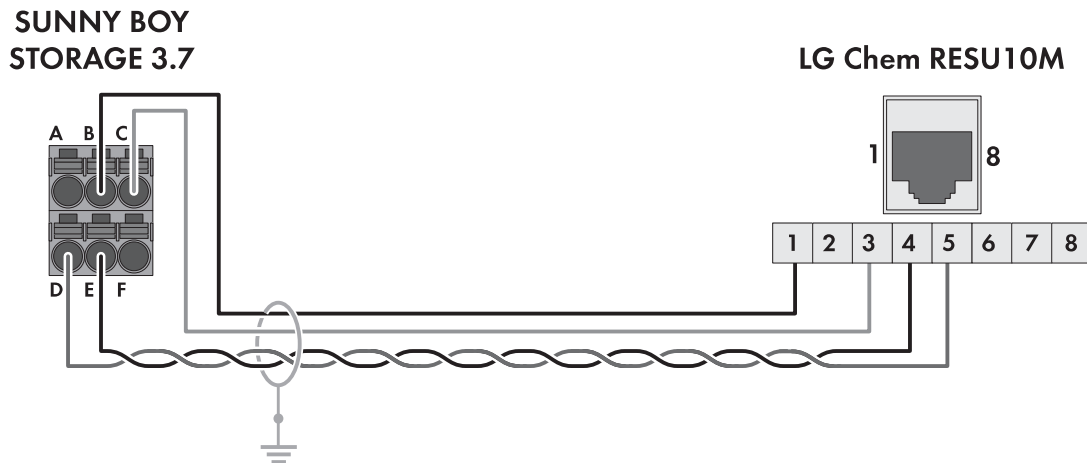

Figure 4: Cabling plan SBS3.7-10 with RESU10M

Clamping position	Assignment	Pin	Assignment
A	Not assigned	-	-
B	Enable	1	Enable
C	GND	3	GND
D	CAN L (twisted pair conductors, at least CAT5e)	5	CAN L
E	CAN L (twisted pair conductors, at least CAT5e)	4	CAN H
F	+12V supply for automatic transfer switching device	-	-

## Sunny Boy Storage with BYD Battery-Box H

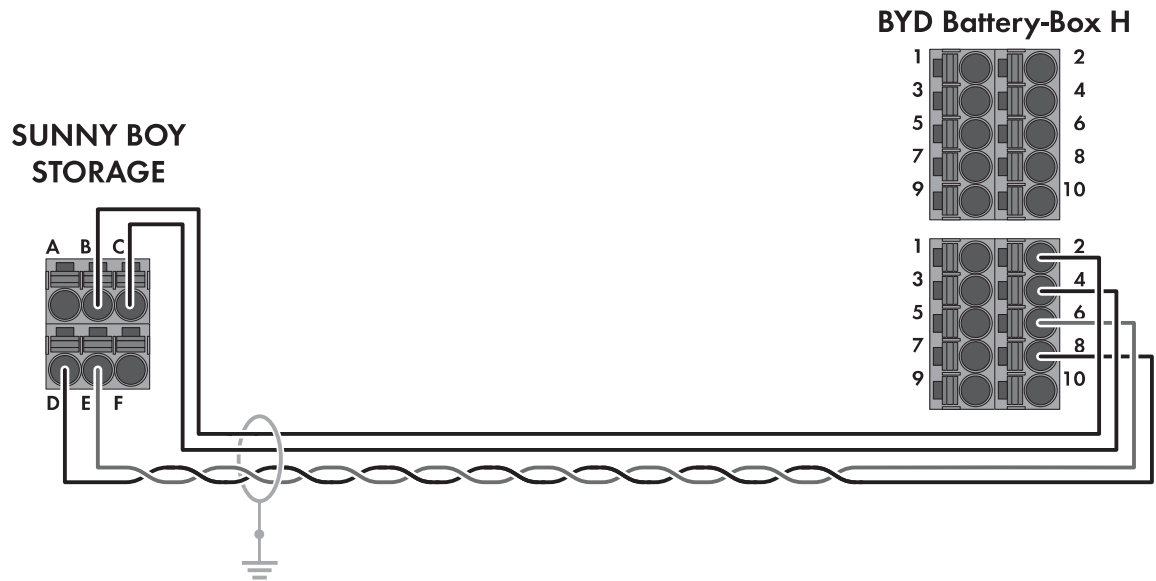

Figure 5: Cabling plan SBS3.7-10 / SBS5.0-10 / SBS6.0-10 / SBS3.8-US-10 / SBS5.0-US-10 / SBS6.0-US-10 with Battery-Box H

Clamping position	Assignment	Clamping position	Assignment
A	Not assigned	-	-
B	Enable	2	EN 11 V +
C	GND	4	EN 11 V -
D	CAN L (twisted pair conductors, at least CAT5e)	8	CANL
E	CAN L (twisted pair conductors, at least CAT5e)	6	CANH
F	+12V supply for automatic transfer switching device	-	-

## Sunny Boy Storage with BYD Battery-Box Premium HVS and HVM

When using the BYD Battery-Box Premium HVS or HVM with the Sunny Boy Storage 3.7/ 5.0/ 6.0, note the "Information on Commissioning" in the download area of our homepage under <http://www.SMA-Solar.com>.

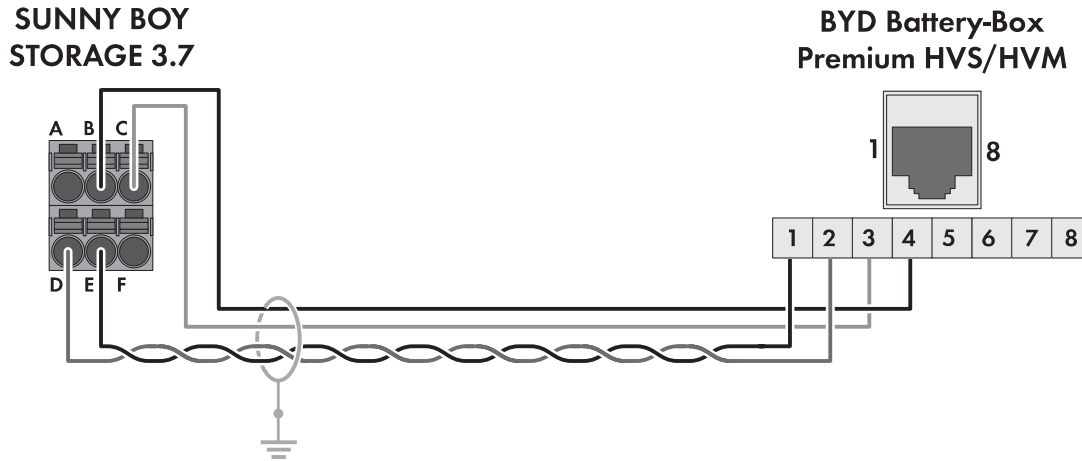

Figure 6: Cabling plan SBS3.7-10 / SBS5.0-10 / SBS6.0-10 / SBS3.8-US-10 / SBS5.0-US-10 / SBS6.0-US-10 with Battery-Box Premium HVS or HVM

Clamping position	Assignment	Pin
A	Not assigned	-
B	Enable	4
C	GND	3
D	CAN L (twisted pair conductors, at least CAT5e)	2
E	CAN L (twisted pair conductors, at least CAT5e)	1
F	+12V supply for automatic transfer switching device	-

## Sunny Boy Storage with BMZ Hyperion, IBC SOLAR era:powerbase and Axitec AXIstorage Li SH

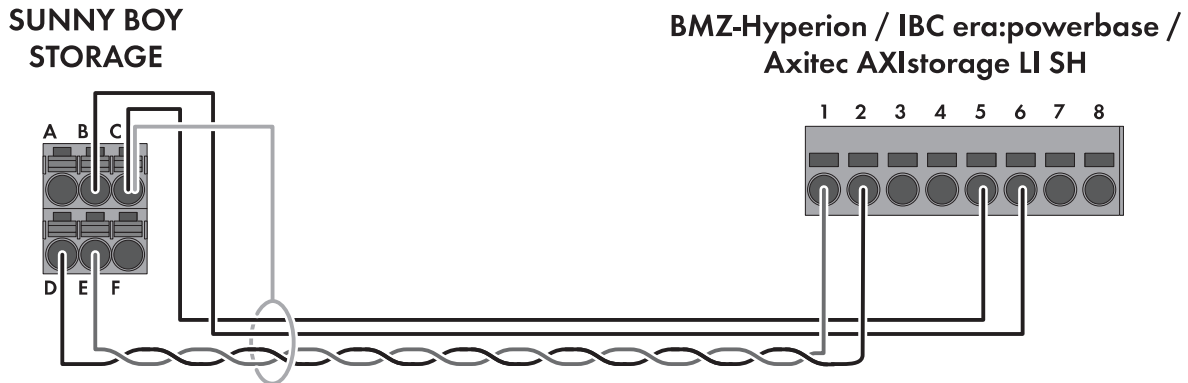

Figure 7: Cabling plan SBSxx-10 with BMZ Hyperion, IBC era:powerbase and Axitec AXIstorage Li SH

Clamping position	Assignment	Pin
A	Not assigned	-
B	Enable	6 (red)
C	GND	5 (black)
D	CAN L (twisted pair conductors, at least CAT5e)	2 (white)
E	CAN L (twisted pair conductors, at least CAT5e)	1 (yellow)
F	+12V supply for automatic transfer switching device	-

### 3 Information about the electrical connection

#### Connection of batteries with a charging/discharging current limit of 20 A

This connection is recommended for the following batteries:

- LG RESU7H
- LG RESU10H

#### Procedure:

The DC terminals A and B must be switched parallelly using the jumpers provided.



The battery must be connected to the terminal blocks **A+** and **A-**.

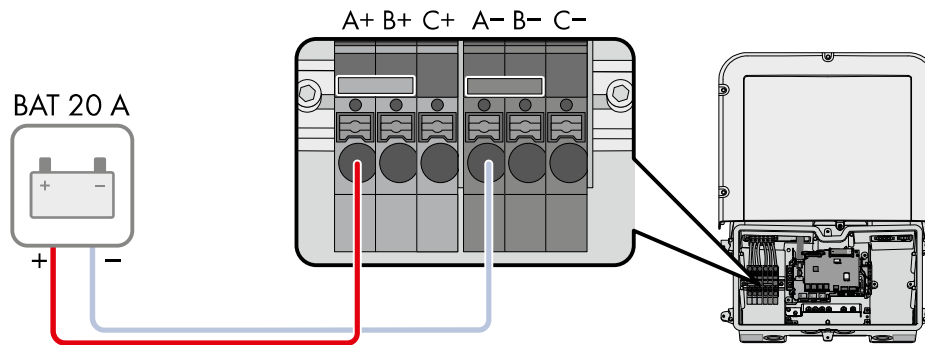

Figure 8: Overview for connection of a battery with a charging/discharging current limit of 20 A

### Connection of a battery with a charging/discharging current higher than 20 A

This connection is recommended for the following batteries:

- LG RESU 10M
- BYD Battery-Box H 5.1-10.2
- BYD Battery-Box Premium HVS 5.1-10.2
- BYD Battery-Box Premium HVM 8.3-22.1
- BMZ Hyperion
- IBC SOLAR era:powerbase
- Axitec AXIstorage Li SH

#### Procedure:

All DC terminals must be switched parallelly with the jumpers provided.

The battery must be connected to the terminal blocks **A+** and **A-**.

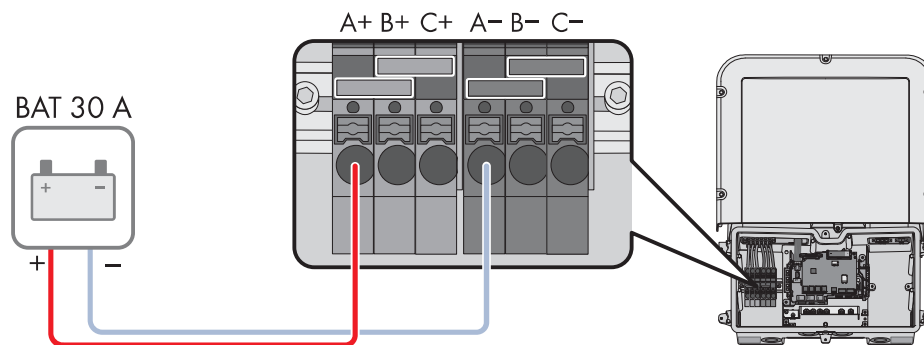

Figure 9: Overview for connection of one battery with a charging/discharging current higher than 20 A.

#### Information:

From Sunny Boy Storage firmware version 3.11.03.R, the DC input current of the inverter is additionally monitored. If the limit of 40 A is exceeded, the battery is automatically switched off for protection. This results in a permanent operation inhibition. It is therefore not necessary to install an external fuse between battery and Sunny Boy Storage for all listed batteries, even those with output

currents greater than 40 A.

This document does not replace any regional, state, provincial, federal or national laws, regulations or standards that apply to the installation, electrical safety and use of the product. Always observe the local regulations as well.



