



what if...

... there could be a new future
for green energy?

BISOL Group is a European manufacturer of premium photovoltaic modules and it provides a full range of photovoltaic solutions, running its international operations from offices in Slovenia, Belgium, France, Italy and United Kingdom. Our vision is to create a greener environment and future energy independence by continuously investing in technology, developing visionary products and increasing returns from photovoltaic investments. Across Europe, we are making green energy more cost-effective compared to conventional energy sources.

Throughout history, the most passionate people have brought the most profound change. The best ideas have come from those with the brilliance and devotion to believe anything is possible. At BISOL Group, the world's leading experts are raising industry standards and inventing creative solutions. Because we design products that offer the strongest lifetime energy yields, green energy has become more attractive than ever before.

We live in a world borrowed from our children.

This is why we take our responsibility to the environment and the community around us very seriously. From the conception of a new product all the way to its everyday use, we consider our carbon footprint. It takes less than a year of operation to pay back the energy used to produce the BISOL modules, which lets you quickly make a positive contribution to the environment.

As a member of CERES, the non-profit organisation who recycles all our modules, we are sure that the raw materials from our products can start a new life in a sustainable world for future generations. The BISOL HDPE mounting systems are also manufactured with recyclable materials, which further reduces our impact on the environment.

what if...

... technology and environment
could go hand in hand

We keep our production process within the European Union because we passionately believe this helps us promote sustainability and ensure better quality control. Toxic materials and industrial waste are an environmental burden to future generations, so we eliminate the use of toxins and handle waste responsibly.

We carefully select suppliers to provide the components and materials we use in production, and all our materials are pre-certified and rigorously tested. By only using top quality components and materials, you benefit from durable products that last longer.

We perform quality checks at every step of the production process in order to ensure the flawless performance and highest energy yield throughout the PV module's lifetime. We operate in accordance with international standards ISO 9001 (Quality management systems), ISO 14001 (Environmental management systems) and OHSAS 18001 (Occupational health and safety management systems).

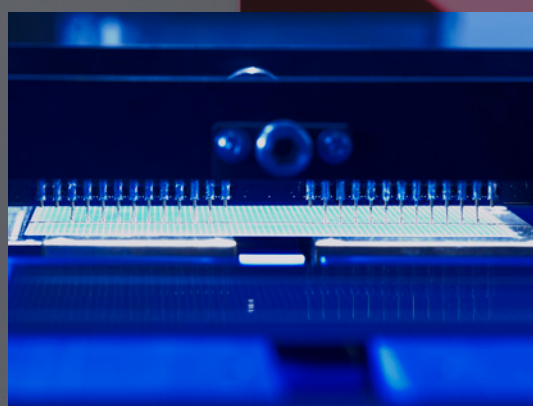
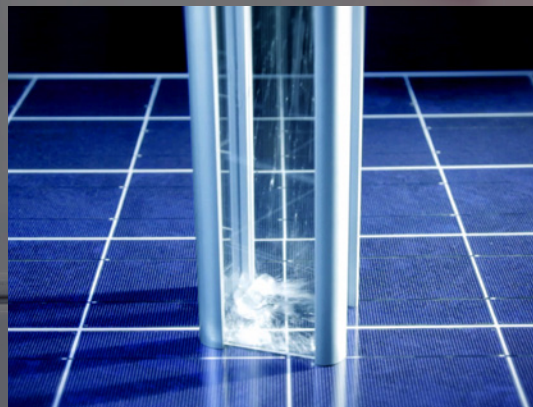
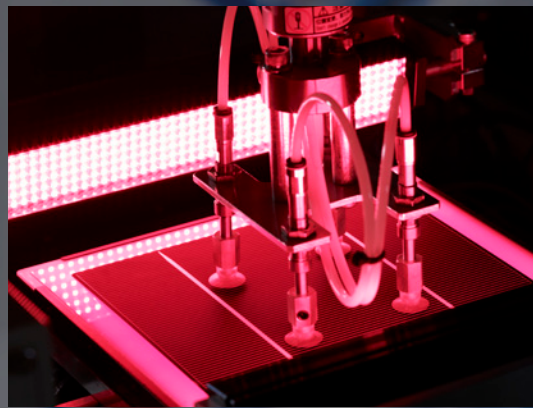

what if...

... a PV module
could do so much more?

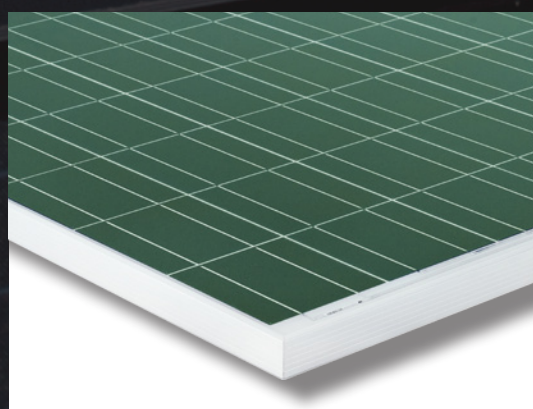
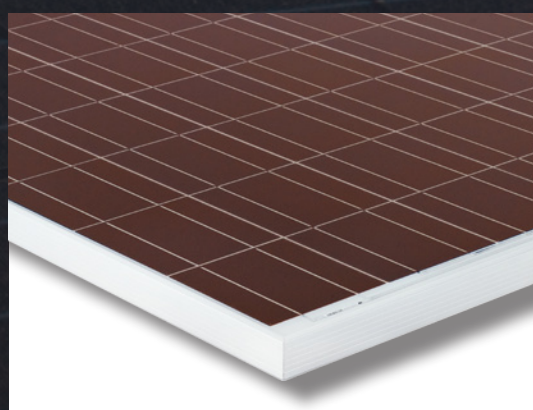
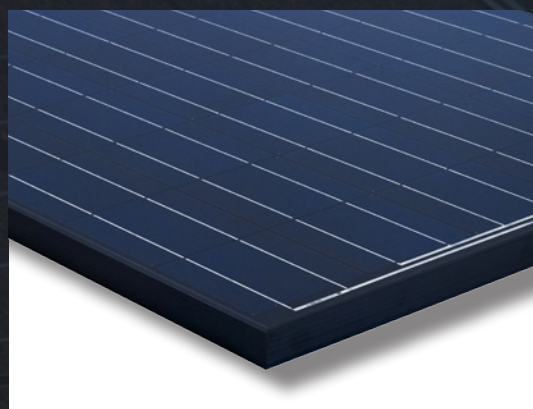
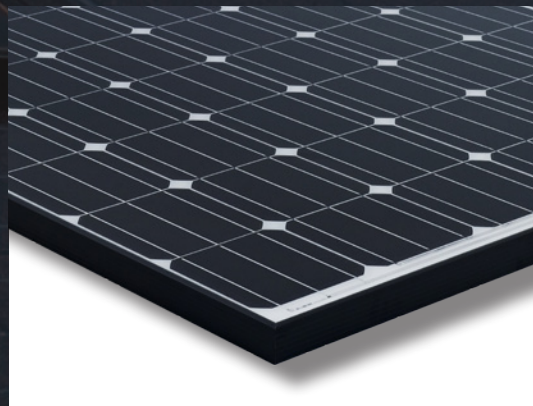
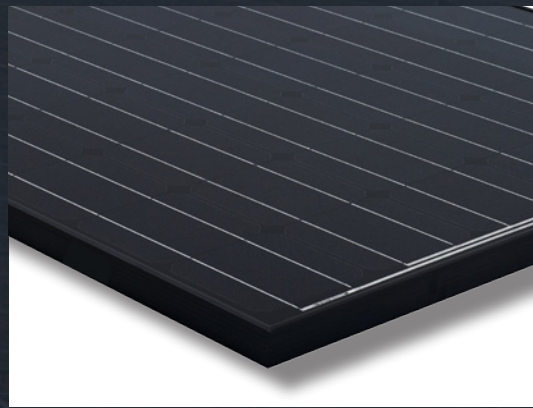

Our in-house research and development team works closely with world-renowned research centres to introduce innovative technology and powerful products.

BISOL crystalline photovoltaic modules are recognised globally for their premium quality, excellent performance and aesthetic design. The high-power modules come with an extended 10-year product warranty, a 25-year warranty on power output and strictly positive power output tolerances. Several independent laboratory tests proved that the modules have extremely low degradation rates, are very robust and have an especially long lifespan. According to the independent PHOTON module yield test and real-life PV plant monitoring, BISOL PV modules are one of the world's best-performing products. They are manufactured from highest quality materials, they last longer and therefore increase your lifetime energy yield. This increases the profitability of your investment.

We combine performance with an elegant design which integrates perfectly into the aesthetics of your home. BISOL full-black modules and building integrated solutions are notable for the way they combine form and function. Our new Spectrum series of PV modules with coloured cells were particularly designed for installations where colour conformity to the building design is of paramount importance.

what if...

... one brand
met all your solar needs?

We have all you need to produce solar energy: from premium quality PV modules, industry-leading mounting systems, project design support, to PV plant performance monitoring and finance for large-scale PV plants. We provide a comprehensive range of products and services, therefore you only need one company for all your solar requirements.

We design our own complete industry-leading mounting solutions suitable for any type of roof or ground-mounted PV installation. BISOL EasyMount mounting solutions can be easily installed and provide long-term performance, which saves you time and increases the profitability of your investment. We offer a wide range of HDPE and triangular structures, aluminium profiles, hooks, brackets and other accessories. BISOL mounting systems come with up to 15 years warranty and present a reliable solution suited for various wind zones and applications.

For a complete insight into the PV plant's performance we offer a 3 in 1 monitoring device, which combines the data logger, 3G modem and a router. Its functional design enables collecting data from different inverter brands and allows monitoring, analysing and downloading all the essential PV plant's performance information via the BISOL web portal. BISOL PV monitoring device is an efficient, easy-to-use and affordable plug & play solution, unlike any other in the market.

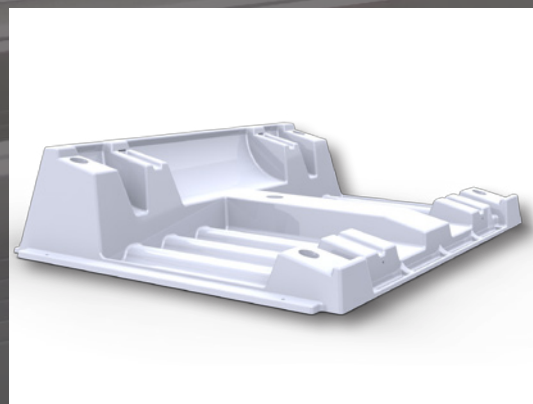
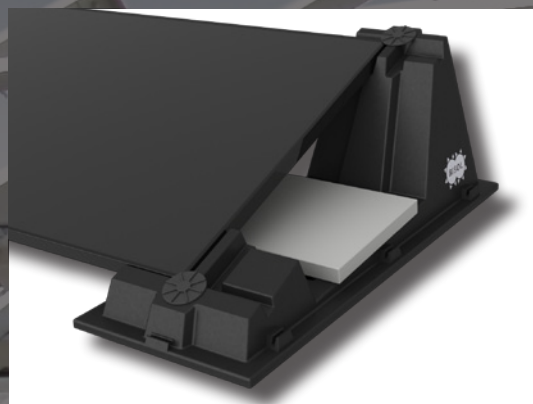
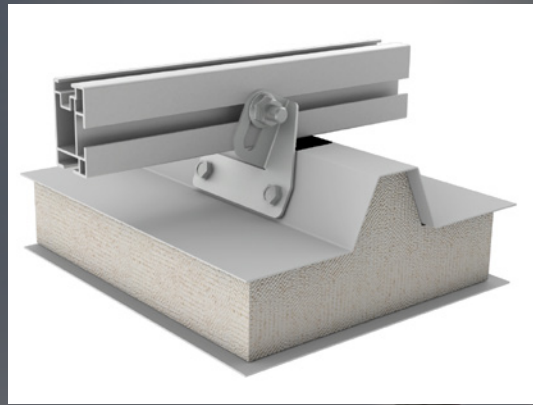
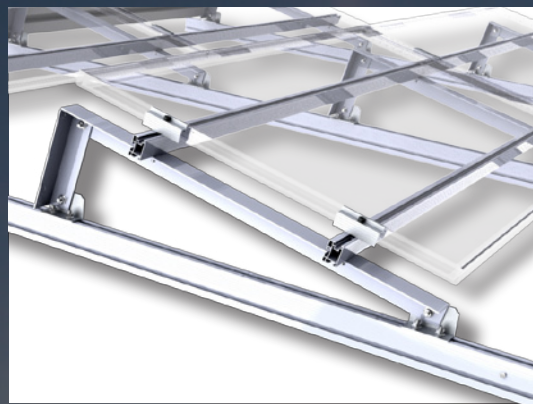

what if...

... you always came first?

Keeping our customer satisfied is the driving force behind our business. That is why our team develops green energy solutions tailored to your specific needs. From our offices throughout Europe, we provide fast and reliable support.

Quality is more than just a word.

BISOL uses the best materials to give you cutting-edge products, ensuring you always get the most from your green energy investment. Additionally, our highly trained aftersales support team are always on hand to offer you an unsurpassed service.



BISOL Group

Latkova vas 59a
3312 Prebold
SLOVENIA

T: +386 (0)3 703 22 50
F: +386 (0) 3 703 22 63
E: info@bisol.si

BISOL Benelux

Wingepark 47
3110 Rotselaar
BELGIUM

T: +32 (0)484 08 80 78
E: info@bisol.be

BISOL France

SSavoie-Technolac
17, avenue du Lac Léman
73372 Le Bourget du Lac Cedex
FRANCE

T: +33 (0)4 79 44 85 91
F: +33 (0)4 79 44 85 91
E: info@bisol.fr

BISOL Italy

Via Bonazzi, 5
40013 Castel Maggiore (BO)
ITALY

T: +39 051 705 697
F: +39 051 705 697
E: italia@bisol.com

BISOL UK

Capital Business Centre
Unit 11J, 22 Carlton Road
South Croydon, CR2 0BS
UNITED KINGDOM

T: +44 (0)208 916 2404
F: +44 (0)208 916 2001
E: info@bisol.co.uk