



Solis S5 Three Phase Inverter

S5-GR3P(3-13)K **Installation and Operation Manual**

Ver 1.1

Ginlong Technologies Co., Ltd.
No. 57 Jintong Road, Binhai Industrial Park, Xiangshan, Ningbo,
Zhejiang, 315712, P.R.China.
Tel: +86 (0)574 6578 1806
Fax: +86 (0)574 6578 1606
Email: info@ginlong.com
Web: www.ginlong.com

Please adhere to the actual products in case of any discrepancies in this user manual.

If you encounter any problem on the inverter, please find out the inverter S/N and contact us, we will try to respond to your question ASAP.



Ginlong Technologies Co., Ltd.

Contents

1. Introduction	2
1.1 Product Description	2
1.2 Packaging	3
2. Safety Instructions	4
2.1 Safety Symbols	4
2.2 General Safety Instructions	4
2.3 Notice For Use	5
2.4 Notice for Disposal	5
3. Overview	6
3.1 Front Panel Display	6
3.2 LED Status Indicator Lights	6
3.3 Keypad	6
3.4 LCD	6
4. Product handling and storage	7
4.1 Product handling	7
4.2 Product Storage	8
5. Installation	9
5.1 Select Location for the Inverter	9
5.2 Mounting the Inverter	11
5.3 Electrical Connections	13
6. Start & Stop	25
6.1 Start the Inverter	25
6.2 Stop the Inverter	25
7. Operation	26
7.1 Main Menu	26
7.2 Information	26
7.3 Settings	28
7.4 Advanced Info.	28
7.5 Advanced Settings	32
7.6 AFCI function	41
8. Maintenance	43
9. Troubleshooting	44
10. Specifications	46
11. Appendix	59

1. Introduction

1.1 Product Description

Solis S5 three phase inverters integrate DRM and backflow power control function, that could suitable for smart grid requirement.

This manual covers the three phase inverter model listed below:

S5-GR3P3K, S5-GR3P4K, S5-GR3P5K, S5-GR3P6K, S5-GR3P8K, S5-GR3P9K, S5-GR3P10K, S5-GR3P12K, S5-GR3P13K, S5-GR3P5K-LV, S5-GR3P6K-LV

The following two models are specially supplied for Belgium market:

S5-GR3P8K-BE, S5-GR3P10K-BE

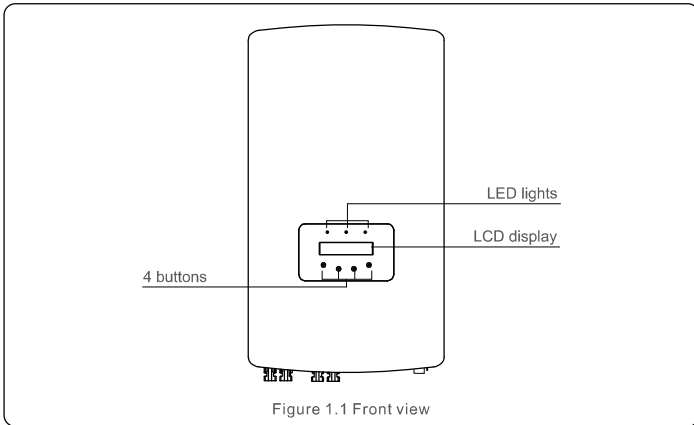

Figure 1.1 Front view

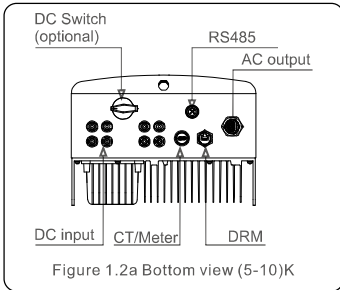

Figure 1.2a Bottom view (5-10)K

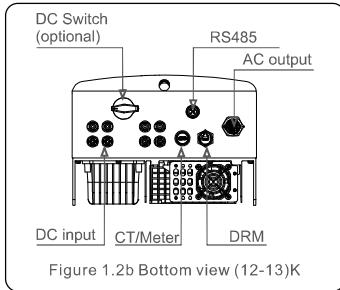
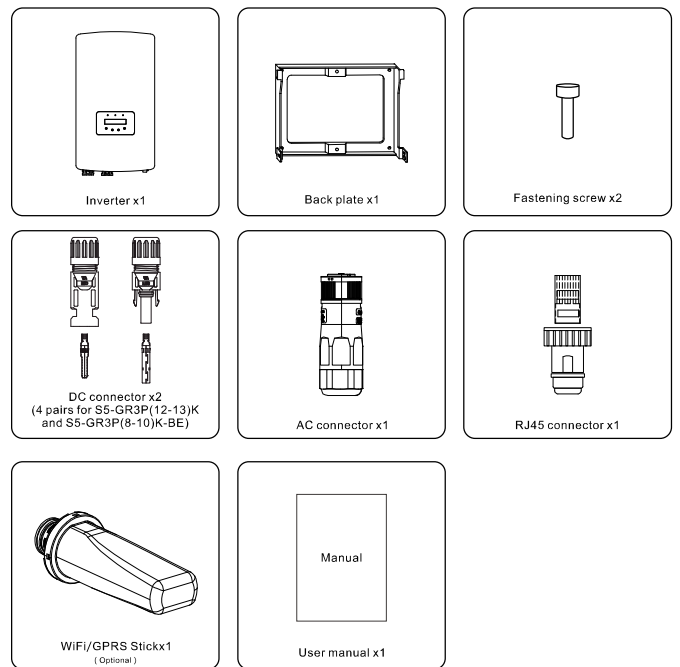

Figure 1.2b Bottom view (12-13)K

1. Introduction

1.2 Packaging

When you receive the inverter, please ensure that all the parts listed below are included:



If anything is missing, please contact your local Solis distributor.

2. Safety Instructions

2.1 Safety Symbols

Safety symbols used in this manual, which highlight potential safety risks and important safety information, are listed as follows:



WARNING:

WARNING symbol indicates important safety instructions, which if not correctly followed, could result in serious injury or death.



NOTE:

NOTE symbol indicates important safety instructions, which if not correctly followed, could result in some damage or the destruction of the inverter.



CAUTION:

CAUTION, RISK OF ELECTRIC SHOCK symbol indicates important safety instructions, which if not correctly followed, could result in electric shock.



CAUTION:

CAUTION, HOT SURFACE symbol indicates safety instructions, which if not correctly followed, could result in burns.

2.2 General Safety Instructions



WARNING:

Please don't connect PV array positive(+) or negative(-) to ground, it could cause serious damage to the inverter.



WARNING:

Electrical installations must be done in accordance with the local and national electrical safety standards.



WARNING:

To reduce the risk of fire, over-current protective devices (OCPD) are required for circuits connected to the Inverter.

The DC OCPD shall be installed per local requirements. All photovoltaic source and output circuit conductors shall have disconnects that comply with the NEC Article 690, Part II. All Solis three phase inverters feature an integrated DC switch.



CAUTION:

Risk of electric shock. Do not remove cover. There is no user serviceable parts inside. Refer servicing to qualified and accredited service technicians.

2. Safety Instructions



CAUTION:

The PV array (Solar panels) supplies a DC voltage when they are exposed to sunlight.



CAUTION:

Risk of electric shock from energy stored in capacitors of the Inverter. Do not remove cover for 5 minutes after disconnecting all power sources (service technician only). Warranty may be voided if the cover is removed without unauthorized.



CAUTION:

The surface temperature of the inverter can exceed 75°C (167F). To avoid risk of burns, DO NOT touch the surface when inverter is operating. The inverter must be installed out of reach of children.

2.3 Notice For Use

The inverter has been constructed according to the applicable safety and technical guidelines. Use the inverter in installations that meet the following specifications only:

- Permanent installation is required.
- The electrical installation must meet all the applicable regulations and standards.
- The inverter must be installed according to the instructions stated in this manual.
- The inverter must be installed according to the correct technical specifications.
- To startup the inverter, the Grid Supply Main Switch (AC) must be switched on, before the solar panel's DC isolator shall be switched on. To stop the inverter, the Grid Supply Main Switch (AC) must be switched off before the solar panel's DC isolator shall be switched off.

2.4 Notice for Disposal

This product shall not be disposed of with household waste. They should be segregated and brought to an appropriate collection point to enable recycling and avoid potential impacts on the environment and human health. Local rules in waste management shall be respected .



3. Overview

3.1 Front Panel Display

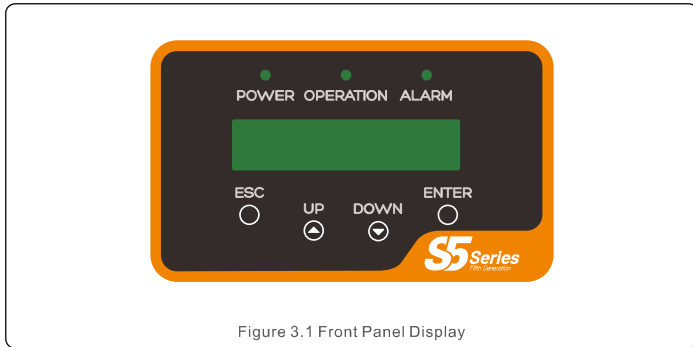

Figure 3.1 Front Panel Display

3.2 LED Status Indicator Lights

	Light	Status	Description
①	● POWER	ON	The inverter can detect DC power.
		OFF	No DC power or low DC power.
②	● OPERATION	ON	The inverter is operating properly.
		OFF	The inverter has stopped to supply power.
		FLASHING	The inverter is initializing.
③	● ALARM	ON	Alarm or fault condition is detected.
		OFF	The inverter is operating without fault or alarm.

Table 3.1 Status Indicator Lights

3.3 Keypad

There are four keys in the front panel of the Inverter(from left to right): ESC, UP, DOWN and ENTER keys. The keypad is used for:

- Scrolling through the displayed options (the UP and DOWN keys);
- Access to modify the adjustable settings (the ESC and ENTER keys).

3.4 LCD

The two-line Liquid Crystal Display (LCD) is located on the front panel of the Inverter, which shows the following information:

- Inverter operation status and data;
- Alarm messages and fault indications.
- Service messages for operator;

.6.

4. Product handing and storage

4.1 Product handling

Please review the instruction below for handling the inverter:

1 The red circles below denote cutouts on the product package.

Push in the cutouts to form handles for moving the inverter (see Figure 4.1).

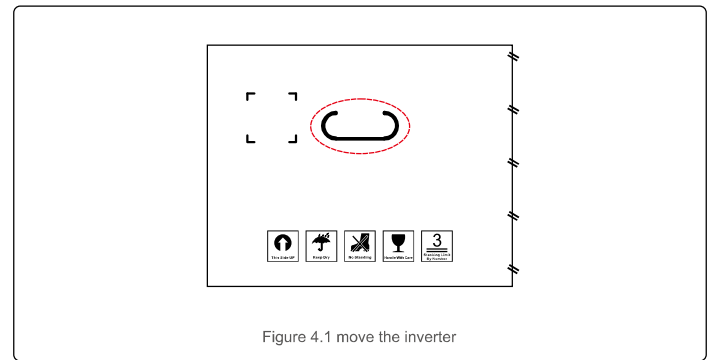

Figure 4.1 move the inverter

2. Open the carton, then handle both sides of inverter through the area denoted dotted line. (see figure 4.2).

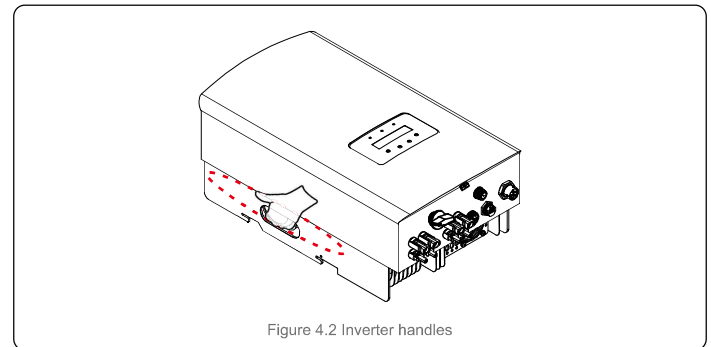

Figure 4.2 Inverter handles

.7.

4. Product handing and storage

4.2 Product Storage

If the inverter is not to be installed immediately, storage instructions and environmental conditions are below:

- Use the original box to repackage the inverter, seal with adhesive tape with the desiccant inside the box.
- Store the inverter(s) in a clean and dry place, free of dust and dirt.
- Storage temperature must be between -40°C and 70°C and the humidity should be between 0 and 95% non-condensing.
- Stack no more than three (3) inverters high.
- Keep box(es) away from corrosive materials to avoid damage to the inverter enclosure.
- Inspect packaging regularly. If packaging is damaged(wet, pest damage, etc), repackage the inverter immediately.
- Store the inverter(s) on a flat, hard surface - not inclined or upside down.
- After long-term storage, the inverter needs to be fully examined and tested by qualified service or technical personnel before using.
- Restarting after a long period of non-use requires the equipment to be inspected and, in some cases, the removal of oxidation and dust that has settled inside the equipment will be required.

5. Installation

5.1 Select a Location for the Inverter

To select a location for the inverter, the following criteria should be considered:



WARNING: Risk of fire

Despite careful construction, electrical devices can cause fires.

- Do not install the inverter in areas containing highly flammable materials or gases.
- Do not install the inverter in potentially explosive atmospheres.

- Do not install in small closed spaces where air can not circulate freely. To avoid overheating, always make sure the flow of air around the inverter is not blocked.
- Exposure to direct sunlight will increase the operational temperature of the inverter and may cause output power limiting. Ginlong recommends inverter installed to avoid direct sunlight or raining.
- To avoid over heating ambient air temperature must be considered when choosing the inverter installation location. Ginlong recommends using a sun shade minimizing direct sunlight when the ambient air temperature around the unit exceeds 104°F/40°C.

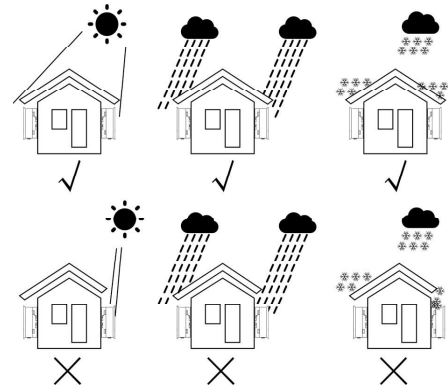

Figure 5.1 Recommended Installation locations



NOTE:

Nothing should be stored on or placed against the inverter.

5. Installation

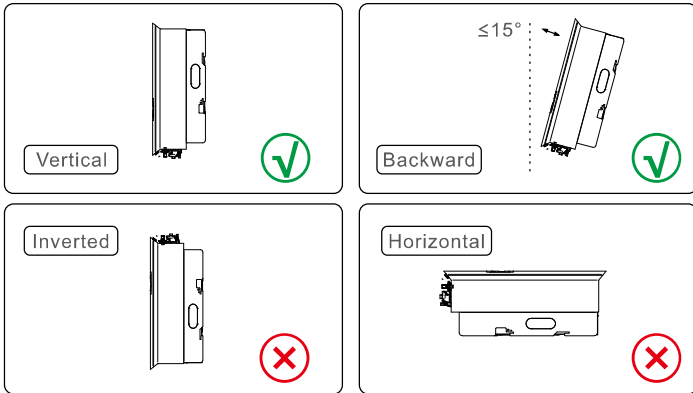

- The visibility of LED status indicator lights and LCD should be considered.
- Install vertically (+/- 5°) or tilted backward ($\leq 15^\circ$).
- Don't mount inverter on the tilted forward wall.
- Don't mount inverter on the horizontal.

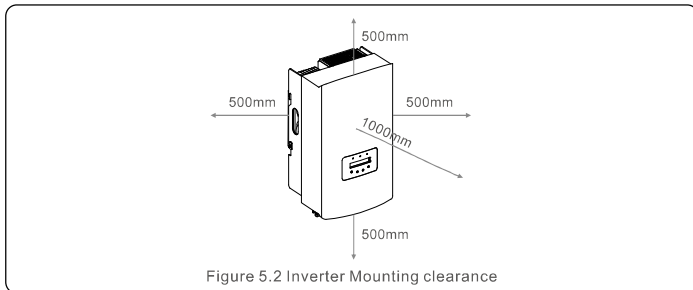

Figure 5.2 Inverter Mounting clearance

- Temperature of inverter heat sinker might 167°F/75°C.
- Inverter is designed for working extreme environment, operation temperature range: -15°F/25°C~149°F/65°C.
- When 1 or more inverters are installed in one location, a minimum 500mm clearance should be kept between each inverter or other object. The bottom of the inverter should be 500mm clearance to the ground.

.10.

5. Installation

5.2 Mounting the Inverter

Dimensions of mounting bracket:

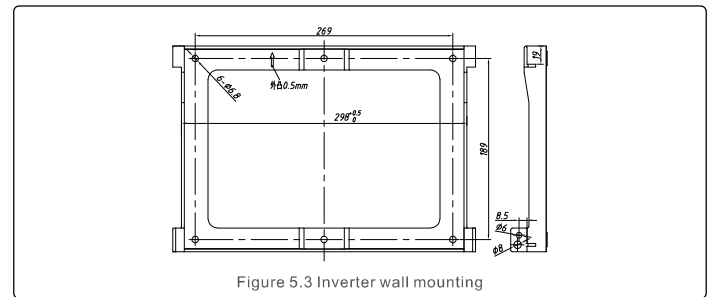

Figure 5.3 Inverter wall mounting

Refer to figure 5.4 and figure 5.5. Inverter shall be mounted vertically. The steps to mount the inverter are listed below.

1. Refer to Figure 5.4, the holes for expansion bolt based on the hole diameter of bracket (ST6.3*60 cross recessed hexagon head tapping screws, HJ0108 10*50mm fished expandable tubular), using the percussion drilling with the 10mm drill need to stay vertically on the wall. And the drill hole must be vertically on the wall. And all drill holes' depth is 60mm.

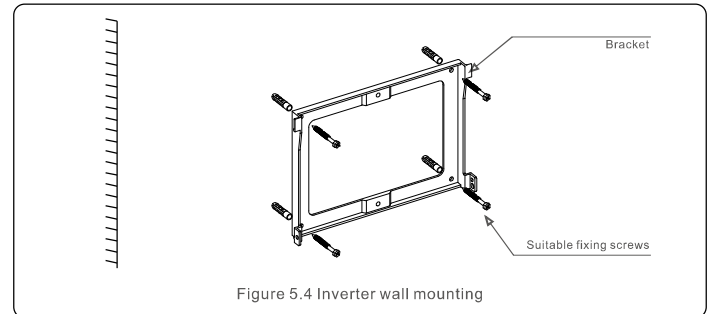

Figure 5.4 Inverter wall mounting

2. Make sure the bracket is horizontal. And the mounting holes (in Figure 5.4) are marked correctly. Drill the holes into wall at your marks.
3. Use the suitable expansion screws to fix the bracket on the wall.

.11.

5. Installation



WARNING:

The inverter must be mounted vertically.

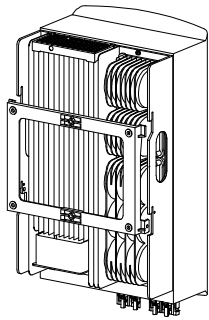

Figure 5.5 Install the inverter

4. Lift the inverter and hang it on the bracket, and fixing both sides of inverter with locking screws (accessories).

Locking screws

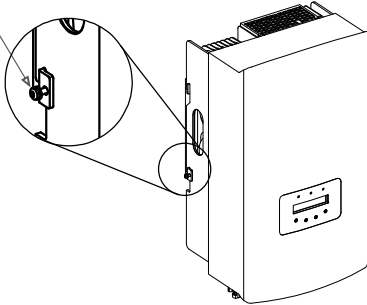

Figure 5.6 Fixed the inverter

.12.

5. Installation

5. Anti-theft lock mount(optional)

Anti-theft lock (User-supplied) function is that inverter is fixed in bracket in case theft. The lock is selected by 5mm(the keyhole diameter), and the lock of stainless steel is preferred.

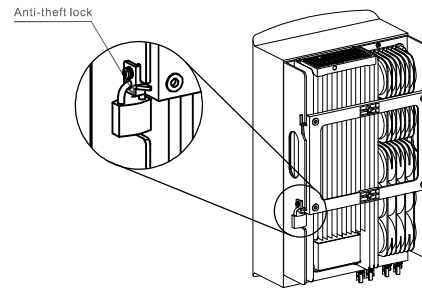

Figure 5.7 Install security lock

5.3 Electrical Connections

Inverter designs quick-connect terminal, so top cover needn't open during electrical connection. The sign meaning located the bottom of inverter, as shown below in table 5.1. All electrical connections are suit for the local or national standard.

+	Positive DC input terminal
-	Negative DC input terminal
DC 1	DC input terminal
DC 2	DC input terminal
DC SWITCH	Switch of DC input terminals
COM	RJ45 and terminal block for RS485 communication port
GRID	Connecting terminal of the Grid

Table 5.1 Electrical connection symbols

The electrical connection of the inverter must follow the steps listed below:

1. Switch the Grid Supply Main Switch (AC) OFF.
2. Switch the DC Isolator OFF.
3. Assemble PV input connector to the Inverter.

.13.

5. Installation

5.3.1 Grounding

To effectively protect the inverter, two grounding methods must be performed.
Connect the AC grounding cable (Please refer to section 5.3.3).
Connect the external grounding terminal.

To connect the grounding terminal on the heat sink, please follow the steps below:

- 1) Prepare the grounding cable: recommend to use the $\geq 6\text{mm}^2$ outdoor copper-core cable.
- 2) Prepare OT terminals: M6.

Important:
 For multiple inverters in parallel, all inverters should be connected to the same ground point to eliminate the possibility of a voltage potential existing between inverter grounds.

- 3) Strip the ground cable insulation to a suitable length (see Figure 5.8).

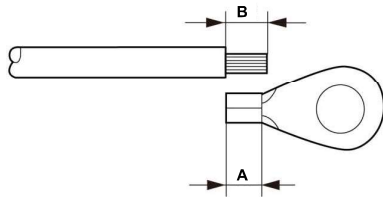



Figure 5.8 suitable length

Important:
 B (insulation stripping length) is 2mm~3mm longer than A (OT cable terminal crimping area) 2mm~3mm.

- 4) Insert the stripped wire into the OT terminal crimping area and use the hydraulic clamp to crimp the terminal to the wire (see Figure 5.9).

5. Installation

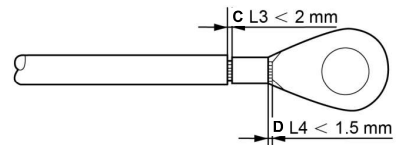



Figure 5.9 strip wire

Important:
 After crimping the terminal to the wire, inspect the connection to ensure the terminal is solidly crimped to the wire.

- 5) Remove the screw from the heat sink ground point.
- 6) Connect the grounding cable to the grounding point on the heat sink, and tighten the grounding screw, Torque is 3Nm (see figure 5.10).

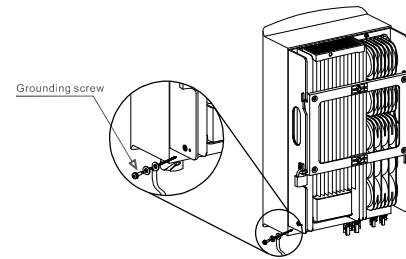





Figure 5.10 Fixed cable

Important:
 For improving anti-corrosion performance, after ground cable installed, apply silicone or paint is preferred to protect.

5. Installation

5.3.2 Connect PV side of inverter

 Before connecting inverter, please make sure the PV array open circuit voltage is within the limit of the inverter.

 Before connection, please make sure the polarity of the output voltage of PV array matches the “DC+” and “DC-” symbols.

 Before connecting inverter, please make sure the PV array open circuit voltage is within the limit of the inverter.

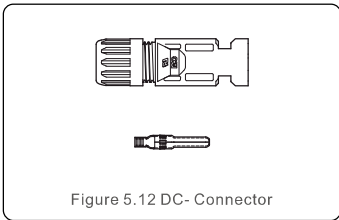
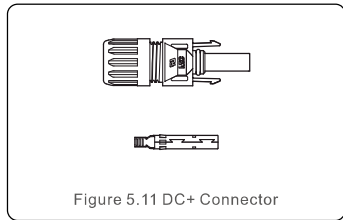

 Please use approved DC cable for PV system.

Cable type	Cross section (mm ²)	
	Range	Recommended value
Industry generic PV cable (model: PV1-F)	4.0~6.0 (12~10AWG)	4.0 (12AWG)

The steps to assemble the DC connectors are listed as follows:

1. Strip off the DC wire for about 7mm, Disassemble the connector cap nut. (see Figure 5.13)
2. Insert the wire into the connector cap nut and contact pin. (see Figure 5.14)
3. Crimp the contact pin to the wire using a proper wire crimper. (see Figure 5.15)
4. Insert metal connector into top of connector, and tighten nut with torque 2.5-3 Nm (see figure 5.16).

5. Installation

5. Measure PV voltage of DC input with multimeter, verify DC input cable polar (see figure 5.17), and ensure each string of PV voltage in range of inverter operation. Connect DC connector with inverter until hearing a slight clicking sound indicates connection succeed. (see figure 5.18)

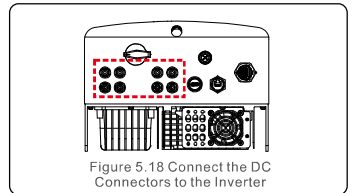
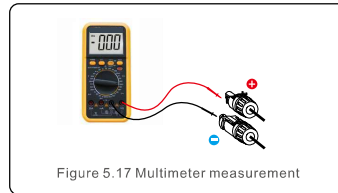
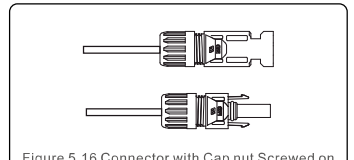
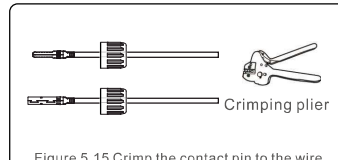
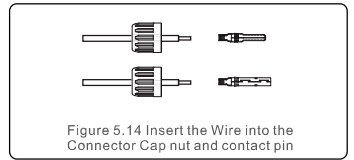
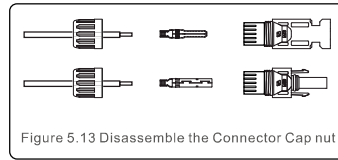

 **Caution:** If DC inputs are accidentally reversely connected or inverter is faulty or not working properly, it is NOT allowed to turn off the DC switch as it will damage the inverter and even leads to a fire disaster.

The correct actions are:

- *Use a clip-on ammeter to measure the DC string current.
- *If it is above 0.5A, please wait for the solar irradiance reduces until the current decreases to below 0.5A.
- *Only after the current is below 0.5A, you are allowed to turn off the DC switches and disconnect the PV strings.

Please note that any damages due to wrong operations are not covered in the device warranty.

5. Installation

5.3.3 Connect grid side of inverter

For all AC connectors, YJV-0.6/1kV cables with 6mm² diameter are required to be used. Please make sure the resistance of AC cable is lower than 1.5 ohm.



Internal of AC connector signs "L1", "L2", "L3", "N" and "PE" five connection ports (see Figure 5.21). Three phase lines shall be connected to the "L1", "L2" and "L3" terminals respectively, Earth wire shall be connected to "PE" and Neutral wires shall be connected to "N" terminal.

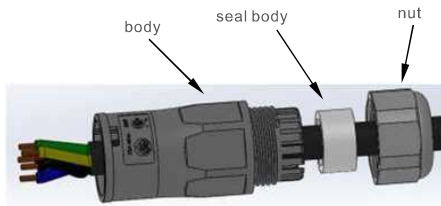

Figure 5.19 AC connector

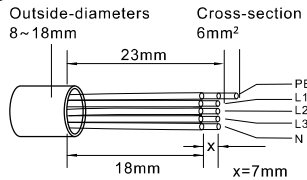

Figure 5.20 Stripped and bared wire

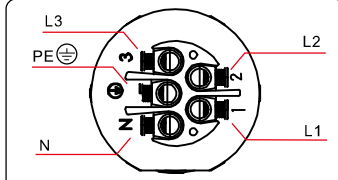

Figure 5.21 Internal structure of AC connector

5. Installation

The steps of AC grid terminal connector for installation are as follows:

- A) Fix the wires into the correct position and the torque is 0.8N.m
Please try to pull out the wire slightly to make sure that the wires are well connected.

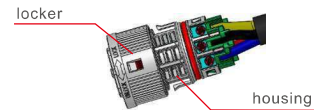

Figure 5.22 Connect Wires to the Terminal

- B) Insert the seal and clamp finger into body, then tighten the nut and the torque is 2.5N.m.



Figure 5.23 Tighten up the Cap on the Terminal

- C) Connect the AC grid connector to the inverter, until hearing a slight click sound that indicates the connection succeed.

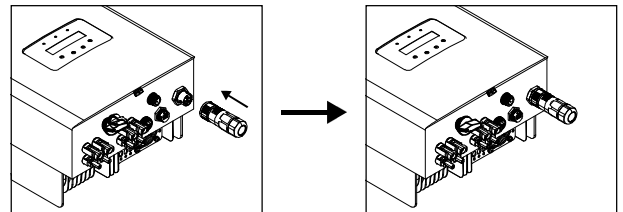

Figure 5.24 Connect AC connector to inverter

5. Installation

5.3.4 Max. over current protection device (OCPD)

To protect the inverter's AC grid connection conductors, Solis recommends installing breakers that will protect against overcurrent.

The following table defines OCPD ratings for the Solis three phase inverters.

Inverter	Rated voltage(V)	Rated output current (A)	Current for protection device (A)
S5-GR3P3K	220/380,230/400	4.6/4.3	20
S5-GR3P4K	220/380,230/400	6.1/5.8	20
S5-GR3P5K	220/380,230/400	7.6/7.2	20
S5-GR3P6K	220/380,230/400	9.1/8.7	20
S5-GR3P8K	220/380,230/400	12.2/11.5	20
S5-GR3P9K	220/380,230/400	13.7/13.0	32
S5-GR3P10K	220/380,230/400	15.2/14.4	32
S5-GR3P12K	220/380,230/400	18.2/17.3	32
S5-GR3P13K	220/380,230/400	19.8/18.8	32
S5-GR3P5K-LV	208/220/240	13.1	32
S5-GR3P6K-LV	208/220/240	15.7	32
S5-GR3P8K-BE	230/400	11.5	20
S5-GR3P10K-BE	230/400	14.4	32

Table 5.2 Rating of grid OCPD

5.3.5 Inverter monitoring connection

The inverter can be monitored via Wi-Fi or GPRS. All Solis communication devices are optional (Figure 5.25). For connection instructions, please refer to the Solis Monitoring Device installation manuals.

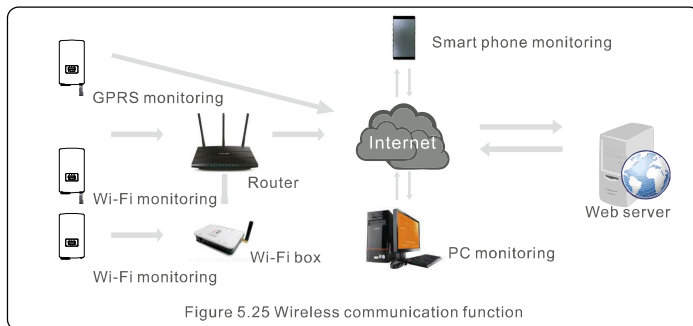

.20.

5. Installation

5.3.6 Meter Connection(optional)

The inverter can work with a three phase smart meter to achieve Export Power Management function and/or 24hour consumption monitoring function.

NOTE

To achieve Export Power Management function, the smart meter can be installed on either grid side or load side.

To achieve 24hour consumption monitoring function, the smart meter can only be installed on grid side.

Two types of meters are supported:

Direct Insert Type Meter - Max input current 80A(DTSD1352-Direct Insert Type).

External CT Type Meter - 150A/5A CTs are supplied(DTSD1352-External CT Type).

Customer can place the order for a suitable meter from Solis Sales Reps.

Below are the connection diagrams of different meters connecting to different locations.

Detailed settings please refer to Section 7.5.12

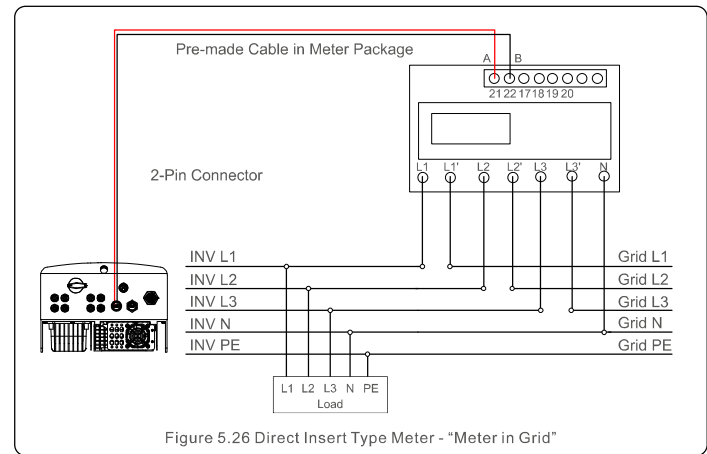

.21.

5. Installation

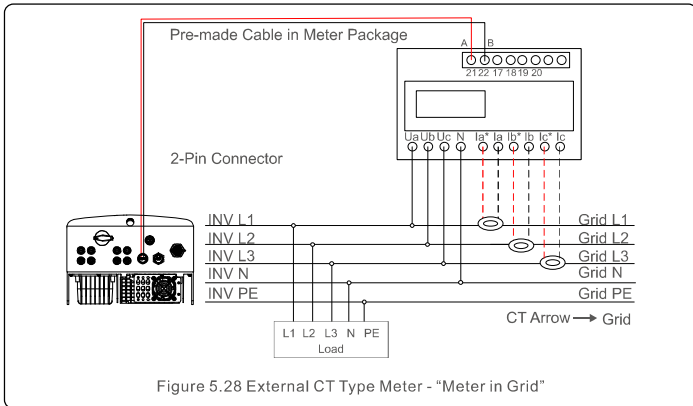
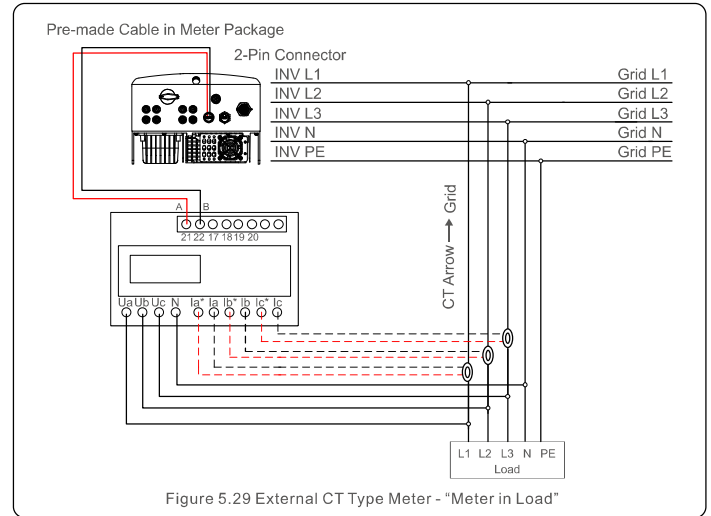
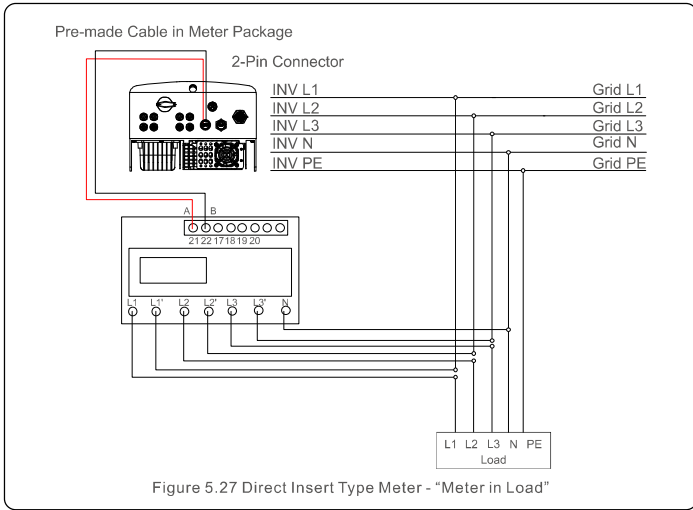

5. Installation

5. Installation

5.3.7 Logic interface connection

Logic interface is required by some local regulations that can be operated by a simple switch or contactor (Not available in South Africa).

When the switch is closed the inverter can operate normally. When the switch is opened, the inverter will reduce its output power to zero within 5s.

Pin5 and Pin6 of RJ45 terminal is used for the logic interface connection.

Please follow below steps to assemble RJ45 connector.

1. Insert the network cable into the communication connection terminal of RJ45.

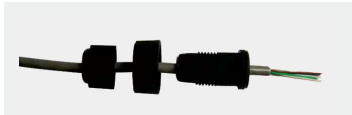

Figure 5.30 RJ45 communication connection terminals

2. Use the network wire stripper to strip the insulation layer of the communication cable.

According to the standard line sequence of figure 5.31 connect the wire to the plug of RJ45, and then use a network cable crimping tool to make it tight.

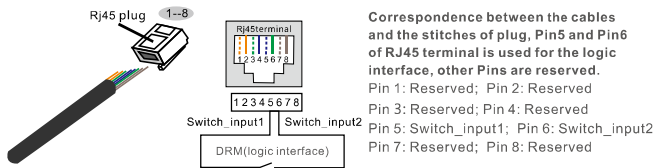

Figure 5.31 Strip the insulation layer and connect to RJ45 plug

3. Connect RJ45 to DRM (logic interface).

After wire connection, please refer chapter 7.5.9.1 to enable the logic interface function.

6. Start & Stop

6.1 Start the Inverter

To start up the Inverter, it is important that the following steps are strictly followed:

1. Switch the grid supply main Switch (AC) ON first.
2. Switch the DC switch ON. If the voltage of PV arrays are higher than start up voltage, the inverter will turn on. The red LED power will light.
3. When both the DC and the AC sides supply to the inverter, it will be ready to generate power. Initially, the inverter will check both its internal parameters and the parameters of the AC grid, to ensure that they are within the acceptable limits. At the same time, the green LED will flash and the LCD displays the information of INITIALIZING.
4. After 30-300 seconds (depending on local requirement), the inverter will start to generate power. The green LED will be on continually and the LCD displays GENERATING.



WARNING:

Do not touch the surface when the inverter is operating. It may be hot and cause burns.

6.2 Stop the Inverter

To stop the inverter, it is mandatory that the steps below are followed in the exact order outlined.

- 1). Select "Grid Off" in the Advanced Setting of Inverter LCD.
- 2). Turn off the AC Switch between Solis inverter and Grid.
- 3). Wait approximately 30 seconds (during this time, the AC side capacitors are dissipating energy). If the inverter has DC voltage above the start-up threshold, the red POWER LED will be lit. Switch the DC switch OFF.
- 4). Confirm all LED's switch OFF (~one (1) minute).



CAUTION

Although the inverter DC disconnect switch is in the OFF position and all the LED's are OFF, operators must wait five (5) minutes after the DC power source has been disconnected before opening the inverter cabinet. DC side capacitors can take up to five (5) minutes to dissipate all stored energy.

7. Operation

In normal operation, LCD screen alternatively shows inverter power and operation status (see Figure 7.1). The screen can be scrolled manually by pressing the UP/DOWN keys. Pressing the ENTER key gives access to Main Menu.

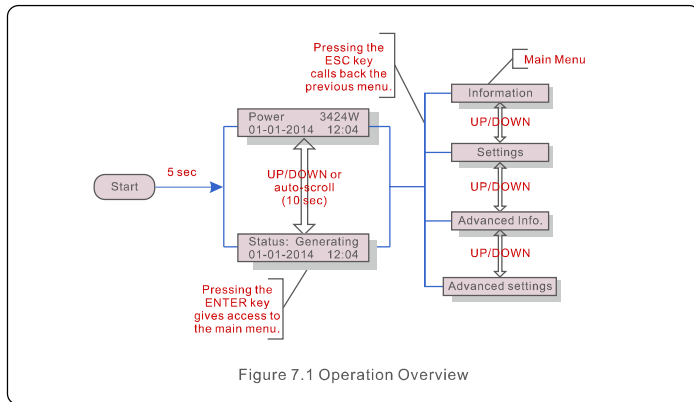

7.1 Main Menu

There are four submenus in the Main Menu (see Figure 7.1):

1. Information
2. Settings
3. Advanced Info.
4. Advanced Settings

7.2 Information

The Solis three Phase S5 Inverter main menu provides access to operational data and information. The information is displayed by selecting "Information" from the menu and then by scrolling up or down.

7. Operation

Display	Duration	Description
V_DC1 350.8V I_DC1 5.1A	10 sec	V_DC1: Shows input 01 voltage value. I_DC1: Shows input 01 current value.
V_DC2 350.8V I_DC2 5.1A	10 sec	V_DC2: Shows input 02 voltage value. I_DC2: Shows input 02 current value.
V_A 230.4V I_A 8.1A	10 sec	V_A: Shows the grid's voltage value. I_A: Shows the grid's current value.
V_C 230.4V I_C 8.1A	10 sec	V_C: Shows the grid's voltage value. I_C: Shows the grid's current value.
Status: Generating Power: 1488W	10 sec	Status: Shows instant status of the Inverter. Power: Shows instant output power value.
Grid Frequency F_Grid 50.06Hz	10 sec	F_Grid: Shows the grid's frequency value.
Total Energy 0258458 kwh	10 sec	Total generated energy value.
This Month: 0123kwh Last Month: 0123kwh	10 sec	This Month: Total energy generated this month. Last Month: Total energy generated last month.
Today: 15.1kwh Yesterday: 13.5kwh	10 sec	Today: Total energy generated today. Yesterday: Total energy generated yesterday.
Inverter SN 00000000000000	10 sec	Display series number of the inverter.

Table 7.1 Information list

7.2.1 Lock screen

Pressing the ESC key returns to the Main Menu. Pressing the ENTER key locks (Figure 7.2(a)) or unlocks (Figure 7.2 (b)) the screen.

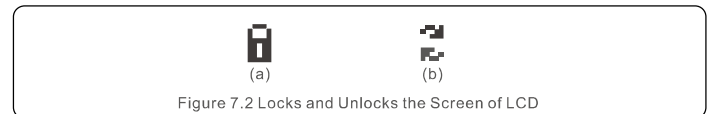

7. Operation

7.3 Settings

The following submenus are displayed when the Settings menu is selected:

- 1.Set Time
- 2.Set Address

7.3.1 Set Time

This function allows time and date setting. When this function is selected, the LCD will display a screen as shown in Figure 7.3.

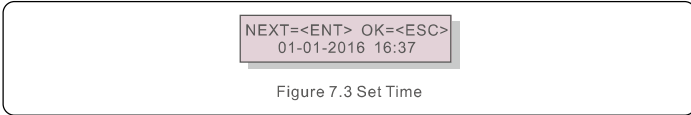

Figure 7.3 Set Time

Press the UP/DOWN keys to set time and data. Press the ENTER key to move from one digit to the next (from left to right). Press the ESC key to save the settings and return to the previous menu.

7.3.2 Set Address

This function is used to set the address when muti inverters are connected to three monitor. The address number can be assigned from "01"to "99"(see Figure 7.4). The default address number of Solis Three Phase Inverter is "01".

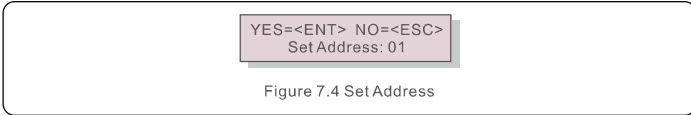



Figure 7.4 Set Address

Press the UP/DOWN keys to set the address. Press the ENTER key to save the settings. Press the ESC key to cancel the change and return to the previous menu.

7. Operation

7.4 Advanced Info - Technicians Only

 **NOTE:**
To access to this area is for fully qualified and accredited technicians only. Enter menu "Advanced Info." and "Advanced settings" (need password).

Select "Advanced Info." from the Main Menu. The screen will require the password as below:

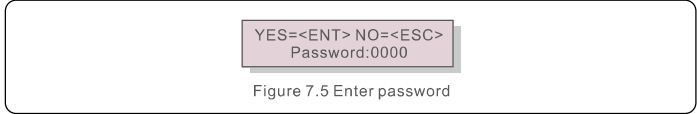

Figure 7.5 Enter password

The default password is "0010".

Please press "down" to move the cursor, press "up" to select the number.

After enter the correct password the Main Menu will display a screen and be able to access to the following information.

- 1.Alarm Message
- 2. Running message
- 3.Version
- 4. Daily Energy
- 5. Monthly Energy
- 6. Yearly Energy
- 7. Daily Records
- 8.Communication Data
- 9. Warning Message

The screen can be scrolled manually by pressing the UP/DOWN keys. Pressing the ENTER key gives access to a submenu. Press the ESC key to return to the Main Menu.

7.4.1 Alarm Message

The display shows the 100 latest alarm messages (see Figure 7.6). Screens can be scrolled manually by pressing the UP/ DOWN keys. Press the ESC key to return to the previous menu.

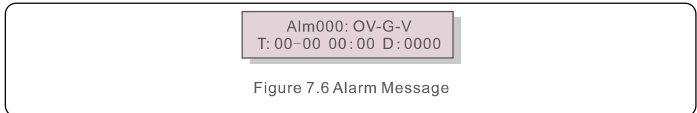

Figure 7.6 Alarm Message

7.4.2 Running Message

This function is for maintaince person to get running message such as internal temperature, Standard No. 1,2,etc.

Screens can be scrolled manually by pressing the UP/DOWN keys.

7.4.3 Version

The screen shows the model version of the inverter. And the screen will show the software ver by pressing the UP and DOWN at the same time.(see Figure 7.7).

7. Operation



Model: 08
Software Version: D20001

Figure 7.7 Model Version and Software Version

7.4.4 Daily Energy

The function is for checking the energy generation for selected day.



YES=<ENT> NO=<ESC>
Select: 2019-01-01

Figure 7.8 Select date for daily energy

Press DOWN key to move the cursor to day, month and year, press UP key to change the digit. Press Enter after the date is fixed.

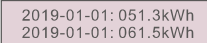

2019-01-01: 051.3kWh
2019-01-01: 061.5kWh

Figure 7.9 Daily energy

Press UP/DOWN key to move one date from another.

7.4.5 Monthly Energy

The function is for checking the energy generation for selected month.

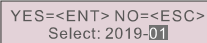

YES=<ENT> NO=<ESC>
Select: 2019-01

Figure 7.10 Select month for monthly energy

Press DOWN key to move the cursor to day and month, press UP key to change the digit. Press Enter after the date is fixed.

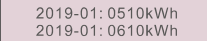

2019-01: 0510kWh
2019-01: 0610kWh

Figure 7.11 Month energy

Press UP/DOWN key to move one date from another.

.30.

7. Operation

7.4.6 Yearly Energy

The function is for checking the energy generation for selected year.



YES=<ENT> NO=<ESC>
Select: 2015

Figure 7.12 Select year for yearly energy

Press DOWN key to move the cursor to day and year, press UP key to change the digit. Press Enter after the date is fixed.

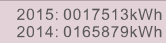

2015: 0017513kWh
2014: 0165879kWh

Figure 7.13 Yearly energy

Press UP/DOWN key to move one date from another.

7.4.7 Daily Record

The screen shows history of changing settings. Only for maintenance personnel.

7.4.8 Communication Data

The screen shows the internal data of the Inverter (see Figure 7.14), which is for service technicians only.

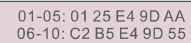

01-05: 01 25 E4 9D AA
06-10: C2 B5 E4 9D 55

Figure 7.14 Communication Data

7.4.9 Warning Message

The display shows the 100 latest warn messages (see Figure 7.15). Screens can be scrolled manually by pressing the UP/ DOWN keys. Press the ESC key to return to the previous menu.

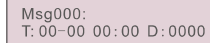

Msg000:
T: 00-00 00:00 D: 0000

Figure 7.15 Warning Message

.31.

7. Operation

7.5 Advanced Settings - Technicians Only



NOTE:

To access to this area is for fully qualified and accredited technicians only. Please follow 7.4 to enter password to access this menu.

Select Advanced Settings from the Main Menu to access the following options:

1. Select Standard
2. Grid ON/OFF
3. 24H Switch
4. Clear Energy
5. Reset Password
6. Power Control
7. Calibrate Energy
8. Special Settings
9. STD. Mode Settings
10. Restore Settings
11. HMI Update
12. Internal EPM Set
13. External EPM set
14. Restart HMI
15. Debug Parameter
16. DSP Update
17. Compensation Set

7.5.1 Selecting Standard

This function is used to select the grid's reference standard (see Figure 7.16).

YES=<ENT> NO=<ESC>
Standard:G59/3

Figure 7.16

Press the UP/DOWN keys to select the standard (G59/3, UL-480V, VDE0126, AS4777-15, AS4777-02, CQC380A, ENEL, UL-380V, MEX-CFE, C10/11 and "User-Def" function).

Press the ENTER key to confirm the setting.

Press the ESC key to cancel changes and returns to previous menu.



NOTE:

This function is for technicians use only.

Selecting the "User-Def" menu will access to the following submenu (see Figure 7.17),

— OV-G-V1: 260V
OV-G-V1-T: 1S

Figure 7.17



NOTE:

The " User-Def" function can be only used by the service engineer and must be allowed by the local energy supplier.

7. Operation

Below is the setting range for "User-Def". Using this function, the limits can be changed manually.

OV-G-V1: 220---374V	OV-G-F1: 50.1-65Hz
OV-G-V1-T: 0.01---300S	OV-G-F1-T: 0.01---300S
OV-G-V2: 220---374V	OV-G-F2: 50.1-65Hz
OV-G-V2-T: 0.01---300S	OV-G-F2-T: 0.01---300S
UN-G-V1: 110---277V	UN-G-F1: 45-59.9Hz
UN-G-V1-T: 0.01---300S	UN-G-F1-T: 0.01---300S
UN-G-V2: 110---277V	UN-G-F2: 45-59.9Hz
UN-G-V2-T: 0.01---300S	UN-G-F2-T: 0.01---300S
Startup-T: 10-600S	Restore-T: 10-600S

Table 7.2 Setting ranges for User-Def (L-N)

Press the UP/DOWN keys to scroll through items. Press the ENTER key to edit the highlighted item. Press the UP/DOWN keys again to change the setting. Press the ENTER key to save the setting. Press the ESC key to cancel changes and returns to the previous menu.



NOTE

For different countries, the grid standard needs to be set as different according to local requirements. If there is any doubt, please consult Solis service technicians for details.

7.5.2 Grid ON/OFF

This function is used to start up or stop the power generation of Solis Three Phase Inverter (see Figure 7.18).

— Grid ON
Grid OFF

Figure 7.18 Set Grid ON/OFF

Screens can be scrolled manually by pressing the UP/DOWN keys. Press the ENTER key to save the setting. Press the ESC key to return to the previous menu.

7. Operation

7.5.3 24H Switch

This function controls the 24H hours consumption function enable or disable (see Figure 7.19).

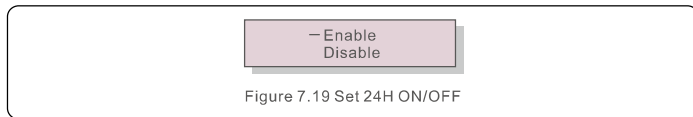

Figure 7.19 Set 24H ON/OFF

NOTE:



When this is enabled, the inverter LCD will still be alive at night with the power LED light on. If the grid is in malfunction at night, the system can't recover even after the grid is back to normal but the consumption data will still be recorded in the meter. Until the sunrise, the system will start to work again while the meter data can be uploaded to the Solis monitoring system to calibrate the load consumption data.

7.5.4 Clear Energy

Clear Energy can reset the history yield of inverter



These two functions are applicable by maintenance personnel only, wrong operation will prevent the inverter from working properly.

7.5.5 Reset Password

This function is used to set the new password for menu "Advanced info." and "Advanced information" (see Figure 7.20).

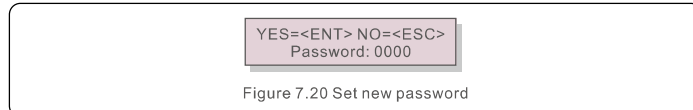

Figure 7.20 Set new password

Enter the right password before set new password. Press the DOWN key to move the cursor, Press the UP key to revise the value. Press the ENTER key to execute the setting. Press the ESC key to return to the previous menu.

7. Operation

7.5.6 Power control

Active and reactive power can be set through power setting button.

There are 5 item for this sub menu:

1. Set output power
2. Set Reactive Power
3. Out_P With Restore
4. Rea_P With Restore
5. Select PF Curve



This function is applicable by maintenance personnel only, wrong operation will prevent the inverter from reaching maximum power.

7.5.7 Calibrate Energy

Maintenance or replacement could clear or cause a different value of total energy. Use this function could allow user to revise the value of total energy to the same value as before. If the monitoring website is used the data will be synchronous with this setting automatically.

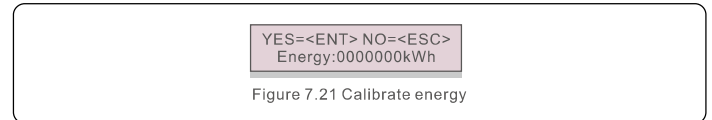

Figure 7.21 Calibrate energy

Press the DOWN key to move the cursor, Press the UP key to revise the value. Press the ENTER key to execute the setting. Press the ESC key to return to the previous menu.

7.5.8 Special Settings



This function is applicable by maintenance personnel only, wrong operation will prevent the inverter from reaching maximum power.

7.5.9 STD Mode settings

There are 5 setting under STD. Mode settings.

1. Working mode
2. Power Rate limit
3. Freq. Derate set
4. 10mins OV-G-V set.
5. Initial Settings



This function is applicable by maintenance personnel only, wrong operation will prevent the inverter from reaching maximum power.

7. Operation

7.5.9.1 Enable logic interface settings

When select G98 or G99 standard to use the logic interface function, please follow below settings to enable the **DRM**. DRM default setting is "OFF", if DRM set "ON", but the logic interface un-connected to the switch or the switch is open, the inverter HMI will display "Limit by DRM" and the inverter output power will be limited to zero.

1. Select **Initial Settings**
2. Select **DRM** and set it "ON"

7.5.10 Restore Settings

There are 5 items in initial setting submenu.

Restore setting could set all item in 7.5.8 special setting to default.

The screen shows as below:

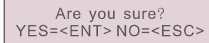

Are you sure?
YES=<ENT> NO=<ESC>

Figure 7.22 Restore Settings

Press the Enter key to save the setting after setting grid off.

Press the ESC key to return the previous mean.

7.5.11 HMI Update

This function is used for updating the LCD program.



This function is applicable by maintenance personnel only, wrong operation will prevent the inverter from reaching maximum power.

7. Operation

7.5.12 Internal EPM Set



NOTE:

This section includes two functions related to the smart meter.

Please refer to section 5.3.6 for detailed connection diagrams.

Function 1: Internal Export Power Management Function

Inverters can work with a smart meter to dynamically limit the export power of the system. Zero injection can be achieved.

Smart meter can be installed either on the grid side OR the load side.

Function 2: 24 Hour Consumption Monitoring Function

Only applicable if Solis monitoring system is used.

Inverters can work with a smart meter to monitor the load consumption data for the whole day and the data will be displayed on the Solis monitoring system.

Smart meter can only be installed on the grid side.



NOTE:

Please refer to below instructions for different user scenarios.

Scenario 1. Only Function 1 is required

Step 1: Refer to Section 5.3.6 to connect the smart meter on the grid side or load side.

Step 2: Select the Section 7.5.12.1 Mode Select as Option 2(Meter in Load) or Option 3 (Meter in Grid) accordingly.

Step 3: Configure the Section 7.5.12.2 to set the allowed backflow power.

Step 4: Configure the Section 7.5.12.3 to enable the failsafe function (If necessary).

Step 5: Configure the Section 7.5.12.4 to modify the work mode (If necessary).

Scenario 2. Both Function 1 and 2 are required

Using a Smart Meter:

Step 1: Refer to Section 5.3.6 to connect the smart meter on the grid side.

Step 2: Select the Section 7.5.12.1 Mode Select as Option 3(Meter in Grid).

Step 3: Select the Section 7.5.3 24H Switch as "Enable".

Step 4: Configure the Section 7.5.12.2 to set the allowed backflow power.

Step 5: Configure the Section 7.5.12.3 to enable the failsafe function (If necessary).

Step 6: Configure the Solis monitoring system (Please refer to the manual of monitoring device).

If customer does not want to enable the export power control function, please change the "backflow power" to the max output power of the inverter in Step 4 OR simply select the mode as "consumption monitor" in Step 2 and skip Step 4-5.

7. Operation

Select EPM Settings from the Main Menu to access the following options:

1. Mode Select 2. Backflow Power 3. Fail safe ON/OFF 4. Backflow Work Mode

7.5.12.1 Mode Select

There are 4 settings in this menu as below:

1. OFF 2. Meter in Load 3. Meter in Grid 4. Consumption Monitor

OFF: Functions are disabled

Meter in Load: Solis Smart Meter is connected in the load branch circuit.

Meter in Grid: Solis Smart Meter is connected in the grid connection point (The backflow power is default as 0W).

Consumption Monitor: Solis Smart Meter is connected in the grid connection point (The backflow power setting is not applicable).

7.5.12.2 Backflow Power

The setting is used to define the allowed export power into the grid.

The setting range is between 00000W to 29900W.

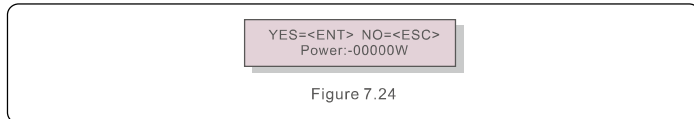
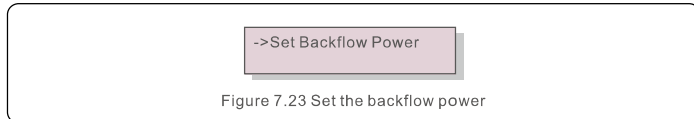

Press the UP/DOWN keys to set data. Press the ENTER key to set backflow power.

Then press DOWN keys to move the cursor, press UP to change the number.

Press the ESC key to save the settings and return to the previous menu.

7.5.12.3 Fail safe ON/OFF

This setting is used to give out an alarm (stop inverter generation as well) when the Meter connection is lost during operation.

It can prevent potential backflow power into the grid when the system loses control.

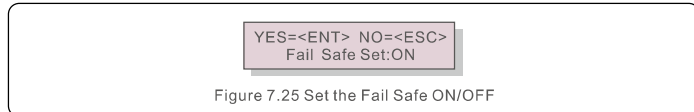

7. Operation

It is only mandatory to turn on this function when the inverter is installed in UK due to the G100 regulation. For other regions, customers can enable or disable the function as they desire.

NOTE:



When the failsafe function is ON and CT/Meter is disconnected somehow, the inverter will stop generation and give "Failsafe" alarm on the LCD. When the failsafe function is OFF and CT/Meter is disconnected somehow, the inverter will keep the output power as the last moment when the CT/Meter is still connected. After a restart, the inverter will output at full power without limit.

7.5.12.4 Backflow Work Mode

This submenu is used for set backflow work mode: 01, 02. "01" is the default mode.

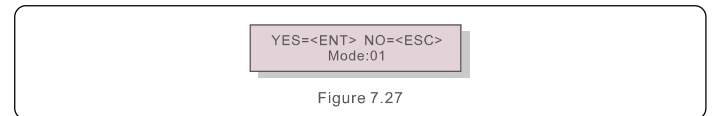
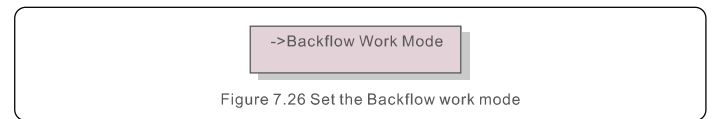

Mode "01", As shown in the figure 7.28, the average limiting mode, the output power of each phase is the average of the three-phase load power, and it is more than the phase of the lowest power in three phases.

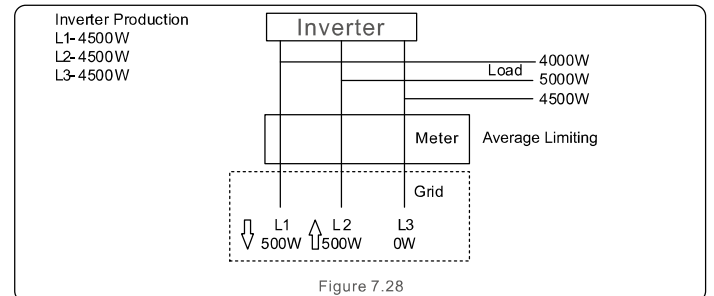

7. Operation

Mode "02", As shown in the figure 7.29 the per phase limiting mode, the inverter only generate the power that equals to one of three-phase load power that is the lowest load power of a certain phase.

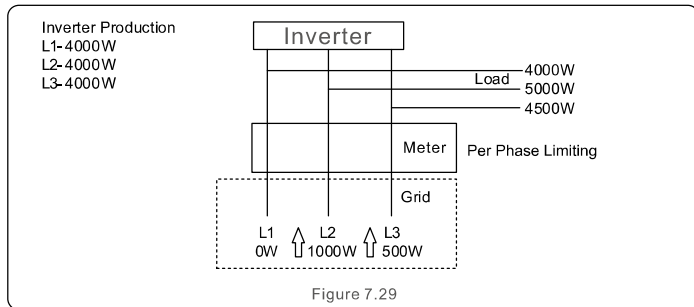

7.5.13 External EPM Set

This setting should only be turned on when Solis external EPM device is used. Two options are available : 5G-EPM and Others-EPM.

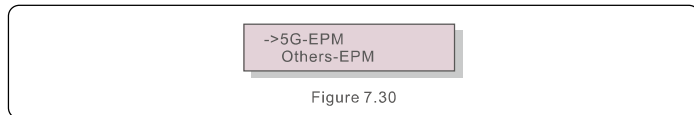

5G-EPM Failsafe Option should be turned ON when 5G series EPM device is used
Others-EPM Failsafe Option should be turned ON when 2G series EPM device is used
Only one option can be activated each time.

7.5.14 Restart HMI

The function is used for restart the HMI.

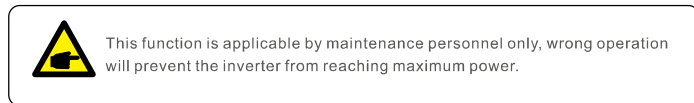

7. Operation

7.5.15 Debug Parameter

This function is used for manufacturer maintenance personnel only.

7.5.16 DSP Update

The function is used for update the DSP.

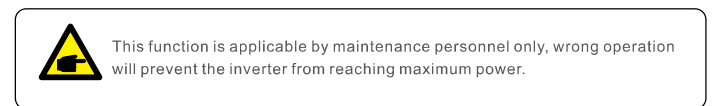

7.5.17 Compensation Set

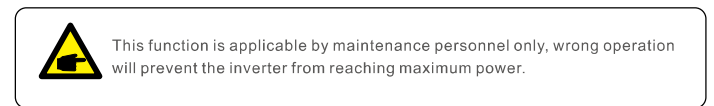

7.6 AFCI function

Solis inverters have the built-in AFCI function which can detect the arc fault on the DC circuit and shut down the inverter to prevent a fire disaster.

7.6.1 Enable the AFCI function

The AFCI function can be enabled in the following.

Path: Advanced Setting -> Password: 0010 -> Special Settings -> AFCI Set ->

AFCI ON/OFF -> ON

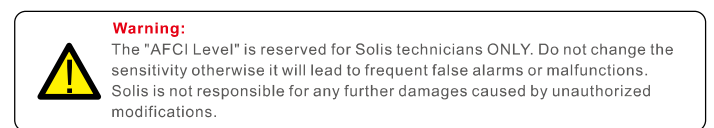
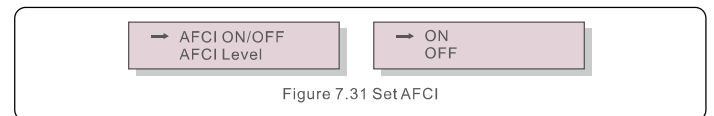

7. Operation

8. Maintenance



NOTE:

The setting corresponds to the current status as well which can be used to inspect the ON/OFF state of the AFCI function.

7.6.2 Arc Fault

During the normal operation, if an DC arc is detected, the inverter will shut down and give out the following alarm:

ARC-FAULT
Restart Press ESC 3s

Figure 7.32 Arc Fault

Installer needs to thoroughly inspect the DC circuit to ensure all the cables are correctly fastened.

Once the DC circuit issue has been fixed or it is confirmed to be OK, press "ESC" for 3s and wait for the inverter to restart.

Solis Three Phase Inverter does not require any regular maintenance. However, cleaning the dust on heat-sink will help the inverter to dissipate the heat and increase its life time. The dust can be removed with a soft brush.



CAUTION:

Do not touch the inverter's surface when it is operating. Some parts of the inverter may be hot and cause burns. Turn off the inverter (refer to Section 6.2) and wait for a cool-down period before any maintenance or cleaning operation.

The LCD and the LED status indicator lights can be cleaned with a damp cloth if they are too dirty to be read.



NOTE:

Never use any solvents, abrasives or corrosive materials to clean the inverter.

8.1 Fan Maintenance

If the fan does not work properly, the inverter will not be cooled effectively, and it may affect the effective operation of the inverter.

Therefore, it is necessary to clean or replace a broken fan as follows:

1. Disconnect the AC power.
2. Turn the DC switch to "OFF" position.
3. Wait for 10 minutes at least.
4. Disconnect all electric connection.
5. Place the inverter on the platform.
6. Remove the 4 screws on the fan plate and pull out the fan assembly slowly.

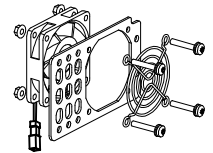
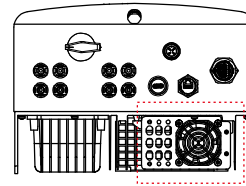

7. Disconnect the fan connector carefully and take out the fan.
8. Clean or replace the fan. Assemble the fan on the rack.
9. Connect the electrical wire and reinstall the fan assembly. Restart the inverter.

9. Troubleshooting

The inverter is designed in accordance with the most important international grid-tied standards and safety and electromagnetic compatibility requirements. Before delivering to the customer, the inverter has been subjected to several tests to ensure its optimal operation and reliability.

In case of failure, the LCD screen will display an alarm message. In this case, the inverter may stop feeding into the grid. The failure descriptions and their corresponding alarm messages are listed in Table 9.1:

Alarm Message	Failure description	Solution
No power	Inverter no power on LCD	1. Check PV input connections 2. Check DC input voltage (single phase >120V, three phase >350V) 3. Check if PV+/- is reversed
LCD show initializing all the time	Can not start-up	1. Check if the connector on main board or power board are fixed. 2. Check if the DSP connector to power board are fixed.
OV-G-V01/02/03/04	Over grid voltage	1. Resistant of AC cable is too high. Change bigger size grid cable 2. Adjust the protection limit if it's allowed by electrical company.
UN-G-V01/02	Under grid voltage	1. Use user define function to adjust the protection limit if it's allowed by electrical company.
OV-G-F01/02	Over grid frequency	
UN-G-F01/02	Under grid frequency	
G-IMP	High grid impedance	
NO-GRID	No grid voltage	1. Check connections and grid switch. 2. Check the grid voltage inside inverter terminal.
OV-DC01/02/03/04	Over DC voltage	1. Reduce the module number in series
OV-BUS	Over DC bus voltage	1. Check inverter inductor connection 2. Check driver connection
UN-BUS01/02	Under DC bus voltage	
GRID-INTF01/02	Grid interference	1. Restart inverter 2. Change power board
OV-G-I	Over grid current	
IGBT-OV-I	Over IGBT current	
DC-INTF OV-DCA-I	DC input overcurrent	1. Restart inverter 2. Identify and remove the string to the fault MPPT 2. Change power board
IGFOL-F	Grid current tracking fail	1. Restart inverter or contact installer.
IG-AD	Grid current sampling fail	
INI-FAULT	Initialization system fault	1. Restart inverter or contact installer.
DSP-B-FAULT	Comm. failure between main and slave DSP	
12Power-FAULT	12V power supply fault	

.44.

9. Troubleshooting

Alarm Message	Failure description	Solution
OV-TEM	Over Temperature	1. Check inverter surrounding ventilation. 2. Check if there's sunshine direct on inverter in hot weather.
PV ISO-PRO 01/02	PV isolation protection	1. Remove all DC input, reconnect and restart inverter one by one. 2. Identify which string cause the fault and check the isolation of the string.
lLeak-PRO 01/02/03/04	Leakage current protection	1. Check AC and DC connection 2. Check inverter inside cable connection.
RelayChk-FAIL	Relay check fail	1. Restart inverter or contact installer.
DCinj-FAULT	High DC injection current	
AFCI self-detection (model with AFCI module)	AFCI module self-detect fault	1. Restart inverter or connect technician.
Arcing protection (model with AFCI module)	Detect arc in DC circuit	1. Check inverter connection whether arc exists and restart inverter.
Screen OFF with DC applied	Inverter internally damaged	1. Do not turn off the DC switches as it will damage the inverter. 2. Please wait for the solar irradiance reduces and confirm the string current is less than 0.5A with a clip-on ammeter and then turn off the DC switches. 3. Please note that any damages due to wrong operations are not covered in the device warranty.

Table 9.1 Fault message and description



NOTE:

If the inverter displays any alarm message as listed in Table 9.1; please turn off the inverter (refer to Section 6.2 to stop your inverter) and wait for 5 minutes before restarting it (refer to Section 6.1 to start your inverter). If the failure persists, please contact your local distributor or the service center. Please keep ready with you the following information before contacting us.

1. Serial number of Solis Three Phase Inverter;
2. The distributor/dealer of Solis Three Phase Inverter (if available);
3. Installation date.
4. The description of problem (i.e. the alarm message displayed on the LCD and the status of the LED status indicator lights. Other readings obtained from the Information submenu (refer to Section 6.2) will also be helpful.);
5. The PV array configuration (e.g. number of panels, capacity of panels, number of strings, etc.);
6. Your contact details.

.45.

10. Specifications

Model	S5-GR3P3K
Max. DC input voltage (Volts)	1100
Rated DC voltage (Volts)	600
Start-up voltage (Volts)	180
MPPT voltage range (Volts)	160...1000
Max. input current (Amps)	16+16
Max short circuit input current (Amps)	25+25
MPPT number/Max input strings number	2/2
Rated output power (Watts)	3000
Max. output power (Watts)	3300
Max. apparent output power (VA)	3300
Rated grid voltage (Volts)	3/N/PE~220/380, 230/400
Rated output current (Amps)	4.6/4.3
Max. output current (Amps)	4.7
Power Factor (at rated output power)	> 0.99 (0.8 leading - 0.8 lagging)
THDi (at rated output power)	<2%
Rated grid frequency (Hertz)	50/60
Operating frequency range (Hertz)	45...55 or 55...65
Max. efficiency	98.3%
EU efficiency	97.7%
Dimensions	310W*563H*219D (mm)
Weight	17.8kg
Topology	Transformerless
Self consumption (night)	< 1 W
Operating ambient temperature range	-25°C... +60°C
Relative humidity	0~100%
Ingress protection	IP66
Noise emission (typical)	<30 dBA
Cooling concept	Natural convection
Max.operation altitude	4000m
Grid connection standard	G98 or G99, VDE-AR-N 4105 / VDE V 0124, EN 50549-1, VDE 0126 / UTE C 15 / VFR:2019, RD 1699 / RD 244 / UNE 206006 / UNE 206007-1, CEI 0-21, C10/11, NRS 097-2-1, TOR, EIFS 2018.2, IEC 62116, IEC 61727, IEC 60068, IEC 61683, EN 50530
Safety/EMC standard	IEC 62109-1/-2, EN 61000-6-1/-2/-3/-4
DC connection	MC4 connector
AC connection	Quick connection plug
Display	LCD, 2x20 Z.
Communication connections	RS485, DO, DI, Optional: Wi-Fi, GPRS, USB*
Warranty Terms	5 Years (Extend to 20 Years)

Optional USB* :only for the brazilian market

.46.

10. Specifications

Model	S5-GR3P4K
Max. DC input voltage (Volts)	1100
Rated DC voltage (Volts)	600
Start-up voltage (Volts)	180
MPPT voltage range (Volts)	160...1000
Max. input current (Amps)	16+16
Max short circuit input current (Amps)	25+25
MPPT number/Max input strings number	2/2
Rated output power (Watts)	4000
Max. output power (Watts)	4400
Max. apparent output power (VA)	4400
Rated grid voltage (Volts)	3/N/PE~220/380, 230/400
Rated output current (Amps)	6.1/5.8
Max. output current (Amps)	6.4
Power Factor (at rated output power)	> 0.99 (0.8 leading - 0.8 lagging)
THDi (at rated output power)	<2%
Rated grid frequency (Hertz)	50/60
Operating frequency range (Hertz)	45...55 or 55...65
Max. efficiency	98.3%
EU efficiency	97.7%
Dimensions	310W*563H*219D (mm)
Weight	17.8kg
Topology	Transformerless
Self consumption (night)	< 1 W
Operating ambient temperature range	-25°C... +60°C
Relative humidity	0~100%
Ingress protection	IP66
Noise emission (typical)	<30 dBA
Cooling concept	Natural convection
Max.operation altitude	4000m
Grid connection standard	G98 or G99, VDE-AR-N 4105 / VDE V 0124, EN 50549-1, VDE 0126 / UTE C 15 / VFR:2019, RD 1699 / RD 244 / UNE 206006 / UNE 206007-1, CEI 0-21, C10/11, NRS 097-2-1, TOR, EIFS 2018.2, IEC 62116, IEC 61727, IEC 60068, IEC 61683, EN 50530
Safety/EMC standard	IEC 62109-1/-2, EN 61000-6-1/-2/-3/-4
DC connection	MC4 connector
AC connection	Quick connection plug
Display	LCD, 2x20 Z.
Communication connections	RS485, DO, DI, Optional: Wi-Fi, GPRS, USB*
Warranty Terms	5 Years (Extend to 20 Years)

Optional USB* :only for the brazilian market

.47.

10. Specifications

Model	S5-GR3P5K
Max. DC input voltage (Volts)	1100
Rated DC voltage (Volts)	600
Start-up voltage (Volts)	180
MPPT voltage range (Volts)	160...1000
Max. input current (Amps)	16+16
Max short circuit input current (Amps)	25+25
MPPT number/Max input strings number	2/2
Rated output power (Watts)	5000
Max. output power (Watts)	5500
Max. apparent output power (VA)	5500
Rated grid voltage (Volts)	3/N/PE~220/380, 230/400
Rated output current (Amps)	7.6/7.2
Max. output current (Amps)	7.9
Power Factor (at rated output power)	> 0.99 (0.8 leading - 0.8 lagging)
THDi (at rated output power)	<2%
Rated grid frequency (Hertz)	50/60
Operating frequency range (Hertz)	45...55 or 55...65
Max. efficiency	98.3%
EU efficiency	97.9%
Dimensions	310W*563H*219D (mm)
Weight	17.8kg
Topology	Transformerless
Self consumption (night)	< 1 W
Operating ambient temperature range	-25°C... +60°C
Relative humidity	0~100%
Ingress protection	IP66
Noise emission (typical)	<30 dBA
Cooling concept	Natural convection
Max.operation altitude	4000m
Grid connection standard	G98 or G99, VDE-AR-N 4105 / VDE V 0124, EN 50549-1, VDE 0126 / UTE C 15 / VFR:2019, RD 1699 / RD 244 / UNE 206006 / UNE 206007-1, CEI 0-21, C10/11, NRS 097-2-1, TOR, EIFS 2018.2, IEC 62116, IEC 61727, IEC 60068, IEC 61683, EN 50530
Safety/EMC standard	IEC 62109-1/-2, EN 61000-6-1/-2/-3/-4
DC connection	MC4 connector
AC connection	Quick connection plug
Display	LCD, 2x20 Z.
Communication connections	RS485, DO, DI, Optional: Wi-Fi, GPRS, USB*
Warranty Terms	5 Years (Extend to 20 Years)

Optional USB* :only for the brazilian market

.48.

10. Specifications

Model	S5-GR3P6K
Max. DC input voltage (Volts)	1100
Rated DC voltage (Volts)	600
Start-up voltage (Volts)	180
MPPT voltage range (Volts)	160...1000
Max. input current (Amps)	16+16
Max short circuit input current (Amps)	25+25
MPPT number/Max input strings number	2/2
Rated output power (Watts)	6000
Max. output power (Watts)	6600
Max. apparent output power (VA)	6600
Rated grid voltage (Volts)	3/N/PE~220/380, 230/400
Rated output current (Amps)	9.1/8.7
Max. output current (Amps)	9.5
Power Factor (at rated output power)	> 0.99 (0.8 leading - 0.8 lagging)
THDi (at rated output power)	<2%
Rated grid frequency (Hertz)	50/60
Operating frequency range (Hertz)	45...55 or 55...65
Max. efficiency	98.3%
EU efficiency	97.9%
Dimensions	310W*563H*219D (mm)
Weight	17.8kg
Topology	Transformerless
Self consumption (night)	< 1 W
Operating ambient temperature range	-25°C... +60°C
Relative humidity	0~100%
Ingress protection	IP66
Noise emission (typical)	<30 dBA
Cooling concept	Natural convection
Max.operation altitude	4000m
Grid connection standard	G98 or G99, VDE-AR-N 4105 / VDE V 0124, EN 50549-1, VDE 0126 / UTE C 15 / VFR:2019, RD 1699 / RD 244 / UNE 206006 / UNE 206007-1, CEI 0-21, C10/11, NRS 097-2-1, TOR, EIFS 2018.2, IEC 62116, IEC 61727, IEC 60068, IEC 61683, EN 50530
Safety/EMC standard	IEC 62109-1/-2, EN 61000-6-1/-2/-3/-4
DC connection	MC4 connector
AC connection	Quick connection plug
Display	LCD, 2x20 Z.
Communication connections	RS485, DO, DI, Optional: Wi-Fi, GPRS, USB*
Warranty Terms	5 Years (Extend to 20 Years)

Optional USB* :only for the brazilian market

.49.

10. Specifications

Model	S5-GR3P8K
Max. DC input voltage (Volts)	1100
Rated DC voltage (Volts)	600
Start-up voltage (Volts)	180
MPPT voltage range (Volts)	160...1000
Max. input current (Amps)	16+16
Max short circuit input current (Amps)	25+25
MPPT number/Max input strings number	2/2
Rated output power (Watts)	8000
Max. output power (Watts)	8800
Max. apparent output power (VA)	8800
Rated grid voltage (Volts)	3/N/PE~220/380, 230/400
Rated output current (Amps)	12.2/11.5
Max. output current (Amps)	12.7
Power Factor (at rated output power)	> 0.99 (0.8 leading - 0.8 lagging)
THDi (at rated output power)	<2%
Rated grid frequency (Hertz)	50/60
Operating frequency range (Hertz)	45...55 or 55...65
Max. efficiency	98.5%
EU efficiency	97.9%
Dimensions	310W*563H*219D (mm)
Weight	17.8kg
Topology	Transformerless
Self consumption (night)	< 1 W
Operating ambient temperature range	-25°C. . . +60°C
Relative humidity	0~100%
Ingress protection	IP66
Noise emission (typical)	<30 dBA
Cooling concept	Natural convection
Max.operation altitude	4000m
Grid connection standard	G98 or G99, VDE-AR-N 4105 / VDE V 0124, EN 50549-1, VDE 0126 / UTE C 15 / VFR:2019, RD 1699 / RD 244 / UNE 206006 / UNE 206007-1, CEI 0-21, C10/11, NRS 097-2-1, TOR, EIFS 2018.2, IEC 62116, IEC 61727, IEC 60068, IEC 61683, EN 50530
Safety/EMC standard	IEC 62109-1/-2, EN 61000-6-1/-2/-3/-4
DC connection	MC4 connector
AC connection	Quick connection plug
Display	LCD, 2x20 Z.
Communication connections	RS485, DO, DI, Optional: Wi-Fi, GPRS, USB*
Warranty Terms	5 Years (Extend to 20 Years)

Optional USB* :only for the brazilian market

.50.

10. Specifications

Model	S5-GR3P9K
Max. DC input voltage (Volts)	1100
Rated DC voltage (Volts)	600
Start-up voltage (Volts)	180
MPPT voltage range (Volts)	160...1000
Max. input current (Amps)	16+16
Max short circuit input current (Amps)	25+25
MPPT number/Max input strings number	2/2
Rated output power (Watts)	9000
Max. output power (Watts)	9900
Max. apparent output power (VA)	9900
Rated grid voltage (Volts)	3/N/PE~220/380, 230/400
Rated output current (Amps)	13.7/13.0
Max. output current (Amps)	14.3
Power Factor (at rated output power)	> 0.99 (0.8 leading - 0.8 lagging)
THDi (at rated output power)	<2%
Rated grid frequency (Hertz)	50/60
Operating frequency range (Hertz)	45...55 or 55...65
Max. efficiency	98.5%
EU efficiency	97.9%
Dimensions	310W*563H*219D (mm)
Weight	17.8kg
Topology	Transformerless
Self consumption (night)	< 1 W
Operating ambient temperature range	-25°C. . . +60°C
Relative humidity	0~100%
Ingress protection	IP66
Noise emission (typical)	<30 dBA
Cooling concept	Natural convection
Max.operation altitude	4000m
Grid connection standard	G98 or G99, VDE-AR-N 4105 / VDE V 0124, EN 50549-1, VDE 0126 / UTE C 15 / VFR:2019, RD 1699 / RD 244 / UNE 206006 / UNE 206007-1, CEI 0-21, C10/11, NRS 097-2-1, TOR, EIFS 2018.2, IEC 62116, IEC 61727, IEC 60068, IEC 61683, EN 50530
Safety/EMC standard	IEC 62109-1/-2, EN 61000-6-1/-2/-3/-4
DC connection	MC4 connector
AC connection	Quick connection plug
Display	LCD, 2x20 Z.
Communication connections	RS485, DO, DI, Optional: Wi-Fi, GPRS, USB*
Warranty Terms	5 Years (Extend to 20 Years)

Optional USB* :only for the brazilian market

.51.

10. Specifications

Model	S5-GR3P10K
Max. DC input voltage (Volts)	1100
Rated DC voltage (Volts)	600
Start-up voltage (Volts)	180
MPPT voltage range (Volts)	160...1000
Max. input current (Amps)	16+16
Max short circuit input current (Amps)	25+25
MPPT number/Max input strings number	2/2
Rated output power (Watts)	10000
Max. output power (Watts)	11000
Max. apparent output power (VA)	11000
Rated grid voltage (Volts)	3/N/PE~220/380, 230/400
Rated output current (Amps)	15.2/14.4
Max. output current (Amps)	15.9
Power Factor (at rated output power)	> 0.99 (0.8 leading - 0.8 lagging)
THDi (at rated output power)	<2%
Rated grid frequency (Hertz)	50/60
Operating frequency range (Hertz)	45...55 or 55...65
Max. efficiency	98.5%
EU efficiency	97.9%
Dimensions	310W*563H*219D (mm)
Weight	17.8kg
Topology	Transformerless
Self consumption (night)	< 1 W
Operating ambient temperature range	-25°C... +60°C
Relative humidity	0~100%
Ingress protection	IP66
Noise emission (typical)	<30 dBA
Cooling concept	Natural convection
Max.operation altitude	4000m
Grid connection standard	G98 or G99, VDE-AR-N 4105 / VDE V 0124, EN 50549-1, VDE 0126 / UTE C 15 / VFR:2019, RD 1699 / RD 244 / UNE 206006 / UNE 206007-1, CEI 0-21, C10/11, NRS 097-2-1, TOR, EIFS 2018.2, IEC 62116, IEC 61727, IEC 60068, IEC 61683, EN 50530
Safety/EMC standard	IEC 62109-1/-2, EN 61000-6-1/-2/-3/-4
DC connection	MC4 connector
AC connection	Quick connection plug
Display	LCD, 2x20 Z.
Communication connections	RS485, DO, DI, Optional: Wi-Fi, GPRS, USB*
Warranty Terms	5 Years (Extend to 20 Years)

Optional USB* :only for the brazilian market

.52.

10. Specifications

Model	S5-GR3P12K
Max. DC input voltage (Volts)	1100
Rated DC voltage (Volts)	600
Start-up voltage (Volts)	180
MPPT voltage range (Volts)	160...1000
Max. input current (Amps)	32+32
Max short circuit input current (Amps)	50+50
MPPT number/Max input strings number	2/4
Rated output power (Watts)	12000
Max. output power (Watts)	13200
Max. apparent output power (VA)	13200
Rated grid voltage (Volts)	3/N/PE, 220/380, 230/400
Rated output current (Amps)	18.2/17.3
Max. output current (Amps)	19.1
Power Factor (at rated output power)	> 0.99 (0.8 leading - 0.8 lagging)
THDi (at rated output power)	<2%
Rated grid frequency (Hertz)	50/60
Operating frequency range (Hertz)	45...55 or 55...65
Max. efficiency	98.6%
EU efficiency	98.0%
Dimensions	310W*563H*219D (mm)
Weight	17.8kg
Topology	Transformerless
Self consumption (night)	< 1 W
Operating ambient temperature range	-25°C... +60°C
Relative humidity	0~100%
Ingress protection	IP66
Noise emission (typical)	<60 dBA
Cooling concept	Intelligent redundant fan-cooling
Max.operation altitude	4000m
Grid connection standard	G98 or G99, VDE-AR-N 4105 / VDE V 0124, EN 50549-1, VDE 0126 / UTE C 15 / VFR:2019, RD 1699 / RD 244 / UNE 206006 / UNE 206007-1, CEI 0-21, C10/11, NRS 097-2-1, TOR, EIFS 2018.2, IEC 62116, IEC 61727, IEC 60068, IEC 61683, EN 50530
Safety/EMC standard	IEC 62109-1/-2, EN 61000-6-1/-2/-3/-4
DC connection	MC4 connector
AC connection	Quick connection plug
Display	LCD, 2x20 Z.
Communication connections	RS485, DO, DI, Optional: Wi-Fi, GPRS, USB*
Warranty Terms	5 Years (Extend to 20 Years)

Optional USB* :only for the brazilian market

.53.

10. Specifications

Model	S5-GR3P13K
Max. DC input voltage (Volts)	1100
Rated DC voltage (Volts)	600
Start-up voltage (Volts)	180
MPPT voltage range (Volts)	160...1000
Max. input current (Amps)	32+32
Max short circuit input current (Amps)	50+50
MPPT number/Max input strings number	2/4
Rated output power (Watts)	13000
Max. output power (Watts)	14300
Max. apparent output power (VA)	14300
Rated grid voltage (Volts)	3/N/PE, 220/380, 230/400
Rated output current (Amps)	19.8/18.8
Max. output current (Amps)	20.7
Power Factor (at rated output power)	> 0.99 (0.8 leading - 0.8 lagging)
THDi (at rated output power)	<2%
Rated grid frequency (Hertz)	50/60
Operating frequency range (Hertz)	45...55 or 55...65
Max. efficiency	98.6%
EU efficiency	98.0%
Dimensions	310W*563H*219D (mm)
Weight	18.8kg
Topology	Transformerless
Self consumption (night)	< 1 W
Operating ambient temperature range	-25°C... +60°C
Relative humidity	0~100%
Ingress protection	IP66
Noise emission (typical)	<60 dBA
Cooling concept	Intelligent redundant fan-cooling
Max.operation altitude	4000m
Grid connection standard	G98 or G99, VDE-AR-N 4105 / VDE V 0124, EN 50549-1, VDE 0126 / UTE C 15 / VFR:2019, RD 1699 / RD 244 / UNE 206006 / UNE 206007-1, CEI 0-21, C10/11, NRS 097-2-1, TOR, EIFS 2018.2, IEC 62116, IEC 61727, IEC 60068, IEC 61683, EN 50530
Safety/EMC standard	IEC 62109-1/-2, EN 61000-6-1/-2/-3/-4
DC connection	MC4 connector
AC connection	Quick connection plug
Display	LCD, 2x20 Z.
Communication connections	RS485, DO, DI, Optional: Wi-Fi, GPRS, USB*
Warranty Terms	5 Years (Extend to 20 Years)

Optional USB* :only for the brazilian market

.54.

10. Specifications

Model	S5-GR3P5K-LV
Max. DC input voltage (Volts)	1100
Rated DC voltage (Volts)	330
Start-up voltage (Volts)	180
MPPT voltage range (Volts)	160...500
Max. input current (Amps)	16+16
Max short circuit input current (Amps)	25+25
MPPT number/Max input strings number	2/2
Rated output power (Watts)	5000
Max. output power (Watts)	5500
Max. apparent output power (VA)	5500
Rated grid voltage (Volts)	3/PE~208/220/240
Rated output current (Amps)	13.1
Max. output current (Amps)	14.4
Power Factor (at rated output power)	> 0.99 (0.8 leading - 0.8 lagging)
THDi (at rated output power)	<2%
Rated grid frequency (Hertz)	50/60
Operating frequency range (Hertz)	45...55 or 55...65
Max. efficiency	98.0%
EU efficiency	97.5%
Dimensions	310W*563H*219D (mm)
Weight	17.8kg
Topology	Transformerless
Self consumption (night)	< 1 W
Operating ambient temperature range	-25°C... +60°C
Relative humidity	0~100%
Ingress protection	IP66
Noise emission (typical)	<30 dBA
Cooling concept	Natural convection
Max.operation altitude	4000m
Grid connection standard	G98 or G99, VDE-AR-N 4105 / VDE V 0124, EN 50549-1, VDE 0126 / UTE C 15 / VFR:2019, RD 1699 / RD 244 / UNE 206006 / UNE 206007-1, CEI 0-21, C10/11, NRS 097-2-1, TOR, EIFS 2018.2, IEC 62116, IEC 61727, IEC 60068, IEC 61683, EN 50530
Safety/EMC standard	IEC 62109-1/-2, EN 61000-6-1/-2/-3/-4
DC connection	MC4 connector
AC connection	Quick connection plug
Display	LCD, 2x20 Z.
Communication connections	RS485, DO, DI, Optional: Wi-Fi, GPRS, USB*
Warranty Terms	5 Years (Extend to 20 Years)

Optional USB* :only for the brazilian market

.55.

10. Specifications

Model	S5-GR3P6K-LV
Max. DC input voltage (Volts)	1100
Rated DC voltage (Volts)	330
Start-up voltage (Volts)	180
MPPT voltage range (Volts)	160...500
Max. input current (Amps)	16+16
Max short circuit input current (Amps)	25+25
MPPT number/Max input strings number	2/2
Rated output power (Watts)	6000
Max. output power (Watts)	6600
Max. apparent output power (VA)	6600
Rated grid voltage (Volts)	3/PE~208/220/240
Rated output current (Amps)	15.7
Max. output current (Amps)	16.7
Power Factor (at rated output power)	> 0.99 (0.8 leading - 0.8 lagging)
THDi (at rated output power)	<2%
Rated grid frequency (Hertz)	50/60
Operating frequency range (Hertz)	45...55 or 55...65
Max. efficiency	98.0%
EU efficiency	97.5%
Dimensions	310W*563H*219D (mm)
Weight	17.8kg
Topology	Transformerless
Self consumption (night)	< 1 W
Operating ambient temperature range	-25°C . . +60°C
Relative humidity	0~100%
Ingress protection	IP66
Noise emission (typical)	<30 dBA
Cooling concept	Natural convection
Max.operation altitude	4000m
Grid connection standard	G98 or G99, VDE-AR-N 4105 / VDE V 0124, EN 50549-1, VDE 0126 / UTE C 15 / VFR:2019, RD 1699 / RD 244 / UNE 206006 / UNE 206007-1, CEI 0-21, C10/11, NRS 097-2-1, TOR, EIFS 2018.2, IEC 62116, IEC 61727, IEC 60068, IEC 61683, EN 50530
Safety/EMC standard	IEC 62109-1/-2, EN 61000-6-1/-2/-3/-4
DC connection	MC4 connector
AC connection	Quick connection plug
Display	LCD, 2x20 Z.
Communication connections	RS485, DO, DI, Optional: Wi-Fi, GPRS, USB*
Warranty Terms	5 Years (Extend to 20 Years)

Optional USB* :only for the brazilian market

.56.

10. Specifications

Model	S5-GR3P8K-BE
Max. DC input voltage (Volts)	1100
Rated DC voltage (Volts)	600
Start-up voltage (Volts)	180
MPPT voltage range (Volts)	160...1000
Max. input current (Amps)	32+32
Max short circuit input current (Amps)	50+50
MPPT number/Max input strings number	2/4
Rated output power (Watts)	8000
Max. output power (Watts)	8800
Max. apparent output power (VA)	8800
Rated grid voltage (Volts)	3/N/PE~230/400
Rated output current (Amps)	11.5
Max. output current (Amps)	12.7
Power Factor (at rated output power)	> 0.99 (0.8 leading - 0.8 lagging)
THDi (at rated output power)	<2%
Rated grid frequency (Hertz)	50
Operating frequency range (Hertz)	45...55
Max. efficiency	98.5%
EU efficiency	97.9%
Dimensions	310W*563H*219D (mm)
Weight	17.8kg
Topology	Transformerless
Self consumption (night)	< 1 W
Operating ambient temperature range	-25°C . . +60°C
Relative humidity	0~100%
Ingress protection	IP66
Noise emission (typical)	<30 dBA
Cooling concept	Natural convection
Max.operation altitude	4000m
Grid connection standard	C10/11
Safety/EMC standard	IEC 62109-1/-2, EN 61000-6-1/-2/-3/-4
DC connection	MC4 connector
AC connection	Quick connection plug
Display	LCD, 2x20 Z.
Communication connections	RS485, DO, DI, Optional: Wi-Fi, GPRS
Warranty Terms	5 Years (Extend to 20 Years)

.57.

10. Specifications

Model	S5-GR3P10K-BE
Max. DC input voltage (Volts)	1100
Rated DC voltage (Volts)	600
Start-up voltage (Volts)	180
MPPT voltage range (Volts)	160...1000
Max. input current (Amps)	32+32
Max short circuit input current (Amps)	50+50
MPPT number/Max input strings number	2/4
Rated output power (Watts)	10000
Max. output power (Watts)	10000
Max. apparent output power (VA)	10000
Rated grid voltage (Volts)	3/N/PE~230/400
Rated output current (Amps)	14.4
Max. output current (Amps)	15.9
Power Factor (at rated output power)	>0.99 (0.8 leading - 0.8 lagging)
THDi (at rated output power)	<2%
Rated grid frequency (Hertz)	50
Operating frequency range (Hertz)	45...55
Max. efficiency	98.5%
EU efficiency	97.9%
Dimensions	310W*563H*219D (mm)
Weight	17.8kg
Topology	Transformerless
Self consumption (night)	< 1 W
Operating ambient temperature range	-25°C . . +60°C
Relative humidity	0~100%
Ingress protection	IP66
Noise emission (typical)	<30 dBA
Cooling concept	Natural convection
Max.operation altitude	4000m
Grid connection standard	C10/11
Safety/EMC standard	IEC 62109-1/-2, EN 61000-6-1/-2/-3/-4
DC connection	MC4 connector
AC connection	Quick connection plug
Display	LCD, 2x20 Z.
Communication connections	RS485, DO, DI, Optional: Wi-Fi, GPRS
Warranty Terms	5 Years (Extend to 20 Years)

11. Appendix

11.1 Grid standard selection guide



NOTE:

Please check if the grid code setting comply with local requirement.

For different countries and regions, corresponding grid code needs to be selected in the inverter LCD to meet the requirements of local network provider.

This instruction indicates how to change the grid code and what code should be selected in different places.

This following list illustrates the grid standard options in the inverter which are subject to change. It is for your reference only. If customer has any doubts or uncertainty, please consult Solis service department for confirmation.

To set the correct grid code, please enter the following path:

Advanced Settings -> Password:0010 -> Select Standard

Detailed protection limits can be viewed when choosing the code.

Please select "Save&Send" to enforce the code.

NO.	Code in LCD	Country/Region	Comments
1	VDE4015	Germany	For German Low Voltage Grid.
2	EN50549 PO	Poland	For Polish Low Voltage Grid
3	EN50549 NL	Netherland	For Dutch Low Voltage Grid
4	EN50438 L	-	General EN50438 Requirement. Possible to be used in Austria, Cyprus, Finland, Czech Republic, Slovenia, etc.
5	EIFS- SW	Sweden	For Swedish Low Voltage Grid
6	France	France	For French Low Voltage Grid
7	C10/11	Belgium	For Belgian Low Voltage Grid
8	NRS097	South Africa	For South African Low Voltage Grid
9	CEI0-21	Italy	For Italian Low Voltage Grid
10	EN50549L (EN50549-1)	-	General EN50549-1 requirement which meets local requirements of most European countries
11	G98	UK	For UK Low Voltage Grid <16A
12	G99	UK	For UK Low Voltage Grid >16A

11. Appendix

NO.	Code in LCD	Country/Region	Comments
13	G98 NI	North Ireland	For North Ireland Low Voltage Grid <16A
14	G99 NI	North Ireland	For North Ireland Low Voltage Grid >16A
15	User-define	-	Customized Protection Limits
16	Gen50	-	Generator Connected, Frequency-Derating, 50Hz
17	Gen 60	-	Generator Connected, Frequency-Derating, 60Hz
18	DK1	East Denmark	For East Danish low voltage grid
19	DK2	West Denmark	For West Danish low voltage grid
20	50438IE	Ireland	For Irish low voltage grid
21	RD1699	Spain	For Spanish low voltage grid
22	EN50549	-	General EN50549 Requirement. Possible to be used in Cyprus, Finland, Czech Republic, Slovenia, Jamaica