

1-Phase PV Grid-Connected Inverter

User Manual

**SG2.0RS-S / SG2.5RS-S / SG3.0RS-S / SG3.0RS /
SG3.6RS / SG4.0RS / SG5.0RS / SG6.0RS**



All Rights Reserved

All Rights Reserved

No part of this document can be reproduced in any form or by any means without the prior written permission of Sungrow Power Supply Co., Ltd (hereinafter "SUNGROW").

Trademarks

SUNGROW and other Sungrow trademarks used in this manual are owned by SUNGROW.

All other trademarks or registered trademarks mentioned in this manual are owned by their respective owners.

Software Licenses

- It is prohibited to use data contained in firmware or software developed by SUNGROW, in part or in full, for commercial purposes by any means.
- It is prohibited to perform reverse engineering, cracking, or any other operations that compromise the original program design of the software developed by SUNGROW.

About This Manual

The manual mainly contains the product information, as well as guidelines for installation, operation, and maintenance. The manual does not include complete information about the photovoltaic (PV) system. Readers can get additional information at www.sungrowpower.com or on the webpage of the respective component manufacturer.

Validity

This manual is valid for the following model of low-power grid-connected PV string inverters:

- SG2.0RS-S
- SG2.5RS-S
- SG3.0RS-S
- SG3.0RS
- SG3.6RS
- SG4.0RS
- SG5.0RS
- SG6.0RS

It will be referred to as "inverter" hereinafter unless otherwise specified.

Target Group

This manual is intended for professional technicians who are responsible for installation, operation, and maintenance of inverters, and users who need to check inverter parameters.

The inverter must only be installed by professional technicians. The professional technician is required to meet the following requirements:

- Know electronic, electrical wiring and mechanical expertise, and be familiar with electrical and mechanical schematics.
- Have received professional training related to the installation and commissioning of electrical equipment.
- Be able to quickly respond to hazards or emergencies that occur during installation and commissioning.
- Be familiar with local standards and relevant safety regulations of electrical systems.
- Read this manual thoroughly and understand the safety instructions related to operations.

How to Use This Manual

Please read this manual carefully before using the product and keep it properly at a place for easy access.

All contents, pictures, marks, and symbols in this manual are owned by SUNGROW. No part of this document may be reprinted by the non-internal staff of SUNGROW without written authorization.

Contents of this manual may be periodically updated or revised, and the actual product purchased shall prevail. Users can obtain the latest manual from support.sungrowpower.com or sales channels.

Symbols

This manual contains important safety instructions, which are highlighted with the following symbols, to ensure personal and property safety during usage, or to help optimize the product performance in an efficient way.

Please carefully understand the meaning of these warning symbols to better use the manual.

DANGER

Indicates high-risk potential hazards that, if not avoided, may lead to death or serious injury.

WARNING

Indicates moderate-risk potential hazards that, if not avoided, may lead to death or serious injury.

CAUTION

Indicates low-risk potential hazards that, if not avoided, may lead to minor or moderate injury.

NOTICE

Indicates potential risks that, if not avoided, may lead to device malfunctions or financial losses.



“NOTE” indicates additional information, emphasized contents or tips that may be helpful, e.g., to help you solve problems or save time.

Contents

All Rights Reserved	I
About This Manual	II
1 Safety	1
1.1 Unpacking and Inspection	1
1.2 Installation Safety	1
1.3 Electrical Connection Safety	2
1.4 Operation Safety	3
1.5 Maintenance Safety	4
1.6 Disposal Safety	4
2 Product Description	5
2.1 System Introduction	5
2.2 Product Introduction	6
2.3 Symbols on the Product	8
2.4 LED Panel	9
2.5 Circuit Diagram	10
2.6 Function Description	11
3 Unpacking and Storage	14
3.1 Unpacking and Inspection	14
3.2 Inverter Storage	14
4 Mechanical Mounting	16
4.1 Safety during Mounting	16
4.2 Location Requirements	16
4.2.1 Environment Requirements	17
4.2.2 Carrier Requirements	17
4.2.3 Angle Requirements	17
4.2.4 Clearance Requirements	18
4.3 Installation Tools	18
4.4 Moving the Inverter	20
4.5 Installing the Inverter	20
5 Electrical Connection	23
5.1 Safety Instructions	23

5.2 Terminal Description	24
5.3 Electrical Connection Overview	25
5.4 External Grounding Connection	26
5.4.1 External Grounding Requirements	27
5.4.2 Connection Procedure	27
5.5 AC Cable Connection	28
5.5.1 AC Side Requirements	28
5.5.2 Assembling the AC Connector	29
5.5.3 Installing the AC Connector	31
5.6 DC Cable Connection	32
5.6.1 PV Input Configuration	32
5.6.2 Assembling the PV Connectors	33
5.6.3 Installing the PV Connectors	34
5.7 WiNet-S Connection	35
5.7.1 Ethernet Communication	36
5.7.2 WLAN Communication	38
5.8 Smart Meter Connection	38
5.9 DRM Connection	40
6 Commissioning	44
6.1 Inspection before Commissioning	44
6.2 Powering on the System	44
6.3 App Preparation	44
6.4 Creating a Plant	45
6.5 Initializing the Device	47
6.6 Configuring the Plant	51
7 iSolarCloud App	55
7.1 Brief Introduction	55
7.2 Installing the App	55
7.3 Account Registration	56
7.4 Login	57
7.4.1 Requirements	57
7.4.2 Login Procedure	57
7.5 Initial Settings	59
7.6 Function Overview	60
7.7 Home	61
7.8 Run Information	62
7.9 Records	63

7.10 More	66
7.10.1 System Parameters	67
7.10.2 Operation Parameters	67
7.10.3 Power Regulation Parameters	68
7.10.4 Communication Parameters	73
7.10.5 Firmware Update	74
7.10.6 Auto-test	75
8 System Decommissioning	77
8.1 Disconnecting the Inverter	77
8.2 Dismantling the Inverter	77
8.3 Disposal of the Inverter	78
9 Troubleshooting and Maintenance	79
9.1 Troubleshooting	79
9.2 Maintenance	88
9.2.1 Maintenance Notices	88
9.2.2 Routine Maintenance	89
10 Appendix	90
10.1 Technical Data	90
10.2 Quality Assurance	95
10.3 Contact Information	96

1 Safety

When installing, commissioning, operating, and maintaining the product, strictly observe the labels on the product and the safety requirements in the manual. Incorrect operation or work may cause:

- Injury or death to the operator or a third party;
- Damage to the product and other properties.



- The safety instructions in this manual are only supplements and cannot cover all the precautions that should be followed. Perform operations considering actual on-site conditions.
- SUNGROW shall not be held liable for any damage caused by violation of general safety operation requirements, general safety standards, or any safety instruction in this manual.
- When installing, operating, and maintaining the product, comply with local laws and regulations. The safety precautions in this manual are only supplements to local laws and regulations.

1.1 Unpacking and Inspection

WARNING

**Check all safety signs, warning labels and nameplates on devices.
Ensure that the safety signs, warning labels and nameplates must be clearly visible and cannot be removed or covered before the device is decommissioned.**

NOTICE

After receiving the product, check whether the appearance and structural parts of the device are damaged, and check whether the packing list is consistent with the actual ordered product. If there are problems with the above inspection items, do not install the device and contact SUNGROW in time.

1.2 Installation Safety

DANGER

**Make sure there is no electrical connection before installation.
Before drilling, avoid the water and electricity wiring in the wall.**

⚠ CAUTION

Improper installation may cause personal injury!

- **If the product supports hoisting transport and is hoisted by hoisting tools, no one is allowed to stay under the product.**
- **When moving the product, be aware of the product weight and keep the balance to prevent it from tilting or falling.**

NOTICE

Before operating the product, must check and ensure that tools to be used have been maintained regularly.

1.3 Electrical Connection Safety

⚠ DANGER

Before electrical connections, please make sure that the inverter is not damaged, otherwise it may cause danger!

Before electrical connections, please make sure that the inverter switch and all switches connected to the inverter are set to "OFF", otherwise electric shock may occur!

⚠ DANGER

The PV string will generate lethal high voltage when exposed to sunlight.

- **Operators must wear proper personal protective equipment during electrical connections.**
- **Must ensure that cables are voltage-free with a measuring instrument before touching DC cables.**
- **Respect all safety instructions listed in relevant documents about PV strings.**

⚠ DANGER

Danger to life due to a high voltage inside the inverter!

- **Be sure to use special insulation tools during cable connections.**
- **Note and observe the warning labels on the product, and perform operations strictly following the safety instructions.**
- **Respect all safety instructions listed in this manual and other pertinent documents.**

⚠ WARNING

Damage to the product caused by incorrect wiring is not covered by the warranty.

- Electrical connection must be performed by professionals.
- All cables used in the PV generation system must be firmly attached, properly insulated, and adequately dimensioned.

⚠ WARNING

Check the positive and negative polarity of the PV strings, and connect the PV connectors to corresponding terminals only after ensuring polarity correctness.

During the installation and operation of the inverter, please ensure that the positive or negative poles of PV strings do not short-circuit to the ground. Otherwise, an AC or DC short-circuit may occur, resulting in equipment damage. The damage caused by this is not covered by the warranty.

NOTICE

Comply with the safety instructions related to PV strings and the regulations related to the local grid.

1.4 Operation Safety

⚠ DANGER

- When the inverter is running, do not touch its enclosure.
- When the inverter is running, it is strictly forbidden to plug and unplug any connector on the inverter.
- When the inverter is running, do not touch any wiring terminal of the inverter. Otherwise, electric shock may occur.
- When the inverter is running, do not disassemble any parts of the inverter. Otherwise, electric shock may occur.
- When the inverter is running, it is strictly forbidden to touch any hot parts of the inverter (such as the heat sink). Otherwise, it may cause burns.
- If the inverter is equipped with a DC switch, do not operate it when the inverter is running. Otherwise, device damage or personal injury may occur.

1.5 Maintenance Safety

DANGER

Risk of inverter damage or personal injury due to incorrect service!

- Before any service work, first disconnect the grid-side AC circuit breaker and check the inverter status. If the inverter indicator is off, please wait until night to disconnect the DC switch. If the inverter indicator is on, directly disconnect the DC switch.
- After the inverter is powered off for 10 minutes, measure the voltage and current with professional instrument. Only when there is no voltage nor current can operators who wear protective equipment operate and maintain the inverter.
- Even if the inverter is shut down, it may still be hot and cause burns. Wear protective gloves before operating the inverter after it cools down.

DANGER

Touching the power grid or the contact points and terminals on the inverter connected to the power grid may lead to electric shock!

- The power grid side may generate voltage. Always use a standard voltmeter to ensure that there is no voltage before touching.

CAUTION

To prevent misuse or accidents caused by unrelated personnel: Post prominent warning signs or demarcate safety warning areas around the inverter to prevent accidents caused by misuse.

NOTICE

To avoid the risk of electric shock, do not perform any other maintenance operations beyond this manual. If necessary, contact SUNGROW for maintenance. Otherwise, the losses caused is not covered by the warranty.

1.6 Disposal Safety

WARNING

Please scrap the inverter in accordance with relevant local regulations and standards to avoid property losses or casualties.

2 Product Description

2.1 System Introduction

The inverter is a transformerless 1-phase PV grid-connected inverter. As an integral component in the PV power system, the inverter is designed to convert the direct current power generated from the PV modules into grid-compatible AC current and feeds the AC current to the utility grid.

⚠ WARNING

- **The inverter must only be operated with PV strings with class II protection in accordance with IEC 61730, application class A. It is not allowed for the positive pole or the negative pole of the PV strings to be grounded. This can cause damage to the inverter.**
- **Do not connect any local load between the inverter and the AC circuit breaker.**

NOTICE

The inverter applies only to the scenarios described in this manual.

The intended usage of the inverter is illustrated in the following figure.

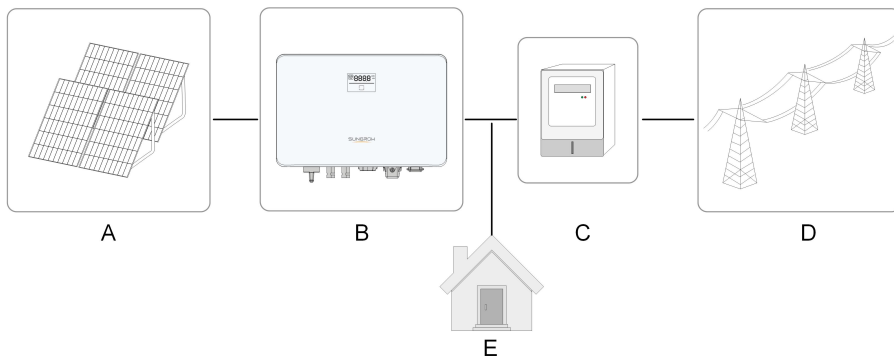

S005-G001

figure 2-1 Inverter Application in PV Power System

Item	Description	Note
A	PV strings	Compatible with monocrystalline silicon, polycrystalline silicon, and thin-film modules without grounding.
B	Inverter	SG2.0RS-S, SG2.5RS-S, SG3.0RS-S, SG3.0RS, SG3.6RS, SG4.0RS, SG5.0RS, SG6.0RS.
C	Metering device	Meter cupboard with power distribution system.

Item	Description	Note
D	Utility grid	TT , TN-C , TN-S, TN-C-S.
E	Loads	House loads that consume electricity.

The following figure shows the common grid configurations.

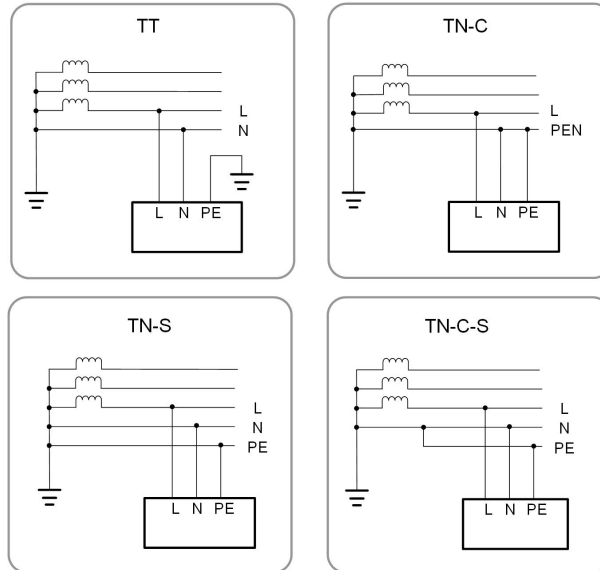

S005-G002

2.2 Product Introduction

Model Description

The model description is as follows (take SG3.0RS-S as an example):

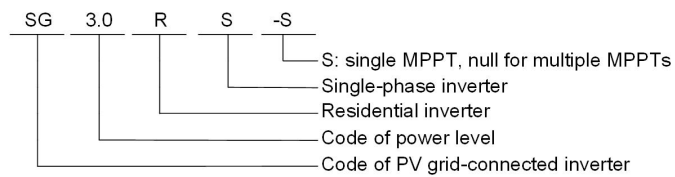

S005-G003

Appearance

The following figure shows the dimensions of the inverter. The image shown here is for reference only. The actual product received may differ.

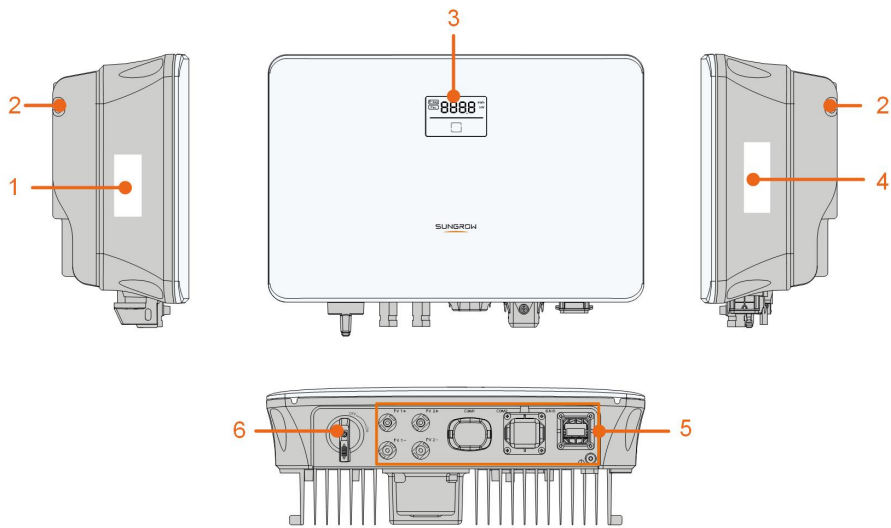

S005-G004

figure 2-2 Inverter Appearance

No.	Name	Description
1	Label	Information about COM2 pin definition, supported DRM modes, etc.
2	Hanger	Complement to the included wall mounting bracket for hanging the inverter.
3	LED pannel	The LED screen indicates the running information and the LED indicator indicates the working state of the inverter.
4	Nameplate	To clearly identify the product, including device model, S/N, important specifications, marks of certification institutions, etc.
5	Electrical connection area	DC terminals (SG6.0RS for example), AC terminal, additional grounding terminal and communication terminals.
6	DC switch	To safely disconnect the DC circuit whenever necessary.

Dimensions

The following figure shows the dimensions of the inverter.

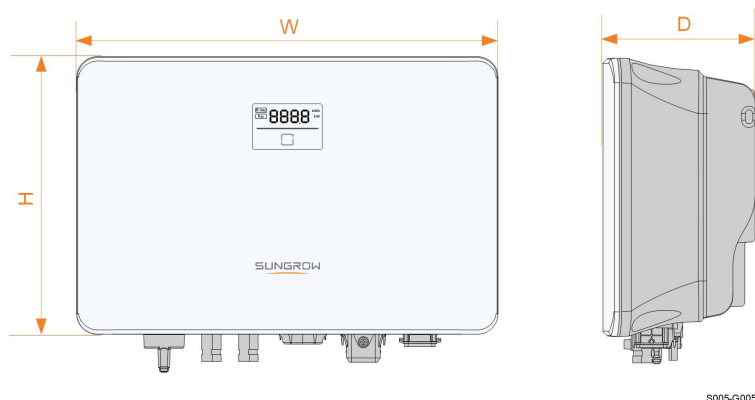





figure 2-3 Dimensions of the Inverter

Inverter Model	W (mm)	H (mm)	D (mm)
SG2.0RS-S, SG2.5RS-S, SG3.0RS-S	320	225	120
SG3.0RS, SG3.6RS, SG4.0RS, SG5.0RS, SG6.0RS	410	270	150

2.3 Symbols on the Product

Symbol	Explanation
	Parameters on the DC side.
	Parameters on the AC on-grid side.
	Regulatory compliance mark.
	TÜV mark of conformity.
	CE mark of conformity. EU/EEA Importer.
	UKCA mark of conformity.
	Do not dispose of the inverter together with household waste.
	The inverter does not have a transformer.
	Disconnect the inverter from all the external power sources before maintenance!

Symbol	Explanation
	Read the user manual before maintenance!
	Burn danger due to the hot surface that may exceed 60°C.
	Danger to life due to high voltages! Do not touch live parts for 10 minutes after disconnection from the power sources. Only qualified personnel can open and maintain the inverter.
	Additional grounding point.

* The table shown here is for reference only. The actual product received may differ.

2.4 LED Panel

The LED panel with a display screen and an indicator is on the front of the inverter.

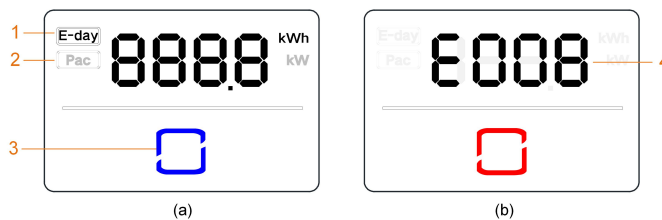

figure 2-4 LED Panel



(a) Normal state

(b) Error state

No.	Name	Description
1	E-day	Today's energy yield.
2	Pac	Current AC power.
3	LED indicator	To indicate the working state of the inverter. Touch it to switch the information in normal state or view multiple error codes in error state.
4	Error code	The error code in the figure is just an example.

- In normal state, the E-day and Pac information will be displayed alternately. Also you can touch the LED indicator to switch the information.
- In error state, touch the LED indicator to view multiple error codes.
- If there is no operation for 5 minutes, the display screen will be off. Touch the LED indicator to activate it.

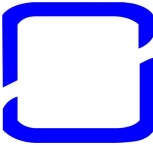
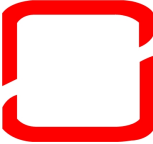
table 2-1 State description of the LED indicator

LED color	State	Definition
 Blue	On Flashing	The inverter is operating normally. The inverter is at standby or startup state (not feeding power into the grid).
 Red	On	A system fault has occurred.
 Gray	Off	Both the AC and DC sides are powered down.

WARNING

Voltage may still be present in AC side circuits after the indicator is off. Pay attention to the electricity safety during operating.

2.5 Circuit Diagram

The following figure shows the main circuit of the inverter.

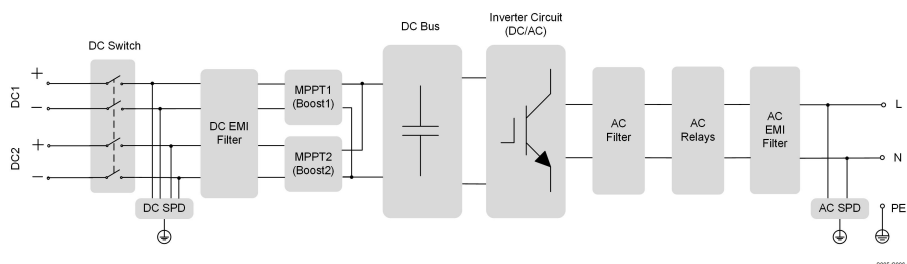

figure 2-5 Circuit Diagram (SG6.0RS for example)

- DC switches can safely disconnect the PV input when necessary to ensure the safe operation of the inverter and the safety of personnel.
- The DC SPD provides a discharge circuit for the DC side over-voltage power to prevent it from damaging the internal circuits of the inverter.
- EMI filters can filter out the electromagnetic interference inside the inverter to ensure that the inverter meets the requirements of electromagnetic compatibility standards.

- The MPPT is utilized for DC input to ensure the maximum power from the PV array at different PV input conditions.
- The inverter circuit converts the DC power into grid-compliant AC power and feeds it into the grid.
- The AC filter filters the output AC component of high frequency to ensure that the output current meets the grid requirements.
- The AC relay isolates the AC output of the inverter from the grid, making the inverter safe from the grid in case of inverter failure or grid failure.
- The AC SPD provides a discharge circuit for the AC side over-voltage power to prevent it from damaging the internal circuits of the inverter.

2.6 Function Description

Basic Function

- Conversion function

The inverter converts the DC power from the PV array to the AC power, in conformity with the grid requirements.

- Data storage

The inverter logs running information, error records, etc.

- Parameter configuration

The inverter provides various parameter configurations for optimal operation. Parameters can be set via the iSolarCloud App or the cloud server. For further configurations, which exceeds the usual parameters configuration, please contact Sungrow.

- Communication interface

The inverter is equipped with two communication interfaces. The communication device can be connected to the inverter via both interfaces.

After communication connection is established, users can view inverter information, operational data and can set inverter parameters through the iSolarCloud.



It is recommended to use the communication module from SUNGROW. Using a device from other companies may lead to communication failure or other unexpected damage.

- Protection Function

Several protective functions are integrated in the inverter, including short circuit protection, grounding insulation resistance monitoring, residual current protection, grid monitoring, DC overvoltage/overcurrent protection, etc.

DRM ("AU"/"NZ")

The DRM function is only applicable to a single inverter.

The inverter provides terminals for connecting to a Demand Response Enabling Device (DRED). After the connection, the DRED asserts demand response modes (DRMs). The inverter detects and initiates a response to all supported demand response modes listed in the following table.

table 2-2 Demand Response Mode Explanation

Mode	Explanation
DRM0	The inverter is in the state of shutdown.

Feed-in Limitation

Set the feed-in limitation value via iSolarCloud App. When the smart energy meter detects that the export power is greater than the limit value, the inverter will reduce the output power within the specified range.

PID Recovery

The inverter is equipped with PID phenomenon recovery function to improve the PV power generation. During the power generation process, the inverter could carry out a main Anti-PID function without any influence to the grid side thanks to a particular technology.

The PID recovery function is disabled by default. Enable the function via iSolarCloud App when there is PV power in the daytime. During the inverter standby process with no irradiance, an additional PID recovery function could apply inverse voltage to PV modules, to restore the degraded modules.

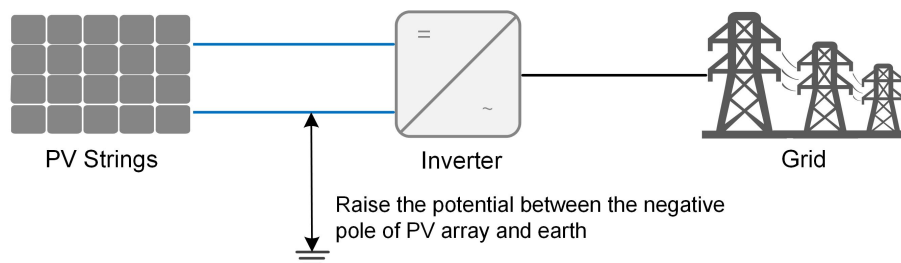

figure 2-6 PID Recovery Scheme

⚠ DANGER

Keep the DC switch "ON" in the PID recovery process. During the process, there is voltage hazard between inverter / PV module live conductors and ground. Do not touch any of them.



When the PID recovery function is enabled, there will be a power consumption of less than 30 W in the PID recovery process.

AFCI Function(Optional)

- AFCI activation

This function can be enabled to detect whether arc occurs in the DC circuit of the inverter.

- AFCI self-test

This function is intended to detect whether the AFCI function of the inverter is normal.



The arc detection function meets the standard requirements, please test under the working conditions as required by the standard.

Auto-test (for Italy CEI0-21 Grid Code Only)

The Italy CEI0-21 grid code requires auto-test for the inverter before grid connection. During the auto-test, the inverter checks the protection threshold and protection time of the 1-level overvoltage (59.S1), 2-level overvoltage (59.S2), 1-level undervoltage (27.S1), 2-level undervoltage (27.S2), 1-level overfrequency (81>.S1), 2-level overfrequency (81>.S2), 1-level underfrequency (81<.S1), 2-level underfrequency (81<.S2) to ensure that the inverter could meet the requirements of CEI0-21 to protect the grid from abnormality after the inverter is operational.

3 Unpacking and Storage

3.1 Unpacking and Inspection

The product is thoroughly tested and strictly inspected before delivery. Nonetheless, damage may still occur during shipping. For this reason, please conduct a thorough inspection after receiving the product.

- Check the packing case for any visible damage.
- Check the scope of delivery for completeness according to the packing list.
- Check the inner contents for damage after unpacking.

Contact SUNGROW or the transport company in case of any damage or incompleteness, and provide photos to facilitate services.

Do not dispose of the original packing case. It is recommended to store the device in the original packing case when the product is decommissioned.

NOTICE

After receiving the product, check whether the appearance and structural parts of the product are damaged, and check whether the packing list is consistent with the actual ordered product. If there are problems with the above inspection items, do not install the device and contact SUNGROW in time.

If any tool is used for unpacking, be careful not to damage the inverter.

3.2 Inverter Storage

Proper storage is required if the inverter is not installed immediately.

- Store the inverter in the original packing case with the desiccant inside.
- The storage temperature must be always between -30°C and $+70^{\circ}\text{C}$, and the storage relative humidity must be always between 0 and 95 %, non-condensing.
- In case of stacking storage, the number of stacking layers should never exceed the limit marked on the outer side of the packing case.
- The packing case should be upright.
- If the inverter needs to be transported again, pack it strictly before loading and transporting it.
- Do not store the inverter in places susceptible to direct sunlight, rain, and strong electric field.

- Do not place the inverter in places with items that may affect or damage the inverter.
- Store the inverter in a clean and dry place to prevent dust and water vapor from eroding.
- Do not store the inverter in places with corrosive substances or susceptible to rodents and insects.
- Carry out periodic inspections. Inspection shall be conducted at least once every six months. If any insect or rodent bites are found, replace the packaging materials in time.
- If the inverter has been stored for more than a year, inspection and testing by professionals are required before it can be put into operation.

NOTICE

Please store the inverter according to the storage requirements. Product damage caused by failure to meet the storage requirements is not covered by the warranty.

4 Mechanical Mounting

WARNING

Respect all local standards and requirements during mechanical installation.

4.1 Safety during Mounting

DANGER

Make sure there is no electrical connection before installation.
Before drilling, avoid the water and electricity wiring in the wall.

WARNING

Poor installation environment will affect system performance!

- Install the inverter in a well-ventilated place.
- Ensure that the heat dissipation system or vent is not blocked.
- Do not install the inverter in an environment with flammable and explosive objects or smoke.

CAUTION

Improper handling may cause personal injury!

- When moving the inverter, be aware of its weight and keep the balance to prevent it from tilting or falling.
- Wear proper protective equipment before performing operations on the inverter.
- The bottom terminals and interfaces of the inverter cannot directly contact the ground or other supports. The inverter cannot be directly placed on the ground.

4.2 Location Requirements

Select an optimal mounting location for safe operation, long service life and expected performance.

- The inverter with protection rating IP65 can be installed both indoors and outdoors.
- Install the inverter at a place convenient for electrical connection, operation, and maintenance.

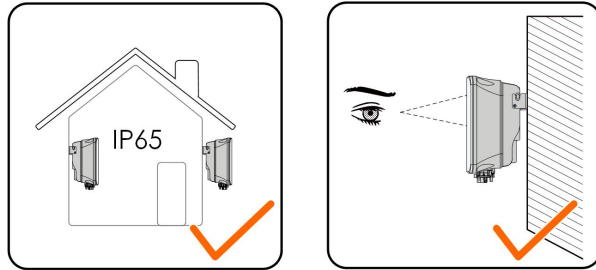

S005-I001

4.2.1 Environment Requirements

- The installation environment must be free of inflammable or explosive materials.
- The location should be not accessible to children.
- The ambient temperature and relative humidity must meet the following requirements.

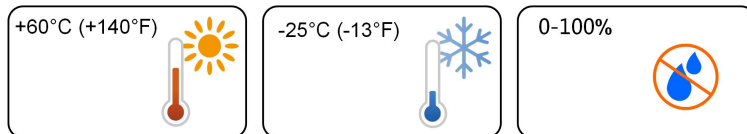

- Inverters free from direct sunlight, direct rain and snow have longer service life. Consider sheltered places as the installation location.
- The inverter should be well ventilated. Ensure air circulation.

4.2.2 Carrier Requirements

The concrete wall should be capable of withstanding a force of four times the weight of the inverter and be suitable for the dimensions of the inverter.

The installation carrier should meet the following requirements:

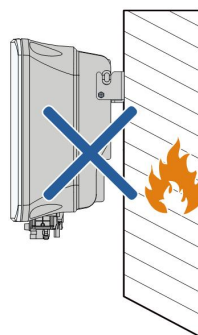

S005-I003

4.2.3 Angle Requirements

Install the inverter vertically. Never install the inverter horizontally, or at forward/backward tilted, side tilted, or upside down.

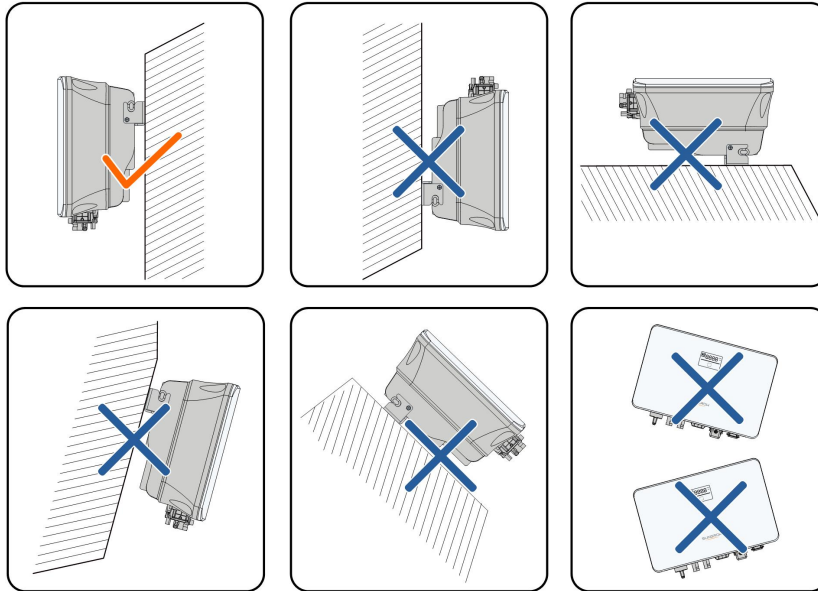

S005-I004

4.2.4 Clearance Requirements

Reserve enough clearance around the inverter to ensure sufficient space for heat dissipation.

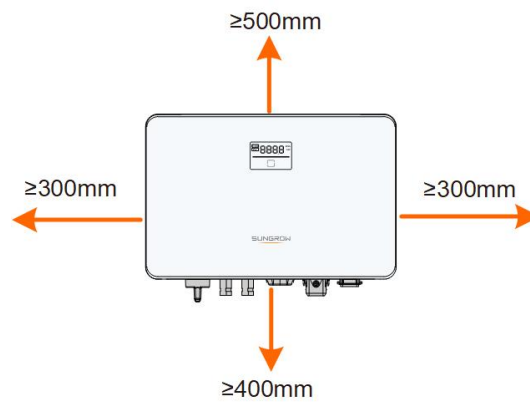

S005-I005

Install the inverter at an appropriate height for ease of viewing the screen and LED indicator and operating switch(es).

4.3 Installation Tools

Installation tools include but are not limited to the following recommended ones. If necessary, use other auxiliary tools on site.

table 4-1 Tool specification



Goggles

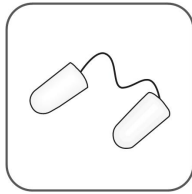

Earplugs

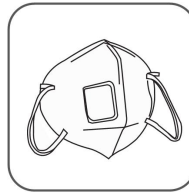

Dust mask



Protective gloves



Insulated shoes



Utility knife

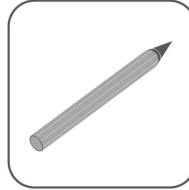

Marker



Wrist strap



Wire cutter

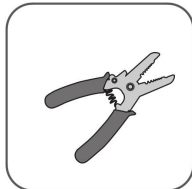

Wire stripper

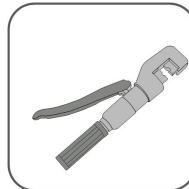

Hydraulic plier

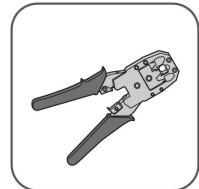

RJ45 crimping tool



MC4 terminal crimping tool (4 mm²–6 mm²)

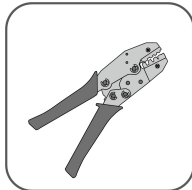

Tube terminal crimping tool (0.5 mm²–1.0 mm²)

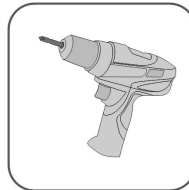

Electric screwdriver (M4, M6)

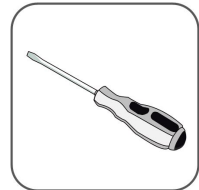

Slotted screwdriver (M2)



Phillips screwdriver (M4)



Vacuum cleaner

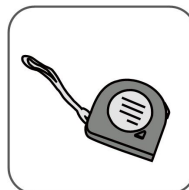

Measuring tape

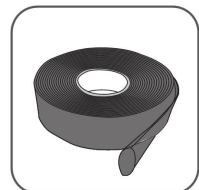

Heat shrink tubing

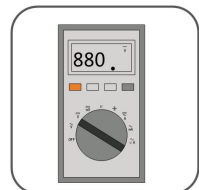
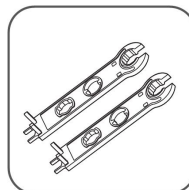
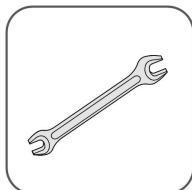
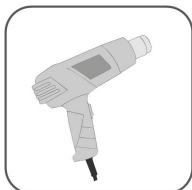

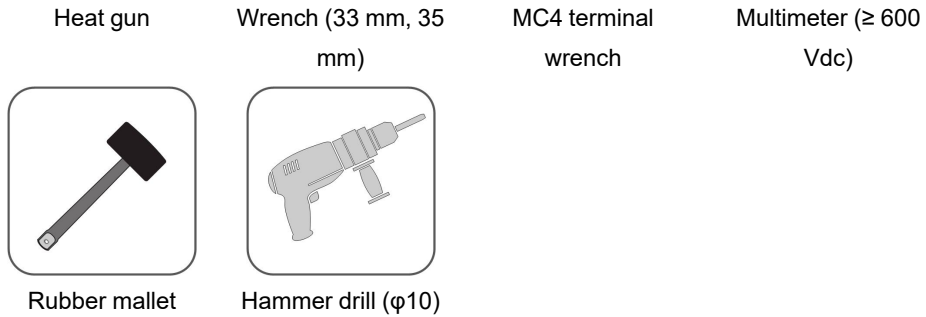

4.4 Moving the Inverter

Before installation, remove the inverter from the packing case and move it to the installation site. Follow the instructions below as you move the inverter:

- Always be aware of the weight of the inverter.
- Lift the inverter using the handles positioned on both sides of the inverter.
- Move the inverter by one or two people or by using a proper transport tool.
- Do not release the equipment unless it has been firmly secured.

⚠ CAUTION

Improper handling may cause personal injury!

- **Arrange an appropriate number of personnel to carry the inverter according to its weight, and installation personnel should wear protective equipment such as anti-impact shoes and gloves.**
- **Attention must be paid to the center of gravity of the inverter to avoid tilting during handling.**
- **Placing the inverter directly on a hard ground may cause damage to its metal enclosure. Protective materials such as sponge pad or foam cushion should be placed underneath the inverter.**
- **Move the inverter by holding the handles on it. Do not move the inverter by holding the terminals.**

4.5 Installing the Inverter

Inverter is installed on the wall by means of wall-mounting bracket and the expansion plug sets.

The expansion plug set shown below is recommended for the installation.

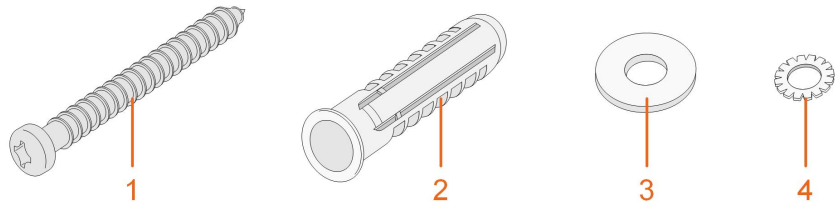

(1) Self-tapping screw M6 (2) Expansion tube (3) Fender washer (4) Spring washer

step 1 Place the wall-mounting bracket to a proper position on the wall. Mark the positions and drill the holes.

NOTICE

Observe the level on the bracket and adjust until the bubble is in the middle position.

The depth of the holes should be about 70 mm.

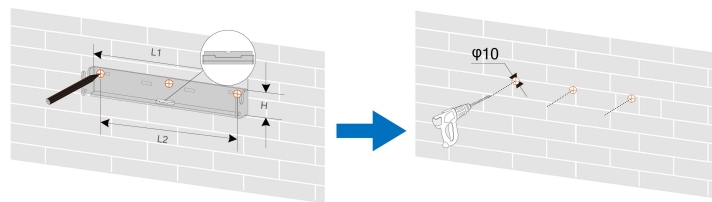

S005-1008

* The image shown here is for reference only. The actual product received may differ.

Inverter Model	L1 (mm)	L2 (mm)	H (mm)
SG2.0RS-S, SG2.5RS-S, SG3.0RS-S	260	225	40
SG3.0RS, SG3.6RS, SG4.0RS, SG5.0RS, SG6.0RS	347	312	40

step 2 Place the expansion tubes into the holes. Then secure the wall-mounting bracket to the wall firmly with the expansion bolt sets.

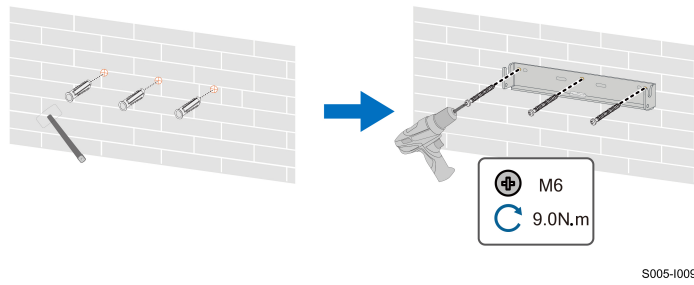

step 3 Lift the inverter and slide it down along the wall-mounting bracket to make sure they match perfectly. Use two screw sets to lock both left and right sides.

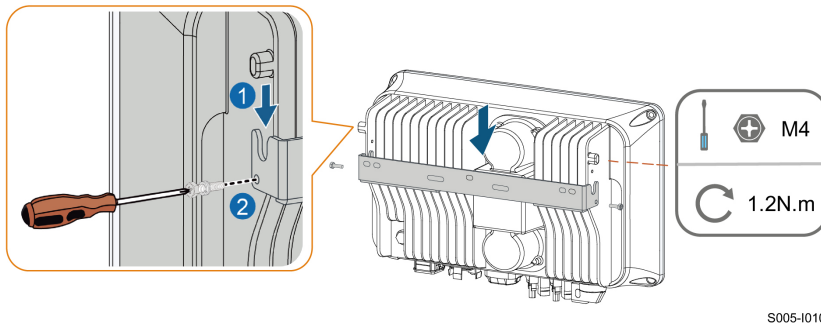

-- End

5 Electrical Connection

5.1 Safety Instructions

DANGER

The PV string will generate lethal high voltage when exposed to sunlight.

- Operators must wear proper personal protective equipment during electrical connections.
- Must ensure that cables are voltage-free with a measuring instrument before touching DC cables.
- Respect all safety instructions listed in relevant documents about PV strings.

DANGER

- Before electrical connections, please make sure that the inverter switch and all switches connected to the inverter are set to "OFF", otherwise electric shock may occur!
- Ensure that the inverter is undamaged and all cables are voltage free before performing electrical work.
- Do not close the AC circuit breaker until the electrical connection is complete.

WARNING

Damage to the product caused by incorrect wiring is not covered by the warranty.

- Electrical connection must be performed by professionals.
- Operators must wear proper personal protective equipment during electrical connections.
- All cables used in the PV generation system must be firmly attached, properly insulated, and adequately dimensioned.

NOTICE

All electrical connections must comply with local and national / regional electrical standards.

- Cables used by the user shall comply with the requirements of local laws and regulations.
- Only with the permission of the national / regional grid department, the inverter can be connected to the grid.

NOTICE

All vacant terminals must be covered with waterproof covers to prevent affecting the protection rating.

When the wiring is completed, seal the gap of cable inlet and outlet holes with fire-proof / waterproof materials such as fireproof mud to prevent foreign matter or moisture from entering and affecting the long-term normal operation of the inverter. Comply with the safety instructions related to PV strings and the regulations related to the utility grid.



The cable colors in figures in this manual are for reference only. Please select cables according to local cable standards.

5.2 Terminal Description

All electrical terminals are located at the bottom side of the inverter.

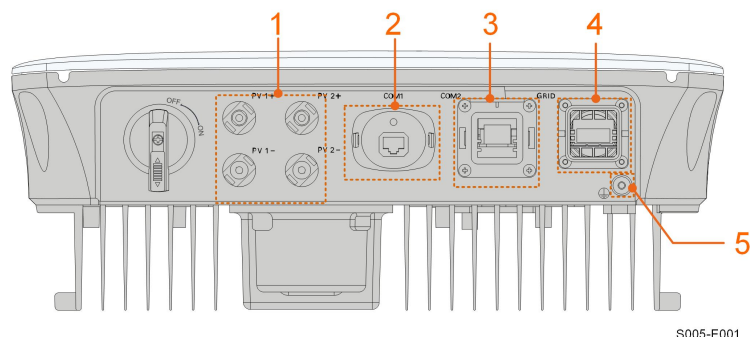

S005-E001

figure 5-1 Terminals (SG3.0RS for example)

* The image shown here is for reference only. The actual product received may differ.

table 5-1 Terminal Description

No.	Name	Description	Decisive Voltage Classification
1	PV1+, PV1-, PV2+, PV2-	MC4 terminals for PV input. The terminal number depends on inverter model.	DVC-C
2	COM1	Communication accessory port to be connected to WiNet-S communication module.	DVC-A

No.	Name	Description	Decisive Voltage Classification
3	COM2	Communication connection for RS485, DRM and smart energy meter.	DVC-A
4	GRID	AC terminal to connect to the grid.	DVC-C
5		Additional grounding terminal.	Not applicable

The pin definition of COM2 terminal is shown in the following label.

RS485	Meter	DRM	RSD
A1	A2	R	RSD-1
B1	B2	C	RSD-2

figure 5-2 Label of COM2 Terminal

table 5-2 Label Description of COM2 Terminal

Label		Description
RS485	A1, B1	Reserved
Meter	A2, B2	For the smart energy meter
DRM	R, C	For external Demand Response Enabling Device ("AU"/"NZ")
RSD	RSD-1, RSD-2	Reserved

5.3 Electrical Connection Overview

The electrical connection should be realized as follows:

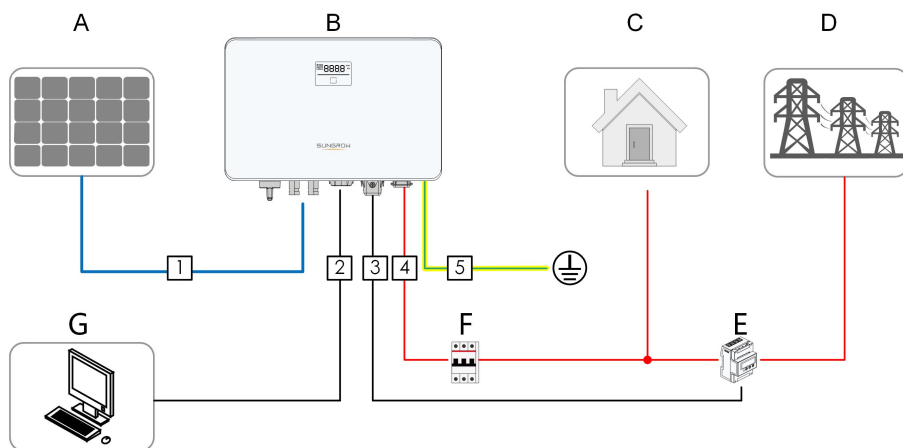

S005-E005

- (A) PV string (B) Inverter (C) Loads
 (D) Grid (E) Smart energy meter (optional)
 (F) AC circuit breaker (G) External device

table 5-3 Cable Requirements

No.	Cable	Type	Cable Diameter	Wire Conductor Cross-section
1	DC cable	Single or multi-core copper wire complying with 600 V and 20 A standard	6 mm–9 mm	4 mm ² –6 mm ²
2	Ethernet cable	CAT 5E outdoor shielded network cable	4.8 mm–6 mm	8 * (0.08–0.2) mm ²
3	Meter RS485 cable ⁽¹⁾	Shielded twisted pair	4.8 mm–6 mm	2 * (0.5–1.0) mm ²
4	AC cable ⁽²⁾	Outdoor 3-core copper wire cable	10 mm–21 mm	4 mm ² –6 mm ²
5	Additional Grounding cable	Outdoor single-core copper wire cable	4 mm –8 mm	4 mm ² –6 mm ²

(1) The cable requirements for **COM2** terminal connection are the same.

(2) All the AC wires should be equipped with correctly colored cables for distinguishing. Please refer to related standards about the wiring color.



It is recommended to use heavy duty conduits when run cables through Cavity walls, or lay out cables with corresponding conduits. (For “AU” and “NZ”)

5.4 External Grounding Connection

DANGER

Electric shock!

- **Make sure that the ground cable is connected reliably. Otherwise, it may cause electric shock.**

⚠ WARNING

- Since the inverter is not equipped with a transformer, neither the negative electrode nor the positive electrode of the PV string can be grounded. Otherwise, the inverter will not operate normally.
- Connect the grounding terminal to the protective grounding point before AC cable connection, PV string connection, and communication cable connection.
- The ground connection of this additional grounding terminal cannot replace the connection of the PE terminal of the AC cable. Make sure those terminals are both grounded reliably. SUNGROW shall not be held liable for any damage caused by the violation.

5.4.1 External Grounding Requirements

All non-current carrying metal parts and device enclosures in the PV power system should be grounded, for example, brackets of PV modules and inverter enclosure.

When there is only one inverter in the PV system, connect the external grounding cable to a nearby grounding point.

When there are multiple inverters in the PV system, connect grounding points of all inverters and the PV array frames to the equipotential cable (according to the onsite conditions) to implement an equipotential connection.

5.4.2 Connection Procedure

Additional grounding cable and OT/DT terminal are prepared by customers.

step 1 Prepare the cable and OT/DT terminal.

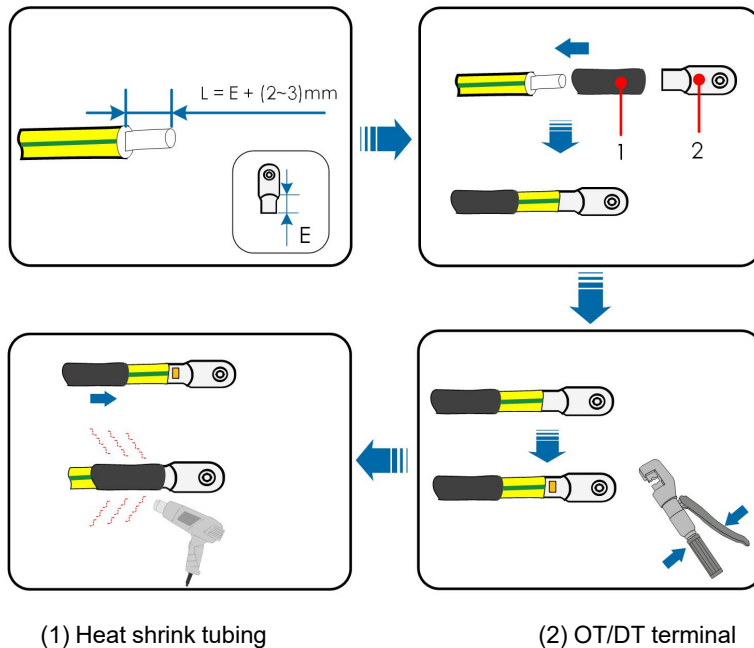

step 2 Remove the screw on the grounding terminal and fasten the cable with a screwdriver.

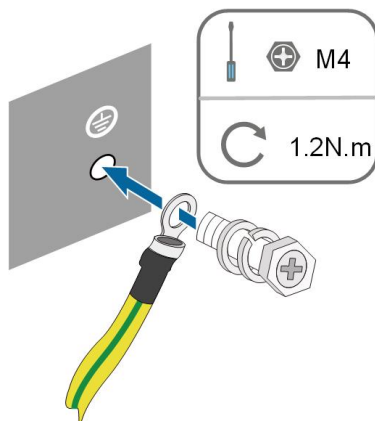

S000-E063

step 3 Apply paint to the grounding terminal to ensure corrosion resistance.

-- End

5.5 AC Cable Connection

5.5.1 AC Side Requirements



Only with the permission of the local grid department, the inverter can be connected to the grid.

Before connecting the inverter to the grid, ensure the grid voltage and frequency comply with requirements, for which, refer to "**Technical Data**". Otherwise, contact the electric power company for help.

AC Circuit Breaker

An independent two-pole circuit breaker must be installed on the output side of the inverter to ensure safe disconnection from the grid. The recommended specifications are as follows.

Inverter Model	Recommended Specification
SG2.0RS-S/SG2.5RS-S/SG3.0RS-S	25 A
SG3.0RS/SG3.6RS/SG4.0RS/SG5.0RS	32 A
SG6.0RS	40 A

⚠ WARNING

AC circuit breakers should be installed on the output side of the inverter and the grid side to ensure safe disconnection from the grid.

- **Determine whether an AC circuit breaker with greater overcurrent capacity is required based on actual conditions.**
- **Do not connect any local load between the inverter and the AC circuit breaker.**
- **Multiple inverters cannot share one AC circuit breaker.**

Residual Current Monitoring Device

With an integrated universal current-sensitive residual current monitoring unit included, the inverter will disconnect immediately from the mains power once a fault current with a value exceeding the limit is detected.

However if an external residual current device (RCD) (type A is recommended) is mandatory, the switch must be triggered at a residual current of 300 mA (recommended). RCD of other specifications can also be used according to local standard.

In Australia, a RCD is not required according to the local standard AS3000-2018 when either of the following installation methods is adopted if the PV array capacitance to ground is large (such as a tin roof):

- Use heavy duty conduits (such as metal bushing) when run PV and AC cables through Cavity walls.
- Route the PV and AC cables through pipes (PVC or metal tubing), lay the cables and install them.

5.5.2 Assembling the AC Connector

step 1 Unscrew the swivel nut of the AC connector.

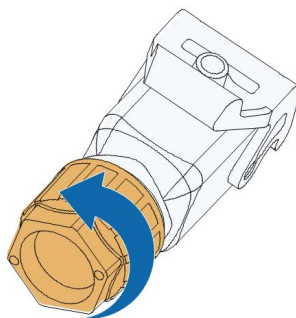

S000-E047

step 2 Thread the AC cable of appropriate length through the swivel nut, the sealing ring and the housing.

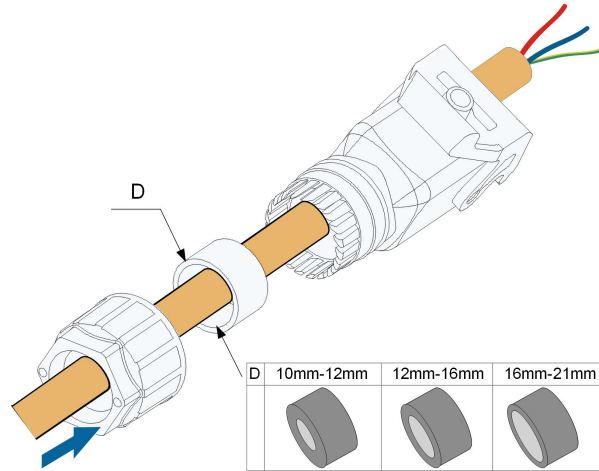

S000-E049

step 3 Remove the cable jacket by less than 45 mm, and strip the wire insulation by 12 mm–16 mm.

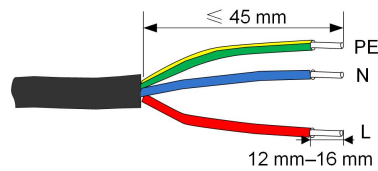

S000-E050

step 4 Open the clamp on the spring-loaded terminal and fully insert the wires into the corresponding holes. Then close the clamp and push the terminal plug into the housing until there is an audible click.

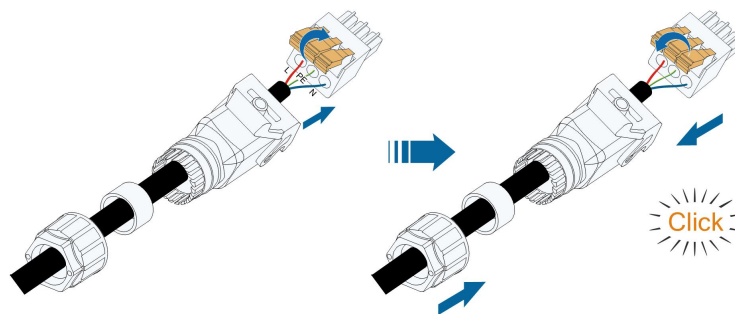

S000-E051

NOTICE

Observe the plug assignment.

- Do not connect the L line to the "PE" terminal or the PE wire to the "N" terminal. Otherwise, unrecoverable damage to the inverter may follow.
- Do not connect the L line and the N line in reverse, otherwise the inverter may not operate normally.

- step 5 Ensure that the wires are securely in place by slightly pulling them. Tighten the swivel nut to the housing.

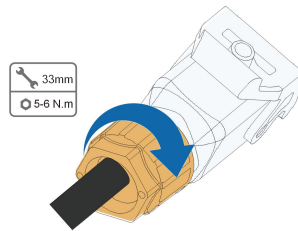

S000-E052

-- End

5.5.3 Installing the AC Connector

⚠ DANGER

High voltage may be present in inverter!

Ensure all cables are voltage-free before electrical connection.

Do not connect the AC circuit breaker until all inverter electrical connections are completed.

- step 1 Disconnect the AC circuit breaker and secure it against reconnection.
- step 2 Lift the locking part upwards and insert the AC connector into the **GRID** terminal on the bottom side of the inverter. Then press the locking part and lock it with the screw.

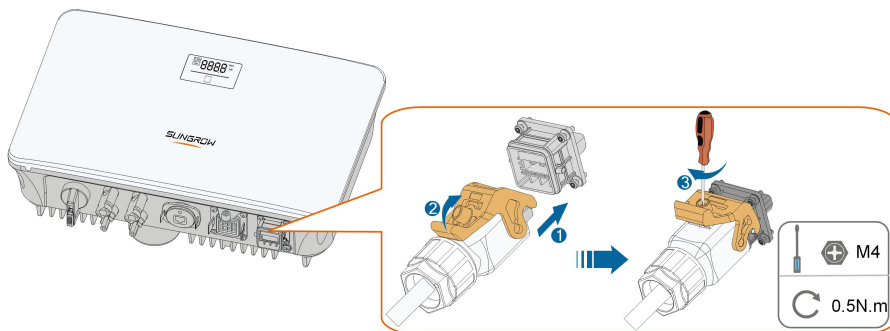

S005-E006

- step 3 Connect the PE wire to ground and the phase lines and the "N" line to AC circuit breaker. Then Connect the AC circuit breaker to electric board.
- step 4 Make sure all wires are firmly installed via the right torque tool or dragging the cables slightly.

-- End

5.6 DC Cable Connection

⚠ DANGER

The PV string will generate lethal high voltage when exposed to sunlight.
Respect all safety instructions listed in relevant documents about PV strings.

⚠ WARNING

- Make sure the PV array is well insulated to ground before connecting it to the inverter.
- Make sure the maximum DC voltage and the maximum short circuit current of any string never exceed inverter permitted values specified in "Technical Data".
- Check the positive and negative polarity of the PV strings, and connect the PV connectors to corresponding terminals only after ensuring polarity correctness.
- During the installation and operation of the inverter, please ensure that the positive or negative electrodes of PV strings do not short-circuit to the ground. Otherwise, an AC or DC short-circuit may occur, resulting in equipment damage. The damage caused by this is not covered by the warranty.
- Electric arc or contactor over-temperature may occur if the PV connectors are not firmly in place, and SUNGROW shall not be held liable for any damage caused.
- If the DC input cables are reversely connected and the DC switch has been rotated to "ON", do not operate immediately. Otherwise, the inverter may be damaged. Please turn the DC switch to "OFF" and remove the DC connector to adjust the polarity of the strings when the string current is lower than 0.5A.

NOTICE

The following requirements about PV string connection must be met. Otherwise, it may cause irreversible damage to the inverter, which is not covered by the warranty.

- Mixed use of different brand or model of PV modules in one MPPT circuit, or PV modules of different orientation or angles in a string may not damage inverter but will cause system bad performance!
- The inverter enters standby state when the input voltage ranges between 560 V and 600 V. The inverter returns to running state once the voltage returns to the MPPT operating voltage range, namely, 40 V to 560 V.

5.6.1 PV Input Configuration

- The inverters SG2.0RS-S / SG2.5RS-S / SG3.0RS-S have one PV input with one MPP tracker.

- The inverters SG3.0RS / SG3.6RS / SG4.0RS / SG5.0RS / SG6.0RS have two PV inputs, each with independent MPP tracker. Each DC input area can operate independently.
- The PV strings to the same DC input area should have the same type, the same number of PV panels, identical tilt and identical orientation for maximum power.
- The PV strings to two DC input areas may differ from each other, including PV module type, number of PV modules in each string, angle of tilt, and installation orientation.

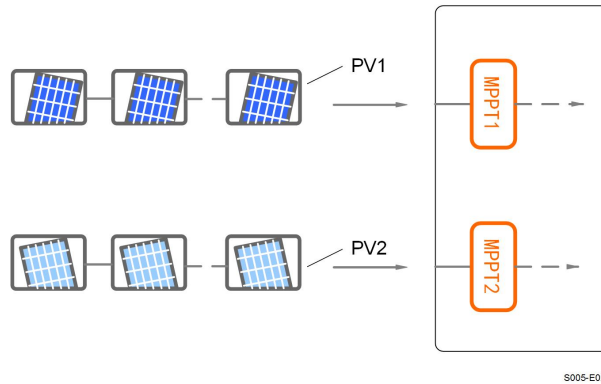

figure 5-3 PV Input Configuration (SG6.0RS for example)

Prior to connecting the inverter to PV inputs, the specifications in the following table should be met:

Inverter Model	Open-circuit Voltage Limit	Max. current for input connector
All models	600 V	20 A

5.6.2 Assembling the PV Connectors

⚠ DANGER

High voltage may be present in the inverter!

- **Ensure all cables are voltage-free before performing electrical operations.**
- **Do not connect the DC switch and AC circuit breaker before finishing electrical connection.**

i To ensure IP65 protection, use only the supplied connector.

step 1 Strip the insulation from each DC cable by 7 mm–8 mm.

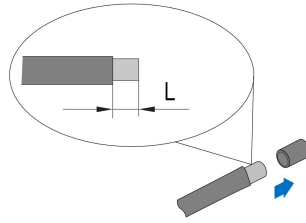

step 2 Assemble the cable ends with the crimping pliers.

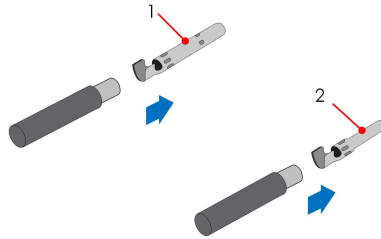

1: Positive crimp contact

2: Negative crimp contact

step 3 Lead the cable through cable gland, and insert the crimp contact into the insulator until it snaps into place. Gently pull the cable backward to ensure firm connection. Tighten the cable gland and the insulator (torque 2.5 N.m to 3 N.m).

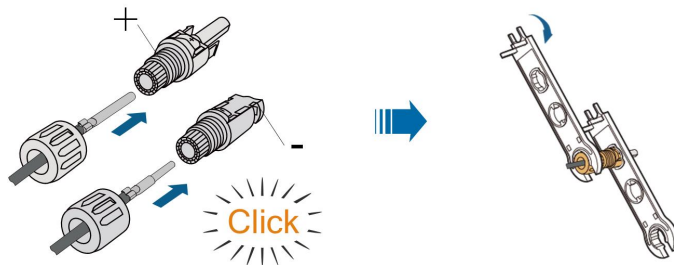

step 4 Check for polarity correctness.

NOTICE

If the PV polarity is reversed, the inverter will be in a fault or alarm state and will not operate normally.

-- End

5.6.3 Installing the PV Connectors

step 1 Rotate the DC switch to "OFF" position.

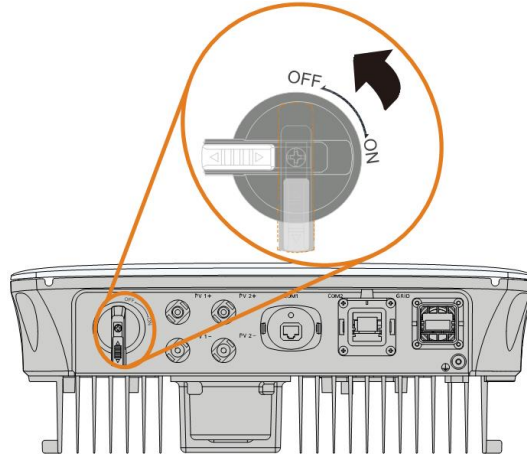

S005-E032

- step 2 Check the cable connection of the PV string for polarity correctness and ensure that the open circuit voltage in any case does not exceed the inverter input limit of 600 V.

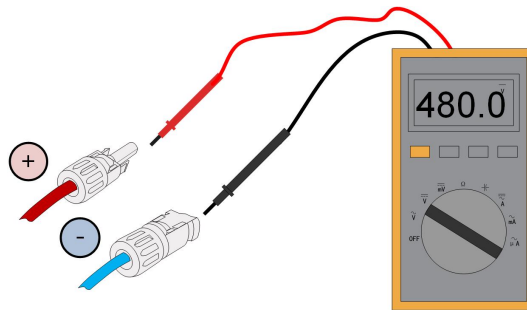

- step 3 Connect the PV connectors to corresponding terminals until there is an audible click.

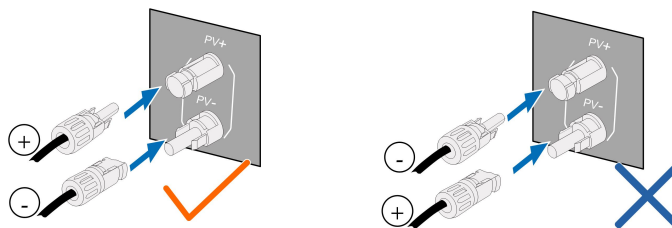

- step 4 Seal the unused PV terminals with the terminal caps.

-- End

5.7 WiNet-S Connection

The WiNet-S module supports Ethernet communication and WLAN communication. It is not recommended to use both communication methods at the same time.

For details, see the quick guide for the WiNet-S module. Scan the following QR code for the quick guide.



5.7.1 Ethernet Communication

step 1 **(Optional)** Strip the insulation layer of the communication cable with an Ethernet wire stripper, and lead the corresponding signal cables out. Insert the stripped communication cable into the RJ45 plug in the correct order, and crimp it with a crimper.

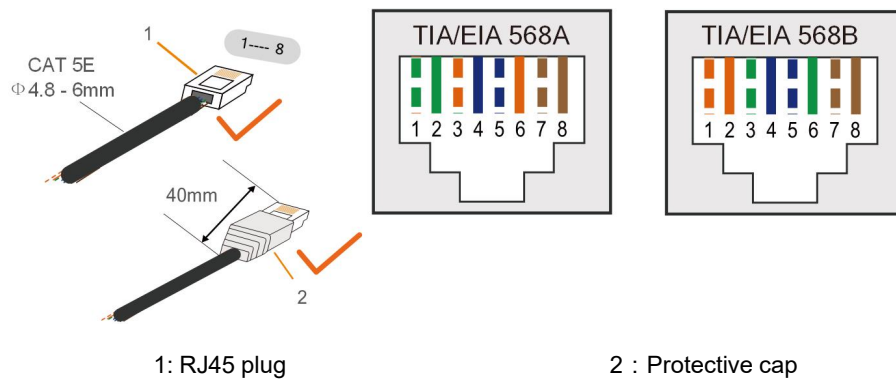

Skip this step if a standard network cable with RJ45 plug is prepared.

step 2 Unscrew the swivel nut from the communication module and take out the inner sealing ring.

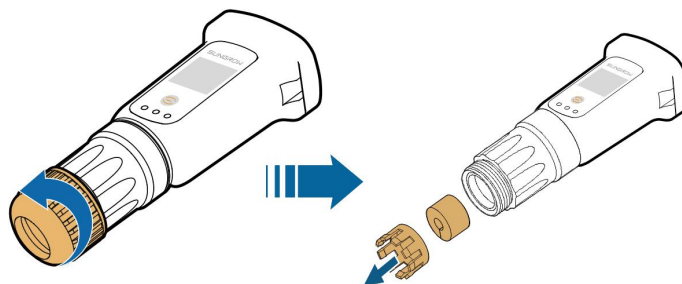

step 3 Unscrew the housing from the communication module.

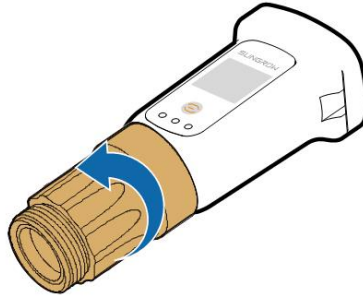

step 4 Thread the network cable through the swivel nut and gasket. Afterwards, route the cable into the opening of the sealing. Finally, insert the cable through the housing.

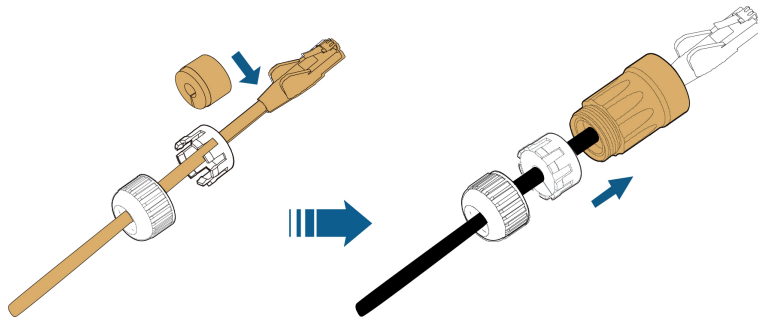

step 5 Insert the RJ45 plug into the front plug connector until there is an audible click and tighten the housing. Install the gasket and fasten the swivel nut.

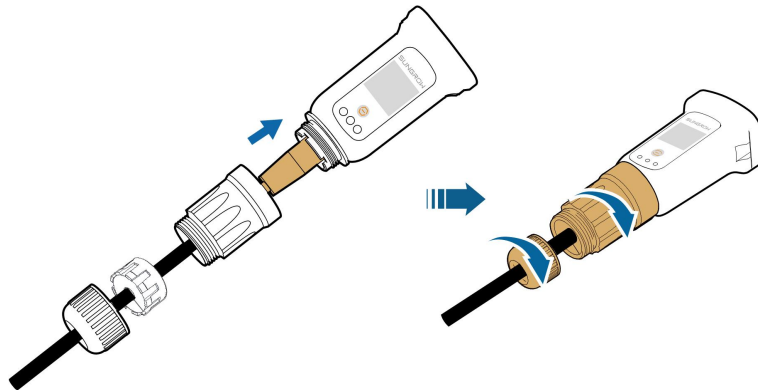

step 6 Remove the waterproof lid from the **COM1** terminal and install WiNet-S.

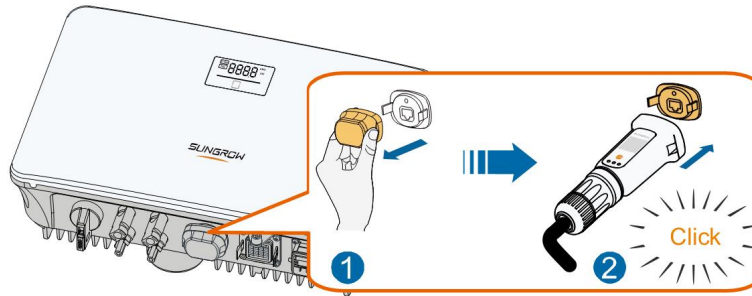

S005-E041

step 7 Slightly shake it by hand to determine whether it is installed firmly.

-- End

5.7.2 WLAN Communication

step 1 Remove the waterproof lid from the **COM1** terminal.

step 2 Install the module. Slightly shake it by hand to determine whether it is installed firmly, as shown below.

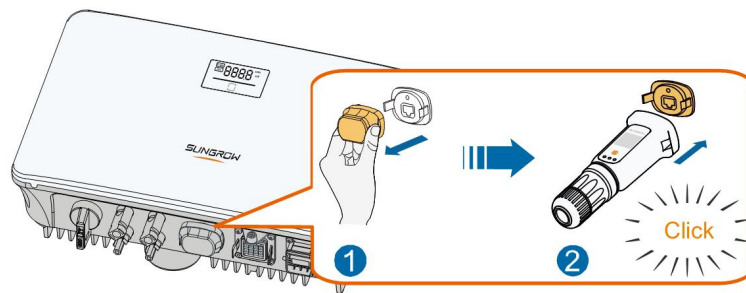

S005-E042

step 3 Refer to the guide delivered with the module for the set-up.

-- End

5.8 Smart Meter Connection

step 1 Unscrew the swivel nut from the communication connector.

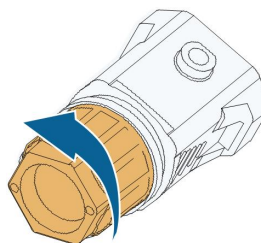

S005-E007

step 2 Remove the seal and lead the cable through the cable gland.

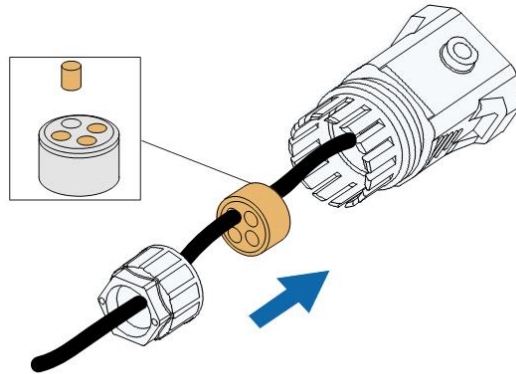

S005-E008

step 3 Remove the cable jacket and strip the wire insulation.

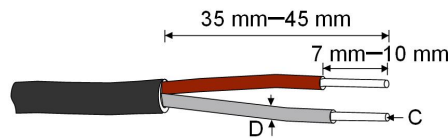

C = 0.5 mm² : D ≤ 2.6 mm
 C = 1.0 mm² : D ≤ 2.8 mm

S005-E044

step 4 (Optional) When using a multi-core multi-strand wire cable, connect the wire head to the cord end terminal. In case of single-strand copper wire, skip this step.

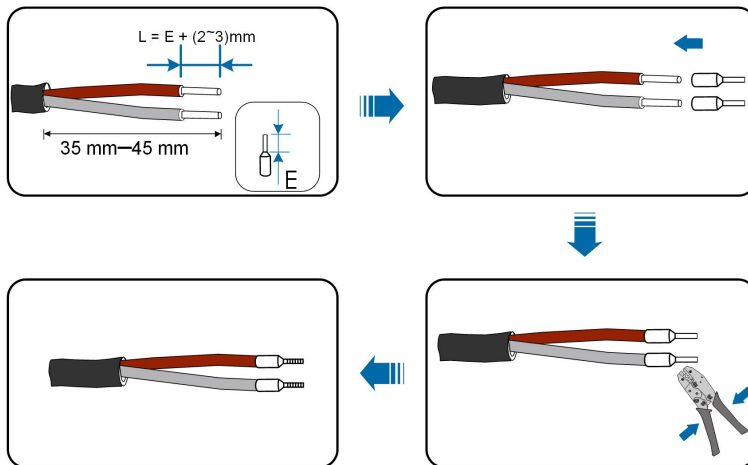

S005-E045

step 5 Plug the wires into the corresponding terminals as shown in the following figure. Ensure that the wires are securely in place by slightly pulling them.

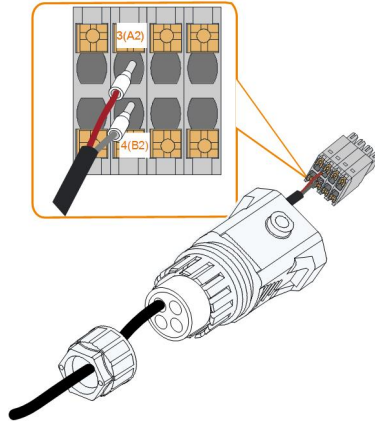

S005-E009

step 6 Insert the terminal plug into the **COM2** terminal at the bottom side of the inverter and then install the housing.

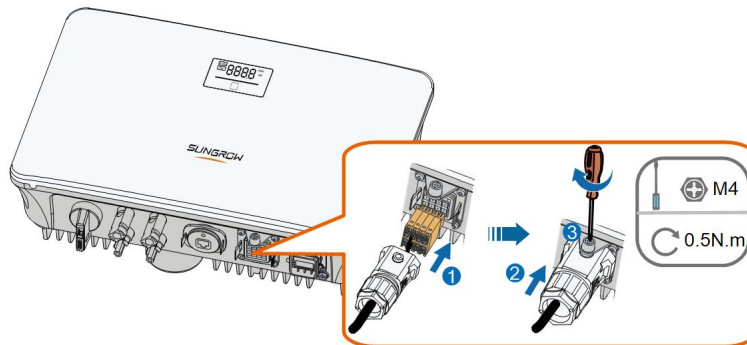

S005-E010

step 7 Slightly pull out the cable and then fasten the swivel nut. Lock the connector with the screw.

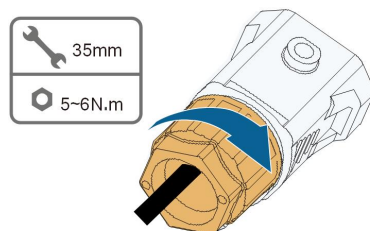

S005-E011

-- End

5.9 DRM Connection

In Australia and New Zealand, the inverter supports DRM0 as specified in the standard AS/NZS 4777.

The DRM0 mode is asserted by shorting terminals **R** and **C** on the inverter.

step 1 Unscrew the swivel nut from the communication connector.

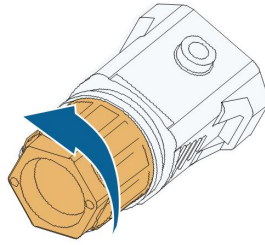

S005-E007

step 2 Remove the seal and lead the cable through the cable gland.

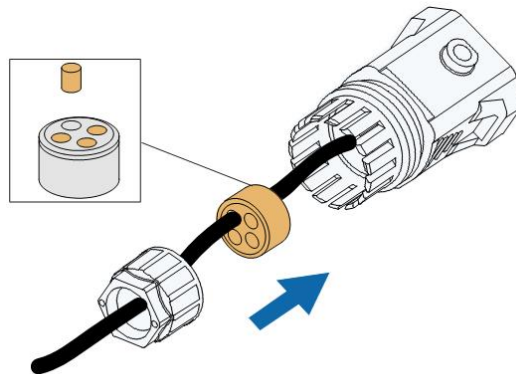

S005-E008

step 3 Remove the cable jacket and strip the wire insulation.

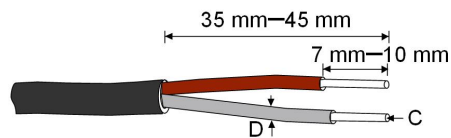

$$C = 0.5 \text{ mm}^2 : D \leq 2.6 \text{ mm}$$

$$C = 1.0 \text{ mm}^2 : D \leq 2.8 \text{ mm}$$

S005-E044

step 4 (Optional) When using a multi-core multi-strand wire cable, connect the wire head to the cord end terminal. In case of single-strand copper wire, skip this step.

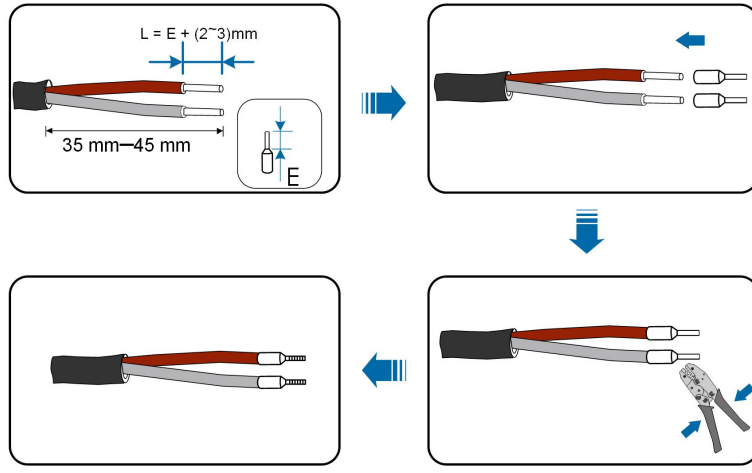

S005-E045

step 5 Plug the wires into the corresponding terminals as shown in the following figure. Ensure that the wires are securely in place by slightly pulling them.

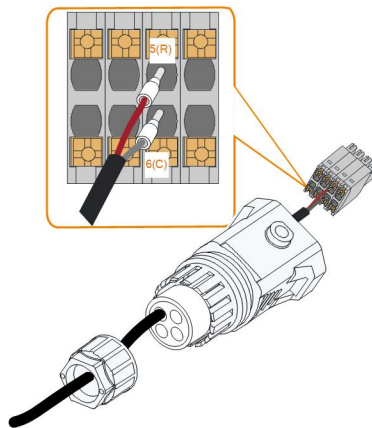

S005-E012

step 6 Insert the terminal plug into the **COM2** terminal at the bottom side of the inverter and then install the housing.

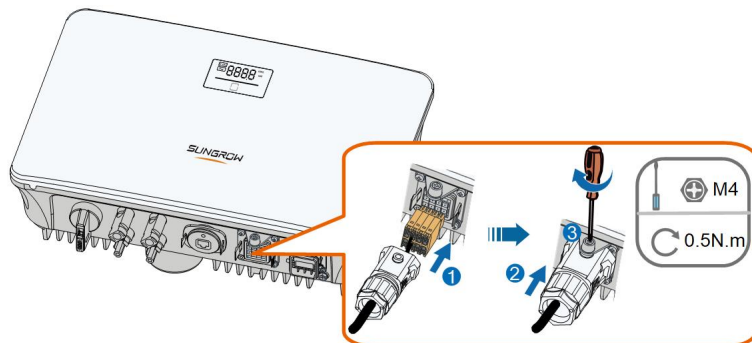

S005-E010

step 7 Slightly pull out the cable and then fasten the swivel nut. Lock the connector with the screw.

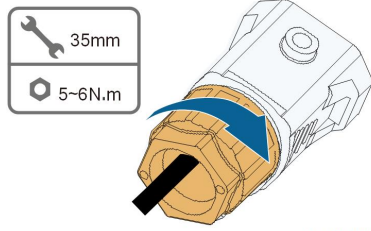

-- End

6 Commissioning

6.1 Inspection before Commissioning

Check the following items before starting the inverter:

- All equipment has been reliably installed.
- DC switch(es) and AC circuit breaker are in the "OFF" position.
- The ground cable is properly and reliably connected.
- The AC cable is properly and reliably connected.
- The DC cable is properly and reliably connected.
- The communication cable is properly and reliably connected.
- The vacant terminals are sealed.
- No foreign items, such as tools, are left on the top of the machine or in the junction box (if there is).
- The AC circuit breaker is selected in accordance with the requirements of this manual and local standards.
- All warning signs & labels are intact and legible.

6.2 Powering on the System

If all of the items mentioned above meet the requirements, proceed as follows to start up the inverter for the first time.

- step 1 Turn on the AC circuit breaker between the inverter and the grid.
- step 2 Rotate the DC switch of the inverter to "ON" position.
- step 3 Turn on the external DC switch (if applicable) between the inverter and the PV string.
- step 4 If the irradiation and grid conditions meet requirements, the inverter will operate normally. Observe the LED indicator to ensure that the inverter operates normally. Refer to "[2.4 LED Panel](#)" for LED screen introduction and LED indicator definition.
- step 5 Refer to the quick guide for WiNet-S for its indicator definition.

-- End

6.3 App Preparation

- step 1 Install the iSolarCloud App with latest version. Refer to "[7.2 Installing the App](#)".

- step 2 Register an account. Refer to "[7.3 Account Registration](#)". If you have got the account and password from the distributor/installer or SUNGROW, skip this step.
- step 3 Download the firmware package to the mobile device in advance. Refer to "Firmware Update". This is to avoid download failure due to poor on-site network signal.

-- End

6.4 Creating a Plant

Screenshots of creating a plant are for reference only. For details, refer to the actual screen.

- step 1 Open the App, tap  at the upper right corner and tap **Select Server**. Choose the same server as when registering.

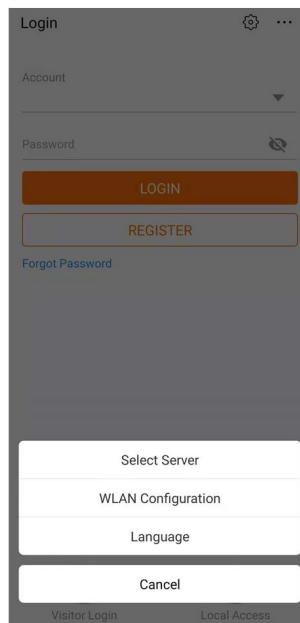



figure 6-1 Selecting the Server

- step 2 Enter the account and password on the login screen and tap **Login** to enter the App home screen.
- step 3 Tap the icon  at the upper right corner to enter the creating screen.

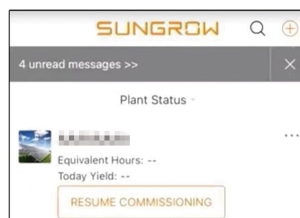

figure 6-2 Creating Power Plant

- step 4 Select plant type to **RESIDENTIAL** and inverter type to **PV**.



figure 6-3 Selecting Plant/Inverter Type

step 5 Scan the QR code on the communication device or manually enter the serial number of the communication device. Tap **Next** after the QR code is identified or the serial number entered is correct and then tap **CONFIRM**. Your mobile device is thus connected to the WiNet-S successfully.

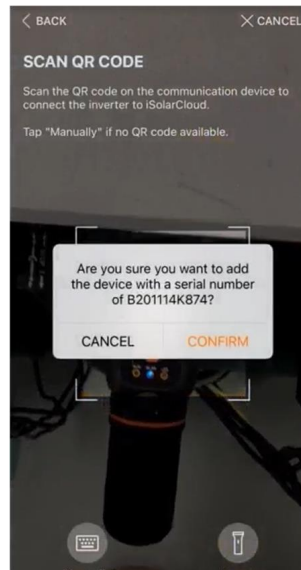

figure 6-4 Connecting Mobile Device to WiNet-S

step 6 Select the Internet access mode to **WLAN** or **ETHERNET** according to actual connection. The following description is for WLAN access mode.



figure 6-5 Selecting Internet Access Mode

step 7 The **EASYCONNECT INSTRUCTION** screen will prompt. Press the multi-function button on the WiNet-S module once to turn on EasyConnect mode. The WLAN indicator on WiNet-S

blinks quickly when this mode is turned on. Return to the App and the screen displays successful connection to the inverter WLAN. Tap **NEXT**.

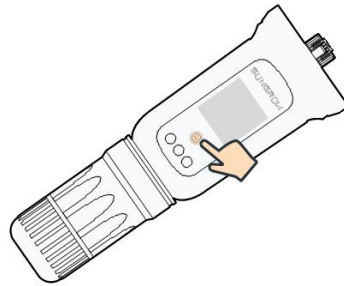

figure 6-6 Turn on EasyConnect Mode

NOTICE

**The EasyConnect mode can be used only when the router is 2.4 GHz.
If the EasyConnect mode fails, refer to the WiNet-S quick guide for the instructions of other modes.**

step 8 Connect the inverter to router network. Enter network name and password. Tap **NEXT** and the screen display prompt information of successful connection to the router network.

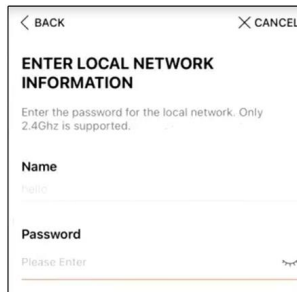

figure 6-7 Connecting Inverter to Router Network

-- End

6.5 Initializing the Device

The inverter is successfully connected to the router.

If there is no latest equipment upgrade package, skip steps 1 and 2.

The actual initializing procedure may differ due to different countries. Please follow the actual App guidance.

step 1 If a latest equipment upgrade package is available, the following prompt window pops up. Tap **UPDATE NOW** to download the latest update package.

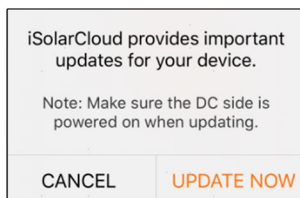

figure 6-8 Upgrade Reminder

step 2 After download, it would take around 15 minutes to update. After successful upgrade, the screen will show the version numbers before and after the upgrade as well as the upgrade time. Tap **NEXT**.

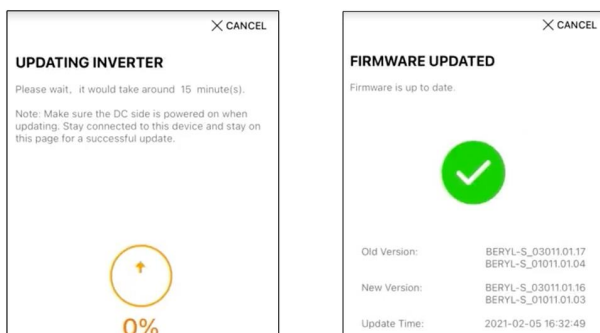

figure 6-9 Upgrading Inverter

NOTICE

If the communication equipment is upgraded, after successful upgrade, check and confirm that the phone is connected to the inverter WLAN.

step 3 Tap **Country/Region** and select the country where the inverter is installed at. The supported countries and corresponding settings are as follows.

Country/Region	Setting
Belgium ("BE")	Belgium
Netherlands ("NL")	Netherlands
Portugal / Turkey / Hungary / Romania / Greece / Lithuania	EN50549-1, with proper manual settings
Poland ("PL")	Poland
United Kingdom	United Kingdom
	United Kingdom_G98
France	France
Italy	Italy

Country/Region	Setting
Spain	Spain
Australia ("AU")	Australia
New Zealand ("NZ")	New Zealand
Countries not listed above	Other 50Hz or Other 60Hz

NOTICE

The parameter Country/Region must be set to the country (region) where the inverter is installed at. Otherwise, the inverter may report errors.

step 4 When the country is set to Australia, additionally set the applicable network service provider and then the grid type.

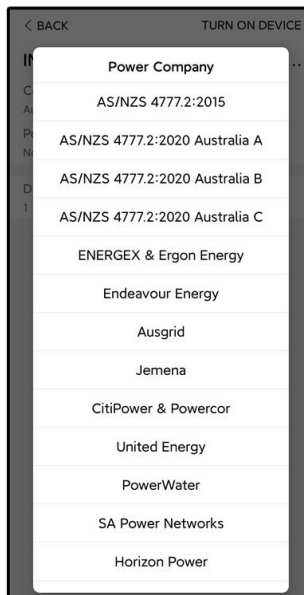

The image shown here is for reference only. Refer to the actual interface for the supported network service providers.

table 6-1 Description of Network Service Provider and Grid Type

Network Service Provider	Grid Type
AS/NZS 4777.2:2015	/
AS/NZS 4777.2:2020	/
Australia A	/
AS/NZS 4777.2:2020	/
Australia B	/

Network Service Provider	Grid Type
AS/NZS 4777.2:2020 Australia C	/
ENERGEX & Ergon Energy	<ul style="list-style-type: none"> • STNW1170: single-phase < 10 kVA & three-phase < 30 kVA • STNW1174: 30 kVA < $P_n \leq 1500$ kVA
Jemena	<ul style="list-style-type: none"> • ≤ 10 kVA per phase (or 30 kVA per three phase) • ELE GU 0014: 30 kVA–200 kVA
Endeavour Energy	MDI 0043
Ausgrid	NS194
CitiPower & Powercor	<ul style="list-style-type: none"> • ≤ 5 kVA for single-phase & 30 kVA for three-phase • > 30 kVA three-phase
United Energy	<ul style="list-style-type: none"> • UE-ST-2008.1: ≤ 10 kVA for single-phase & 30 kVA for three-phase • UE-ST-2008.2: > 30 kVA three-phase
PowerWater	Embedded Generation Notice Photovoltaic Systems:2020
SA Power Networks	<ul style="list-style-type: none"> • TS129-2019: < 10 kW for single-phase & 30 kW for three-phase • TS130-2017: > 30 kW & ≤ 200 kW • TS131-2018: > 200 kW
Horizon Power	<ul style="list-style-type: none"> • HPC-9DJ-13-0001-2019: ≤ 10kVA for single-phase & 30 kVA for three-phase • HPC-9DJ-13-0002-2019: > 30kVA & ≤ 1MVA
westernpower	EDM # 33612889-2019
AusNet Services	Basic Micro Embedded Generation: 2020

* For compliance with AS/NZS 4777.2:2020, please select from Australia A/B/C. Please contact your electricity grid operator for which region to use.

step 5 Initialize parameters according to local grid requirements, including grid type, reactive power regulation mode, etc. The screen displays that the inverter is successfully configured.

figure 6-10 Initializing Parameters

-- End

6.6 Configuring the Plant

The inverter is successfully added to the plant and initialized. Refer to the guidance in previous sections.

The distributor/installer who creates a plant for the end user needs to get the end user's e-mail address. In configuring a plant, the e-mail address is required, and each e-mail address can be registered only once.

step 1 The App screen will display the added inverter. Tap **NEXT** to configure the plant.

figure 6-11 Display the Added Inverter

step 2 Fill in the plant information. The fields marked with * must be filled in.

figure 6-12 Entering Plant Information

step 3 **(Optional)** Fill in the tariff information. The electricity price can be set to a specific value or Time-of-Use tariff.

figure 6-13 Entering Tariff Information

step 4 Fill in the end user's e-mail address. The first time you fill in the end user's e-mail address, the system will create an account for the end user and send an email to the end user. The end user can activate the account via the email.



The Distributor/installer creates plants for the end user and can manage the plants by default.

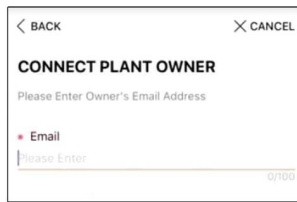

figure 6-14 Entering Owner's e-mail

step 5 Tap **NEXT** to wait for the inverter to connect to the iSolarCloud.

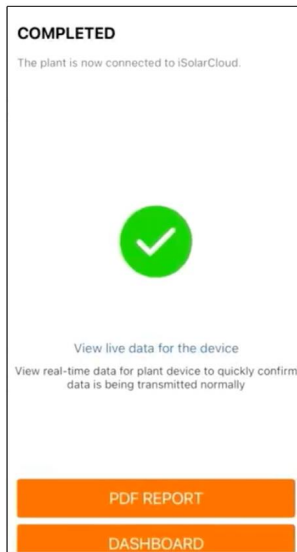

figure 6-15 Configuration Completed

step 6 **(Optional)** Tab **View live data for the device**, tick **Inverter** or **Total Plant Devices** and tab **ALL PLANTS OPEN**. The clock symbol indicates that the live data view function is successfully enabled. Tab the inverter to view the live data about voltage, current, power or curve.

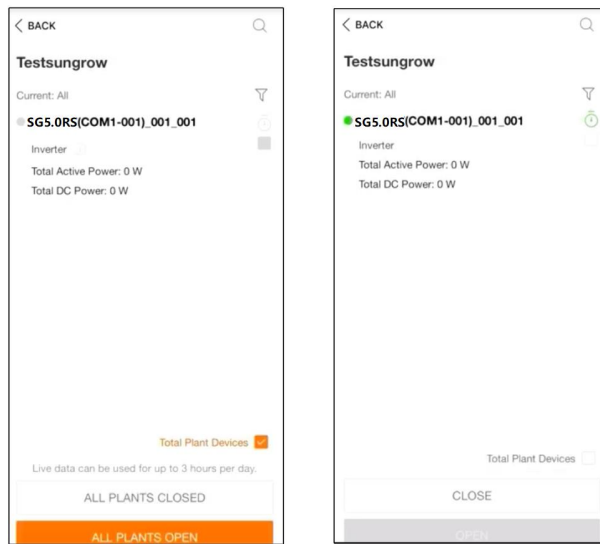

figure 6-16 Live Data View Function Setting



Contact Sungrow service to enable live data function of devices. Once enabled, live data function is available for 3 hours per day by default. To make it available for 24 hours, contact SUNGROW.

step 7 Tab **BACK** to the **COMPLETED** screen. Tab **PDF REPORT** to export the plant configuration report.

step 8 Tab **BACK** to the **COMPLETED** screen. Tab **DASHBOARD** to return and manually refresh the page until the newly created plant is displayed with status commissioned.

-- End

7 iSolarCloud App

7.1 Brief Introduction

The iSolarCloud App can establish communication connection to the inverter via the WLAN, providing remote monitoring, data logging and near-end maintenance on the inverter. Users can also view inverter information and set parameters through the App.

* To achieve direct login via WLAN, the wireless communication module developed and manufactured by SUNGROW is required. The iSolarCloud App can also establish communication connection to the inverter via Ethernet connection.



- This manual describes only how to achieve near-end maintenance via WLAN direct connection.
- Screenshots in this manual are based on the V2.1.6 App for Android system, and the actual interfaces may differ.

7.2 Installing the App

Method 1

Download and install the App through the following application stores:

- MyApp (Android, mainland China users)
- Google Play (Android, users other than mainland China ones)
- App Store (iOS)

Method 2

Scan the following QR code to download and install the App according to the prompt information.



The App icon appears on the home screen after installation.



7.3 Account Registration

The account distinguishes two user groups, end user and distributor/installer.

- The end user can view plant information, create plants, set parameters, share plants, etc.
- The distributor/installer can help the end user to create plants, manage, install, or maintain plants, and manage users and organizations.

step 1 Tap **REGISTER** to enter the registration screen.

A screenshot of the 'USER REGISTRATION' screen. At the top, it says 'USER REGISTRATION'. Below that is a section titled 'Account Type' with a dropdown menu. Underneath is a note: 'Please select the relevant server for your area; if not available, please select the international station'. There are two orange buttons: 'Distributor/Installer' and 'End User'. Below the 'Distributor/Installer' button is a description: 'Distributor/Installer is the person who install or/and manage the plant, and supply service to end user'. Below the 'End User' button is a description: 'End User is the person who will own or has owned one inverter or more'.

step 2 Select the relevant server for your area.

step 3 Select **End user** or **Distributor/Installer** to enter the corresponding screen.

DISTRIBUTOR/INSTALLER

Email @gmail.com *

[Send Verification Code](#)

Verification Code *

Password *

Confirm Password *

Country/Region *

Company Name

Code of Upper Level Installer/Distributor

[Accept Privacy Policy](#)

step 4 Fill in the registration information, including email, verification code, password and affirmation and country (region). The distributor/installer has the permission to fill in the company name and the code of upper level distributor/installer.



The code of upper level distributor/installer can be obtained from the upper level distributor/installer. Only when your organization belongs to the upper level distributor/installer organization, can you fill in the corresponding code.

step 5 Tick **Accept privacy protocol** and tap **Register** to finish the registration operation.

-- End

7.4 Login

7.4.1 Requirements

The following requirements should be met:

- The AC or DC side of the inverter is powered-on.
- The WLAN function of the mobile phone is enabled.
- The mobile phone is within the coverage of the wireless network produced by the communication module.

7.4.2 Login Procedure

step 1 For the WiNet-S module, press the multi-function button 3 times to enable the WLAN hotspot. No password is required and the valid time is 30 minutes.

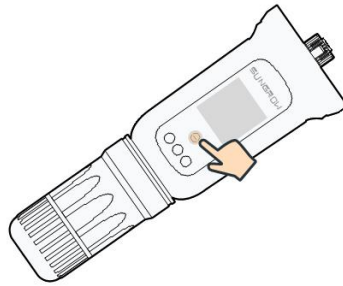

figure 7-1 Enabling the WLAN Hotspot

- step 2 Connect the mobile phone to the WLAN network named as "SG-xxxxxxxxxx" (xxxxxxxxxx is the serial number indicated on the side of the communication module).
- step 3 Open the App to enter the login screen. Tap **Local Access** to enter the next screen.
- step 4 Select **WLAN** and select the device (SN), then enter the password and tap **LOGIN**.



- If the WiFi signal, serial number or inverter related data information cannot be found, unplug and reinsert the Winet-S or press the multi-function button of the Winet-S three times.
- The default account is "user" and the initial password is "pw1111" which should be changed for the consideration of account security. Tap "More" at the lower right corner on home page and choose "Change Password".

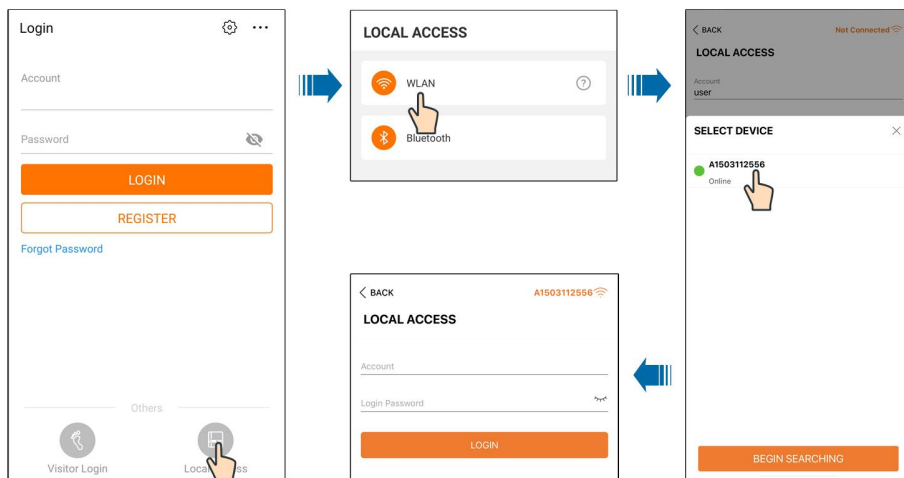

figure 7-2 WLAN Local Access

- step 5 If the inverter is not initialized, navigate to the quick setting screen to initialize the protection parameters. For details, please refer to "**Initial Settings**".

NOTICE

The "Country/Region" must be set to the country where the inverter is installed at. Otherwise, the inverter may report errors.

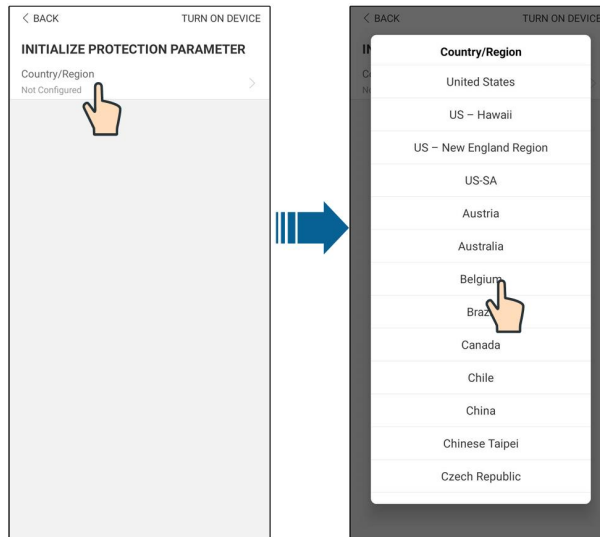

figure 7-3 WLAN Local Access

- step 6 After finishing the settings, tap **TUNR ON DEVICE** at the upper right corner and the device will be initialized. The App will send start instructions and the device will start and operate.
- step 7 After initialization settings, the App will return automatically to the home page.

- - End

7.5 Initial Settings

Tap **Country/Region** and select the country where the inverter is installed. For countries except Australia and Germany, the initialization is completed.



i The actual initializing procedure may differ due to different countries. Please follow the actual App guidance.

For some countries, you should initialize parameters according to local grid requirements. For details, see "[6.5 Initializing the Device](#)".

7.6 Function Overview

The App provides parameter viewing and setting functions, as shown in the following figure.

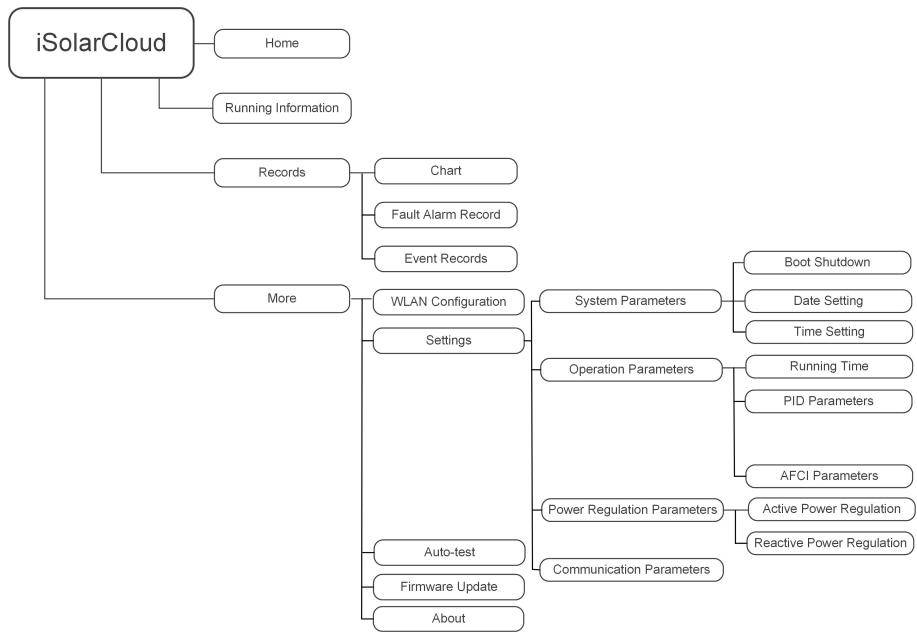

figure 7-4 App Key Function Menu

7.7 Home

Home page of the App is shown in the following figure.

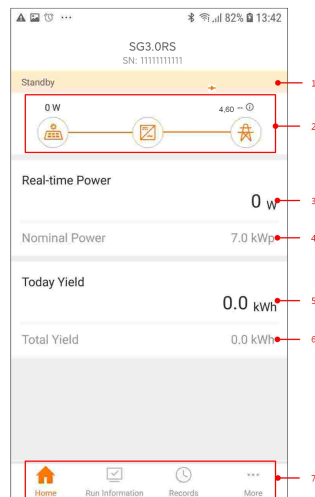



figure 7-5 Home

table 7-1 Home Page Description

No.	Name	Description
1	Inverter state	Present operation state of the inverter
2	Energy flow chart	Shows the PV power generation power, feed-in power, etc. The line with an arrow indicates energy flow between connected devices, and the arrow pointing indicates energy flow direction.
3	Real-time power	Shows the present output power of the inverter.
4	Nominal power	Shows the installed power of the inverter.
5	Today yield	Shows today power generation of the inverter
6	Total yield	Shows accumulative power generation of the inverter
7	Navigation bar	Includes menus of " Home ", " Run Information ", " Records " and " More ".

If the inverter runs abnormally, the fault icon  will appear on the upper left corner of the screen. Users can tap the icon to view detailed fault information and corrective measures.

7.8 Run Information

Tap **Run Information** on the navigation bar to enter the screen showing running information, slide the screen upwards to view all detailed information.

table 7-2 Description of Run Information

Item	Description
PV information	Shows voltage and current of every PV string.
Inverter information	Shows basic information such as running state, on-grid running time, negative voltage to grid, bus voltage, internal air temperature, inverter efficiency, etc.
Input	Shows total DC power, voltage and current of MPPT1 and MPPT2.
Output	Shows daily/monthly/annual/total yield, total active/reactive/apparent power, total power factor, grid frequency, phase voltage and current.
Grid information	Shows daily/total feed-in energy, daily/total purchased energy.

7.9 Records

Tap **Records** on the navigation bar to enter the screen showing event records, as shown in the following figure.

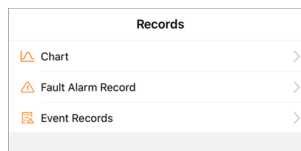

figure 7-6 Records

Chart

Tap **Chart** to enter the screen showing daily power generation, as shown in the following figure.

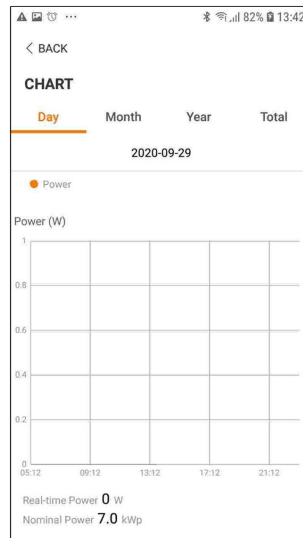

figure 7-7 Chart

The App displays power generation records in a variety of forms, including daily power generation graph, monthly power generation histogram, annual power generation histogram and total power generation histogram.

table 7-3 Description of Power Curve

Item	Description
Daily	Daily curve that indicates the real-time power.
Month	Monthly curve that indicates daily yield and equivalent hours in a month.
Year	Annual curve that indicates monthly yield and equivalent hours in a year.
Total	A curve that indicates annual yield and equivalent hours since installation.

Fault Alarm Record

Tap **Fault Alarm Record** to enter the screen, as shown in the following figure.

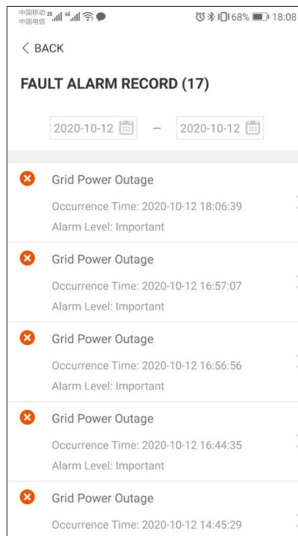



figure 7-8 Fault Alarm Record



Click  to select a time segment and view corresponding records.

Select one of the records in the list and click the record, to view the detailed fault info as shown in following figure.

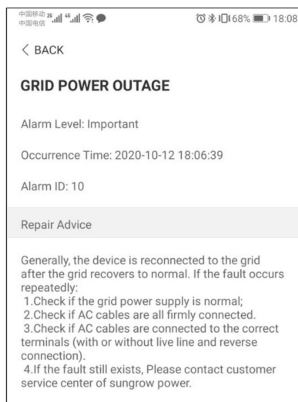

figure 7-9 Detailed Fault Alarm Information

Event Record

Tap **Event Record** to enter the screen, as shown in the following figure.

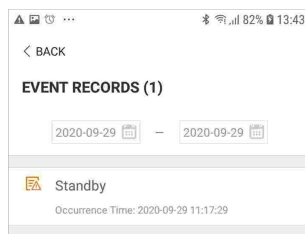



figure 7-10 Event Record



Click  to select a time segment and view corresponding records.

7.10 More

Tap **More** on the navigation bar to enter the corresponding screen, as shown in the following figure.

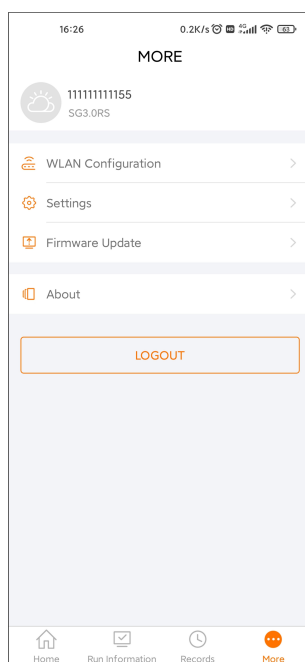

figure 7-11 More

In addition to viewing the WLAN configuration and App software version, the **More** screen supports the following operations:

- Set parameters including inverter system parameters, operation parameters, power regulation parameters and communication parameters.
- Upgrade inverter firmware.

7.10.1 System Parameters

Tap **Settings**→**System Parameters** to enter the corresponding screen, as shown in the following figure.

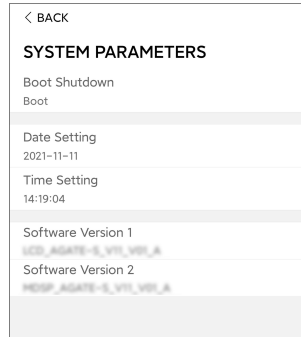

figure 7-12 System Parameters

* The image shown here is for reference only.

Boot/Shutdown

Tap **Boot/Shutdown** to send the boot/shutdown instruction to the inverter.

For Australia and New Zealand, when the DRM state is DRM0, the "Boot" option will be prohibited.

Date Setting/Time Setting

The correct system time is very important. Wrong system time will directly affect the data logging and power generation value. The clock is in 24-hour format.

Software Version

Version information of the current firmware.

7.10.2 Operation Parameters

Running Time

Tap **Settings**→**Operation Parameters**→**Running Time** to enter the corresponding screen, on which you can set "Connecting Time" and "Reconnecting Time".

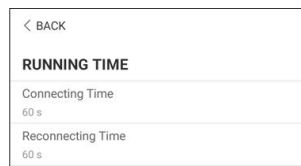

figure 7-13 Running Time

PID Parameters

Tap **Settings**→**Operation Parameters**→**PID Parameters** to enter the corresponding screen, on which you can set "PID Parameters".

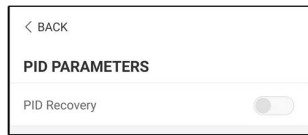

figure 7-14 PID Setting

table 7-4 PID Parameter Description

Parameter	Description
PID Recovery	Set enabling/disabling of the PID night recovery function. PID night recovery function operates between 22:00 pm and 5:00 am by default.

AFCI Parameters(Optional)

Tap **Settings**→**Operation Parameters**→**AFCI Parameters** to enter the corresponding screen, on which you can set "AFCI Parameters".

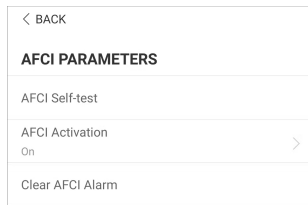

figure 7-15 AFCI Setting

7.10.3 Power Regulation Parameters

Active Power Regulation

Tap **Settings**→**Power Regulation Parameters**→**Active Power Regulation** to enter the screen, as shown in the following figure.

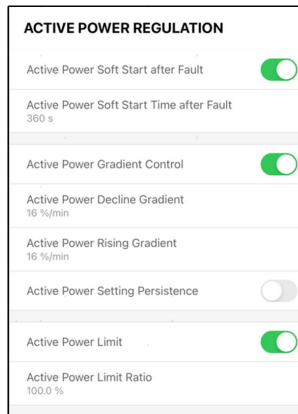

figure 7-16 Active Power Regulation

table 7-5 Description of Active Power Regulation Parameters

Parameter	Description	Range
Active Power Soft Start after Fault	Switch for activating/deactivating the function of active power soft start after a fault occurs	On/Off
Active Power Soft Start Time after Fault	The soft start time required for raising active power from 0 to rated value after a fault occurs	1 s–1200 s
Active Power Gradient Control	Set whether to enable active power gradient control	On/Off
Active Power Decline Gradient	Decline gradient of inverter active power per minute	1 %/min–6000 %/min
Active Power Rising Gradient	Rising gradient of inverter active power per minute	1 %/min–6000 %/min
Active Power Setting Persistence	Switch for activating/deactivating the function of active power setting persistence	On/Off
Active Power Limit	Switch for limiting active power	On/Off
Active Power Limit Ratio	The ratio of active power limit to rated power in percentage	0.0 %–100.0 %

Reactive Power Regulation

Tap **Settings**→**Power Regulation Parameters**→**Reactive Power Regulation** to enter the screen, as shown in the following figure.



figure 7-17 Reactive Power Regulation

table 7-6 Description of Reactive Power Regulation Parameters

Parameter	Description	Range
Reactive Power Setting Persistence	Switch for activating/deactivating the function of reactive power setting persistence	On/Off
Reactive Power Regulation Mode	Off/PF/Qt/Q(P)/Q(U)	Off/PF/Qt/Q(P)/Q(U)
Reactive Response	Switch for activating/deactivating the function of reactive response	On/Off
Reactive Response Time	Time for reactive response	0.1 s-600 s

"Off" Mode

The reactive power regulation function is disabled. The PF is fixed at +1.000.

"PF" Mode

The power factor (PF) is fixed and the reactive power is regulated by the parameter PF. The PF ranges from 0.8 leading to 0.8 lagging.

- Leading: the inverter is sourcing reactive power to the grid.
- Lagging: the inverter is injecting reactive power into the grid.

"Qt" Mode

In the Qt mode, the reactive power can be regulated by the parameter Q-Var limits (in %). The system rated reactive power is fixed, the system injects reactive power according to the delivered reactive power ratio. The "Reactive Power Ratio" is set through the App.

The setting range of the reactive power ratio is from -100 % to 100 %, corresponding to the ranges of inductive and capacitive reactive power regulation respectively.

"Q(P)" Mode

The PF of the inverter output varies in response to the output power of the inverter.

table 7-7 "Q(P)" Mode Parameters Explanation

Parameter	Explanation	Range
Q(P) Curve	Select corresponding curve according to local regulations	A, B, C*
QP_P1	Output power at point P1 on the Q(P) mode curve (in %)	0.0 %–100.0 %
QP_P2	Output power at point P2 on the Q(P) mode curve (in %)	20.0 %–100.0 %
QP_P3	Output power at point P3 on the Q(P) mode curve (in %)	20.0 %–100.0 %
QP_K1	Power factor at point P1 on the Q(P) mode curve	Curve A/C: 0.800 to 1.000
QP_K2	Power factor at point P2 on the Q(P) mode curve	Curve B: -0.600 to 0.600
QP_K3	Power factor at point P3 on the Q(P) mode curve	Curve B: -0.600 to 0.600
QP_EnterVoltage	Voltage for Q(P) function activation (in %)	100.0 %–110.0 %
QP_ExitVoltage	Voltage for Q(P) function deactivation (in %)	90.0 %–100.0 %
QP_ExitPower	Power for Q(P) function deactivation (in %)	1.0 %–100.0 %
QP_EnableMode	Unconditional activation/deactivation of Q(P) function	Yes, No

* Curve C is reserved and consistent with Curve A currently.

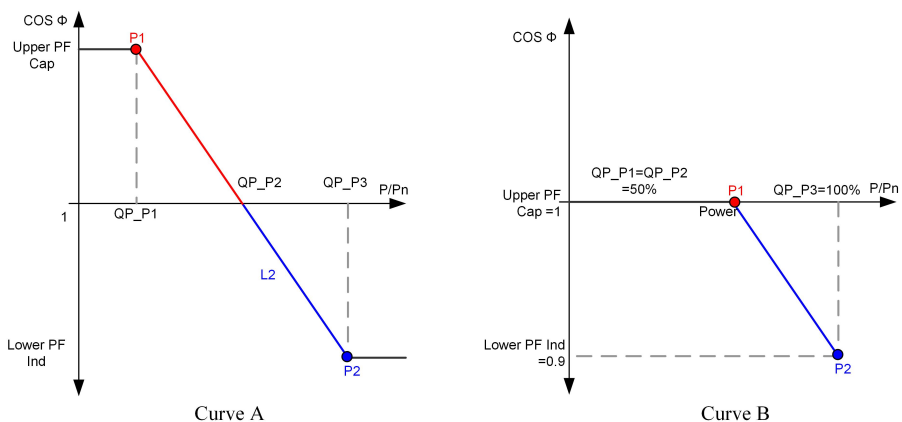

figure 7-18 Reactive Power Regulation Curve in Q(P) Mode

"Q(U)" Mode

The reactive power output of the inverter varies in response to the grid voltage.

table 7-8 "Q(U)" Mode Parameter Explanation

Parameter	Explanation	Range
Q(U) curve	Select corresponding curve according to local regulations	A, B, C*
Hysteresis Ratio	Voltage hysteresis ratio on the Q(U) mode curve	0.0 %–5.0 %
QU_V1	Grid voltage limit at point P1 on the Q(U) mode curve (in %)	80.0 %–100.0 %
QU_V2	Grid voltage limit at point P2 on the Q(U) mode curve (in %)	80.0 %–100.0 %
QU_V3	Grid voltage limit at point P3 on the Q(U) mode curve (in %)	100.0 %–120.0 %
QU_V4	Grid voltage limit at point P4 on the Q(U) mode curve (in %)	100.0 %–120.0 %
QU_Q1	Value of Q/Sn at point P1 on the Q(U) mode curve (in %)	-60.0 % to 0.0 %
QU_Q2	Value of Q/Sn at point P2 on the Q(U) mode curve (in %)	-60.0 % to 60.0 %
QU_Q3	Value of Q/Sn at point P3 on the Q(U) mode curve (in %)	-60.0 % to 60 %
QU_Q4	Value of Q/Sn at point P4 on the Q(U) mode curve (in %)	0.0 % to 60.0 %
QU_EnterPower	Active power for Q(U) function activation (in %)	20.0 %–100.0 %
QU_ExitPower	Active power for Q(U) function deactivation (in %)	1.0 %–20.0 %
QU_EnableMode	Unconditional activation/deactivation of Q(U) function	Yes, No, Yes (Limited by PF)
QU_Limited PF Value	Preset PF value	0–1

* Curve C is reserved and consistent with Curve A currently.

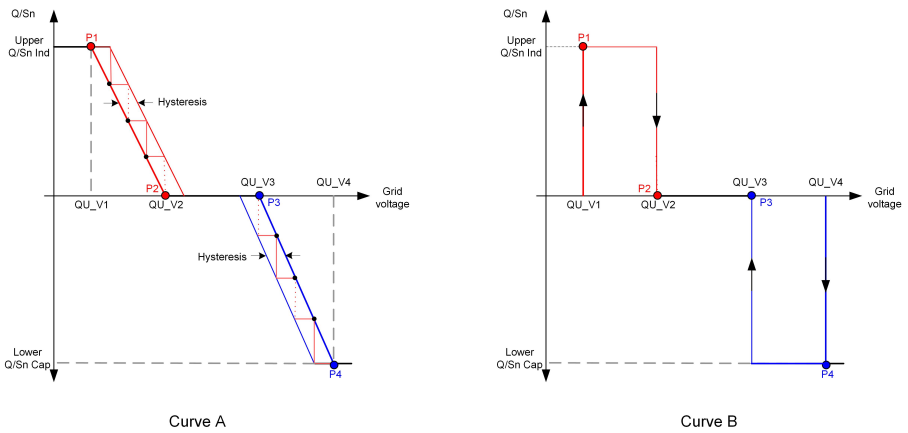

figure 7-19 Reactive Power Regulation Curve in Q(U) Curve

7.10.4 Communication Parameters

Tap **Settings**→**Communication Parameters**→**Serial Port Parameters** to enter the corresponding interface, as shown in the following figure.

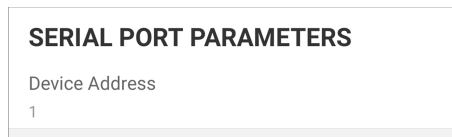

figure 7-20 Serial Port Parameters

table 7-9 Serial Port Parameters

Parameter	Range
Device Address	1–246

MPLC Parameters

Tap **Settings**→**Communication Parameters**→**MPLC Parameters** to enter the corresponding interface, as shown in the following figure.

MPLC PARAMETERS	
Band Num	Band1
Array ID	1
Winding ID	1

figure 7-21 MPLC Parameters

table 7-10 MPLC Parameters

Parameter	Range
Band Num	Band1, Band2
Array ID	1–255
Winding ID	1–10

7.10.5 Firmware Update

To avoid download failure due to poor on-site network signal, it is recommended to download the firmware package to the mobile device in advance.

- step 1 Enable the "Mobile data" of the mobile device.
- step 2 Open the App, enter the account and password on the login screen. Tap **Login** to enter the home screen.
- step 3 Tap **More**→**Firmware Download** to enter corresponding screen on which you can view the device list.
- step 4 Select the device model before downloading the firmware. Tap the device name in the device list to enter the firmware upgrade package detail interface, and tap  behind the firmware upgrade package to download it.

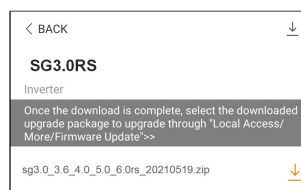

- step 5 Return to the **Firmware Download** screen, tap  in the upper right corner of the screen to view the downloaded firmware upgrade package.
- step 6 Login the App via local access mode. Refer to "7.4 Login".
- step 7 Tap **More** on the App home screen and then tap **Firmware Update**.
- step 8 Tap the upgrade package file, a prompt box will pop up asking you to upgrade the firmware with the file, tap **CONFIRM** to perform the firmware upgrade.



step 9 Wait for the file to be uploaded. When the upgrade is finished, the interface will inform you of the upgrade completion. Tap **Complete** to end the upgrade.

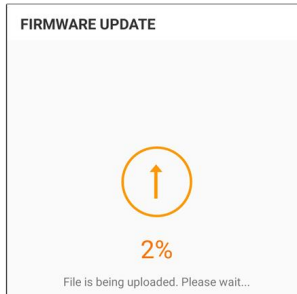

-- End

7.10.6 Auto-test

Tap **Auto-test** to enter the corresponding screen, as shown in the following figure.

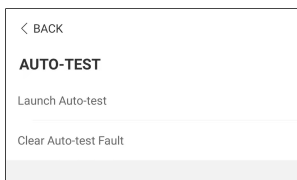

figure 7-22 Auto-test

Launch Auto-test

Tap **Launch Auto-test** carry out an auto-test. Auto-testing will take about 5 minutes. When the auto-test is completed, the auto-test report is displayed, as shown in the figure below. Tap **DOWNLOAD** to download the report.

AUTO-TEST RESULT	
Auto-test Result	Successful
Over-frequency Level 1 (81>.S1)	
Frequency Threshold	51.50 Hz
Frequency Sample Value	50.00 Hz
Time Threshold	0.10 s
Time Sample Value	0.10 s
Under Frequency Level 1 (81<.S1)	
Frequency Threshold	47.50 Hz
Frequency Sample Value	49.99 Hz
Time Threshold	0.10 s
Time Sample Value	0.10 s
Over-voltage Level 1 (59.S1)	
Frequency Threshold	51.50 Hz
Frequency Sample Value	50.00 Hz
Time Threshold	0.10 s
Time Sample Value	0.10 s
<input type="button" value="DOWNLOAD"/>	

figure 7-23 Auto-test Result

Clear Auto-test Fault

Tap **Clear Auto-test Fault** → **CONFIRM** to clear the auto-test fault.

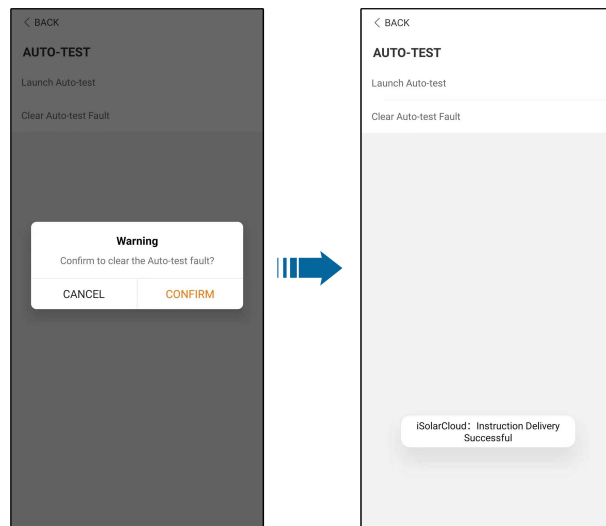

figure 7-24 Clear Auto-test Fault

8 System Decommissioning

8.1 Disconnecting the Inverter

CAUTION

Risk of burns due to hot components!

Even if the inverter is shut down, it may still be hot and cause burns. Wear protective gloves before operating the inverter after it cools down.

For maintenance or other service work, the inverter must be switched off.

Proceed as follows to disconnect the inverter from the AC and DC power sources. Lethal voltages or damage to the inverter will follow if otherwise.

- step 1 Disconnect the external AC circuit breaker and secure it against reconnection.
- step 2 Rotate the DC switch to the "OFF" position for disconnecting all of the PV string inputs.
- step 3 Wait about 10 minutes until the capacitors inside the inverter completely discharge.
- step 4 Ensure that the DC cable is current-free via a current clamp.

-- End

8.2 Dismantling the Inverter

CAUTION

Risk of burn injuries and electric shock!

After the inverter is powered off for 10 minutes, measure the voltage and current with professional instrument. Only when there is no voltage nor current can operators who wear protective equipment operate and maintain the inverter.



Before dismantling the inverter, disconnect both AC and DC connections.

If there are more than two layers of inverter DC terminals, dismantle the outer DC connectors before dismantling the inner ones.

- step 1 Refer to "[5 Electrical Connection](#)", for the inverter disconnection of all cables in reverse steps. In particular, when removing the DC connector, use an MC4 wrench to loosen the locking parts and install waterproof plugs.

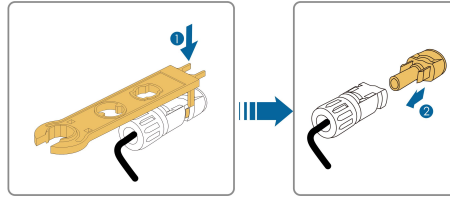

step 2 Refer to "[4 Mechanical Mounting](#)", to dismantle the inverter in reverse steps.

step 3 If necessary, remove the wall-mounting bracket from the wall.

step 4 If the inverter will be used again in the future, please refer to "[3.2 Inverter Storage](#)" for a proper conservation.

-- End

8.3 Disposal of the Inverter

Users take the responsibility for the disposal of the inverter.

WARNING

Please scrap the inverter in accordance with relevant local regulations and standards to avoid property losses or casualties.

NOTICE

Some parts of the inverter may cause environmental pollution. Please dispose of them in accordance with the disposal regulations for electronic waste applicable at the installation site.

9 Troubleshooting and Maintenance

9.1 Troubleshooting

Once the inverter fails, the fault information can be displayed on the App interface. If the inverter is equipped with an LCD screen, the fault information can be viewed on it.

The fault codes and troubleshooting methods of all PV inverters are detailed in the table below. The device you purchase may only contain some of the fault information, and when the inverter fails, you can check the corresponding information through the fault codes from the mobile app.

Fault code	Fault name	Corrective measures
2, 3, 14, 15	Grid Overvoltage	<p>Generally, the inverter will be reconnected to the grid after the grid returns to normal. If the fault occurs repeatedly:</p> <ol style="list-style-type: none"> 1. Measure the actual grid voltage, and contact the local electric power company for solutions if the grid voltage is higher than the set value. 2. Check whether the protection parameters are appropriately set via the App or the LCD. Modify the overvoltage protection values with the consent of the local electric power operator. 3. Contact Sungrow Customer Service if the preceding causes are ruled out and the fault persists.
4, 5	Grid Undervoltage	<p>Generally, the inverter will be reconnected to the grid after the grid returns to normal. If the fault occurs repeatedly:</p> <ol style="list-style-type: none"> 1. Measure the actual grid voltage, and contact the local electric power company for solutions if the grid voltage is lower than the set value. 2. Check whether the protection parameters are appropriately set via the App or the LCD. 3. Check whether the AC cable is firmly in place. 4. Contact Sungrow Customer Service if the preceding causes are ruled out and the fault persists.

Fault code	Fault name	Corrective measures
8	Grid Overfrequency	<p>Generally, the inverter will be reconnected to the grid after the grid returns to normal. If the fault occurs repeatedly:</p> <ol style="list-style-type: none"> 1. Measure the actual grid frequency, and contact the local electric power company for solutions if the grid frequency is beyond the set range.
9	Grid Underfrequency	<ol style="list-style-type: none"> 2. Check whether the protection parameters are appropriately set via the App or the LCD. 3. Contact Sungrow Customer Service if the preceding causes are ruled out and the fault persists.
10	Grid Power Outage	<p>Generally, the inverter will be reconnected to the grid after the grid returns to normal. If the fault occurs repeatedly:</p> <ol style="list-style-type: none"> 1. Check whether the grid supplies power reliably. 2. Check whether the AC cable is firmly in place. 3. Check whether the AC cable is connected to the correct terminal (whether the live wire and the N wire are correctly in place). 4. Check whether the AC circuit breaker is connected. 5. Contact Sungrow Customer Service if the preceding causes are ruled out and the fault persists.
12	Excess Leakage Current	<ol style="list-style-type: none"> 1. The fault can be caused by poor sunlight or damp environment, and generally the inverter will be reconnected to the grid after the environment is improved. 2. If the environment is normal, check whether the AC and DC cables are well insulated. 3. Contact Sungrow Customer Service if the preceding causes are ruled out and the fault persists.

Fault code	Fault name	Corrective measures
13	Grid Abnormal	<p>Generally, the inverter will be reconnected to the grid after the grid returns to normal. If the fault occurs repeatedly:</p> <ol style="list-style-type: none"> 1. Measure the actual grid, and contact the local electric power company for solutions if the grid parameter exceeds the set range. 2. Contact Sungrow Customer Service if the preceding causes are ruled out and the fault persists.
17	Grid Voltage Imbalance	<p>Generally, the inverter will be reconnected to the grid after the grid returns to normal. If the fault occurs repeatedly:</p> <ol style="list-style-type: none"> 1. Measure the actual grid voltage. If grid phase voltages differ greatly, contact the electric power company for solutions. 2. If the voltage difference between phases is within the permissible range of the local power company, modify the grid voltage imbalance parameter through the App or the LCD. 3. Contact Sungrow Customer Service if the preceding causes are ruled out and the fault persists.
28, 29, 208, 448-479	PV Reserve Connection Fault	<ol style="list-style-type: none"> 1. Check whether the corresponding string is of reverse polarity. If so, disconnect the DC switch and adjust the polarity when the string current drops below 0.5 A. 2. Contact Sungrow Customer Service if the preceding causes are ruled out and the fault persists. <p>*The code 28 to code 29 are corresponding to PV1 to PV2 respectively.</p> <p>*The code 448 to code 479 are corresponding to string 1 to string 32 respectively.</p>

Fault code	Fault name	Corrective measures
532-547, 564-579	PV Reverse Connection Alarm	<p>1. Check whether the corresponding string is of reverse polarity. If so, disconnect the DC switch and adjust the polarity when the string current drops below 0.5 A.</p> <p>2. Contact Sungrow Customer Service if the preceding causes are ruled out and the alarm persists.</p> <p>*The code 532 to code 547 are corresponding to string 1 to string 16 respectively.</p> <p>*The code 564 to code 579 are corresponding to string 17 to string 32 respectively.</p>
548-563, 580-595	PV Abnormal Alarm	<p>Check whether the voltage and current of the inverter is abnormal to determine the cause of the alarm.</p> <p>1. Check whether the corresponding module is sheltered. If so, remove the shelter and ensure module cleanness.</p> <p>2. Check whether the battery board wiring is loose, if so, make it reliably connected.</p> <p>3. Check if the DC fuse is damaged. If so, replace the fuse.</p> <p>4. Contact Sungrow Customer Service if the preceding causes are ruled out and the alarm persists.</p> <p>*The code 548 to code 563 are corresponding to string 1 to string 16 respectively.</p> <p>*The code 580 to code 595 are corresponding to string 17 to string 32 respectively.</p>

Fault code	Fault name	Corrective measures
37	Excessively High Ambient Temperature	<p>Generally, the inverter will resume operation when the internal or module temperature returns to normal. If the fault persists:</p> <ol style="list-style-type: none"> 1. Check whether the ambient temperature of the inverter is too high; 2. Check whether the inverter is in a well-ventilated place; 3. Check whether the inverter is exposed to direct sunlight. Shield it if so; 4. Check whether the fan is running properly. Replace the fan if not; 5. Contact Sungrow Power Customer Service if the fault is due to other causes and the fault persists.
43	Excessively Low Ambient Temperature	<p>Stop and disconnect the inverter. Restart the inverter when the ambient temperature rises within the operation temperature range.</p>
39	Low System Insulation Resistance	<p>Wait for the inverter to return to normal. If the fault occurs repeatedly:</p> <ol style="list-style-type: none"> 1. Check whether the ISO resistance protection value is excessively high via the app or the LCD, and ensure that it complies with the local regulations. 2. Check the resistance to ground of the string and DC cable. Take corrective measures in case of short circuit or damaged insulation layer. 3. If the cable is normal and the fault occurs on rainy days, check it again when the weather turns fine. 4. Contact Sungrow Customer Service if the preceding causes are ruled out and the fault persists.

Fault code	Fault name	Corrective measures
106	Grounding Cable Fault	<ol style="list-style-type: none"> 1. Check whether the AC cable is correctly connected. 2. Check whether the insulation between the ground cable and the live wire is normal. 3. Contact Sungrow Customer Service if the preceding causes are ruled out and the fault persists.
88	Electric Arc Fault	<ol style="list-style-type: none"> 1. Disconnect the DC power supply, and check whether any DC cable is damaged, the connection terminal or fuse is loose or there is a weak contact. If so, replace the damaged cable, fasten the terminal or fuse, and replace the burnt component. 2. After performing step 1, reconnect the DC power supply, and clear the electric arc fault via the App or the LCD, after that the inverter will return to normal. 3. Contact Sungrow Customer Service if the fault persists.
84	Reverse Connection Alarm of the Meter/CT	<ol style="list-style-type: none"> 1. Check if the meter is wrongly connected. 2. Check if the input and output wiring of the meter is reversed. 3. If the existing system is enabled, please check if the rated power setting of the existing inverter is correct.
514	Meter Communication Abnormal Alarm	<ol style="list-style-type: none"> 1. Check whether the communication cable and the terminals are abnormal. If so, correct them to ensure reliable connection. 2. Reconnect the communication cable of the meter. 3. Contact Sungrow Customer Service if the preceding causes are ruled out and the alarm persists.
323	Grid Confrontation	<ol style="list-style-type: none"> 1. Check whether the output port is connected to actual grid. Disconnect it from the grid if so. 2. Contact Sungrow Customer Service if the preceding causes are ruled out and the fault persists.

Fault code	Fault name	Corrective measures
75	Inverter Parallel Communication Alarm	<ol style="list-style-type: none"> 1. Check whether the communication cable and the terminals are abnormal. If so, correct them to ensure reliable connection. 2. Reconnect the communication cable of the meter. 3. Contact Sungrow Customer Service if the preceding causes are ruled out and the alarm persists.
<p>7, 11, 16, 19–25, 30– 34, 36, 38, 40–42, 44– 50, 52–58, 60–68, 85, 87, 92, 93, 100–105, 107–114, 116–124, 200–211, 248–255, 300–322, 324–327, 401–412, 600–603, 605, 608, 612, 616, 620, 622– 624, 800, 802, 804, 807, 1096– 1122</p>	System Fault	<p>Wait for the inverter to return to normal.</p> <p>Disconnect the AC and DC switches, and reconnect the AC and DC switches 15 minutes later to restart the inverter. If the fault still exists, contact Sungrow Customer Service.</p>

Fault code	Fault name	Corrective measures
59, 70–74, 76, 82, 83, 89, 77–81, 216–218, 220–232, 432–434, 500–513, 515–518, 900, 901, 910, 911	System Alarm	<p>1. The inverter can continue running.</p> <p>2. Check whether the related wiring and terminal are abnormal, check whether there are any foreign materials or other environmental abnormalities, and take corresponding corrective measures when necessary.</p> <p>If the fault persists, please contact Sungrow Power Customer Service.</p>
264-283	MPPT Reverse Connection	<p>1. Check whether the corresponding string is of reverse polarity. If so, disconnect the DC switch and adjust the polarity when the string current drops below 0.5 A.</p> <p>2. Contact Sungrow Customer Service if the preceding causes are ruled out and the fault persists.</p> <p>*The code 264 to code 279 are corresponding to string 1 to string 20 respectively.</p>
332-363	Boost Capacitor Over-voltage Alarm	<p>1. The inverter can continue running.</p> <p>2. Check whether the related wiring and terminals are abnormal, check whether there are any foreign materials or other environmental abnormalities, and take corresponding corrective measures when necessary.</p> <p>If the fault persists, please contact Sungrow Power Customer Service.</p>

Fault code	Fault name	Corrective measures
364-395	Boost Capacitor Over-voltage Fault	Disconnect the AC and DC switches, and reconnect the AC and DC switches 15 minutes later to restart the inverter. If the fault still exists, contact Sungrow Customer Service.
1548-1579	String Current Reflux	<ol style="list-style-type: none"> 1. Check whether the number of PV modules of the corresponding string is less than other strings. If so, disconnect the DC switch and adjust the PV module configuration when the string current drops below 0.5 A. 2. Check whether the PV module is shaded; 3. Disconnect the DC switch to check whether the open circuit voltage is normal when the string current drops below 0.5 A. If so, check the wiring and configuration of the PV module, 4. Check whether the orientation of the PV module is abnormal.

9.2 Maintenance

9.2.1 Maintenance Notices

The DC switch can be secured with a lock in the OFF position or a certain angle beyond the OFF position.

DANGER

Risk of inverter damage or personal injury due to incorrect service!

- **Be sure to use special insulation tools when perform high-voltage operations.**
- **Before any service work, first disconnect the grid-side AC circuit breaker and check the inverter status. If the inverter indicator is off, please wait until night to disconnect the DC switch. If the inverter indicator is on, directly disconnect the DC switch.**
- **After the inverter is powered off for 10 minutes, measure the voltage and current with professional instrument. Only when there is no voltage nor current can operators who wear protective equipment operate and maintain the inverter**
- **Even if the inverter is shut down, it may still be hot and cause burns. Wear protective gloves before operating the inverter after it cools down.**

⚠ CAUTION

To prevent misuse or accidents caused by unrelated personnel: Post prominent warning signs or demarcate safety warning areas around the inverter to prevent accidents caused by misuse.

NOTICE

Restart the inverter only after removing the fault that impairs safety performance. As the inverter contains no component parts that can be maintained, never open the enclosure, or replace any internal components.

To avoid the risk of electric shock, do not perform any other maintenance operations beyond this manual. If necessary, contact SUNGROW for maintenance. Otherwise, the losses caused is not covered by the warranty.

NOTICE

Touching the PCB or other static sensitive components may cause damage to the device.

- **Do not touch the circuit board unnecessarily.**
- **Observe the regulations to protect against electrostatic and wear an anti-static wrist strap.**

9.2.2 Routine Maintenance

Item	Method	Period
System clean	Check the temperature and dust of the inverter. Clean the inverter enclosure if necessary.	Six months to a year (depending on the dust contents in air)
Electrical connection	Check whether all cable are firmly connected in place. Check whether there is damage to the cables, especially the surface in contact with metal.	6 months after commissioning and then once or twice a year.
General status of the system	<ul style="list-style-type: none"> • Visual check for any damage or deformation of the inverter. • Check any abnormal noise during the operation. • Check each operation parameter. • Be sure that nothing covers the heat sink of the inverter. 	Every 6 months

10 Appendix

10.1 Technical Data

Parameter	SG2.0RS-S	SG2.5RS-S	SG3.0RS-S
Input (DC)			
Recommended max. PV input power	3.0 kWp	3.75 kWp	4.5 kWp
Max. PV input voltage	600 V *		
Min. operating PV voltage / Start-up input voltage	40 V / 50 V		
Nominal input voltage	360 V		
MPP voltage range	40 V – 560 V		
No. of MPPTs	1		
Default No. of PV strings per MPPT	1		
Max. PV input current	16 A		
Max. DC short-circuit current	20 A		
Output (AC)			
Rated AC output power	2000 W	2500 W	3000 W
Max. AC output apparent power	2000 VA	2500 VA	3000 VA
Rated AC output apparent power	2000 VA	/	/
Rated AC output current (at 230 V)	8.7 A	10.9 A	13.1 A
Max. AC output current	9.1 A	11.4 A	13.7 A
Rated AC voltage	220 V / 230 V / 240 V		
AC voltage range	154 V – 276 V		
Rated grid frequency / Grid frequency range	50 Hz / 45 Hz – 55 Hz, 60 Hz / 55 Hz – 65 Hz		
Harmonic (THD)	< 3 % (at rated power)		
Power factor at rated power / Adjustable power factor	> 0.99 / 0.8 leading - 0.8 lagging		
Feed-in phases / connection phases	1 / 1		

Parameter	SG2.0RS-S	SG2.5RS-S	SG3.0RS-S
Efficiency			
Max. efficiency / European efficiency	97.8 % / 96.9 %	97.8 % / 97.2 %	97.8 % / 97.3 %
Protection			
Grid monitoring	Yes		
DC reverse polarity protection	Yes		
AC short circuit protection	Yes		
Leakage current protection	Yes		
Surge Protection	DC type II / AC type II		
DC switch	Optional**	Yes	Yes
PV string current monitoring	Yes		
Arc fault circuit interrupter (AFCI)	Optional		
PID recovery function	Yes		
General Data			
Dimensions (W x H x D)	320 mm x 225 mm x 120 mm		
Weight	6 kg		
Mounting method	Wall-mounting bracket		
Topology	Transformerless		
Degree of protection	IP65		
Operating ambient temperature range	-25°C to +60°C		
Allowable relative humidity range (non-condensing)	0–100 %		
Max. operating altitude	4000 m		
Cooling method	Natural cooling		
Display	LED digital display & LED indicator		
Communication	Ethernet / WLAN / RS485 / DI (Ripple control & DRM)		
DC connection type	MC4 (Max. 6 mm ²)		
AC connection type	Plug and play connector (Max. 6 mm ²)		
Grid support	Active & reactive power control and power ramp rate control		

* The inverter enters standby state when the input voltage ranges between 560 V and 600 V.

** This function is only available for non-AU versions.

Parameter	SG3.0RS	SG3.6RS	SG4.0RS
Input (DC)			
Recommended max. PV input power	4.5 kWp	5.4 kWp	6 kWp
Max. PV input voltage	600 V *		
Min. operating PV voltage / Start-up input voltage	40 V / 50 V		
Rated PV input voltage	360 V		
MPP voltage range	40 V – 560 V		
No. of MPPTs	2		
Default No. of PV strings per MPPT	1		
Max. PV input current	32 A (16 A / 16 A)		
Max. DC short-circuit current	40 A (20 A / 20 A)		
Output (AC)			
Rated AC output power	3000 W	3680 W	4000 W
Max. AC output apparent power	3000 VA	3680 VA	4000 VA
Rated AC output apparent power	3000 VA	/	/
Rated AC output current (at 230 V)	13.1 A	16 A	17.4 A
Max. AC output current	13.7 A	16 A	18.2 A
Rated AC voltage	220 V / 230 V / 240 V		
AC voltage range	154 V – 276 V		
Rated grid frequency / Grid frequency range	50 Hz / 45 Hz – 55 Hz, 60 Hz / 55 Hz – 65 Hz		
Harmonic (THD)	< 3 % (at rated power)		
Power factor at rated power / Adjustable power factor	> 0.99 / 0.8 leading - 0.8 lagging		
Feed-in phases / connection phases	1 / 1		
Efficiency			
Max. efficiency / European efficiency	97.9 % / 97.0 %	97.9 % / 97.0 %	97.9 % / 97.2 %
Protection			
Grid monitoring	Yes		

Parameter	SG3.0RS	SG3.6RS	SG4.0RS
DC reverse polarity protection	Yes		
AC short circuit protection	Yes		
Leakage current protection	Yes		
Surge Protection	DC type II / AC type II		
DC switch	Optional**	Yes	Yes
PV string current monitoring	Yes		
Arc fault circuit interrupter (AFCI)	Optional		
PID recovery function	Yes		
General Data			
Dimensions (W x H x D)	410 mm x 270 mm x 150 mm		
Weight	10 kg		
Mounting method	Wall-mounting bracket		
Topology	Transformerless		
Degree of protection	IP65		
Operating ambient temperature range	-25°C to +60°C		
Allowable relative humidity range (non-condensing)	0–100 %		
Max. operating altitude	4000 m		
Cooling method	Natural cooling		
Display	LED digital display & LED indicator		
Communication	Ethernet / WLAN / RS485 / DI (Ripple control & DRM)		
DC connection type	MC4 (Max. 6 mm ²)		
AC connection type	Plug and play connector (Max. 6 mm ²)		
Grid support	Active & reactive power control and power ramp rate control		

* The inverter enters standby state when the input voltage ranges between 560 V and 600 V.

** This function is only available for non-AU versions.

Parameter	SG5.0RS	SG6.0RS
Input (DC)		
Recommended max. PV input power	7.5 kWp	9 kWp
Max. PV input voltage	600 V *	

Parameter	SG5.0RS	SG6.0RS
Min. operating PV voltage / Start-up input voltage	40 V / 50 V	
Rated PV input voltage	360 V	
MPP voltage range	40 V – 560 V	
No. of MPPTs	2	
Default No. of PV strings per MPPT	1	
Max. PV input current	32 A (16 A / 16 A)	
Max. DC short-circuit current	40 A (20 A / 20 A)	
Output (AC)		
Rated AC output power	4999 W for "AU", 5000 W for others	6000 W
Max. AC output apparent power	4999 VA for "AU", 5000 VA for others	6000 VA
Max. AC output apparent power	4999 VA for "AU", 5000 VA for others	/
Rated AC output current (at 230 V)	21.7 A for "AU", 21.8 A for others	26.1 A
Max. AC output current	21.7 A for "AU", 22.8 A for others	27.3 A
Rated AC voltage	220 V / 230 V / 240 V	
AC voltage range	154 V – 276 V	
Rated grid frequency / Grid frequency range	50 Hz / 45 Hz – 55 Hz, 60 Hz / 55 Hz – 65 Hz	
Harmonic (THD)	< 3 % (at rated power)	
Power factor at rated power / Adjustable power factor	> 0.99 / 0.8 leading - 0.8 lagging	
Feed-in phases / connection phases	1 / 1	
Efficiency		
Max. efficiency / European efficiency	97.9 % / 97.3 %	97.9 % / 97.5 %
Protection		
Grid monitoring	Yes	
DC reverse polarity protection	Yes	
AC short circuit protection	Yes	
Leakage current protection	Yes	
Surge Protection	DC type II / AC type II	
DC switch	Optional**	Yes
PV string current monitoring	Yes	

Parameter	SG5.0RS	SG6.0RS
Arc fault circuit interrupter (AFCI)	Optional	
PID recovery function	Yes	
General Data		
Dimensions (W x H x D)	410 mm x 270 mm x 150 mm	
Weight	10 kg	
Mounting method	Wall-mounting bracket	
Topology	Transformerless	
Degree of protection	IP65	
Operating ambient temperature range	-25°C to +60°C	
Allowable relative humidity range (non-condensing)	0–100 %	
Max. operating altitude	4000 m	
Cooling method	Natural cooling	
Display	LED digital display & LED indicator	
Communication	Ethernet / WLAN / RS485 / DI (Ripple control & DRM)	
DC connection type	MC4 (Max. 6 mm ²)	
AC connection type	Plug and play connector (Max. 6 mm ²)	
Grid support	Active & reactive power control and power ramp rate control	

* The inverter enters standby state when the input voltage ranges between 560 V and 600 V.

** This function is only available for non-AU versions.

10.2 Quality Assurance

When product faults occur during the warranty period, SUNGROW will provide free service or replace the product with a new one.

Evidence

During the warranty period, the customer shall provide the product purchase invoice and date. In addition, the trademark on the product shall be undamaged and legible. Otherwise, SUNGROW has the right to refuse to honor the quality guarantee.

Conditions

- After replacement, unqualified products shall be processed by SUNGROW.
- The customer shall give SUNGROW a reasonable period to repair the faulty device.

Exclusion of Liability

In the following circumstances, SUNGROW has the right to refuse to honor the quality guarantee:

- The free warranty period for the whole machine/components has expired.
- The device is damaged during transport.
- The device is incorrectly installed, refitted, or used.
- The device operates in harsh conditions beyond those described in this manual.
- The fault or damage is caused by installation, repairs, modification, or disassembly performed by a service provider or personnel not from SUNGROW.
- The fault or damage is caused by the use of non-standard or non-SUNGROW components or software.
- The installation and use range are beyond stipulations of relevant international standards.
- The damage is caused by unexpected natural factors.

For faulty products in any of above cases, if the customer requests maintenance, paid maintenance service may be provided based on the judgment of SUNGROW.

10.3 Contact Information

In case of questions about this product, please contact us.

We need the following information to provide you the best assistance:

- Model of the device
- Serial number of the device
- Fault code/name
- Brief description of the problem

For detailed contact information, please visit: <https://en.sungrowpower.com/contactUS>.