

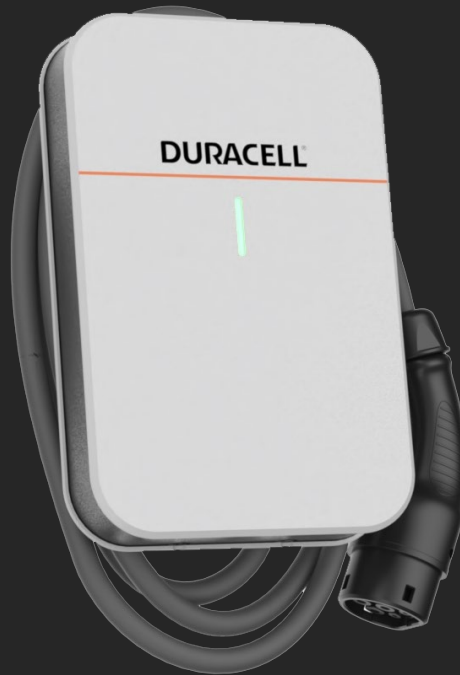

**DURACELL<sup>®</sup>**  
ENERGY

## **DURACELL EV (1P-T) INSTALLATION GUIDE**



Version 1.0

# Contents

<b>1 Safety and Warning</b> .....	<b>3</b>
<b>2 Introduction</b> .....	<b>4</b>
2.1 Technical Specifications.....	4
2.2 External Structure.....	5
2.3 Package Content .....	6
<b>3 Installation Instructions</b> .....	<b>7</b>
3.1 Installation Preparation .....	7
3.1.1 Required Tools .....	7
3.2 Installation Process .....	7
3.2.1 Installation Notice.....	7
3.2.2 Checks before starting the installation process .....	8
3.3 Installation Procedure .....	8
<b>4 Electrical Connection</b> .....	<b>10</b>
<b>5 CT connection for DLB &amp; Solar integration</b> .....	<b>11</b>
<b>6 EV Charger App</b> .....	<b>13</b>
<b>7 App Registration</b> .....	<b>15</b>
7.1 Register the homeowner on the PureCharger app.....	15
7.2 Load balancing set up.....	22
7.3 Register the homeowner on the Duracell app.....	23
7.4 Charging operations on PureCharger App .....	26
7.5 Charging with RFID Card .....	27
<b>8 Configuration and Operation</b> .....	<b>28</b>
8.1 Checks before Power-on .....	28
8.2 Power-on status checking .....	28
8.3 Charging Operation .....	29
<b>9 Troubleshooting</b> .....	<b>30</b>
9.1 Indicator status .....	30
9.2 Error code and resolutions.....	31

## 1 Safety and Warning

Save these instructions. Read all instructions before installing or using the charger.

1. Keep the charger away from explosive or flammable materials, chemicals, vapours, and other hazardous objects.
2. Keep the charger socket clean and dry. If it gets dirty, please wipe it with clean, dry cloth.
3. Touching the socket core with fingers or foreign objects is strictly forbidden when the power is on.
4. Do not use the charger in case of any device defects, crack, abrasion, bare leakage and so on. Please contact the professional personnel if any of these conditions occur.
5. Do not attempt to disassemble, repair, or refit the charger. If necessary, please contact the professional personnel. Improper operation will result in device damage, electric leakage, etc.
6. If any abnormal condition happens, please immediately cut off all input and output power supplies.
7. Please ensure the charger is not in use and protected in case of lightning and thunderstorms.
8. Keep children away from the charger.
9. During charging, do not drive the EV. Charge only when the EV is stationary. For hybrid cars, charge only when the engine is switched off.
10. Our packaging materials are environmentally friendly and can be recycled. Please put the packaging in applicable containers to recycle it. Do not dispose of this device with household waste. It should be taken to a suitable facility for recycling electrical and electronic devices. For more detailed information about recycling this device, please contact your local city/town council office or your household waste disposal service.

### **RED Declaration of Conformity**

Puredrive Energy Ltd hereby declares that the product is in compliance with essential requirements and other relevant provisions of directive 2014/53/EU, ETSI EN300 328 V2.2.2 (2019-07), ETSI EN 300 330 V2.1.1 (2017-02), ETSI EN 301 489-1 V2.2.3 (2019-11) & ETSI EN 301 489-3 V2.1.1 (2019-03). The original EU Declaration of Conformity may be found at:

<https://duracellenergy.com/>.



## **Warning**



The input and output voltages of this device are high voltage, which threatens the safety of human life. Please strictly observe all warnings on the device and user manual. Unauthorized and non-professional service personnel are forbidden to remove the cover of this device.

## 2 Introduction

### 2.1 Technical Specifications







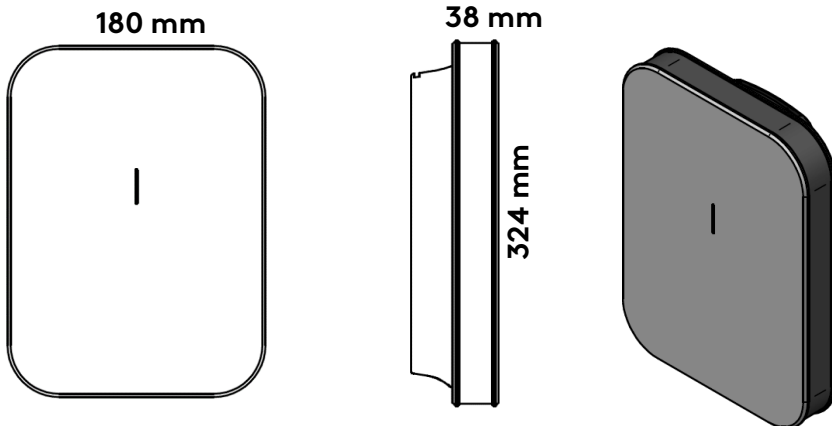

	Product specification	Duracell EV (1P-T)
Electrical Parameter	Power Supply	Single Phase
	Rated Power	7.4kW
	Rated Voltage	AC 230V ± 20%
	Rated Current	32A
	Frequency	50Hz/60Hz
	Charging Mode	Mode 3 (EN/IEC 61851-1)
	Charging Connector Type	IEC 62196 Type 2 (Tethered)
	Standby Power	<1W
Mechanical Parameter	Status Indication	3 Coloured LED (Red, Yellow, Green)
	Dimensions (H x W x D)	341 x 250 x 85 mm
	Weight	3.2 kg
	Cable Length	4m
	Unit Material	ABS
	Operating Temperature	-30°C ~+ 50 °C
Communication	Operating Humidity	5% ~ 95%
	Communication	W-Fi 2.4GHz, Bluetooth (optional), RFID
Safety	Protocol	OCPP 1.6 JSON (OCPP 2.0 Optional)
	RCD	6mA DC Protection
	Ingress Protection	IP55
	Flame Retardant	UL 94V-0
	Certification	CE, UKCA, EN/IEC 61851-1: 2017, EN/IEC 61851-21-2: 2018, EN/IEC 61000-6-1:2019

	Electrical Protection	<ul style="list-style-type: none"> <li>- Over current protection</li> <li>- Residual current protection</li> <li>- Ground protection</li> <li>- Surge protection</li> <li>- Over/Under voltage protection</li> <li>- Over/Under frequency protection</li> <li>- Over/Under temperature protection</li> </ul>
	Warranty	3 years

## 2.2 External Structure







**2.3 Package Content**

				
	<p>User Manual (x1)</p>	<p>Ø 6 Expansion Pipe (x6)</p>	<p>M4*32 Screw (x6)</p>	<p>Mounting Template (x1)</p>
				
<p>Duracell EV (1P-T) Charger (x1)</p>	<p>M4 Wrench (x1)</p>	<p>Sealed Cap (x1)</p>	<p>Insulated Terminal (x3)</p>	<p>CT Clamp (x1)</p>

### 3 Installation Instructions

#### 3.1 Installation Preparation

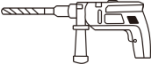
##### 3.1.1 Required Tools

Tool Name	Photo	Function
Multimeter		Check the electrical connection and electrical parameter
Phillips Screwdriver (PH2x150mm, PH3x250mm)		Tighten the screws
Insulated Torque Wrench		Tighten the bolts
Electric Drill		Hole in the wall
Diagonal Pliers		Cut cables

##### 3.1.2 Recommended Cables

Name	Specification	Quantity
EV Ultra Cable	6.0mm 3 core + CAT5 Data PVC	Depends on the Installation requirement

#### 3.2 Installation Process

##### 3.2.1 Installation Notice

- a. Electrical devices should only be installed, operated, and maintained by qualified personnel. No responsibility is assumed by the manufacturer for any consequences arising

out of the use of this device. A qualified person is one who has certified skills and knowledge related to the construction, installation, and operation of this type of electrical device and who has received safety training to recognise and avoid the hazards involved.

- b. All applicable local, regional, and national regulations must be applied when installing, repairing, and maintaining this device.
- c. This charger is integrated with an internal 6mA (DC) RCD, please install a Type A or Type B breaker externally.

### 3.2.2 Checks before starting the installation process

- a. Ensure that the location of the charger is convenient for operational access for normal use and maintenance.
- b. The AC input components within the premises' s power supply are correctly fitted with required protection items prior to installation of the charger.

### 3.3 Installation Procedure

- a. Based on the profile of the attached mounting template, drill 3 x  $\varnothing$  6 x 35 mm holes in the wall and insert the expansion pipe.

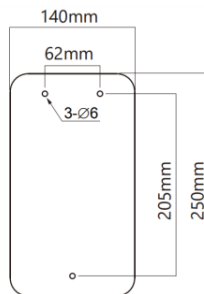

- b. Lock the 2 x M4x32mm self-tapping screws into the expansion pipe, leaving a 5mm space, between the screw head and the wall.
- c. Open the front cover of the EV charger, hang it on the 2 M4x32 mm self-tapping screws, lock it into the bottom M4x32 mm self-tapping screw and then cover the sealing cap.



- d. Connect wires to the connectors (refer to Section 4.3), close the upper cover, and lock it with 2 M4x12mm screws.

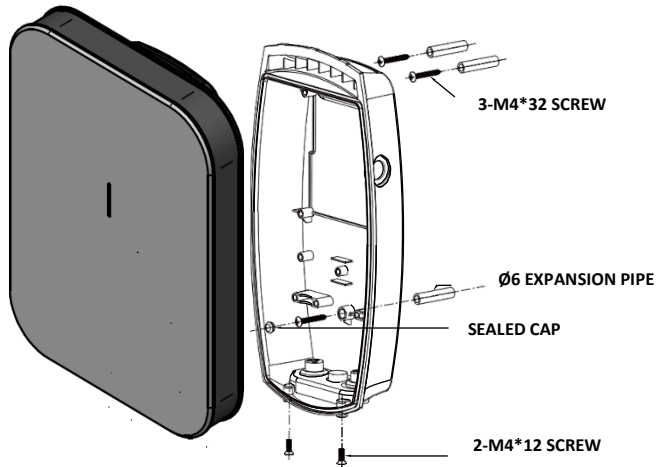

## 4 Electrical Connection

Note: Before inserting the power supply cable, cut the silicon-sealed loop as required to maintain the IP55 rating.

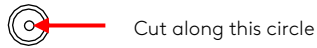

- Remove a length of 40mm of the cable jacket and strip the wire insulation to a length of 8~15mm.
- Crimp the terminal as shown in Figure 1 below.
- Terminate the connections as shown in Figure 2.



Figure 1: Single-Phase Cable

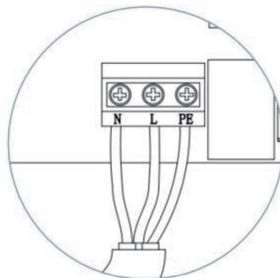

Figure 2: Single-Phase connection

## 5 CT connection for DLB & Solar integration

- a. Screw in the CT wire (red and white) into the provided connector as shown below. Ensure the red and white are terminated as below.



- b. Insert the terminal block into CN13 (CT2) of the main PCB Board.

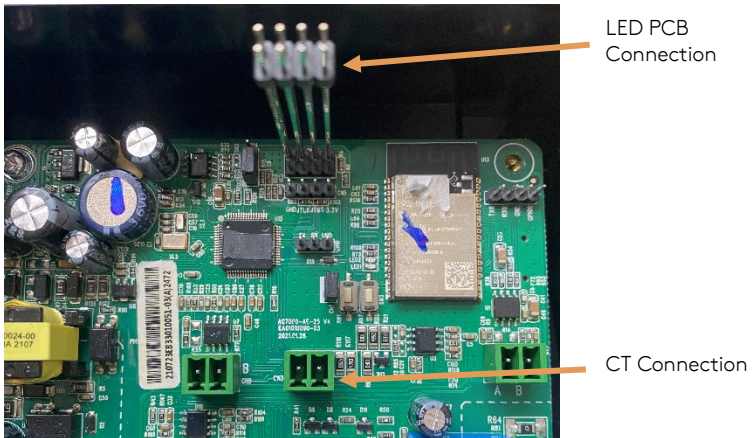

- c. After the CT is installed, Dynamic Load Balancing can be setup on the App.

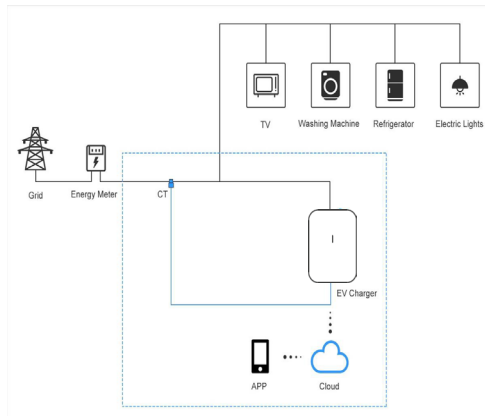

CT Connection Diagram (Single Phase Charger 7kW)

## 6 EV Charger App

There are two different apps you need to download for your charger. Download these on the App store or Google play store. Scan the shown QR codes to download the app.

**PureCharger app:** For the installer to set up the charger.



Apple



Android

**Duracell app:** For the user, please download this Duracell app to operate the charger.



DISCLAIMER: QR CODES WILL BE  
AVAILABLE UPON APPLICATION  
LAUNCH

Apple

Android



PureCharger

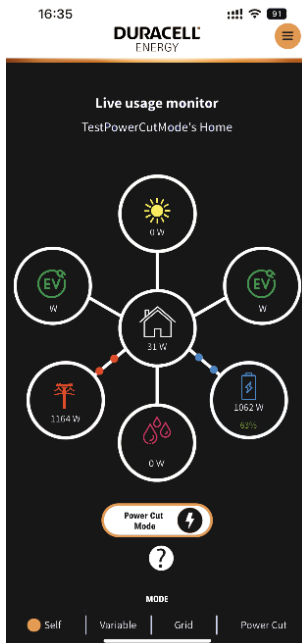

Duracell Energy

## 7 App Registration

### 7.1 Register the homeowner on the PureCharger app

Use the PureCharger App to register the EV charger, the RFID cards, and to set up the dynamic load balancing.

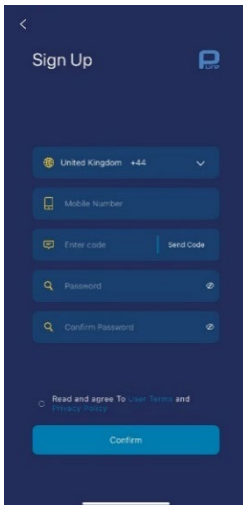

Download the PureCharger App from the App store

Sign up with the homeowner's phone number to register the EV charger

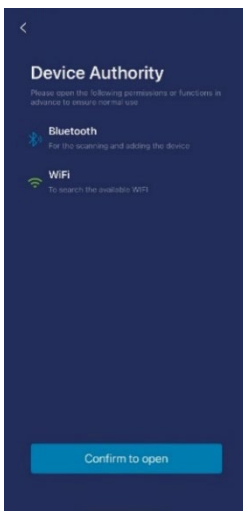

Confirm that your Bluetooth and location services are turned on for the App

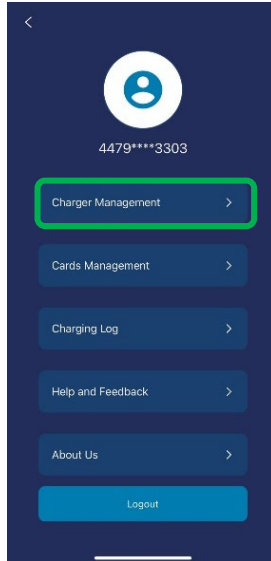
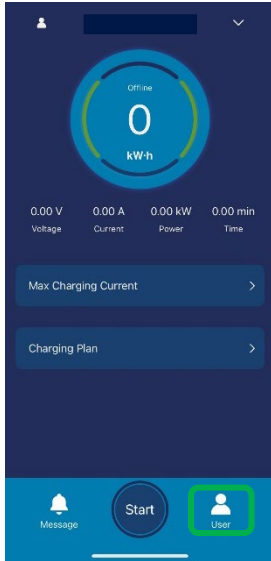

Select user → Charger Management → Wait for Charger to appear

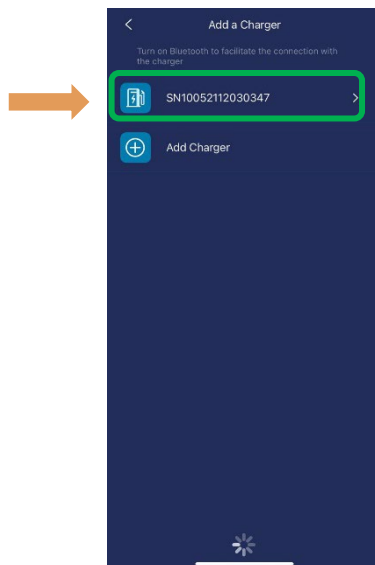

Please select the available charger



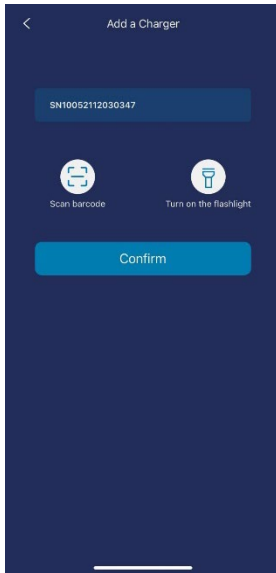

Please confirm the serial number on the side panel of your EV charger



Please open your phone's Wi-Fi setting



Connect to your Charger's Hotspot. This is usually the serial number of your Charger



Password:  
admin123

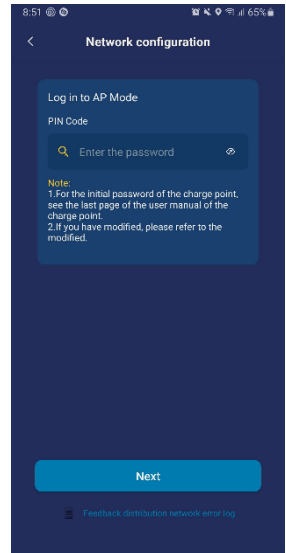

Please type in the provided Pin Code

Once you have successfully connected to the Charger's Hotspot, please open the PureCharger app and follow the next steps.

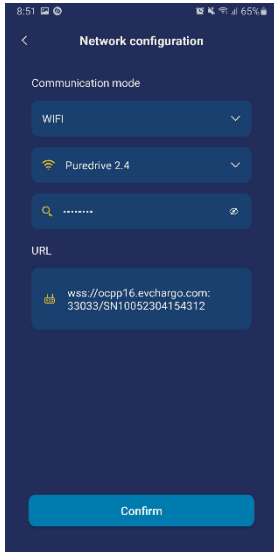

Complete the Wi-Fi  
setup

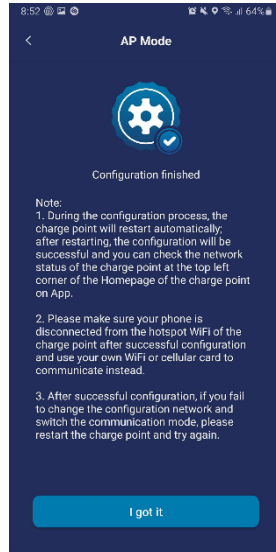

Configuration Finished!

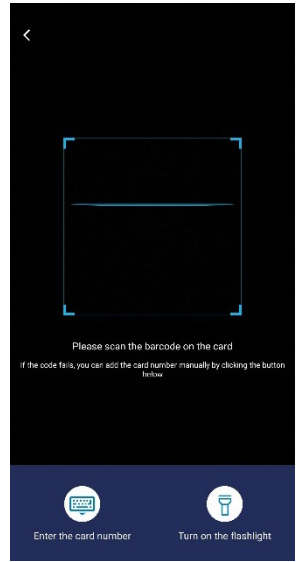
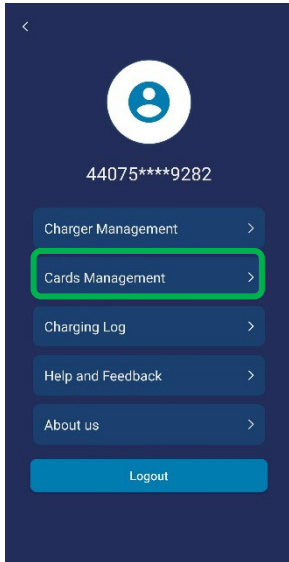

To register your RFID card,  
select **Cards  
Management**



Select **Add a Card**.



Scan the barcode on  
your card

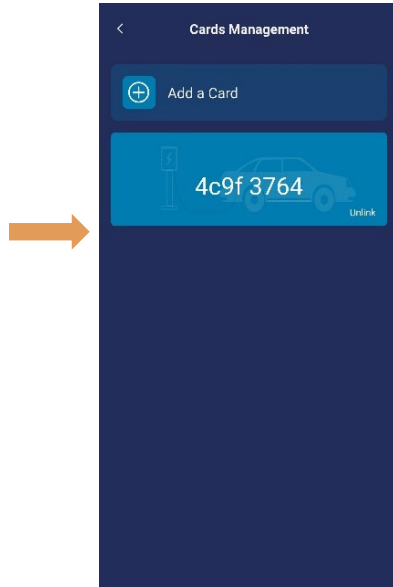

Your card should then be added here in Cards Management

## 7.2 Load balancing set up

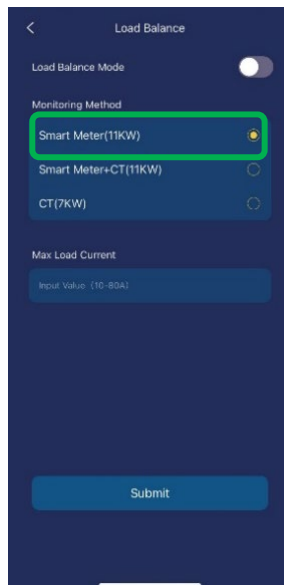
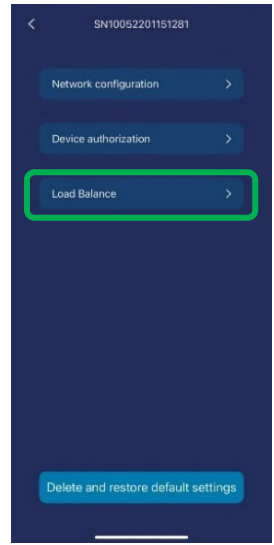
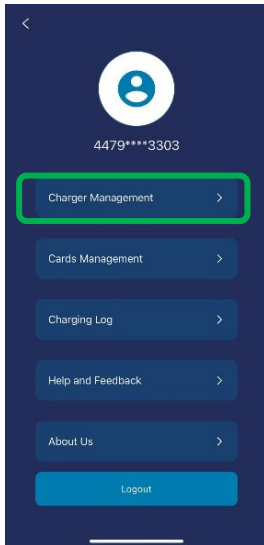

Please select CT (7kW)  
and type in the Max  
Load Current, then click  
submit.

### 7.3 Register the homeowner on the Duracell app

Use the Duracell app for the integration of products and additional charging modes.

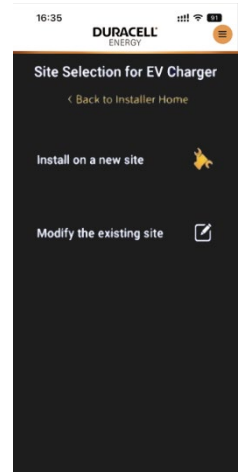
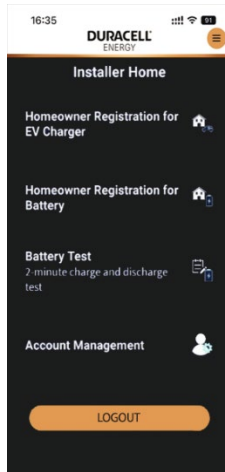
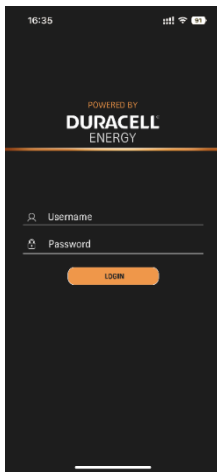

Download the Duracell App from the App Store

Enter the installer's Username and Password as shown. If the installer does not have Username & Password then contact:  
[duracellenergy.com/contact](http://duracellenergy.com/contact)



Please select the **Homeowner Registration for EV Charger**



If a Duracell battery system is installed, please select Modify the existing site.

If not, select Install on a new site.

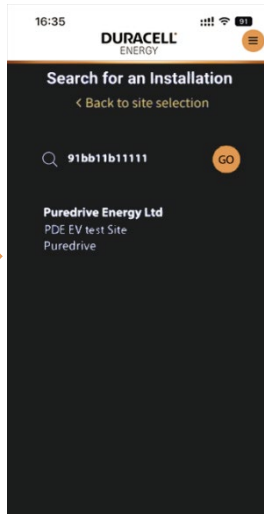

If you have selected **Modify the existing site**, please enter the app ID of the battery system. Then please select the site.

For the Duracell 5+, the app ID is the Solis Datalogger serial number.

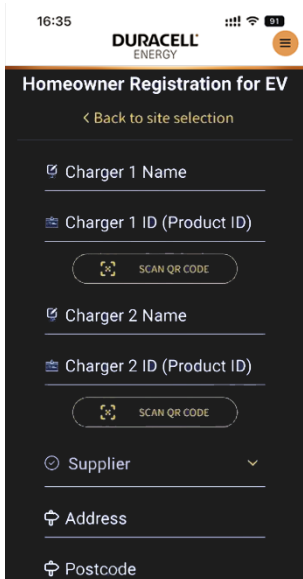

Enter the EV charger information.

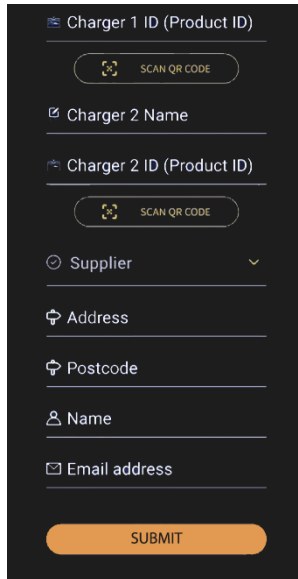

Enter the homeowner details and select the supplier.



Live usage page



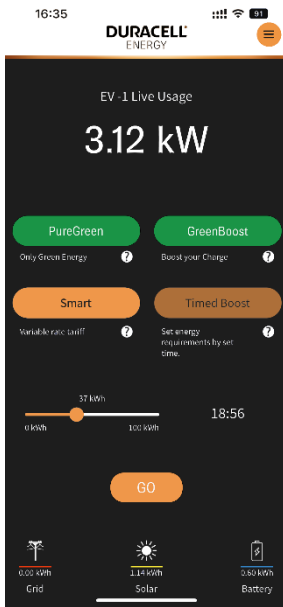

EV mode page

## 7.4 Charging operations on PureCharger App

Post-installation, the installer should test the EV Charger through the PureCharger app.

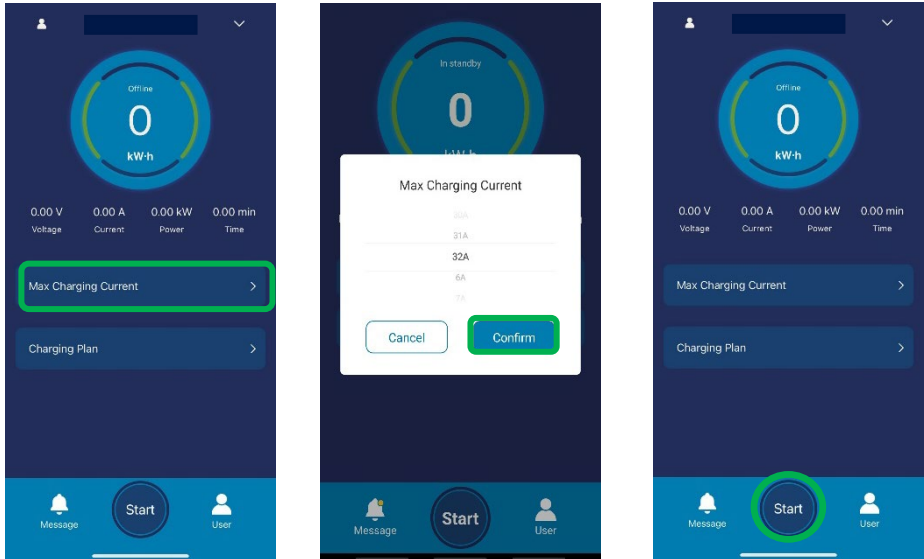

To Start the charging session, select **Max Charging Current**

Select your Max Charging Current and select **Confirm**

Select **Start** to begin charging your vehicle

### 7.5 Charging with RFID Card

- You can also start the charging session by tapping your RFID card on the front of the EV charger.
- Tap it on the area as highlighted by the green rectangle for approximately 3 seconds until a clicking sound is heard. Then the EV Charger will begin the charging session with the maximum possible charge rate.
- Repeat this same process to stop the charging session.

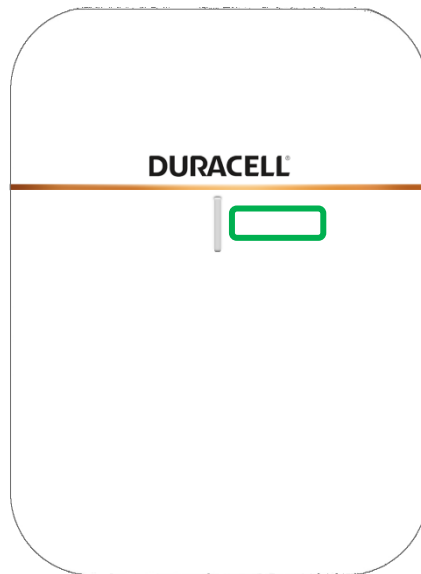

## 8 Configuration and Operation

### 8.1 Checks before Power-on

Please check/re-check the following items prior to the initial power-on:

- The location of the installed charger is convenient for operational access for normal use and maintenance.
- The AC input components within the premises' s power supply are correctly fitted with required protection items prior to installation of the charger.
- Any components or other tools have not been left on the top of the charger.

### 8.2 Power-on status checking

Power on the charger. The LED indicator should initiate as flashing white, 1 second on; 1 second off as the charger is in POST (Power on self-test).

State	Description	LED Status
POST	Power on self-test	Flashing White, 1 second on; 1 second off
Tamper Detection Alarm	The security switch for Tamper Detection is not activated	Solid Yellow
No Internet Access	The charger has not been network configured or the charger has no internet access.	Flashing Green for 1 second and flashing yellow for 1 second; 3 seconds off
Standby	Power-on, but no gun plug-in	Flashing Green, 1 second on; 3 seconds off
Ready to Charge	The gun is plugged in, but the charging session hasn't been initiated	Flashing Yellow, 1 second on; 3 seconds off
Charging in Progress	Charging in Progress	Breathing green, 1 second on; 1 second off
Fault detected	An error/ fault state has been detected. Please check the Troubleshooting section for error code details/ resolution	Flashing red or constantly red

### 8.3 Charging Operation

#### Connect the charger to EV

- a. Plug the charger gun into the EV Charging Port.
- b. After plug-in, please check the charger gun is connected securely.
- c. When the charger gun & EV connection is secured, the LED indicator will start flashing yellow, meaning the charger is ready to initiate a charging session.

#### Start Charging & Stop Charging.

The charging session can be initiated and stopped by the following options.

- a. By RFID card: Use the registered RFID card to start & stop the session.
- b. Plug & Play mode: In a situation with no internet connection access, the charger can be set into plug & play mode, meaning after plugging in the connector, the charging session will be initiated and after plugging out the connector, the charging session will be stopped, please contact Duracell Energy Ltd to enable this function.
- c. By App: The charger can be monitored and controlled by either PureCharger App or Duracell Energy App. Please refer to the user manual.

9 Troubleshooting  
 9.1 Indicator status

State	Description	LED Status
<b>In standby</b>	Normal	Flashing green, 1S on, 4S off
<b>Charging status</b>	Normal	Breathing green, 1S on, 1S off
<b>Plugged In gun state</b>	Normal	Breathing yellow, 1S on, 1S off
<b>Software upgrade</b>	Normal	Green light flash
<b>Ground warning</b>	Normal	Flashing yellow, 2S on, 2S off
<b>Relay adhesion</b>	Fault	Red light normally on
<b>Input polarity reverse</b>	Fault	Flashing red, 500ms on, 500ms off, 1 time, 3S off, Cycle
<b>CP fault</b>	Fault	Flashing red, 500ms on, 500ms off, 2 times, 3S off, Cycle
<b>Leakage current fault</b>	Fault	Flashing red, 500ms on, 500ms off, 3 times, 3S off, Cycle
<b>Input terminal overtemperature</b>	Fault	Flashing red, 500ms on, 500ms off, 4 times, 3S off, Cycle
<b>Relay overtemperature</b>	Fault	Flashing red, 500ms on, 500ms off, 5 times, 3S off, Cycle
<b>Under voltage fault</b>	Fault	Flashing red, 500ms on, 500ms off, 6 times, 3S off, Cycle
<b>Over voltage fault</b>	Fault	Flashing red, 500ms on, 500ms off, 7 times, 3S off, Cycle
<b>Overload fault</b>	Fault	Flashing red, 500ms on, 500ms off, 8 times, 3S off, Cycle
<b>Over frequency fault</b>	Fault	Flashing red, 500ms on, 500ms off, 9 times, 3S off, Cycle
<b>Under frequency fault</b>	Fault	Flashing red, 500ms on, 500ms off, 10 times, 3S off, Cycle
<b>Leakage current loop abnormal</b>	Fault	Flashing red, 500ms on, 500ms off, 11 times, 3S off, Cycle

9.2 Error code and resolutions

Error Code	Problems	Possible Causes	Solutions
<b>OverVolt</b>	Input over voltage	The AC input voltage may be too high.	1. Check the input voltage from the backend.
			2. If the voltage is over 253Vac for a short time, wait till the power supply recovers to the normal voltage range.
<b>UnderVolt</b>	Input lower voltage	The AC input voltage may be too low.	1. Check the input voltage from the back end.
			2. If the voltage is under 184Vac for a short time, wait till the power supply recovers to the normal voltage range.
<b>OverCurr</b>	Output overload	The AC output current may be too large.	1. Shut down the leakage current protection, then switch off the main power supply from the distribution board immediately.
			2. Check whether there is a low resistance connection between the AC output cables of the charger.
<b>OverFreq</b>	Input over frequency	The AC input frequency may be too high.	1. Check the input voltage frequency from the back end.
			2. If the frequency exceeds 63Hz for a short time, wait till the power supply recovers to the normal voltage range.
<b>UnderFreq</b>	Input lower frequency	The AC input frequency may be too low.	1. Check the input voltage frequency from the backend.
			2. If the frequency is lower than 47Hz for a short time, wait until the power supply recovers to the normal voltage range.
<b>OverTemp</b>	Over Temperature	The temperature may be too low inside the charger.	1. Check the surrounding conditions of the chargers installed and whether there is a heating device nearby. Make sure the environmental temperature is under 60°C.
<b>Over DCLeak</b>	Over leakage current	The leakage current to the earth may be too high.	1. Shut down the leakage current protection, then switch off the main power supply from the distribution board immediately.
			2. Check whether there is broken AC output cables or low-resistance connection to the earth.

<b>PhaseError</b>	Reverse connection	Reverse connection of L/N input cable.	1. Shut down the leakage current protection, then switch off the main power supply from the distribution board immediately.
			2. Check if AC input/output cables are normal and if inverse connection of L/N input cables.
<b>CableRCErr</b>	Charging cable connection abnormal	Poor connection of charging cable with EV/Charger.	1. Check if the charger gun is connected to EV securely.



## CONTACT US

**For general inquiries, complaints, questions, or claims, please visit:**

[duracellenergy.com/contact](https://duracellenergy.com/contact)



Duracell is a registered trademark of Duracell Batteries BV and Duracell U.S. Operations, Inc., used under license. All rights reserved. Manufactured under license by Puredrive Energy in units 18a & 18b, Orchard Industrial Estate, Evesham rd, Toddington, Cheltenham, GL54 5EB.