

Install the Enphase IQ Battery System

To install the Enphase **IQ Battery 3T** system or **IQ Battery 10T** system and the Enphase wall-mount bracket, read and follow all warnings and instructions in this guide. Safety warnings are listed at the end of this guide. These instructions are not meant to be a complete explanation of how to design and install an energy storage system. All installations must comply with national and local electrical codes and standards. **Only qualified electricians shall install, troubleshoot, or replace the IQ Battery 3T or IQ Battery 10T.**

The IQ Battery system includes the IQ Battery(ies) with integrated Enphase IQ Microinverters. The IQ Gateway measures PV production and home energy consumption. The IQ Battery system senses when it is optimal to charge or discharge the battery so that energy is stored when it is abundant and used when scarce. IQ Battery systems are capable of providing backup power when an IQ System Controller is installed at the site.

Five unique installation scenarios are shown:

Whole home backup with IQ System Controller as service entrance and PV combiner connected to IQ System Controller. This is the preferred configuration for back up of the entire main load panel. This configuration supports up to an 80 A breaker for the PV circuit and an 80 A breaker for battery storage.

- NOTE:**
1. For M215/M250 connection to Enphase Energy System, refer tech brief at <https://enphase.com/download/enphase-energy-system-planning-guide-tech-brief>.
 2. M Series Microinverters require IQ Gateway.

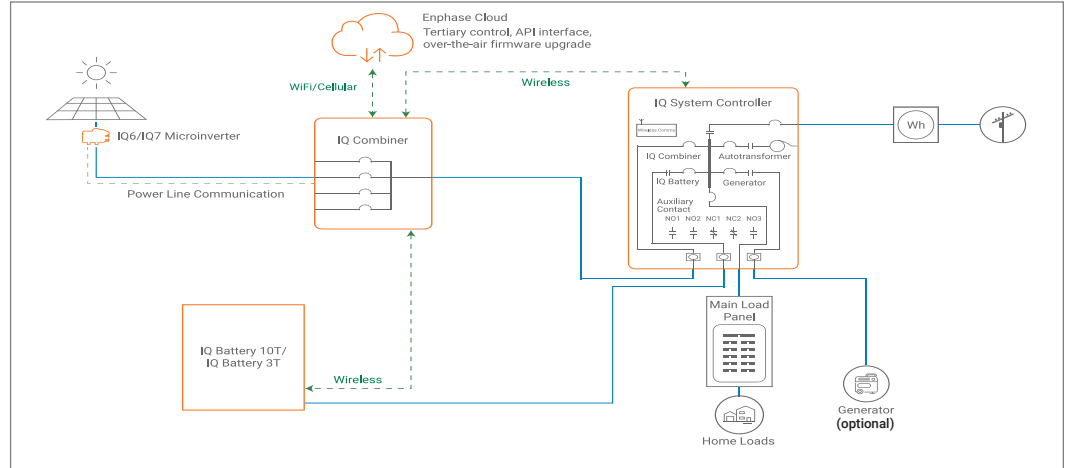

Whole home backup with IQ System Controller as service entrance and PV combiner connected to main load panel. This is the preferred configuration when you back up the entire main load panel, and the size of the PV combiner circuit is more than 80 A. In this configuration, the PV combiner connection space in IQ System Controller is left vacant. When existing PV combiner circuits are connected to the main load panel, and you want to add battery storage to the system, you can keep the PV combiner connected to the main load panel and connect only the battery storage to IQ System Controller.

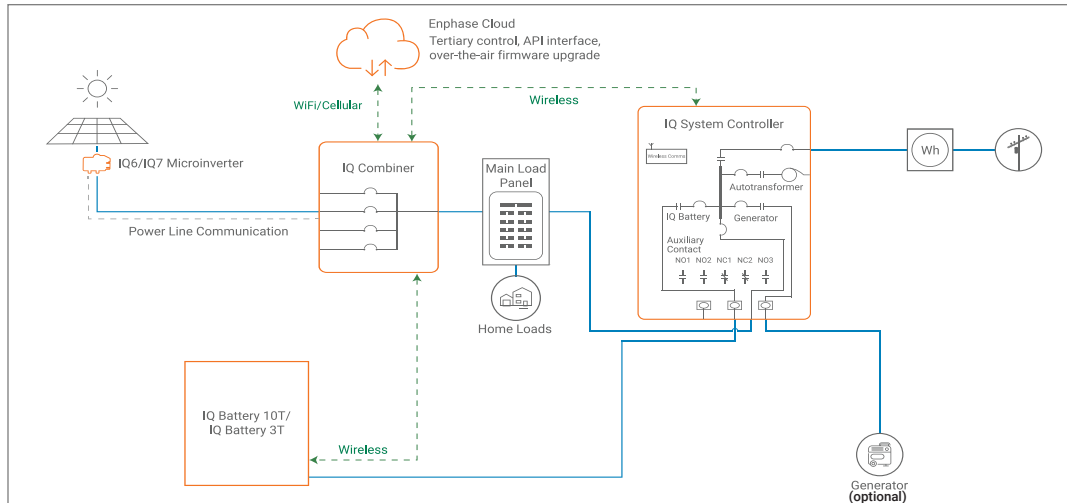

Partial home backup with main load panel as service entrance and PV combiner connected to IQ System Controller. When PV circuits breaker size is less than 80 A, this is the preferred configuration for partial home backup with subpanel.

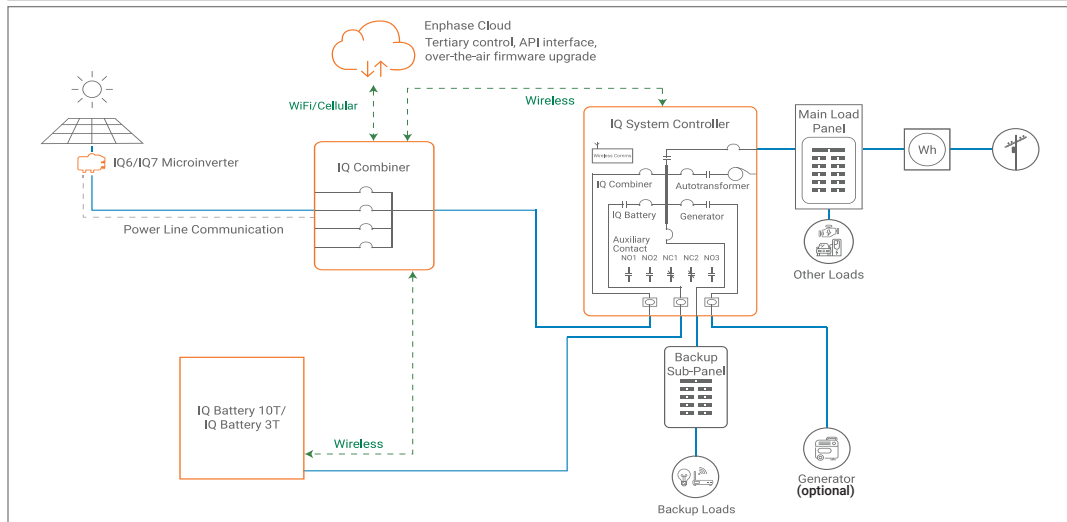

Partial home backup with main load panel as service entrance and PV combiner connected to subpanel. This is the preferred connection configuration for partial home backup using a subpanel when the PV circuit breaker size is more than 80 A. The space available in IQ System Controller for combiner (solar) connection is left vacant.

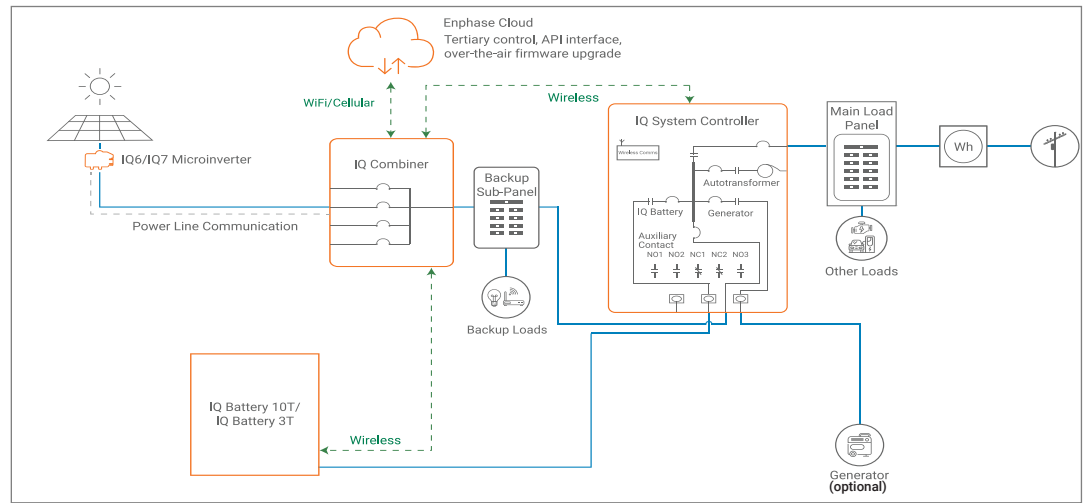

Self-consumption, no IQ System Controller. The preferred configuration when adding battery storage and PV for self-consumption in a grid-tied application with no option for backup during outages. PV and IQ Battery will not operate when the grid is unavailable.

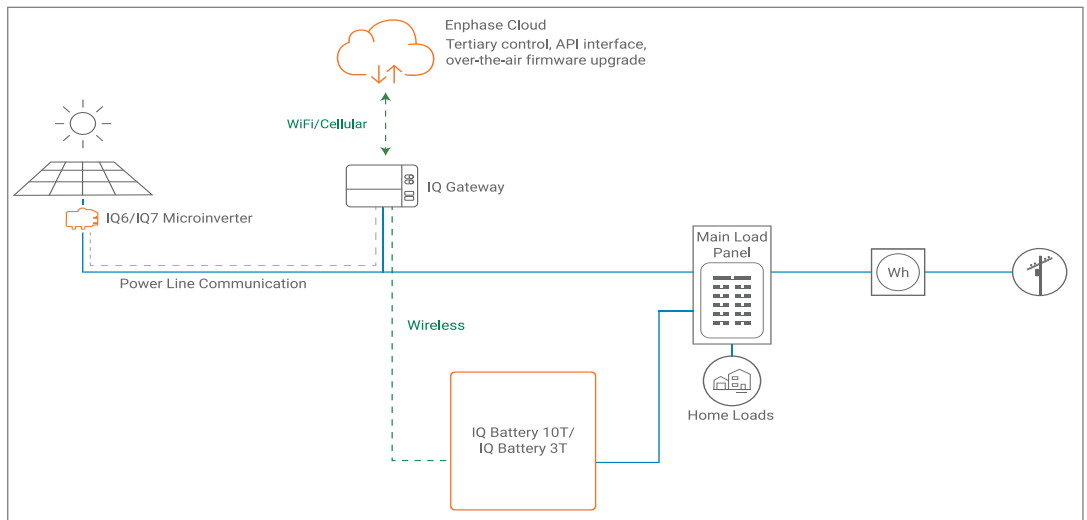

PREPARATION

- A) Inspect the packaging and the IQ Battery(ies) for damage, such as cracks, dents, or leaking electrolyte. **Do not install or use the IQ Battery(ies) if it has been damaged in any way.** If damaged, contact your distributor for replacement.
- B) Ensure that your kit includes the following IQ Battery components:
- The **IQ Battery 10T** includes three batteries and two interconnect cable assemblies, an IQ Battery 10T triple-width cover, top, middle, and bottom mounting brackets.
 - The **IQ Battery 3T** includes one battery, and single-width cover with a single-width mounting bracket.
- NOTE:** Check the “Energize By” label on the shipping box to verify that the IQ Battery(ies) will be installed by the date shown. If the date has passed, contact your distributor for next steps.
- ⚠ WARNING!** Risk of injury. Take care when lifting. The IQ Battery unit is heavy (40.5 kg/89.3 lbs) and requires two persons to lift.
- C) Ensure you have the following **required Enphase items for backup systems:**
- An IQ System Controller with microgrid interconnect device (MID) functionality and an Enphase IQ Combiner.
 - The IQ Battery system requires an Internet connection through the IQ Gateway in the IQ Combiner. Failure to maintain an Internet-connection may have an impact on the warranty. See enphase.com/warranty for full terms.
 - Wireless communications kit (COMMS-KIT-01) is to be installed at the IQ Gateway for communications with IQ Battery and IQ System Controller. It includes USB cable for connection to IQ Gateway/IQ Combiner and allows wireless communication with IQ Battery and IQ System Controller.
- D) Make sure you also have the following **required items:**
- Mounting location that is structurally suited to bear the weight of the IQ Battery(ies). Total weight for the IQ Battery 3T, including the IQ Battery base unit, cover and wall mount bracket, is 48.8 kg (107.6 lbs).

- Total weight for the IQ Battery 10T, including the three IQ Battery base units, cover, and wall mount bracket, is 152.1 kg (335.3 lbs). The wall must contain blocking studs that can bear the battery weight or can be of masonry or other suitable structure.
- Tools: conduit (with fittings and fitting tools), drill 5/32 inch pilot bit (or metric equivalent), screwdriver, socket wrench, torque wrench, level, wire stripper, and stud finder if installing on studs.
 - Fasteners for wall mount bracket. Slots are 9.2 mm (0.36"). Check with a structural engineer and local standards for requirements:
 - Single-width bracket for IQ Battery 3T:** A minimum of three #20(5/16") lag bolts or screws, 7.6 cm (3 inches) long (depending on attachment wall).
 - Triple-width bracket for IQ Battery 10T:** A minimum of fifteen #20 (5/16") lag bolts or screws, 7.6 cm (3 inches) long (depending on attachment wall).
 - Washers for use between fastener heads and wall-mount bracket.
 - Copper conductors: No. 14 - 8 AWG (11 mm/7/16 inch strip length) copper conductors (rated at 75°C or 90°C) for terminals.
 - Conduit fittings: 1/2 inch or 3/4 inch (left side) hubs are required for all installations, and NEMA Type 3R conduit fittings (hubs) are needed when installing outdoors.
 - Overcurrent protection: The overcurrent protection in IQ Battery is not branch circuit overcurrent protection and cannot be relied upon for that purpose. The branch circuit overcurrent protection is located in IQ System Controller or, when combining, in a separate combiner. See the IQ System Controller Quick Install Guide for more information.
 - Personal protective equipment (PPE) for handling lithium batteries as required by local safety standards.
 - Protective gloves for protection against sharp edges.
- E) Verify that main service is 120/240 VAC, and not 208/120 VAC. IQ Batteries cannot be installed where L1 to L2 measures 208 VAC.
- F) Note that the rated energy capacity of the battery is 3.36 kWh.
- G) Install the PV system and the IQ Combiner as directed by the Enphase installation manuals.

INSTALLATION

1 Plan a location for the IQ Batteries

The IQ Battery housing is NEMA type 3R and can be installed indoors or outdoors. The terminal blocks accept copper conductors of No. 14 - 8 AWG.

- A) **Following local standards**, choose a well-ventilated location where the ambient temperature and humidity are within -15°C to 55°C (5°F to 131°F) and 5% to 100% RH, non-condensing, preferably out of direct sunlight. The optimum ambient temperature range for installation location is 0°C to 30°C (32°F to 86°F). Provide smoke alarms in the residence in accordance with building, fire and installation codes.

WARNING! IQ Batteries have been evaluated by UL Solutions to UL9540A Standard for outdoor and non-habitable indoor residential installations. Installations in finished, non-habitable indoor spaces such as detached and attached garages, utility closets, basements and storage or utility spaces shall be permitted.

- B) **Ensure that the mounting location can sustain the total weight of the IQ Batteries and mounting bracket.** Total weight for the IQ Battery 3T, including the IQ Battery base unit, cover and wall mount bracket, is 48.8 kg (107.6 lbs). Total weight for the IQ Battery 10T, including the three IQ Battery base units, cover, and wall mount bracket, is 152.1 kg (335.3 lbs).

WARNING! The installer should install blocking between studs to ensure that no single stud carries the entire weight load of the IQ Batteries.

- C) Plan the mounting location to be at least 15 cm (six inches) off the ground and 15 cm (six inches) from the ceiling for IQ Battery 3T and IQ Battery 10T.

NOTE: Wherever local codes allow a smaller separation distance for Energy Storage installations, the minimum spacing around IQ Battery 10T must be at least six inches from the top, bottom, left, and right side of the product.

Keep the IQ Battery away from falling or moving objects, including motor vehicles.

WARNING! If mounted in the path of a motor vehicle, we recommend a mounting height that is 91 cm (thirty-six inches) minimum above the floor.

- D) Ensure that there are no pipes or electrical wires where you plan to drill.
 E) Plan to maintain at least 91 cm (thirty-six inches) of clearance in front of each IQ Battery.
 F) Consider the dimensions of the IQ Batteries, easy access, height, and length of cable when selecting the location.
 G) Select a location where you can interconnect to the IQ System Controller.
 H) Follow all local standards and restrictions set forth by authority having jurisdiction (AHJ).
 I) For installations with more than one IQ Battery 10T units, there must be a separate load center, subpanel, or circuit combiner with over current protection to combine the circuits, and you must run only one circuit for all the IQ Battery units to the IQ System Controller (or to IQ Combiner for grid-tied-only installations). You must select proper conductors and circuit breakers for these circuits according to local codes, standards, and other applicable requirements. The circuit breakers used would have to be suitable for back-feeding, per NEC 408.36(D). IQ System Controller supports up to a maximum of 80 A breaker for IQ Battery connection circuit.

Up to four IQ Battery 10Ts or twelve IQ Battery 3Ts can be safely connected to 80 A load center.

To do this, you can install as per the options presented in the image shown in next column.

- J) The maximum conductor size for IQ Battery 3T and IQ Battery 10T is 8 AWG and the maximum breaker rating with this conductor size is 40 A.

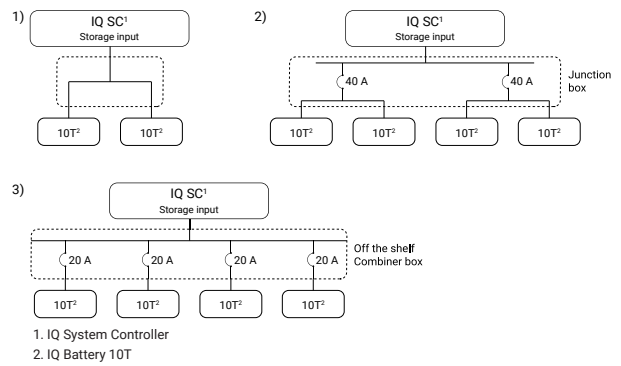

WARNING! Parallel power production sources only. Do not connect load circuits.

2 Install the AC disconnect

Following all local codes and standards:

- A) Install an AC disconnect that can break the maximum rated current of the branch circuit under load. The AC disconnect must be readily accessible and located within line-of-sight of IQ Battery units and IQ System Controller to combine the IQ Battery circuits together. All circuit breakers in the subpanel must be suitable for back-feeding, per NEC 408.36 (D).
- B) Each IQ Battery unit is suitable for use with up to No. 8 AWG wires on a maximum 40 A branch circuit. If more than 32 A of IQ Batteries (corresponding to a 40 A branch circuit) are installed, a separate subpanel must be installed between the IQ Battery units and IQ System Controller to combine the IQ Battery circuits together. All circuit breakers in the subpanel must be suitable for back-feeding, per NEC 408.36 (D).
- C) Verify that AC voltage at the site is within range: single-phase L1 to L2 voltage must measure between 211 VAC and 264 VAC, while L-N should measure between 106 VAC and 132 VAC.

3 Prepare to install the wall-mount bracket

- A) Make sure that the planned position for the wall-mount bracket meets clearance requirements as shown. The image depicts a single-width bracket for the IQ Battery 3T, but clearances and requirements are the same when installing a triple-width bracket for the IQ Battery 10T.
- B) **Ensure that the mounting location can sustain the weight of the IQ Batteries and mounting bracket.** Total weight for the IQ Battery 3T including the mounting brackets and cover is 48.8 kg (107.6 lbs), while the total weight for IQ Battery 10T including the mounting bracket and cover add up to 152.1 kg (335.3 lbs).
- C) Starting at installation position closest to the power source, mark a level line on the wall as a guide.
WARNING! Multiple risks. Make sure not to drill or attach into electric wiring or pipes that are in the wall!

Mounting on vertical stud

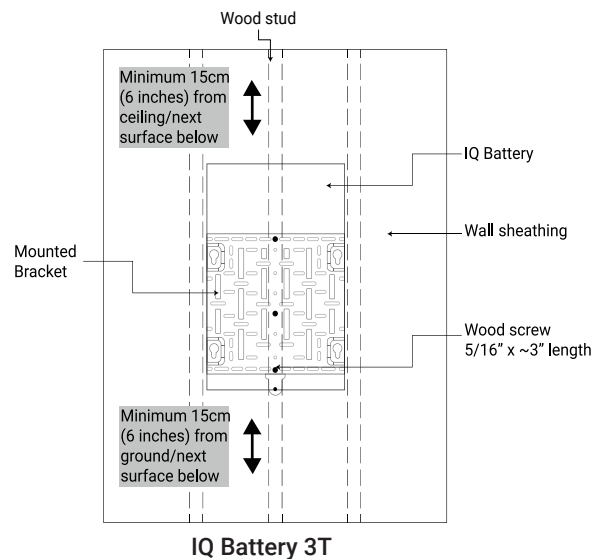

NOTE: The above shown image is just for reference. Use other slots on the wall mount if additional fixing is required for stability (to be assessed by the installer).

4 Install the IQ Battery 3T (single-width) or IQ Battery 10T (triple-width) wall mount bracket

Follow the instructions below for installing the bracket.

⚠ WARNING! Risk of injury and equipment damage. Attach the wall mount to the wall so that it is no more than five percent tilted from vertical. See the following image for reference:

Allowable tilt from vertical for IQ Battery installation:

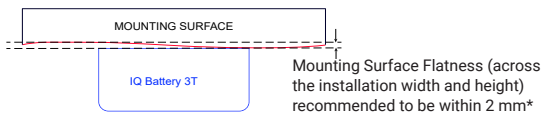
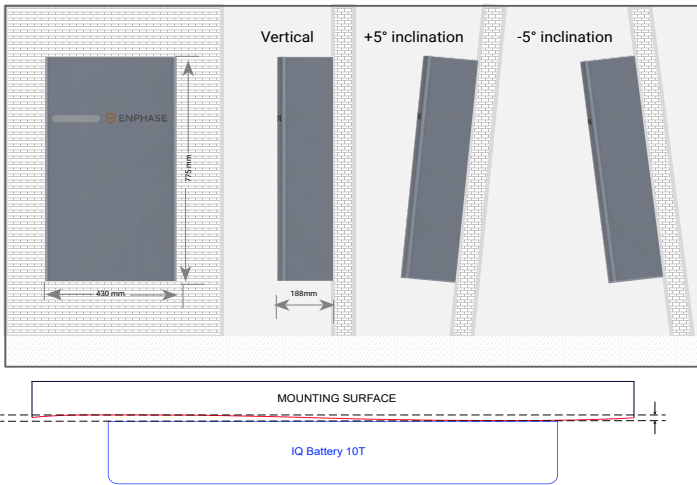

* If the difference in flatness is more than 2 mm, recommend installing a substructure like unistrut for better alignment of the units.

IQ Battery 3T – single-width bracket

A) Place the wall-mount bracket on the wall so that the mounting holes of the bracket align with the center of the stud.

⚠ WARNING! Risk of injury and equipment damage. Use the unit mounting holes only to mount the base unit of IQ Battery to the wall mount. Do not use the unit mounting holes to secure the bracket to the wall.

B) Use a level to keep the wall-mount bracket leveled.

C) Use #20 (5/16") screws (or masonry attachments for masonry) to attach the bracket using one screw and washer for each slot (9.2 mm/0.36"). Use minimum of three screws in each mounting bracket. Tighten all screws to manufacturer specified torque values.

D) Verify that the wall-mount bracket is solidly attached to the wall.

⚠ WARNING! Risk of injury and equipment damage. Do not mount an IQ Battery 3T on a bracket that is not properly mounted.

E) If installing additional batteries, install adjacent wall-mount brackets, as needed. Be sure to align the mounting holes in the wall-mount bracket to the center of the wall stud. You may install another row of brackets above the one already installed. Maintain at least 15 cm (six inches) vertical clearance between rows and 2.54 cm (1 inch) horizontal clearance between units of IQ Battery 3T installations, and ensure that the wall can support the structural load (weight) of the installation.

⚠ WARNING! Risk of injury and equipment damage. Do not install more than three IQ Battery 3T units per 20 A branch circuit.

Single-width mounting bracket

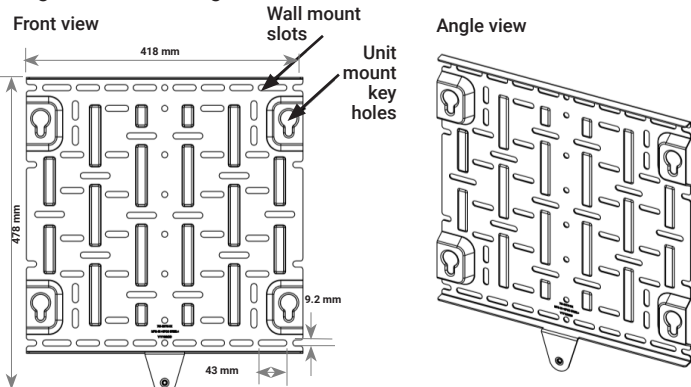

IQ Battery 10T – triple-width bracket

A) Place the middle wall-mount bracket on the wall so that the mounting holes of the bracket align with the center of the stud, and the mounting holes on the left and right align with the adjacent studs.

⚠ WARNING! Risk of injury and equipment damage. Use the unit mounting holes only to mount the base unit of IQ Battery to the wall mount. Do not use the unit mounting holes to secure the bracket to the wall.

B) Use a level to keep the wall-mount bracket leveled.

C) Use #20 (5/16") screws (or masonry attachments for masonry) to attach the bracket using one screw and washer for each slot (9.2 mm/0.36"). Use a minimum of six screws in each middle mounting bracket (within the red dotted rectangle) to support three IQ Battery units. There is an array of slots so that you can choose those that allow you to mount the bracket on studs. Tighten all screws to manufacturer specified torque values.

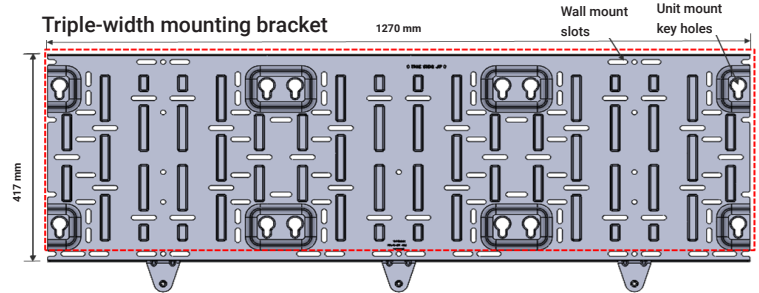

D) The screws on the area below the red dotted rectangle would be utilized in the next steps.

E) Verify that the wall-mount bracket is solidly attached to the wall.

F) Place the bottom wall-mount bracket below the middle bracket aligning the holes and edges as shown in the image below:

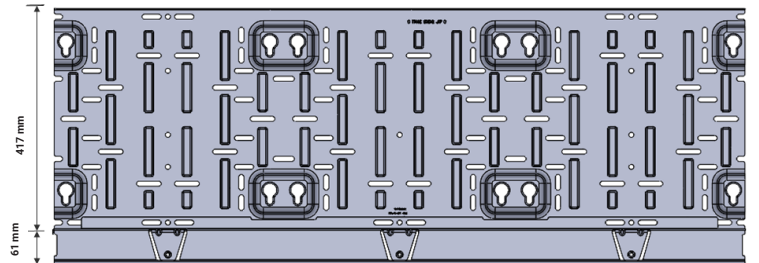

G) Use three number of #20 (5/16") screws and utilize three wall mount slots that are common between middle and bottom wall-mount brackets to attach bottom wall mount bracket on wall.

H) Place the top wall-mount bracket sitting on top of middle wall-mount bracket as shown in the image below:

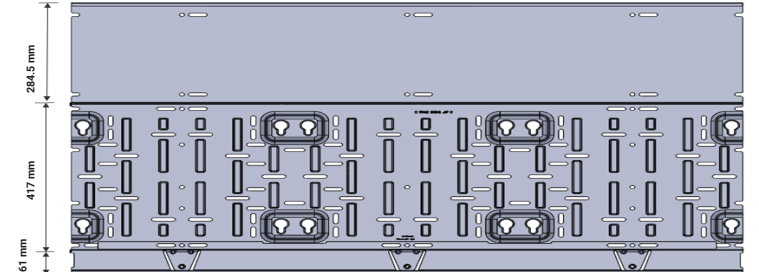

I) Use six number of #20 (5/16") screws and utilize six wall mount slots to attach top wall mount bracket on the wall.

⚠ WARNING! Risk of injury and equipment damage. Do not mount IQ Battery 10T batteries on a bracket that is not properly mounted.

J) If installing additional batteries, install adjacent wall-mount brackets, as needed. Be sure to align the mounting holes in the wall-mount bracket to the center of the wall stud. You may install another row of brackets above the one already installed.

Maintain at least 15 cm (six inches) vertical clearance between rows and 15 cm (six inches) horizontal clearance between units of IQ Battery 10T installations, and ensure that the wall can support the structural load (weight) of the installation.

⚠ WARNING! Risk of injury and equipment damage. Do not install more than one IQ Battery 10T unit per 20 A branch circuit.

5 Mount the IQ Battery(ies) on the wall

⚠ WARNING! Risk of injury. Take care when lifting. Each IQ Battery base unit is heavy (40.5 kg/89.3 lbs) and requires two persons to lift.

⚠ WARNING! Risk of injury and equipment damage. Avoid dropping the IQ Battery(ies). Doing so may create a hazard, cause serious injury, and/or damage the equipment.

⚠ WARNING! Risk of injury and equipment damage. Protect the IQ Battery(ies) from impact damage and improper use.

⚠ WARNING! Risk of injury and equipment damage. Do not hold the microinverters to lift the unit during installation.

- Two person together must lift a single IQ Battery base unit from the packaging and place it in upright position (as shown in image) on a flat surface.
 - Locate the IQ Battery lifting points:
 - The first person lifting must use points **a** and **d** (as shown) to lift the battery.
 - The second person lifting must use points **b** and **c** (as shown) to lift the battery.
 - Together, lift the IQ Battery and bring it to the already mounted bracket.
 - Hold the IQ Battery straight so that the four bolts on the back of the IQ Battery pass through the four key hole slots on the corner of the mounting bracket.
- ⚠ WARNING!** Risk of injury and equipment damage. Do not release the IQ Battery unit until you ensure that the IQ Battery unit is fully seated in the wall-mount bracket shelf.
- Once all four battery bolts fully pass through the mounting bracket key hole slots, lower the battery down until fully seated within the wall-mount bracket and set into the bottom of the key holes.
 - Attach the battery to the mounting bracket aligning the screw hole at the bottom of the battery with the screw hole at the bottom of the bracket. Tighten the bottom screw to 8 N m (70.8 lb-in).
 - To record the installation of each IQ Battery base unit, scan the serial number label using Enphase Installer App and your mobile device.

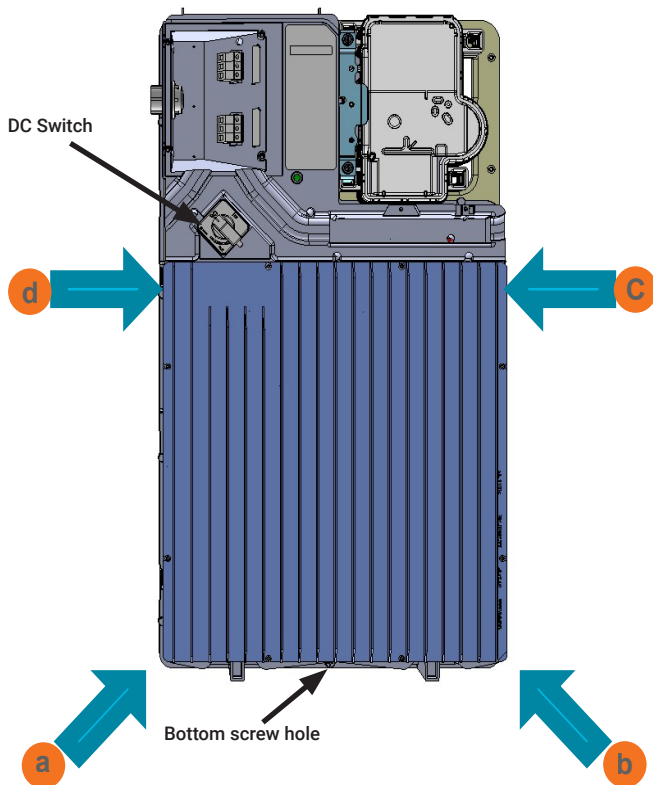

6 Prepare for field wiring

⚠ DANGER! Risk of electric shock. The DC switch must be in the locked position before performing this step.

- Drill the left wall of field wiring compartment to accommodate the conduit.
- Connect field wiring to the top three terminal blocks.
- Size the conductors (Lines and Ground) to account for voltage rise and to conform to the tables below. Design for a voltage rise of less than 2%. IQ Battery can use any circuit breaker size between 10 A and 40 A. Breaker rating and wire size are installation dependent.

Number of IQ3T/IQ10T units	Current (A)	Minimum wire size (AWG)	Breaker rating (A)
1*IQ3T	5.3	14	10
2*IQ3T	10.7	14	15
3*IQ3T or 1*IQ10T	16.0	12	20
4*IQ3T or (1*IQ10T + 1*IQ3T)	21.3	10	30
5*IQ3T or (1*IQ10T + 2*IQ3T)	27.7	8	35
6*IQ3T or 2*IQ10T or (1*IQ10T + 3*IQ3T)	32.0	8	40

*IQ3T refers to IQ Battery 3T

*IQ10T refers to IQ Battery 10T

In all cases in the table, it is possible to always use larger conductors and a breaker sized for that conductor or smaller. For Example in row 3, with 3 × IQ3T or 1 × IQ10T, it is possible to use:

- 12 AWG wire with 20 A breaker, or
- 10 AWG wire with 20 A or 30 A breaker, or
- 8 AWG wire with 30, 35, or 40 A breaker

⚠ DANGER! Risk of electric shock. Check that the dedicated circuit breaker protecting the branch where the IQ Battery(ies) will be connected is turned off before wiring.

⚠ WARNING! Risk of equipment damage. The DC switch must be OFF before installing, otherwise IQ Battery will try to form a grid.

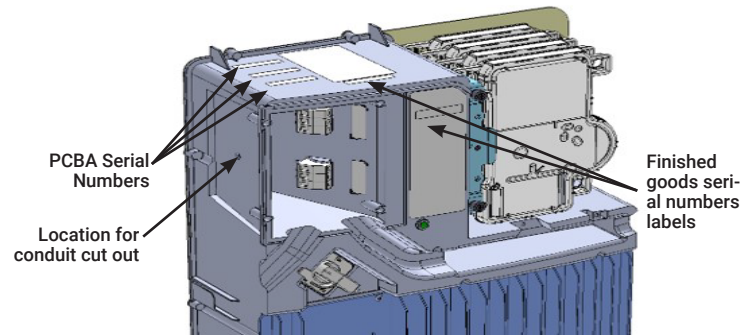

7 Install conduit and field wiring

⚠ DANGER! Risk of electric shock. The DC switch must be in the locked position before performing this step.

- If installing an IQ Battery 10T**, install the interconnect cable assembly.
 - Face the front of the batteries, and insert the interconnect cable assembly through the front cable slot from within the field wiring compartment, with the arm of the interconnect cable pointing up, making a "U" shape.
- Using the conductors and suitable conduits, connect the AC disconnect and the first adjacent IQ Battery. Use the conduit openings provided to connect the conduit and pass the wires through them. Note that if an IQ System Controller is in line-of-sight, the breaker can service as a disconnect.

⚠ WARNING! Risk of equipment damage. Do not modify or rewire the pre-installed wiring or bonding connections in the field wiring compartment.

⚠ WARNING! Risk of equipment damage. Always connect to two Lines (active) and one ground.

(CONTINUED ON NEXT PAGE)

7 Install conduit and field wiring (continued)

- C) Connect each wire in the field wiring component to its corresponding terminal (Lines and Ground). Each terminal accepts two 14-8 AWG conductors (11 mm/7/16 inch strip length). Tighten to 1.6 N m (14 lb-in).
- D) **If installing an IQ Battery 10T**, secure the inter-connection cable assembly between the IQ Battery units. You must connect the interconnect cable to the bottom three terminal blocks for the left unit and top three terminal blocks for the right unit.

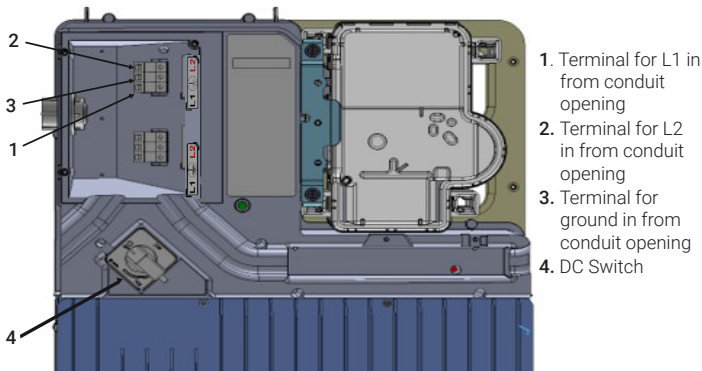

Ensure that the interconnect cable is properly seated in the slot.

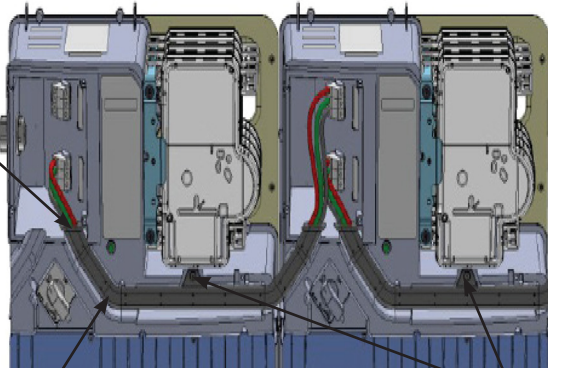

Interconnect cable

Assemble using two M4 screws from the cover accessories kit:
 Tighten to 1.9 N m/16.8 lb-in.

- E) After all wires in the field wiring component are connected and secured, check that there are no exposed conductors.
- F) If connecting additional IQ Batteries, use another conduit and another set of wires to connect between field wiring components.
- G) Gently arrange all the wires and connectors inside the field wiring component.
- H) Secure the field wiring component cover. Use a cross-head screw driver to tighten the cover screws to 2.3 N m (20.3 lb-in).
- I) Break tab 1, tab 2, or both tabs on the field wiring door along the yellow lines indicated for interconnect cable entry as shown.
- J) Do not break tabs when installing the IQ Battery 3T.

⚠ DANGER! Risk of electric shock. The system is not ready to be energized! Do not close the circuit breaker or turn ON the DC switch.

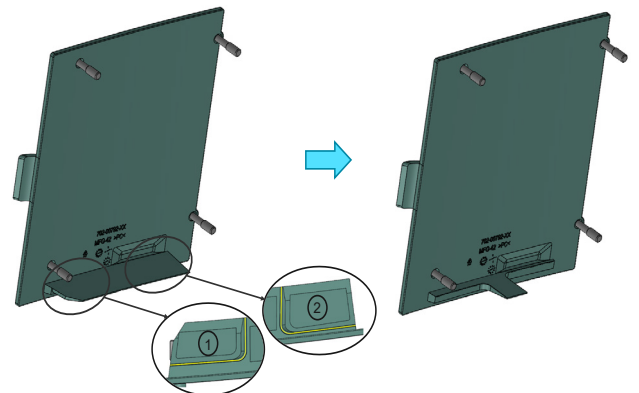
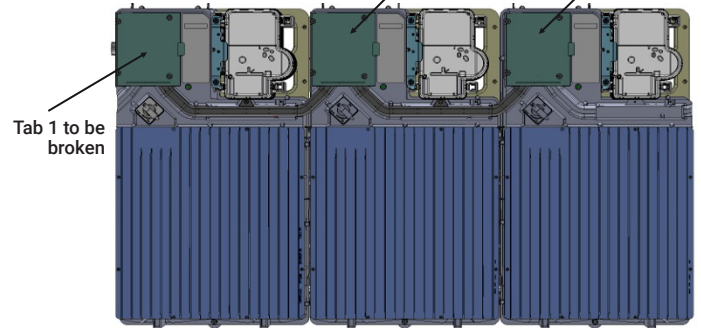
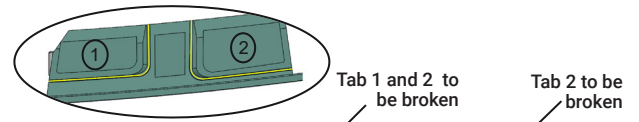
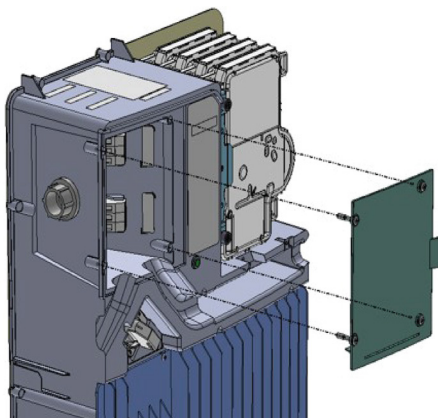

8 Cover and energize the system

⚠ WARNING: Before energizing, make sure that ALL IQ Batteries in the system are properly installed and conductors terminated.

⚠ WARNING! Risk of equipment damage. Ensure that no wires are pinched before replacing the cover.

NOTE: Check the box for updates on cover installation instructions.

IMPORTANT: The section 8 and 9 will depict instructions for assembly and disassembly of IQ Battery 3T cover, similar instructions are applicable for IQ Battery 10T cover.

- A) Check that the field wiring component cover(s) for all IQ Batteries in the system are closed and secured.

⚠ WARNING: Complete the IQ System Controller and IQ Combiner installations before turning the DC switch(es) ON.

⚠ DANGER: Risk of electric shock. Before continuing, check that IQ Battery units are properly wired, and ground connection does not have a L1 or L2 connection, as this introduces a safety hazard.

- Apply AC power to the IQ Battery circuits. Do NOT turn ON the IQ Battery DC switch(es).
- Use a Voltmeter to measure the IQ Battery chassis metal to ground (e.g., grounded conduit) voltage and ensure there is no AC voltage source present. If wiring is incorrect, a ground fault may exist, and the AC voltage may read ~120 VAC. If voltage is present, DO NOT touch the chassis, and immediately remove AC power from the IQ Battery circuits and correct the wiring.

⚠ DANGER: Risk of electric shock. AC voltage might be present at the output, when the DC switch is ON.

⚠ WARNING: Branch Circuit protection for IQ Battery MUST be ON (with AC voltage present) before turning DC switch ON. Wait for 15 seconds after turning branch circuit protection ON and check that LED on IQ Battery is ON (Any color LED is ON) before turning DC switch ON.

8 Cover and energize the system (continued)

- B) Turn ON the AC power first (branch circuit protection) and then turn ON the DC switches of the IQ Batteries.

NOTE: Do NOT leave the IQ Battery unit's DC switch in the ON position for any extended period of time (such as overnight or for more than 24 hours) unless IQ Battery is commissioned (communicating with IQ Gateway), connected to AC, and has passed functional testing and is operational. Leaving the DC switch ON without AC connection and communication with the system will drain the battery and may cause damage to the battery cells such that they no longer be able to charge. **Damage resulting from this improper installation and misuse is not covered under the product's limited warranty.**

- C) Slide the IQ Battery cover in the indicated direction so that the hook of the cover in the highlighted region goes into the slot provided for it in the main unit (both sides of the main unit).

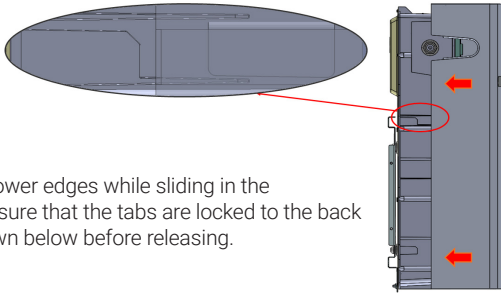

- D) Pull out the lower edges while sliding in the cover and ensure that the tabs are locked to the back plate as shown below before releasing.

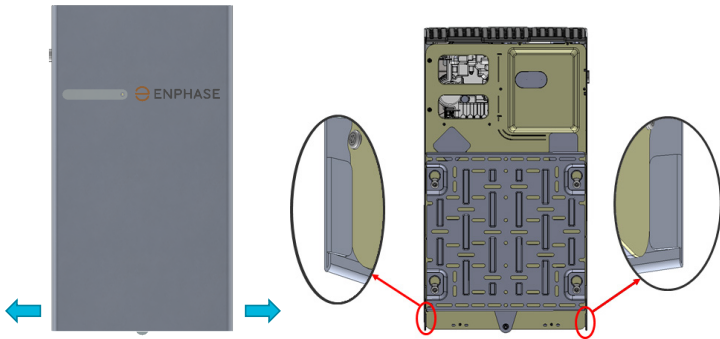

- E) Once the cover reaches the position as shown in the side view image, push the top portion of the cover and make sure that the cover is locked in place, in the indicated regions.

Before pushing into place:

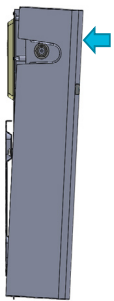

Locked into place:

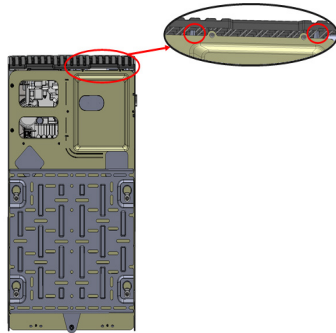

IQ Battery 3T cover

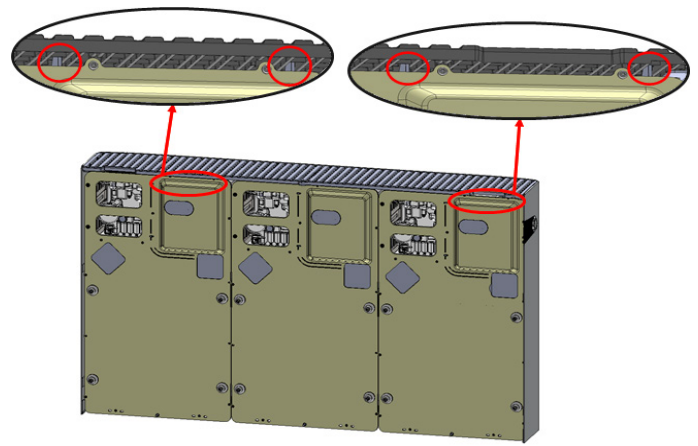

IQ Battery 10T cover

NOTE: Only for reference purpose, the IQ Battery 10T cover image is shown above for locking.

- F) After assembling the IQ Battery cover, remove the break-out tab from the conduit cover and assemble with the ribs snapping in as shown:

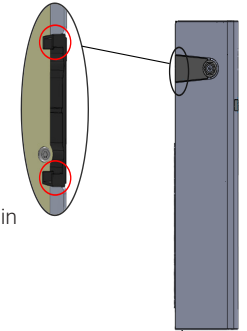

- G) Break the conduit cover tab along the yellow line as indicated before assembling to the main unit:

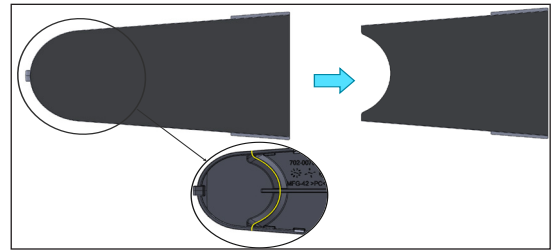

9 Disassembly of the IQ Battery cover

- A) Remove the conduit cover from the IQ Battery cover.

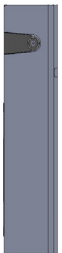

- B) Using the hand access slots pull the top plastic grill slightly in the direction shown below (in order to unlock the top plastic cover from the ribs highlighted in red):

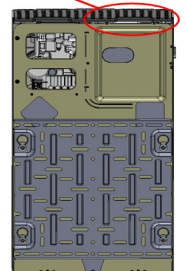
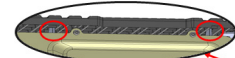
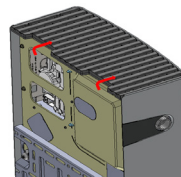

IQ Battery 3T cover

9 Disassembly of the IQ Battery cover (continued)

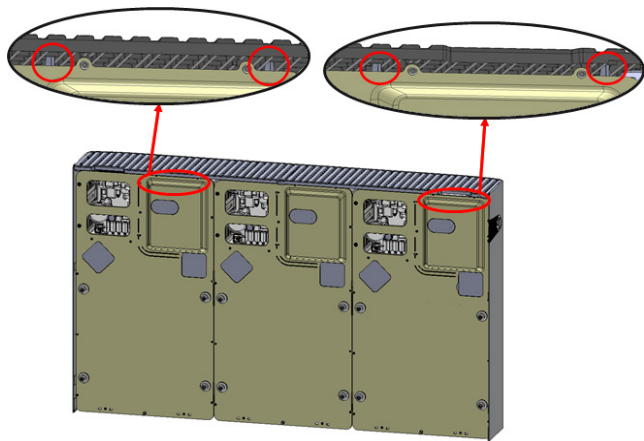

IQ Battery 10T cover

NOTE: Only for reference purpose, the IQ Battery 10T cover image is shown above for unlocking.

Ensure that the IQ Battery cover reaches the position shown in the side view image after the completion of the step B.

Before Step B

After Step B

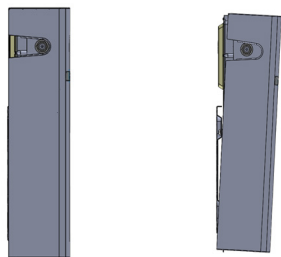

C) Pull out the lower portion of the cover in the directions shown below and move it away from the wall slightly (in order to unlock the highlighted angular tabs):

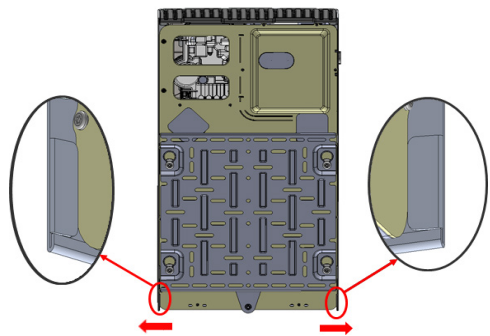

D) Pull out the cover in the indicated direction.

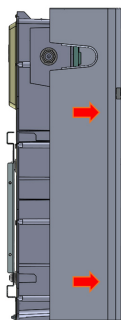

CONFIGURE and ACTIVATE

- Use the Enphase Installer App to commission the IQ Battery(ies). Once connected to the IQ Gateway, refer to the Enphase Installer App help topics for more information.
- After the IQ Gateway has detected the IQ Battery(ies), the IQ Battery LEDs operate as described in the following section.

OPERATION

a LED overview

After being commissioned, the LED flashes yellow while each IQ Battery boots up. If the LED rapidly flashes green for more than two minutes, the battery is in trickle charge mode and will remain so until it reaches a minimum state of charge (up to 30 minutes). After the IQ Battery is booted up, the LED becomes blue or green depending on the charge level. If the LED flashes yellow after one hour or changes to a flashing red state, contact Enphase customer support at enphase.com/en-us/contact/support.

State	Description
Uncommissioned	
Flashing blue	After booting up, IQ Battery has paired with an IQ Gateway but has not passed the commissioning three-way handshake to confirm that it is an Enphase device.
Flashing green	After passing the three-way handshake with the IQ Gateway.
After commissioning (normal operation)*	
Rapidly flashing yellow	Starting up/Establishing communications
Red flashes in sequences of 2	Error. See "Troubleshooting".
Solid yellow	Not operating due to high temperature. See "Troubleshooting".
Solid blue or green	Idle. Color transitions from blue to green as state of charge increases. Check Enphase Installer App for charge status.
Slowly flashing blue	Discharging
Slowly flashing green	Charging
Slowly flashing yellow	Sleep mode activated
Off	Not operating. See "Troubleshooting".

* IQ Batteries have a one-hour orphan timer. If the IQ Gateway stops communicating with them, after one hour the IQ Batteries return to an "uncommissioned" state.

b Operating mode and set points

IQ Battery supports multiple storage interactive system modes based on usage.

- Using Enphase Installer App, select **Menu > Settings > Battery Storage**.
- Select one of three battery modes:
 - Self-consumption mode (default, no setting change required)
 - Savings mode
 - Full backup

For more information on Operation modes, refer to the **Storage System Owner's guide** at enphase.com/en-us.

c Troubleshooting

If the IQ Battery(ies) are not operating correctly, do the following. If the issue persists, contact Enphase at enphase.com/en-us/contact/support.

- If the IQ Battery(ies) do not operate, check the temperature in the room and increase cooling and/or ventilation as required. Check that the front, and top sides of the IQ Battery 3T and IQ Battery 10T have at least 15 cm (six inches) of unobstructed clearance.
- If the IQ Battery LED is off, turn off the breaker for the branch circuit, wait for at least one minute, and turn it back on.

NOTE: During a brownout or blackout, the IQ Battery powers down automatically. This is normal. When power is restored, it automatically starts up again.
- If you do not see IQ Battery information in Enphase Installer App, check that the IQ Gateway and the Internet-connection are working. If the issue persists, contact Enphase customer support at enphase.com/en-us/contact/support.

Limitation of use:

Your IQ Battery unit is not intended for use as a primary or backup power source for life-support systems, other medical equipment, or any other use where product failure could lead to injury, loss of life, or catastrophic property damage. Enphase disclaims any and all liability arising out of any such use of your IQ Battery unit. Further, Enphase reserves the right to refuse to provide support in connection with any such use and disclaims any and all liability arising out of Enphase's provision of, or refusal to provide, support for your IQ Battery device in such circumstances.

SAFETY

IMPORTANT SAFETY INSTRUCTIONS. SAVE THESE INSTRUCTIONS. This guide contains important instructions that you must follow during installation and maintenance of the Enphase IQ Battery(ies). Failing to follow any of these instructions may void the warranty (enphase.com/warranty).

In Case of Fire or Other Emergency

In all cases:

- If safe to do so, switch off the AC breaker for the IQ Battery circuit, and if an isolator switch is present, switch off the AC isolator for the IQ Battery circuit.
- Contact the fire department or other required emergency response team.
- Evacuate the area.

In case of fire:

- When safe, use a fire extinguisher. Suitable types are A, B, and C dry chemical fire extinguishers. Additional extinguishing media include carbon dioxide, or alcohol-resistant foams.

In case of flooding:

- Stay out of the water if any part of the IQ Battery(ies) or wiring is submerged.
- If possible, protect the system by finding and stopping the source of the water, and pumping it away.
- If water has contacted Enphase equipment, such as IQ Battery(ies) or IQ System Controller, IQ Combiner, IQ Gateway they should be replaced. Please work with your installer to evaluate next steps.

In case of unusual noise, smell or smoke:

- Ensure nothing is in contact with the IQ Battery(ies) or in the venting area of the IQ Battery(ies).
- Ventilate the room.
- Contact Enphase customer support at <https://enphase.com/contact/support>.

Safety and advisory symbols

	DANGER: This indicates a hazardous situation, which if not avoided, will result in death or serious injury.
	WARNING: This indicates a situation where failure to follow instructions may be a safety hazard or cause equipment malfunction. Use extreme caution and follow instructions carefully.
	NOTE: This indicates information particularly important for optimal system operation. Follow instructions carefully.

Safety instructions

	DANGER: Risk of electric shock. Risk of fire. Only qualified electricians should install, troubleshoot, or replace the IQ Battery(ies).
	DANGER: Risk of fire or explosion. Only qualified personnel, using personal protective equipment (PPE) should transport or handle the IQ Battery(ies).
	DANGER: Risk of explosion. Do not dispose of IQ Battery(ies) in a fire or by burning. The IQ Battery(ies) can explode.
	DANGER: Risk of fire or explosion. This product is designed for stationary installation only and should be used accordingly. It is not designed for mobile applications such as installation and on vehicles and trailers and should not be used in such applications.
	DANGER: Risk of fire. During use, when stored, or during transport, keep the IQ Battery(ies) in an area that is well ventilated and protected from the elements, where the ambient temperature and humidity are within -15°C to 55°C (-5°F to 131°F) and 5% to 100% RH, non-condensing, preferably out of direct sunlight. Do not install the IQ Battery(ies) at elevations over 2,500 m (8,200 feet) above sea level.
	DANGER: Risk of fire. If the IQ Battery(ies) generate smoke, remove AC power from the Enphase System and turn the DC connect switch to the off position so that charging/discharging stops.
	DANGER: Risk of electric shock. Risk of fire. Do not attempt to repair the IQ Battery(ies). DO NOT OPEN THE ENCLOSURE – NO SERVICEABLE PARTS. Tampering with or opening the IQ Battery(ies) will void the warranty. If the IQ Battery(ies) fail, contact Enphase customer support for assistance at https://enphase.com/contact/support .
	DANGER: Risk of electric shock. Do not use Enphase equipment in a manner not specified by the manufacturer. Doing so may cause death or injury to persons, or damage to equipment.
	DANGER: Risk of electric shock. Do not install the IQ Battery(ies) without first removing AC power from the photovoltaic system. Disconnect the power coming from the photovoltaics before servicing or installing.
	DANGER: Risk of electric shock. Always de-energize the AC branch circuit during an emergency and/or before servicing the IQ Battery(ies). Never disconnect the DC switch under load.
	DANGER: Risk of electric shock. Risk of high short-circuit current. Observe the following precautions when working on batteries: <ul style="list-style-type: none"> • Remove watches, rings, or other metal objects. • Use tools with insulated handles. • Wear insulating gloves and boots. • Do not lay tools or metal parts on top of batteries.
	DANGER: Risk of electric shock. Risk of fire. Do not work alone. Someone should be in the range of your voice or close enough to come to your aid when you work with or near electrical equipment.
	DANGER: Risk of fire. Do not allow or place flammable, sparking, or explosive items near the IQ Battery(ies).
	DANGER: Risk of electric shock. In areas where flooding is possible, install the IQ Battery(ies) at a height that prevents water ingress.
	DANGER: Risk of electric shock. AC voltage is present at the output when the DC switch is on.

Safety instructions, continued

	DANGER: Risk of electric shock. Branch circuit protection must be off before switching DC power on or off.
	DANGER: Risk of electric shock. The DC switch must be locked in the OFF position for shipping and service.
	WARNING: Risks of electric shock, energy hazard, and chemical hazard. Do not disassemble.
	WARNING: Risk of equipment damage. During use, storage, transport, or installation, always keep the IQ Battery(ies) in an upright position.
	WARNING: You must install the IQ Battery(ies) only on a suitable wall using an Enphase wall-mount bracket.
	WARNING: Before installing or using the IQ Battery(ies), read all instructions and cautionary markings in this guide and on the equipment.
	WARNING: Do not install or use the IQ Battery(ies) if it has been damaged in any way.
	WARNING: Do not exceed the maximum number (3) of IQ Batteries in a 20 A AC branch circuit.
	WARNING: Do not sit on, step on, place objects on, or insert objects into the IQ Battery(ies).
	WARNING: Do not place beverages or liquid containers on top of the IQ Battery(ies). Do not expose the IQ Battery(ies) to liquids or flooding.
	WARNING: When placing the IQ Battery(ies) in storage, ensure that AC power is not present and that the DC switch is in the Locked position. While in storage, damage to the battery can occur from over-discharge. If the battery state of charge falls to 0%, the IQ Battery(ies) can be damaged or destroyed. Because of this, the IQ Battery(ies) must only be stored for a limited amount of time. <ul style="list-style-type: none"> • The IQ Battery(ies) must be installed and energized by the "Must Energize By" date on the shipping box label. • The IQ Battery(ies) must have a charge state of no more than 30% when placed in storage. To do this, the IQ Battery(ies) must be placed in Sleep Mode. • If the IQ Battery(ies) is already been installed, it must be placed into Sleep Mode prior to uninstalling. A battery in Sleep Mode can be stored a maximum of two months after being placed into Sleep Mode.
	NOTE: Perform installation and wiring, including protection against lightning and resulting voltage surge, in accordance with all applicable local electrical codes and standards.
	NOTE: Because IQ Battery(ies) are grid forming, you must install signage in accordance with NEC articles 705, 706, and 710.
	NOTE: Using unapproved attachments or accessories could result in damage or injury.
	NOTE: Install properly rated over current protection as part of the system installation.
	NOTE: To ensure optimal reliability and to meet warranty requirements, the IQ Battery(ies) must be installed and/or stored according to the instructions in this guide.
	NOTE: The IQ Battery(ies) are compatible only with the IQ Gateway communications gateway properly fitted with USB hub, USB radios, and production and consumption CTs . The IQ Gateway is required for operation of the IQ Battery(ies). Earlier versions of the IQ Gateway communications gateway are incompatible.
	NOTE: The IQ Battery(ies) are intended to operate with an Internet connection. Failure to maintain an Internet connection may have an impact on the warranty. See Limited Warranty for full terms and services (enphase.com/warranty).
	NOTE: When replacing IQ Battery(ies), you must replace with an IQ Battery(ies) of the same type, with the same AC current rating.
	NOTE: When disconnected and stored, no automatic charge of the battery is possible.
	NOTE: Properly mount the IQ Battery(ies). Ensure that the mounting location is structurally suited to bearing the weight of the IQ Battery(ies).
	NOTE: During use, storage, and transport, keep the IQ Battery(ies): <ul style="list-style-type: none"> • Properly ventilated • Away from water, other liquids, heat, sparks, and direct sunlight • Away from excessive dust, corrosive and explosive gases, and oil smoke • Away from direct exposure to gas exhaust, such as from motor vehicles • Free of vibrations • Away from falling or moving objects, including motor vehicles. If mounted in the path of a motor vehicle, we recommend a 91 cm (36-inch) minimum mounting height • At an elevation of lower than 2,500 m (8,200 feet) above sea-level • In a location compliant with fire safety regulations • In a location compliant with local building codes and standards
	NOTE: Conditions for the IQ Battery installation site apply also to storage conditions.



Environmental Protection

ELECTRONIC DEVICE: DO NOT THROW AWAY. Waste electrical products should not be disposed of with household waste. Proper disposal of batteries is required. Refer to your local codes for disposal requirements.

Revision history

REVISION	DATE	DESCRIPTION
140-00176-10	July 2023	Updated product graphics

Previous releases
