

## SDM230Modbus

### Single-Phase Two Module DIN rail Meters



- Measures kWh, kVarh, kW, kVA, PF, Hz, dmd, V, A, etc.
- Bi-directional measurement IMP & EXP
- Two pulse outputs
- RS485 Modbus
- Din rail mounting 35mm
- 100A direct connection
- Better than Class 1 / B accuracy

## User Manual V1.7

### Application

The energy-meters “with a white back-lighted LCD screen for prefect reading” are used to measure single-phase like residential, utility and industrial application. The unit measures and displays various important electrical parameters, and provide a communication port for remote reading and monitoring. Bi-directional energy measurement makes the unit a good choice for solar PV energy metering.

## PART 1 Specification

### General Specifications

Voltage AC (Un)	230V
Voltage Range	176~276V AC
Base Current (Ib)	10A
Max. Current (Imax)	100A
Mini Current (Imin)	0.5A
Starting Current	0.4% of Ib
Power Consumption	<2W/10VA
Frequency	50/60Hz(±10%)
AC Voltage Withstand	4KV for 1 minute
Impulse Voltage Withstand	6KV-1.2uS waveform
Overcurrent Withstand	30 Imax for 0.01s
Pulse Output Rate	
-Pulse Output 1	1000/100/10/1 imp/Exp/kWh/kVArh (configurable)
-Pulse Output 2	1000imp/kWh (default) for import kWh
Display	LCD with white backlit
Max. Reading	999999.9 kWh/kVArh

### Accuracy

Voltage	0.5% of range maximum
Current	0.5% of nominal
Frequency	0.2% of mid-frequency
Power factor	1% of Unity
Active power	1% of range maximum
Reactive power	1% of range maximum
Apparent power	1% of range maximum
Active energy	Class 1 IEC62053-21 Class B EN50470-1/3
Reactive energy	Class 2 IEC62053-23

### Environment

Operating temperature	-40°C to +70°C
Storage and transportation temperature	-40°C to +70°C
Reference temperature	23°C ± 2°C
Relative humidity	0 to 95%, non-condensing
Altitude	up to 2000m
Warm up time	5s
Installation category	CAT III
Mechanical Environment	M1
Electromagnetic environment	E2
Degree of pollution	2

### Output

#### Pulse Output

The meter provides two pulse outputs. Both pulse outputs are passive type.

Pulse output 1 is configurable. The pulse output can be set to generate pulses to represent total / import/export kWh or kVArh.

The pulse constant can be set to generate 1 pulse per: 0.001(default) /0.01/0.1/kWh/kVArh.

Pulse width: 200/100/60ms

Pulse output 2 is non-configurable. It is fixed to import kWh. The constant is 1000imp/kWh.

#### RS485 output for Modbus RTU

The meter provides a RS485 port for remote communication. Modbus RTU is the protocol applied. For Modbus RTU, the following RS485 communication parameters can be configured from the Set-up menu.

**Baud rate:** 1200, 2400, 4800, 9600 bps. Default: 9600bps

**Parity:** NONE/EVEN/ODD Default:NONE

**Stop bits:** 1 or 2

**Modbus Address:** 1 to 247

### Mechanics

Din rail dimensions	36x100x63 (WxHxD) DIN 43880
Mounting	DIN rail 35mm
Ingress protection	IP51 (indoor)
Material	self-extinguishing UL94V-0

LCD display

Item	Descriptions
1	7 digits used to display measured values or RTC
2	Total value
4	Import information, Export information
5	Max. Demand for Power or Current
6	Pulse output 1 and Pulse output 2
7	Measurement units
8	PF = power factor Hz = frequency
9	Bar display of Power
10	Communication indicator
11	Time information
12	Low battery warning
13	Lock symbol



## PART 2 Operation

### Initialization Display

When it is powered on, the meter will initialize and do self-checking.

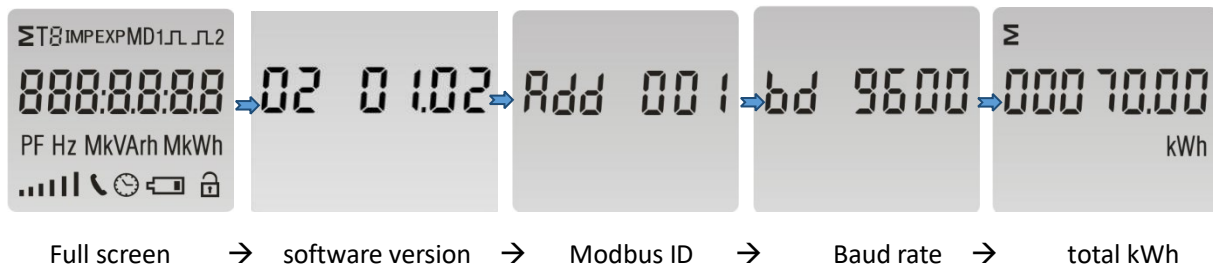











### Scroll display by Button





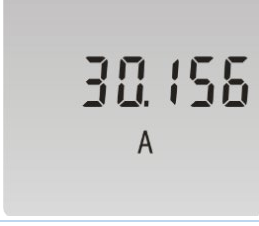
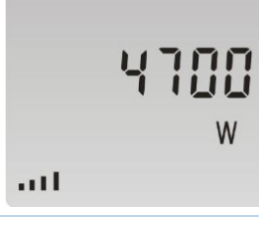
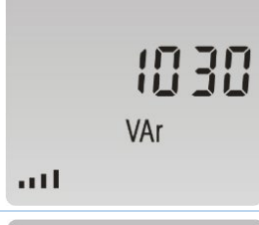
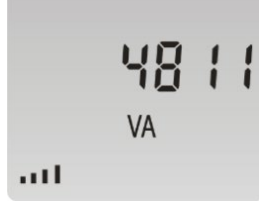

After initialization and self-checking program, the meter display the measured values. The default page is total kWh. If the user wants to check other information, he needs to press the scroll button on the front panel.

The display order by scroll button  :

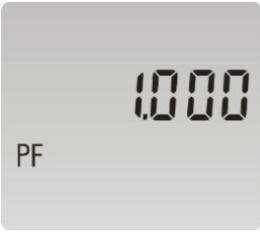
Total kWh → import kWh → export kWh → resettable kWh → total kVAh → import kVAh → export kVAh → resettable kVAh → Max. power demand → voltage → current → W → VAr → VA → power factor → frequency → pulse constant → Modbus ID → baud rate → continuous running time.

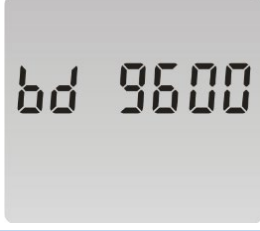

Page	Display	Descriptions
1		Total active energy Example: 70.00kWh
2		Import active energy Example: 50.00kWh
3		Export active energy Example: 20.00kWh
4		Total resettable energy
5		Total reactive energy Example: 10.00kVArh
6		Import reactive energy Example: 5.00kVArh
7		Export reactive energy Example: 5.00kVArh

8		Total resettable reactive energy
9		Total Max. power demand Example: 6930W
10		Voltage Example: 229.8V
11		Current Example: 30.156A
12		Active Power Example: 4700W
13		Reactive Power Example: 1030VAr
14		Apparent power Example: 4811VA



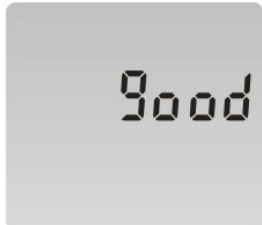

15		Power factor Example: 1.000
16		Frequency Example: 49.99Hz
17		Pulse constant Example: 1000
18		Modbus address Example: 001
19		Baud rate Example: 9600
20		Continuous running time(In total)

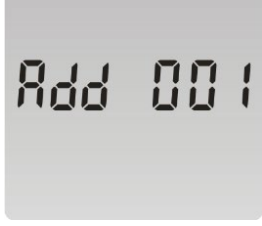
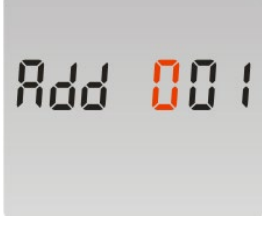
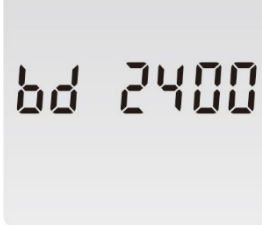
**Set-up Mode**



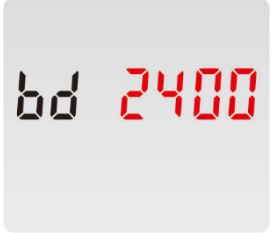
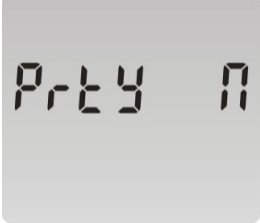

To get into Set-up Mode, the user need press the “Enter” button  for 3 second.

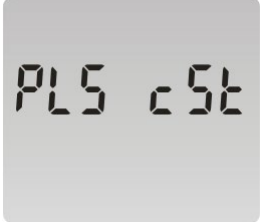
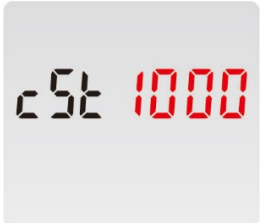
Page	Display	Descriptions
		The setting is done correctly
		The entering information is wrong. The operation fails.
1		<b>Password</b> To get into Set-up mode, it asks a password confirmation. Default password: 1000
2		<b>Address ID</b> Default ID is 001 Range: 001~247
2-1		Press the “Enter” button, the first digit flash. Press the “Scroll” button to change the value. After choosing the new address value, the user need pressing the “Enter” button to confirm the setting.
3		<b>Baud rate</b> Default value: 9600bps Range: 1200, 2400, 4800, 9600bps.

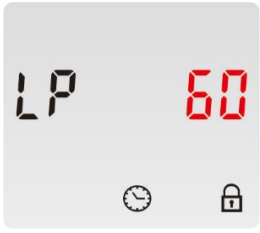
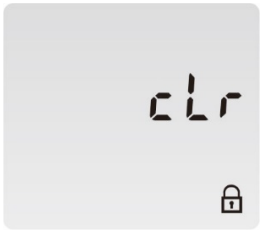

3-1		<p>Press the “Enter” button, the red digit flash. Press the “Scroll” button to change the value. After choosing the new baud rate, the user need pressing the “Enter” button to confirm the setting.</p>
4		<p><b>Parity</b> Default: None Option: None, Even, Odd</p>
4-1		<p>Press the “Enter” button, the red part flash. Press the “Scroll” button to change the option. After choosing the new Parity, the user need pressing the “Enter” button to confirm the setting.</p>
5		<p><b>Pulse Output</b> Default: Export kWh Option: kWh / kVArh / Imp. kWh / Exp.kWh / Imp.kVArh / Exp.kVArh</p>
5-1		<p>Press the “Enter” button, the red part flash. Press the “Scroll” button to change the option. After choosing the new Pulse output option, the user need pressing the “Enter” button to confirm the setting.</p>
6		<p><b>Pulse Constant</b> Default: 1000 Option: 1000 / 100 / 10 / 1</p>
6-1		<p>Press the “Enter” button, the red part flash. Press the “Scroll” button to change the option. After choosing the new Pulse constant option, the user need pressing the “Enter” button to confirm the setting.</p>

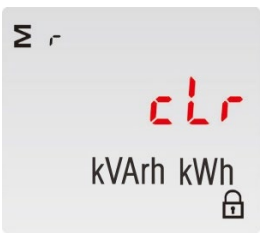
7		<p><b>Pulse duration</b>            Default: 100mS            Option: 200 / 100 / 60ms</p>
7-1		<p>Press the “Enter” button, the red part flash.            Press the “Scroll” button to change the option.            After choosing the new Pulse duration option, the user need pressing the “Enter” button to confirm the setting.</p>
8		<p><b>Demand Integration Time</b>            Default: 15 minutes            Option: 5 / 10 / 15 / 30 / 60 / OFF</p>
8-1		<p>Press the “Enter” button, the red part flash.            Press the “Scroll” button to change the option.            After choosing the new DIT option, the user need pressing the “Enter” button to confirm the setting.</p>
9		<p><b>Automatic Scroll Time Interval</b>            Default: 0 S            Option: 0 ~ 30S</p>
9-1		<p>Press the “Enter” button, the red part flash.            Press the “Scroll” button to change the option.            After choosing the new “Scrl” option, the user need pressing the “Enter” button to confirm the setting.</p>
10		<p>Backlit lasting time set-up            Default: 60 min            Option: 0 (OFF) / 5/ 10/ 20/ 30/ 60            Long press “Enter” button to enter set-up mode.</p>

10-1		<p>Press the “Scroll” button to change the option. After choosing the new “Scrl” option, the user need pressing the “Enter” button to confirm the setting.</p>
11		<p>Clear Long press “Enter” to enter clear interface.</p>
11-1		<p>Clear Max demand of active power Long press “Enter” button to confirm the operation.</p>
11-2		<p>Clear the resettable energy From the “11-1” page, press “Scroll” button enter into the energy reset page. Long press the “Enter” button to confirm the operation.</p>
12		<p>Password Default: 1000</p>
12-1		<p>Press the “Enter” button, the red part flash. Press the “Scroll” button to change the value. After choosing the new password, the user need pressing the “Enter” button to confirm the setting.</p>

**Wiring and Dimension**

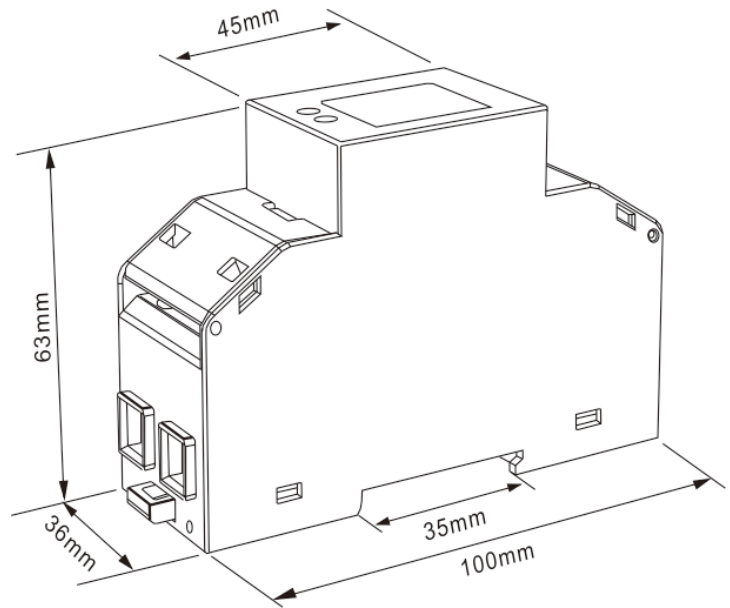
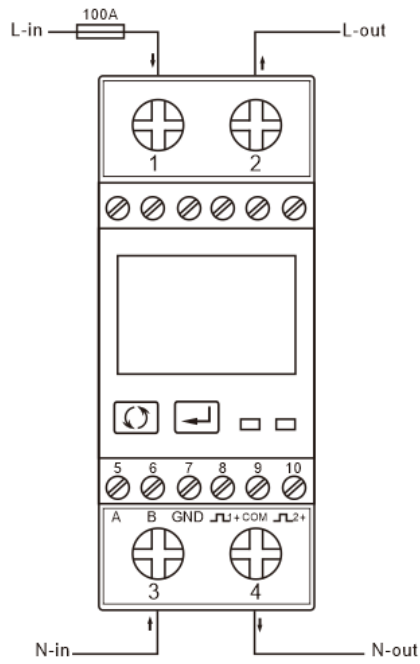

**Installation**

