

SigenStor Home

User Manual

Single-phase System

A1



Version: Draft A

Release date: 2023-05-17

Copyright Notice

Copyright © 2023 Shanghai SIGEN New Energy Technology Co., Ltd. All Rights Reserved.

Description in this document may contain predictive statements regarding financial and operating results, product portfolio, new technology, configurations and features of product. Several factors could cause difference between actual results and those expressed or implied in the predictive statements. Therefore, description in this document is provided for reference purpose only and constitutes neither an offer nor an acceptance. Shanghai SIGEN New Energy Technology Co., Ltd. may change the information at any time without notice.



SIGENERGY and other SIGEN Energy trademarks are owned by Shanghai SIGEN New Energy Technology Co., Ltd.

All trademarks and registered trademarks in this document belong to their owners.

Building 18, Pujiang High-tech Plaza, No. 2388, Chenhang Highway, Minhang District, Shanghai

www.sigenergy.com

Contents

Revision History	4
Overview	5
Chapter 1 Safety Precautions	6
Chapter 2 Introduction to energy storage system	9
2.1 Product Introduction	9
2.1.1 Function Introduction	9
2.2 Appearance Introduction.....	10
2.2.1 Appearance and Dimensions	10
2.2.2 Port Introduction	10
2.3 Label Description.....	12
2.4 Single-phase Network.....	13
Chapter 3 Site Selection Requirements	14
Chapter 4 Equipment Installation and Wiring	17
Chapter 5 System Operation	18
5.1 Working Mode.....	18
5.2 LED Indicator State	20
5.3 mySigen APP Query	22
Chapter 6 System Maintenance	23
6.1 Routine Maintenance	23
6.2 Equipment Powering-on/Power-off	24
6.3 Low SOC.....	26
6.4 Emergency Treatment	27
Chapter 7 Appendix	29
7.1 Technical Parameter	29

Revision History

Version	Date	Description
Draft A	2023.05.17	Test bureau version.

Overview

Introduction



This document mainly introduces the product introduction, networking, system operation and maintenance of the devices in the SigenStor Home single-phase system.

Readers

This document is suitable for product users and professionals

Sign Definition

The following signs may be used in the document to indicate security precautions or key information. Before installation and operation, familiarize yourself with signs and their definitions.

Signs	Definition
 Danger	Danger. Failure to comply may result in death or serious personal injury.
 Warning	Danger. Failure to comply may result in serious personal injury or property damage.
 Caution	Caution. Failure to comply will result in property damage.
Tips	Important or key information, and supplementary operation tips.

Chapter 1 Safety Precautions

Basic Information

Before installing, operating, and maintaining the equipment, familiarize yourself with this document.

The "Danger ", "Warning", "Caution" items described in this manual are only supplementary to all precautions.

The Company shall not be liable for equipment damage or property loss caused by the following reasons:

- Failure to obtain approval from the national, regional power authority.
- The installation environment does not meet international, national, or regional standards.
- Failure to observe local laws, regulations and norms when operating and maintaining equipment.
- The installation area does not meet the requirements of the equipment.
- Failure to follow the instructions and precautions in this document.
- Failure to follow the warning labels on equipment or tools.
- Negligent, improper operation or intentional damage.
- Battery capacity loss or irreversible damage caused by your failure to charge the device in time.
- Damage caused by your or a third party's replacement of our equipment (such as mixing our battery pack with other batteries, using our battery pack with other brands of inverters or converters, etc.).
- Equipment damage caused by improper operations such as disassembling, replacing, or modifying the software code without authorization.
- Equipment damage caused by force majeure (such as war, earthquake, fire, storm, lightning, flood, debris flow, etc.).
- Damage caused by the failure of the natural environment or external

power parameters to meet the standard requirements of the equipment during actual operation (for example, the actual operating temperature of the equipment is too high or too low).

- The equipment was stolen.
- The equipment is damaged after the warranty period.

Safety Requirements

Danger

- The overheated battery pack may cause fire or explosion. Do not expose the device to high temperature or heat sources (such as sunlight, fire, or heaters) around the equipment for a long time.
- Do not clean or soak the equipment with water, alcohol, or oil to avoid power leakage or battery pack leakage.
- Do not knock or impact the equipment. In case of an accident, please stop using the equipment immediately and contact your sales agent.

Danger

The equipment shall be inspected and evaluated by professional personnel before continuing to use.

Warning

- Do not touch the heat sink when the equipment is running.
- When the equipment is running, do not cover the decorative cover plate and keep the heat dissipation channel of 300-600mm to avoid fire at high temperature.

 **Caution**

- Do not use the equipment with faults. If the equipment appears abnormal (for example, battery pack leakage or appearance distortion), contact your sales agent.
- Carbon dioxide fire extinguishers and ABC dry powder fire extinguishers are recommended at home.
- If the equipment cannot be charged, please contact your sales agent in time.

Do not use the equipment in the following situations:

- When connected to public infrastructure systems.
- When connected to emergency medical equipment.
- When connected to elevators and other control devices.
- Any other critical systems.

Chapter 2 Introduction to energy storage system

2.1 Product Introduction

2.1.1 Function Introduction

The main function of SigenStor Home energy storage system is to store the direct current generated by photovoltaic panels into SigenStor EC 3.0/3.6/4.0/4.6/5.0/6.0 SP (SigenStor EC for short). Photovoltaic and SigenStor BAT 5.0/8.0 (SigenStor BAT for short) can also be converted into alternating current for use by the load or incorporated into the grid.

Model No.	Name
Sigen Energy Controller	
SigenStor EC 3.0 SP	Sigen Energy Controller 3.0 kW Single Phase
SigenStor EC 3.6 SP	Sigen Energy Controller 3.6 kW Single Phase
SigenStor EC 4.0 SP	Sigen Energy Controller 4.0 kW Single Phase
SigenStor EC 4.6 SP	Sigen Energy Controller 4.6 kW Single Phase
SigenStor EC 5.0 SP	Sigen Energy Controller 5.0 kW Single Phase
SigenStor EC 6.0 SP	Sigen Energy Controller 6.0 kW Single Phase
Sigen Battery	
SigenStor BAT 5.0	Sigen Battery 5 kWh
SigenStor BAT 8.0	Sigen Battery 8 kWh

2.2 Appearance Introduction

2.2.1 Appearance and Dimensions

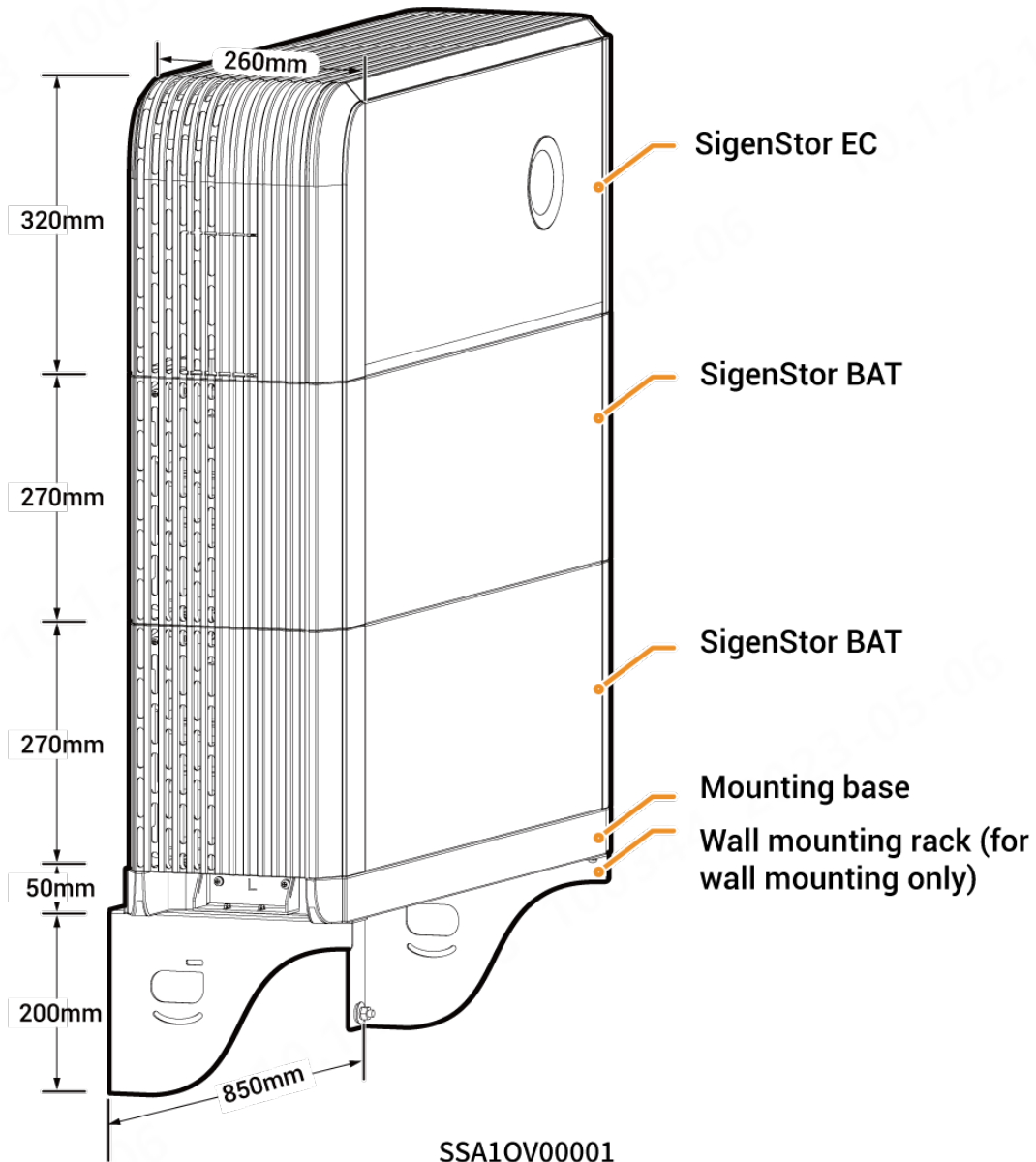

2.2.2 Port Introduction



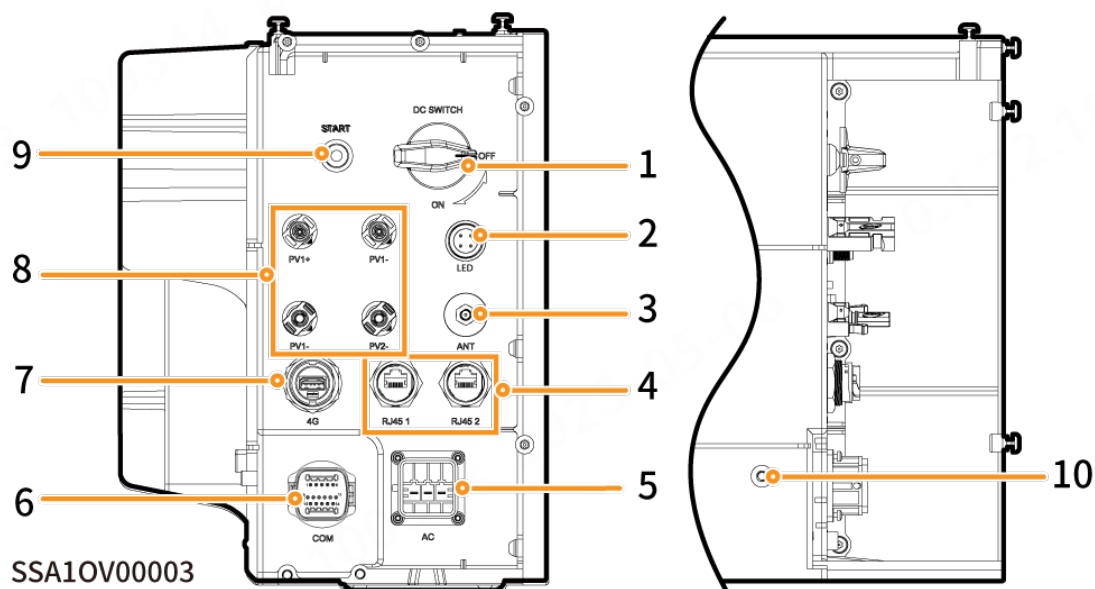

SigenStor EC(left side view)

SigenStor EC(rear view)



Serial No.	Name	Silk screen
1	Dc switch	DC SWITCH
2	Decorative cover light strip connector	LED
3	Antenna interface	ANT
4	Cable interface	RJ45 1/ RJ45 2
5	AC output interface	AC
6	Communication interface	COM
7	Sigen CommMod interface	4G
8	DC input interface	PV1+/PV2+/ PV1-/PV2-
9	Switch button	START
10	Ground screw	-

2.3 Label Description

Symbols	Definition
	<p>Warning! Life at risk.</p> <p>The inverter has potential hazards after running. Take proper protection when operating the inverter.</p>
	<p>After the inverter is powered off, the discharge of internal components is delayed. Wait 35 minutes until the inverter is fully discharged according to the label time.</p>
	<p>Warning! Risk of burns.</p> <p>The inverter surface is hot. Do not touch the inverter when it is running. Doing so may result in burns.</p>
	<p>Please refer to the instructions to operate the equipment.</p>
	<p>Earthing mark</p>

2.4 Single-phase Network

The SigenStor Home energy storage system consists of photovoltaic panels, SigenStor EC and SigenStor BAT, master control switches, loads, electricity meters, power grids, etc.

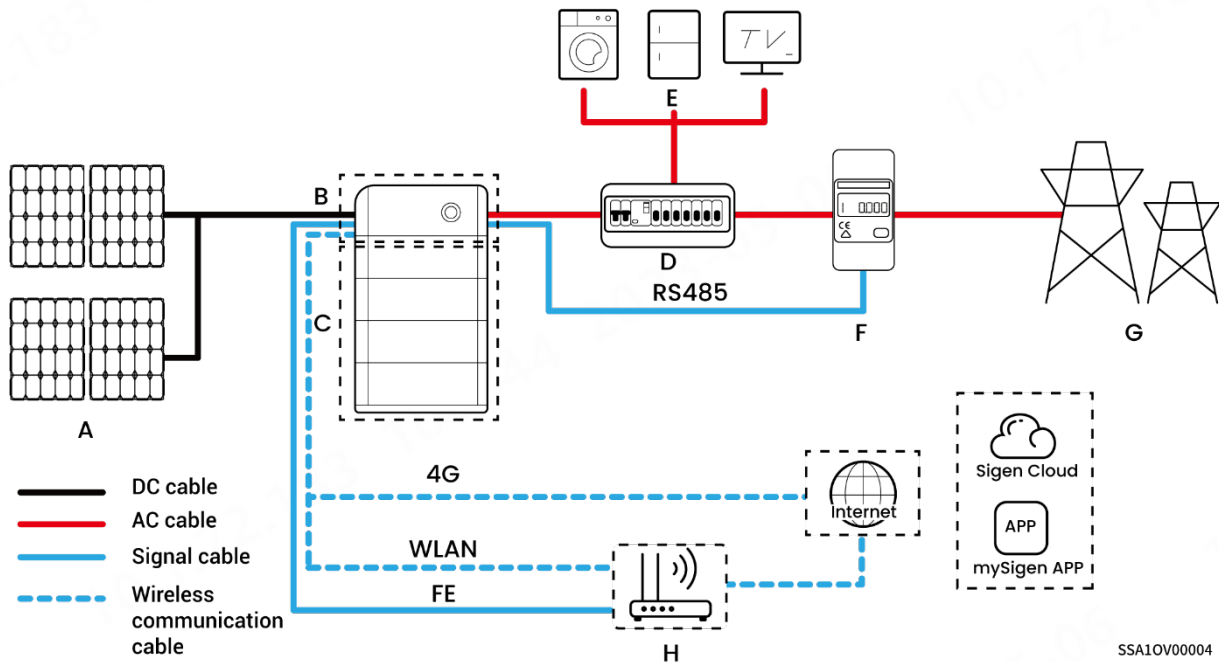

- A.** Photovoltaic panel **B.** SigenStor EC **C.** SigenStor BAT **D.** Master control switch **E.** Load **F.** Electric meter (Recommended model SDM230-Modbus) **G.** Grid **H.** Router

Chapter 3 Site Selection

Requirements

Installation Environment Requirements

- Do not install the equipment in smoky, flammable, explosive, or corrosive environments.
- Do not install the equipment outdoors in areas prone to salt damage area, which are located less than 500 meters from the coastline or affected by sea wind.
- Do not install the equipment in environments exposed to direct sunlight, rain, standing water, snow accumulation, sand, and dust. It is recommended to install in a sheltered location. If the area is susceptible to natural disasters such as floods, landslides, earthquakes, or typhoons, take preventive measures during equipment installation.
- Do not install the equipment in environments with electromagnetic interference.
- Ensure that the temperature and humidity of the installation environment comply with the equipment's requirements.







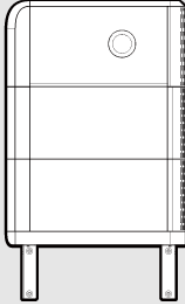

Installation Position Requirements

- Do not tilt or overturn the equipment to ensure that it is installed horizontally.
- Do not install the equipment in a place where children can easily reach it.
- Do not install the equipment in areas subject to fire or moisture (including but not limited to kitchen, tea room, toilet, shower room, laundry room, etc.).
- Please keep away from daily working and living areas (including but not limited to living room, bedroom, studio, lounge, study, etc.).
- Do not install the equipment in areas that are difficult to access (including but not limited to attic, basement, etc.).

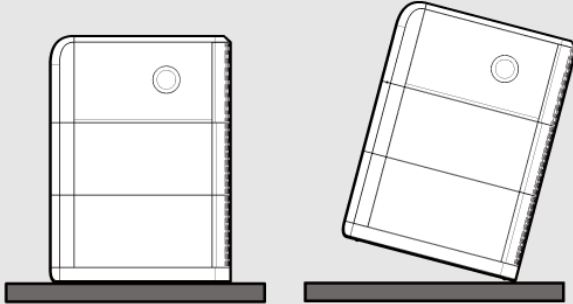
- Do not install the equipment in mobile scenarios such as RVS, cruise ships, and trains.
- You are advised to install the equipment in a position that is easy to operate, maintain, and view indicator status.
- When installing the equipment in the garage, do not install the equipment in the position where the vehicle passes through to avoid collision.

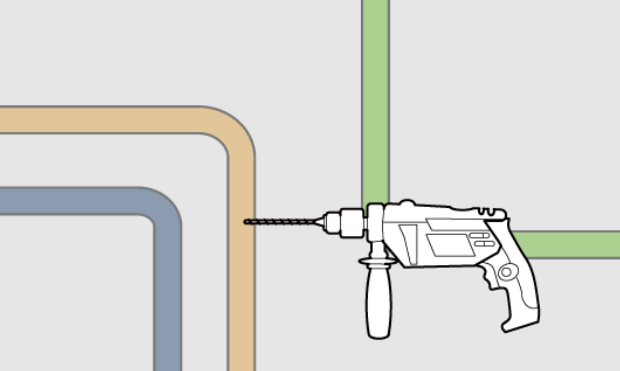
Mounting Surface Requirements

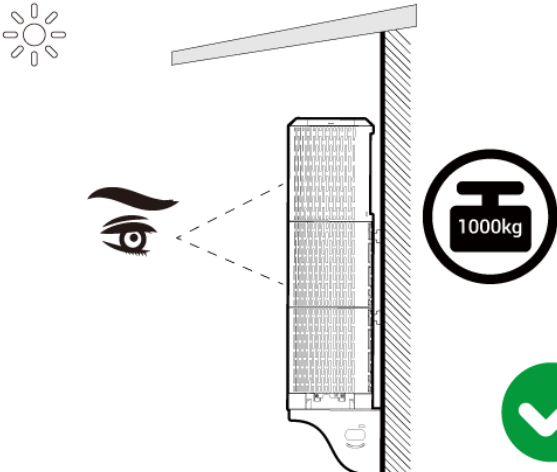
- Do not install the equipment on a flammable carrier.
- The installation carrier must meet load-bearing requirements. Solid brick-concrete structure, concrete walls, and ground are recommended.
- The surface of the installation carrier must be smooth and the installation area must meet the installation space requirements.
- No water or electricity is routed inside the carrier to prevent drilling hazards during equipment installation.

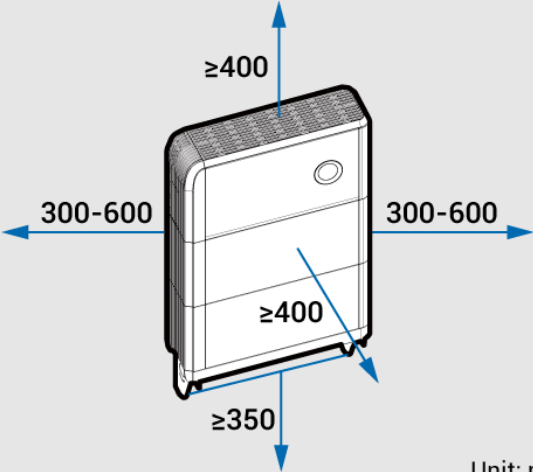
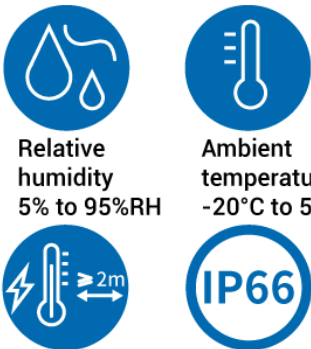
 	  
 	 
 <p style="text-align: right;">Unit: mm</p>	 <p>Relative humidity 5% to 95%RH</p> <p>Ambient temperature -20°C to 55°C</p> <p>Heat source (60°C)distance</p> <p>IP66</p> <p style="text-align: right;">SSA1SF00001</p>

Chapter 4 Equipment

Installation and Wiring

Only company authorized personnel should install and connect the equipment. For details, see SigenStor Home Installation Guide - Single-phase System A1.

Chapter 5 System Operation

5.1 Working Mode

The energy storage system has two operating modes, namely, Sigen AI Mode, Maximum Self-Powered Mode.

Sigen AI Mode

By recording the peaks and troughs of users' consumption habits and local electricity prices, Sigen AI mode can customize smart electricity solutions to maximize savings for customers.

Maximum Self-Powered Mode

When there is enough sunlight: the power generated by the photovoltaic panel is prioritized to the load, and the remaining power is charged to SigenStor BAT.

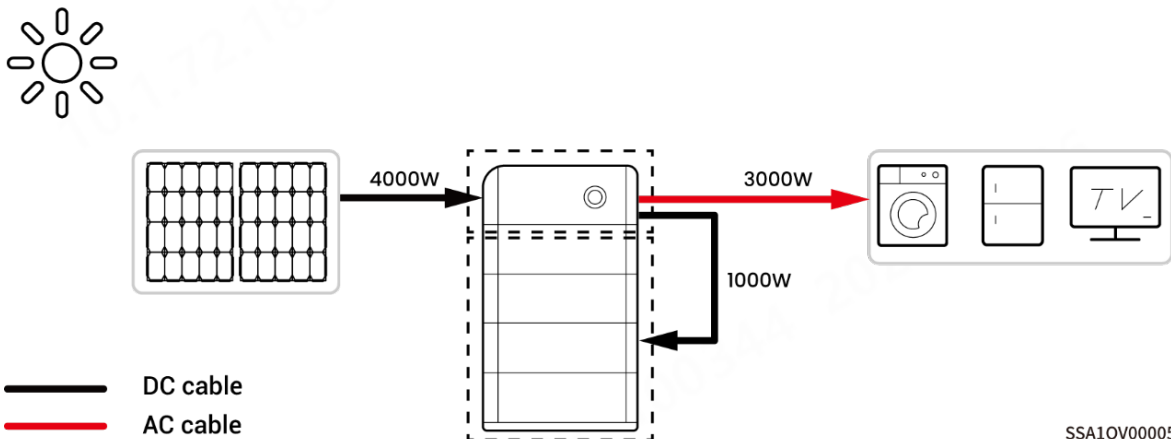

1. When sunlight is insufficient: the photovoltaic panel is not enough to support the load, and the remaining power is first provided by SigenStor BAT. If this is still insufficient, the power is supplied by the grid.

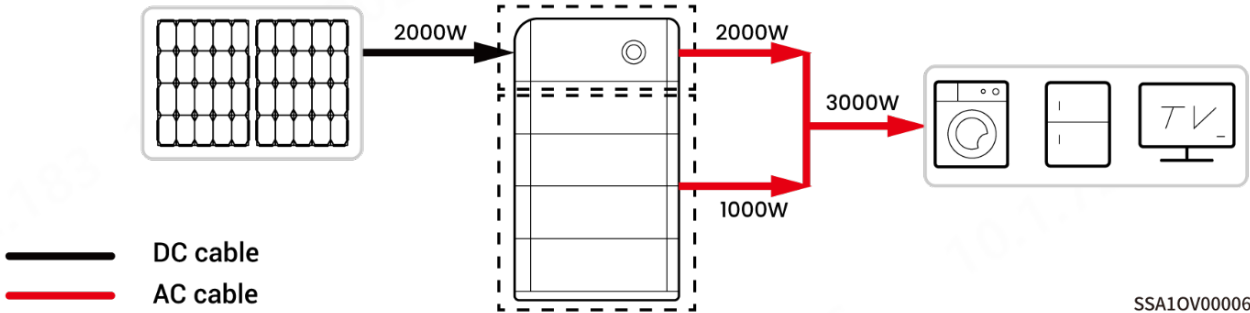
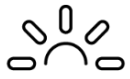



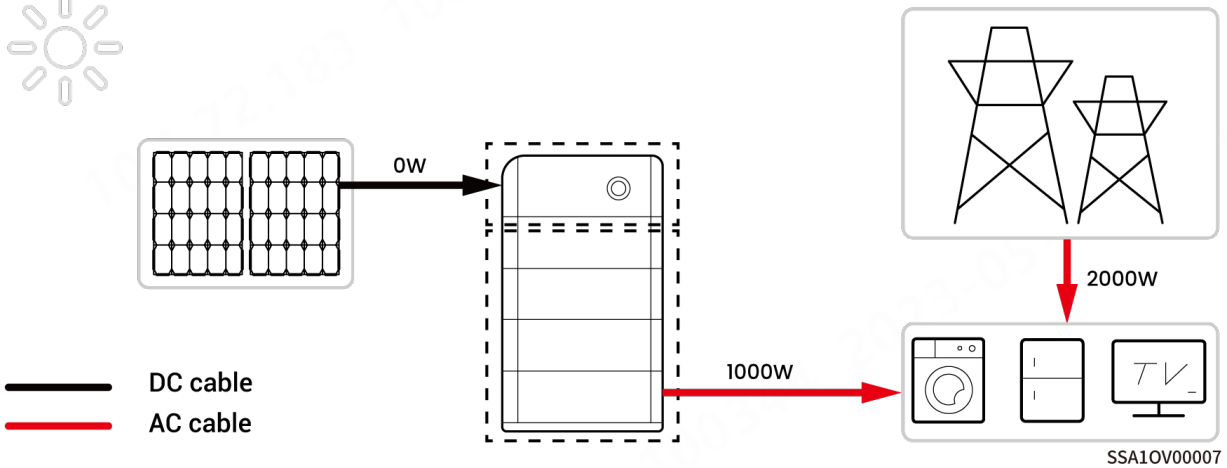
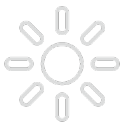

- When there is no sunlight: SigenStor BAT provides, the load energy first, and if it is still insufficient, it is supplied by the grid.

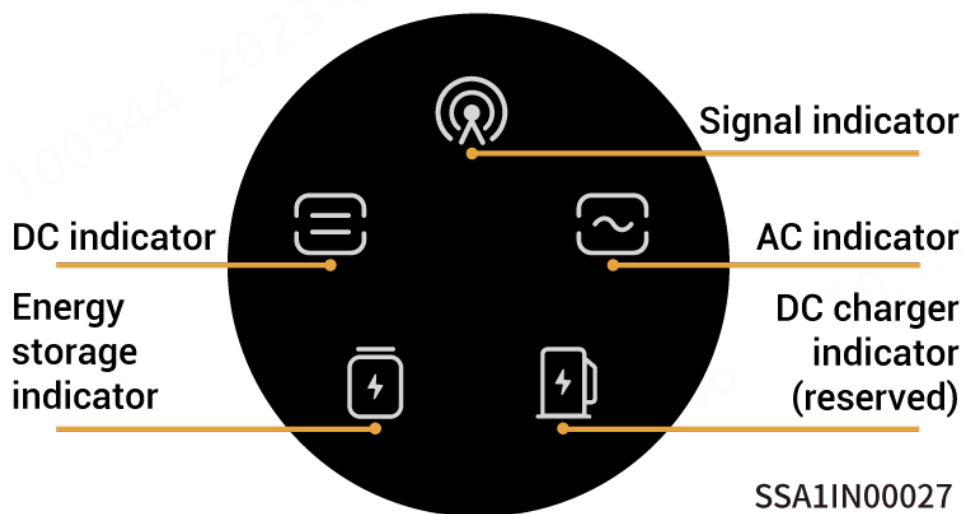

5.2 LED Indicator State



Serial No.	Name	State	Silk screen
	White	Always on	The DC side is connected but not running.
	Green	Always on	The DC side is running.
	No	Off	The DC side is not connected.
	Orange	Flash	The DC side is faulty.
	Red	Always on	The SigenStor EC is faulty.
	White	Always on	The AC side is connected but not running.
	Green	Always on	Grid-connected operation.
	Blue	Always on	Off-grid operation.
	No	Off	The AC side is not connected.
	Blue	Flash	Off-grid overload operation.
	Orange	Flash	The AC side is faulty.
	Red	Always on	The SigenStor EC is faulty.

Serial No.	Name	State	Silk screen
	White	Always on	All SigenStor BATs are connected but not running.
	Green	Flash slowly/Always on	SigenStor BAT is charging.
	Blue	Flash slowly/Always on	SigenStor BAT is discharging.
	No	Off	All SigenStor bats lie dormant.
	Red	Flash	Some SigenStor BATs are faulty.
	Red	Always on	All SigenStor bats are faulty.
	Orange	Flash	The management system is not connected.
	Green	Flash	Connected to local APP.
	Green	Always on	Connected to the management system using an FE or WLAN.
	Blue	Always on	Connected to the management system over 4G.

5.3 mySigen APP Query

The App can be downloaded in the following two ways. For details, see mySigen APP User Manual.

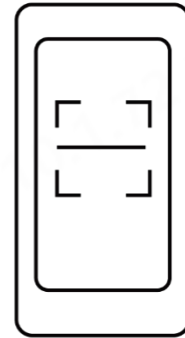

mySigen

Chapter 6 System Maintenance

6.1 Routine Maintenance

To ensure the long-term running of the equipment, you are advised to perform routine maintenance according to this section.

Inspection content	Inspection method	Power off or not	Maintenance cycle
System cleaning	Check the decorative cover regularly for shielding and dirt. If so, clean it up.	Yes	Once every three months.
System running state	<ul style="list-style-type: none"> ● Check whether the equipment is damaged or deformed. ● Listen for any abnormal noises during the operation of the equipment. ● When the equipment is running, check whether the equipment parameters are correctly set. 	No	Once every six months.

6.2 Equipment Powering-on/Power-off

Scheme 1: App operation

Click SigenStor Setting in the mySigen APP and click Power-on/Power-off below.

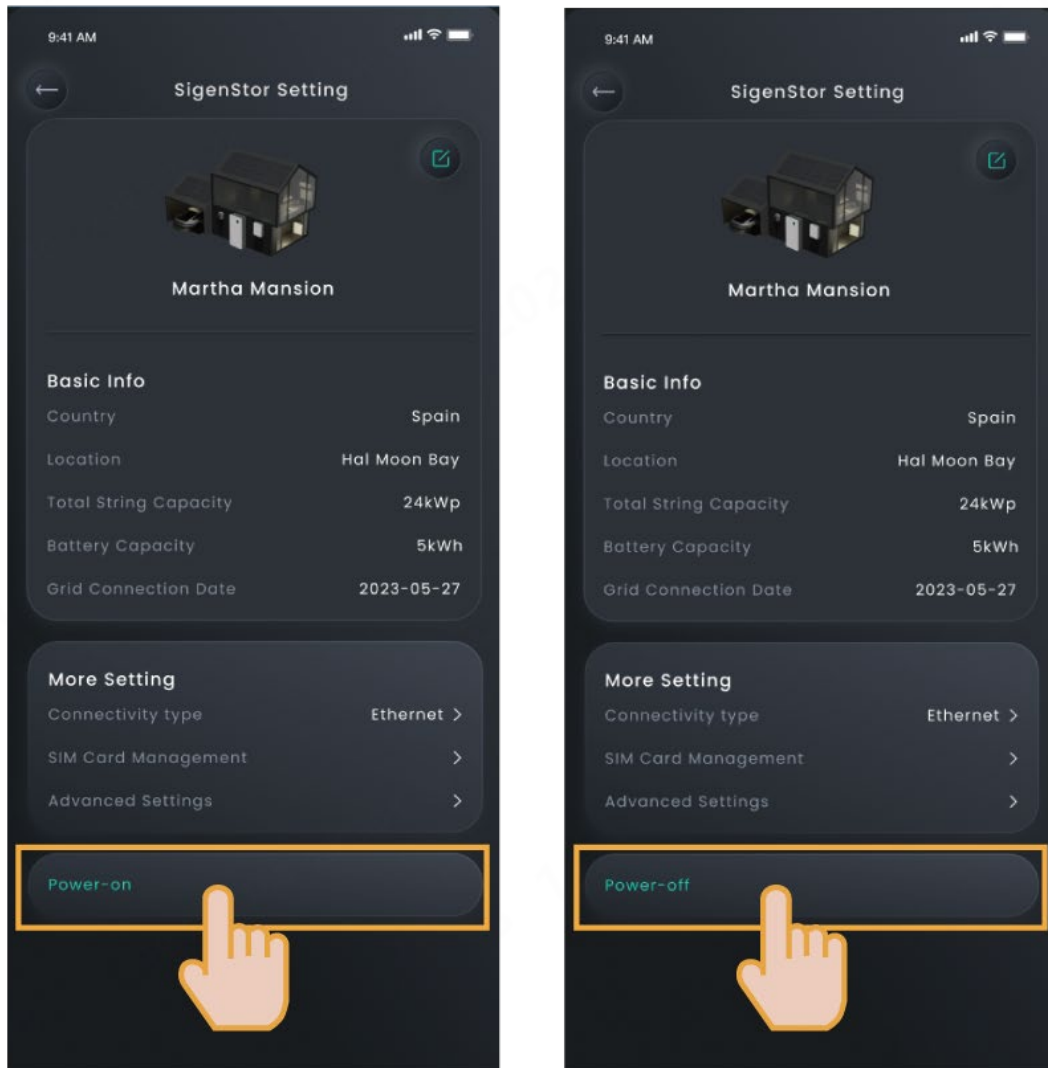

SSA1CM00001

Scheme 2: Manual operation

Follow the steps shown to remove the side and top decorative cover, and press the START switch button.

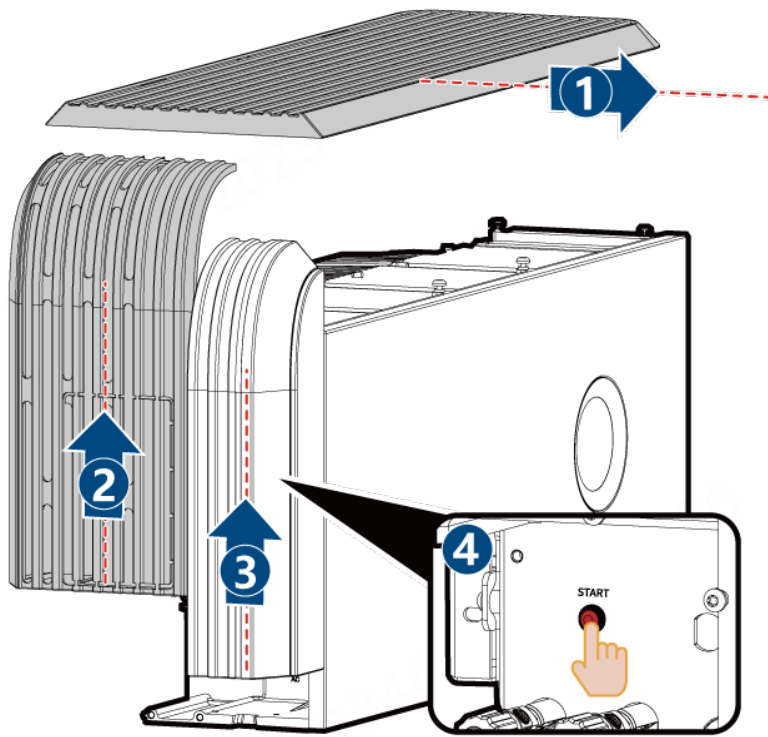

SSA1IN00030

6.3 Low SOC

The self-discharge characteristic of battery pack will cause power loss. If the equipment is not charged for a long time, it may be damaged due to overdischarge of power. When the battery is low, charge the equipment in time.

Under normal circumstances, the equipment can charge itself according to the running condition. If the equipment cannot be charged, please contact your sales agent in time and deal with it within the specified time. If the battery capacity is lost or irreversible damage is caused due to the delay, the company will not be liable.

- When the battery power is more than 10% (inclusive), charge within 30 days
- When the battery power is more than 0 (inclusive) and less than 5%, charge within 7 days

Scenarios that may cause a charge failure (including but not limited to) :

- The PV side has no input, and the power grid side is powered off for a long time.
- The equipment is faulty.
- Parameters are not set correctly.

6.4 Emergency Treatment

Emergency Measures for Fire

Danger

- Please shut down the equipment or disconnect the main power switch when it is safe.
- The high temperature may distort or damage the battery pack, resulting in electrolyte overflow or toxic gas leakage. Do not go near the battery pack and wear protective equipment.
- If the fire is small, use carbon dioxide or ABC dry powder extinguisher to extinguish the fire.
- If the fire is spreading, evacuate the building or equipment area immediately and call the fire department. Re-entry to burning buildings is prohibited.
- Do not contact with high voltage components during fire fighting, otherwise it may lead to the risk of electric shock.
- After extinguishing the fire, do not use the equipment, please contact your sales agent.

Emergency Measures for Flood

Danger

- Please shut down the equipment or disconnect the main power switch when it is safe.
- If the battery pack is submerged, do not touch it to avoid the danger of electric shock.
- After the flood waters recede, do not use the equipment. Please contact your sales agent.

Emergency Measures for Battery Pack Exceptions

Danger

- When the battery pack has abnormal odor, electrolyte leakage, or heat, do not touch it, and contact professional personnel immediately. Professionals must wear protective equipment such as goggles, rubber gloves, gas masks, and protective clothing to protect themselves.
- The electrolyte is corrosive and contact may cause skin irritation or chemical burns. In case of accidental contact with electrolyte, take the following measures immediately:
 - Inhalation: Evacuate the contaminated area, keep fresh air circulating, and seek immediate medical help.
 - Eye contact: Flush eyes with plenty of water for at least 15 minutes. Do not rub eyes. Seek medical help immediately.
 - Skin contact: Wash the contact area with plenty of soapy water and seek medical help immediately.
 - Ingestion: Induce vomiting and seek medical help immediately.
- Do not continue to use abnormal battery packs, please contact your sales agent.

Emergency Measures for Battery Pack Drops or Impacts

- If there is an obvious odor, smoke, or fire, keep away from the equipment immediately and contact professional personnel.
- Do not use the battery pack if it has been dropped or hit. Please contact your sales agent.

Chapter 7 Appendix

7.1 Technical Parameter

For details about equipment parameters, see the Data sheets of the product.