



Rechargeable Li-ion Battery system EverCore-261kWh-125kW-NV

User Manual Version V1.0

Category

1.	Manual Description	1
1.1.	Scope of Application.....	1
1.2.	Purpose	1
1.3.	Manual Usage.....	1
1.4.	Terms and Acronyms	2
2.	Safety Instructions	3
2.1.	Symbol Usage Instructions.....	3
2.2.	Safe Usage Instructions.....	5
	2.2.1. Personnel Requirements	7
	2.2.2. Setting of Safety Warning Signs.....	8
	2.2.3. Requirements for Escape Routes.....	8
	2.2.4. Electrical Measurement.....	8
	2.2.5. Usage of Measuring Equipment	8
	2.2.6. System Parameter Settings.....	9
	2.2.7. Moisture Protection.....	9
	2.2.8. Precautions During Maintenance or Repair.....	9
	2.2.9. Product Scrap.....	9
	2.2.10. Personal Protective Equipment (PPE).....	10
	2.2.11. Other Important Notes.....	11
3.	Product Introduction.....	12
3.1.	Product Overview.....	12
	3.1.1. Product Appearance and System Composition.....	12
	3.1.2. System Schematic	15
3.2.	System Overview	15
	3.2.1. Auxiliary Power.....	16
	3.2.2. Thermal Management System(TMS).....	17
	3.2.3. Fire Suppression System.....	17

3.2.4.	Fire suppression control logic	22
3.2.5.	Emergency plan	23
3.3.	Load type requirements in system applications	24
4.	Transportation and Storage.....	26
4.1.	Transportation Process and Requirements	26
4.1.1.	Requirements for Transportation Methods	26
4.1.2.	Requirements for Transportation.....	26
4.2.	Storage Requirements	27
4.3.	Lifting and hoisting equipment	27
4.3.1.	Equipment Requirements	27
4.3.2.	Lifting Equipment Hoisting Parameters	27
4.3.3.	Precautions for Lifting Operations	28
4.3.4.	Risk Identification for Hoisting Operations.....	29
4.3.5.	Lifting Safety Measures.....	30
4.3.6.	Forklift transportation requirement	31
5.	Product Installation	33
5.1.	Requirements for the Site	35
5.1.1.	Battery Cabinet Installation Dimensions.....	35
5.1.2.	Basic Requirements and Product Installation Spacing	35
5.1.3.	System Anti-Vibration Protection Requirements.....	37
5.1.4.	Ventilation and Heat Dissipation Requirements.....	37
5.2.	Installation Foundation Requirements	38
5.2.1.	EverCore Foundation Requirements	38
5.2.2.	Level Land Surface Installation.....	39
5.3.	Mechanical Installation.....	41
5.3.1.	Requirements for Disassembly of Product Outer Packaging.....	41
5.3.2.	Packaging.....	42
5.3.3.	EverCore Cabinets Installation with Hybrid Inverters	43
5.3.4.	Tool List.....	46

5.3.5.	Product Installation Requirements	47
5.4.	Electrical Connections.....	49
5.4.1.	Wiring Requirements.....	49
5.4.2.	Cable Fixing Requirements.....	49
5.4.3.	System Grounding Requirements	50
5.4.4.	EverCore Electrical Connection.....	50
5.4.5.	Inspection of Wiring Quality.....	76
5.5.	Instructions for Using Aerosols	76
5.6.	Installation Instructions for Fire Water Inlet Connector	77
5.7.	Battery pack wiring.....	78
6.	Operation of System.....	79
6.1.	Requirements for Trial Operation	79
6.2.	System Power-on Operation Procedure.....	79
6.3.	System Power on Operation Instructions	79
6.3.1.	High-Voltage Box Isolating Switch Closing Operation	80
6.3.2.	High-Voltage Box Closing Operation	80
6.3.3.	Closing of Switch.....	81
6.3.4.	High-Voltage Box Operation Indicator Light	82
6.3.5.	Indicator Light Status and Position.....	82
6.4.	Quick setting on APP (SolisCloud).....	83
6.4.1.	Log in the APP Via Bluetooth.....	83
6.4.2.	APP Quick Setting	86
6.5.	System Shutdown Procedure.....	90
6.6.	System Shutdown Operation Instructions	91
6.6.1.	High-Voltage Box Power-Down Procedure.....	91
6.6.2.	High-Voltage Box Isolating Switch Opening Operation.....	91
6.6.3.	Open Circuit.....	91
7.	Product Maintenance.....	92
7.1.	Safety Precautions.....	92

7.2.	Maintenance Work and Cycle	92
7.2.1.	Product Maintenance Inspection	93
7.3.	Requirements for Product Appearance Maintenance	93
7.4.	Battery system maintenance requirements.....	95
7.4.1.	Battery System Maintenance and Calibration	95
7.4.2.	Instructions for Replacement and Safe Handling of Damaged Packs	96
7.5.	Requirements for Thermal Management System Maintenance	98
7.5.1.	Requirements for Maintenance of Air-Cooled Air Conditioner	98
7.6.	Fire Protection System Maintenance Management.....	98
7.6.1.	Replace smoke detectors and temperature detectors	98
7.6.2.	Replacement of the Flammable Gas Detector	99
7.6.3.	Replacement of Audible and visual alarm.....	100
7.6.4.	Replacement of Aerosol device	100
7.6.5.	Post-Aerosol Spraying Precautions	101
7.7.	Electrical System Maintenance & Management.....	103
7.7.1.	High-Voltage Box	103
8.	Trouble Shooting.....	104
8.1.	Battery System Failures Trouble shooting	104
8.1.1.	Fault, Alarm Handling and Countermeasures	104
8.1.2.	Battery System Fault Diagnosis and Elimination Procedure	107
8.1.3.	Handling of Abnormalities and Accidents.....	108
8.2.	Trouble Shooting for Air conditioner.....	110
8.2.1.	Trouble Shooting.....	110
8.3.	Fire Protection System Trouble Shooting.....	111
8.3.1.	Smoke Detector Fault.....	111
8.3.2.	Temperature detector fault	112
8.3.3.	Gas detector alarm	112
8.3.4.	Audible and visual alarm fault	112
9.	Appendix.....	113

9.1.	Maintenance Inspection Checklist.....	113
9.2.	Daily Operation Fault Record Sheet	119
9.3.	Regular Maintenance Record Sheet.....	120
10.	After-Sales Instructions	121

1. Manual Description

1.1. Scope of Application

This manual is applicable to the EverCore-261kWh-125kW-NV integrated energy storage cabinet. Hereinafter referred to as "EverCore".

1.2. Purpose

The purpose of this manual is to provide detailed product information and instructions for system installation, operation, maintenance, and use.

1.3. Manual Usage

Before using this system, carefully read this manual and ensure that you understand all safety precautions. Then, use the product.

The content of this manual and the pictures, logos, symbols, etc. used are all owned by Ginlong Energy Storage Co., Ltd. Without prior authorization from Ginlong Energy Storage Co., Ltd., no part of this manual may be reproduced or distributed.

The content of the manual will be continuously updated and corrected. If there are slight discrepancies from the physical objects, users should refer to the purchased physical objects

1.4. Terms and Acronyms

SolisStorage	Ginlong Energy Storage Co., Ltd.
CAE	Computer Aided Engineering
BESS	Battery Energy Storage System
FEA	Finite Element Analysis
EMU	Energy Management Unit
BMS	Battery Management System
BCU	Battery Cluster Management Unit
BMU	Battery Management Unit
PDU	Power Distribution Unit
SOC	State of Charge
SOF	State of Function
SOH	State of Health
OCV	High Voltage Interlock
HVIL	CAN communication between BMU and CSC
EMC	Electromagnetic Compatibility
HV	High Voltage
CAN	Controller Area Network
DVP&R	Design Verification Planning& Report
SOP	Start of Production
BOL	Beginning of Life
EOL	End of Life
DOD	Depth Of Discharge
DV	Design Verification
Hybrid	Hybrid Inverter
PV	Photovoltaic
EMS	Energy Management System
AC Coupling	Alternating Current Coupling
AC	Alternating Current
DC	Direct Current

2. Safety Instructions





This section provides general safety instructions for the operation process. For specific safety instructions regarding the installation procedures, please refer to the corresponding chapters.

2.1. Symbol Usage Instructions



This manual provides relevant information, highlighted with appropriate symbols, for user safety and property protection, and to help users operate the product efficiently and optimally.



The following lists the symbols that may be used in this manual. Please read them carefully to better utilize this manual.

Warnings in the document





	"DANGER" indicates a high potential for danger. If it is not avoided, it will result in the death or serious injury of personnel.
	"WARNING" sign indicates a moderate potential hazard. Failure to avoid it could result in the death or serious injury of personnel
	"CAUTION" indicates a low level of potential danger. Failure to avoid it could result in moderate or minor injuries to personnel.
	"NOTICE" indicates potential risks. Failure to avoid these risks may result in the equipment not functioning properly. Or result in property damage.

Warnings on the product

	Be aware of dangerous voltage This product operates under high voltage. All operations on the product must be carried out in accordance with the instructions provided in the product manual.
	Risk of incorrect operation Personnel must operate correctly. Misoperation may result in serious personal injury or equipment damage.
	Be aware of excessive surface temperature The product may get hot during operation. Please do not touch this product during the operation process.

	<p>Risk of crushing</p> <p>Do not place your hands inside the movable and/or rotating parts of the product</p>
	<p>Risk of high noise levels</p> <p>The product can generate high noise levels. Hearing protection should be worn when operating the equipment.</p>

Product symbols

	<p>Risk of door swing angle</p> <p>The door opening angle is up to 120, and there are labels attached to the door.</p>
	<p>Unlock direction</p> <p>Unlock direction label, which is located on the door</p>
<p>Always pay attention to the danger warning signs on the equipment, including:</p>	
	<p>This sign indicates high voltage inside the cabinet. Touching it may pose a risk of electric shock</p>
	<p>This symbol indicates that this is the PE terminal for protective grounding. It is necessary to ensure a firm connection for the purpose of safeguarding the safety of the operators.</p>

2.2. Safe Usage Instructions

This section presents the general safety guidelines that need to be followed when operating the system. For the safety instructions in the specific usage and maintenance steps, please refer to the warning explanations in the corresponding chapters.



Electric shock hazard! Ignoring the following warnings may result in personal death or serious injury.

Only qualified personnel are allowed to operate, install and maintain the system.

Before work, safety protective equipment must be worn, and the protective equipment should comply with local laws, regulations and standards.

Never touch any electrified parts directly.

Before installing the equipment, the AC circuit must be isolated from the power grid, and the AC connection must be disconnected. The DC circuit must be isolated from the battery pack, and the DC connection must be disconnected.

The equipment should have a grounding cable. If several devices are installed together, each device should be grounded separately. The grounding cable should comply with the corresponding safety standards.

Dehumidify the equipment after installation or a prolonged power outage. Then, test the insulation resistance. Do not start the equipment until the insulation test is passed.

Requirement: The insulation resistance on both the AC and DC sides must be no less than 1 MΩ.

The PCB circuit board may generate high voltage when the equipment is powered on, especially the voltage sampling boards for AC and DC. Therefore, be careful of electric shock when using instruments such as an oscilloscope.

When the equipment malfunctions, the main and auxiliary circuits may generate dangerous voltages. Therefore, before working, measure the voltage and ensure that the voltage is below the safe level..

Do not operate the equipment when the cover or door is open

In rainy weather, do not open the equipment door to avoid water ingress and protect personnel from electric shock

⚠ WARNING

Warning! Ignoring this warning may result in personal injury.

Even if the power of the equipment has been turned off, the cooling fan may still be rotating. Please do not touch the rotating parts.

When disassembling the components of the equipment, please wear gloves to prevent scratches.

After the system is powered off, do not touch the radiator, heater surface, bus bars or capacitors.

Maybe they are very hot and could burn you.

Do not collide with personnel during equipment handling.

An isolation area should be set up during installation operations.

During the lifting process, move and transfer the equipment carefully.

The installation of all equipment must be carried out by installation personnel who have received training in handling high-voltage electricity.

Do not use or install equipment with any defects, cracks, or damage.

Do not attempt to open, disassemble, repair, tamper with or modify the equipment.

Do not perform outdoor installation during severe weather such as rainstorms or sandstorms.

To protect the equipment and its components from damage during transportation, handle them carefully. Do not hit, pull, drag or step on the equipment. Do not subject the equipment to any strong force. To prevent damage, keep the equipment in the transportation packaging until ready for installation

Do not insert any foreign objects into any part of the equipment.

Do not expose the equipment or its components to direct flames.

Do not install the equipment near heating devices.

Do not immerse the equipment or its components in water or other liquids.

Place the equipment on a level surface to ensure it is stable and does not shake or tilt

The installation of the equipment should take into account the load capacity of the installation ground and floor (according to the requirements of the construction drawings).

CAUTION

Caution! Ignoring the following warnings may damage product components.

When installing the equipment, do not place the conductive sweep device in the cabinet, as it may damage the equipment.

Install the equipment on the platform using the specified strength bolts, and the bolts should comply with the installation requirements.

Ensure that the equipment has good heat dissipation, and the ventilation pipe should not be blocked

Ensure that the electrical bolts are always tightened to the exact torque specified in this document.

If the equipment is not powered for a long time, its lifespan will be affected.

Do not use cleaning agents to clean the equipment, or expose the equipment to flammable or irritating chemical substances or vapors.

Do not use components that have not been authorized by Solis

The transfer and lifting diagrams in this document are for reference only. The specific tools and equipment shall be selected according to the actual site conditions.

NOTICE

The power/battery module is too heavy and requires multiple people to move it. Appropriate protective equipment should be worn, and the protective equipment should comply with local laws, regulations and standards.

Unless otherwise specified, all dimensions are in millimeters.

2.2.1. Personnel Requirements

Only professional electricians or personnel with professional qualifications can perform all operations on this product.

Operators should be fully familiar with the composition and working principle of the entire system.

Operators should be fully acquainted with this manual.

Operators should be fully aware of the relevant standards of the project's location area.

2.2.2. Setting of Safety Warning Signs

Please follow the following guidelines when implementing installation, daily maintenance, and inspection operations of this system, in order to prevent irrelevant personnel from approaching and causing incorrect operations or accidents:

Set up clear signs at the front and rear switch positions of the equipment under maintenance to prevent accidental closing of the switch and resulting accidents

Establish warning signboards or set up safety warning tapes near the operation area.

2.2.3. Requirements for Escape Routes

To ensure that staff can evacuate the site promptly in case of an emergency, please follow the following guidelines:

During maintenance, repair, or other operations on the equipment, it is essential to ensure that the escape routes are completely unobstructed.

It is strictly prohibited to pile up any items or occupy the escape routes in any way.

2.2.4. Electrical Measurement



There is high voltage in the system. Accidental contact may cause a fatal electric shock hazard. Therefore, when conducting measurements while the system is energized, the following should be done:

Take protective measures (such as wearing insulating gloves).

There must be a companion to ensure personal safety.

2.2.5. Usage of Measuring Equipment



There is a high voltage in the system. Accidental contact could lead to a fatal electric shock hazard. Therefore, when conducting measurements while the system is energized, you should.

Select high-quality measuring equipment whose range and operational conditions meet the requirements of the site.

Ensure that the connections of the measuring equipment and the operation follow the correct procedures to avoid potential hazards such as electric arcs

2.2.6. System Parameter Settings

Some parameters in the system software can be set, and they are closely related to the operation of the system. Such parameters can only be set after a reliable analysis and evaluation of the system's operation status.

⚠ WARNING

**Improper parameter settings may affect the normal operation of the system.
Only authorized professionals are permitted to set the parameters of the system.**

2.2.7. Moisture Protection

NOTICE

The ingress of moisture is highly likely to damage electrical equipment! To ensure the normal operation of all system functions, please follow the following items:

When the air humidity is over 95%, do not open the system or equipment doors.

Avoid conducting maintenance or repair operations on the system in rainy or humid weather conditions.

2.2.8. Precautions During Maintenance or Repair

⚠ WARNING

After the system stops running, please wait for at least 10 minutes before conducting maintenance or repair operations on the system. After the system is shut down, when performing maintenance or repair operations on the system, be sure to:

Ensure that the system will not be accidentally re-powered.

Use a multimeter or an electric tester to check and ensure that the system is completely de-energized.

Cover the adjacent potentially electrified components with insulating materials.

During the entire maintenance and repair process, ensure that the escape route is completely unobstructed.

2.2.9. Product Scrap

Scrap products shall be immediately recovered and disposed of by the designated qualified manufacturer. In order to avoid safety accidents or serious environmental pollution, it is strictly forbidden

to discard discarded products.

2.2.10. Personal Protective Equipment (PPE)

⚠ WARNING

It is strictly prohibited to carry out maintenance or repair operations when the equipment is powered on

When conducting maintenance or repair on the equipment, it is recommended that at least two personnel be present on site.

When performing maintenance or repair on the equipment, turn off the system and use a multimeter or an electric tester pen to test to ensure that the system is completely de-energized.

PPE is determined by the incident energy (in cal/cm²) generated by an arc flash at a specified working distance (typically 18 inches). The PPE requirements for EverCore operation correspond to PPE Category 2.

PPE CATEGORY 1	PPE CATEGORY 2	PPE CATEGORY 3	PPE CATEGORY 4
<p>Minimum Arc Rating of 4 cal/cm²</p>  <p>Arc Rated Clothing:</p> <ul style="list-style-type: none"> • AR long-sleeve shirt and pants, or AR coverall • AR face shield, or AR flash suit hood • AR jacket, parka, rainwear, or hard hat liner (as needed) <p>Protective Equipment:</p> <ul style="list-style-type: none"> • Hard hat • Safety glasses or safety goggles • Hearing protection (with inserts) • Heavy-duty leather gloves • Leather footwear (as needed) 	<p>Minimum Arc Rating of 8 cal/cm²</p>  <p>Arc Rated Clothing:</p> <ul style="list-style-type: none"> • AR long-sleeve shirt and pants, or AR coverall • AR flash suit hood, or AR face shield and AR balaclava • AR jacket, parka, rainwear, or hard hat liner (as needed) <p>Protective Equipment:</p> <ul style="list-style-type: none"> • Hard hat • Safety glasses or safety goggles • Hearing protection (with inserts) • Heavy-duty leather gloves • Leather footwear 	<p>Minimum Arc Rating of 25 cal/cm²</p>  <p>Arc Rated Clothing:</p> <ul style="list-style-type: none"> • As required, AR long-sleeve shirt, AR pants, AR coverall, AR flash suit jacket, and/or AR flash suit pants • AR flash suit hood • AR gloves • AR jacket, parka, rainwear, or hard hat liner (as needed) <p>Protective Equipment:</p> <ul style="list-style-type: none"> • Hard hat • Safety glasses or safety goggles • Hearing protection (with inserts) • Leather footwear (as needed) 	<p>Minimum Arc Rating of 40 cal/cm²</p>  <p>Arc Rated Clothing:</p> <ul style="list-style-type: none"> • As required, AR long-sleeve shirt, AR pants, AR coverall, AR flash suit jacket, and/or AR flash suit pants • AR flash suit hood • AR gloves • AR jacket, parka, rainwear, or hard hat liner (as needed) <p>Protective Equipment:</p> <ul style="list-style-type: none"> • Hard hat • Safety glasses or safety goggles • Hearing protection (with inserts) • Leather footwear (as needed)

Figure 2-1 PPE Classification

2.2.11.Other Important Notes

In addition, the following protective or emergency measures should be taken according to the on-site needs:

When conducting maintenance, repair, or other operations on the system, relevant personnel should take appropriate protective measures as needed at the site, such as wearing noise-proof earplugs, insulated shoes, insulated gloves, and heat-resistant gloves.

All necessary auxiliary measures should be adopted to ensure the safety of personnel and equipment.

This manual cannot cover all possible situations during operation, maintenance, and repair processes. If there are situations not explained in the manual, please contact SolisStorage in time.

To facilitate users' better reading and use of this manual, a large number of pictures are configured in the manual. All pictures are only for explanatory purposes. Users should refer to the actual product received.

3. Product Introduction

3.1. Product Overview

3.1.1. Product Appearance and System Composition

EverCore consists of a Solis Hybrid Inverter (HYI), a battery system, a Battery Management System (BMS), a Fire Suppression System (FSS), a Thermal Management System (TMS), and an auxiliary distribution system.



Figure 3-1 Product Appearance

Datasheet

NO	Item		Specification
1	Pack number		13
2	Nominal Energy		261.248kWh
3	Nominal voltage		832Vd.c.
4	Range of voltage		754~936Vd.c.
5	Nominal Charging power		130.5kW
6	Nominal Discharging power		130.5kW
7	Auxiliary power supply	Voltage	220Vac;
		Power	~4kW
8	Operating ambient temperature	Charging	0°C~+55°C
		Discharging	-25°C~+55°C
9	Ambient requirement	Storage temperature	-20°C~+45°C
		Transportation temperature	-30°C~+55°C
		Operating Height	≤4,000m,derating is required when the altitude is above 2000m
10	General	Dimension	1400(W)*1600(D)*2230(H) mm (not including the size of the hybrid inverter)
		Weight	2900 kg
		IP	IP55 (cabinet) IP66 (inverter)
		Cooling method	Industrial-grade air-conditioning (Cabinet) fan-cooling (Pack) Intelligent fan-cooling (Inverter)
		Communication protocol	TCP/IP, CAN,RS485
		Refrigerating fluid	R134a

11	Compliance standard	System	UN38.3
			IEC 62619
			IEC 60730-1
			IEC 63056
			IEC 62477-1
			IEC 61000-6-2/IEC 61000-6-4
			UN3480

*More detailed parameters about hybrid inverter , you can refer to the document on Solis's official website

Battery pack

Series	Battery Pack (EverCore)
Model	PACK-1P20S-314-01
Cell brand	EVE
Cell type	LFP 3.2V/314Ah
Cell model	MB31
Cell weight	5.6±0.2kg
Configuration mode	1P20S
Rated voltage	64V
Operating voltage range	58~72V
Charge and discharge rate	≤0.5C
Battery pack capacity	20.10kWh
Battery pack weight	138kg
Dimensions (W*H*D)	435*230*904mm
Cooling concept	Air cooling
Ingress protection	IP20
Storage temperature range	0°C~40°C
Transportation temperature range	-10°C~45°C
Balancing mode	Passive cell balancing
Communications port	CAN 2.0

3.1.2. System Schematic

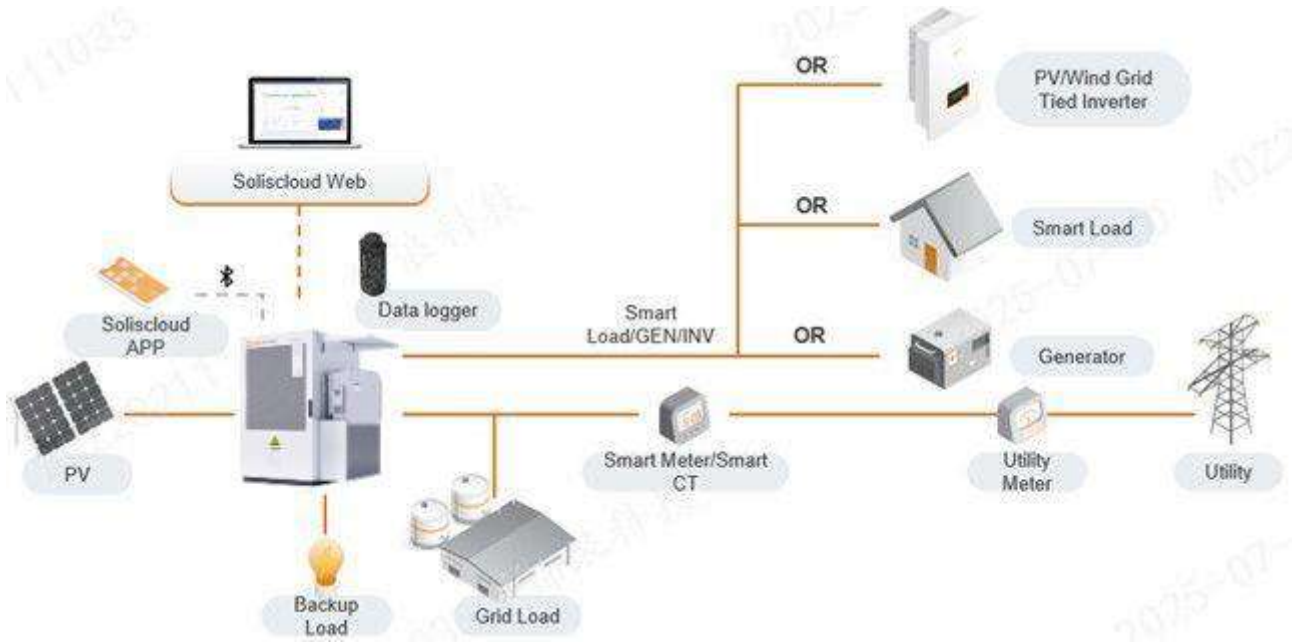

Figure 3-2 System Schematic

3.2. System Overview

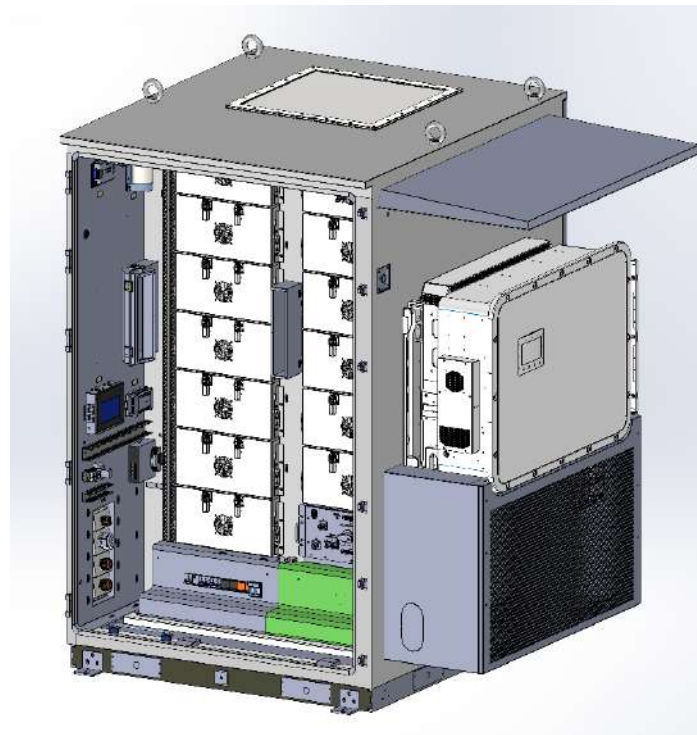

Figure 3-3 Main Components

The system consists of a single battery cluster, the battery cluster contains 13 battery packs, each of which is composed of 20 battery cells. The system contains 260 battery cells.

Table 3-1 System Configuration

System	Component	Amount	Remark
Battery system	Pack	13	Including BMU
Controller	EMU	1	Energy Management Unit
	BCU	1	Battery Cluster Management Unit
Thermal management system	Air-conditioner	1	/
Fire suppression system	Thermal detection Smoke detection Water immersion sensor Moisture detection Aerosol(cabinet level) Fire water inlet Short circuit protection	1	Flammable gas detector (optional) Audible and visual alarm (optional) Explosion-proof exhaust fan (optional) Explosion relief panel (optional)
Auxiliary power	PDU	1	Power distribution unit

3.2.1.Auxiliary Power

The auxiliary power distribution system is used to provide auxiliary power for the entire control system and air conditioner.

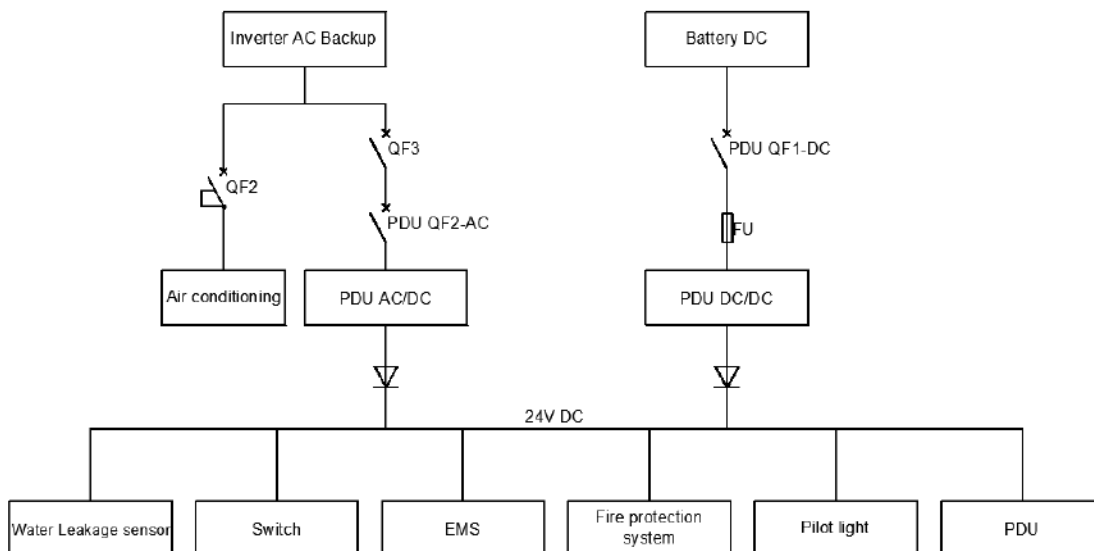

Figure 3-4 Distribution Box Diagram

The character of auxiliary power

The auxiliary power system consists of an AC auxiliary supply and a DC supply. The AC circuit power supply is taken from the Backup port of the hybrid inverter, used for air conditioner and the controller power supply. The DC power supply is taken from the inner side of the battery and is used for powering the control system.

3.2.2. Thermal Management System(TMS)

The Thermal Management System (TMS) consists of an air conditioner, an air duct. It supply the intelligent temperature control of the battery system. Due to the high performance TMS, The air-cooled management system provides intelligent temperature control management for the energy storage system, ensuring efficient operation of the energy storage system

1. Refrigerant type of air conditioner: R134a
2. Suitable for extreme ambient temperature applications:-40°C ~ +55 °C
3. Each battery cabinet is equipped with an air conditioner that provides 5 kW of cooling capacity
4. Fan-less design

Table 3-2 TMS related parameter

TMS configuration	Parameter
Air conditioner units	1
Refrigerating capacity	5000W
Heating capacity	3000W
Rated Power	2400W/3300W(Refrigerating/Heating) @50Hz
	2900W/3400W(Refrigerating/Heating) @60Hz
Rated voltage	220±15%Vac
Rated frequency	50/60Hz

3.2.3. Fire Suppression System

The fire suppression system is divided into components as follows:

1. Fire alarm system
2. Gas fire suppression system

3. Explosion and pressure relief system

4. Water inlet

The main equipment and functions of each system:

(1) The main equipment of the fire alarm system includes: smoke detectors, temperature detectors, audible and visual alarm, and flammable gas detectors (optional),

(2) The main equipment of the gas fire suppression system includes: temperature-starting and electric-starting aerosol.

(3) The main equipment of the pressure relief and explosion suppression system: pressure relief valves, explosion-relief panel (optional).

(4) The main equipment of the fire water inlet system: DN65 externally threaded connection pipes and DN65 fire hydrant plugs.

Fire suppression operation process:

1. Initial fire detection: When the smoke detector senses a smoke obscuration of 0.15 dB/m, or the temperature detector detects either a rate-of-rise exceeding the preset threshold or an ambient temperature reaching 65 °C, a fire alarm signal is triggered and a dry contact signal is sent to the EMU. Simultaneously, if the flammable gas detector (hydrogen) detects a gas concentration rising at a rate of 10 ppm per second—reaching the low alarm threshold—it also outputs a dry contact signal to the EMU and activates the audible and visual alarm.

2. When the battery cabinet temperature reaches $170\pm 5^{\circ}\text{C}$, the aerosol automatically sprays to perform initial fire suppression. If the fire cannot be controlled, the pressure in the battery cabinet increases, the pressure relief valve will automatically pop open to prevent the accumulation of flammable gas and deformation of the box due to excessive pressure. When the flammable gas explodes, the internal explosion shock wave will cause the explosion-proof plate to automatically burst and release the shock wave from the top. Finally, this system is reserved with a fire water injection interface. After the user connects the fire water pipe on site, water injection fire suppression is achieved.

As an outdoor non-entry energy storage system, this project provides a complete fire suppression system solution, with detection, pressure relief and explosion control, and fire suppression functions. The fire suppression strategy is divided into four levels:

Level 1: Activate any single detector (flammable gas(optional), smoke or temperature), trigger an

audible and visual alarm, and output an alarm signal. When the combustible gas detector(optional) is triggered alone, the ventilation system (optional) is automatically activated.

Level 2: Simultaneous activation of any two of the following detectors—smoke, temperature, and flammable gas (optional), triggers deactivation of the ventilation system (optional), releases aerosol to suppress the incipient fire, activates the aerosol feedback alarm, and disconnect the main positive and main negative contactors of the high-voltage box.

Level 3: Pressure relief and explosion suppression system, preventing secondary damage from explosion;

Level 4: Water injection fire suppression, preventing re-ignition;

The main components are listed in the table below

Table 3-3 Main components of the FSS system

NO.	Item	component name	amount	Remark
1	Detection and alarm component	Flammable gas detector (Li-ion Tamer sensor)	1	Optional configuration
2		Temperature detector	1	Standard configuration
3		Smoke detector	1	Standard configuration
4		Audible and Visual Alarm	1	Standard configuration
5	Explosion relief and pressure release system	Pressure relief valve	1	Standard configuration
6		Explosion proof intake valve	1	Optional configuration
7		Explosion proof exhaust valve	1	Optional configuration
8		Explosion relief Panel	1	Optional configuration
9	Gas fire-extinguishing system	Temperature-starting and electric-starting aerosol	1	Standard configuration
10	Fire Water inlet system	DN65 external thread external pipe connector	1	Standard configuration

3.2.3.1. Fire Detection System

The detection system consists of 3 types of detectors: smoke detector, temperature detector and

flammable gas detector (optional). Their installation locations is as follows.



Figure 3-5 Detector Installation Layout

3.2.3.2. Explosion and Pressure Relief System

The explosion and pressure relief system consists of pressure relief valve and Explosion relief panel (optional), and the installation position is as follows.





Figure 3-6 Layout of Explosion Relief Panel and Relief Valve

3.2.3.3. Fire Extinguishing System

(1) Aerosol fire extinguishing system



Figure 3-7 Aerosol device layout

(2) Water injection system



Figure 3-8 Water injection port layout

3.2.4. Fire suppression control logic

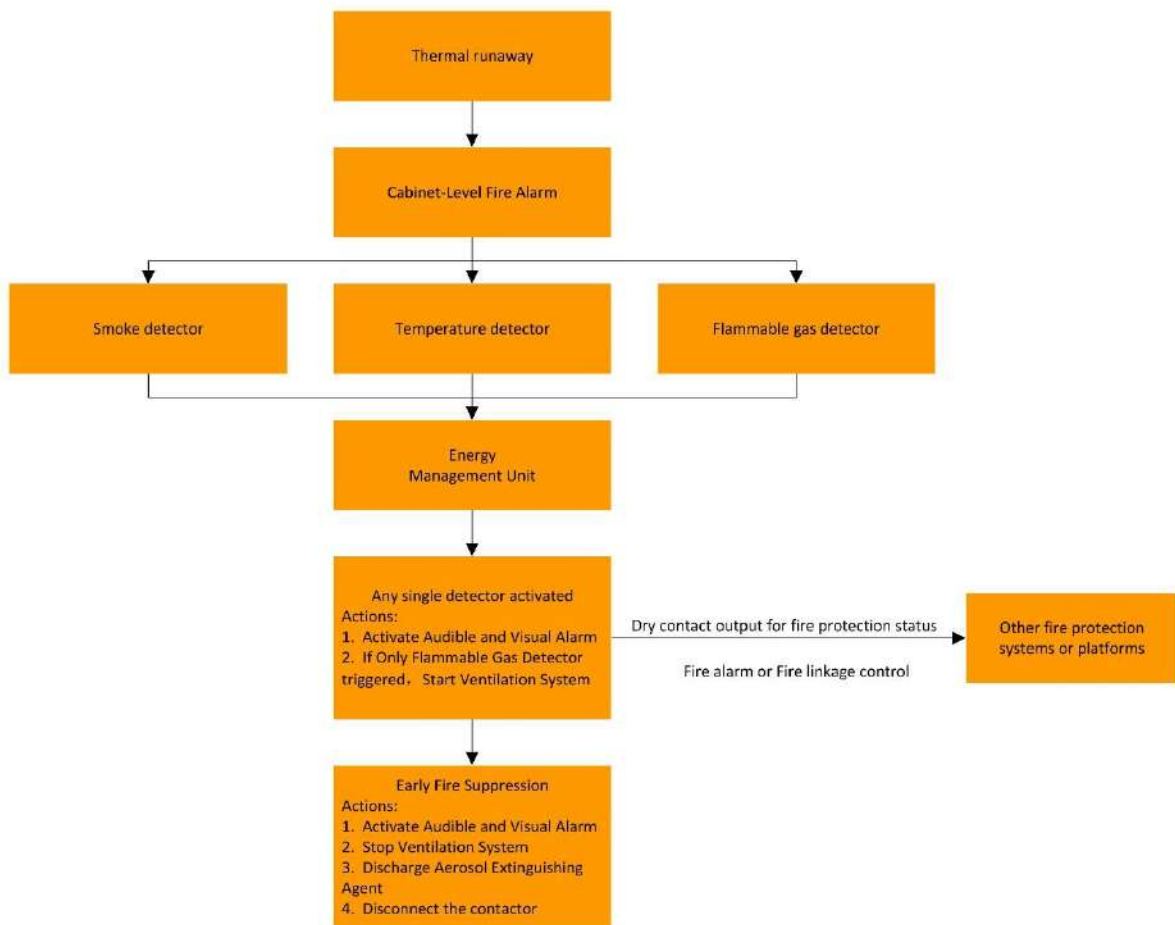

Figure 3-9 FSS Logic Figure 1 (Smoke Sensor / Temperature Sensor / Flammable Gas Detector)

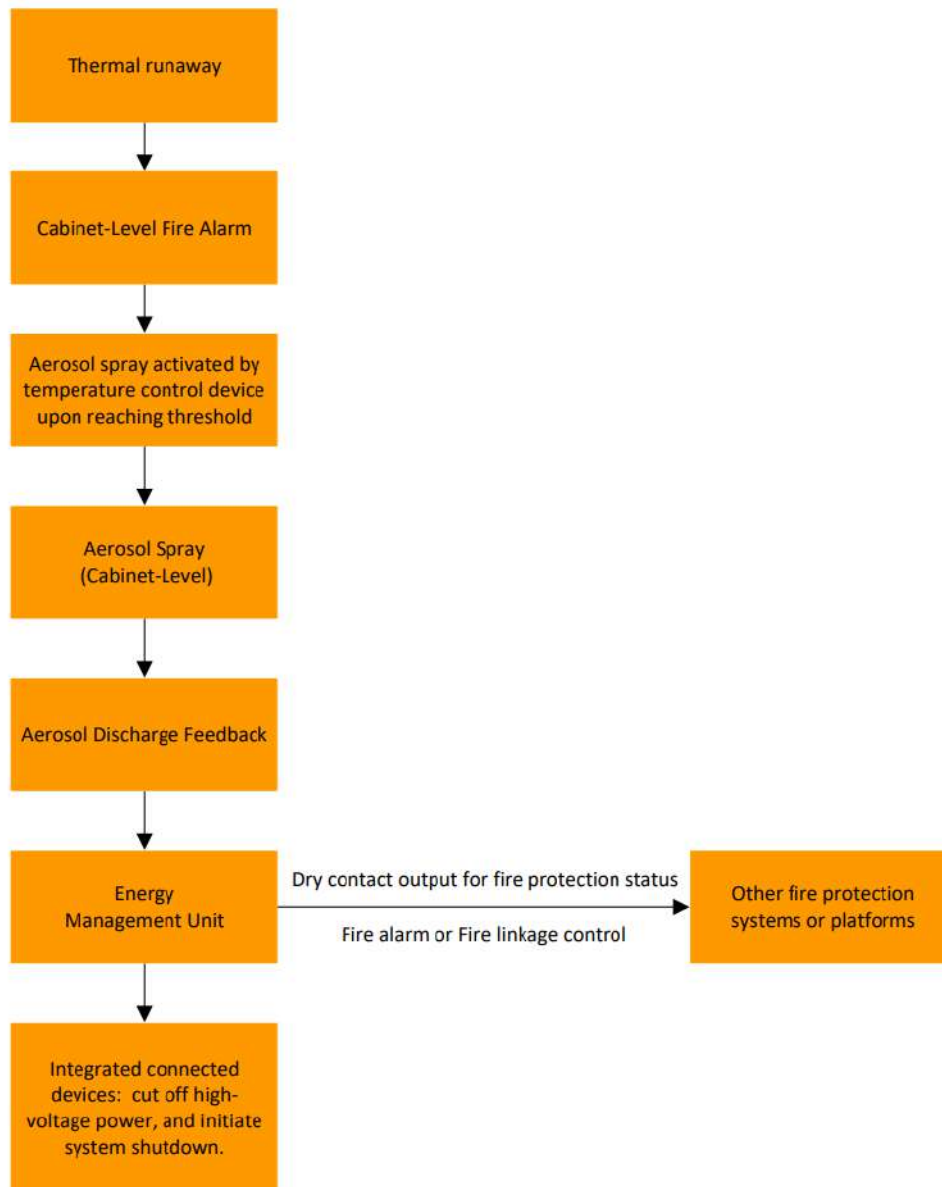

Figure 3-10 FSS Logic Figure 2-(Aerosol)

3.2.5. Emergency plan

(1) Post-Incident Actions

Once the fire has been extinguished or the system has stabilized, professional personnel must carry out the following cleaning and assessment procedures:

- Electrolyte Leakage Cleanup:

Safety Protection: Damaged batteries may leak electrolyte, which is corrosive and toxic. Operators must wear chemical protective suits, acid-resistant gloves, and respirators.

Absorption & Disposal: Cover the leaked liquid with sand, dry earth, or specialized chemical absorbent pads. Do not use water to flush the electrolyte directly.

Waste Disposal: The collected residue is classified as hazardous chemical waste and must be stored in sealed containers and disposed of by a qualified hazardous waste treatment agency.

- **Cleaning Fire Suppression Residues:**

Water Removal: If the water injection system (via DN65 connector) was used, drain the accumulated water through the cabinet's bottom drain valves or holes. As the firewater may contain chemical pollutants, it should be collected and treated rather than discharged directly into public storm drains.

Aerosol Cleanup: Aerosol discharge leaves fine powder on equipment surfaces. After confirming the power is safely disconnected, use industrial vacuum cleaners or dry cloths to remove the powder to prevent long-term corrosion or moisture absorption by electronic components.

(2) Product Contact Instructions in Emergencies

During an emergency (e.g., thermal runaway, fire alarm, or leakage), contact with the product must strictly follow these rules:

- **Prohibited Access:** Unauthorized personnel are strictly forbidden from approaching or attempting to open the cabinet doors during a fire or alarm event. Opening the doors may allow oxygen to enter, causing re-ignition or the loss of fire-extinguishing agents (aerosol).

- **Safety Radius:** During a thermal runaway risk, personnel should maintain a safety radius of at least 10 meters.

- **Emergency Connection:** Only firefighters wearing full protective gear are permitted to contact and operate the external DN65 fire water inlet.

- **Post-Shutdown Safety:** Even after the system has initiated an emergency shutdown and cut off high-voltage power, residual voltage may still exist within the battery strings. Do not touch any internal conductive parts or damaged battery modules until professional personnel verify that the voltage has dropped to a safe level.

3.3. Load type requirements in system applications

The backup output port of the EverCore hybrid inverter supports temporary overloads of up to 1.4 times the rated apparent output power for 10 seconds or 1.6 times for 200 milliseconds.

Meanwhile, Due to different load characteristics, the Backup port of the EverCore hybrid inverter has different load capacities and requirements, as described below.

(1) Resistive and RCD loads: When connecting single-phase resistive loads, it should not exceed 100% of the single-phase power; when connecting RCD loads, it should not exceed 60% of the rated power of the hybrid inverter.

(2) Motor-based loads: For direct motor loads, the starting impact power should not exceed 1.1 times the rated power of the hybrid inverter. For motor loads using frequency converters or soft-start types, the power should not exceed 60% of the rated power of the hybrid inverter.

(3) RLC load: The total load capacity shall not exceed the rated power of the hybrid inverter. The peak current during load switching (peak inrush current) shall not exceed twice the rated current of the hybrid inverter, and the minimum power factor shall not be less than 0.8.

(4) If a hybrid inverter is used for loading, apart from the RLC load, the motor load and the RCD load need to be proportionally reduced.

(5) Isolation transformer: The isolation transformer that comes with the hybrid inverter must be started simultaneously with the hybrid inverter. It is not allowed to start the hybrid inverter first and then put the isolation transformer into operation. Moreover, the inrush current at the moment of transformer start-up should not exceed twice the rated current, and the inrush power should not exceed 1.1 times the rated power of the hybrid inverter. Otherwise, a soft starter needs to be added to the transformer.

(6) The peak current at the moment of load switching (base current + inrush current) does not exceed 1.1 times the rated current of the hybrid inverter

4. Transportation and Storage

4.1. Transportation Process and Requirements

4.1.1. Requirements for Transportation Methods

The equipment can be transported by sea freight or by land. During the loading and unloading process, handle with care to prevent throwing, rolling and excessive pressure; during transportation, avoid external mechanical impacts.

- The transportation plan for bulk goods must be evaluated in advance;
- The speed of vehicles (trucks) must not exceed 100 kilometers per hour and must comply with local laws;
- During driving, do not make sudden braking or sharp turns;
- Ensure the vehicles are in good condition and regularly check their status during transportation to promptly identify and resolve problems;

4.1.2. Requirements for Transportation

Based on the characteristics of the battery, in order to maximize the performance of the battery, the transportation and storage should meet the following requirements:

CAUTION

1. To reduce the impact of condensation water during transportation on the products, desiccants are installed in each box of the products. Please remove them during operation.
2. The desiccants should not be left in the powered equipment for a long time. If they are not removed in time, they will cause damage to the equipment and may even lead to short circuits or even explosions in the electrical equipment.

- Allowed transportation temperature: -30~ + 55 °C
- Humidity: ≤ 85% (no condensation).
- Take appropriate protective measures to keep the SOC level at around 40%, and ensure no short circuit occurs, or prevent liquids from entering the EverCore or being immersed in liquids (such as

water, oil, etc.).

4.2. Storage Requirements

EverCore should be stored in a location free of harmful gasses, flammable and explosive products, and corrosive chemicals. It should be kept away from mechanical shocks, heavy pressure, and strong magnetic fields, and also far from heat sources.

The battery system must operate within the optimal working temperature range to extend the battery's service life and enhance its safety performance.

4.3. Lifting and hoisting equipment

4.3.1. Equipment Requirements

(1) Based on the on-site conditions and the performance of the mechanical equipment, select high-performance lifting equipment, rigging, and shackles for calculation and selection; ensure that the crane and the steel wire rope meet the load-bearing requirements.

(2) Before entering the site, all types of slings, including slings and shackles, should be inspected to ensure they are in good condition. Before the formal lifting operation, the specifications and quality should be reconfirmed to meet the requirements of this lifting operation.

(3) The lifting points are located at the top of the four terminal corners of EverCore.

(4) When installing or dismantling the lifting device, do not drag EverCore. Otherwise, EverCore may be damaged.

4.3.2. Lifting Equipment Hoisting Parameters

Table 4-1 Lifting parameter requirements

Equipment Lifting load-bearing requirements	Length of cable	Number of cables	Acceleration
>5T	>1m	4	≤0.2g

NOTICE

The lifting equipment is provided by the client.

CAUTION

During the lifting process, the center of gravity of EverCore must remain stable.



Figure 4-1 Lifting Installation Diagram

4.3.3. Precautions for Lifting Operations

Lifting process	Precautionary measures
Before lifting	The lifting capacity and working radius of the crane meet the requirements. If the on-site working conditions do not meet the requirements, a professional assessment should be sought.
	EverCore for outdoor use, we recommend that you operate the EverCore in clear, windless and rain-free weather conditions.
	EverCore can be lifted using slings with hooks or U-hooks.
	The hook size must match the hole diameter (D=24mm)
	Each hook should have a working load limit (WLL) of at least 1.8 metric tons.

	Before hoisting, ensure that the crane and the steel wire rope meet the requirements.
	Make sure that all the doors of EverCore have been closed and locked.
In the lifting process	Unauthorized personnel are not allowed to enter the lifting area. Do not stand under the crane arm.
	Ensure that the crane is in the correct position. Do not perform long-distance lifting.
	Maintain the stability of EverCore.
	The diagonal inclination of EverCore should be less than or equal to 5° .
	Lift gently. The cabinet should fall slowly and steadily when dropping to avoid impact on the internal equipment.
	When EverCore comes into contact with the base, the steel cable should be removed after the base is evenly stressed.
	EverCore can only be lifted after it is securely fixed.

4.3.4.Risk Identification for Hoisting Operations



To prevent personal injury or equipment damage, risk identification must be conducted before the lifting operation.

1. The compression or impact caused to the human body during the operation of the crane;
2. The crane hook breaks due to overloading and is lifted when the sling slides off the hook;
3. The falling of the heavy object causes an impact, the heavy object drops from the air and rebounds and injures people;
4. The hoist or sling accidentally comes into contact with the conductive wire;
5. The ground at the working site of the truck crane is uneven, the support is unstable, the weight is unbalanced, and the heavy object exceeds the rated lifting weight, causing the crane to overturn;
6. The wind force is too strong, and the operation is carried out illegally, causing the crane to tip over;
7. Someone is standing under the crane boom and other dangerous areas;
8. Someone is standing or sitting on the hook;

9. No one is directing during lifting, there are people staying in the operation area, and the spare parts and heavy objects of the operating crane swing and strike pedestrians;

10. The crane and other operators do not wear safety helmets and other personal protective equipment;

11. The driver's cabin glass is not cleaned, resulting in unclear vision;

12. The communication between the driver and the commander was poor, or they misunderstood the lifting signals;

13. The lifting method was incorrect, causing the heavy object to fall off the hook;

14. The used lifting ropes exceeded the safety factor;

15. The steel wire rope jumped out of the pulley groove;

16. The brake cracked and the friction pad was worn out excessively.

4.3.5.Lifting Safety Measures



To prevent personal injury or equipment damage, safety measures must be followed.

1. Strengthen on-site construction management. Set up a warning zone at the lifting site and assign full-time safety personnel to supervise and warn. Non-operational personnel are strictly prohibited from entering.

2. Carefully complete the preparatory work before lifting. Prepare mechanical equipment and heavy lifting rigging according to the plan requirements. Strictly follow the performance inspection of lifting equipment, inspection of lifting rigging, pre-lifting detection and lifting procedures to ensure the safety and reliability of the lifting operation.

3. Before all personnel involved in the construction work arrive, conduct detailed technical briefings to make them understand the essentials, procedures and requirements of the operation. After the crane enters the site, the crane driver will introduce the lifting plan in detail and clearly define the unified command signals.

4. The operation position of the crane and the walking route should be carried out according to the plan requirements. The legs' pads must be safe and reliable. Use special roadbed box layers under the legs to expand the unit force surface. The lifting operation of the crane should be smooth, with slow

movements. Pay close attention to the settlement of the crane legs during the lifting operation.

5. The communication between the on-site commander and the crane driver should be timely and reliable. The command signals, flags and gestures should be clear. If any abnormal situation is found, report it to the overall commander of the lifting site promptly to take effective measures as soon as possible.

6. When the wind force is 5 or above, lifting is strictly prohibited in thunderstorms, foggy weather.

7. Construction personnel entering the lifting operation site must strictly abide by the on-site safety regulations and wear labor protection clothing and safety helmets as required.

8. The lifting operation should be under unified command. Operators should hold their own opinions, closely cooperate, and complete the lifting operation safely and smoothly.

4.3.6.Forklift transportation requirement

4.3.6.1. Requirement of Forklift

1) Recommended load capacity: ≥ 5000 kg;

2) The length of the fork arm should not be less than the depth to which the product needs to be lifted. It is recommended that the length of the fork arm (as indicated by the arrow at the lower right corner of the following figure) be ≥ 1.6 meters.



Figure 4-2 Forklift Transfer Illustration

3) When performing forklift transfer operations, it is necessary to ensure that the two sides of the inserted fork arms are at equal distances from the center of gravity of the product. The distance between the two fork arms (excluding the width of the fork arms) should be ≥ 780 mm, as shown in Figure

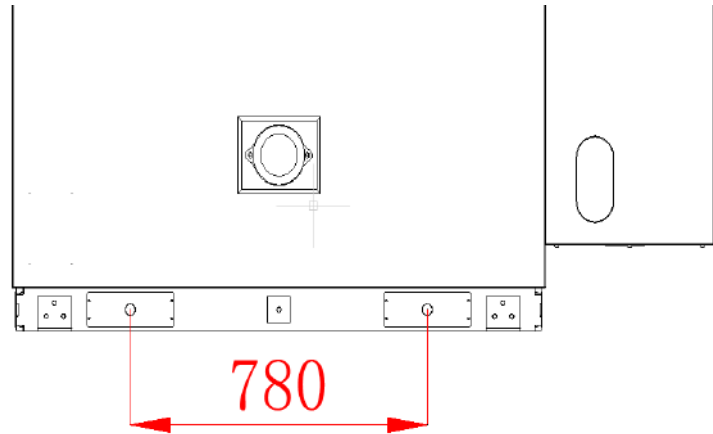

Figure 4-3 Indication of the Distance between the Fork Arms

4.3.6.2. Precautions for Forklift Transfer

- 1) Remove the sealing plates at the bottom of the front and back of the cabinet to ensure that the bottom of the front and back of the cabinet is unobstructed.
- 2) Before the forklift's fork arm extends into the bottom of the cabinet, ensure that the height of the fork arm is lower than the bottom of the cabinet, with a gap of no less than 5 centimeters, to avoid colliding with the cabinet. The fork arm slowly penetrates into the bottom of the cabinet to ensure the stability of the product and the forklift during operation.
- 3) When the fork arm is fully extended and in place, ensure the product is stable. Lift the product carefully and keep the lifting process at a constant speed to avoid sudden lifting or shaking.
- 4) During the transfer process, avoid pedestrians or obstacles in advance, keep the forklift at a low and constant speed, pay attention to the surrounding environment, and slow down when turning to prevent the goods from toppling over and falling.
- 5) After reaching the destination, descend slowly to ensure the goods are safely and smoothly delivered.

5. Product Installation

⚠ DANGER

Electric shock danger! Ignoring the following warnings may result in death or serious injury.

Make sure that no DC voltage is supplied to the equipment and there is no AC voltage on the AC lines; otherwise, it may cause serious injury or death. Provide warning labels to notify all personnel whose devices are not turned on. This label should be hung on the outside of the door and remain clearly visible. Make sure that the external AC side circuit breaker and DC circuit breaker are in the open position.

Do not touch the live parts of the device.

Do not place flammable materials near the equipment

⚠ WARNING

The cables or copper bars provided by the user should meet the current-carrying capacity requirements.

It is necessary to comply with all country-specific standards and regulations

PCS can only be connected to the public power grid after obtaining authorization from the local network operator

Only professional electricians can perform the operations described in this chapter

All wiring instructions must be followed

All input and output circuits are isolated from the housing

Make sure the electrical insulation meets the requirements before laying the cables

In accordance with EMC regulations, power lines and communication cables should be laid in layers

Provide support and protection for the cables when necessary to reduce their stress

Before wiring, please ensure that the equipment is turned off

Operators are strictly prohibited from operating without training

It is strictly prohibited for workers to work by hand without wearing protective equipment

The key points of connection are: ensuring that the connection is correct, reliable (without looseness), has good contact and no short circuit.

During the wiring process, the positive and negative poles of the DC combiner cabinet

must not be reversed

Strictly prevent any form of short circuit during the connection process

NOTICE

Moisture can damage equipment. For the normal operation of the equipment, please abide by the following rules

Do not open the equipment door when the relative humidity is higher than 95%

Do not maintain or repair the equipment in rainy or other bad weather

The installation and design of the equipment must comply with national and local standards and regulations

The wire dimensions and rated values are provided by the manufacturer in the corresponding table. If other cable sizes comply with local standards or regulations, they can also be used

The size of the grounding wire must be larger than half of the size of the AC or DC cable

5.1. Requirements for the Site

5.1.1. Battery Cabinet Installation Dimensions

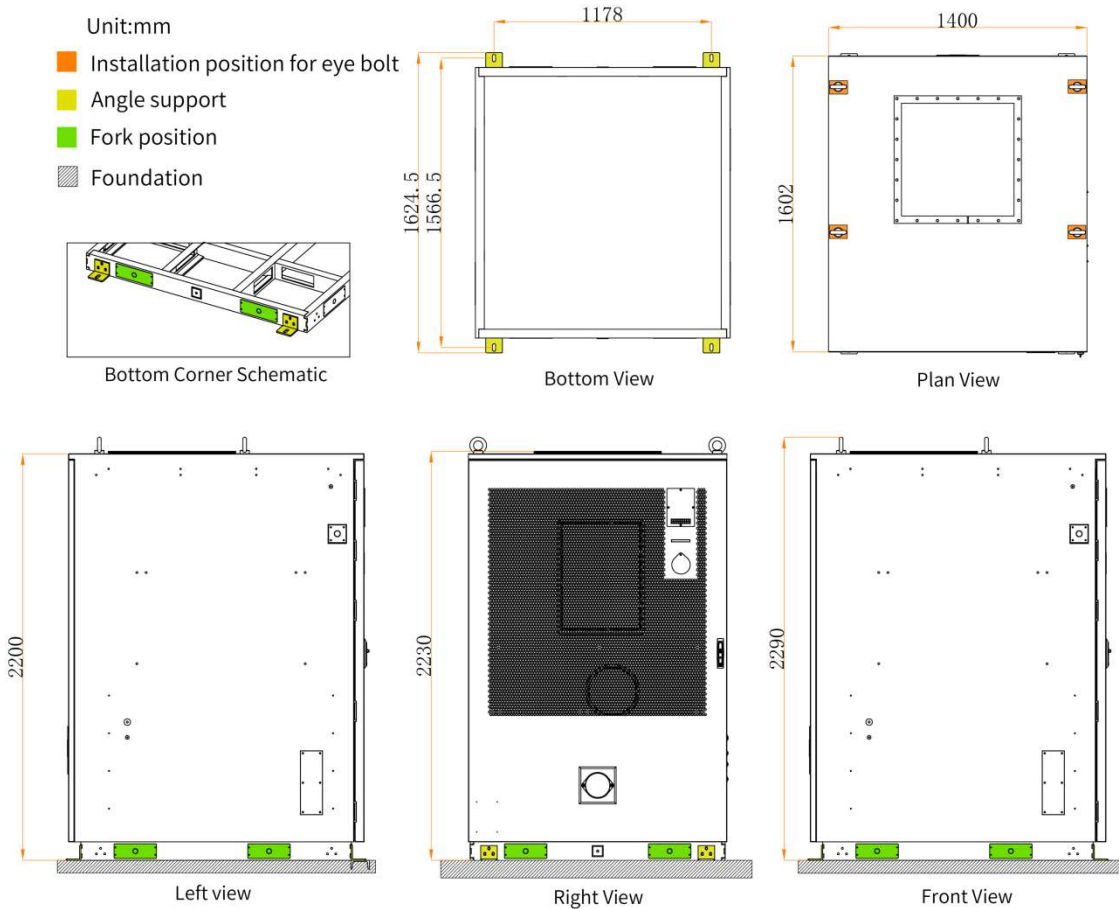

Figure 5-1 Appearance and dimension (without inverter)

5.1.2. Basic Requirements and Product Installation Spacing

The EverCore system is suitable for general outdoor scenarios. According to local laws and regulations, the site selection requirements are as follows:

1. The installation location should not be in low-lying areas, and the site level should be higher than the historical highest water level in that area.
2. The soil conditions should be good, and the ground should be solid. There should be no poor geological conditions such as rubber soil or soft soil layers. Avoid ground that is prone to water accumulation and subsidence.
3. The equipment should be installed in a well-ventilated area.
4. The equipment should be installed on a foundation, with the foundation height from the ground not less than 200 mm. The foundation should be flat, solid, and able to bear the weight of the equipment.

5. Stay away from strong vibrations, noise sources, and electromagnetic interference areas. Try to avoid existing underground facilities.

6. Stay away from places that produce dust, smoke, and harmful gasses, and from places that produce or store corrosive, flammable, and explosive substances. The distance from airports, landfill sites, riverbanks, coasts, or dams should not be less than 2000 meters.

7. Select an open location according to the requirements of Figure 5-2 and ensure there are no obstacles from surrounding areas.

8. Maintain a distance of at least 50 meters from residential areas to avoid noise pollution.

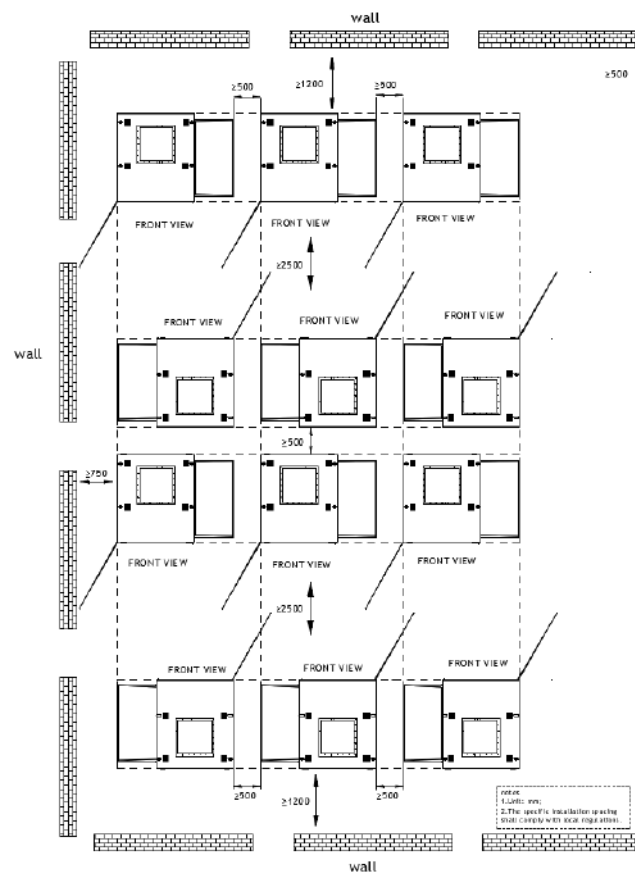

Figure 5-2 Product Installation Distance Requirement

1. The minimum distance between back-to-back units is 500mm.
2. The recommended distance when facing each other should be ≥ 2500 mm (between air conditioners).
3. The minimum gap between the back of the cabinet and the wall is 1200mm.

4. The recommended minimum distance between the front of the cabinet and the wall is 2000mm (between the wall and the cabinet door).

5. The minimum distance on the side of the inverter is suggested to be 500mm.

CAUTION

The above minimum interval parameters are for reference only. The specific requirements and standards should be in accordance with those of the local fire department.

5.1.3. System Anti-Vibration Protection Requirements

In EverCore, batteries are connected in series, and the management system and various sensing devices are installed. The whole battery system must be installed firmly and reliably without loosening or shaking. Collision avoidance devices of sufficient strength must be installed at the periphery of the battery system installation space to ensure that no safety incidents (e.g. direct short circuit, overheating and combustion) will be caused by general collisions and will not directly damage the battery system and battery.

5.1.4. Ventilation and Heat Dissipation Requirements

EverCore generates a large amount of heat during operation. Excessive equipment temperature will directly affect its electrical performance and even damage the equipment. Therefore, when designing the placement space for EverCore, it is necessary to fully consider the dissipation of these heats to ensure the normal and efficient operation of the equipment. To meet the ventilation requirements of EverCore, its installation environment must at least meet the following requirements:

1. Avoid installing it in a closed space or a place with poor ventilation. Greater ventilation volume can be obtained through construction measures such as adding air supply grilles or fans.

2. The air inlet should have an adequate supply of fresh air. It is necessary to prevent air short circuit (hot air from the air outlet being sucked in from the air inlet).

NOTICE

Please observe the following items:

Regularly (suggested every 6 months) clean the grilles, filters and filter cotton at the air intake and exhaust ports of the equipment.

Regularly (suggested every 6 months) check whether the exhaust fan inside the EverCore equipment is functioning properly.

The regular clearing and inspection cycle will be shortened according to the actual situation

⚠ WARNING

It is essential to ensure the unobstructed flow of air through the intake and exhaust ports; otherwise, it will seriously affect the operation of the equipment.

5.2. Installation Foundation Requirements

EverCore system can support both concrete foundation installation and flat ground installation.

5.2.1. EverCore Foundation Requirements

Before installing EverCore, please construct the foundation and ditches on the selected ground. The construction requirements for the foundation are as follows:

1. The size of the foundation should meet the installation and bearing capacity requirements of EverCore, as shown in Table 5-1.

Table 5-1 The Construction Requirements

Type of ground	Requirement	Remark
Concrete floor	The ground needs to be able to bear a load of 1.5*n (where n represents the number of parallel machines) tons.	The ground should meet the following requirements: ◆ Horizontal deviation ≤ ±10 millimeters ◆ Plane degree deviation ≤ ±4 millimeters per 2 meters
Level land surface		

2. Foundation Requirement

Foundation requirements (for a single machine):

As shown in Figure 5-3, each cabinet has four fixed points.

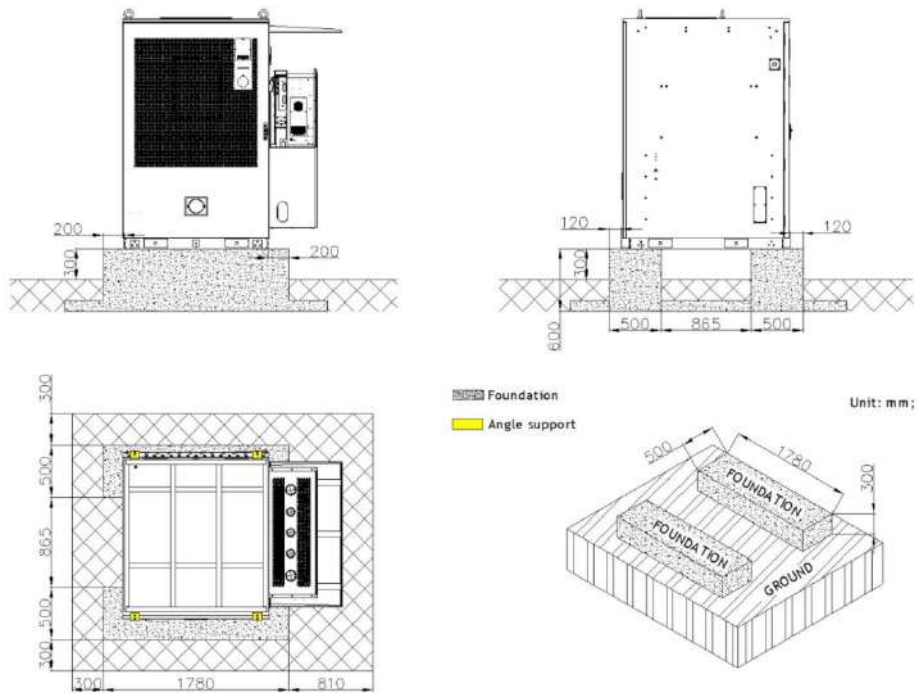

Figure 5-3 Foundation

3. Other Requirements:

Place the grounding grid and reserve grounding strips at the EverCore's ground position. Connect one end of the grounding grid to the embedded grounding grid, and the other end to the EverCore's grounding point. When the grounding network is embedded, ensure there is sufficient length for the grounding plate to connect to the grounding point on EverCore.

The protective bonding resistance of EverCore shall be less than or equal to 0.1Ω .

EverCore uses side cable entry, so there is no need to pre-lay cables.

The inner diameter of the protective pipe should be no less than 1.5 times the outer diameter of the cable (including the protective layer).

The foundation construction should meet the drainage requirements for the local maximum historical rainfall. The discharged water should be treated in accordance with local laws and regulations.

5.2.2.Level Land Surface Installation

1. As shown in Figure 5-4, each cabinet is provided with 4 fixing points on 4 feet.

Fixing $\phi 14\text{mm}$ holes are pre-reserved at the fixing feet points, which shall align with the openings at the bottom corners of the cabinet base. Secure the cabinet using M12 screws with matching nuts.

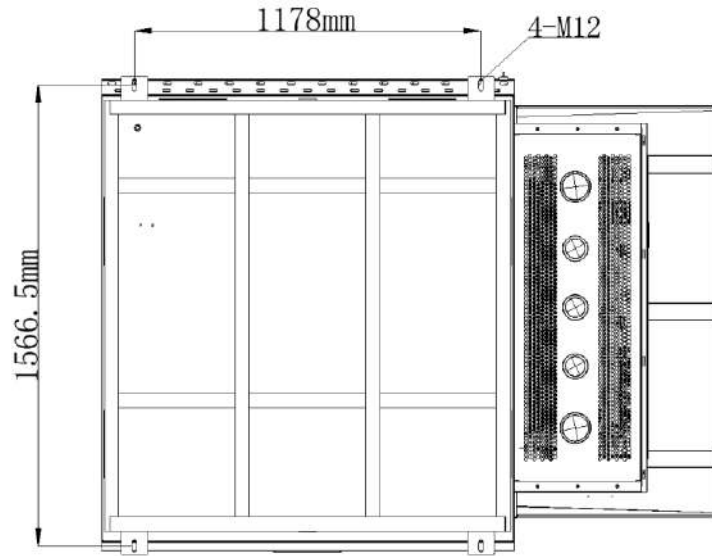

Figure 5-4 Fixed schematic diagram

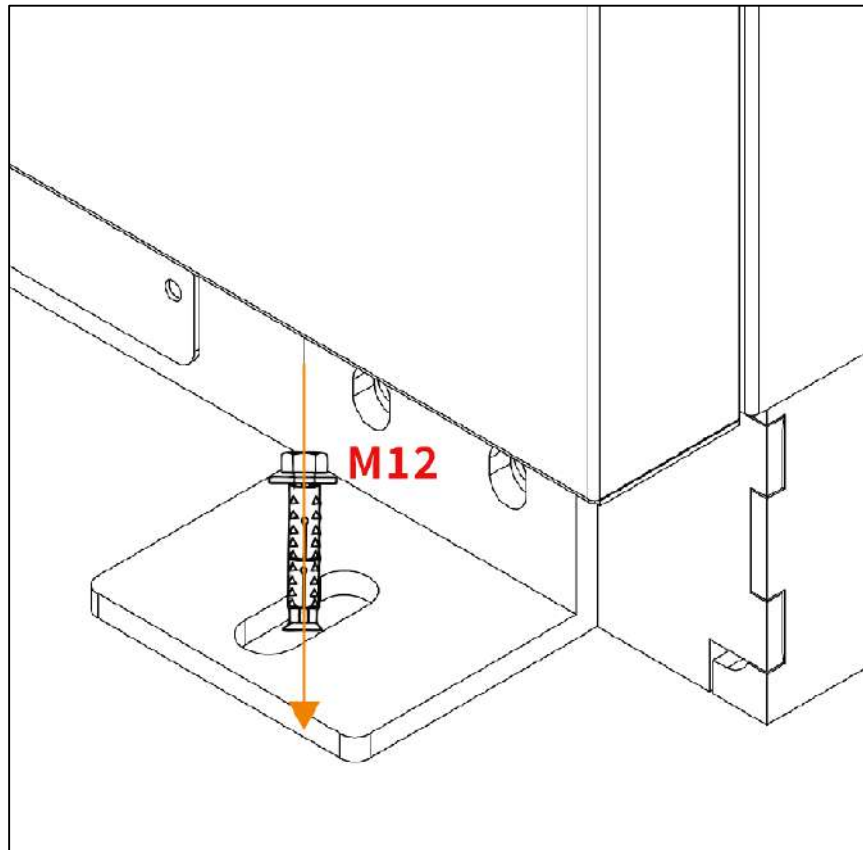

Figure 5-5 bottom corner Tightening expansion bolts

Level ground installation is suitable for areas where high water accumulation (≥ 50 mm) will not occur.

If the installation site is prone to water accumulation, it is recommended to add a concrete foundation.

2. Requirements for cable trays

The cable tray is recommended to be made of corrosion-resistant metal (such as stainless steel or aluminum alloy) (such as stainless steel, aluminum alloy, etc.) to adapt to the environment of the plant station.

The total cross-sectional area of the cable should not exceed 40% (for power lines) or 50% (for control cables) of the cross-sectional area within the cable tray. It is recommended that the specification of a single cable tray should be no less than 50mm*100mm. The specific quantity and specification should be confirmed based on the number of parallel units in the plant station and the cable specification.

The wire slot must be reliably grounded throughout, with electrical connection between each section and connection to the grounding grid of the plant station.

After the cable is wired, all holes in the cable ducts and joints of the cable troughs must be sealed to prevent small animals from entering and to prevent fire.

3. Other requirements:

- The grounding grid shall be buried beneath the EverCore location, with grounding strips reserved at the designated grounding points. One end of the grounding strip shall be connected to the embedded grounding grid, and the other end to EverCore grounding terminal.
- Sufficient length shall be reserved during installation to ensure reliable connection to the EverCore grounding point.
- The earth resistance of the grounding system for EverCore shall be $\leq 4\Omega$. The foundation construction should meet the drainage requirements of the local historical maximum rainfall.
- The discharged water should be treated in accordance with local laws and regulations

5.3. Mechanical Installation

5.3.1. Requirements for Disassembly of Product Outer Packaging

The unpacking steps are as follows:

1. Remove the wrapping film outside the packaging box.
2. First, remove the top cover of the carton, and then take off the four side panels.
3. Remove the packaging bag, unscrew the four nuts on the wooden box pallet, and take off the bolts and washers.
4. Remove the equipment from the tray.

5. Unpacking is complete.

5.3.2.Packaging

Please ensure that the following items are included in the packaging with your machine:

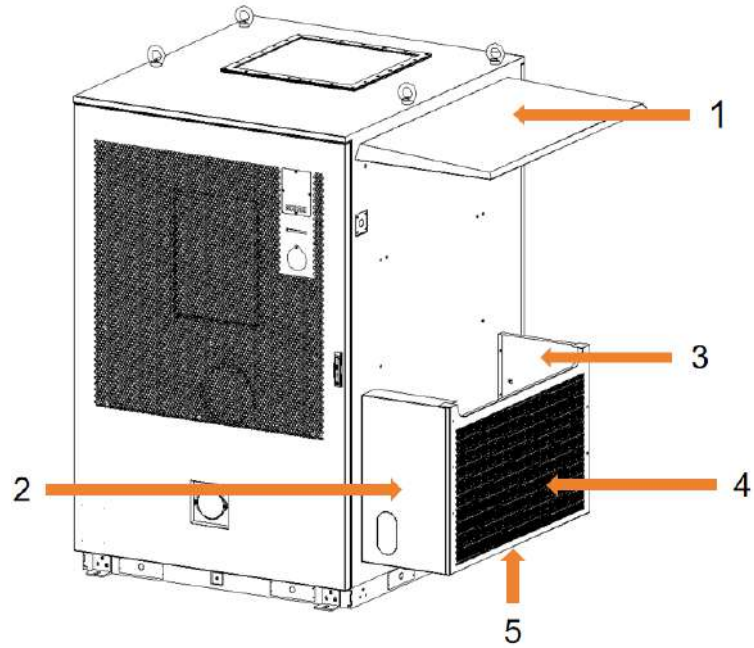
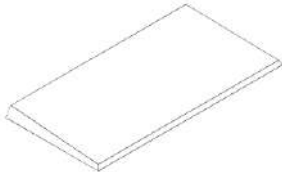
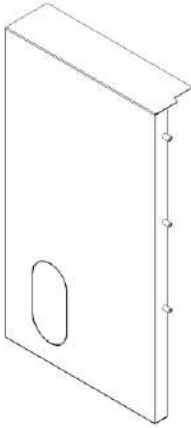
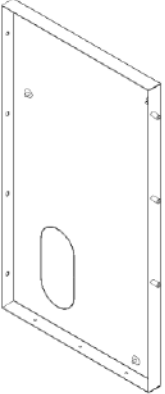
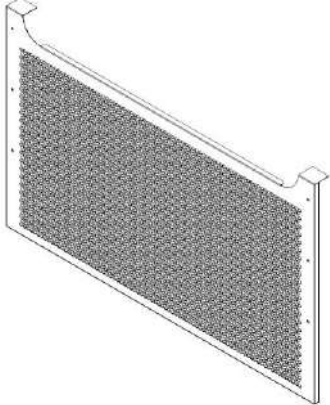
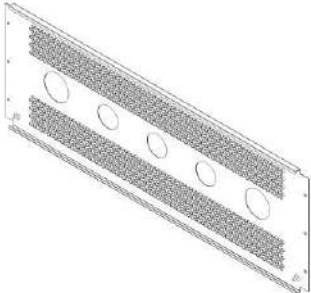
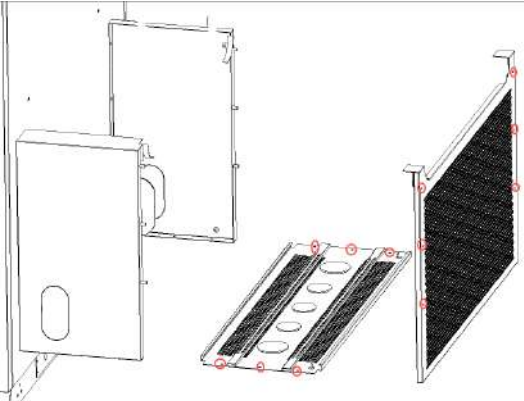

Figure 5-6 Accessory Diagram

Number	Name	Amount	Item
1	Sun shade	1	
2	Right side panel	1	

3	Left side panel	1	
4	front panel	1	
5	bottom panel	1	
/	Screw M6*12/304 Steel	12	

5.3.3.EverCore Cabinets Installation with Hybrid Inverters

The battery cabinet and the hybrid inverter are shipped separately. At the user's site, the hybrid inverter needs to be installed on the battery cabinet first. The installation steps are as follows:

1. Install a sun shade.

Install a sun shade, Use M8×25 hexagonal flange bolts to fix Inverter Sunshade at the upper right position of the cabinet.

Connecting the ground cable of [Top baffle] to cabinet

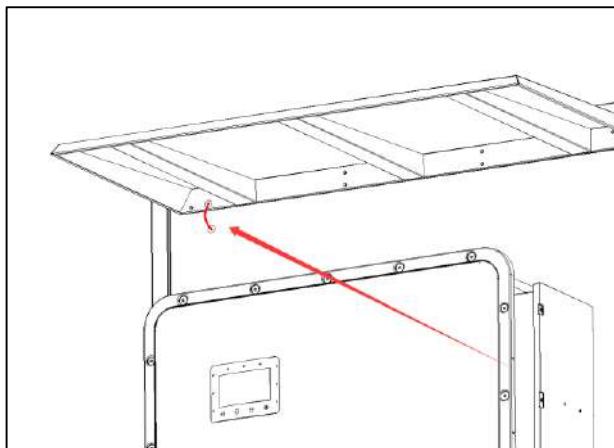

Figure 5-7 Sun shade ground wire

2. Secure the inverter bracket, then hang the inverter on the bracket.

Use M10×16 hexagonal flange bolts to lock the back plate of the hybrid inverter onto the cabinet body, and then use a forklift to assemble the hybrid inverter onto the back plate. Lift the hybrid inverter (be careful to avoid physical strain), and align the back plate of the hybrid inverter with the raised part of the installation bracket. Hang the hybrid inverter on the installation bracket and make sure it is firmly installed.

3. Fix the left and right end panels of the output cover.

As shown in the diagram, use M6×12 hexagonal flange bolts to fix Left side panel and Right side panel on the bottom side of the inverter.

Using M6×12 hexagonal flange nuts, secure components bottom panel to the lower sections of both side panels from above.

Connecting the ground cable of [the right / left side baffle] to cabinet

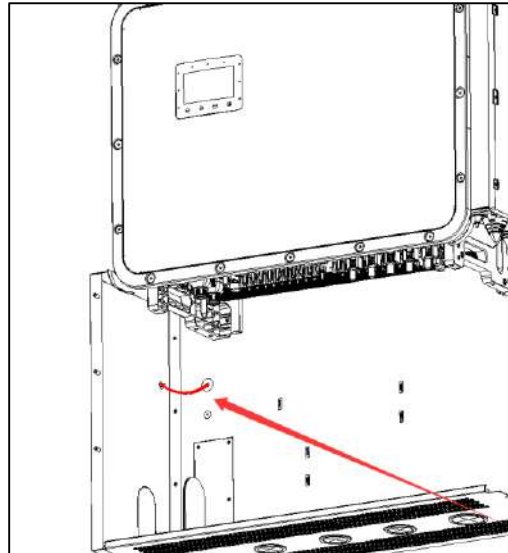

Figure 5-8 panel ground wire

4. Secure the bottom panel of the output cover from top to bottom.
5. Finally, fix the front panel.

After the assembly of the hybrid inverter wiring harness is completed, use M6×12 hexagonal flange bolts to fix front panel at both ends of the side plates.

Table 5-2 Bolt and Nut Torque Gauge

Bolt diameter	Torque(N.m)	Re-twisting torque(N.m)
M6	10	9
M8	20	15
M10	30	25
M12	50	45

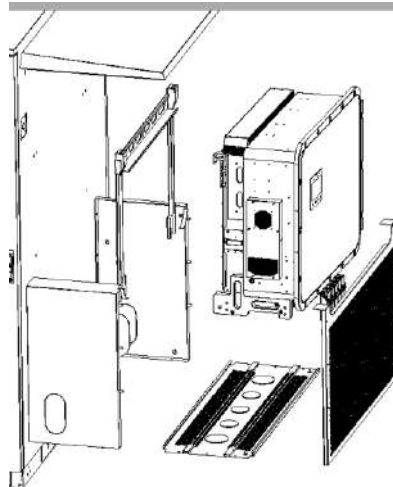

Figure 5-9 Installation Diagram of the Hybrid Inverter and Battery Cabinet

5.3.4.Tool List

The main tools used during the installation process can be referred to in the following figure and table.



Table 5-3 List of Tools

No.	Tool	Technical requirements	Amount
1	Hex Key	M8	1pcs
2	Ratchet Screwdriver Set	Slotted head, crosshead and hexagonal head	1pcs
3	Socket Wrench Set		
4	Screwdriver	5.5mm	1set
5	Mini Screwdriver Set	Slotted head, crosshead and hexagonal head	1set
6	Cold-pressed Crimping		1pcs
7	Multi-meter		1set
8	Insulation resistance meter		1set
9	Network cable pliers		1set
10	Wire stripper		1pcs
11	Forklift	Load capacity \geq 5000kg	1pcs
12	Crane	Load capacity \geq 5000kg	1pcs

13	Electric-Powered Hydraulic pliers	M8	1 pcs
14	Hook		2 set
15	Wire Rope	≥2m	2 set

5.3.5.Product Installation Requirements

When choosing the installation location for the product, the following criteria should be considered:

1) Direct exposure to sunlight may cause the inverter to output reduced power due to overheating. It is recommended to avoid installing the inverter in a position directly exposed to sunlight. The ideal location is where the surrounding temperature does not exceed 40°C.

2) It is recommended to install the inverter at a position where rain and snow will not directly fall on it. The ideal installation location is on the north-facing wall under the eaves.

3) Do not install the inverter in an environment where there may be explosive atmospheres.

4) The inverter must be installed vertically (90 degrees, or tilted backward by no more than 15 degrees).

5) The temperature of the inverter's heat sink can reach 75°C. Product installation gap requirements, please refer to Section 5.1.2 for detailed information.

7) Avoid direct exposure to sunlight.

It is advisable to avoid installing the inverter in a location exposed to direct sunlight. Direct sunlight may cause:

Reduced power output (resulting in decreased system energy output)

Early wear of electrical/mechanical components

Early wear of mechanical components (seals) and user interface

1) Air circulation

Do not install it in a small, enclosed room where air cannot flow freely

To prevent overheating, always ensure that the air circulation around the inverter is not obstructed

2) Flammable substances

Do not install it near flammable substances. Keep at least three meters (10 feet) away from such substances.

3) Living area

Do not install it in a living area where people or animals stay for a long time. Depending on the installation location of the inverter (such as the type of surface around the inverter, the general attributes of the room, etc.) and the power supply quality, the sound level of the inverter may be very high.

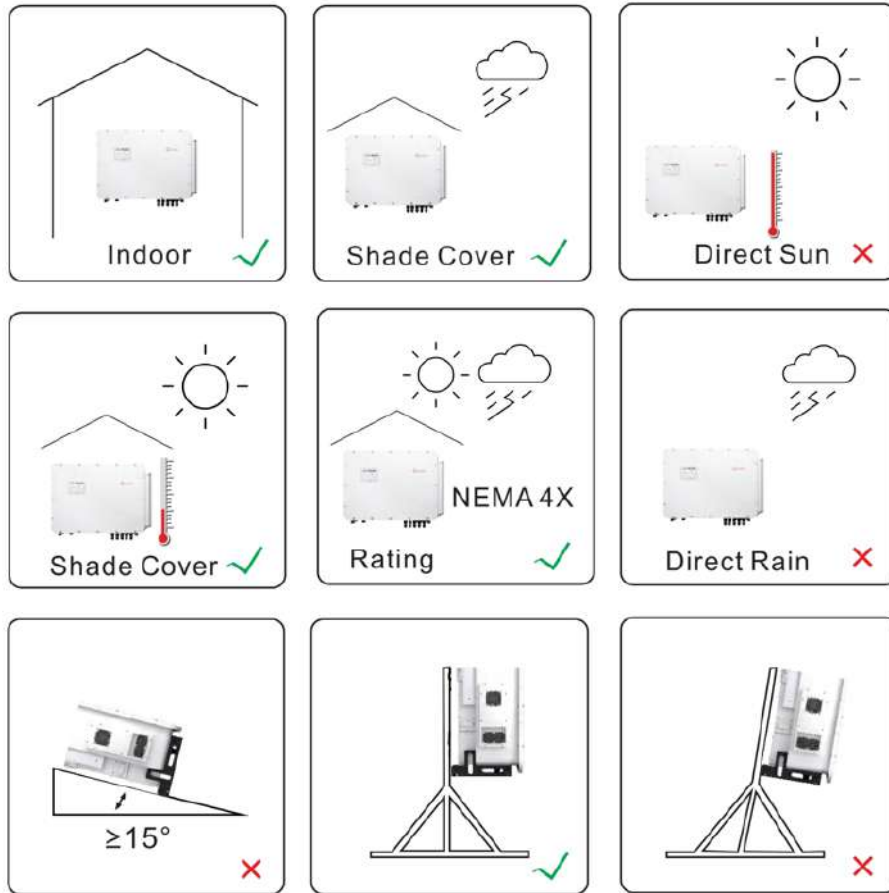

WARNING

Hot Surface

The temperature of the inverter heat-sink can reach 75°C.

The ambient temperature and relative humidity of the installation environment should meet the following requirements:

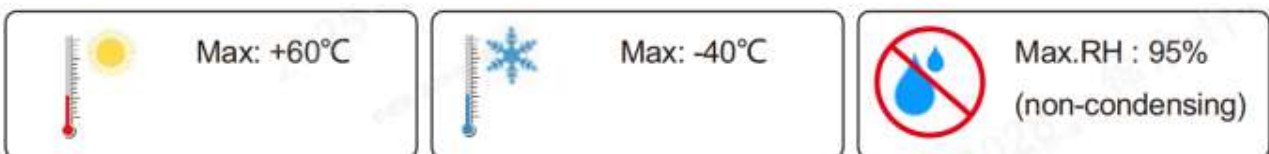

5.4. Electrical Connections

5.4.1. Wiring Requirements

The cables used in the system are divided into power cables, auxiliary power supply cables and communication cables. It is recommended to place the power cables, auxiliary power supply cables and communication cables in different Cable glands to reduce electromagnetic interference caused by voltage fluctuations.

The power cables, auxiliary power supply cables and communication cables should run side by side, with a distance of more than 200 mm. The wiring should avoid crossing as much as possible, and at the crossing points, the cables need to maintain a 90 degree right angle, with a distance of no less than 250 mm.

The recommended minimum space distance between parallel cables and power cables and the corresponding relationship in the field are shown in the following table.

Table 5-4 Minimum Spatial Distance

Length of parallel cables	Minimum spatial distance
200m	0.2m
300m	0.3m
500m	1.2m

5.4.2. Cable Fixing Requirements

In order to prevent the connection copper terminals from loosening due to force, resulting in poor contact, increased contact resistance, overheating and even fire, it is necessary to ensure that when tightening the screws of the connection copper terminals, the following torque requirements should be met:

Table 5-5 Screw Torque Table

Screw specification	M3	M4	M5	M6	M8	M10	M12	M16
Torque (N.m)	0.8-1	1.8-2.2	4-5	6-8	12-15	32-40	56-70	96-120

To reduce the force exerted on the copper terminals of the wiring, the cables should be fixed at appropriate positions.

5.4.3. System Grounding Requirements

Grounding resistance requirements:

1. Continuity of equipment grounding: $R < 0.1 \Omega$;
2. Recommended value for system grounding resistance: no more than 4Ω

5.4.4. EverCore Electrical Connection

The external connections of EverCore mainly including **power cable connection**, **auxiliary power connection** and **communication connection**. As the battery cabinet and hybrid inverter are shipped separately, the electrical connections for EverCore are divided into two corresponding sections. One part is the electrical connection between the battery cabinet and the hybrid inverter, and the other part is the connection between EverCore and the on-site equipment.

The electrical connection between the battery cabinet and the hybrid inverter mainly consists of DC circuit cable connection, AC auxiliary power connection, communication cable connection and grounding cable connection.

The connection between EverCore and the equipment site mainly includes the wiring of the PV module, utility grid, user load (Backup port), diesel generator, grounding wire, and the communication connection of EverCore.



Before installing the cables, make sure that the OCPD (circuit breaker) is turned off.

Before proceeding with the operation, use a multimeter to confirm that the voltage is 0Vac

5.4.4.1. The Electrical Connection between the Battery Cabinet and the Hybrid Inverter

5.4.4.1.1. DC Circuit Cable Connection between the Battery Cabinet and the Hybrid Inverter

1. DC circuit cable connection: The hybrid inverter is connected to the battery cabinet distribution box via two dc power cables.
2. The label of the cable is: BAT1, BAT2. Connect according to the connection points shown in Figure 5-10. When wiring, pay attention to the polarity definition. The following is the interface definition:

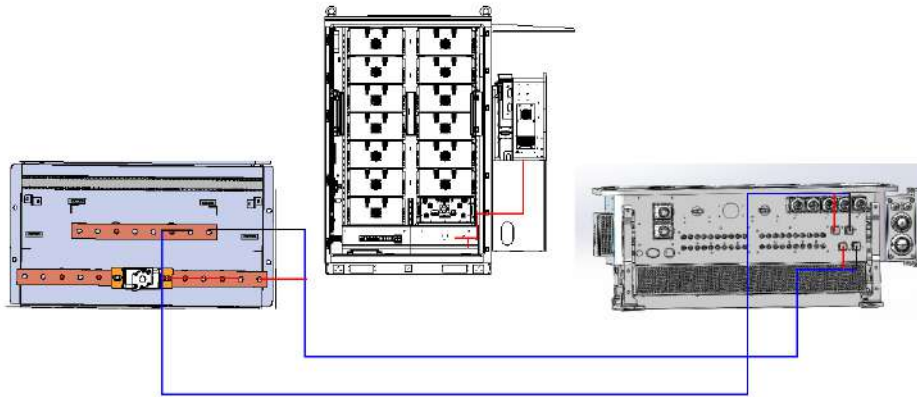
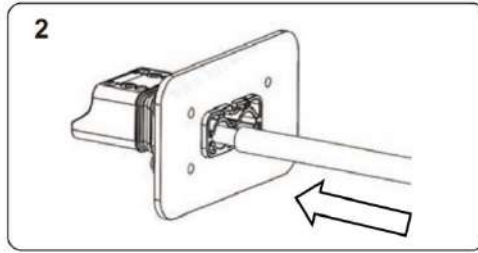
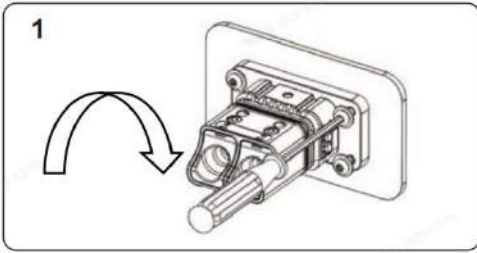

Figure 5-10 Diagram of DC Circuit Connection for Battery Cabinet

Position	Terminal 1	Terminal type	Position	Terminal 2	Terminal type	remark
Battery cabinet	BAT1+	Copper Tube Terminal (SC Tube)	Hybrid inverter	BAT1	Copper Tube Terminal (SC Tube)	DC+
	BAT1-	Copper Tube Terminal (SC Tube)			Copper Tube Terminal (SC Tube)	DC-
	BAT2+	Copper Tube Terminal (SC Tube)		BAT2	Copper Tube Terminal (SC Tube)	DC+
	BAT2-	Copper Tube Terminal (SC Tube)			Copper Tube Terminal (SC Tube)	DC-

5.4.4.1.1.1. Steps for Connecting the Battery Terminals of the Hybrid Inverter:

- 1) Press the locking plate screws with the T20 Torx Screwdriver, with a torque of 1.2 ± 0.1 N.m.
- 2) Insert the stripped wires into the corresponding connection holes in the order of wiring.



3) Press the wiring with a T8 Torx Screwdriver, with a torque of 1.2 ± 0.1 N.m.

4) One by one, insert the stripped wires into the locking nut and the main body (soft wires need to be riveted to the insulation terminals).

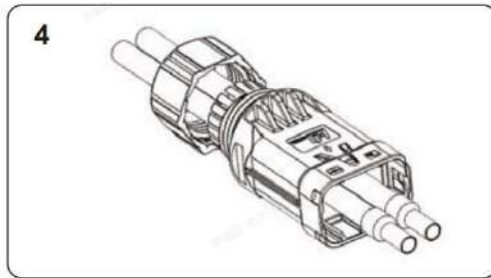
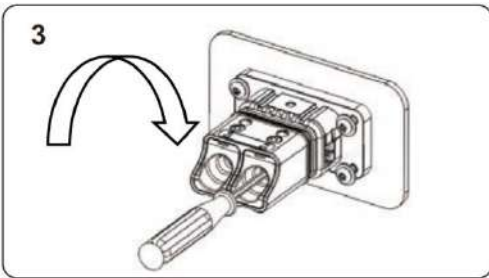

5) Insert the cable into the rubber core in the order of the lines. Observe the viewing hole. The cable is in place. The torque of the crimping screwdriver is 4 ± 0.1 N.m.

6) Insert the main body into the rubber core and hear the "click" sound.

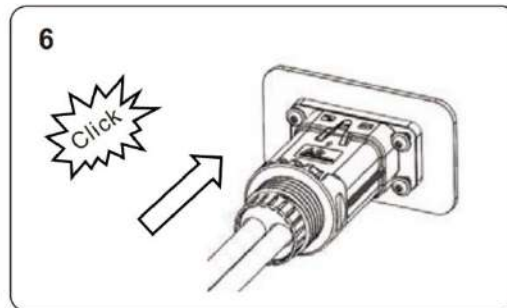
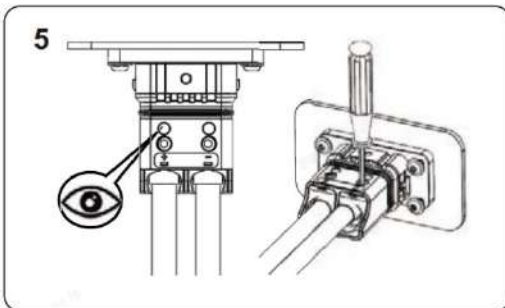

7) Tighten the nut with an open-end wrench (torque 10.0 ± 0.1 N.m).

8) Installation completed.

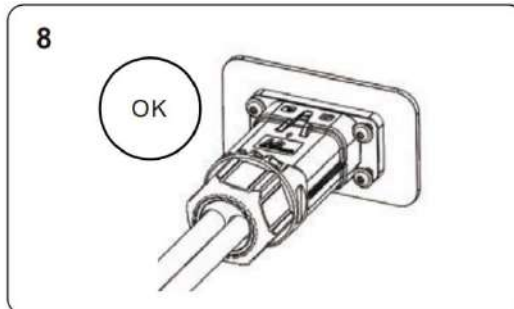
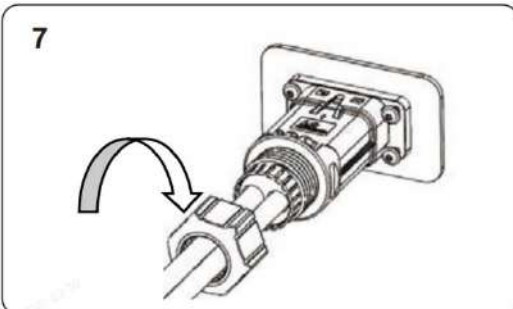

5.4.4.1.2. AC Auxiliary Power Connection Between the Battery Cabinet and the Hybrid Inverter

1. Connect according to the connection points shown in Figure 5-11. The following is the interface definition:

Position	Terminal 1	Terminal type	Position	Terminal 2	Terminal type	Remark
cabinet	L1	Pre-installed	Inverter Backup port	L1	Ring Terminal	A phase
	L2			L2	Ring Terminal	B phase
	L3			L3	Ring Terminal	C phase
	N			N	Ring Terminal	Neutral
	PE			PE	Ring Terminal	PE

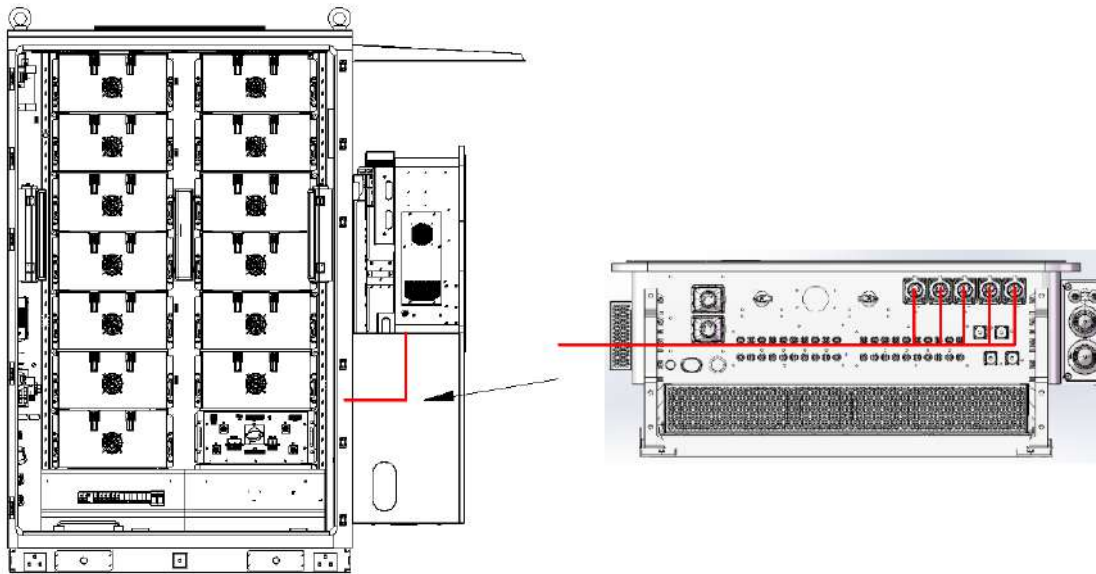

Figure 5-11 Auxiliary Power Connection

2. Connection precautions for the AC cables at the hybrid inverter (including Smart port/ Backup port /Grid port)

The allowed maximum temperature when connecting the AC power and the battery terminals is 85°C.

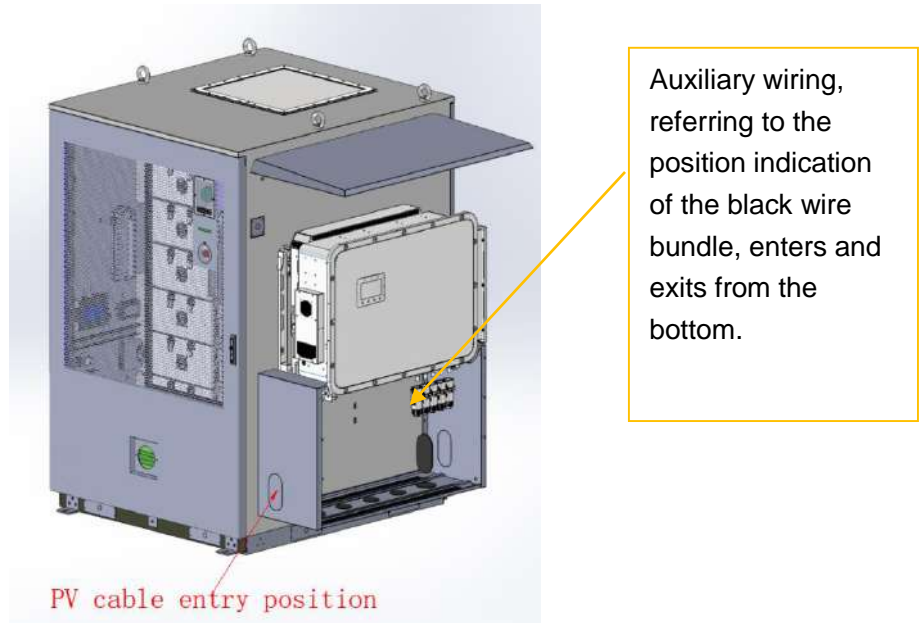

Figure 5-12 AC Auxiliary Power Cable Wiring from Inverter Bottom



Figure 5-13 AC terminal in Inverter Wiring Box

Model	BACKUP	SMARTLOAD/ GEN/INV	GRID	PE
Wire Size	0AWG/1AWG	0AWG/1AWG	00AWG/000AWG	1AWG/2AWG
Cable	70-95mm ²	70-95mm ²	95-120mm ²	50-75mm ²
Torque	10-12N.m	20-30N.m	20-30N.m	10-12N.m

- Detailed wiring steps are as follows

1. Disconnect the AC circuit breaker to ensure it won't accidentally turn on.
2. Strip the insulation sheath from the end of the AC cable to a length B, where B (insulation stripping length) is 2 mm – 3 mm longer than A (OT cable terminal crimping area). Place R-type

terminals on both ends and perform a secure crimp connection. The crimped part of the terminals must be insulated with heat shrink tubing or insulating tape.

3. When connecting to the grid port and the SMARTLOAD/GEN/INV ports, remove the three screws on the cover of the inverter junction box, and then remove the junction box cover.

4. Select the matching diameter of the outlet sealing ring according to the diameter of the AC cable. Cut the diameter of the sealing ring to the appropriate size, pass the cable through the sealing ring, remove the nut at the corresponding position of the wiring box, and use a socket

5. wrench to connect the cable to the corresponding AC terminal block in sequence. The torque should follow the recommended torque in table.

6. To ensure the waterproof effect, the operator needs to regularly check if the sealing ring is damaged.

7. When the cable is coming out in right wiring box, there should be no openings or gaps between the tower protective sleeve and the cable.

8. After the AC cable are wired, the cables should be fixed, The installers should use the ribbon to secure the wire harnessed in the holes of the surrounding metal shells.

5.4.4.1.3. The Communication Cable Connection between Battery Cabinet and the Hybrid Inverter

1. The communication cable from the hybrid inverter to the battery cabinet. Connecting the one CAN cables reserved in the integrated cabinet according to Figure 5-14. Connect the end with the RJ45 to the communication interface of the hybrid inverter. The following is the interface definition.

Position	Terminal 1	Terminal Type	Position	Terminal 2	Terminal Type	Remark
Cabinet (The terminal has been pre-installed)	CANH1	RJ45	inverter arm board BMS Port	BMS (for battery communication)	RJ45	CAN-H
	CANL1					CAN-L

2. The Cabinet terminal has been pre-installed. The RJ45 port is reserved at the below figure indicated position. During installation, pull out the cable and connect it to the corresponding port (BMS1) of the hybrid inverter according to the port definitions in the above table.

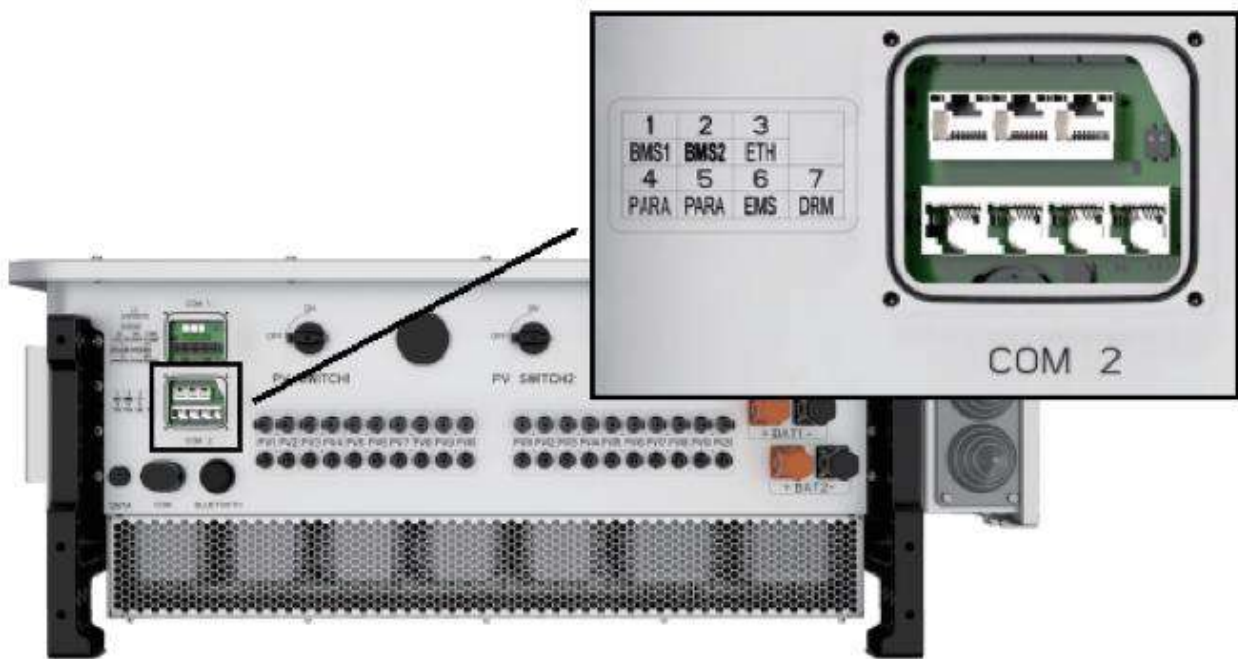

Figure 5-14 Communication Cable Connection Diagram

5.4.4.1.4. The Grounding Cable Connection between the Battery Cabinet and the Hybrid Inverter

1. As shown in Figure 5-15, on the right is the grounding copper bar of the battery cabinet. The holes in the copper bar are M8. SolisStorage will provide two grounding cables. Connect the two grounding cables from the left and right shells of the hybrid inverter to the grounding copper bar.

2. About grounding copper bar in battery cabinet, please note that the four one terminal for hybrid inverter grounding cable connection, the middle one used for cabinet grounding to foundation ground.

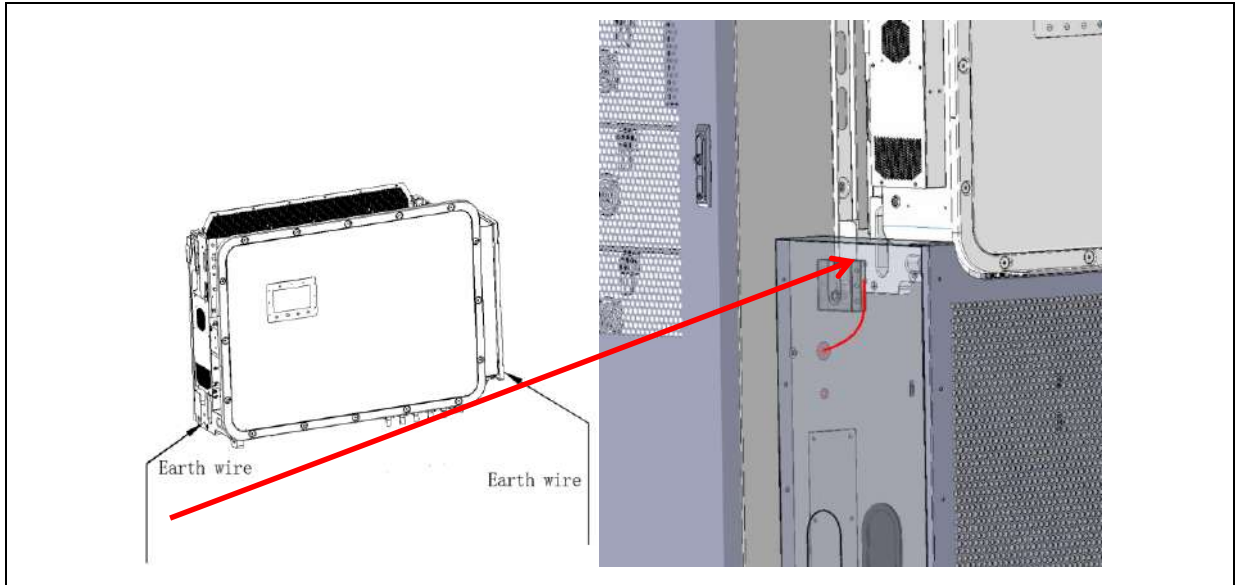

Figure 5-15 Grounding Cable Connection Diagram

5.4.4.2. Connecting EverCore to the Field Equipment

5.4.4.2.1. EverCore Connection with On-Site PV Modules

⚠ DANGER

Before connecting the inverter, make sure that the open-circuit voltage of the photovoltaic array is within the limit range of the inverter.

Before connection, confirm that the polarity of the output voltage of the photovoltaic array matches the "DC+" and "DC-" symbols.

Please use the approved DC cables for the photovoltaic system.

The user's on-site PV system should be connected to the hybrid inverter. Please refer to Figure 5-16 for the wiring instructions:

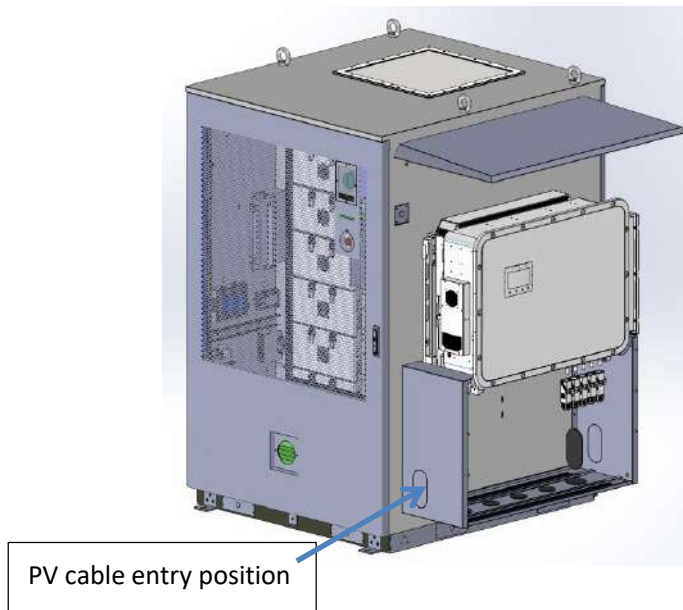
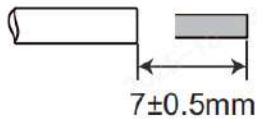

Figure 5-16 PV Wiring Diagram

1. PV Cable Installation

1. Select the appropriate DC cable and strip the outer sheath of the wire by 7 ± 0.5 millimeters. Please refer to the table below for specific specifications.



Cable type	Cross section (mm ²)	
	Range	Recommended value
Industry generic PV cable	4.0~6.0 (12~10AWG)	4.0 (12AWG)

Figure 5-17-1

2. Remove the DC terminals of the accessory package, rotate the nut to disassemble it, and remove the waterproof rubber ring.

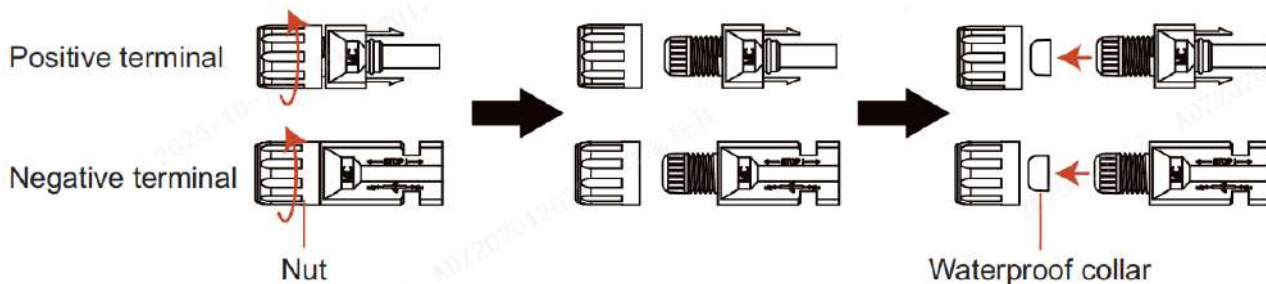

Figure 5-17-2

3. Pass the stripped DC cable through the nut and the waterproof rubber ring.

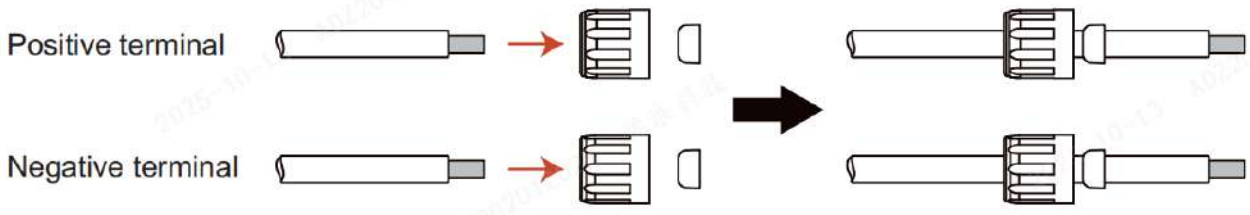

Figure 5-17-3

4. Connect the wire part of the DC cable to the metal DC terminal, and use the dedicated DC terminal crimping tool for crimping.

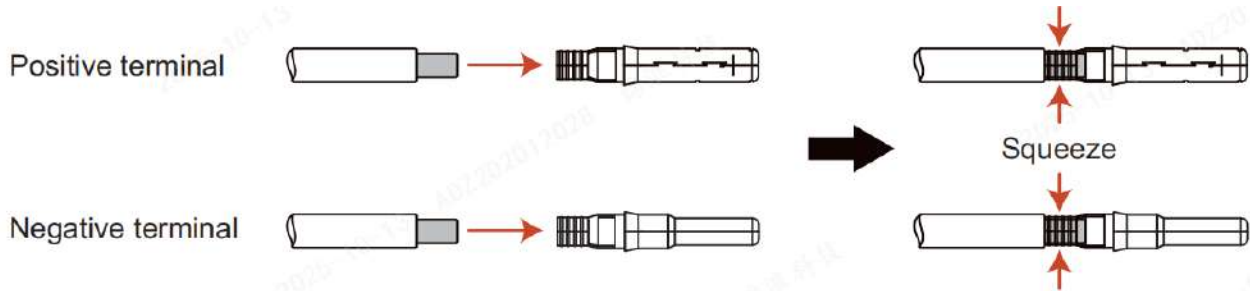

Figure 5-17-4

5. Insert the press-welded DC cable firmly into the DC terminal, then insert the waterproof rubber ring into the DC terminal and tighten the nut.

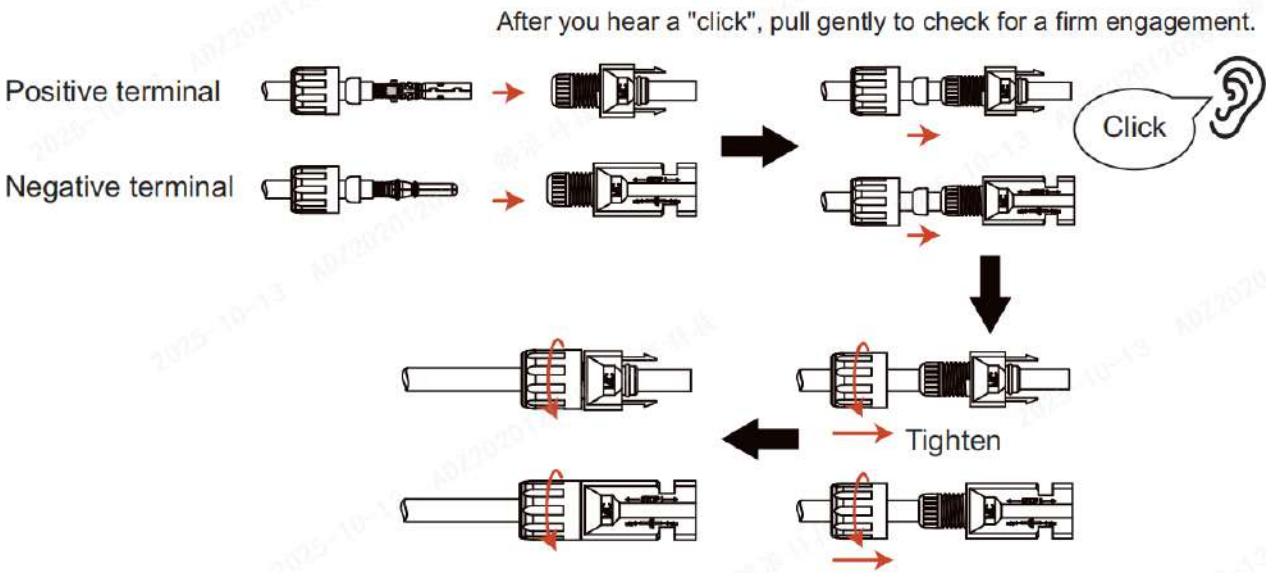

Figure 5-17-5

6. Use a multimeter to measure the DC input photovoltaic voltage and verify the polarity of the DC input cable.

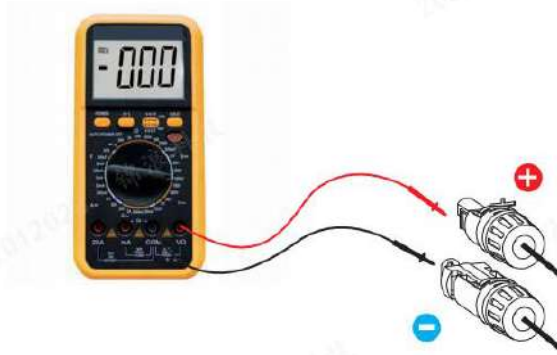

Figure 5-17-6

7. Connect the already wired DC terminals to the inverter as shown in the figure, and gently tighten the nuts to ensure a secure connection. When you hear a "click" sound, it indicates that the connection is correct and secure.

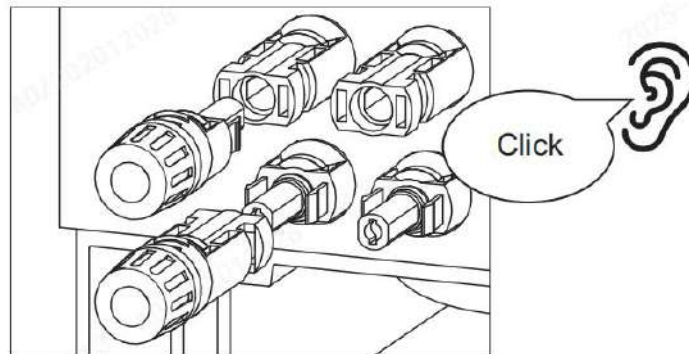

Figure 5-17-7

When installing, please pay attention to the following points:

If the DC input is accidentally reversed or the inverter malfunctions or operates abnormally, the DC switch must not be turned off. Otherwise, it may cause a DC arc, damage the inverter, and even lead to a fire.

The correct operation is:

1. Use the clamp-type clamp meter to measure the DC series current.
2. If the current is higher than 0.5A, wait until the solar irradiance decreases until the current drops below 0.5A.
3. Only when the current is lower than 0.5A, is it allowed to close the DC switch and disconnect the photovoltaic series.

4. To completely eliminate the possibility of faults, disconnect the photovoltaic series after closing the DC switch to avoid secondary faults caused by continuous photovoltaic energy the next day.

Please note that any damage caused by incorrect operation is not covered by the equipment warranty.

5.4.4.2.1.1. Requirement of PV input

PV input requirement	
Max input voltage	1000V
Rated voltage	600V
Start voltage	180V
MPPT voltage range	150-950 V
Max input current	10*42A
Max short current	10-60A
MPPT number/Max input strings number	10/20

Please note that the maximum operating altitude is 4,000 meters. However, when the altitude exceeds 2000 meters, the maximum input photovoltaic voltage will decrease. The table below shows the relationship between altitude and voltage.

Altitude (m)	Voltage (Vdc)
2000	1000
2700	1000
3000	981
3500	925
4000	875

5.4.4.2.2. Connecting EverCore to the Power Grid

- About local grid connection with inverter. Please refer to Figure 5-18 for the wiring procedure:

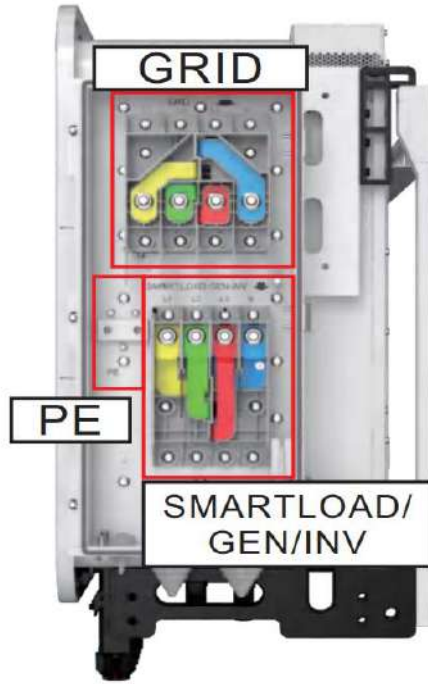

Figure 5-18 Connection for Power Grid

Position	Terminal 2	Terminal type	Recommended Specification	Position	Terminal 1	Terminal type	Remark
Grid	L1	Depends on the grid type of client side	95-120mm ²	Hybrid inverter GRID Port	L1	R-type terminal	Torque: 20-30N.m
	L2		95-120mm ²		L2	R-type terminal	Torque: 20-30N.m
	L3		95-120mm ²		L3	R-type terminal	Torque: 20-30N.m
	N		95-120mm ²		N	R-type terminal	Torque: 20-30N.m
	PE		50-75mm ²		PE	R-type terminal	Torque: 10-12N.m

- Detailed wiring steps are as follows

1. Detailed wiring steps are as follows:

2. Disconnect the AC circuit breaker to ensure it won't accidentally turn on.

3. Strip the insulation sheath from the end of the AC cable to a length B, where B (insulation

stripping length) is 2 mm – 3 mm longer than A (OT cable terminal crimping area). Place R-type terminals on both ends and perform a secure crimp connection. The crimped part of the terminals must be insulated with heat shrink tubing or insulating tape.

4. When connecting to the grid port and the SMARTLOAD/GEN/INV ports, remove the three screws on the cover of the inverter junction box, and then remove the junction box cover.

5. Select the matching diameter of the outlet sealing ring according to the diameter of the AC cable. Cut the diameter of the sealing ring to the appropriate size, pass the cable through the sealing ring, remove the nut at the corresponding position of the wiring box, and use a socket

6. wrench to connect the cable to the corresponding AC terminal block in sequence. The torque should follow the recommended torque in table.

7. To ensure the waterproof effect, the operator needs to regularly check if the sealing ring is damaged.

8. When the cable is coming out in right wiring box, there should be no openings or gaps between the tower protective sleeve and the cable.

9. After the AC cable are wired, the cables should be fixed, The installers should use the ribbon to secure the wire harnessed in the holes of the surrounding metal shells.

10. For detailed connection information, refer to the Solis hybrid inverter manual.

5.4.4.2.3. Connection between EverCore and User load

1. The power cable of the user load is connected to the backup port of the hybrid inverter. The connection should be carried out according to Figure 5-19. The following is the interface definition:

Position	Terminal 1	Terminal type	Recommended specification	Position	Terminal 2	Terminal type	Remark
Load side	L1	Depend s on load	Depends on the load	Hybrid	L1	Copper	L1
	L2			Inverter	L2	Tube	L2
	L3			Backup	L3	Terminal	L3
	N			Port	N	(SC Lug)	N

	PE				PE		PE
--	----	--	--	--	----	--	----



Figure 5-19 Backup Load Connection Position

5.4.4.2.4. Connection between Generator and EverCore

- The diesel generator is connected to the EverCore hybrid inverter. Please refer to Figure 5-20 for the connection procedure.

Position	Terminal 1	Terminal type	Recommended Specification	Position	Terminal 2	Terminal type	Remark
Generator	L1 phase	Depends on the generator	70-120mm ²	Hybrid GEN port	U	R-type terminal	Torque: 20-30 N.m
	L2 phase		70-120mm ²		V	R-type terminal	Torque: 20-30 N.m
	L3 phase		70-120mm ²		W	R-type terminal	Torque: 20-30 N.m
	Neutral		70-120mm ²		N	R-type terminal	Torque: 20-30 N.m
	PE		50-70mm ²		PE	R-type terminal	Torque: 10-12 N.m

the tower protective sleeve and the cable.

8. After the AC cable are wired, the cables should be fixed, The installers should use the ribbon to secure the wire harnessed in the holes of the surrounding metal shells.

9. For detailed connection information, refer to the Solis hybrid inverter manual.

5.4.4.2.5. Grounding Cable Connection with EverCore

As shown in Figure 5-21, EverCore has a grounding connection copper bar. The copper bar has a M8 hole and requires the user to connect a ground cable to the ground point at the site.

The recommended cable diameter is 25mm², Use M10*20 Three-piece Screw/Stainless Steel, Torque: :30N.

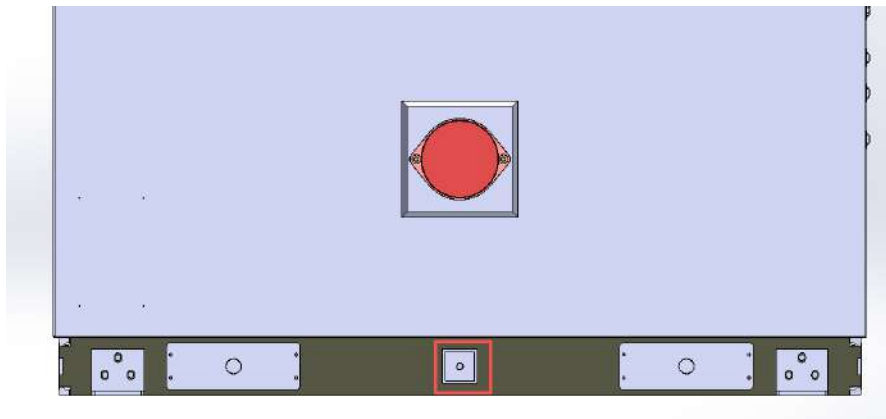

Figure 5-21 Grounding schematic diagram

5.4.4.2.6. Communication connection between Inverter and battery cabinet

The Battery cabinet communication with inverter Datalogger. Follow the connection method shown in Figure 5-22. The following is the interface definition.

Position	Terminal 1	Terminal type	Ethernet cable type	Position	Terminal 2	Terminal type	Remark
User device	EMU-LAN2	Pre-installed	RJ45	S2-WL-ST Data logger	RJ45	RJ45	Ethernet cable

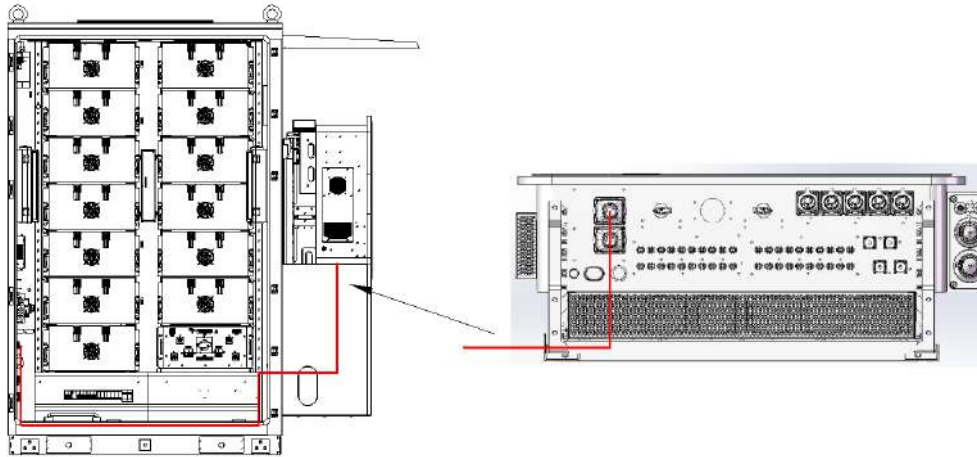

Figure 5-22 Communication Cable Schematic Diagram

The Battery cabinet EPO Signal connection with inverter EPO terminal. Follow the connection method shown in Figure 5-23. The following is the interface definition.

Position	Terminal 1	Terminal type	Ethernet cable type	Position	Terminal 2	Terminal type	Remark
User device	Emergency stop	Pre-installed	Spade Terinal	COM1	EPO	Cord-End Terminal	cable

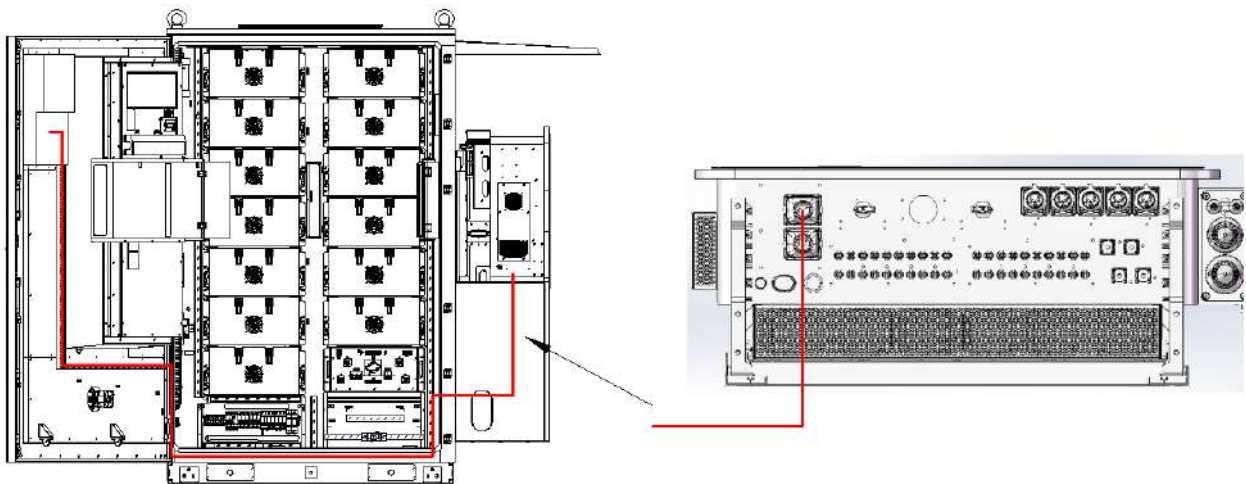

Figure 5-23 EPO Cable Schematic Diagram

5.4.4.2.7. CT Connection

⚠ DANGER

Make sure that the AC cable is completely disconnected from the AC power source before connecting

the current transformer (CT)

1) When installing the Inverter, the CT provided in the product box must be used. It can be used to detect the direction of the grid current and provide information about the system operation status to the hybrid inverter.

CT model: AKH-0.66-K-80*40-600A

CT Cable:Size – 00.8mm², Length – 5m, its extension not supported.

2) CT connection: On the inverter side, it is directly inserted through the quick-insert terminal; on the grid side, it is connected through the U-shaped terminal.

3) Solis marked the CT cable in 6 different colors. Lead the CT cables through the COM 1 port of the inverter bottom.

CT Wire	8 PIN Communication Terminal Block	Print name
Black	Pin 1 (Form left to right)	L1CT+
Purple	Pin 2 (Form left to right)	L1CT
Orange	Pin 3 (Form left to right)	L2CT+
Blue	Pin 4 (Form left to right)	L2CT
Yellow	Pin 5 (Form left to right)	L3CT+
Green	Pin 6 (Form left to right)	L3CT

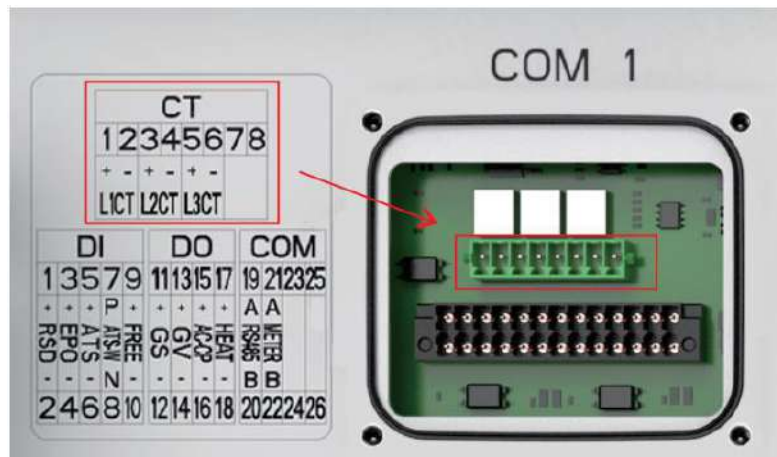
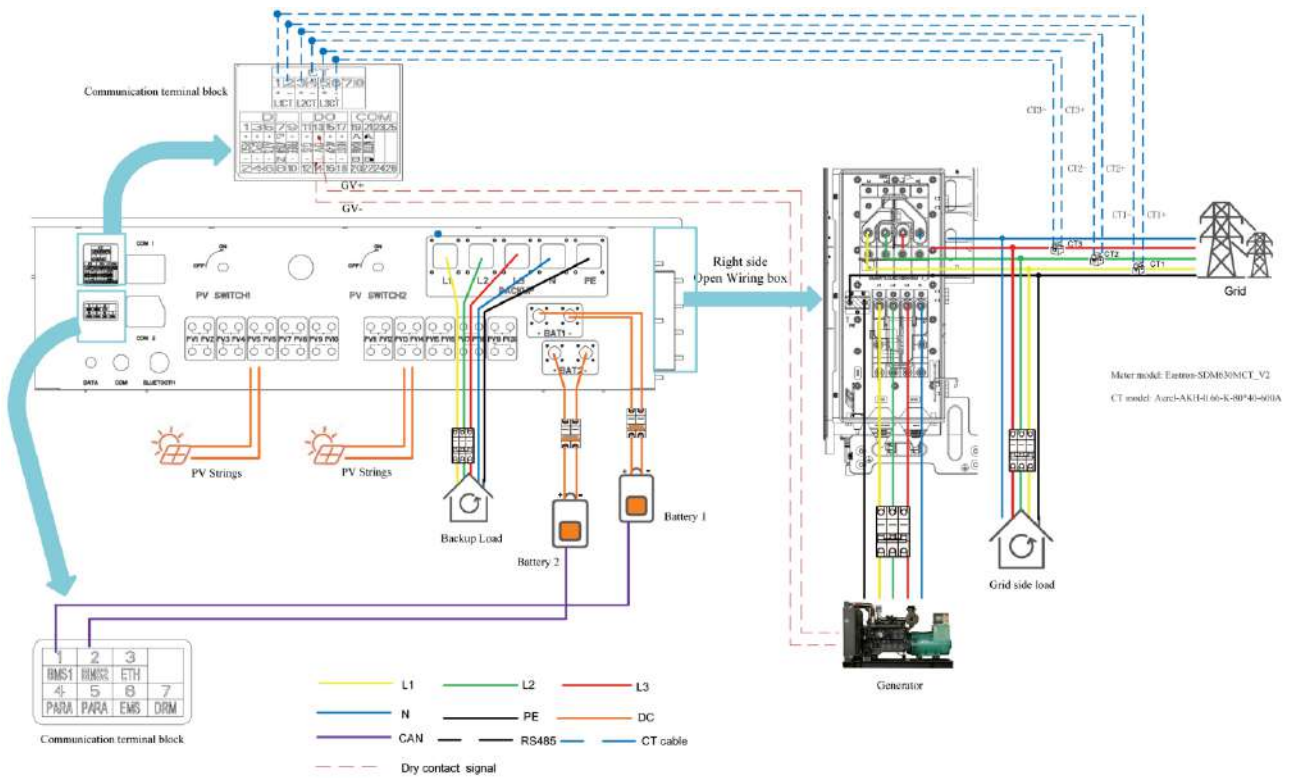

Figure 5-24 CT Cable Connection Terminal in Inverter

Note: Solis supply the 2 measurement methods, please choose one of the two options.

1. CT
2. CT + Smart Meter

5.4.4.2.8. Connection between Inverter and Smart Meter

The wiring principle between the smart meter and the CT is shown in the following diagram. It mainly consists of two parts:

One part is the wiring between the smart meter itself and the CT, and the other part is the wiring

between the smart meter and the hybrid inverter.

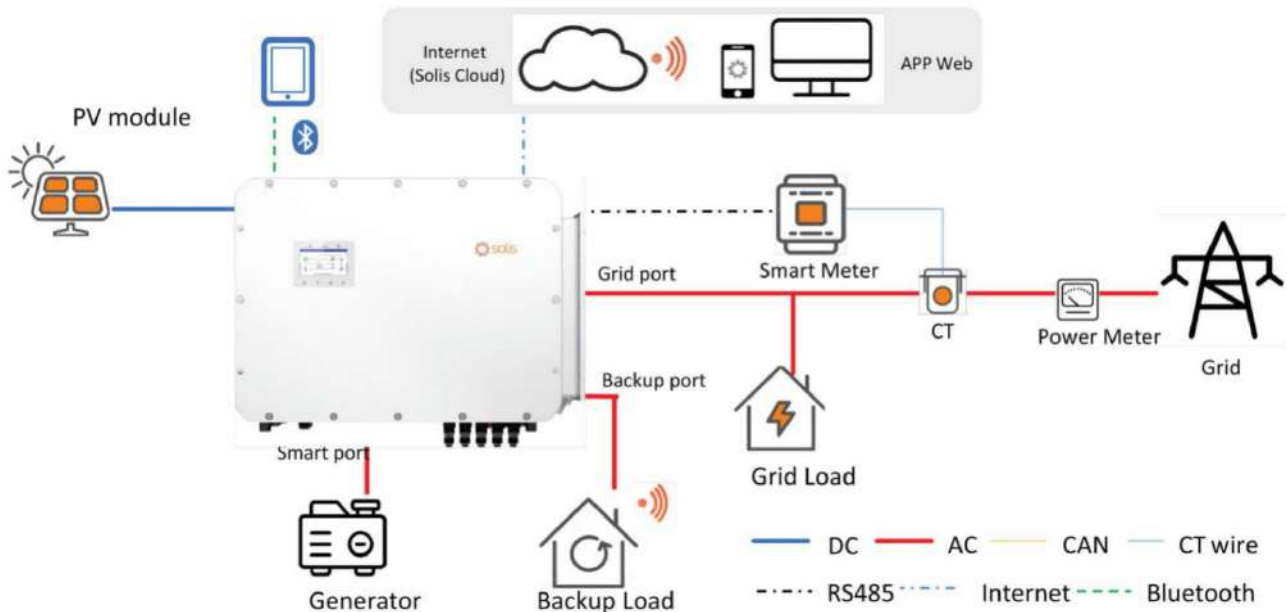

Figure 5-25 Meter & CT Connection Diagram

The connections related to the smart meter and CT are mainly divided into voltage input, current input, auxiliary power supply, communication lines, as shown in the following diagram:

1. The voltage measurement cable should be directly connected to the input port of the client's power grid, including L1, L2, L3 and the N line..
2. The current measurement should be detected by CT,CT device must be installed on each phase cable of the power grid. When connecting, be sure to pay attention to the polarity of the CT and ensure that the phase sequence of the CT connected to L1, L2, and L3 is correct; otherwise, it will affect the normal use of the product.

CT cable	Ports on meter
L1 CT cable(white)	20(S1 ₁)
L1 CT cable (black)	19(S2 ₁)
L2 CT cable (white)	18(S1 ₂)
L3 CT cable (black)	17(S2 ₂)
L4 CT cable (white)	16(S1 ₃)
L5 CT cable (black)	15(S2 ₃)

3. Auxiliary power supply: An external 220Vac power supply must be provided separately to power

the electricity meter. The power line needs to be connected to the LA (5) and NA(6) terminals of the smart meter.

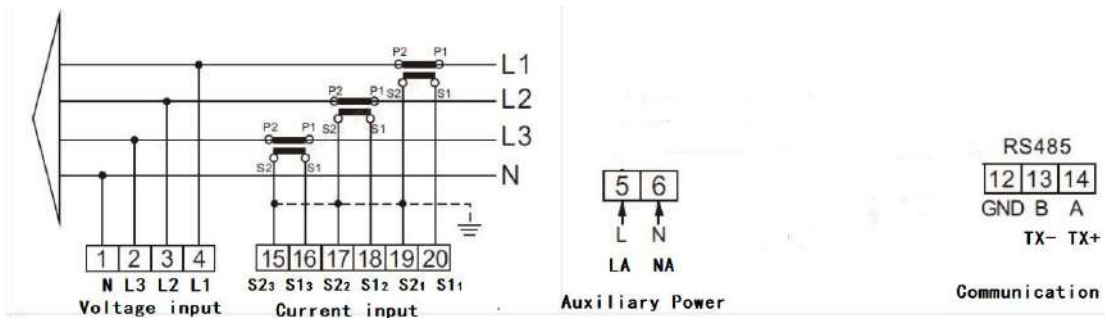

Figure 5-26 Meter Cable Connection

The wiring between the smart meter and the hybrid inverter consists only of the communication lines. The wiring method is as follows.

1. Pass the RS485 cable of the electricity meter through the COM1 port of the inverter bottom, and connect it to the smart meter terminals of the inverter wiring box using RJ45 connector.

RJ45 Connector Wire sequence definition:

Note:

Pin definition of the Meter Terminal is following EIA/TIA 568B.

RS485A on Pin 1: Orange/white

RS485B on Pin 2: Orange

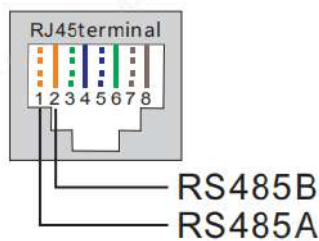

The correspondence between communication lines is as shown in the table below.

Hybrid inverter RJ45 Connector	Smart meter ports
RS485A on Pin 1: Orange/white	21(TX+/A)
RS485B on Pin 2: Orange	22(TX-/B)

Note: When using, the hybrid inverter can be connected to both the meter and the CT, or it can be connected only to the CT. Choose one of the two options.

Meter communication port in inverter wiring box

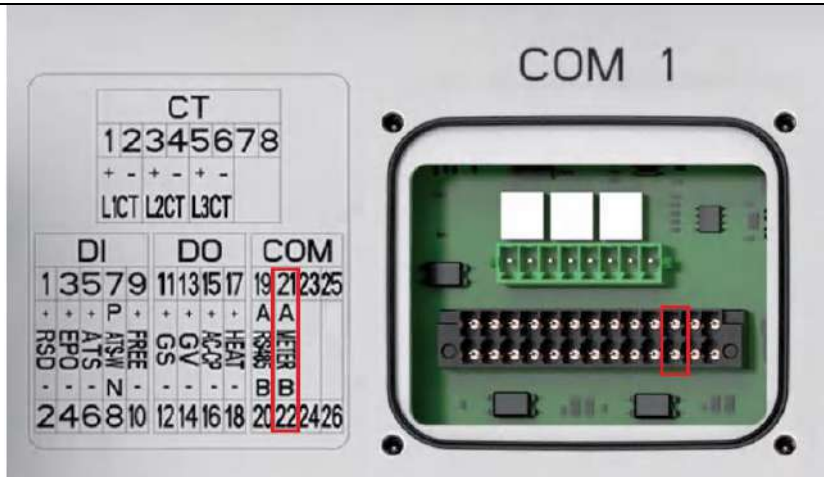

Figure 5-27 Meter Connection

5.4.4.2.9. 4G router installation and wiring (optional)

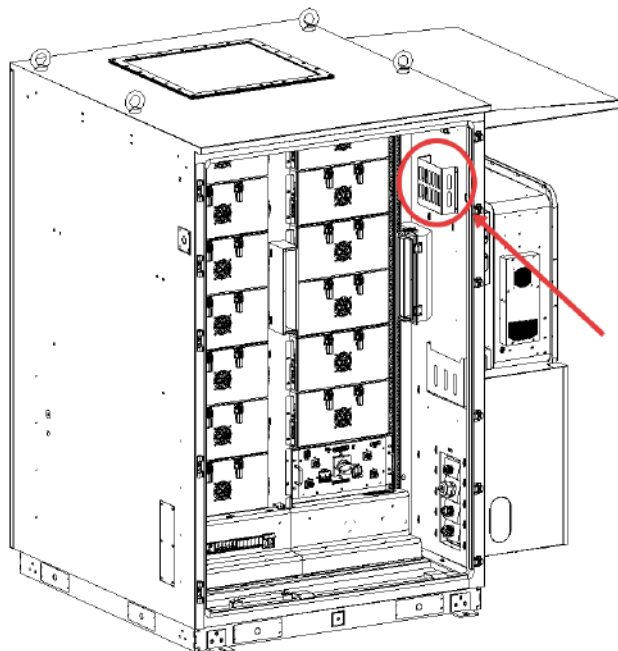

Figure 5-28 4G Router Installation Position(Without door)

1. As shown in the figure above, the 4G router is installed within the mounting frame indicated by the red circle, and its power supply and communication wiring are defined as follows:

Position	Terminal 1	Terminal type	Recommended Specification	Position	Terminal 2	Terminal type
4G router	V+	Depends on the actual site conditions	0.5mm ²	Distribution box	Available positions on the XT2 terminal block	Cord End Terminal
	V-		0.5mm ²	Distribution box		Cord End Terminal
	PE		0.5mm ²	Grounded nearby	PE earthing bar	Ring Terminal
	LAN	Crystal head	CAT5e	switch	RJ45	Crystal Head

2. Antenna direction:

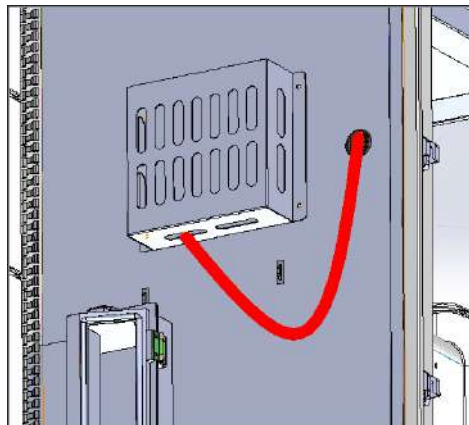

Figure 5-29 Antenna Installation Position

The antenna routing for the 4G router is as shown in the figure above.

5.4.4.3. Cat5e Cable crimping fabrication

RJ45 Connector Wire crimping instructions

- Tools and materials Preparation
1. Ethernet cable (Cat5e、 Cat6, etc)
 2. RJ45 connector
 3. Network cable pliers (with functions of cutting and stripping wires)
 4. Wire tester (used for testing connectivity)

5. Scissors or wire strippers

● Procedure:

1. Remove the outer sheath of the cable.

2. Use an Ethernet cable stripper or a stripping tool to remove about 2-3 centimeters of the outer sheath of the network cable, exposing the 8 inner wire cores.

3. be careful not to damage the inner wire cores.

4. Arrange the wire sequence:

- Arrange the 8 wire cores in a standard order:

- White orange, orange, white green, blue, white blue, green, white brown, brown

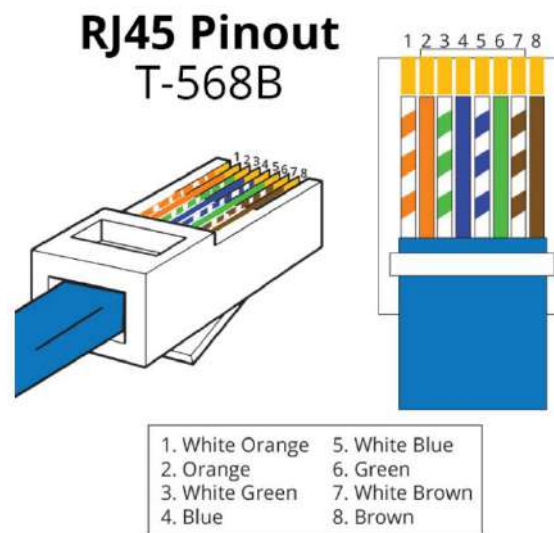

Figure 5-30 Ethernet Cable Wiring Sequence

After arranging them, use your fingers to straighten the wire cores, and then use scissors to trim the ends of the wire cores evenly.

5. Inserting the Connector

- Insert the neatly arranged wire cores into the RJ45 connector, making sure each wire core reaches the front end of the connector.

- Also, check if the outer skin of the network cable has entered the internal part of the connector to ensure a more secure connection after the crimping.

6. Crimping the Connector

- Place the connector into the crimping slot of the network cable pliers, and firmly press the handle

to ensure that the metal piece of the connector makes full contact with the wire cores.

- After the crimping is completed, check if the metal piece of the connector is flattened and pressed down properly.

5.4.4.4. External dry contact signal connection

The EverCore system provides a dry contact output for Fire Protection Linkage activation. Upon detecting fire protection linkage system activation, the system will enable the Fire Protection Linkage dry contact to transmit a signal to the client.

Table 5- External Dry Contact Interface

Position	Terminal	Definition of terminal	Connector type
EverCore	XT3:1	Fire Protection Linkage	Tubular terminal
XT3	XT3:2		Tubular terminal

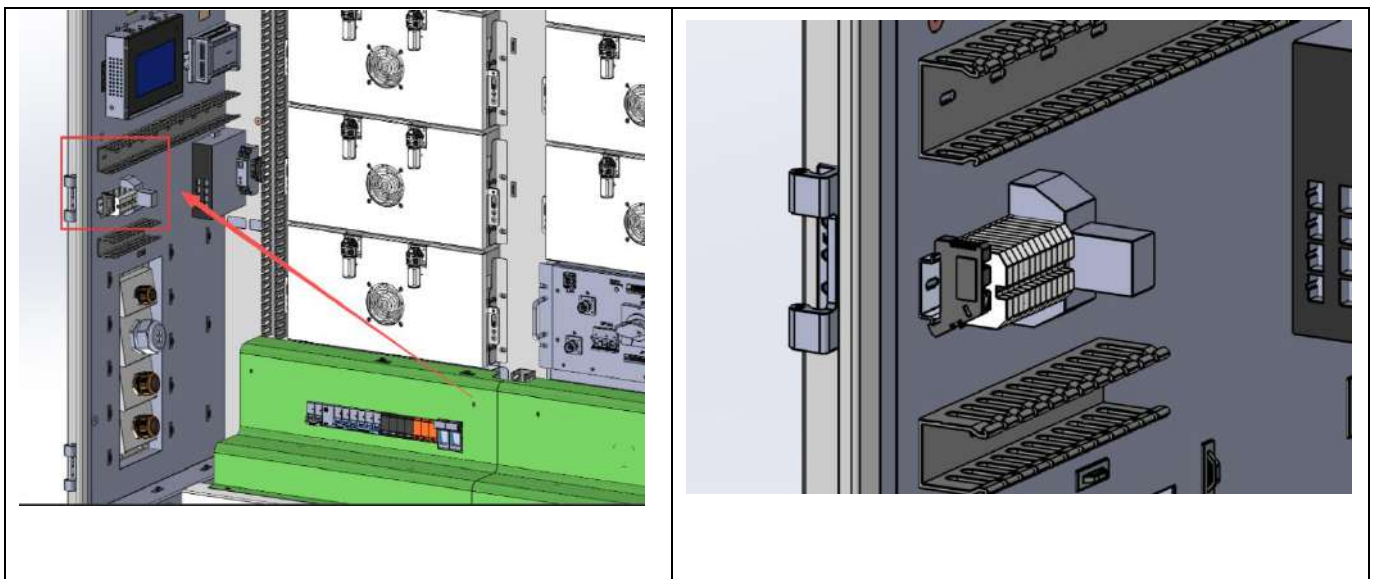

Figure 5-31 External Dry Contact Control

5.4.4.5. Side Cable Conduit Installation Instructions

As shown in the figure below, for each wiring hole, define the wiring according to it. Before wiring, use a knife to cut the protective coil into a cross shape, then pass the wire bundle through it, and finally seal it with fireproof mud.

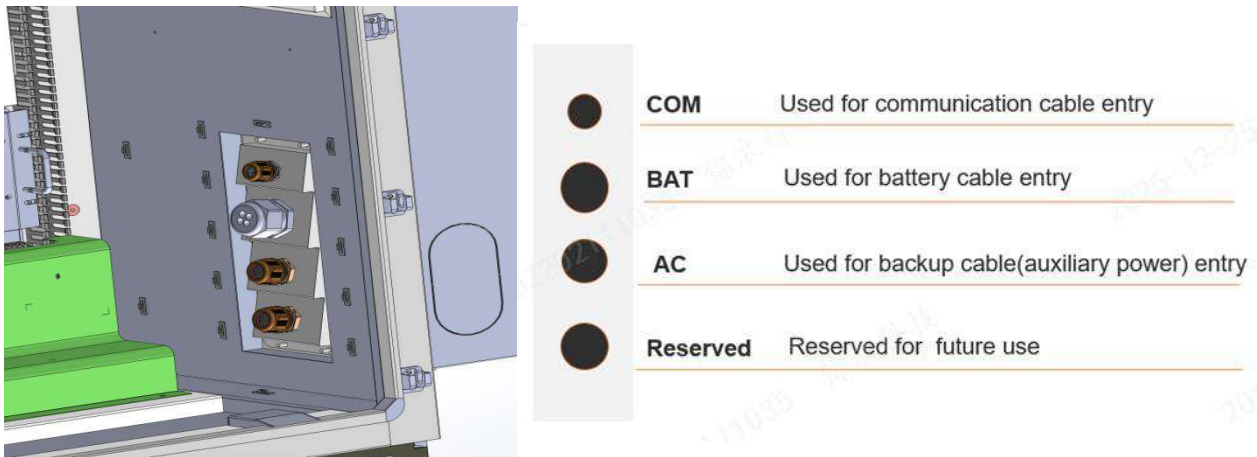

Figure 5-32 Bottom Wiring Hole of Cabinet

5.4.5. Inspection of Wiring Quality

1. Check whether the polarity of the DC cables is correct, whether the nuts are installed properly, and whether the cable labels are correct.
2. Check whether the phase sequence of the AC cables is correct, whether the connection terminals are fixed properly, and whether the cable labels are correct.
3. Check whether the insulation resistance of all equipment meets the requirements.
4. Check whether the positive and negative poles of EverCore are short-circuited, and whether the AC cable terminals L1, L2, L3, N, and PE are short-circuited.
5. Check whether the grounding conductance of the grounding wire is good.
6. Before powering on, check the connection cables of the entire system to ensure reliable cable connections, without aging, cracking, or insulation damage.
7. Check whether all communication cables and connection terminals are tightly and reliably connected;

5.5. Instructions for Using Aerosols

The aerosol is generally installed on the top of the cabinet. The aerosol is equipped with a temperature-starting detection line. The starting temperature of the detection line is approximately $170^{\circ}\text{C} \pm 5^{\circ}\text{C}$. When using it, the detection line should be kept as exposed as possible. In areas with high humidity, it is recommended to take moisture-proof measures at the end of the temperature-starting detection line

of the aerosol:

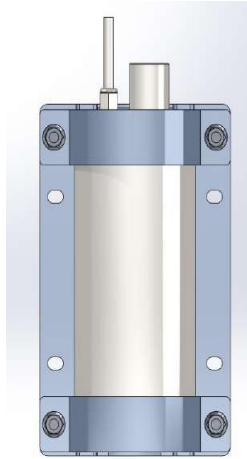

Figure 5-33 Aerosols Activated by Thermal Sensitive Wires

5.6. Installation Instructions for Fire Water Inlet Connector

1. A DN65 water pipe is reserved on the back of the cabinet, and a corresponding DN65 fire hydrant quick connector is also selected. Before use, the acrylic cover plate should be broken or removed first. There are two usage schemes for this water filling port:

(1) When configuring the DN65 fire hydrant quick connector, the DN65 quick-connect fire hose can be directly connected.

(2) When there is no DN65 fire hydrant quick connector (or when it is removed), the pre-action pipe network can be connected to this DN65 water pipe connector.

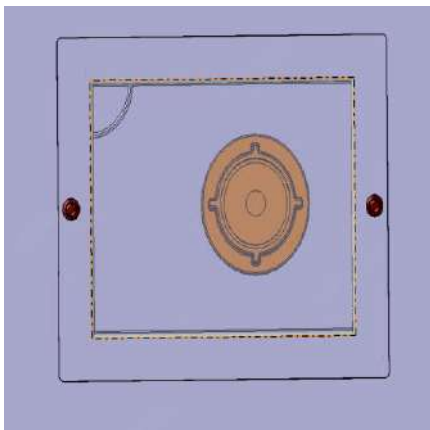

Figure 5-34

Water Injection Interface Location Diagram
(Back of the Cabinet)

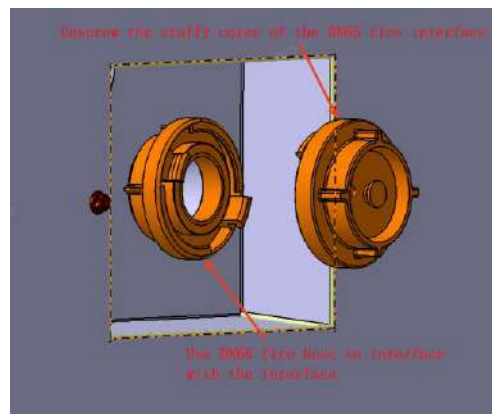

Figure 5-35

Disassembly Diagram of Fire Extinguisher
Water Injection Interface Scheme 1

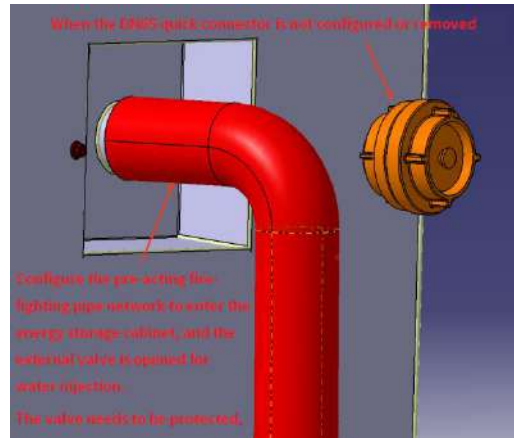

Figure 5-36 Disassembly Diagram of Fire Water Injection Interface Scheme 2

5.7. Battery pack wiring

The power cables of the battery compartment that have been removed need to be manually connected at the delivery site. The orange ones should be connected to the positive terminal (B+), and the black ones to the negative terminal (B-). The detailed operation steps are as follows:

1. Before installation, it should be confirmed that the pins of the power line connector are not skewed or broken, and should be inserted as vertically as possible.
2. Install the DC power line according to the color and refer to Figure 5-43. When connecting the wire harness, do not pull the wire harness forcefully.
3. After the connector is assembled in place, you should hear a click. Gently pull the connector by hand; it must not be loose.

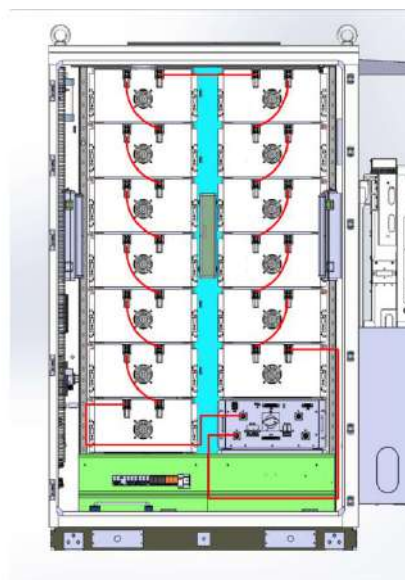

Figure 5-37 Diagram of Power Cables in the Battery Compartment

6. Operation of System

6.1. Requirements for Trial Operation

Before the trial run, please check the following items:

NO	Inspection items
1	Check if all cable connections are reliable.
2	Check if EverCore is well ventilated.
3	Check if EverCore is reliably grounded.
4	Test the AC input items of EverCore to ensure if they are correct.
5	Check if all switches of EverCore are in the off position.
6	Check if the High-Voltage Box isolating switch is in the off position.
7	Ensure that the grid voltage and frequency on the AC side are in accordance with the input requirements of EverCore.

6.2. System Power-on Operation Procedure

During the trial operation or after completing maintenance or repair, the system can be powered on only after all the aforementioned inspection and testing items have been carried out. The power-on process must be carried out strictly in accordance with the following steps.

WARNING

For systems with long downtime, a comprehensive and detailed inspection of all system lines is necessary. Only after ensuring that all indicators meet the requirements can the system be restarted.

6.3. System Power on Operation Instructions

The switches include:

- ① High-Voltage Box power supply switch “PDU”

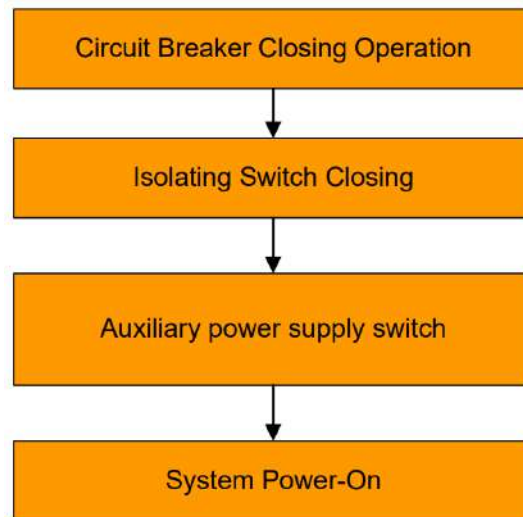

Figure 6-1 System Startup Flowchart

- ② Air conditioner power supply switch “AC”
- ③ High-Voltage Box DC power take-in switch “QF1-DC”
- ④ High-Voltage Box AC power take-in switch “QF2-AC”

6.3.1.High-Voltage Box Isolating Switch Closing Operation

Switch the isolating switch (QF-Battery Breaker) of the High-Voltage Box from the "OFF" position to the "ON" position.

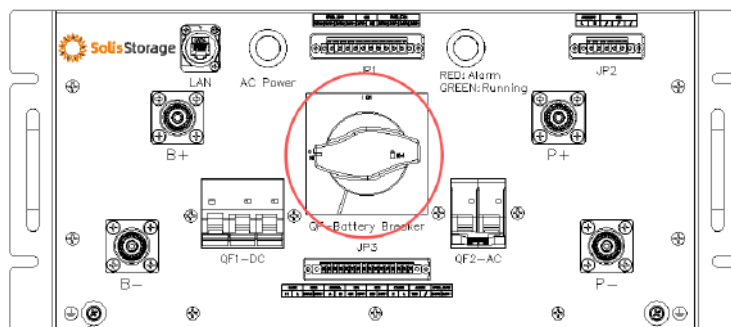

Figure 6-2 Schematic Diagram of the High-Voltage Box disconnect switch

6.3.2.High-Voltage Box Closing Operation

Step 1: Close the High-Voltage Box DC power take-in switch (“QF1-DC”)

“QF1-DC” is the High-Voltage Box DC power take-in switch. By manually operating and pushing the lever upwards, it can be switched from the "OFF" position to the "ON" position to perform the closing

operation.

Step 2: Close the High-Voltage Box AC power take-in switch (“QF2-AC”)

“QF2-AC” is the High-Voltage Box AC power take-in switch. By manually operating and pushing the lever upwards, it can be switched from the "OFF" position to the "ON" position to perform the closing operation.

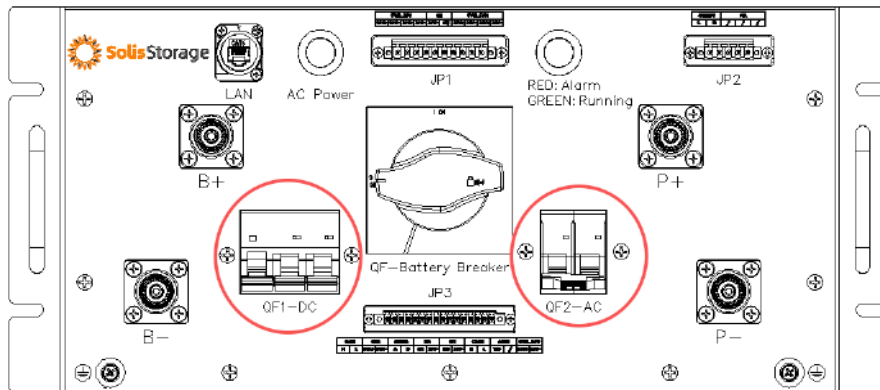

Figure 6-3 Switch “QF1-DC”、 “QF2-AC”

6.3.3. Closing of Switch

The closing operation of the switches follows these steps:

Step 1: Close the High-Voltage Box power supply switch (“PDU”)

“PDU” is the High-Voltage Box power supply switch. By manually operating and pushing the lever upwards, it can be switched from the "OFF" position to the "ON" position to perform the closing operation.

Step 2: Close the air conditioner power supply switch (“AC”)

“AC” is the air conditioner power supply switch. By manually operating and pushing the lever upwards, it can be switched from the "OFF" position to the "ON" position to perform the closing operation.

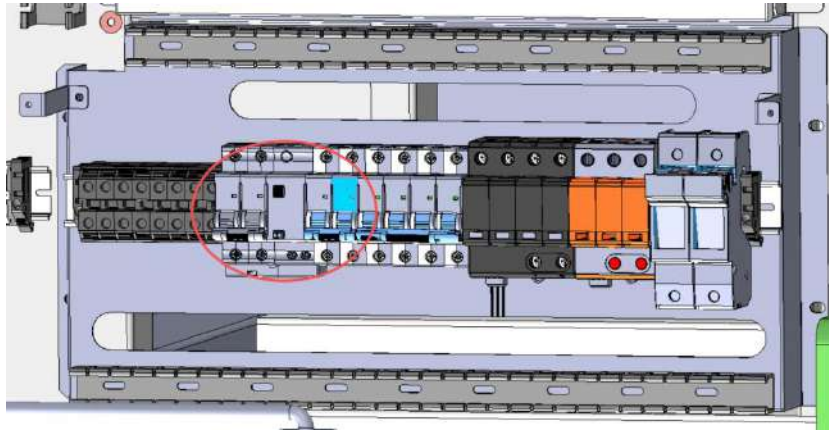

Figure 6-4 Switch “AC”、 “PDU”

6.3.4.High-Voltage Box Operation Indicator Light

After closing the “PDU”switch and “AC”switch, The "AC Power" indicator light (green) on the High-Voltage Box will illuminate, along with the status indicator light (red).

Once no other abnormalities are detected and a grid-connection command is received, the High-Voltage Box contactor will close, the status indicator light will turn green, and the system will begin operation.

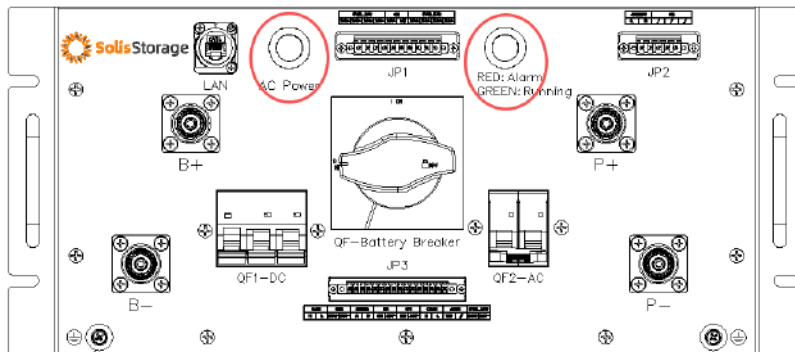

Figure 6-5 High-Voltage Box Operation Indicator Light

6.3.5.Indicator Light Status and Position

1. The "Run" indicator light is on (green): indicating the battery system is in charging/discharging mode;
2. The "Fault" indicator light is on (red): indicating a fault currently exists in the battery system;
3. The "Standby" indicator light is on (yellow): indicating the battery system is in standby mode.

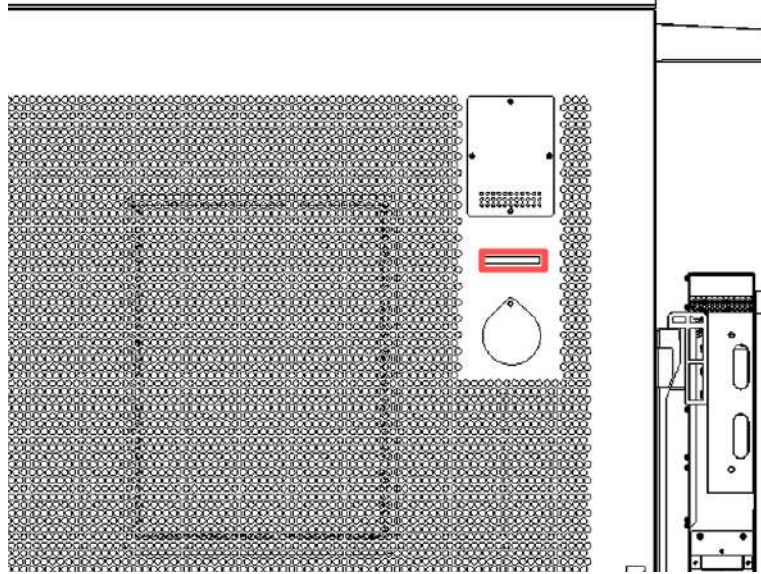

Figure 6-6 System operation. Indicator

NOTICE

After confirming that the working power indicator light and the working status indicator light on the front panel of the High-Voltage Box are both normal, you can proceed with the subsequent operations. Otherwise, you need to first troubleshoot the problem.

6.4. Quick setting on APP (SolisCloud)

You can download the app by scanning the QR Code or download it in the App Store in your region, the App version should be higher than V5.1.1



6.4.1. Log in the APP Via Bluetooth

Step 1: Turn on Bluetooth switch on your phone and then open the SolisCloud APP.

Click "Local Debugging"——> "Bluetooth Connection"

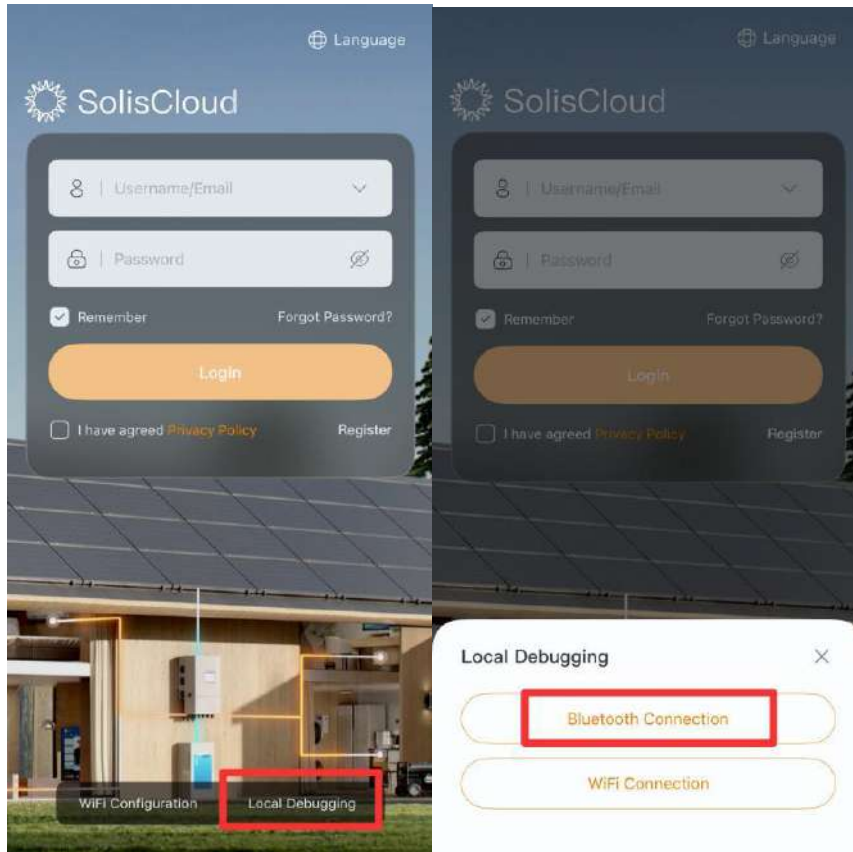

Step 2: Select the Bluetooth signal from the inverter. (Bluetooth Name: Inverter SN)

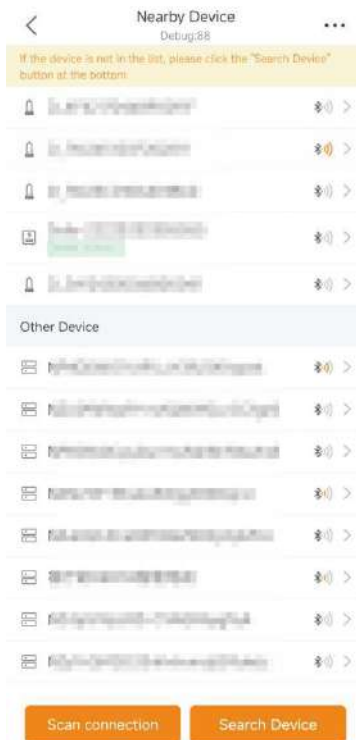

Step 3: Login account.

If you are the installer, please select the account type as Installer. If you are the plant owner, please select the account type as owner. Then set your own initial password for control verification. (The first time log-in operation must be finished by installer in order to do the initial setup)

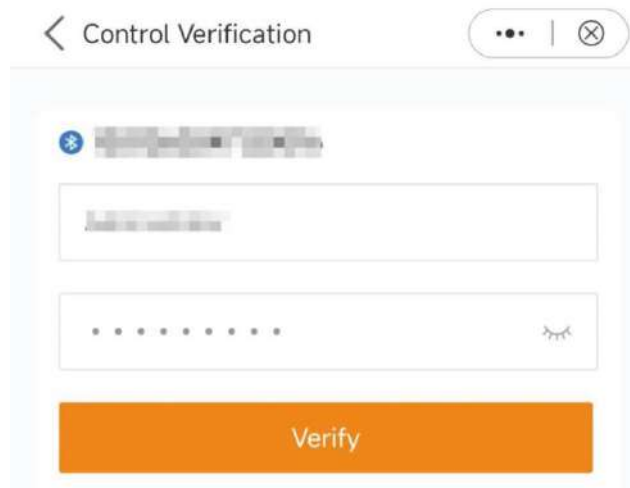

6.4.2.APP Quick Setting

If this is the first time the inverter has been commissioned, you will need to first go through the Quick Settings. Once this has been done, these settings can be changed later.

(1) Inverter Time:

Set inverter time and date, tap the slider next to "Follow Phone Time", then tap "Next step" at the bottom right corner.



(2) Battery:

- Select number of battery banks;
- Select battery model: **SolisStorage**
- Select battery cabinet quantity setting;

You can manually configure a dynamic or static IP address for the battery cabinet.

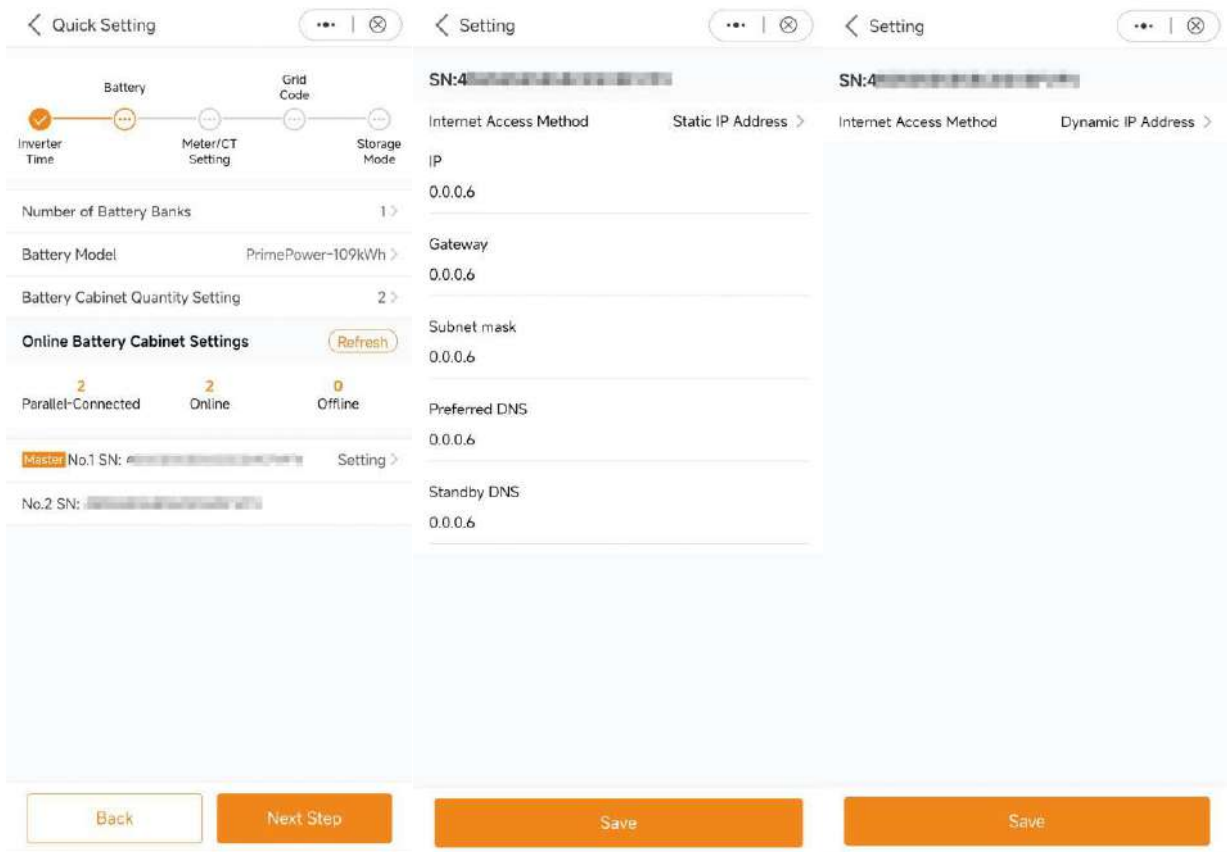

(3) CT/Meter setting:

- Select CT or Meter;
- Set Meter type (Solis provide Eastron 3 phase meter, it is self-identifiable).
- Set Meter installation location: Grid side / Load side / Grid+ PV inverter;
- Set CT ratio: default 60 (Solis provide ESCT-T50-300A/5A CT), if the user installs their own CT,

then need to set the CT ratio manually. If the system is connected to the Meter, then the CT ratio needs to be set on the Meter.

- CT direction: When CT is installed correctly, select "Forward"; when CT is installed in the wrong direction, the sampling current of CT will be reversed when calculating the power, select "Reversal" to correct it.

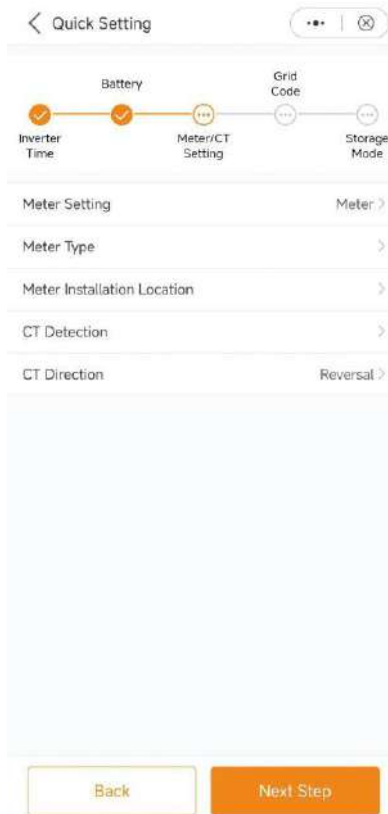

(4) Grid code:

Select grid code that meets the local regulations.

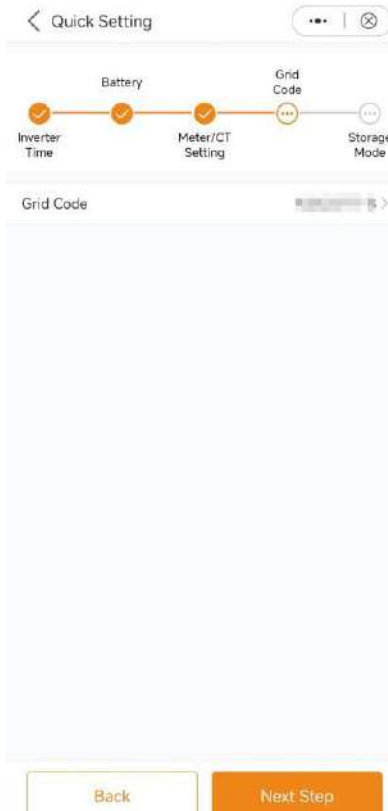

(5) Storage mode:

ALL modes first priority is to use the available PV power to support loads. The different modes determine what the second priority, or use of the excess PV power, will be. Self-use / Selling first / Off-grid are exclusive, the user can select only one mode.

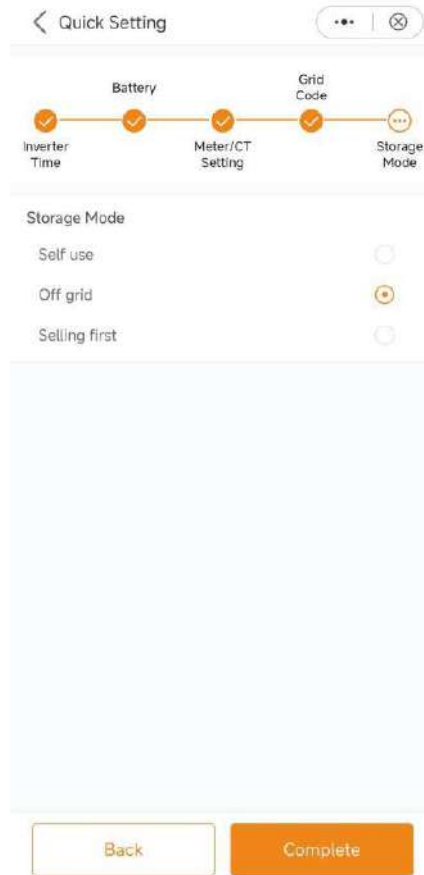

6.5. System Shutdown Procedure

When the system needs maintenance or repair, it must be powered off. The shutdown process must be carried out strictly in accordance with the following steps.

⚠ WARNING

After the system stops running, please wait for at least 10 minutes before conducting maintenance or repair operations on the system. After the system is shut down, when performing maintenance or repair operations on the system, be sure to:

Ensure that the system will not be accidentally re-powered.

Using a multimeter or an electric tester to check and ensure that the system is completely de-energized.

Cover the adjacent potentially electrified components with insulating materials.

During the entire maintenance and repair process, ensure that the escape routes are completely unobstructed.

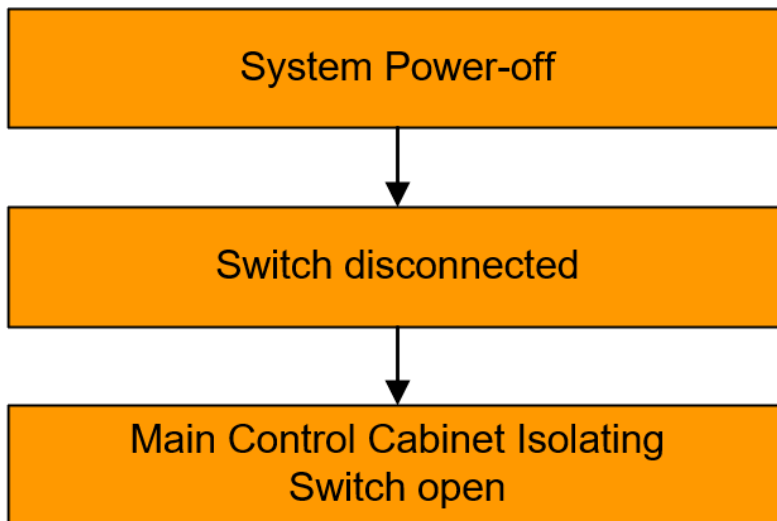

Figure 6-7 System Shutdown Procedure

6.6. System Shutdown Operation Instructions

6.6.1.High-Voltage Box Power-Down Procedure

Turn off the DC input circuit breaker (“QF1-DC”) and AC input circuit breaker (“QF2-AC”) of the high-voltage box by switching them from the ON position to the OFF position..

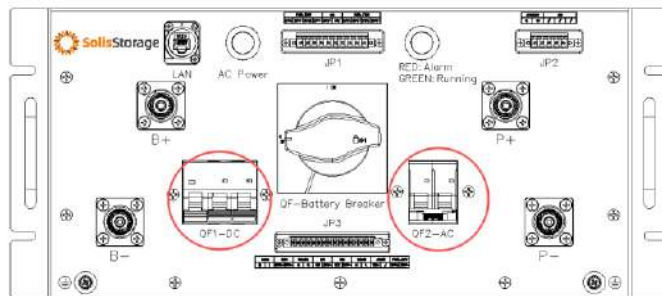

Figure 6-8 High-Voltage Box Power-Down Procedure

6.6.2.High-Voltage Box Isolating Switch Opening Operation

Switch the isolating switch (QF-Battery Breaker) of the high-voltage box from the "ON" position to the "OFF" position.

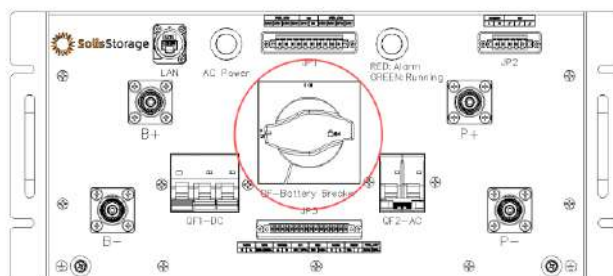

Figure 6-9 High-Voltage Box Open the Isolating Switch

6.6.3.Open Circuit

Step 1: Open the High-Voltage Box power supply switch (“PDU”)

“PDU” is the High-Voltage Box power supply switch. By manually operating and pulling the lever down, it can be switched from the "ON" position to the "OFF" position to perform the connection.

Step 2: Open the air conditioner power supply switch (“AC”)

“AC” is the air conditioner power supply switch. By manually operating and pulling the lever down, it can be switched from the "ON" position to the "OFF" position to perform the connection.

7. Product Maintenance

Due to the influence of environmental temperature, humidity, dust, vibration, etc., the internal components of the system or equipment will age or wear out, which may lead to potential faults within the system or equipment. Therefore, it is necessary to conduct daily and regular maintenance on the system to ensure its normal operation and service life.

7.1. Safety Precautions



- 1. Only qualified personnel with authorization can perform operations such as maintenance on the system.**
- 2. During the maintenance process, do not leave any metal parts such as screws, washers, and tools inside the equipment. Otherwise, it may damage the equipment.**
- 3. After the system stops running, still need to press the system emergency stop switch and the photovoltaic controller emergency stop switch. Then, it is necessary to wait for at least 10 minutes before conducting maintenance or repair operations on the system. After the system is shut down, when performing maintenance or repair operations on the system, pay attention to:**
 - Ensure that the system will not be accidentally re-powered.**
 - Use a multimeter or an electric tester to check and ensure that the system is completely de-energized.**
 - Cover the adjacent potentially electrified components with insulating material fabric.**
 - During the entire maintenance and repair process, ensure that the escape route is completely unobstructed.**

7.2. Maintenance Work and Cycle

During the daily operation of the equipment, the following matters should be noted:

(1) Regularly clean the EverCore system, especially pay attention to cleaning the air intake and outlet of the fan. If necessary, use a vacuum cleaner for cleaning to ensure that the air can flow freely within

the EverCore cabinet.

(2) Ensure that there are no any debris inside the EverCore system, and there are no debris around the system that hinders maintenance personnel from performing maintenance and repair on the system.

(3) Regularly check whether the cable connection terminals are loose, whether the surface of the terminals is severely rusted or oxidized, and whether the contact is good.

(4) Regularly check whether the emergency stop switch of the system is effective, to ensure that the system can be stopped quickly in emergency situations.

(5) Regularly check the fire extinguishing device configured for the system to ensure that its condition is good.

7.2.1.Product Maintenance Inspection

Throughout the entire product lifecycle, abnormal operations must be avoided. Regular equipment maintenance is mandatory to ensure safe and reliable operation and to achieve the best performance of the system. For detailed maintenance procedures, please refer to the Appendix: Product Maintenance Inspection Checklist.



Throughout the entire product lifecycle, the casing must not have any rusted or bent structures.

7.3. Requirements for Product Appearance Maintenance

Check EverCore once every twelve months and keep a record of the inspection. If there are any of the following damages on the paint surface of EverCore, please repaint according to the following steps:

Light scratches (on the unexposed steel substrate)

Irremovable stains or rust

Deep scratches (damage to the primer, exposure of the steel substrate)

Preparations

● In an outdoor environment without any coverings, re-coating under adverse weather conditions is strictly prohibited.

- Prepare the corresponding paint of the same color as the equipment surface.



- Conduct a visual inspection of the severity of paint damage on the equipment surface, prepare the corresponding tools and materials, and assess the quantity of on-site materials based on the re-coating situation.

- Prepared the paint that meets the requirements according to the paint surface color code RAL 9003 of the equipment.

- The exterior of the equipment should be intact. If the paint on the EverCore surface is damaged or cracked, re-coat immediately.

- Tools and materials: Hand spray paint or paint, brushes (for small area painting), fine sandpaper, isopropyl alcohol, cotton cloth, and spray gun.

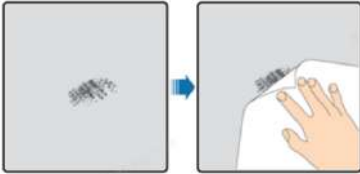
Maintenance steps

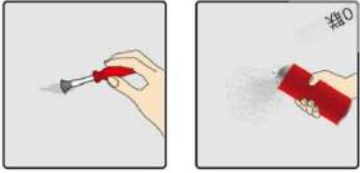
Steps	Operation method
1	<p>Gently sand the damaged area with fine sandpaper to remove dirt or rust.</p> 
2	<p>Moisten the cotton cloth with absolute ethanol, wipe the polished or repaired area to remove dirt and dust, and then dry it with a clean cotton cloth.</p> 
3	<p>Depending on the extent of the paint damage, use one of the following methods to evenly apply the paint onto the damaged coating until the damage is no longer visible:</p> <ol style="list-style-type: none"> 1. For minor scratches and small areas of stains, rust, it is recommended to use hand spray painting or brush painting. 2. For extensive scratches and large areas of stains and rust, use a spray gun for spraying. 
4	<p>Allow the paint to dry for 30 minutes, and then check whether the re-coated area meets the requirements.</p>

CAUTION

If the base of the area to be repaired is exposed, apply the primer first. After the primer dries, apply the intermediate layer paint and the polyurethane topcoat after the base is no longer exposed. Use the corresponding color of primer or polyurethane topcoat.

Please note that the paint film should be as thin and uniform as possible. The paint film should not be in droplet form and the surface should be smooth.

If there are different colors on the box pattern, cover the parts of other colors (except for the damaged paint) with tape and white paper before painting to avoid contaminating other colored parts during the paint repair process.

The paint patch area should be consistent in color with the surrounding area, without obvious boundaries, obvious protrusions, damage marks and paint peeling. If the user wants to spray paint, it is recommended to spray three times first, and then check if it meets the requirements. If not, repeat the above operation until the requirements are met.

7.4. Battery system maintenance requirements

7.4.1. Battery System Maintenance and Calibration

The battery of the system will be maintained once every twelve months according to the following plan to prevent battery damage.

1) Scheme 1 (This scheme is applicable when the SOC of the battery system is low)

- Discharge the battery system to the cut-off state (minimum voltage > 2.7V), then stop discharging and let it stand for 1 hour.

- The battery system automatically charges to full (maximum voltage < 3.65V), then let it stand for 1 hour after charging.

- Discharge the battery system to 30% and stop.

2) Scheme 2 (This scheme is applicable when the SOC of the battery system is high)

- Charge the battery system automatically (maximum voltage < 3.65V), let it stand for 1 hour after charging.

- Discharge the battery system to the cut-off state (minimum voltage > 2.7V), then stop discharging

and let it stand for 1 hour.

- Charge the battery system to 30% and stop.

CAUTION

1. Before performing maintenance operations, conduct checks to ensure environmental safety, system security, no alarms, and no faults.
2. After battery maintenance is completed, it is recommended to notify the SOLIS after-sales engineers to conduct free data analysis.

7.4.2. Instructions for Replacement and Safe Handling of Damaged Packs

This procedure defines the requirements for identifying, reporting, isolating, replacing, storing, and disposing of damaged or faulty battery Packs to ensure safety and compliance.

7.4.2.1. Identification and Reporting

- Identification: Technical personnel shall identify faulty Packs via BMS alerts (e.g., cell imbalance, overtemperature) or visual inspection (e.g., leakage, swelling, or odor).

- Reporting: Immediately record the Serial Number (S/N) and fault code of the damaged Pack. Report the incident to the site supervisor and log it in the maintenance records.

7.4.2.2. Safety and Isolation

- Electrical Isolation: Disconnect the DC/AC breakers and Ensure the system is physically locked and tagged to prevent accidental re-energization..

- Area Isolation: Establish a 3-meter safety exclusion zone around the cabinet. Ensure a Class D or Lithium-specific fire extinguisher is available on-site.

- PPE: Operators must wear insulated gloves, safety goggles, and arc-flash protective clothing.

7.4.2.3. Pack Replacement Procedure

Note: Follow these steps precisely to ensure mechanical and electrical integrity.

1. Remove the high and low voltage wiring harness of the pack.
2. Remove the fixing bolts and washers on both sides in front of the pack.
3. Pull it out of the slide rail.
4. Replace the pack.
5. Install it back into the slide rail.

6. Re-fix the fixing bolts and washers on both sides in front of the electrical box.

7. Restore the cables and connectors.

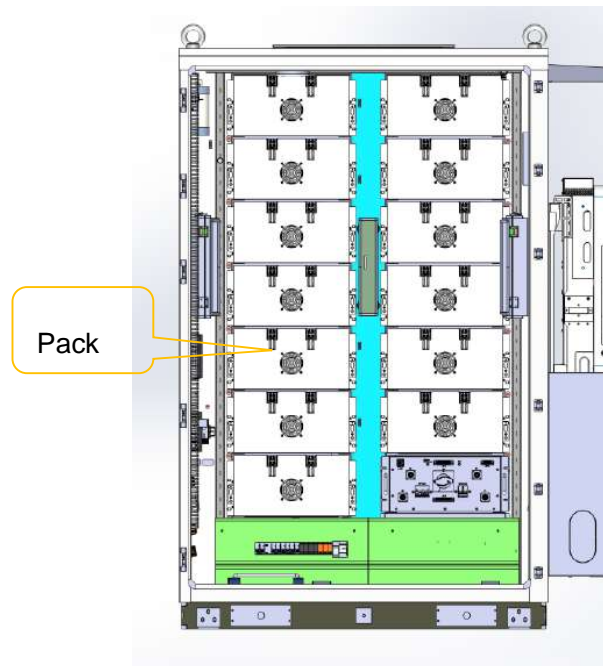

Figure 7-1 Pack Position

7.4.2.4. Storage of Damaged Pack

Damaged modules must be stored under strict conditions until they are removed from the site:

- Certified Container: Place the damaged Pack in a fire-rated storage box.
- Filling Material: Surround the module with non-combustible, absorbent material such as vermiculite or fire-resistant pillows.
- Location: Store the container in a well-ventilated, dry area, maintaining a minimum safety clearance of 5 meters from flammable materials or buildings.
- Labeling: Affix a clear "Damaged/Defective Lithium Battery" warning label on the exterior of the container.

7.4.2.5. Safe Disposal

- Authorized Disposal: Damaged batteries must NOT be disposed of as general waste. They must be handed over to a licensed hazardous waste contractor.

7.5. Requirements for Thermal Management System Maintenance

7.5.1. Requirements for Maintenance of Air-Cooled Air Conditioner

When the air conditioner unit is in operation, it is strictly prohibited for personnel to touch the internal circulation side of the unit;

Non-professionals are strictly forbidden to disassemble it;

Heavy objects are strictly prohibited from pressing on the air conditioner unit;

Every six months, check whether there is any dust or foreign matter blocking the air intake and outlet of the air conditioner unit. If any abnormalities are found, use compressed air or a vacuum cleaner with a brush head to clean the air intake and outlet of the air conditioner unit. Do not use hot water or organic solvents such as gasoline for cleaning.

7.6. Fire Protection System Maintenance Management

The reliability of the fire protection system is of vital importance for ensuring the safety of personnel and property. To ensure that the system can function effectively in case of fire or emergency, the users of the EverCore system should conduct professional inspections, tests and maintenance of each subsystem of the product on a regular basis. These operations not only help to ensure that the system is in the best working condition, but also help to avoid potential failures.

The detectors of this product's fire protection system do not require any specific maintenance (except for gas detectors), but if the equipment is damaged, replacement should be carried out according to the following procedures.

7.6.1. Replace smoke detectors and temperature detectors

1. Cut off the power distribution circuit of the system.
2. Rotate the thermal sensor detector counterclockwise to remove it from the base.
3. Install the new thermal sensor detector on the base and rotate it clockwise until you hear a "click" sound, indicating that it is securely fastened.
4. After the replacement is completed, restore the power distribution circuit of the system.



Figure 7-2 smoke sensor



Figure 7-3 temperature sensor

7.6.2.Replacement of the Flammable Gas Detector

1. Cut off the power distribution circuit of the system.
2. Loosen the two nuts that fix the base and remove the combustible gas detector.
3. Use two nuts to fix the new gas detector and its base in their original positions.
4. Rotate the cap of the gas detector head, lock the detector head, and then complete the wiring between the gas detector head and the gas processing module according to the wiring diagram, as shown in the following figure.

After the wiring is completed, restore the power distribution circuit of the system.



Figure 7-4 Flammable Gas Detector Wiring Diagram

7.6.3.Replacement of Audible and visual alarm

1. Cut off the power distribution circuit of the system.
2. Remove the front cover of the Audible and Visual Alarm, and disconnect the wires on the base.
3. Complete the wiring of the new Audible and visual alarm according to the wiring diagram and install it in place.
4. After the replacement is completed, restore the power distribution circuit of the system.

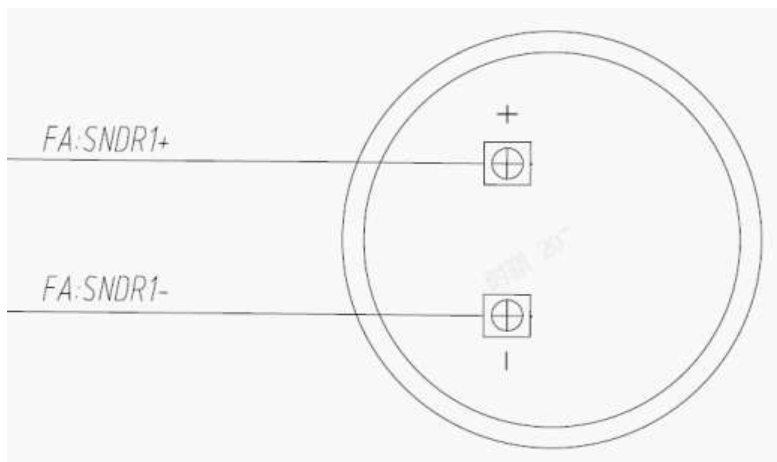

Figure 7-5 Wiring Diagram of Audible and visual alarm Device

7.6.4.Replacement of Aerosol device

1. Cut off the power distribution circuit of the system.
2. Adjust the temperature activation line on the aerosol.
3. Use a socket wrench to loosen and remove the fixing nut on the aerosol fire extinguishing device.
4. Then remove the aerosol and reinstall the new aerosol fire extinguishing device.
6. Fix it again with nuts.
7. After the replacement is completed, restore the power distribution circuit of the system.

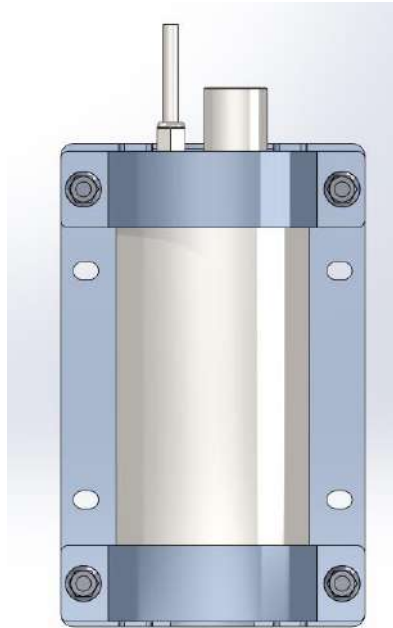

Figure 7-6 Aerosol

7.6.5. Post-Aerosol Spraying Precautions

1. There may be flammable gasses in the EverCore, which could cause re-ignition or explosion. Do not carry any open flames, heat sources or lit cigarettes when entering the dangerous area.
2. There may be toxic gasses in the EverCore, which could pose risks to the safety and health of the workers. Before entering the dangerous area, ensure proper personal protection.
3. After the aerosol is sprayed for fire extinguishing, professional firefighters must assess the safety risks inside the EverCore and only open the cabinet door after confirming there are no dangers.
4. The workers involved in the on-site fire accident response must wear personal protective equipment that complies with Directive 89/656/EEC requirements to avoid contact with unnecessary toxic substances and fire extinguishing agents.
5. If there are small amounts of residual aerosol fire extinguishing agents that remain during the ventilation period, thorough suction and scrubbing must be carried out as soon as possible.
6. The aerosol fire extinguishing agents may accumulate near the equipment or surfaces of the aerosol fire extinguishing device after being sprayed. Timely inspection and thorough suction and scrubbing must be carried out to ensure no fire extinguishing agents are accumulated.

7. For a period of time after spraying, the used aerosol fire extinguishing device may still have a relatively high temperature. Do not touch it. When removing the aerosol fire extinguishing device, wear appropriate protective gloves and follow the operation procedures for removal.

8. If the air humidity is high, perform dehumidification treatment after ventilating the dangerous area. Unremoved residual fire extinguishing agent residues will absorb moisture and may cause corrosion of metal and electronic equipment.

9. Dispose of the used aerosol fire extinguishing device in accordance with the requirements of your local area.

10. If you need to re-calibrate the aerosol fire extinguishing system or replace the aerosol fire extinguishing device, contact SOLIS for handling.

11. Gently press the circuit board with non-abrasive fabric and absorb the remaining liquid.

12. Do not use fabric to wipe the circuit board to avoid scratching components or causing components to fall off.

13. Do not use any paper products as they may leave paper fibers that could scratch the circuit board.

14. Use a toothbrush to remove the remaining particles, including the residual liquid after drying.

15. Use compressed air to blow away dust and residual liquid residues. Ensure to spray in a rapid and short-duration direction.

7.7. Electrical System Maintenance & Management

7.7.1.High-Voltage Box

The reference steps for maintenance and replacement of the High-Voltage Box are as follows:

- (1) Unplug the connection cables of the High-Voltage Box
- (2) Remove the fixing bolts and washers around the High-Voltage Box
- (3) Replace the High-Voltage Box
- (4) Reinstall the fixing bolts and washers around the High-Voltage Box
- (5) Restore the connection cables

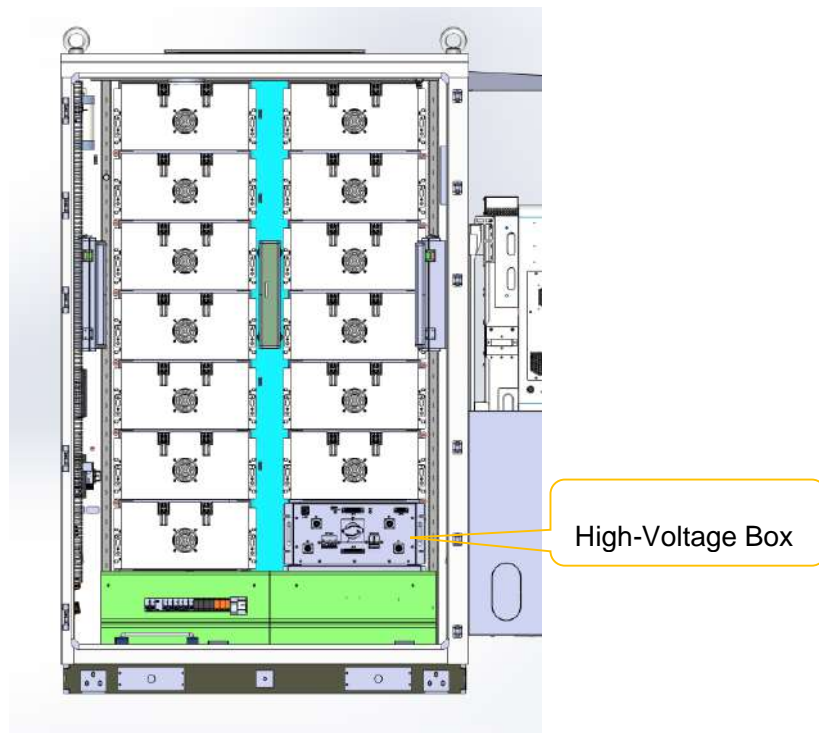

Figure 7-7 High-Voltage Box position

8. Trouble Shooting

⚠ WARNING

After the system stops running, please wait for at least 10 minutes before conducting maintenance or repair operations on the system. After the system is shut down, when performing maintenance or repair operations on the system, please note:

Ensure that the system will not be accidentally re-powered.

Use a multimeter or an electric tester to check and ensure that the system is completely de-energized.

Cover the adjacent potentially electrified components with insulating materials.

During the entire maintenance and repair process, ensure that the escape route is completely unobstructed.

8.1. Battery System Failures Trouble shooting

8.1.1. Fault, Alarm Handling and Countermeasures

If there is an alarm message displayed in the "System Alarm Information" tab, or if the battery system malfunctions, please follow the corresponding handling procedures as described in the table below. If the problem still cannot be resolved, please contact SolisStorage

Table 8-1 Explanation of Common Fault Information

NO	Fault or alarm phenomenon	Possible causes	Solution
1	The low voltage indicator light of the High-Voltage Box is not illuminated.	<ol style="list-style-type: none"> 1. not good contact of wiring cable 2. BCU malfunction 3. indicator light failure 	<ol style="list-style-type: none"> 1. Inspect the indicator light wiring 2. Replace the BCU 3. Replace the indicator light
2	The high-voltage indicator light of the High-Voltage Box is not illuminated.	<ol style="list-style-type: none"> 1. high-voltage relay damaged 2. BCU fault 3. indicator light failed 	<ol style="list-style-type: none"> 1. replace the relay 2. replace the BCU 3. replace the indicator light
3	The pre-charging relay cannot close.	<ol style="list-style-type: none"> 1. The main positive relay wiring is not properly connected. 2. failure of pre-charging relay 3. BMU malfunction 	<ol style="list-style-type: none"> 1. inspect the wiring connections. 2. replace the pre-charging relay. 3. replace the BMU.

4	The main relay cannot be closed.	1. the main positive relay wiring is not properly connected. 2. The relay is damaged. 3. The BMU malfunctioned.	1. inspect the wiring connections. 2. replace the pre-charging relay. 3. replace the BMU.
5	The main contactor cannot close.	1. the main positive relay wiring is not properly connected. 2. the relay is damaged. 3. the BMU malfunctioned.	1. inspect the wiring connections. 2. replace the pre-charging relay. 3. replace the BMU.
6	Main positive relay report Sticking	The main positive relay is damaged.	replace main positive relay
7	Main negative relay report Sticking	The main negative relay is damaged.	replace main negative relay
8	CSC shutdown	the wake-up signal cable is lost or has bad connection.	check wake-up signal
9	Abnormal alarm for cell voltage sampling	1.bad connection of the voltage detection cable 2. CSC failure.	1.check cable connection 2.replace CSC
10	Abnormal alarm for cell temperature sampling	1.the temperature sampling line is not properly connected. 2. the temperature sensor failure. 3.the CSC failure	1.check cable connection. 2.replace temperature sensor 3.replace CSC
11	Abnormal alarm Battery pack voltage sampling	1.voltage detection cable connection is not tight 2. BMU fault	1.check cable connection. 2.replace CSC
12	Internal communication failure alarm	internal can cable connection not good	unplug can cable and check it
13	Temperature extremes	cell temperature higher than normal working temperature range	stop charging and discharging
14	Voltage extremes	cell voltage higher than normal working range	stop charging and discharging
15	BMU shutdown automatically	1. MBMU wake up signal cable connection not good	1.check the cable connection 2, replace BMU

		2. MBMU wake up signal output not good	
16	Cell over-voltage alarm	1.balanced performance bad 2.system over charging	1.stop charging and conduct balance function in standby state 2.stop charging
17	Cell under-voltage alarm	1. balanced performance bad 2. system over discharging	1. stop discharging and conduct balance function in standby state 2. stop discharging
18	Cell over-temperature alarm	1.single cell temperature is too high 2.charging/discharging current is too large	1.check whether the cooling function of the cooler is operating 2.reduce the charging and discharging current appropriately
19	Cell under-temperature alarm	1.single cell temperature is too low 2.environment temperature is too low	1.check whether the heating function of the cooler is running 2.stop charging
20	Battery pack over voltage alarm	system over charging	stop charging
21	Battery pack under voltage alarm	system over discharging	stop discharging
22	Battery pack over temperature alarm	1.battery pack temperature is too high 2.Temperature sensor failure	1. check whether the cooling function of the cooler is operating 2. replace the temperature sensor
23	Battery pack under temperature alarm	1.battery bracket low temperature 2.environmental temperature is too low	1.check whether the heating function of the cooler is running 2.stop charging
24	Charging over current alarm	The system charging current is too large	decrease the charging current
25	Discharging over current alarm	The system discharging current is too large	Decrease the load power
26	High SOC alarm	system already charging fully (over charging)	stop charging system
27	Low SOC alarm	system has been discharged and emptied (over discharging)	stop discharging system
28	Cells excessive temperature difference alarm	1、 cabinet dissipation not uniformity 2、 temperature sensor failure	1.check whether the cooler is turned on 2.replace the temperature sensor

29	Alarm for excessive cell voltage difference	the SOC difference of battery cell is too large	charge the battery system to over 80% SOC to achieve standby balancing
30	Air conditioner is not running and there is no display	1.no power supply 2, a lightning strike caused the fuse to burn out	1. check if there is electricity at the power input terminal of the air conditioner 2. check if the fuse of the air conditioner has blown. If it has, replace the fuse
31	Air conditioner compressor failure	1. the condenser is clogged or scaled; 2. the significant impact received by the machine body during rough handling 3. the AC power supply voltage is either too low or too high.	1. clean the condenser heat exchanger regularly; 2. transport as vertically as possible and handle with care. 3. add a voltage stabilizing device.
32	Smoke sensor fault	1. smoke sensor bad contact 2. smoke sensor failure	1. check the connection cable 2. replace the smoke sensors
33	Temperature sensor fault	1.temperature sensor bad contact 2.temperature sensor failure	1.check the connection cable 2.replace the temperature sensors

8.1.2.Battery System Fault Diagnosis and Elimination Procedure

(1) Shut down and temporarily stop this unit from operating.

(2) Status recording: Record the phenomena at the time of the failure immediately, try to keep it complete, such as taking photos, making videos, taking screenshots of the screen, and saving the corresponding data.

(3) Fault type identification: Refer to the following fault information description table, preliminarily determine the fault type, and send the records and confirmation results together to the supplier or technical support engineer. The user's feedback information is extremely important for the maintenance work.

(4) Notify the technical engineer and follow his guidance, combine the diagnostic methods provided in the table above, conduct a preliminary diagnosis, and further confirm the specific type of the fault.

(5) After confirming the specific fault type, contact the engineer to solve the problem on-site immediately.

(6) Fault record: After the failure is resolved, fill in the daily operation fault record form to facilitate retrospect.

8.1.3. Handling of Abnormalities and Accidents

In case of abnormalities or accidents in the battery system, appropriate and effective handling measures should be taken promptly to eliminate further damage and losses:

Overheating:

Under normal circumstances, when the battery in the system overheats, the cooling system of the battery system will automatically operate to dissipate heat and cool the system to the optimal working temperature range. If the battery system fails to reach the target temperature within the specified time or the temperature exceeds the safe usage limit, the management system will issue a warning and require immediate cessation of use. In this case, the battery should be immediately stopped and the relevant technicians should be notified for a comprehensive inspection to eliminate the fault before it can be used again.

Leakage:

During use, if leakage is detected in the battery system, personnel in the energy storage room must be evacuated immediately, and relevant technicians must be notified to handle the situation on site. The system can be used again only after the fault is eliminated. It is strictly prohibited to operate the battery with faults or continue to use it forcefully.

Over-discharge:

When the battery system is completely discharged, the overall voltage is too low or the voltage of some individual batteries is lower than their normal working voltage range. The management system will issue a warning and require immediate cessation of use of the battery and charging. At this time, the discharge of the battery should be immediately stopped, and charging should be started for the battery. It is strictly prohibited to forcibly continue discharging the battery at this time, as it will damage the battery's performance and, in severe cases, may cause the battery to be permanently damaged and unable to be used.

Short Circuit:

Battery system short circuits caused by various reasons must be immediately evacuated the personnel in the energy storage room, the relevant power sources and electrical equipment must be cut off (if possible), the battery and the system must be disconnected, and relevant technicians must be

notified to arrive on site for maintenance and fault elimination. Batteries that have been severely short-circuited cannot be used again. They must be fully inspected by the manufacturer before a decision can be made on whether partial repair and use is possible.

Fire:

Battery system fire accidents caused by various reasons must be immediately evacuated the personnel in the energy storage room. No irrelevant personnel are allowed to approach the energy storage room within the safe range (because there may be explosion risks). Special fire extinguishers should be used by professionals for firefighting. After the fire is extinguished, personnel wearing necessary protective equipment should first cut off the power connection lines, and the battery system should be fully discharged through resistance (to zero volts) before the battery system can be removed for subsequent operation analysis.

Battery system collision:

Due to various reasons, if the battery system is collided, deformed or pierced by foreign objects, it should be immediately disconnected from the power connection line, and relevant technicians should be notified to handle the situation. If the battery needs to be removed, it should be fully discharged by personnel wearing necessary protective equipment before the battery can be removed.

Other accidents:

When the battery system needs to be repaired or the battery system needs to be removed due to other accidents, the battery circuit should be disconnected to ensure that the battery will not be short-circuited. The battery system should be removed under safe conditions to prevent damage from collisions, falls, upside-down, etc. If such situations occur, please follow the above regulations for handling.

8.2. Trouble Shooting for Air conditioner

8.2.1. Trouble Shooting

NO	Fault or alarm phenomenon	Possible causes	Solution
1	Temperature sensor failure	<ol style="list-style-type: none"> 1. The sensor is damaged, broken or short-circuited; 2. Sensor damage. 	<ol style="list-style-type: none"> 1. check if the cable connection is tight 2. If the above issues are not resolved, contact SOLIS.
2	System HV alarm	<ol style="list-style-type: none"> 1. The condenser is clogged or scaled; 2. Failure of the external fan; 3. The external circulating air is short-circuited or blocked; 4. Excessive refrigerant was charged during maintenance; 5. Excessively high ambient temperature; 6. False alarm from the sensor in the middle of the condenser. 	<ol style="list-style-type: none"> 1. Clean the condensing heat exchanger regularly; 2. Inspect/Replace the condensing fan; 3. The air inlet and outlet of the external mask must be well isolated, and it should be ensured that there are no close-range obstructions directly in front of the on-site cabinet installation. 4. Please have it repaired by professionals and add the appropriate amount of refrigerant as required by the nameplate. 5. Appropriately lower the ambient temperature or add shading devices; 6. If the above issues are not resolved, contact SOLIS.
3	Cabinet high-temperature	<ol style="list-style-type: none"> 1. The condenser is clogged or scaled; 2. Excessively high ambient temperature; 3. The refrigeration system malfunctions; 4. A cabinet with a relatively high heat generation has been added Equipment; 5. The temperature setting is 	<ol style="list-style-type: none"> 1. Clean the condenser heat exchanger regularly; 2. Appropriately lower the ambient temperature or add shading devices; 3. Please have professionals conduct inspection and maintenance. 4. Reevaluate the calorific value and make adjustments;

		inappropriate; 6. False alarm from the temperature sensor inside the cabinet.	5. Re-evaluate the temperature setting value and its deviation; 6. If the above issues are not resolved, contact SOLIS.
4	Cabinet low-temperature	1. The temperature setting is inappropriate; 2. The refrigeration system cannot be turned off. 3. False alarm from the temperature sensor inside the cabinet.	1. Re-evaluate the temperature setting value and its deviation; 2. If the above issues are not resolved, contact SOLIS.
5	The evaporator is frozen	1. Internal air circulation short circuit; 2. Poor air intake or exhaust inside the cabinet; 3. Internal fan failure; 4. The refrigeration system cannot be turned off. 5. The temperature sensor in the middle of the evaporator gave a false alarm.	1. Ensure that there is a certain distance between the internal circulation air inlet and the equipment inside the cabinet, and add an intermediate partition. 2. Ensure smooth air circulation at the air inlet and outlet of the internal circulation without severe blockage. 3. If the above issues are not resolved, contact SOLIS.
6	Abnormal communication	The terminal of the wire harness is loose.	Check if the wiring has come loose.

8.3. Fire Protection System Trouble Shooting

8.3.1. Smoke Detector Fault

NO	Fault or alarm phenomenon	Causes	Solution
1	The test smoke detector did not alarm	The smoke detector is damaged	Replace smoke detector, refer to chapter 7.6
2	The smoke detector gave a false fire alarm	The smoke detector is damaged	Replace smoke detector, refer to chapter 7.6

8.3.2. Temperature detector fault

NO	Fault or alarm phenomenon	Causes	Solution
1	The test temperature detector did not alarm	The temperature detector is damaged	Replace temperature detector, refer to chapter 7.6
2	The temperature detector gave a false fire alarm	The temperature detector is damaged	Replace temperature detector, refer to chapter 7.6

8.3.3. Gas detector alarm

NO	Fault or alarm phenomenon	Causes	Solution
1	The test detector did not alarm	detector is damaged	Replace the detector
2	LED indicator display Continuous yellow	1.cable failure 2.need calibration 3.detector is damaged	1.check it 2.re-calibration 3.replace it

8.3.4. Audible and visual alarm fault

NO	Fault or alarm phenomenon	Causes	Solution
1	The detector tested not alarm	The alarm is damaged	Replace it

9. Appendix

9.1. Maintenance Inspection Checklist

NO	System	Item	Standard	Frequency	Remark
1	Fire protection	Check the indicator light of the smoke detector	The indicator light of the smoke detector flashes every 2 seconds.	every six months	
2		Check the indicator light of the temperature detector	The indicator light of the temperature detector flashes every 6 seconds.	every six months	
3		Check whether the fixing brackets of the aerosol fire extinguishing device are loose.	No loosening	every year	
4		Check whether the aerosol fire extinguishing device is damaged	No Damage	every year	
5		Check if the aerosol has expired	The aerosol must be within the warranty period; The aerosol must be replaced every 15 years.	every year	
6		Use a smoke gun to spray smoke into the smoke detector.	If the smoke concentration does not exceed the alarm threshold, the indicator light flashes every 2 seconds; if the smoke concentration exceeds the alarm threshold, the indicator light	every year	

			remains on, indicating a fire alarm.		
7		Use the heating device to approach the temperature detector	If the temperature does not exceed the alarm threshold, the indicator light flashes once every 6 seconds; if the temperature exceeds the alarm threshold, the indicator light remains on and the EMS displays a fire alarm.	every year	
8		Audible and Visual Alarm	Check for any deformation, rusting, aging or other damages to the appearance. Check the installation for its firmness.	every year	
9		Gas detector	Check if the working condition is normal. Check for any deformation, rusting, aging or other damages to the appearance. Check if the installation is secure.	every year	
10		Gas detector calibration and testing	Refer to Section 7.7	every six months	

11	Pressure relief and explosion-proof facilities	Check Pressure relief valve (Standard configuration)	<p>Check if the vent holes are clear and unobstructed.</p> <p>Check for any deformation, rusting, or other damages to the appearance.</p> <p>Check if the valve flap can move flexibly without jamming.</p>	every three months	
12		Check Explosion proof intake valve (Optional configuration)	<p>Check if the vent holes are clear and unobstructed</p> <p>Check whether the explosion-proof fan has accumulated dust or is blocked</p> <p>Check if the installation and fasteners are secure.</p>	every three months	
13		Check Explosion proof exhaust valve (Optional configuration)	<p>Check if the vent holes are clear and unobstructed</p> <p>Check whether the explosion-proof fan has accumulated dust or is blocked</p> <p>Check if the installation and fasteners are secure.</p>	every three months	
14		Check Explosion relief Panel (Optional configuration)	<p>Check if the panel is intact without any scratches, dents, or cracks.</p> <p>Check if the discharge area is clear of any obstacles.</p>	every six months	

15	Battery	Are the fixing bolts of the internal structural components loose or missing?	No loosening or missing parts	every six months	
16		Check if the BMU/CSC is not properly connected.	Judged based on warnings or abnormal data via EMS; If the BMU/CSC is abnormal, please replace it.	Every day	
17		Check if there are any abnormal alarms in the High-Voltage Box.	Based on the EMS warnings or abnormal data; if there is an abnormality in the High-Voltage Box's hardware, then replacement is required.	every day	
18	Air conditioner	Inlet and outlet vents	Check whether the inlet and outlet air vents of the air conditioner, as well as the inlet and outlet air vents of the protective cover outside the cabinet, are clogged.	every six months	
19		Power cord and communication cable	Check whether the power lines and communication lines of the cabinet air conditioner are functioning properly.	every six months	
20		Sound	Check for any abnormal sounds when the fans, pumps and compressors are operating normally.	every six months	

21	System	Check whether there is water accumulation in the installation area and the cable trench.	The installation area and cable trench are free of water accumulation (if there is any water, please clean it and check the insulation condition)	Every month and after rainy days	
22		Check Is there any odor inside the equipment, such as a burnt smell, a foul odor or a pungent smell	There are no abnormalities around the equipment.	every day	
23		Check the connection of the power cord, whether the connections between each device and the terminals are loose, damaged or rusted, etc.	The power cord connections are not loose, and the wires between the devices are not damaged. There is no burning, no abnormal terminals, and no loosening, rusting or abnormality.	every six months	
24		Check whether the appearance is deformed, rusted or damaged	The appearance is normal, without rust or damage.	every six months	
25		Regular dust removal: Clean the air intake filter, exhaust filter and floor drain.	Keep the air intake mesh, exhaust outlet mesh and drain holes clean (if clogged, they may need to be cleaned or replaced)	every three months	
26		Check whether the indicator lights correspond to the operating status.	The indicator light is operating and corresponds to the operating status.	every day	
27		Regularly export the host monitoring data	Regularly export and store the data of the host system	every six months	

28		Regular charging and discharging	The system should be fully charged and discharged regularly for calibration to ensure the consistency of the battery system.	every months	
29		Check whether the data uploaded to EMS is functioning properly	Data is complete and there are no abnormal alarms.	every day	
30		Sealing inspection	All sealing points (including valves, pump seals, threaded/clip/Flange /joints) are tightly connected without any looseness or leakage. The sealing strips are undamaged or not loose.	every six months	
31		Check the insulation (high-voltage circuit)	Check every day whether there are any insulation alarms in the EMS. Use an insulation tester to check the insulation resistance once a year.	Daily (EMS Annual) Insulation Test	
32		Check the grounding condition of each battery pack. Check the grounding of other electrical cabinets.	The grounding resistance of each pack should be less than 0.1Ω (measured) and the grounding resistance of the site system should not exceed 4Ω.	every year	

10. After-Sales Instructions

SolisStroage provides users with comprehensive technical support and after-sales services.

1. Users can obtain services by calling our company's service hotline.

Service hotline: +86 (0)574 6578 1806

2. The free warranty period is in accordance with the contract.

The following situations are not covered by our company's free warranty service:

(1) System damage caused by improper operation in accordance with the user manual, or faults resulting therefrom.

(2) Damage or faults caused by incorrect wiring and power supply in accordance with relevant electrical safety regulations, or due to poor on-site conditions.

(3) System damage caused by user's unauthorized modifications.

(4) System damage or faults caused by natural disasters such as typhoons, earthquakes, floods, fires, or adverse environmental conditions (high temperature, low temperature, high humidity, acid rain, etc.).

(5) If the user does not maintain the initial fault state after the occurrence of the fault, fails to notify the manufacturer in time and handles it by themselves, resulting in inability to make a practical fault diagnosis of the cause of the fault.