



Quick Installation Guide

11KW&22KW Fox ESS AC EV Charger

Please read this guide carefully to
prevent improper operation before use.

Directory

1. Packing List.....	1
2. Product Icon.....	2
3. Installation Preparation	2
3.1 Electrical Connections.....	3
3.2 Communication wiring	5
3.3 Network connection.....	7
3.4 SIM card insertion.....	9
3.5 Wall Mounted Installation Method.....	10
3.6 Floor/Vertical installation Method.....	12
4. Inspection after installation	14

1. Packing List

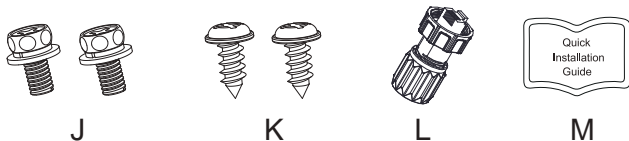
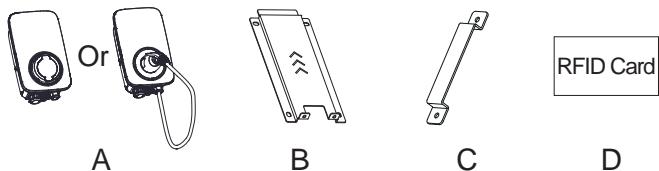

S/N	Name	Quantity
A	EV Charger (EV Plug or Plug Holder)	1
B	Mounting Backplate	1
C	Mounting Bracket	1
D	RFID Card	2
E	Expansion Pipe $\Phi 8 \times 40\text{mm}$	4
F	Expansion Screw ST6*40	4
G	Tubular Terminal EVN10-12	5
H	Tubular Terminal EVN6012	5
I	Tubular Terminal EVN0508	4
J	Screw Assembly M4*10mm	2
K	Self-tapping Screw ST4.2*9.5mm	2
L	Communication connector RJ45	1
M	Quick Installation Guide	1

2. Product Icon

① Meaning of lights

- Green breathing light - standby status
- Blue Steady - EV Plug inserted status
- Blue breathing light - charging start status/ pause
- Blue running light - charging status
- Green Steady - charging end status
- Red Steady - Charger fault, shutdown protection
- Yellow Steady - locked status

② EV Plug holder

③ RJ45 Communication wire

④ RS485 Communication wire

⑤ Incoming cable

⑥ Stop button

⑦ Mounting Bracket

⑧ Mounting Backplate

⑨ Side cover

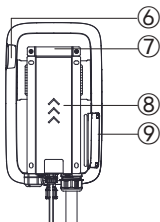
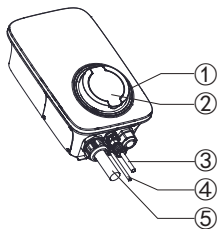

3. Installation Preparation

1. The EV Charger can be installed on a flat surface that can support its weight (such as walls, columns, etc.).

2. Please install an EV Charger where the EV Plug cable can be connected to the vehicle charging port (without pulling the cable).

3. The recommended installation height of the EV Charger is 700~1500mm.

4. Do not install the EV Charger in an environment that may cause damage to it.

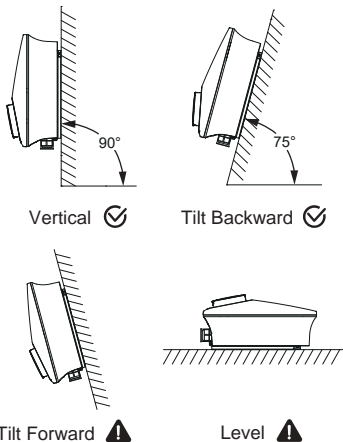

Installation Schematic Diagram

3.1 Electrical Connections

A leakage protection switch needs to be installed. The leakage protection switch should use Type A, not less than 32A, and the input wire should be led out from the leakage protection switch. It is recommended to use wire diameter 6-10mm² cable.

Trim all cables to 50mm (as shown in the figure) and peel off the insulation sheath to expose the conductor by about 10mm.

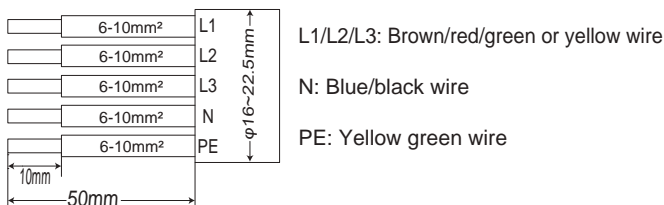

Note: Please refer to the local cable model and color during actual installation

Step 1

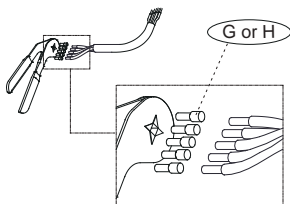

Use crimping pliers to crimp the tubular terminal (G) or(H)and cable.

Step 2

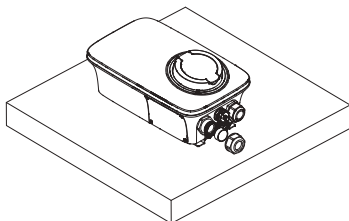

Unscrew the gland nut and puncture the wire-through hole.

Step 3

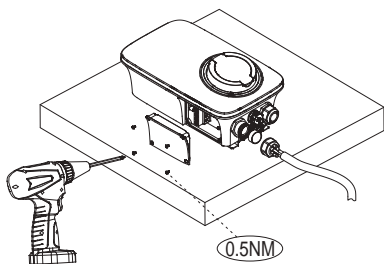

Unscrew the gland nut and puncture the wire-through hole. Open the side cover and install the cable (wire diameter $\varnothing 16-22.5\text{mm}$).

Step 4

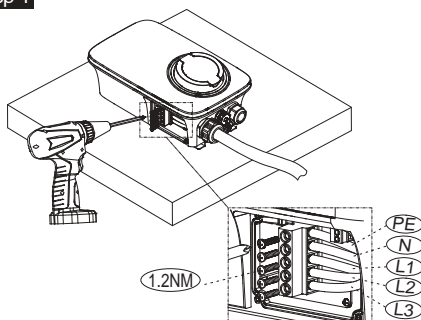

Install the cable into the terminal block and fix it, and tighten the gland nut.

Step 5

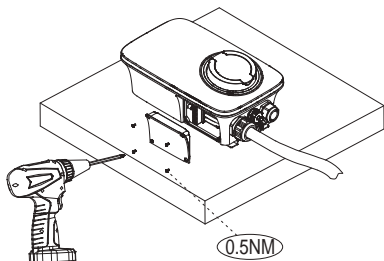

Lock the side cover and complete the installation.

3.2 Communication wiring (The communication wire is required only if an electric meter is available on the site of use)

Trim all cables (wire diameter 0.3mm^2) to 15mm (as shown in the figure), peel off the insulation sheath to expose the conductor by about 8mm .

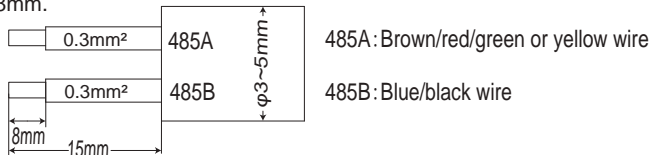

Note: Please refer to the local cable model and color during actual installation.

Step 1

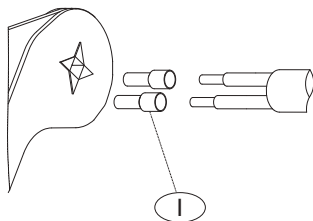

Use crimping pliers to crimp the tubular terminal (I) and cable.

Step 2

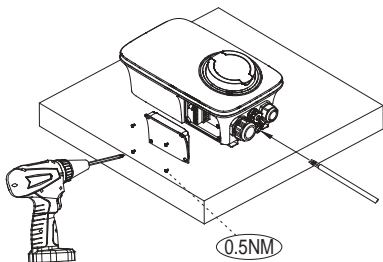

1. Open the side cover.
2. Install the communication cable (wire diameter $\phi 3 \sim 5\text{mm}$) from the communication port.

Step 3

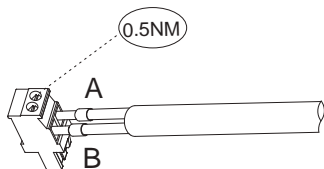

Install the cable into the signal terminal, tighten the screw and compress the tubular terminal.

Step 4

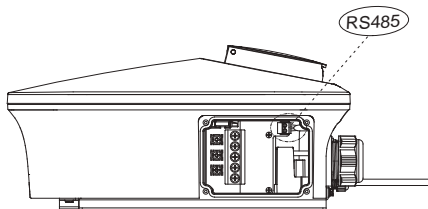

Fix the male and female ends of the signal terminal by connecting them.

Step 5

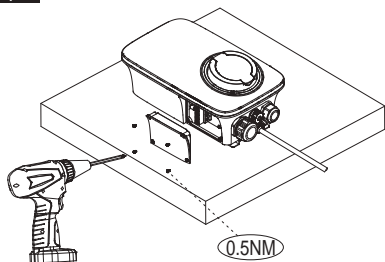

Lock the side cover and complete the installation.

3.3 Network connection

The network cable interfaces of the charging pile are as follows:

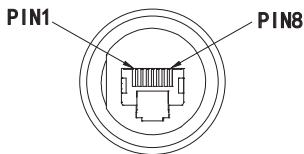

PIN	1	2	3	4	5	6	7	8
Color	White/Orange	Orange	White/Green	Blue	White/Blue	Green	White/Brown	Brown

Step 1

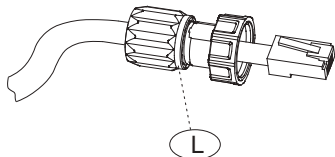

Pass the network cable through connector (L) and connect the network cable to the RJ45 connector.

Step 2

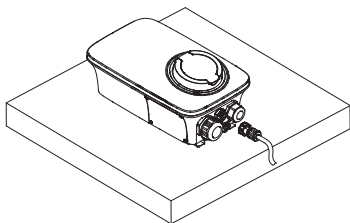

Unscrew the dust cover. Insert the RJ45 communication connector on which the network cable is installed into the Ethernet port.

Step 3

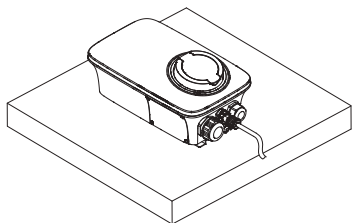

Tighten the connector nut to complete the installation.

3.4 SIM card insertion (SIM card insertion is required only when the charging pile has 4G connection function and 4G network connection is required)

Step 1

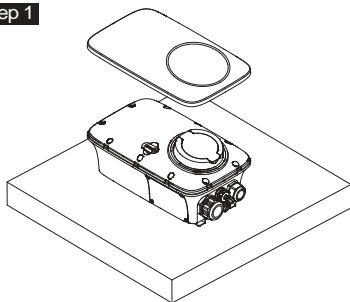

Open the outer cover.

Step 2

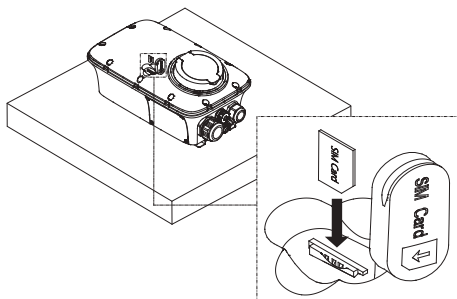

Open the SIM Card plug and insert the SIM Card (When inserting the SIM Card, pay attention to the direction shown in the picture)

Step 3

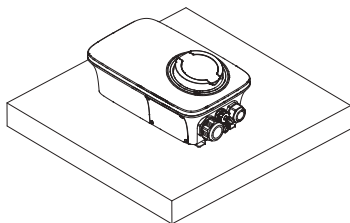

Close the SIM Card plug, install the cover, and complete the installation.

3.5 Wall Mounted Installation Method

Step 1

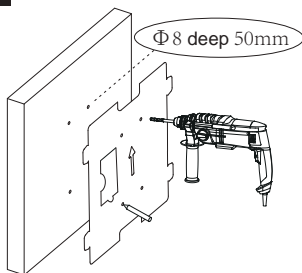

1. Mark 4 holes according to the installation positioning card on the wall.
2. Use an 8mm drill bit to drill holes (with a hole depth of over 50mm).
3. Clean the hole position.

Step 2

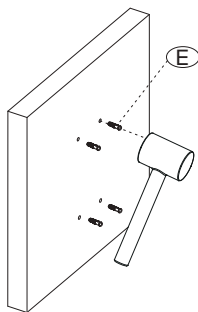

Insert the expansion pipe (E) into the hole and fix it tightly with a rubber hammer.

Step 3

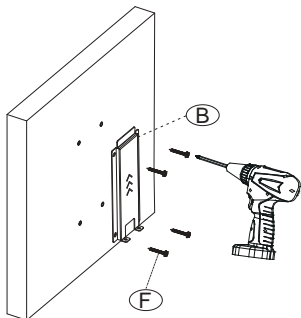

Fix the Mounting backplate (B) to the wall with screws (F).

Step 4

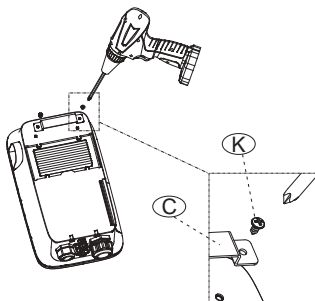

Fix the Mounting bracket (C) onto the EV Charger with screws (K).

Step 5

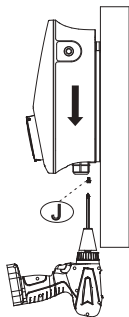

1. Hang the EV Charger into the Mounting backplate.
2. Tighten the screws (J) to complete the installation.

3.6 Floor/Vertical installation Method(When only purchasing columns and requiring installation)

Step 1

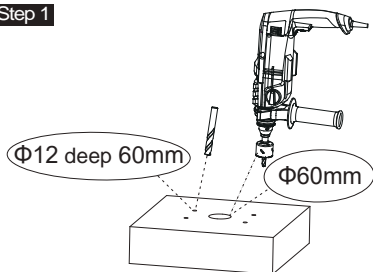

1. Use a 12mm drill bit to drill four 60mm deep holes with a spacing of 170*120mm.
2. Drill one $\Phi 60$ mm outlet hole in the center.
3. Clean the hole position.

Step 2

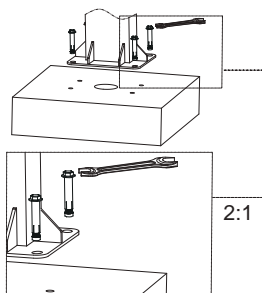

Install the foot screw and fix with a wrench.

Step 3



Router the input wire into the column hole through the ottom of the column.

Step 4

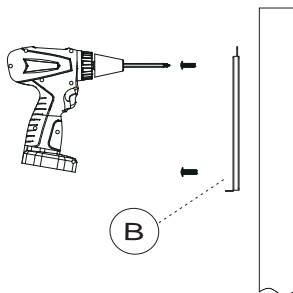

Fix the Mounting backplate (B) to the column with screws.

Step 5

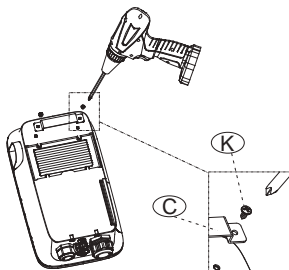

Fix the bracket (C) onto the EV Charger with screws (K).

Step 6

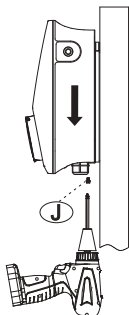

1. Hang the EV Charger into the Mounting backplate.
2. Tighten the screws (J) to complete the installation.

4. Inspection after installation

1) Cleaning

Properly dispose of all transportation and packaging materials in accordance with local regulations.

Clean up the debris inside and around the pile, such as small sections of cables, screws/nuts, etc. Do not leave them behind

Install tools on site or inside the pile (record the type and quantity of tools to prevent omissions).

Clean the insulation with an anti-static cloth and do not use any corrosive solvents

2) Inspection

Check if the base is fixed and sealed.

Check whether the internal components of the equipment are secure and reliable.

Check whether the electrical connections and wiring are correct and complete, whether the connections are reliable, and check the grounding Is it reliable.

Check whether the protection level of the equipment meets the requirements, especially at the cable inlet at the bottom of the pile.

Check appearance, markings, integrity, cleanliness.

Users can download the (Android and IOS) APP by scanning the QR code in the Quick Installation Manual, or search for EliteCharger through the App Store and Google Play.

Obtain the APP QR code



Please follow the steps below to download our latest multilingual manual/Quick Installation Guide;

Scan QR code → Select your language → Select to download User Manual or Quick Installation Guide → Download

Obtain User Manual QR code



Address: Longwan District, Wenzhou, China

Tel: +86(510) 68092998(General)
+86(510) 68101679 (Sales)

Website: www.fox-ess.com



V1.0

10-203-00443-00