

LAGUNA®

JX | 6 & JX | 8 Quadtec:al Jointers



Owner's Manual
506601
MJ8X72E-0130
3/11/2021





CONTENTS

JX|6 & JX|8 Quadtec:I Jointers

Safety	4
Electrical Safety	8
Specifications	13
Machine Overview	14
Setup	15
Placement & Unboxing	15
Inventory List	17
Assembling	18
Operation	21
Maintenance	24
Troubleshooting	27
Wiring	28
JX6 Quadtec:I Parts	31
JX8 Quadtec:I Parts	39
Warranty	47

Safety

Read and understand all warnings and operation instructions before using any tool or equipment. Always follow basic safety precautions to reduce the risk of personal injury. Improper operation, maintenance or modification of tools or equipment could result in serious injury and property damage. There are certain applications for which tools and equipment are designed. This product should NOT be modified and/or used for any application other than for which it was designed.

It is important for you to read and understand this manual. The information it contains relates to protecting your safety and preventing problems.

Safety Call-outs

⚠ DANGER!

A POTENTIALLY HAZARDOUS SITUATION WHICH, IF NOT AVOIDED, COULD RESULT IN DEATH OR SERIOUS INJURY.
SOMETIMES DISPLAYED AS **⚠ DANGER!**

⚠ WARNING

A POTENTIALLY HAZARDOUS SITUATION WHICH, IF NOT AVOIDED, COULD RESULT IN DEATH OR SERIOUS INJURY.
SOMETIMES DISPLAYED AS **⚠ WARNING!**











⚠ CAUTION!

A POTENTIALLY HAZARDOUS SITUATION WHICH, IF NOT AVOIDED, MAY RESULT IN MINOR OR MODERATE INJURY.
SOMETIMES DISPLAYED AS **⚠ CAUTION!**

NOTICE!

A HELPFUL TIP FROM OUR TECHNICAL STAFF. SOMETIMES DISPLAYED AS NOTICE!

Safety Symbols

- | | | | |
|---|--|---|--------------------------|
|  | Disconnect from power before proceeding. |  | Wear ear protection. |
|  | Be aware of possible laceration danger. |  | Wear Eye Protection. |
|  | Be aware of possible crushing danger. |  | Wear a full face shield. |
|  | Be aware of possible crushing danger. |  | Wear lung protection. |
|  | Electrical Hazard. |  | Requires X People |

⚠ PROP 65 WARNING

SOME DUST CREATED BY POWER SANDING, SAWING, GRINDING, DRILLING, AND OTHER CONSTRUCTION ACTIVITIES CONTAINS CHEMICALS KNOWN TO THE STATE OF CALIFORNIA TO CAUSE CANCER, BIRTH DEFECTS OR OTHER REPRODUCTIVE HARM. SOME EXAMPLES OF THESE CHEMICALS ARE:

- LEAD FROM LEAD-BASED PAINTS.
- CRYSTALLINE SILICA FROM BRICKS, CEMENT AND OTHER MASONRY PRODUCTS.
- ARSENIC AND CHROMIUM FROM CHEMICALLY-TREATED LUMBER.

YOUR RISK FROM THESE EXPOSURES VARIES, DEPENDING ON HOW OFTEN YOU DO THIS TYPE OF WORK. TO REDUCE YOUR EXPOSURE TO THESE CHEMICALS: WORK IN A WELL VENTILATED AREA, AND WORK WITH APPROVED SAFETY EQUIPMENT, SUCH AS THOSE DUST MASKS THAT ARE SPECIALLY DESIGNED TO FILTER OUT MICROSCOPIC PARTICLES.

⚠ APPLICATIONS WARNING

- THIS MACHINE WAS DESIGNED FOR CERTAIN APPLICATIONS ONLY. WE STRONGLY RECOMMEND THAT THIS MACHINE NOT BE MODIFIED AND/OR USED FOR ANY APPLICATION OTHER THAN THAT FOR WHICH IT WAS DESIGNED. IF YOU HAVE ANY QUESTIONS RELATIVE TO A PARTICULAR APPLICATION, DO NOT USE THE MACHINE UNTIL YOU HAVE FIRST CONTACTED THE MANUFACTURER TO DETERMINE IF IT CAN OR SHOULD BE PERFORMED ON THE PRODUCT.
- IF YOU HAVE ANY QUESTIONS RELATIVE TO ITS APPLICATION DO NOT USE THE PRODUCT UNTIL YOU HAVE CONTACTED THE MANUFACTURER AND WE HAVE ADVISED YOU.

⚠ WARNING!

Machine & Workshop Safety Instructions

Read and understand all warnings and operating instructions before using this equipment. Failure to follow all instructions listed below, may result in electric shock, fire, and/or serious personal injury or property damage. Machinery can be dangerous if safe and proper operating procedures are not followed. As with all machinery, there are certain hazards involved with the operation of the product. Using the machine with respect and caution will considerably lessen the possibility of personal injury. However, if normal safety precautions are overlooked or ignored, personal injury to the operator may result. Safety equipment such as guards, push sticks, hold-downs, feather boards, goggles, dust masks and hearing protection can reduce your potential for injury. But even the best guard won't make up for poor judgment, carelessness or inattention. Always use common sense and exercise caution in the workshop. If a procedure feels dangerous, don't try it. Figure out an alternative procedure that feels safer. REMEMBER: Your personal safety is your responsibility.

OWNER'S MANUAL. Read and understand this owner's manual BEFORE using machine.

TRAINED OPERATORS ONLY. Untrained operators have a higher risk of being hurt or killed. Only allow trained/supervised people to use this machine. When machine is not being used, disconnect power, remove switch keys, or lock-out machine to prevent unauthorized use—especially around children. Make your workshop kid proof!

DANGEROUS ENVIRONMENTS. Do not use machinery in areas that are wet, cluttered, or have poor lighting. Operating machinery in these areas greatly increases the risk of accidents and injury.

MENTAL ALERTNESS REQUIRED. Full mental alertness is required for safe operation of machinery. Never operate under the influence of drugs or alcohol, when tired, or when distracted.

ELECTRICAL EQUIPMENT INJURY RISKS. You can be shocked, burned, or killed by touching live electrical components or improperly grounded machinery. To reduce this risk, only allow qualified service personnel to do electrical installation or repair work, and always disconnect power before accessing or exposing electrical equipment.

DISCONNECT POWER FIRST. Always disconnect machine from power supply BEFORE making adjustments, changing tooling, or servicing machine. This prevents an injury risk from unintended start-up or contact with live electrical components.

EYE PROTECTION. Always wear ANSI-approved safety glasses or a face shield when operating or observing machinery to reduce the risk of eye injury or blindness from flying particles. Everyday eyeglasses are NOT approved safety glasses.

WEARING PROPER APPAREL. Do not wear clothing, apparel or jewelry that can become entangled in moving parts. Always tie back or cover long hair. Wear non-slip footwear to reduce risk of slipping and losing control or accidentally contacting cutting tool or moving parts.

HAZARDOUS DUST. Dust created by machinery operations may cause cancer, birth defects, or long-term respiratory damage. Be aware of dust hazards associated with each workpiece material. Always wear a NIOSH-approved respirator to reduce your risk.

HEARING PROTECTION. Always wear hearing protection when operating or observing loud machinery. Extended exposure to this noise without hearing protection can cause permanent hearing loss.

REMOVE ADJUSTING TOOLS. Tools left on machinery can become dangerous projectiles upon startup. Never leave chuck keys, wrenches, or any other tools on machine. Always verify removal before starting!

USE CORRECT TOOL FOR THE JOB. Only use this tool for its intended purpose—do not force it or an attachment to do a job for which it was not designed. Never make unapproved modifications, modifying tool or using it differently than intended may result in malfunction or mechanical failure that can lead to personal injury or death!

AWKWARD POSITIONS. Keep proper footing and balance at all times when operating machine. Do not overreach! Avoid awkward hand positions that make workpiece control difficult or increase the risk of accidental injury.

CHILDREN & BYSTANDERS. Keep children and bystanders at a safe distance from the work area. Stop using machine if they become a distraction.

GUARDS & COVERS. Guards and covers reduce accidental contact with moving parts or flying debris. Make sure they are properly installed, undamaged, and working correctly BEFORE operating machine.

FORCING MACHINERY. Do not force machine. It will do the job safer and better at the rate for which it was designed.

NEVER STAND ON MACHINE. Serious injury may occur if machine is tipped or if the cutting tool is unintentionally contacted.

STABLE MACHINE. Unexpected movement during operation greatly increases risk of injury or loss of control. Before starting, verify machine is stable and mobile base (if used) is locked.

USE RECOMMENDED ACCESSORIES. Consult this owner's manual or the manufacturer for recommended accessories. Using improper accessories will increase the risk of serious injury.

UNATTENDED OPERATION. To reduce the risk of accidental injury, turn machine OFF and ensure all moving parts completely stop before walking away. Never leave machine running while unattended.

MAINTAIN WITH CARE. Follow all maintenance instructions and lubrication schedules to keep machine in good working condition. A machine that is improperly maintained could malfunction, leading to serious personal injury or death.

DAMAGED PARTS. Regularly inspect machine for damaged, loose, or wrongly adjusted parts—or any condition that could affect safe operation. Immediately repair/replace BEFORE operating machine. For your own safety, DO NOT operate machine with damaged parts!

MAINTAIN POWER CORDS. When disconnecting cord-connected machines from power, grab and pull the plug—NOT the cord. Pulling the cord may damage the wires inside. Do not handle cord/plug with wet hands. Avoid cord damage by keeping it away from heated surfaces, high traffic areas, harsh chemicals, and wet/damp locations.

WARNING!

Jointer Specific Safety Instructions

LIKE ALL MACHINES, THERE IS DANGER ASSOCIATED WITH THE MACHINE. INJURY IS FREQUENTLY CAUSED BY LACK OF KNOWLEDGE OR FAMILIARITY. USE THIS MACHINE WITH RESPECT. IF NORMAL SAFETY PRECAUTIONS ARE OVERLOOKED OR IGNORED, SERIOUS PERSONAL INJURY MAY OCCUR.

1. KICKBACK

"KICKBACK" IS WHEN THE WORK PIECE IS THROWN OFF THE JOINTER TABLE BY THE CUTTER HEAD. ALWAYS USE PUSH BLOCKS AND SAFETY GLASSES TO REDUCE THE LIKELIHOOD OF INJURY FROM "KICKBACK". THE "KICKBACK ZONE", IS THE PATH DIRECTLY THROUGH THE END OF THE IN FEED TABLE. NEVER STAND OR ALLOW OTHERS TO STAND IN THIS AREA DURING OPERATION. IF KICK BACK OCCURS, SEVERE INJURY MAY RESULT.

2. CUTTER HEAD ALIGNMENT

TO REDUCE THE POSSIBILITY OF KICKBACK, KEEP THE TOP EDGE OF THE OUT FEED TABLE ALIGNED WITH THE CUTTER HEAD INSERT AT TOP DEAD CENTER (TDC).

3. PUSH BLOCKS

THE CUTTER HEADS ARE EXTREMELY DANGEROUS AND YOU MUST NEVER PASS YOUR HANDS OVER THE CUTTER HEAD. ALWAYS USE PUSH BLOCKS WHENEVER SURFACE PLANNING. HAND SAFETY. IT IS GOOD PRACTICE TO MOVE THE HANDS IN AN ALTERNATE MOTION FROM BACK TO FRONT AS THE WORK CONTINUES THROUGH THE CUT. NEVER PASS YOUR HANDS DIRECTLY OVER THE CUTTERHEAD. AS ONE HAND APPROACHES THE CUTTERHEAD REMOVE IT FROM THE STOCK IN AN ARC MOTION AND PLACE IT BACK ON THE STOCK IN A POSITION BEYOND THE CUTTERHEAD. YOUR HANDS MUST NEVER BE CLOSER THAN 3 INCHES TO THE CUTTER HEAD.

4. SUPPORTING THE WORK

ONLY MAKE CUTS IF THE WORK PIECE IS STABLE AND NEVER ATTEMPT TO CUT UNSTABLE PLANKS, OR INJURY MAY OCCUR.

5. CUTTING DEPTH

NEVER EXCEED THE MAXIMUM CUTTING DEPTH AS STATED IN THE SPECIFICATION FOR YOUR MACHINE. IT IS FAR BETTER TO TAKE SEVERAL SMALL CUTS RATHER THAN LARGE CUTS.

6. DIRECTION OF CUT

JOINTING AGAINST THE GRAIN OR JOINTING END GRAIN IS DANGEROUS AND COULD PRODUCE CHATTER OR EXCESSIVE CHIP OUT. ALWAYS JOINT WITH THE GRAIN.

7. GUARDS

GUARDS ARE DESIGNED TO REDUCE THE RISK OF INJURY. ALWAYS USE THE GUARDS. IF IT IS IMPERATIVE TO USE THE MACHINE WITHOUT THE GUARDS, [RABBETING] ALWAYS REPLACE THE GUARDS.

8. CUTTING DIRECTION

ONLY CUT FROM THE IN FEED TABLE TO THE OUT FEED TABLE, AND ALWAYS COMPLETE THE CUT. DO NOT STOP THE WOOD PROGRESS UNTIL THE JOB HAS CLEARED THE CUTTER HEAD COMPLETELY. ONLY CUT WITH THE GRAIN OR AT A SLIGHT ANGLE TO THE GRAIN.

9. STOCK

YOUR SAFETY WILL BE GREATLY ENHANCED IF YOU ONLY USE GOOD LUMBER. ONLY WORK WITH LUMBER AFTER YOU HAVE INSPECTED IT COMPLETELY. STAPLES, NAILS LOOSE KNOTS AND ANY OTHER METAL IN THE PLANK WILL DAMAGE YOUR CUTTER HEAD AND COULD CAUSE INJURY AND OR FIRE. IF YOU HAVE ANY QUESTION ABOUT A PIECE OF LUMBER, DO NOT USE IT.

**SAVE THESE INSTRUCTIONS.
Refer to them often and use them to instruct others.**

Electrical Safety

WARNING!

- RUNNING ON A DIFFERENT VOLTAGE THAN STATED BELOW WILL DAMAGE THE MACHINE. NEVER RUN THE MACHINE IN WET OR DAMP CONDITIONS.
- ELECTROCUTION, FIRE, SHOCK, OR EQUIPMENT DAMAGE MAY OCCUR IF MACHINE IS NOT PROPERLY GROUNDED AND CONNECTED TO POWER SUPPLY.

Motor Specifications

The typical main motors are either a 1.5 HP (JX6) or a 1.75 HP (JX8) and are wired for 110 Volt, Single-Phase, 60 HZ, AC current. Confirm your motor electrical configuration before connecting power! Before connecting the machine to the power source, make sure the starter and switches are in the "OFF" position. Power Cord and "plug" are NOT included. These must be installed by a qualified technician/electrician to meet all applicable codes.

NOTICE! A 110 Volt to 220 Volt conversion kit is available for either jointer. Kit part #510220. See "220 Volt Conversion" for kit instructions.

Power Supply

A separate electrical circuit should be used for each machine. This circuit should not be less than the wiring listed below and should be protected with an appropriate circuit breaker based on the total running and start-up amperage's (listed below). If an extension cord is used, use only 3-wire extension cords which have 3-prong grounding type plugs and matching receptacle which will accept the machine's plug.

506601

VOLTAGE	110V
PHASE	1PH
HERTZ	60Hz
FULL LOAD AMPERAGE	13Amp

 WARNING! Below are RECOMMENDATIONS to be used for this machine based on the above information. Variables that may affect this are:

- Actual voltage supplied to the machine
- Electrical code that must be met in your local province.

An electrician will verify that all the demands are met to properly wire the machine. If you have absolutely any doubt when wiring this machine - please consult with a qualified electrician.

PLUG/RECEPTACLE	Not Included
WIRING (Gauge)	See Jacket Printing
CIRCUIT BREAKER	20Amp

MJ8X72P-0130

VOLTAGE	110V
PHASE	1PH
HERTZ	60Hz
FULL LOAD AMPERAGE	15Amp

⚠ WARNING! Below are RECOMMENDATIONS to be used for this machine based on the above information. Variables that may affect this are:

- Actual voltage supplied to the machine
- Electrical code that must be met in your local province.

An electrician will verify that all the demands are met to properly wire the machine. If you have absolutely any doubt when wiring this machine - please consult with a qualified electrician.

PLUG/RECEPTACLE	Not Included
WIRING (Gauge)	See Jacket Printing
CIRCUIT BREAKER	20Amp

If this information is different than what is stated on the Motor Specification Plate - omit this information. It is possible that the documentation is outdated to a machine change - such as a different motor. Always check the motor plate prior to any wiring. If any doubts, please consult a certified electrician.

Know when to use a time delay fuse! AKA Slow blow fuse. Generally, if the motor uses a start capacitor, a time delay fuse is required. This type of fuse (circuit breaker) will not trip with the initial amperage needed to start the machine, which is typically double that of the running amperage. Most woodworking machines use this type of fuse.

Grounding Methods

⚠ DANGER!

THIS MACHINE MUST BE GROUNDED WHILE IN USE TO PROTECT THE OPERATOR FROM ELECTRIC SHOCK. IN ALL CASES, MAKE CERTAIN THAT THE RECEPTACLE IN QUESTION IS PROPERLY GROUNDED. IF YOU ARE NOT SURE, HAVE A QUALIFIED ELECTRICIAN CHECK THE RECEPTACLE.

Grounding Methods Provided by CSA Group. (A) Receptacle with nominal rating less than 150 volts. (B) 150 volt receptacle without grounding pin fitted with adapter. (C) 150-250 volt receptacle.

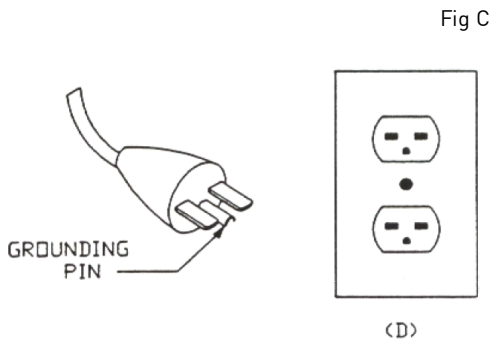
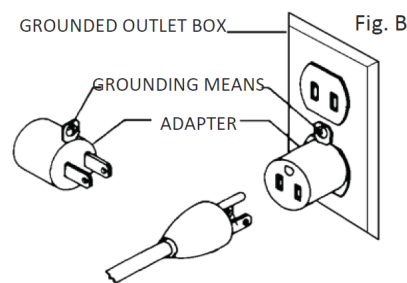
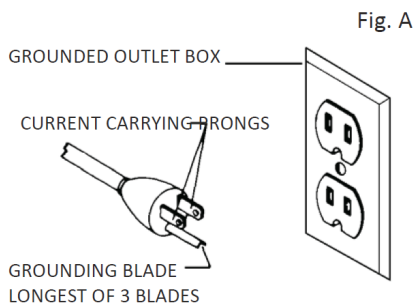

1. All grounded, cord-connected machines:

In the event of a malfunction or breakdown, grounding provides a path of least resistance for electric current to reduce the risk of electric shock. This tool is equipped with an electric cord having an equipment-grounding conductor and a grounding plug. The plug must be plugged into a matching outlet that is properly installed and grounded in accordance with all local codes and ordinances.

Do not modify the plug provided - if it will not fit the outlet, have the proper outlet installed by a qualified electrician.

Improper connection of the equipment-grounding conductor can result in a risk of electric shock. The conductor with insulation having an outer surface that is green with or without yellow stripes is the equipment-grounding conductor. If repair or replacement of the electric cord or plug is necessary, do not connect the equipment-grounding conductor to a live terminal.

Check with a qualified electrician or service personnel if the grounding instructions are not completely understood, or if in doubt as to whether the tool is properly grounded.

Use only 3-wire extension cords that have 3-prong grounding plugs and 3 pole receptacles that accept the tool's plug.

Repair or replace damaged or worn cord immediately.

2. Grounded, cord-connected machines intended for use on a supply circuit having a nominal rating less than 150 volts:

This tool is intended for use on a circuit that has an outlet that looks like the one illustrated in Fig. A. The tool has a grounding plug that looks like the plug illustrated in Fig A. A temporary adapter, which looks like the adapter illustrated in Fig B may be used to connect this plug to a 2 pole receptacle as shown in Fig B if a properly grounded outlet is not available. The temporary adapter should be used only until a properly grounded outlet can be installed by a qualified electrician. This adapter is not permitted in Canada. The green-colored rigid ear, lug, and the like, extending from the adapter must be connected to a permanent ground such as a properly grounded outlet box.

3. Grounded, cord-connected tools intended for use on a supply circuit having a nominal rating between 150 – 250 volts, inclusive:

This tool is intended for use on a circuit that has an outlet that looks like the one illustrated in Fig C. The tool has a grounding plug that looks like the plug illustrated in Fig C. Make sure the tool is connected to an outlet having the same configuration as the plug. No adapter is available or should be used with this tool. If the tool must be reconnected for use on a different type of electric circuit, the reconnection should be made by qualified service personnel; and after reconnection, the tool should comply with all local codes and ordinances.

Extension Cords

⚠ WARNING Use proper extension cords. Make sure your extension cord is in good condition and is a 3-wire extension cord which has a 3-prong grounding type plug and matching receptacle which will accept the machine’s plug. When using an extension cord, be sure to use one heavy enough to carry the current of the machine. An undersized cord will cause a drop in line voltage, resulting in loss of power and overheating. If in doubt, use the next heavier gauge. The smaller the gauge number, the heavier the cord.

MINIMUM GAUGE EXTENSION CORD 120V

RECOMMENDED SIZES FOR USE WITH STATIONARY ELECTRIC MACHINES

Ampere Rating	Volts	Total Length of Cord in Feet	Gauge of Extension Cord
0-6	120	up to 25	18 AWG
0-6	120	25-50	16 AWG
0-6	120	50-100	16 AWG
0-6	120	100-150	14 AWG
6-10	120	up to 25	18 AWG
6-10	120	25-50	16 AWG
6-10	120	50-100	14 AWG
6-10	120	100-150	12 AWG
10-12	120	up to 25	16 AWG
10-12	120	25-50	16 AWG
10-12	120	50-100	14 AWG
10-12	120	100-150	12 AWG
12-16	120	up to 25	14 AWG
12-16	120	25-50	12 AWG
12-16	120	GREATER THAN 50 FEET NOT RECOMMENDED	

MINIMUM GAUGE EXTENSION CORD 240V

RECOMMENDED SIZES FOR USE WITH STATIONARY ELECTRIC MACHINES

Ampere Rating	Volts	Total Length of Cord in Feet	Gauge of Extension Cord
0-6	240	up to 50	18 AWG
0-6	240	50-100	16 AWG
0-6	240	100-200	16 AWG
0-6	240	200-300	14 AWG
6-10	240	up to 50	18 AWG
6-10	240	50-100	16 AWG
6-10	240	100-200	14 AWG
6-10	240	200-300	12 AWG
10-12	240	up to 50	16 AWG
10-12	240	50-100	16 AWG
10-12	240	100-200	14 AWG
10-12	240	200-300	12 AWG
12-16	240	up to 50	14 AWG
12-16	240	50-100	12 AWG
12-16	240	GREATER THAN 100 FEET NOT RECOMMENDED	

Specifications

JX|6 & JX|8 Quadtec:I Jointers

	JX 6 QUADTEC: I 506601	JX 8 QUADTEC: I MJ8X72P-0130
VOLT HP MOTOR AMP. RECOM. SIZE BRKR.	115V 1.5HP 1PHASE 60HZ/ 13 AMP.	115V 1.75HP 1PHASE 60HZ/15 AMP.
CSA	YES	YES
BED SIZE	6 X 60"	8 X 72"
INFEEED TABLE PULL-OUT EXTENSION	8"	8"
RABBETTING CAPACITY	1/2"	1/2"
FENCE SIZE	29"X3-3/4" CAST IRON	38" X 4-3/4" CAST IRON
FENCE TILT	±45/90 DEGREE	±45/90 DEGREE
MAX. DEPTH OF CUT	1/8"	1/8"
TABLE HEIGHT FROM FLOOR	31"	31"
SAFETY BAR SHUT-OFF	YES	YES
WHEELS BUILT-IN	YES	YES
BRACKET TO MOUNT LIGHT	NO	NO
110V OUTLET FOR LIGHT	NO	NO
BRACKET TO MOUNT FEEDER	NO	NO
DUST PORT DIAMETER	4"	4"
CUTTERHEAD INSERT #	12 X 4-SIDED CARBIDE, 4 ROW	20 X 4-SIDED CARBIDE, 4 ROW
CUTTERHEAD RPM	5500	5500
CUTTERHEAD DIAMETER	2-1/2"	3-1/8"
BED ADJUSTMENT	PARALLELOGRAM	PARALLELOGRAM
DIMENSIONS SET UP APPROX.	63" X 22"	75-1/2" X 26-1/2"
DIMENSIONS SHIPPING	65"X 22"X 13" + 31"X 16"X 27"	76" X 25" X 41"
NET/SHIP WEIGHT # OF BOXES	LBS. 161/174 + 88/94 2BOXES	LBS. 380/495 1 BOX

Machine Overview

JX|6 & JX|8 Quadtec:I Jointers

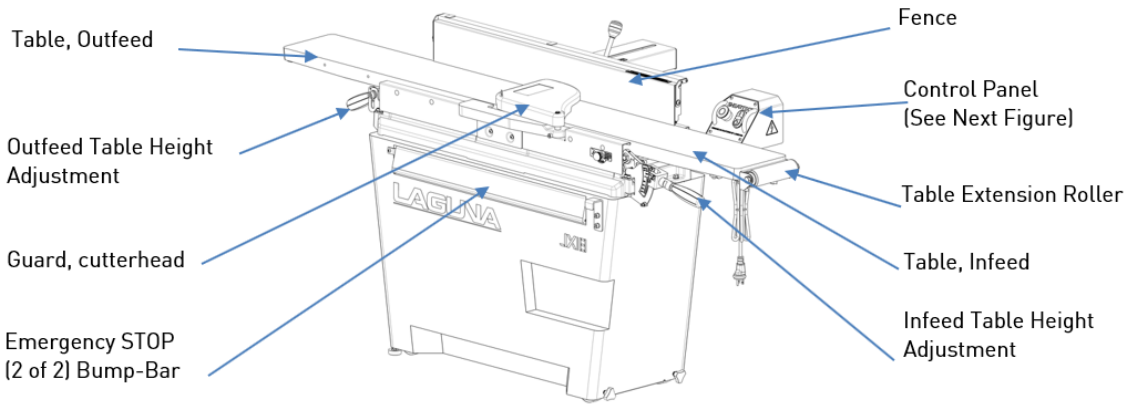
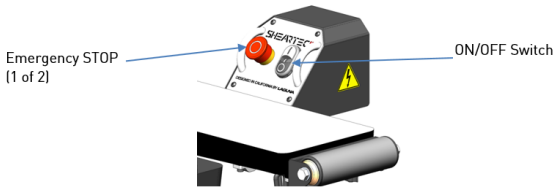

Figure 6: Main Components



- A. Emergency Stop (E-STOP); stops all functions of machine, however, power continues to machine. **NOTICE!** To reset E-STOP, rotate switch clockwise until the button “pops” out. **NOTICE!** E-STOP bump bar (red) located on front of frame.
- B. ON/OFF Switch; Starts and Stops rotation of cutterhead. **NOTICE!** Will not work of the E-STOP is engaged.

Setup

Setup Overview (MUST READ)

When setting up your Jointer, please take a moment to read this overview prior to starting.

The machine comes mostly assembled. You will have to assemble the leveling feet and calibrate the thickness scale.

After Setup, There may be a few adjustment to be made. All of these adjustments are done prior to shipping the machine, however if additional adjustments are required please follow the adjustment guides.

⚠ CAUTION! If you have any doubt about the described procedure, seek professional assistance. Do not attempt any procedure that you feel is unsafe, or that you do not have the physical capability of achieving.

Placement & Unboxing

Your Machine will likely be delivered by a third party delivery service. Before unpacking your new machine, first inspect the packaging, the invoice, and the shipping documents supplied by the driver. When unpacking your machine, separate all enclosed items from the packing materials and inspect them for damages. Ensure that there is no visible damage to either the packaging or the machine BEFORE the driver leaves. Save all packaging materials until you are satisfied with the machine and/or have resolved any issues concerning any missing or damaged items.

NOTICE!

- ALL SHIPPING DAMAGE MUST BE NOTED UPON DELIVERY AND SIGNED BY THE OWNER AND THE DELIVERY DRIVER. IF YOU FIND ANY DAMAGED ITEMS IN YOUR PACKAGE, YOU MUST CONTACT LAGUNA TOOLS TO FILE A COMPLAINT. IN ORDER TO RETURN DAMAGED GOODS UNDER THE LIMITED WARRANTY TO LAGUNA TOOLS, INC., YOU MUST HAVE THE ORIGINAL PACKAGING. ALL CLAIMS OF LOSS OR DAMAGED GOODS MUST BE REPORTED TO LAGUNA TOOLS WITHIN 24 HOURS OF DELIVERY. PLEASE CONTACT THE LAGUNA TOOLS, INC. CUSTOMER SERVICE DEPARTMENT TO MAKE CLAIMS FOR ANY DAMAGED ITEMS/PARTS.
- IT IS PROBABLE THAT YOU WILL FIND SAWDUST WITHIN YOUR MACHINE. THIS IS BECAUSE THE MACHINE HAS BEEN TESTED PRIOR TO SHIPMENT FROM THE FACTORY AND OR LAGUNA TOOLS. WE TEST MACHINES PRIOR TO SHIPPING TO CUSTOMERS, BUT MOVEMENT CAN TAKE PLACE DURING TRANSPORTATION. SOME ADJUSTMENTS MAY HAVE TO BE UNDERTAKEN BY THE CUSTOMER. THESE ADJUSTMENTS ARE COVERED IN THE VARIOUS SECTIONS OF THIS MANUAL.

Placement

Before you remove your machine from the packaging, select the area where you will use your machine. There are no hard and fast rules for its location, but below are a few guidelines:

1. There should be sufficient area at the front of the machine to allow you to work on it comfortably.
2. There should be sufficient area at the back of the machine to allow access for adjustments and maintenance to be conducted.
3. Adequate lighting. The better the lighting the more accurately and safely you will be able to work.
4. Solid floor. You should select a solid flat floor, preferably one made of concrete or something similar.
5. Locate it close to a power source and dust collection.

6. Allow an area for the storage of blanks, finished products and tools.

Unboxing

⚠ WARNING!

- THE MACHINE WEIGHS 174 LBS (78KG) (THE JX8 WEIGHS 495 LBS (224KG)). ENSURE THAT YOU HAVE ENOUGH PEOPLE TO DO THE JOB SAFELY.
- IF YOU HAVE ANY DOUBT ABOUT THE DESCRIBED PROCEDURE, SEEK PROFESSIONAL ASSISTANCE. DO NOT ATTEMPT ANY PROCEDURE THAT YOU FEEL IS UNSAFE, OR THAT YOU DO NOT HAVE THE PHYSICAL CAPABILITY OF ACHIEVING.

This step requires a forklift. The machine is heavy, be careful when lifting and handling it! Failure to comply may cause serious injury and/or damage to the machine and/or property! Use a forklift to remove the jointer from pallet and place on floor.

NOTICE! Another option to remove the jointer from the pallet is to attach the included hooks to frame of machine at each of the four corners (Fig. 3). The hooks and bolts are included in the hardware kit. The machine can then be lifted with a harness and forklift. Remove and save hooks for later movement scenarios.



FIGURE 3: COVER REMOVED FROM CRATE



FIGURE 4: CRATE REMOVED

The Jointer comes packed in a single crate. Before attempting to assemble this machine, follow these directions:

1. Remove the top covering the machine, typically screwed (or nailed) in place.
2. Remove the two ends of the crate.
3. Remove the top cross pieces and the sides of the crate.
4. Cut the banding (use gloves & eye protection) being careful not to be in the path of the banding when cut.
5. Remove any packing material such as cardboard or foam.
6. Using the information below, ensure that all parts are present and in good condition.

Inventory List

The following depicts items shipped with your machine. Before assembling, ensure that you have received all parts shown below. Machine parts should arrive sealed in plastic bags. Remove parts from plastic bags before laying them out to inventory them.

Inventory

- 2 Push Blocks
- 1 3mm Hex Wrench
- 1 6mm Hex Wrench
- 1 8/10mm Wrench
- 1 11/13mm Wrench

Tools/items Required: Assembly & Adjustment

- T-25 Torx Wrench
- 3mm Hex Wrench
- 6mm Hex Wrench
- 8mm Hex Wrench (not included)
- 8/10mm Wrench
- 11/13mm Wrench

DANGER!

FOR YOUR OWN SAFETY, DO NOT CONNECT THE MACHINE TO THE POWER SOURCE UNTIL THE MACHINE IS COMPLETELY ASSEMBLED! PLEASE ALSO MAKE SURE THAT YOU READ AND UNDERSTAND THE ENTIRE MANUAL.

Assembling

Machine Preparation and Setup:

1. The machine is supplied with four installed wheels, two of which are locking style (infeed side). Lock these two wheels, by turning the thumbscrew clockwise, when the machine is placed and before operation (Fig. 4). Loosen the two thumbscrews when moving the jointer.

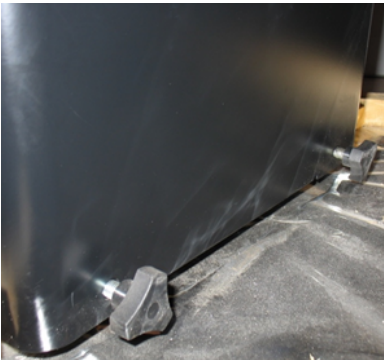

FIGURE 5: WHEEL LOCKS

2. Clean all rust protected surfaces with a commercial de-greaser. DO NOT use acetone, gasoline, lacquer thinner or any type of cleaner that could damage paint. Coat cleaned surfaces with WD-40® or Teflon based lube.

⚠ CAUTION!

BE CAREFUL WHEN WORKING ON OR NEAR CUTTERHEAD AS THE KNIVES ARE VERY SHARP!

Power Supply Circuit Requirements

The power source circuit for your machine must be grounded and rated for the amperage given below. Never replace a circuit breaker on an existing circuit with one of higher amperage without consulting a qualified electrician to ensure compliance with wiring codes. If you are unsure about the wiring codes in your area or you plan to connect your machine to a shared circuit, consult a qualified electrician.

Circuit Size 1.5 HP (110V, Single Phase)20 Amp (minimum)

Circuit Size 1.75 HP (110V, Single Phase)20 Amp (minimum)

⚠ DANGER!

IN ALL CASES, MAKE CERTAIN THE RECEPTACLE IN QUESTION IS PROPERLY GROUNDED. IF YOU ARE NOT SURE, HAVE A QUALIFIED ELECTRICIAN CHECK THE RECEPTACLE.

Motor Specifications

The standard main motor is either 1.5 or 1.75 HP and is typically wired for 110 Volt, Single Phase, 60 HZ, AC current. Confirm your motor electrical configuration before connecting power! Before connecting the machine to the power source, make sure the starter and/or switches are in the "OFF" position.

⚠ WARNING

WHEN COMPLETED, THE MACHINE MUST CONFORM TO THE NATIONAL ELECTRIC CODE AND ALL LOCAL CODES AND ORDINANCES.

Connecting Power (See also wiring diagram page 33)

1. Plug power cord into 20 Amp (min.), 110 Volt, Single Phase, dedicated circuit.

⚠ WARNING

DISCONNECT POWER SUPPLY TO JOINTER BEFORE CONTINUING! ONLY CONNECT POWER WHEN REQUIRED.

Calibrating the Thickness Scale

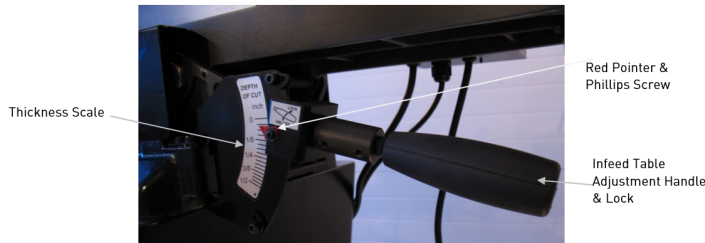

FIGURE 13: THICKNESS SCALE



FIGURE 14: LOCK PIN

1. Loosen the Infeed Table locking handle by rotating counterclockwise (Fig. 13).
2. Pull and hold the Lock Pin (Fig. 14) while positioning handle to 1/64". Tighten handle.
3. Make a test cut half-way on sample material. Measure The depth of cut/stock removal on the sample. If not 1/64", adjust pointer to actual cut dimension by loosening the Phillips screw and adjusting red pointer and tightening the Philips screw.

Adjusting the Fence

The fence can be adjusted to use all or a portion of the cutterhead. To adjust, loosen the Locking Handle (Fig. 15) and turn the Adjustment Knob to position fence in desired location.

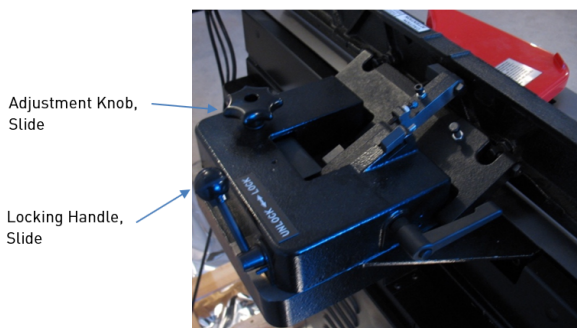

FIGURE 15: FENCE SLIDE COMPONENTS

NOTICE! The 90-degree position has an included reference STOP (Fig. 16). To adjust, flip the stop into position, loosen the lock nut and rotate the adjusting screw until the fence is at 90 degrees to the table. Tighten the lock nut and flip the stop back if making other angled adjustments. To check the 90 degree setting, place a square on the outfeed table and against the fence.



FIGURE 16: FENCE ANGLE ADJUSTMENT COMPONENTS

To adjust the fence perpendicular or angled to the bed, loosen the Locking Lever (Fig. 16) and adjust the fence to the desired position.

Operation

⚠ CAUTION!

PLACE THE JOINTER ON A SECURE AND STABLE SURFACE FOR OPERATION. CLAMP OR BOLT THE JOINTER INTO POSITION.

1. Establish the proper depth of cut. 1/64" is the recommended maximum cut for the best finish with least chance of kick-back when jointing.



FIGURE 22: INFEEED TABLE EXTENSION

NOTICE! The infeed table extension (Fig. 22) can be extended for support of long material. Loosen the two locking studs under the bed, pull extension out and tighten the two locking studs.

2. Start dust collection.
3. Start jointer.
4. Feed stock into cutterhead, while maintaining contact of the stock on the bed and against the fence. Maintain control and support of stock as the stock opens the guard and contacts the cutterhead. Maintain a good, firm stance while pushing stock across the jointer. Move hands along stock when feeding to maintain control of stock. Lift hands from stock as they come near cutterhead and reposition them on outfeed side. **DO NOT allow hands to come within three inches of the cutterhead.**
5. Reposition yourself to the outfeed side of jointer and control and support stock until it is past cutterhead and the guard has fully closed.

⚠ WARNING

USE PUSH BLOCKS FOR FACE JOINTING! DO NOT PLACE YOUR HANDS NEAR CUTTERHEAD OR GUARD!

Edge and Face jointing:

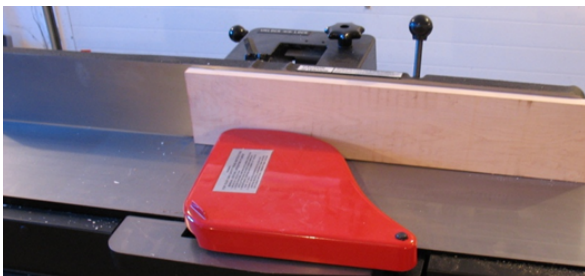

FIGURE 17: EDGE JOINTING



FIGURE 18: FACE JOINTING

Beveling

The fence can be adjusted up to 45 degrees angled toward the infeed/outfeed tables (bed) or away from the infeed/outfeed tables (bed) for beveling. There is less chance of stock slippage when the fence is angled down, toward the tables (Fig. 19). Angling the fence toward the tables is also a safer method to bevel, when the application allows.

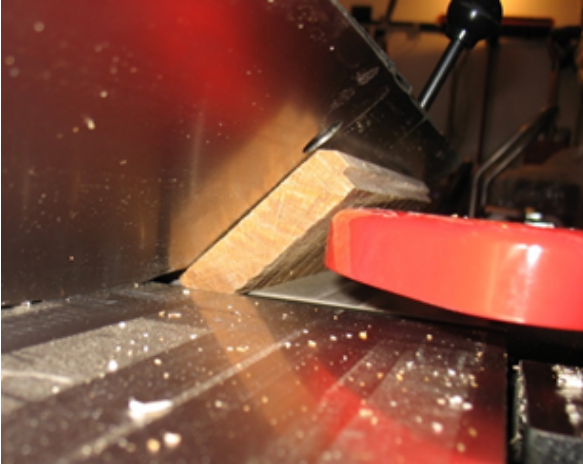

FIGURE 19: BEVELING

NOTICE!

THE TWO 45-DEGREE POSITIONS INCLUDE TWO REFERENCE STOPS (FIG. 16). TO ADJUST, LOOSEN THE LOCK NUT AND ROTATE THE ADJUSTING SCREW UNTIL THE FENCE IS AT 45 DEGREES TO THE TABLE, ANGLED IN OR OUT.

Rabbeting

Rabbeting is a groove along the edge of stock. The stock can be on edge or face, depending on the dimensions required for the rabbet.

Position fence for width of rabbet cut. This is the distance from the outmost edge of the outermost knife insert to the fence.

Set depth of cut with the Infeed Table Adjustment Handle. Do not set deeper than 1/64" per pass. Several passes may be required to reach the desired depth. Adjust the infeed table for each pass (1/64" max.) until the rabbet is completed.



FIGURE 20: RABBETING

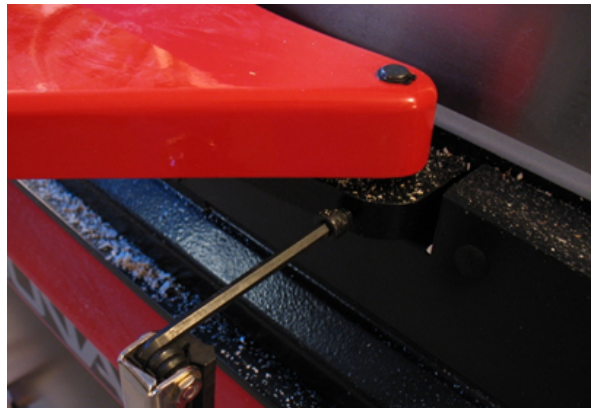

FIGURE 21: REMOVING GUARD FOR RABBETING

NOTICE!

(SPRING LOADED GUARD (RED) MAY NEED TO BE REMOVED FOR RABBETING WIDE STOCK.) LOOSEN HEX BOLT AND LIFT GUARD WITH PIN FROM MACHINE (FIG. 21).

⚠ DANGER!

REPLACE GUARD AS SOON AS MACHINE STOPS AFTER RABBET IS CUT!
NEVER ALLOW HANDS NEAR CUTTERHEAD WHEN THE GUARD IS REMOVED!

Maintenance

General

Keep your machine clean. At the end of each day, clean the machine. Wood contains moisture, and if sawdust or wood chips are not removed they will cause rust.

In general, we recommend that you only use a Teflon-based lubricant on the machine. Regular oil attracts dust and dirt. Teflon lubricant tends to dry and has less of a tendency to accumulate dirt and saw dust.

Periodically check that all nuts and bolts are tight.

Daily checks

1. Clean the machine and lubricate unpainted surfaces with a Teflon lubricant. Wipe off any excess and buff with a dry polishing cloth. This will reduce the likelihood of rust forming and reduce the friction on the tables as the wood is machined.
2. Check knife inserts for nicks and sharpness.
3. Generally inspect the machine for damage and loose or worn parts.

Weekly checks

1. Clean the cutter head. Do not touch knife inserts!
2. Check knife inserts for nicks and sharpness.
3. Generally inspect the machine for damage and loose or worn parts.
4. Check the dust extraction for blockages and any large pieces that could cause blockages.

Monthly checks

1. Check the drive belt for wear, splits and cuts.
2. Clean the motor compartment and the motor to ensure that the motor cooling fins work efficiently.
3. Generally inspect the machine for damage and loose or worn parts. NOTICE! It is recommended that you use a Teflon based lubricant.

Routine Inspections

It is a good idea to routinely inspect any quality woodworking tool in order to keep it in optimum condition. This includes inspecting all hardware for tightness, ensuring the filter is clean, and cleaning debris and grime from any surfaces and moving parts. In addition, make sure to:

- Clean out-feed rollers and table with a non-flammable solvent to remove pitch, gum and other unwanted build-up.
- Periodically clean the inside of the machine for dust control.
- Keep pulleys and belts free from dirt, dust, oil and grease.
- Replace worn belts as needed.
- Replace worn knives or sharpen.

Knife rotation/replacement

⚠ CAUTION!

KNIFE INSERTS ARE DANGEROUSLY SHARP. USE EXTREME CAUTION WHEN INSPECTING, REMOVING, OR REPLACING KNIFE INSERTS.

⚠ WARNING

- TURN JOINTER OFF AND DISCONNECT POWER BEFORE PERFORMING ANY MAINTENANCE OR ADJUSTMENTS!
- MAKE SURE ALL KNIFE INSERT SCREWS ARE TIGHTENED SECURELY. LOOSE INSERTS CAN BE PROPELLED AT HIGH SPEED FROM A ROTATING CUTTERHEAD, CAUSING INJURY.
TORQUE EACH SCREW TO 52-60 IN/LBS.



Figure 23: Quad-Tec I Cutterhead

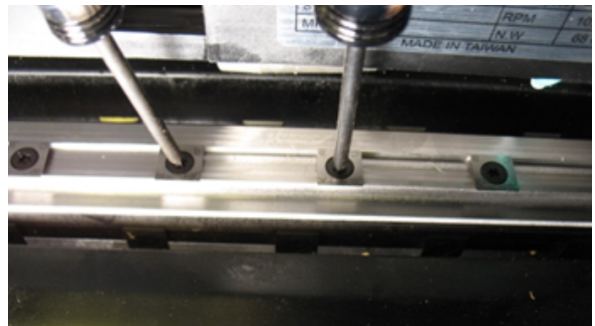

Figure 23b: Holding Quad-Tec I Cutterhead

1. The knife inserts are four-sided. When dull, remove each knife, rotate it 90° for a fresh edge, and re-install it. No further adjustment is necessary. Use a Torx wrench to remove the knife insert screw. Use a second Torx wrench to hold the cutterhead (from rotating) in position (in another screw). **⚠ WARNING! DO NOT USE YOUR HAND TO HOLD THE CUTTERHEAD! See Fig. 23b.**
2. It is advisable to rotate all inserts at the same time to maintain consistent cutting. However, if one or more knife inserts develops a nick, rotate only those inserts that are affected. Each knife insert has an etched reference mark so you can keep track of the rotation. **Torque each screw to 52-60 in/lbs.**
3. **IMPORTANT:** When removing or rotating inserts, clean sawdust from the screw, the insert, and the cutterhead platform. Dust accumulation between these elements can prevent the insert from seating properly and may affect the quality of the cut.
4. Before installing each screw, lightly coat the screw threads with machine oil and wipe off any excess. Securely tighten each screw which holds the knife inserts before operating the jointer!

Outfeed Table Adjustment:

⚠ WARNING

- TURN OFF AND DISCONNECT POWER BEFORE PERFORMING ANY MAINTENANCE OR ADJUSTMENTS!

The outfeed table is adjusted at the factory to be level with (or within .006" of) the Top Dead Center (TDC) of the knife inserts.

To adjust the Outfeed Table, loosen the Adjustment Lock (Fig. 24) for the Outfeed Table with an 8mm hex wrench (not included). Adjust the height of the Outfeed Table with the Adjustment Handle for the Outfeed Table (Fig. 24). Tighten the Adjustment Lock.

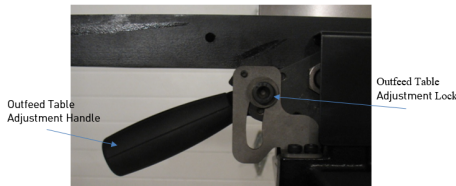

FIGURE 24: OUTFEED TABLE ADJUSTMENT

Poly Drive Belt Adjustment:

⚠ WARNING

- TURN OFF AND DISCONNECT POWER BEFORE PERFORMING ANY MAINTENANCE OR ADJUSTMENTS!

The poly-drive-belt tension is set at the factory. Proper tension is achieved when the belt can be depressed approximately 1/4" mid-way between the pulleys.

If adjustment is needed remove the four screws holding the back panel to the stand of the jointer.

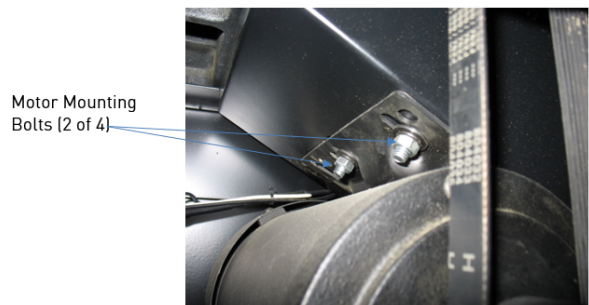

FIGURE 25: TWO OF THE FOUR MOTOR MOUNTING BOLTS

The motor is attached with four bolts on a slide. Loosen the four motor mount bolts to tension the drive belt by sliding the motor downward (Fig. 25).

When the drive belt is properly tensioned, tighten the four motor mounting bolts and replace the back cover.

Troubleshooting

Symptom	Possible Cause	Possible Solution
MACHINE WILL NOT START	<ol style="list-style-type: none"> 1. FUSE BLOWN OR CIRCUIT BREAKER TRIPPED 2. CORD DAMAGED 3. NOT CONNECTED TO POWER SOURCE 4. CONNECTED TO WRONG VOLTAGE 5. EMERGENCY STOP BUTTON PRESSED 	<ol style="list-style-type: none"> 1. REPLACE FUSE OR RESET CIRCUIT BREAKER 2. HAVE CORD REPLACED 3. CHECK CONNECTION 4. CHECK VOLTAGE 5. ROTATE EMERGENCY STOP BUTTON CLOCKWISE UNTIL IT POPS OUT
CUTTERHEAD DOES NOT COME UP TO SPEED	<ol style="list-style-type: none"> 1. LOW CURRENT 2. MOTOR NOT WIRED FOR CORRECT VOLTAGE 	<ol style="list-style-type: none"> 1. CONTACT LOCAL ELECTRIC COMPANY 2. REFER TO MOTOR NAMEPLATE FOR CORRECT VOLTAGE
WORKPIECE DIFFICULT TO PUSH	<ol style="list-style-type: none"> 1. TOO MUCH MATERIAL BEING REMOVED IN ONE PASS 2. DULL KNIVES 	<ol style="list-style-type: none"> 1. REDUCE THE AMOUNT OF MATERIAL BEING REMOVED 2. ROTATE OR REPLACE KNIVES
SHIPE	<ol style="list-style-type: none"> 1. MATERIAL NOT SUPPORTED PROPERLY AS IT EXITS OUTFEED TABLE 2. OPERATOR PUSHING DOWN ON TRAILING END OF MATERIAL 3. OUTFEED TABLE TOO LOW 	<ol style="list-style-type: none"> 1. SUPPORT MATERIAL FOR ENTIRE CUT 2. ELIMINATE DOWNWARD PRESSURE ON TRAILING END 3. ADJUST OUTFEED TABLE LEVEL WITH CUTTERHEAD ACHIEVED
FUZZY GRAIN	<ol style="list-style-type: none"> 1. WOOD WITH A HIGH MOISTURE CONTENT 2. DULL KNIFE INSERT(S) 	<ol style="list-style-type: none"> 1. ALLOW WOOD TO DRY PROPERLY 2. ROTATE OR REPLACE 3. KNIFE INSERT(S)
LINE(S) OR RIDGES IN FINISHED SURFACE	<ol style="list-style-type: none"> 1. NICKED OR DAMAGED KNIFE INSERT(S) 	<ol style="list-style-type: none"> 1. ROTATE OR REPLACE 2. KNIFE INSERT(S)

Dust Collection

To ensure proper operation and longest knife life it is important to maintain full air flow to your dust collection system. Make sure the filter media is clean and there are no obstructions in the ducting or hoses.

Wiring

⚠ WARNING

REVIEW [ELECTRICAL SAFETY](#) PRIOR TO ANY WIRING PROCEDURES.

506601

VOLTAGE	110V
PHASE	1PH
HERTZ	60Hz
FULL LOAD AMPERAGE	13Amp

⚠ WARNING! Below are RECOMMENDATIONS to be used for this machine based on the above information. Variables that may affect this are:

- Actual voltage supplied to the machine
- Electrical code that must be met in your local province.

An electrician will verify that all the demands are met to properly wire the machine. If you have absolutely any doubt when wiring this machine - please consult with a qualified electrician.

PLUG/RECEPTACLE	Not Included
WIRING (Gauge)	See Jacket Printing
CIRCUIT BREAKER	20Amp

MJ8X72P-0130

VOLTAGE	110V
PHASE	1PH
HERTZ	60Hz
FULL LOAD AMPERAGE	15Amp

⚠ WARNING! Below are RECOMMENDATIONS to be used for this machine based on the above information. Variables that may affect this are:

- Actual voltage supplied to the machine
- Electrical code that must be met in your local province.

An electrician will verify that all the demands are met to properly wire the machine. If you have absolutely any doubt when wiring this machine - please consult with a qualified electrician.

PLUG/RECEPTACLE	Not Included
WIRING (Gauge)	See Jacket Printing
CIRCUIT BREAKER	20Amp

JX|6 Quadtec: I 506601

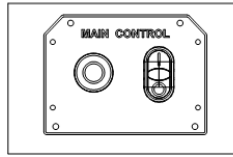

1.5HP*115V/230V*60HZ*1PH*2P

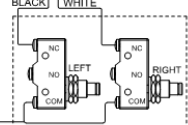
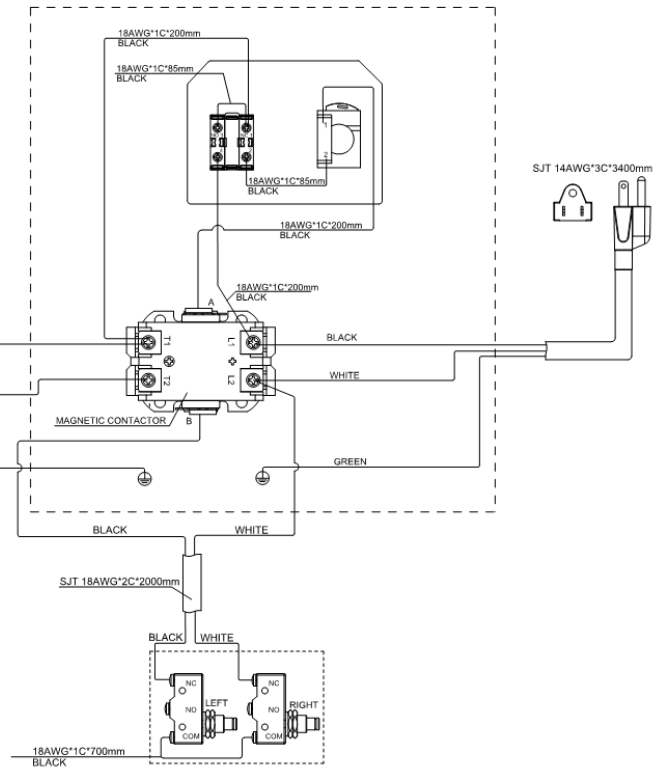
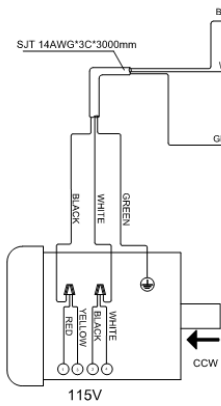
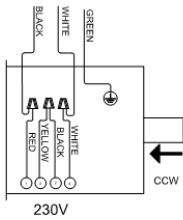
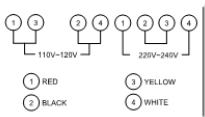

JX|8 Quadtec: I MJ8X72P-0130

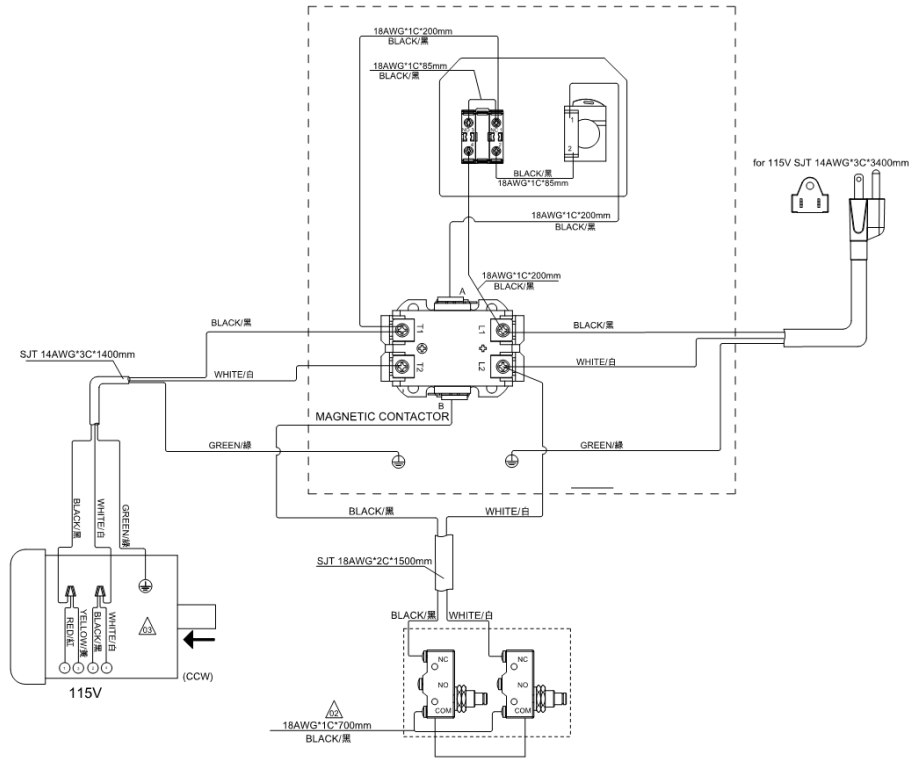
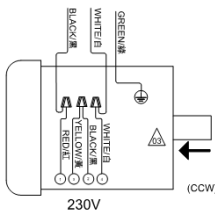
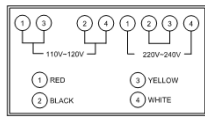
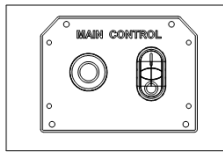

JX6 Quadtec:| Parts

Cutterhead & Drivetrain

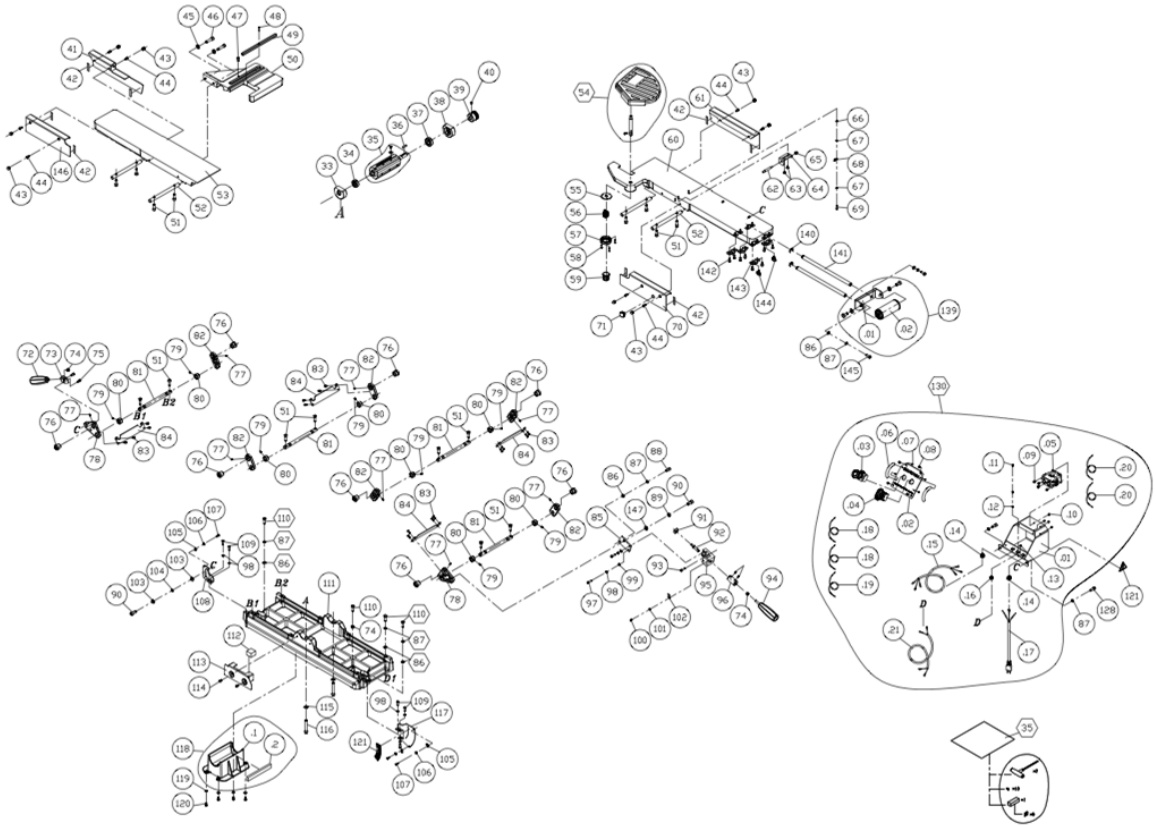

Fence

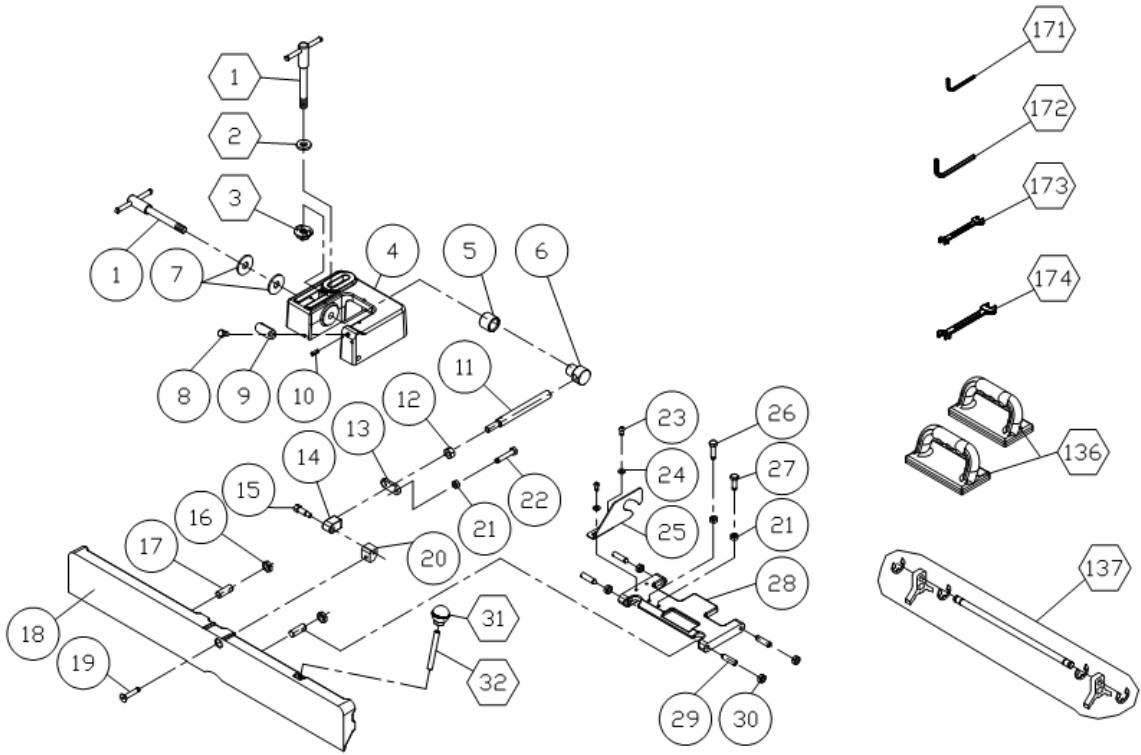

Stand & Motor

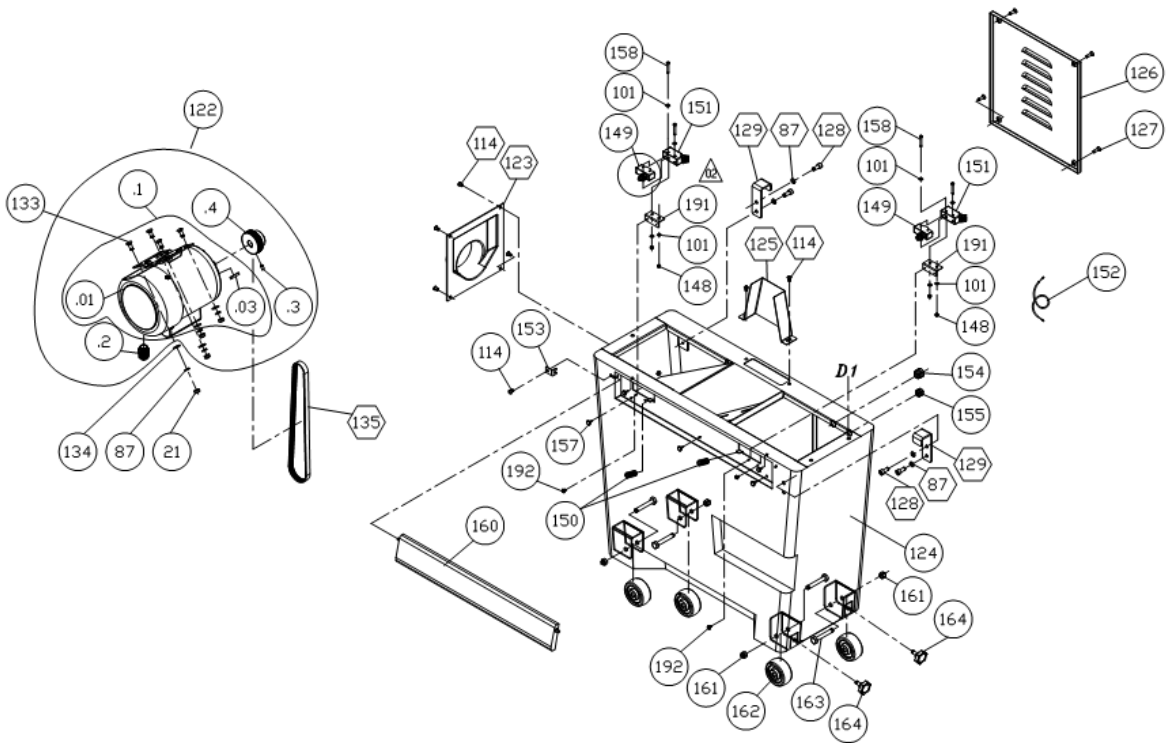

REF NO	PART NUMBER	DESCRIPTION	SPECIFICATION	QTY
1	360034-901	LOCK HANDLE		2
2	006003-091	FLAT WASHER	13-28X3.0	1
3	380209-901	T-NUT		1
4	051301-196	FENCE BRACKET - UPPER		1
5	130055-903	SLEEVE		1
6	130009-903	FIXING BLOCK		1
7	006003-097	FLAT WASHER	13.5-40X3.0	2
8	290003-901	BOLT		1
9	170047-901	STOP PLATE		1
10	011002-103	SPRING PIN	4X12	2
11	360068-901	FIXING ROD		1
12	009008-300	HEX NUT	7/16"-14 (17.4BX9.52H)	1
13	170598-901	FENCE STOP		1
14	130007-903	PIVOT		1
15	290004-901	BOLT		1
16	009010-100	HEX NUT	1/2"-20 (19.05BX6.35H)	2
17	360676-901	STUD PIVOT		2
18	051300-196	FENCE		1

REF NO	PART NUMBER	DESCRIPTION	SPECIFICATION	QTY
19	003602-702	FLAT HD. SOC. SCREW	5/16"-18X1-5/8"	1
20	130008-903	PIVOT		1
21	009005-300	HEX NUT	5/16"-18 (12.7BX6.75H)	7
22	003003-708	HEX SCREW	5/16"-18X1-3/4"	1
23	003301-701	PAN HEAD SCREW	1/4"-20X1/2"	2
24	006003-023	FLAT WASHER	6.3-13X2	2
25	170048-901	SAFT PLATE		1
26	003003-706	HEX SCREW	5/16"-18X1-1/4"	1
27	003003-705	HEX SCREW	5/16"-18X1"	1
28	051303-196	TILT PLATE		1
29	230015-901	STUD		4
30	009022-300	HEX NUT	3/8"-16 (13.83BX6.68H)	4
31	250372-615	FENCE TILT KNOB		1
32	360038-901	HANDLE ROD		1
33	050018-901	BEARING HOUSING		1
34	030206-002	BALL BEARING	6202	1
35	925133-001	SEGMENTED CUTTERHEAD	QUADTEC1	1
35	925134-001	SEGMENTED CUTTERHEAD	4 SLOTS	1
	925135-001	KNIFE INSERT	10PCS/BOX	1
	038201-101	TORX SCREW	#10-32X1/2"	
	040710-000	TORX WRENCH	T-25	1
36	012003-009	KEY	5X5X25	1
37	030207-002	BALL BEARING	6203	1
38	050019-901	BEARING HOUSING		1
39	381427-902	PULLEY	6SLOT	1
40	001902-101	SET LOCK SCREW	M6-1.0X10	1
41	174794-196	REAR BASE COVER - L		1
42	200024-615	PACKING		8
43	042505-000	CORD PLUG	HP-13	8
44	000103-102	CAP SCREW	M6*1.0P*10	8
45	006001-163	FLAT WASHER	8.5-19X3	2
46	000104-110	CAP SCREW	M8-1.25X30	2
47	003103-102	CAP SCREW	1/4"-20X1/2"	1
48	011002-105	SPRING PIN	4X20	1
49	380080-000	KEY		1
50	051445-196	FENCE BRACKET		1
51	000104-108	CAP SCREW	M8-1.25X25	16
52	361373-902	SUPPORT SHAFT		4
53	051443-196	OUTFEED TABLE		1
54	920155-001	CUTTERHEAD GUARD ASSEMBLY		1
55	170045-901	RETAINER RING		1
56	280009-000	SPRING		1

REF NO	PART NUMBER	DESCRIPTION	SPECIFICATION	QTY
57	110004-000	RETAINING KNOB		1
58	003305-206	PAN HEAD SCREW	5/32"-32X5/8"	3
59	110024-000	KNOB		1
60	051459-196	TABLE INFEED		1
61	174793-196	REAR BASE COVER - R		1
62	361327-902	HANDLE SHAFT BOLT		1
63	290028-901	SHOULDER SCREW		2
64	174603-902	FIXING PLATE		1
65	009103-100	LOCK NUT	1/4"-20 (11BX8H)	1
66	008004-100	HEX NUT	M5-0.8 (8BX4H)	1
67	006001-009	FLAT WASHER	5.2-10X1.0	2
68	280082-000	TENSION SPRING		1
69	000102-116	CAP SCREW	M5-0.8X15	1
70	174796-196	FRONT COVER - R		1
71	230156-615	KNOB PLUNGER	22 X 1/4-20	1
72	230141-615	HANDLE		1
73	174786-904	PLATE		1
74	008006-100	HEX NUT	M8-1.25 (13BX6.5H)	3
75	000102-104	CAP SCREW	M5-0.8X12	2
76	130350-903	BUSHING		8
77	001901-102	SET LOCK SCREW	M5-0.8X8	8
78	130351-903	CONNECTING ROD PLATE		2
79	001902-102	SET LOCK SCREW	M6-1.0X8	10
80	361241-902	BUSHING		8
81	361374-902	ROD		4
82	130352-903	ROD PLATE		6
83	002603-101	CAP LOCK SCREW	M5-0.8X10	16
84	174790-000	FIXING ROD PLATE		4
85	174784-904	FIXING PLATE		1
86	006001-049	FLAT WASHER	8.5-16X2.0	6
87	006305-100	LOCK WASHER	8.2-13.7	16
88	000104-104	CAP SCREW	M8-1.25X16	1
89	006307-100	LOCK WASHER	10.2-18.5	1
90	000105-101	CAP SCREW	M10-1.5X20	2
91	130393-903	INCLINED BLOCK		1
92	361370-902	HANDLE SHAFT BOLT		1
93	002602-101	CAP LOCK SCREW	M6-1.0X12	1
94	230191-000	MITER GAUGE HANDLE		1
95	310548-911	FIXED BLOCK		1
96	381428-902	BUSHING		1
97	000103-108	CAP SCREW	M6-1.0X25	2
98	006303-100	LOCK WASHER	6.5-10.5	7

REF NO	PART NUMBER	DESCRIPTION	SPECIFICATION	QTY
99	006001-022	FLAT WASHER	6.3-13X1.0	2
100	000302-101	PAN HEAD SCREW	M4-0.7X6	1
101	006001-001	FLAT WASHER	4.3-10X1.0	9
102	174782-156	POINTER		1
103	006003-080	FLAT WASHER	10.5-23X3.0	2
104	006703-100	WAVE WASHER	WW-10	1
105	174785-904	FIXING PLATE		3
106	006502-100	INT. TOOTH WASHER	5.3-10 (BW-5)	3
107	000102-103	CAP SCREW	M5-0.8X10	3
108	174787-904	LOCKING PLATE - L		1
109	000103-105	CAP SCREW	M6-1.0X15	5
110	000003-105	HEX SCREW	M8-1.25X25	1
110	000003-105	HEX SCREW	M8-1.25X25	3
111	051444-196	BASE		1
112	200105-615	SPONGE	30X30X22 (LXWXH)	1
113	174797-196	CUTTERHEAD FRONT COVER		1
114	000801-101	ROUND HEAD HEX SCREW	M6-1.0X10	3
114	000801-101	ROUND HEAD HEX SCREW	M6-1.0X10	6
115	006306-100	LOCK WASHER	9.8-17.8	2
116	003111-302	CAP SCREW	3/8"-24X2-1/2"	2
117	174783-904	LOCKING PLATE - R		1
118	924851-001	CHIP HOOD ASSEMBLY	6"	1
119	006002-032	FLAT WASHER	6.6-13X1.0	4
120	000304-203	PAN HEAD SCREW	M6-1.0X12	4
122	901269-000	MOTOR ASSEMBLY	1.5HP/115V/230V/60HZ/1P H PREWIRED 115V	1
123	250036-615	DUST CHUTE		1
124	174933-196	STAND		1
125	174795-196	PULLEY COVER		1
126	170445-196	COVER		1
127	000403-104	FLAT HEAD PHILLIPS SCREW	M6-1.0X20	4
128	000104-106	CAP SCREW	M8-1.25X20	2
128	000104-106	CAP SCREW	M8-1.25X20	4
129	174695-902	HOOK		2
130	950868-001	CONTROL BOX ASSEMBLY	LAGUNA-QUADTEC I (110-120V)	1
130.1	174936-000	CONTROL BOX	LAGUNA	1
130.2	575554-000	SWITCH PLATE	LAGUNA-QUADTEC I	1
130.3	491153-000	EMERGENCY STOP SWITCH	NPB22-H01R	1
130.4	491223-000	POWER SWITCH	M22DP-SF11W	1
130.5	491186-000	CONTACTOR	SF20C2A (110-120V)	1
130.6	300117-909	SWITCH GUARD		2

REF NO	PART NUMBER	DESCRIPTION	SPECIFICATION	QTY
130.7	000301-101	PAN HEAD SCREW	M3-0.5X6	4
130.8	000804-101	ROUND HEAD HEX. SCREW	M5*0.8P*8	4
130.6	001601-101	ROUND HEAD PHILLIPS SCREW W/WASHER	M4*0.7P*8/4*10*0.8T	4
130.10	008103-100	HEX. CUP NUT	M4*0.7P	4
130.11	000302-101	PAN HEAD SCREW	M4*0.7P*6	1
130.12	006501-100	TEETH WASHER	4.3*8.5(BW-4)	1
130.13	570695-000	GROUNDING LABEL		1
130.14	020005-000	STRAIN RELIEF	SB8R-3	2
130.15	473003-068	CONNECT CORD	SJT 14AWG*3C*2100MM	1
130.16	020008-000	STRAIN RELIEF	SBR5-2	1
130.17	453011-048	POWER CORD	SJT 14AWG*3C*3400MM	1
130.18	471001-001	CONNECT CORD	18AWG*1C*85MM	2
130.19	471037-109	CONNECT CORD	18AWG*1C*200MM	1
130.20	471037-110	CONNECT CORD	18AWG*1C*200MM	2
130.21	472001-056	CONNECT CORD	SJT 18AWG*2C*2000MM	1
133	003801-107	CARRIAGE BOLT	5/16-18X3/4"	4
134	006001-053	FLAT WASHER	8.5-19X2.0	4
135	014367-000	POLY-V-BELT	320J-6	1
136	250035-629	PUSH BLOCK		2
139	925093-001	EXTENSION ROLLER ASSEMBLY	6"	1
140	010208-000	RETAINING RING	ETW-12	2
141	361435-902	EXTENSION ROD		2
142	000103-103	CAP SCREW	M6-1.0X12	8
143	130405-903	BUSHING BLOCK		4
144	250705-000	WING SCREW	M6-1.0P	2
145	000003-104	HEX SCREW	M8-1.25X20	2
146	174792-196	FRONT COVER - L		1
147	006001-069	FLAT WASHER	10X20X3.0	1
148	008301-200	LOCK NUT	M4-0.7 (7BX5H)	4
149	491101-000	LIMIT SWITCH	MJ2-1307	2
150	280274-000	SPRING		2
151	490229-615	COVER FOR LIMIT SWITCH		2
152	471037-103	CONNECT CORD	18AWG/1C/700MM	1
153	174955-904	LIMITED PLATE		1
154	020005-000	STRAIN RELIEF	SB8R-3	1
155	020008-000	STRAIN RELIEF	SBR5-2	1
157	340007-615	BLOCK		5
158	000101-110	CAP SCREW	M4-0.7X30	4
160	174934-156	EMERGENCY STOP PLATE		1
161	009102-100	LOCK NUT	3/8"-16	4
162	250400-000	WHEEL		4

REF NO	PART NUMBER	DESCRIPTION	SPECIFICATION	QTY
163	003005-106	HEX SCREW	3/8"-16X2-1/2"	4
164	004001-101	KNOB		2
171	040003-000	HEX WRENCH	3MM	1
172	040006-000	HEX WRENCH	6MM	1
173	040201-000	OPEN WRENCH	8/10	1
174	040203-000	OPEN WRENCH	11/13	1
191	174932-000	LIMIT SWITCH BRACKET		2
192	002401-101	ROUND HEAD PHILLIPS LOCK SCREW W/WASHER	M4-0.7X12/4-10X0.8	4
193	040203-000	OPEN WRENCH	11/13MM	1

JX8 Quadtec:| Parts

Cutterhead & Drivetrain

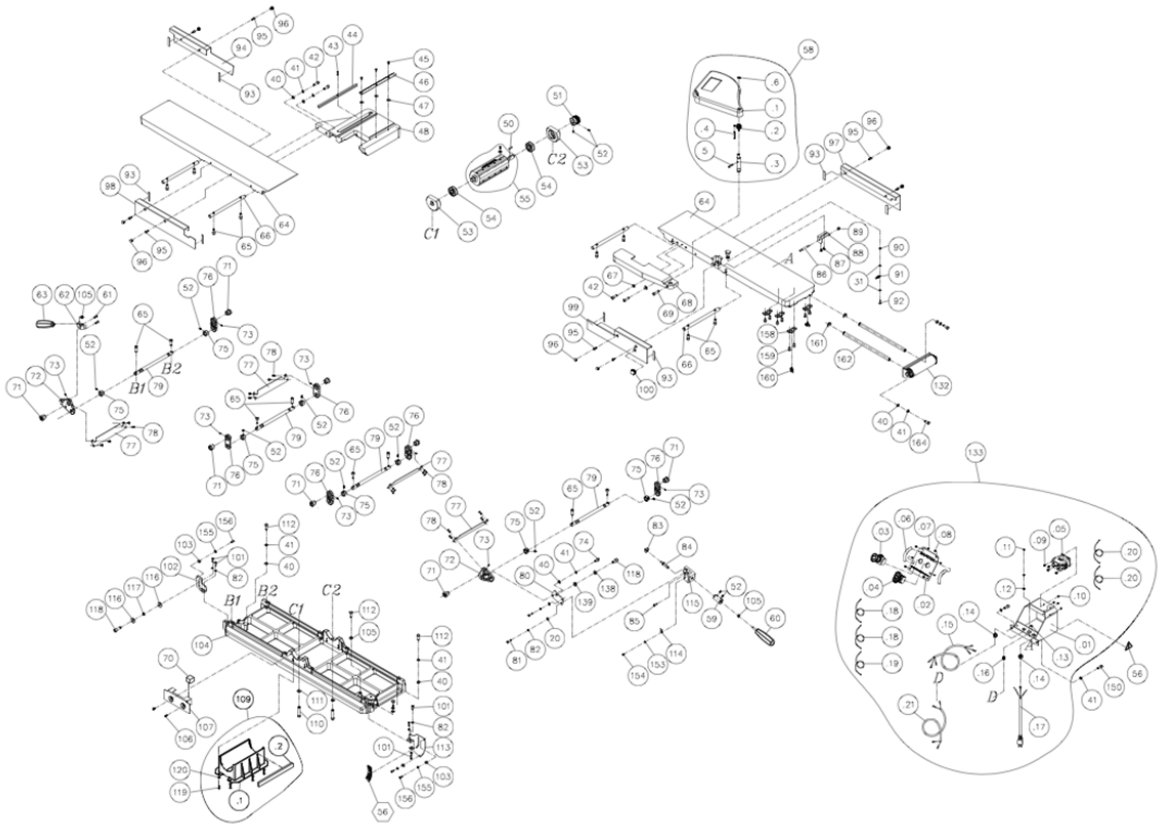

Fence

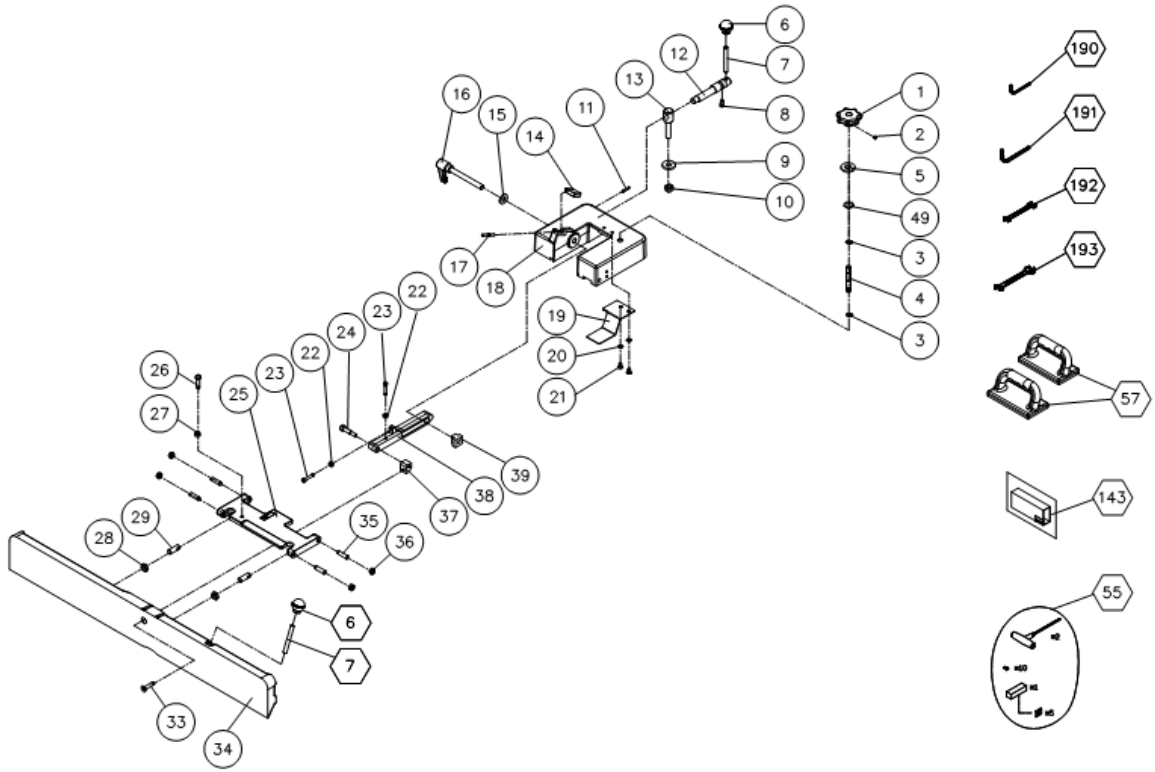

Stand & Motor

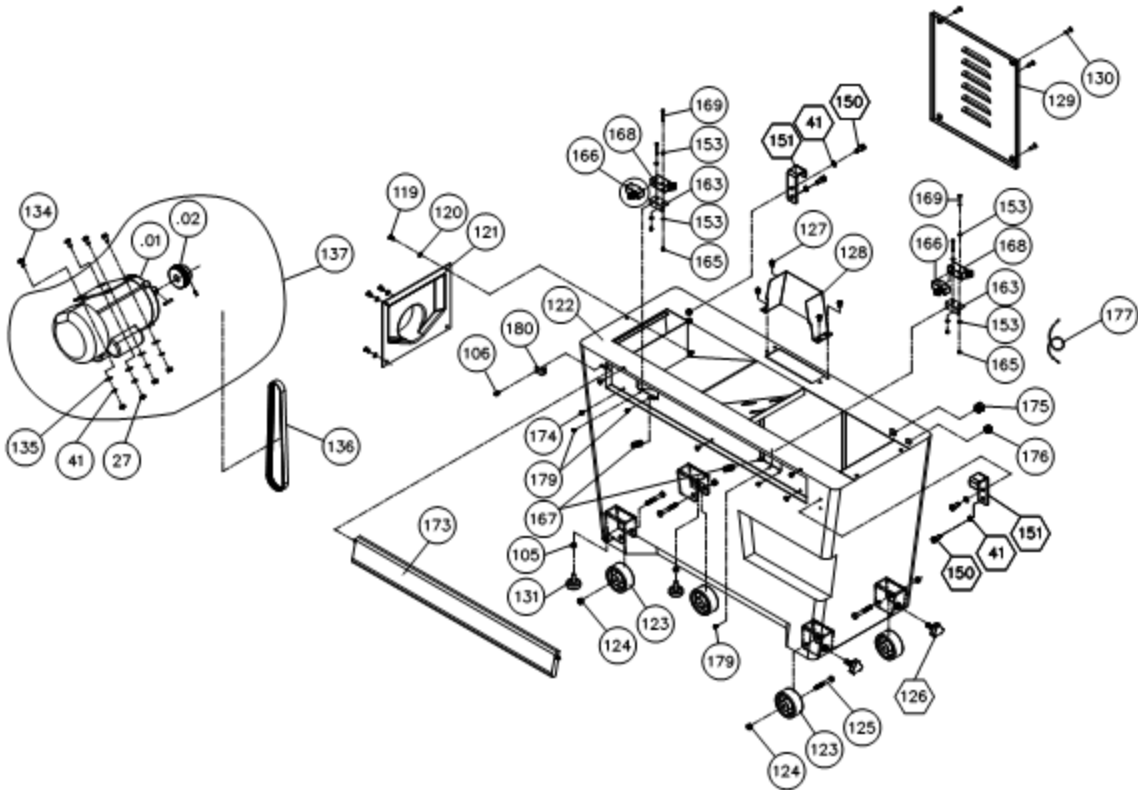

REF NO	PART NUMBER	DESCRIPTION	SPECIFICATION	QTY
1	240080-904	HANDWHEEL		1
2	001902-109	SET LOCK SCREW	M6-1.0X6	1
3	010003-000	RETAINING RING	STW-12	2
4	381336-901	LEAD SCREW		1
5	006001-087	FLAT WASHER	12-25X1.5	1
6	250372-615	FENCE TILT KNOB		2
7	360038-901	HANDLE ROD		2
8	003103-102	CAP SCREW	1/4"-20X1/2"	1
9	172285-905	FLAT WASHER	13-35X5.0	1
10	009104-200	LOCK NUT	1/2"-12 (19BX15H)	1
11	011002-106	SPRING PIN	4X25	1
12	360074-901	CRANKSHAFT		1
13	360075-901	CLAMPING SCREW		1
14	130019-903	STOP PLATE		1
15	006001-091	FLAT WASHER	13-28X3.0	1
16	230035-000	UNIVERSAL HANDLE		1
17	360078-000	PIN		1

REF NO	PART NUMBER	DESCRIPTION	SPECIFICATION	QTY
18	051332-196	FENCE BRACKET - UPPER		1
19	170127-901	SAFETY PLATE		1
20	006001-032	FLAT WASHER	6.6-13X1.0	4
21	003403-102	FLAT HEAD PHILLIPS SCREW	1/4"-20X1/2"	2
22	009004-200	HEX NUT	1/4-20 (11BX5.5H)	2
23	003103-104	CAP SCREW	1/4"-20X1-1/4"	2
24	290007-901	BOLT		1
25	051313-196	TILT PLATE		1
26	003003-106	HEX SCREW	5/16"-18X1-1/4"	1
27	009005-200	HEX NUT	5/16-18 (12.7BX6.75H)	3
28	009010-100	HEX NUT	1/2"-20 (19.05BX6.35H)	2
29	360676-901	STUD PIVOT		2
31	006001-009	FLAT WASHER	5.2-10X1.0	2
33	003602-101	FLAT HEAD HEX SCREW	5/16"-18X1-1/2"	1
34	051310-196	FENCE		1
35	230015-901	BOLT		4
36	009022-100	HEX NUT	3/8"-16 (13.83BX6.68H)	4
37	130008-903	CONNECT BLOCK		1
38	051334-196	FIXING ROD		1
39	130383-903	SQUARE NUT	1/2"-12	1
40	006001-049	FLAT WASHER	8.5-16X2.0	8
41	006305-100	LOCK WASHER	8.2-13.7	12
42	000104-108	CAP SCREW	M8-1.25X25	4
43	011002-105	SPRING PIN	4X20	1
44	380082-902	KEY		1
45	000701-103	FLAT HEAD HEX SCREW	M5-0.8X12	3
46	171841-902	LEAD SCREW		1
41	006305-100	LOCK WASHER	8.2-13.7	4
47	006001-034	FLAT WASHER	6.7-16X2.0	3
48	051355-196	FENCE BRACKET		1
49	006722-100	WAVE WASHER	WW-19 (19.05X26)	1
50	012003-008	KEY	5X5X22	1
51	381409-902	PULLEY	7 SLOTS	1
52	001902-102	SET LOCK SCREW	M6-1.0X8	11
53	050095-901	BEARING HOUSING		2
54	030208-002	BALL BEARING	6204	2
55	925137-001	SEGMENTED CUTTERHEAD	4 SLOTS	1
	038201-101	TORX SCREW	#10-32X1/2"	20
	040710-000	TORX WRENCH	T-25	1
	925135-001	KNIFE INSERT	10PCS/BOX	12
57	250035-629	PUSH BLOCK		2
58	924821-001	CUTTERHEAD GUARD ASSEMBLY		1

REF NO	PART NUMBER	DESCRIPTION	SPECIFICATION	QTY
59	381428-902	BUSHING		1
60	230191-000	MITER GAUGE HANDLE		1
61	000102-104	CAP SCREW	M5-0.8X12	2
62	174786-904	PLATE		1
63	230141-615	HANDLE		1
64	051460-197	TABLE	LAGUNA	2
65	002601-107	CAP LOCK SCREW	M8-1.25X25	16
66	361239-902	SUPPORT SHAFT		4
67	006001-163	FLAT WASHER	8.5-19X3	2
68	051358-197	RABBET ARM		1
69	003104-104	CAP SCREW	5/16"-18X1"	1
70	200105-615	SPONGE	30X30X22 (LXWXH)	1
71	130350-903	BUSHING		8
72	130351-903	CONNECTING ROD PLATE		2
73	001901-102	SET LOCK SCREW	M5-0.8X8	8
74	000104-104	CAP SCREW	M8-1.25X16	1
75	361241-902	BUSHING		8
76	130352-903	ROD PLATE		6
77	174604-000	FIXING ROD PLATE		4
78	002603-101	CAP LOCK SCREW	M5-0.8X10	16
79	361326-902	ROD		4
80	174784-904	FIXING PLATE		1
81	000103-108	CAP SCREW	M6-1.0X25	2
82	006303-100	LOCK WASHER	6.5-10.5	7
83	130393-903	INCLINED BLOCK		1
84	361370-902	HANDLE SHAFT BOLT		1
85	002602-101	CAP LOCK SCREW	M6-1.0X12	1
86	361327-902	HANDLE SHAFT BOLT		1
87	290028-901	SHOULDER SCREW		2
88	174603-902	FIXING PLATE		1
89	009103-100	LOCK NUT	1/4-20 (11BX8H)	1
90	008004-100	HEX NUT	M5-0.8 (8BX4H)	1
91	280082-000	TENSION SPRING		1
92	000102-116	CAP SCREW	M5-0.8X15	1
93	200024-615	PACKING		8
94	174600-196	REAR BASE COVER - L		1
95	000103-102	CAP SCREW	M6-1.0X10	8
96	042505-000	CORD PLUG	HP-13	8
97	174601-196	REAR BASE COVER - R		1
98	174599-196	FRONT COVER - L		1
99	174781-196	FRONT COVER - R		1
100	230156-615	KNOB PLUNGER	22X1/4"-20	1

REF NO	PART NUMBER	DESCRIPTION	SPECIFICATION	QTY
101	000103-105	CAP SCREW	M6-1.0X15	5
102	174787-904	LOCKING PLATE - L		1
103	174785-904	FIXING PLATE		3
104	051441-196	BASE		1
105	008006-100	HEX NUT	M8-1.25 (13BX6.5H)	5
106	000801-101	ROUND HEAD HEX SCREW	M6-1.0X10	3
107	174597-196	CUTTERHEAD FRONT COVER		1
109	924665-001	CHIP HOOD ASSEMBLY		1
110	003111-301	CAP SCREW	3/8-24X2"	2
111	006306-100	LOCK WASHER	9.8-17.8	2
112	000003-105	HEX SCREW	M8-1.25X25	4
113	174783-904	LOCKING PLATE - R		1
114	174782-156	POINTER		1
115	310548-911	FIXED BLOCK		1
116	006003-080	FLAT WASHER	10.5-23X3.0	2
117	006703-100	WAVE WASHER	WW-10	1
118	000105-101	CAP SCREW	M10-1.5X20	2
119	000304-203	PAN HEAD SCREW	M6-1.0X12	8
120	006002-032	FLAT WASHER	6.6-13X1.0	8
121	250052-615	DUST CHUTE		1
122	174937-196	STAND		1
123	250399-615	WHEEL		4
124	008306-100	LOCK NUT	M8-1.25 (13BX9H)	4
125	000003-313	HEX SCREW	M8-1.25X60	4
126	230388-000	TRIANGLE KNOB		2
127	001603-102	ROUND HEAD PHILLIPS SCREW W/WASHER	M6-1.0X10/6-13.2X1.0	4
128	174595-196	PULLEY COVER		1
129	170445-196	COVER		1
130	000403-104	FLAT HEAD PHILLIPS SCREW	M6-1.0X20	4
131	230049-000	FOOT		2
132	925094-001	EXTENSION ROLLER ASSEMBLY	8"	1
133	950867-001	CONTROL BOX ASSEMBLY	110-120V	1
133.1	174936-000	CONTROL BOX		1
133.2	575554-000	SWITCH PLATE		1
133.3	491153-000	EMERGENCY STOP SWITCH	NPB22-H01R	1
133.1	491223-000	POWER SWITCH	M22DP-SF11WB	1
133.5	491186-000	CONTACTOR	SF20C2A (110-120V)	1
133.6	300117-909	SWITCH GUARD		2
133.7	000301-101	PAN HEAD SCREW	M3-0.5X6	4
133.8	000804-101	ROUND HEAD HEX SCREW	M5-0.8X8	4

REF NO	PART NUMBER	DESCRIPTION	SPECIFICATION	QTY
133.9	001601-101	ROUND HEAD PHILLIPS SCREW W/WASHER	M4-0.7X8/4-10X0.8	4
133.10	008103-100	HEX CUP NUT	M4-0.7	4
133.11	000302-101	PAN HEAD SCREW	M4-0.7X6	1
133.12	006501-100	INT. TOOTH WASHER	4.3-8.5 (BW-4)	1
133.13	570695-000	GROUNDING LABEL		1
133.14	020005-000	STRAIN RELIEF	SB8R-3	2
133.15	473003-067	CONNECT CORD	SJT 14AWG/3C/1400MM	1
133.16	020008-000	STRAIN RELIEF	SBR5-2	1
133.17	453011-048	POWER CORD	SJT 14AWG/3C/3400MM W/PLUG	1
133.18	471001-001	CONNECT CORD	18AWG/1C/85MM	2
133.19	471037-109	CONNECT CORD	18AWG/1C/200MM	1
133.20	471037-110	CONNECT CORD	18AWG/1C/200MM	2
133.21	472001-054	CONNECT CORD	SJT 18AWG*2C*1500MM	1
134	003801-107	CARRIAGE BOLT	5/16-18X3/4"	4
135	006001-053	FLAT WASHER	8.5-19X2.0	4
136	014361-000	POLY-V-BELT	300J-7	1
137	901336-001	MOTOR ASSEMBLY	1.75HP/115V/230V/60HZ/1 PH PREWIRED 115V	1
1	960044-001	MOTOR ASSEMBLY	1.75HP/115V/230V/60HZ/1 PH	1
2	381410-902	MOTOR PULLEY	7 SLOTS	1
3	001902-102	SET LOCK SCREW	M6-1.0X8	1
138	006307-100	LOCK WASHER	10.2-18.5	1
139	006001-069	FLAT WASHER	10-20X3.0	1
150	000104-106	CAP SCREW	M8-1.25X20	2
150	000104-106	CAP SCREW	M8-1.25X20	4
151	174695-902	HOOK		2
153	006001-001	FLAT WASHER	4.3-10X1.0	9
154	000302-101	PAN HEAD SCREW	M4-0.7X6	1
155	006502-100	INT. TOOTH WASHER	5.3-10 (BW-5)	3
156	000102-103	CAP SCREW	M5-0.8X10	6
158	130405-903	BUSHING BLOCK		4
159	000103-103	CAP SCREW	M6-1.0X12	8
160	250705-000	WING SCREW	M6-1.0	2
161	010208-000	RETAINING RING	ETW-12	2
162	361435-902	EXTENSION ROD		2
163	174932-000	LIMIT SWITCH BRACKET		2
164	000003-104	HEX SCREW	M8-1.25X20	2
165	008301-200	LOCK NUT	M4-0.7 (7BX5H)	4
166	491101-000	LIMIT SWITCH	MJ2-1307	2
167	280274-000	SPRING		2

REF NO	PART NUMBER	DESCRIPTION	SPECIFICATION	QTY
168	490229-615	LIMIT SWITCH COVER	KSSCB-2	2
169	000101-110	CAP SCREW	M4-0.7X30	4
173	174939-156	EMERGENCY STOP PLATE		1
174	340007-615	BLOCK		5
175	020005-000	STRAIN RELIEF	SB8R-3	1
176	020008-000	STRAIN RELIEF	SBR5-2	1
177	471037-103	CONNECT CORD	18AWG/1C/700MM	1
179	002401-101	ROUND HEAD PHILLIPS LOCK SCREW W/WASHER	M4-0.7X12/4-10X0.8	4
180	174955-904	LIMITED PLATE		1
190	040003-000	HEX WRENCH	3MM	1
191	040006-000	HEX WRENCH	6MM	1
192	040201-000	OPEN WRENCH	8/10MM	1
193	040203-000	OPEN WRENCH	11/13MM	1

Warranty

This machine is covered by a warranty and the purchasing dealer can answer any questions you may have. Additionally, you can contact Laguna: +1 (949) 474-1200 customerservice@lagunatools.com.

Every product sold is warranted to be free of manufacturers' defective workmanship, parts, and materials. For any questions about this product, the intended use or what it was designed for, customer service, or replacement parts – please reach out to our customer service department.

REGISTRATION

TO PREVENT VOIDING THIS WARRANTY, ALL PRODUCTS SOLD MUST BE REGISTERED WITHIN THIRTY (30) DAYS OF RECEIVING. REGISTERING THE PRODUCT WILL ENABLE THE ORIGINAL PURCHASER TO RECEIVE NOTIFICATIONS ABOUT IMPORTANT PRODUCT CHANGES AND RECEIVE CUSTOMER SUPPORT.

[HTTPS://LAGUNATOOLS.COM/POLICIES/WARRANTY/](https://lagunatools.com/policies/warranty/)

WHAT IS COVERED?

ANY PART, DETERMINED BY LAGUNA TOOLS®, TO HAVE A DEFECT WILL BE REPAIRED OR REPLACED (AND SHIPPED), WITHOUT CHARGE. IT IS REQUIRED THAT THE DEFECTIVE ITEM/PART BE RETURNED TO LAGUNA TOOLS® WITH THE COMPLAINT AND PROOF OF PURCHASE IN THE ORIGINAL PACKAGING THAT IT WAS RECEIVED. IN THE EVENT THE ITEM/PART IS DETERMINED TO BE VOID OF THIS WARRANTY, THE CUSTOMER WILL BE RESPONSIBLE FOR THE COST TO REPLACE THE ITEM/PART AND ALL RELATED SHIPPING CHARGES.

WHO IS COVERED?

THE APPLICABLE WARRANTY COVERS ONLY THE INITIAL PURCHASER OF THE PRODUCT FROM THE RECEIPT DATE. THE ORIGINAL PURCHASER MUST PRESENT THE ORIGINAL RECEIPT AS PROOF OF PURCHASE.

SHIPPING DAMAGE

LAGUNA TOOLS® AND THE PURCHASING CUSTOMER IS NOT RESPONSIBLE FOR DAMAGE OR LOSS CAUSED BY A FREIGHT COMPANY OR OTHER CIRCUMSTANCES NOT IN THE DIRECT CONTROL OF LAGUNA TOOLS®. ALL SHIPPING RELATED CLAIMS FOR LOSS OR DAMAGED GOODS MUST BE MADE TO LAGUNA TOOLS WITHIN TWENTY-FOUR HOURS OF DELIVERY.

WARRANTY LIMITATIONS

THIS LIMITED WARRANTY DOES NOT APPLY TO NATURAL DISASTERS, ACTS OF TERRORISM, NORMAL WEAR AND TEAR, PRODUCT FAILURE DUE TO LACK OF MAINTENANCE OR CLEANING, DAMAGE CAUSED BY ACCIDENT, NEGLIGENCE, OR LACK-OF/INADEQUATE DUST COLLECTION. THE WARRANTY MAY BE VOIDED AGAINST PROOF OF MISUSE/ABUSE, DAMAGE CAUSED WHERE REPAIR OR ALTERATIONS HAVE BEEN MADE OR ATTEMPTED BY OTHERS, USING THE PRODUCT FOR PURPOSES OTHER THAN THOSE DESCRIBED AS INTENDED USE (UNLESS WITH CONSENT BY LAGUNA TOOLS®), MODIFICATION TO THE PRODUCT, OR USE WITH AN ACCESSORY THAT WAS NOT DESIGNED FOR THE PRODUCT. IT IS THE RESPONSIBILITY OF THE USER TO UNDERSTAND BASIC WOODWORKING MACHINERY SETTINGS AND PROCEDURES AND TO PROPERLY MAINTAIN THE EQUIPMENT IN ACCORDANCE WITH THE STANDARDS PROVIDED IN THIS MANUAL.

LENGTH OF WARRANTY

ASIDE FROM BEING FREE OF DEFECTS UPON RECEIVING, CONSUMABLE PARTS, LIKE CUTTERS AND ABRASIVES, ARE NOT COVERED BY THIS WARRANTY UNLESS OTHERWISE STATED BY LAGUNA TOOLS®. THESE PARTS ARE DESIGNED TO BE USED AT THE EXPENSE OF THE OPERATOR AND ARE AVAILABLE FOR REPLACEMENT OR INVENTORY PURCHASE.

2 YEAR – NEW PURCHASES THROUGH AUTHORIZED DEALERS.

1 YEAR – NEW PURCHASES DIRECTLY FROM LAGUNA TOOLS.

1 YEAR – BLADES AND ACCESSORIES



LAGUNA AMERICAN HEADQUARTERS

Texas: 744 Refuge Way Suite 200, Grand Prairie, Texas 75050, U.S.A. Phone: +1-800-332-4094
Huntington Beach: 7291 Heil Ave Huntington Beach, CA 92647, U.S.A. Phone: +1-949-474-1200
South Carolina: 825 Bistline Dr. Ste 101, West Columbia, SC 29172, U.S.A. Phone: +1-800-234-1976
Minnesota: 5250 West 74th St, Edina, MN 55439, U.S.A Phone: +1-949-474-1200

DAKE CORPORATION

724 Robbins Road, Grand Haven, MI 49417, United States +1-800-937-3253

LAGUNA EUROPE

Walker Rd, Bardon Hill, Coalville LE67 1TU, United Kingdom. Phone: +44-1530-516921

© 2021 Laguna Tools