



ROCCBOX



GAS BURNER
USER MANUAL

DANGER

If you smell gas:

- **Shut gas off to the appliance.**
- **Extinguish any open flame.**
- **If odour continues, keep away from the appliance and immediately call your fire department.**

This instruction manual contains important information necessary for the proper assembly and safe use of the appliance.

Read and follow all warnings and instructions before assembling and using the appliance.

Follow all warnings and instructions when using the appliance.

Keep this manual for future reference.

Never operate this appliance in enclosed areas.

Failure to follow these instructions could result in fire or explosion which could cause property damage, personal injury or death.

- **Never operate this appliance unattended.**
- **Never operate this appliance within 5ft (1.5m) of any structure, combustible material or other gas cylinder.**
- **Never operate this appliance within 25ft (7.5m) of any flammable liquid.**
- **Do not fill cooking vessel beyond the limitation of the door dimensions.**
- **Heated liquids remain at scalding temperatures long after cooking process. Never touch cooking appliance until liquids have cooled to 115°F (45°C) or less.**
- **If a fire should occur, keep away from the appliance and immediately call your fire department. Do not attempt to extinguish an oil or a grease fire with water.**

FIRE

Most fires are caused by a build up of grease, or (if using gas) an improper gas connection. Ensure all people and pets are kept as far away as possible.

If you are able, turn the gas off at the cylinder or the on/off valve where applicable. Use a fire extinguisher if possible. If water is the only fire retardant available, thoroughly soak the area around the appliance. When spraying water on the Rocbox itself, do not use a strong jet of water, as this may cause splashing of burning grease, resulting in a further spreading of the fire.

CARBON MONOXIDE

Carbon Monoxide is a highly poisonous gas which can be produced when the device isn't receiving enough ventilation. We therefore recommend using the gas and wood burners in a well ventilated area away from direct wind and to never cover the oven mouth.

It is difficult to know if your device is producing Carbon Monoxide as it is an odourless and colourless gas. It can, however cause these symptoms when you are exposed to it:

Tightness across the forehead

Headache,

Weakness,

Dizziness,

Nausea,

Vomiting,

Coma, intermittent convulsions,

Depressed heart action, slowed respiration,

If the exposure has been severe it may cause death.

Warning: Contact your local municipality for any building codes regulating the installation of outdoor barbecue appliances. Outdoor installations must conform to local codes or, in the absence of local codes, with the following:

USA: National Fuel Gas Code, ANSI Z223.1/NFPA 54

CAN: CGA: B149.1 Natural Gas & Propane Installation Code.

AUST/NZ: Australian Standards Code AS: 5601 as well as the requirements of any local council, gas electricity authority or other statutory regulation.

Spanner tighten all gas fittings as per instructions. Do not modify the appliance. Parts sealed by the manufacturer or the company shall not be manipulated.



PRODUCT INFORMATION

Roccbox Limited. Units 18 & 19, Radar Way, Christchurch, Dorset, BH23 4FL UK.			
Appliance Name		Roccbox oven	
Model/Type No.		RBX1.1	
Trade name		Roccbox	
Total nominal heat output for the gas burner		14330 BTU/HR	
Injector size		1.1mm	
Gas Type	Propane	Gas Pressure	11 "W.C.
<p>Use outdoors only.</p> <p>Read the instructions before using the appliance.</p> <p>WARNING: accessible parts may be very hot. Keep young children away.</p> <p>WARNING! Do not use spirit or petrol for lighting or re-lighting!</p>			

SETTING UP THE GAS

①

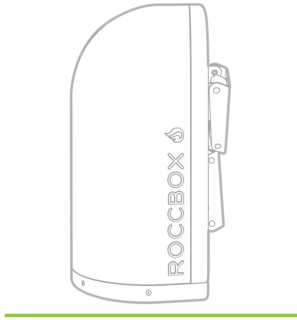

②

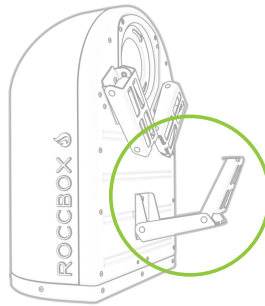

③

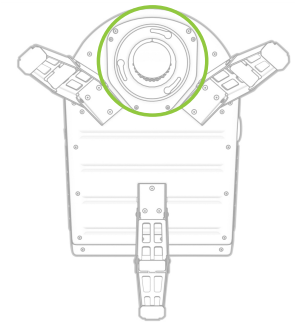

④

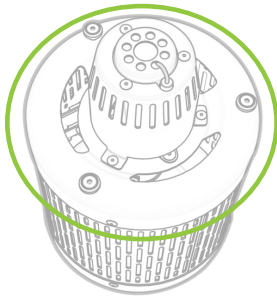

⑤

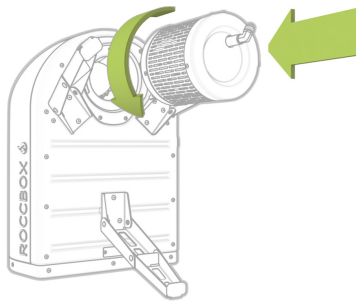

⑥

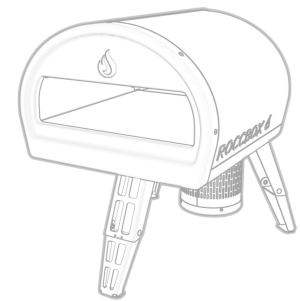

GAS SAFETY

WARNING

Prior to use, check the oven and burner and venturi for blockages (eg, food residue or insect nests - Wasps, Bees or Ants.) If an insect nest is found they can be dangerous and must be cleaned out thoroughly. Please refer to the cleaning and maintenance sections at the end of this chapter for guidance on how to do this.

Should the appliance go out for any reason, turn off the control knob and the cylinder gas valve. Wait 5 minutes before attempting to relight the appliance.

Some foods produce flammable fats and juices. Attend to an operating Rocccbox at all times. Damage caused by fat and grease fires is not covered by warranty. If a grease or fat fire should occur, immediately turn off burner knob and the gas cylinder valve until the fire is out. Remove all food from the appliance.

A leak test must be carried out prior to using the appliance for the first time and whenever the gas cylinder is refilled or whenever the gas hose and regulator have been disconnected from the gas cylinder or appliance.

Please take a moment to review all of the safety requirements before operating the appliance when using gas.

- ⚠ Do not disconnect any gas fittings while the appliance is operating.
- ⚠ Check all gas hose lines and connections for cuts, cracks and other damage.
- ⚠ Gas cylinders must not be stored in enclosed areas.
- ⚠ Keep the fuel supply hose away from heated surfaces or direct sunlight.
- ⚠ Do not use any additional flammable substance whilst operating with gas.
- ⚠ Do not touch! The Rocccbox can get extremely hot when in operation. Be sure to wear protective gloves.
- ⚠ Keep the cylinder outdoors in it's upright position.
- ⚠ Do not connect multiple gas canisters to Rocccbox or store a spare within the same vicinity.
- ⚠ A regulator which complies with EN16129 must fit between the gas canister and the oven.
- ⚠ Do not position the gas canister under the oven.
- ⚠ Never use a naked flame to check for gas leaks.
- ⚠ Do not use natural gas! It can damage the oven.
- ⚠ Maximum length of hose cannot exceed 1.5m. In Finland, hose length cannot exceed 1.2m.
- ⚠ National requirements state how often to replace the hose. Please review this for your area.
- ⚠ Never fill the cylinder beyond 80 percent full.
- ⚠ Make sure the flexible tube is not twisting when the appliance is in operation.

CONNECTING TO GAS

STEP 1 Check that the gas you have is Propane LPG.

The gas cylinder used must have a safety collar to protect the valve assembly. Do not use a cylinder that is rusty, dented or has a damaged valve.

For US & Canadian Customers

Gas cylinder, must be constructed and marked in accordance with the specifications for LP gas cylinders, U.S. Department of Transportation (DOT) or the Standard for Cylinders, Spheres and Tubes for the Transportation of Dangerous Goods, CAN/CSA-B339.



WARNING

If at any point you smell gas:
Shut off the gas from the canister, turn off the switch on the Rocbox and extinguish any open flames.
If odour continues, move away from the oven and gas supply then contact your gas supplier or fire service.



MAX: 13 kg / 29 lb.

MIN: 4kg / 9 lb.

WARNING

Ensure that the LP cylinder or regulator valve is closed.

Do not store a spare LP cylinder under or near this appliance.

CONNECTING TO GAS

STEP 2 Connect the regulator to the gas canister, following the instructions for your regulator accordingly. Don't force the regulator as this could damage the gas bottle.

PUSH FIT GAS REGULATOR

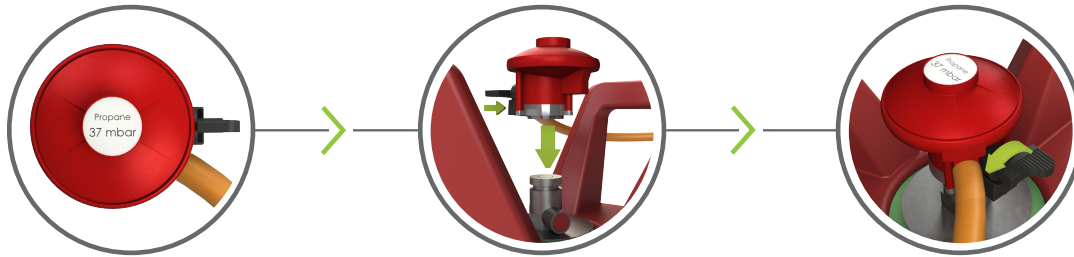

CLOCKWISE/ANTICLOCKWISE GAS REGULATOR

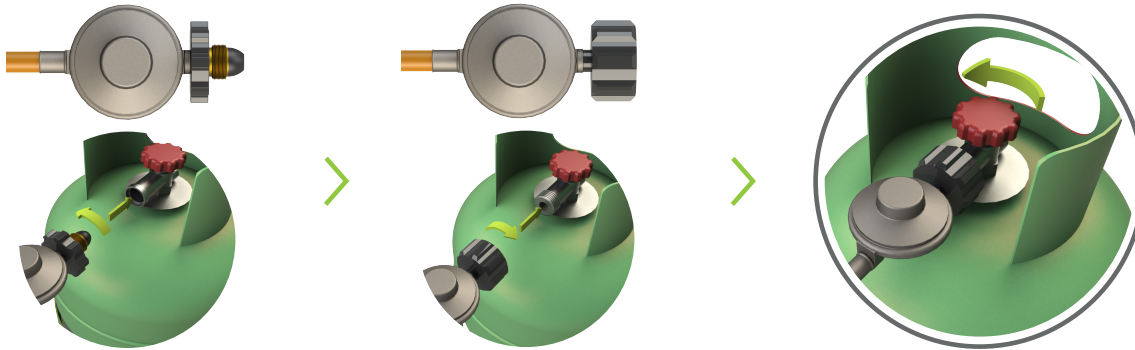

GAS LEAKS

To test for gas leaks, apply a mixture of soapy water to these highlighted areas using a brush as well as any areas that show cracks on the piping.

WARNING

Check for gas leaks every time you disconnect and reconnect a gas fitting.

Do not ignite burners when leak checking.

Do not use an open flame to check for gas leaks. Do not create sparks or have open flames in the area whilst changing gas supply.

The changing of gas canisters must be carried out away from any sources of ignition.

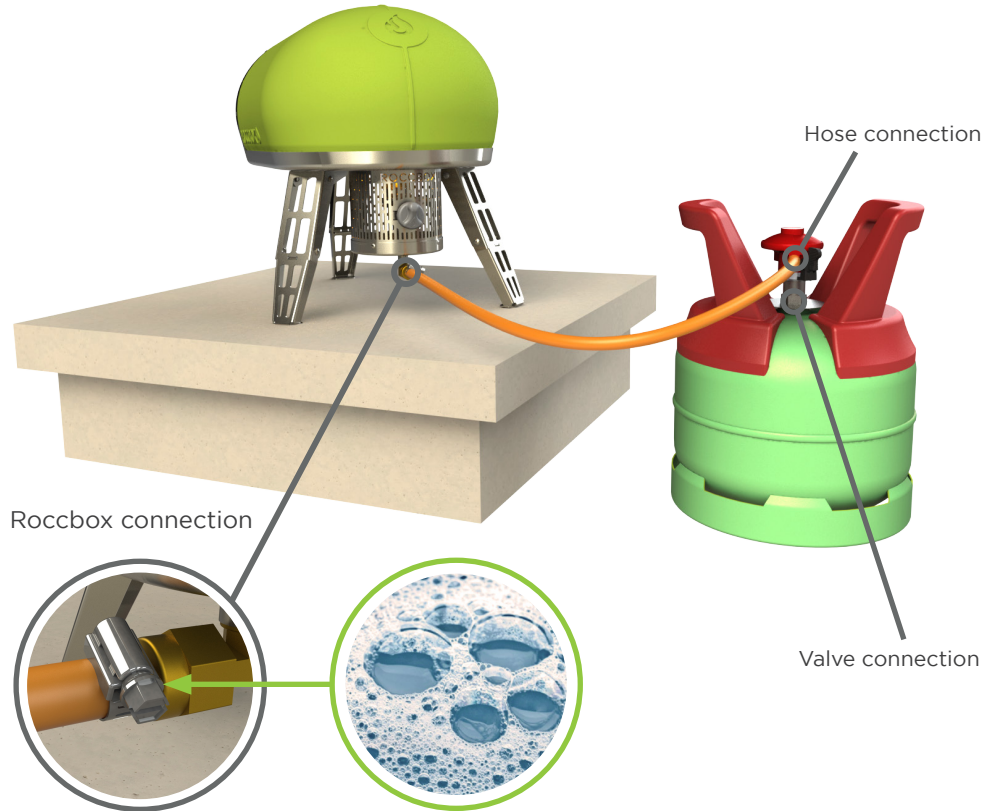

WARNING

If there is a leak at the Rocibox connection, re-tighten the fitting with a spanner and recheck for leaks with soap-and-water solution. If a leak persists turn off the gas, and DO NOT OPERATE THE OVEN.

If there is a leak at the Valve connection, remove LP cylinder. Do not operate oven. Use a different LP cylinder and recheck for leaks with soap-and-water solution.

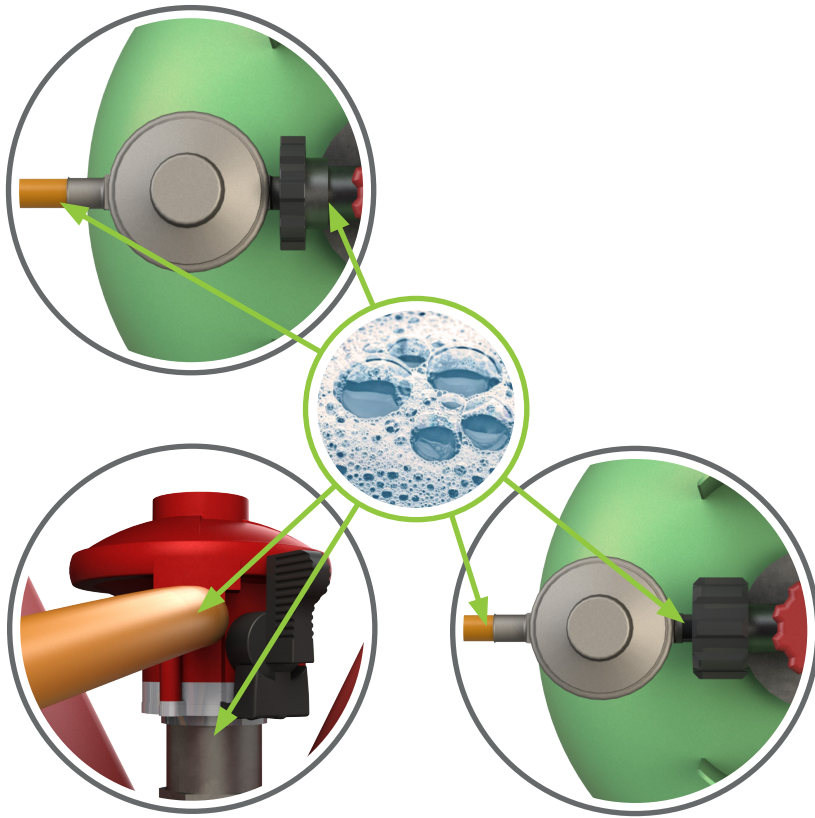

DISCONNECTING GAS

After cooking, turn off the gas from the gas canister before turning off Rocibox. This will allow any gas left in the burner or pipe to be used up safely.

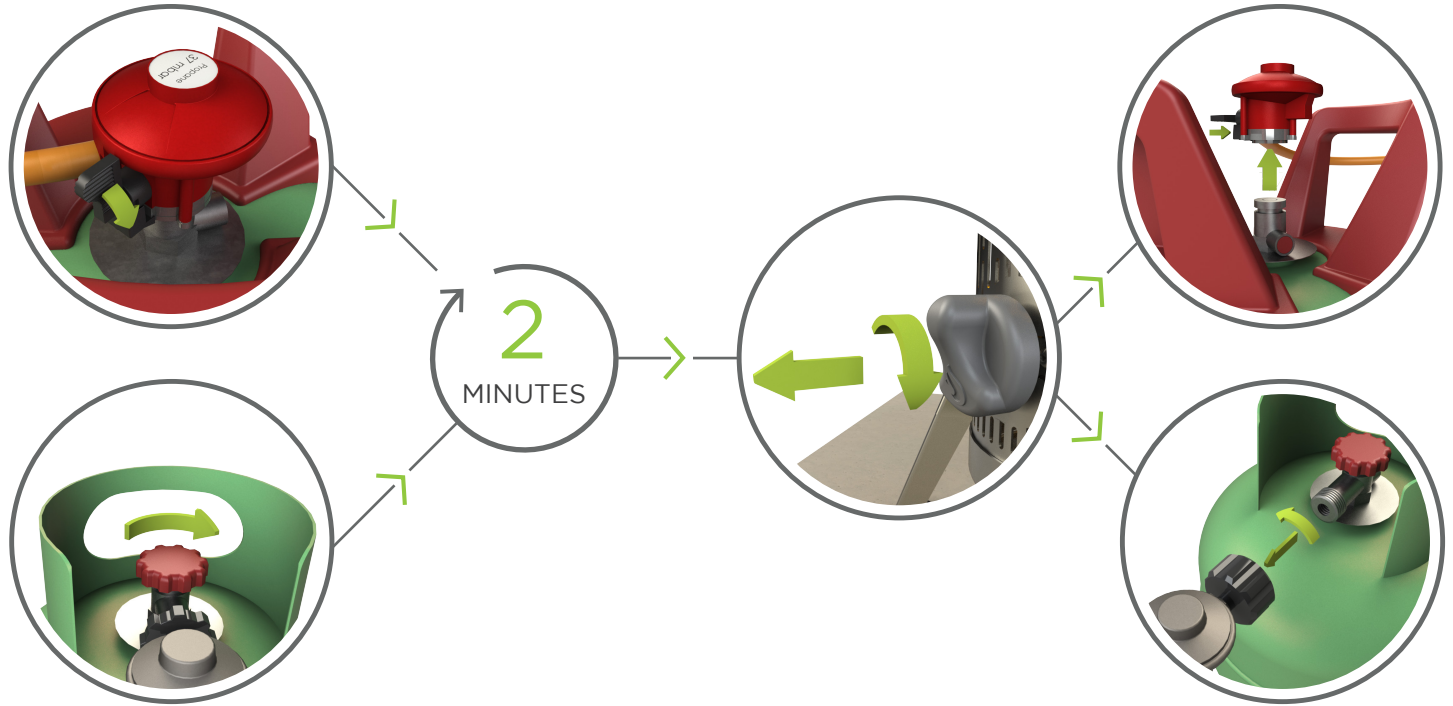

FIRST FIRING

STEP 1



STEP 2

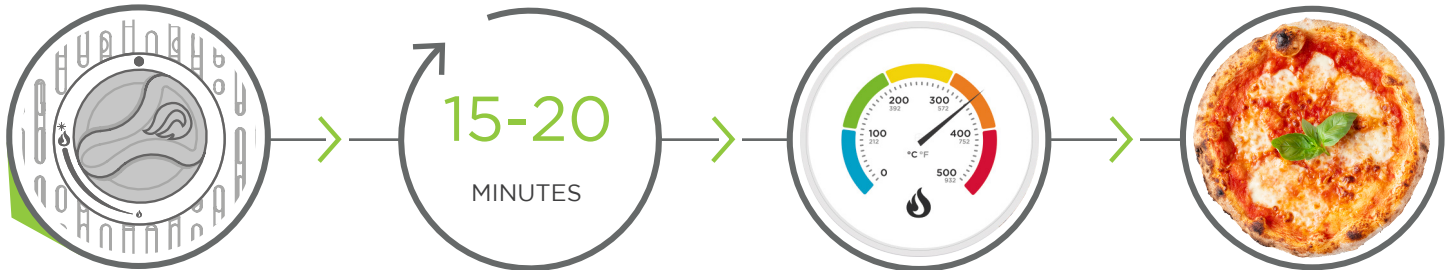

CLEANING AND MAINTENANCE

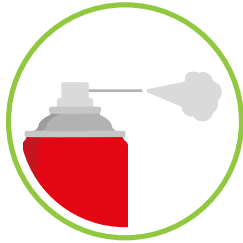

WARNING

Don't store your gas canisters in enclosed areas or in rooms below ground level.