



Inogen Rove 6™

PORTABLE OXYGEN CONCENTRATOR SYSTEM

System Catalog: IS-501
Concentrator Catalog: IO-501



USER MANUAL

ENGLISH

Rx ONLY Caution: USA Federal law restricts this device to sale by or on the order of a physician. May also be applicable in other countries.

TABLE OF CONTENTS

1. FORWARD	5
1.1 General information	5
1.2 Standards compliance	5
1.3 Typographic conventions	6
2. INTENDED USE	6
2.1 Indications for use and clinical benefit	6
2.2 Contraindications	6
2.3 Patient Population	6
3. SAFETY INSTRUCTIONS	6
3.1 Warnings	6
3.2 Cautions	8
4. INSTRUCTIONS AND TRAINING	9
5. PRODUCT DESCRIPTION	10
5.1 Schematic description	10
6. GENERAL INSTRUCTIONS BEFORE USE	11
6.1 Accessories list	12
6.2 Rechargeable battery packs (BA-500, BA-508 and BA-516)	12
6.3 Nasal cannula use steps	15
6.4 AC power supply (BA-502/BA-501)	15
6.5 DC power cord (BA-306)	16
6.6 External battery charger (BA-503, optional accessory not included)	17
7. OPERATING INSTRUCTIONS	18
7.1 Operating principals & essential performance	18
7.2 Pneumatic diagram	18
7.3. Preparing your concentrator for use	19
7.4 Using your concentrator	21
7.5 Storing your concentrator	25
7.6 Responding to alarms	25
7.7 Traveling with your concentrator	25
8. ALARM INDICATORS & DEVICE ICON GLOSSARY	26
8.1 Overview information	26

8.2 Mode icons	27
8.3 Bluetooth icons (for models with bluetooth)	27
8.4 Informational icons.....	27
8.5 Alarms.....	28
9. TROUBLESHOOTING	32
10. CLEANING, CARE AND MAINTENANCE	33
10.1 Cannula replacement.....	34
10.2 Case cleaning	34
10.3 Filter cleaning & replacement (RP-500)	34
10.4 Cannula barb and output filter replacement (RP-506)	35
10.5 DC power cord fuse replacement (RP-125)	36
10.6 Column change.....	37
10.7 Battery care and maintenance.....	40
10.8 Service life	40
11. PAIRING YOUR DEVICE WITH THE CONNECT APP	40
11.1 Pairing your device with the mobile application	41
11.2 Cybersecurity.....	43
12. DEVICE REPAIR & DISPOSAL	43
12.1 Repair.....	43
12.2 Disposal.....	43
13. LIMITED WARRANTY STATEMENT.....	44
14. TRADEMARKS AND DISCLAIMER	44
14.1. Trademark	44
14.2. Disclaimer	44
14.3. This Document.....	44
14.4. For Help.....	44
15. TECHNICAL DESCRIPTION	45
15.1 Specifications.....	45
15.2 Pulse volume flow settings	46
15.3 Electromagnetic compatibility (EMC) Information	46
16. WIRELESS COMMUNICATION SPECIFICATIONS & COMPLIANCE	49
17. SYMBOLS KEY.....	51

1. FORWARD

Please refer to this manual for detailed instructions on warnings, cautions, specifications and additional information.

Important:

- Users should read this entire manual before operating the Inogen Rove 6 Portable Oxygen Concentrator. Failure to do so could result in personal injury and/or death. If you have questions about the information in this user manual or about the safe operation of this system, contact your equipment provider.
- If, in relation to the use of this product, a death or serious deterioration of health has occurred, this should be reported to Inogen, Inc. and the competent authority of your country.

1.1 GENERAL INFORMATION

This user manual provides information for users of the Inogen Inogen Rove 6 Portable Oxygen Concentrator. For the sake of brevity, the terms “concentrator,” “POC”, “unit,” or “device” are sometimes used in this document to refer to the Inogen Rove 6 Portable Oxygen Concentrator. “Patient” and “User” are used interchangeably.

1.2 STANDARDS COMPLIANCE

This device is listed with an internationally recognized testing laboratory and classified with respect to electric shock, fire and mechanical hazards in accordance with the following standards:

- IEC 60601-1:2005+AMD1:2012, Medical electrical equipment – Part 1: General requirements for basic safety and essential performance
- IEC 60601-1-2:2014+AMD1:2020, Medical electrical equipment – Part 1-2: General safety requirements – Collateral Standard: Electromagnetic disturbances - Requirements and tests
- IEC 60601-1-8:2006+AMD1:2012, Medical electrical equipment – Part 1-8: Medical electrical equipment – Part 1-8: General requirements for basic safety and essential performance — Collateral standard: General requirements, tests and guidance for alarm systems in medical electrical equipment and medical electrical systems
- IEC 60601-1-11:2015, Medical electrical equipment – Part 1-11: General requirements for basic safety

and essential performance – Collateral standard: Requirements for medical electrical equipment and medical electrical systems used in the home healthcare environment

- IEC 60601-1-6:2010+AMD1:2013+AMD2:2020, Medical electrical equipment - Part 1-6: General requirements for basic safety and essential performance - Collateral standard: Usability
- ISO 80601-2-69:2014, Medical electrical equipment -- Part 2-69: Particular requirements for basic safety and essential performance of oxygen concentrator equipment
- ISO 80601-2-67:2014, Medical electrical equipment -- Part 2-67: Particular requirements for basic safety and essential performance of oxygen-conserving equipment
- ISO 80601-2-69:2020, Medical electrical equipment – Part 2-69: Requirements for the basic safety and essential performance of oxygen concentrator equipment
- ISO 80601-2-67:2020, Medical electrical equipment – Part 2-67: Requirements for the basic safety and essential performance of oxygen-conserving equipment
- RTCA DO-160G, Environmental Conditions and Test Procedures for Airborne Equipment
- ISO 18562-1:2017, Biocompatibility evaluation of breathing gas pathways in healthcare applications – Part 1: Evaluation and testing within a risk management process
- ISO 18562-2:2017, Biocompatibility evaluation of breathing gas pathways in healthcare applications – Part 2: Tests for emissions of particulate matter
- ISO 18562-3:2017, Biocompatibility evaluation of breathing gas pathways in healthcare applications – Part 3: Tests for emissions of volatile organic compounds (VOCs)
- IEEE/ANSI C63.27-2017, American National Standard for Evaluation of Wireless Coexistence
- Bluetooth Core Specification Version 4.2
- RED 2014/53/EU
- CAN/CSA C22.2 NO. 60601-1:14 (R2018) Medical Electrical Equipment - Part 1: General Requirements for Basic Safety and Essential Performance

(Adopted IEC 60601-1:2005, third edition, 2005-12, including amendment 1:2012, with Canadian deviations)

1.2.1 MEDICAL EQUIPMENT CLASSIFICATION

- IEC Class II Equipment
- Type BF Applied Part
- IP22 - Protected from touch by fingers and objects greater than 0.5 in (12.5 mm). Protected from dripping water less than 15 degrees from vertical.
- Not suitable for use in the presence of a flammable anesthetic mixture with air or with oxygen or nitrous oxide.
- Intended for continuous operation.

1.2.2 IT NETWORK

Important: IT-network is a system composed of wireless (Bluetooth) transmission between the device and the Inogen Connect Application.

- Connection of the device to an IT-Network could result in previously unidentified risks to patients, operators or third parties.
- Subsequent changes to the IT-network could introduce new risks and require additional analysis.
- Changes to the IT-network include:
 - Changes in the IT-network configuration
 - Connection of additional items to the IT-network
 - Disconnecting items from the IT-network
 - Updating equipment connected to the IT-network

1.3 TYPOGRAPHIC CONVENTIONS

- This user manual contains warnings, cautions, and notes to help call attention to the most important safety and operational aspects of the device. To help identify these items when they occur in the text, they are shown using the following typographical conventions:
- **WARNING:** Statements that describe serious adverse reactions and potential safety hazards.
- **CAUTION:** Statements that call attention to

information regarding any special care to be exercised by the practitioner and/or patient for the safe and effective use of the device.

- **IMPORTANT:** Statements calling attention to additional significant information about the device or a procedure.

2. INTENDED USE

The Inogen Rove 6 Portable Oxygen Concentrator provides a high concentration of supplemental oxygen to patients requiring respiratory therapy on a prescriptive basis. It may be used in the home, institution, vehicle, train, airplane, boats and other transport modalities.

2.1 INDICATIONS FOR USE AND CLINICAL BENEFIT

The Inogen Rove 6 is used on a prescriptive basis by patients requiring supplemental oxygen to increase blood oxygen saturation.

2.2 CONTRAINDICATIONS

This device is to be used as an oxygen supplement and is NOT INTENDED to be life sustaining or life supporting. ONLY use this product if the patient is capable of spontaneous breath and is able to inhale and exhale without the use of a machine.

- DO NOT use in conjunction with flammable anesthetic or flammable materials.
- DO NOT use this device in tracheotomized patients.
- DO NOT use this device in persons whose breathing during normal resting is unable to trigger the device.

2.3 PATIENT POPULATION

Adults only. Prescription Required.

3. SAFETY INSTRUCTIONS

To ensure the safe installation, assembly and operation of the concentrator these instructions MUST be followed. The patient is the intended operator of the device.

3.1 WARNING

Risk of injury or damage

- Do not use in conjunction with a humidifier,

nebulizer or CPAP, or connected with any other equipment. Doing so may impair performance and/or damage the equipment.

- The Rove 6 is MR Unsafe. Do not expose to MRI equipment or other devices that generate strong magnetic fields (for example, x-ray, CT scan, or other types of radiation).
- Use of this device has not been studied in pediatric populations. Consult your physician before using the product for pediatric patients.
- Use of this product outside of the intended use and specifications has not been tested and may lead to product damage, loss of product function, or personal injury.
- Do not use this product in any way other than described in the specifications and intended use sections of this manual.
- Do not modify the device. Any modifications performed on the equipment may impair performance or damage equipment and will void your warranty unless indicated or instructed to do so.
- Do not perform service or maintenance on the device while it is in use.
- It is the responsibility of the patient to have an alternate source of oxygen in case of power outage or mechanical failure. This should be assessed upon starting oxygen therapy and be based on the patient's condition, environmental living conditions and the ability of the patient to be resupplied with backup supplies of supplementary oxygen. These attributes should be periodically reassessed as the patient's conditions change.
- It is the responsibility of the patient to plan for a back-up oxygen supply when traveling; Inogen assumes no liability for any disruptions in oxygen supply if a backup source is not secured.
- If you feel ill or uncomfortable, or if the concentrator does not signal an oxygen pulse and you are unable to hear and/or feel the oxygen pulse, consult your equipment provider and/or your physician IMMEDIATELY.
- If you are unable to communicate discomfort, you may require additional monitoring and or

a distributed alarm system to convey the information about the discomfort and or the medical urgency to your responsible caregiver to avoid harm.

- This device produces enriched oxygen gas, which accelerates combustion. Do not allow smoking or open flames within 2m (6.56ft) of this device while in use. Smoking during oxygen therapy is dangerous and is likely to result in facial burns or death. If you smoke, you must always turn the oxygen concentrator off, remove the cannula and leave the room where either the cannula or the oxygen concentrator is located. If unable to leave the room, you must wait 10 minutes after the flow of oxygen has been stopped.
- Oxygen is flammable. Do not leave the nasal cannula on bed coverings or chair cushions. Turn the oxygen concentrator off when not in use.
- Avoid use of the device in the presence of pollutants, smoke, or fumes. Do not use the device in the presence of flammable anesthetics, cleaning agents or other chemical vapors. Do not use aerosol sprays around the device.
- Do not use power supplies, power cables or accessories other than those specified in this user manual. The use of nonspecified power supplies, power cables or accessories may create a safety hazard and/or impair equipment performance.
- Do not use oil, grease, or petroleum-based products on or near the device, on your face or upper chest to avoid the risk of fires and burns. Use only water-based lotions or salves that are oxygen-compatible during setup or use during oxygen therapy.
- Do not lubricate fittings, connections, tubing, or other accessories of the oxygen concentrator to avoid the risk of fire and burns.
- To avoid danger of choking or strangulation hazard, keep cords away from children and pets.
- It is the responsibility of the patient to use only parts and accessories mentioned in these instructions for use. Parts and accessories used by the patient not recommended in these instructions for use are at the sole responsibility for the patient. Inogen assumes no liability for use of

parts and accessories not mentioned in these instructions for use.

- It is the responsibility of the patient to periodically check the battery and replace as necessary per these instructions for use. Inogen assumes no liability for persons choosing not to adhere to manufacturer recommendations.
- To ensure you are receiving the therapeutic amount of oxygen according to your medical condition, the device must (1) be used only after one or more settings have been individually determined or prescribed for you at your specific activity levels, (2) be used with the specific combination of parts and accessories that are in line with the specification of the concentrator manufacturer and that were used while your settings were determined.
- The settings of other models or brands of oxygen therapy equipment may not correspond with the settings of this device.
- The settings of this device may not correspond with the settings for devices that provide a continuous flow oxygen.
- Use of this device at an altitude above 3,048 m (10,000 ft) or outside the temperature range of 5 – 40°C (41 – 104° F) or a relative humidity above 95% is expected to adversely affect the flowrate and the percentage of oxygen and consequently the quality of the oxygen therapy. Use of this device immediately after storage in temperatures beyond the allowable operating range may adversely affect operation of the device until the temperature returns to the allowable operating range. Wind or strong drafts can adversely affect the accurate delivery of oxygen therapy.
- If the device fails, it will cause a return to your previous condition prior to starting oxygen therapy. This state will be different for each individual patient.
- The proper placement and positioning of the nasal cannula in the nose is critical to the consistent operation of this equipment.
- Do not use this device in conjunction with a humidifier, nebulizer, or CPAP, or in parallel or series with other oxygen concentrators or

oxygen therapy devices. Doing so may impair the performance and could damage the equipment.

3.2 CAUTION!

Risk of minor injury or discomfort

- The device, parts and accessories are specified for use at flow rates between setting 1 and setting 6.
- Incompatible parts and accessories can result in degraded performance or damage and may void your warranty.
- The device is designed to provide a flow of high purity oxygen. An advisory alert, "Oxygen Low", will inform you if oxygen concentration drops. If alarm persists, contact your equipment provider.
- The oxygen flow setting must be determined and recorded for each patient individually by the prescriber, including the configuration of the device, its parts and the accessories. It is the responsibility of the patient to periodically reassess the setting(s) of the therapy for effectiveness.
- Do not modify the device. Any modifications performed on the equipment may impair performance or damage equipment and will void your warranty unless indicated or instructed to do so.
- Do not use oil, grease, or petroleum-based products on or near the device or its accessories.
- Do not use lubricants on the device or its accessories.
- Do not obstruct air intake or exhaust when operating the device. Blocking air circulation or placing close to a heat source may lead to internal heat buildup and shutdown or damage to the concentrator. In the event of changes to the performance of the device, please refer to the troubleshooting section of this document.
- Do not operate the device without the particle filter in place. Particles drawn into the system may damage the equipment.
- Do not wrap cords around power supply for storage. Do not drive, drag or place objects over cord. Doing so may lead to damaged cords and a failure to provide power to the concentrator.
- Do not use the DC power cord with a cigarette

plug splitter. This may cause overheating of the DC power cord.

- Do not disassemble the power supply. This may lead to component failure and/or safety risk.
- Do not place anything in the device's power port other than the supplied power supply. If an extension cord is used, use an extension cord that has an Underwriters Laboratory (UL) Mark and a minimum wire thickness of 18 gauge. Do not connect any other devices to the same extension cord.
- Do not repackage concentrator, accessories, or systems for shipment in packaging not provided by Inogen.
- Do not jump start the automobile with the DC power cord connected. This may lead to voltage spikes which could shut down and/or damage the device.
- Do not leave the device in an environment which can reach high temperatures, such as an unoccupied car in high temperature environments.
- Do not touch the recessed electrical contacts of the External Battery Charger; damage to contacts may affect charger operation.
- The device will perform as specified only when used within the altitude temperature and humidity ranges as specified in these instructions for use
- The device should be kept dry at all times. Exposure to water could lead to electrical shock and/or damage.
- For optimal sieve bed (columns) life, the product should be used frequently.
- The device's battery acts as a secondary power supply in the event of a planned or unexpected loss of the external power supply. Even when operating the device from an external power supply, a properly inserted battery should be maintained in the unit. Doing so will minimize the risk of interrupting operation and will keep alarms functioning.
- The power supply should be placed in a well-ventilated location as it relies on air circulation for heat dissipation. The power supply may become hot during operation; if this happens, allow to cool

down before handling to avoid injury.

- Ensure the automobile power socket is clean of cigarette ash and the adapter plug fits properly, otherwise overheating may occur.
- Ensure that the automobile power socket is adequately fused for the device power requirement (minimum 15Amp). If the power socket cannot support a 15Amp load, the fuse may blow, or the socket may be damaged.
- When powering the device in an automobile, ensure the vehicle's engine is running first before connecting DC power cord into cigarette lighter adapter. Operating the device without the engine running may drain the vehicle's battery.
- A change in altitude (for example, from sea level to mountains) may affect total oxygen available to the patient. Consult your physician before traveling to higher or lower altitudes to determine if your flow setting should be changed.
- Always keep liquids away from batteries. If batteries become wet, discontinue use immediately and dispose of battery properly.
- To extend the run-time of your battery, avoid running in temperatures less than 41°F (5°C) or higher than 95°F (35°C) for extended periods of time. Store battery in a cool, dry place. Store with a charge of 40-50%.
- Patients who exhibit breathing effort below the specified inspiratory sensitivity value may not be able to consistently trigger the device to receive oxygen therapy.

4. INSTRUCTIONS AND TRAINING

The product provider must ensure that, where appropriate, all users of this device are provided with the user manual.

WARNING:

Do not use the product without proper self-training by reading this manual.

If you need additional information after reading this user manual, please contact your equipment provider.

5. PRODUCT DESCRIPTION

The Inogen Rove 6 Portable Oxygen Concentrator System may include the following accessories: AC power supply, DC power cord, rechargeable battery pack and carry bag.

5.1 SCHEMATIC DESCRIPTION

This section is intended to help familiarize you with the device's components and interface. Do not perform any actions on or with your POC until after reading Section 7, OPERATING Inogen Rove 6.

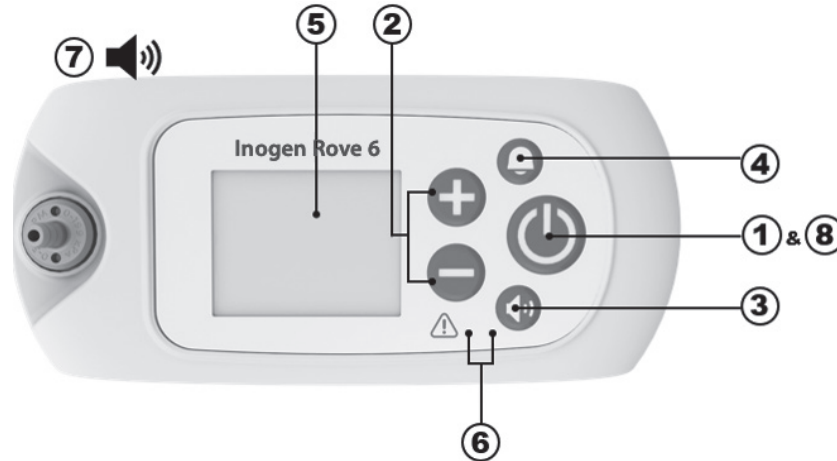

Item	Description	Function
1	Power button	<ul style="list-style-type: none"> Pressing and holding this buttons turns the device on an off. DO NOT try this under after reading Section 7, OPERATING Inogen Rove 6.
2	Flow setting control buttons	<ul style="list-style-type: none"> Use the – or + flow setting control buttons to change the setting. There are six settings, from 1 to 6.
3	Volume control button	<ul style="list-style-type: none"> Pressing this button will change the volume level from 1 to 4.
4	Bell button	<ul style="list-style-type: none"> Pressing this button will toggle the device's <i>no-breath-detect</i> audible alarm on and off. <ul style="list-style-type: none"> When this mode is ON: The device will alarm with audible and visual signals when no breath has been detected for 60 seconds. At 60 seconds, the device will enter 'auto pulse mode.' Once another breath is detected, the device will exit 'auto pulse mode' and deliver normally on inspiration. This mode is enabled when there is a bell in the upper left-hand corner of the display. If power is lost, the no-breath-detect audible alarm remains set in the user preferred mode.
5	Display	<ul style="list-style-type: none"> The display shows information about the status of the device such as flow setting, power status, battery life and alarms. Before use, remove the static cling FCC label from the screen.
6	Indicator lights	<ul style="list-style-type: none"> Breath Detect LED: A green light indicates breath detection. Signal/Alarm LED: A yellow light indicates either a change in operating status or a condition that may need response (alarm). A flashing light is higher priority than non-flashing.
7	Audible signals	<ul style="list-style-type: none"> An audible signal (beep) indicates either a change in operating status or a condition that may need response (alarm). More frequent beeps indicate higher priority conditions.

Item	Description	Function
8	Backlight	• A backlight will illuminate the screen for 15 seconds when the power button is briefly pressed.

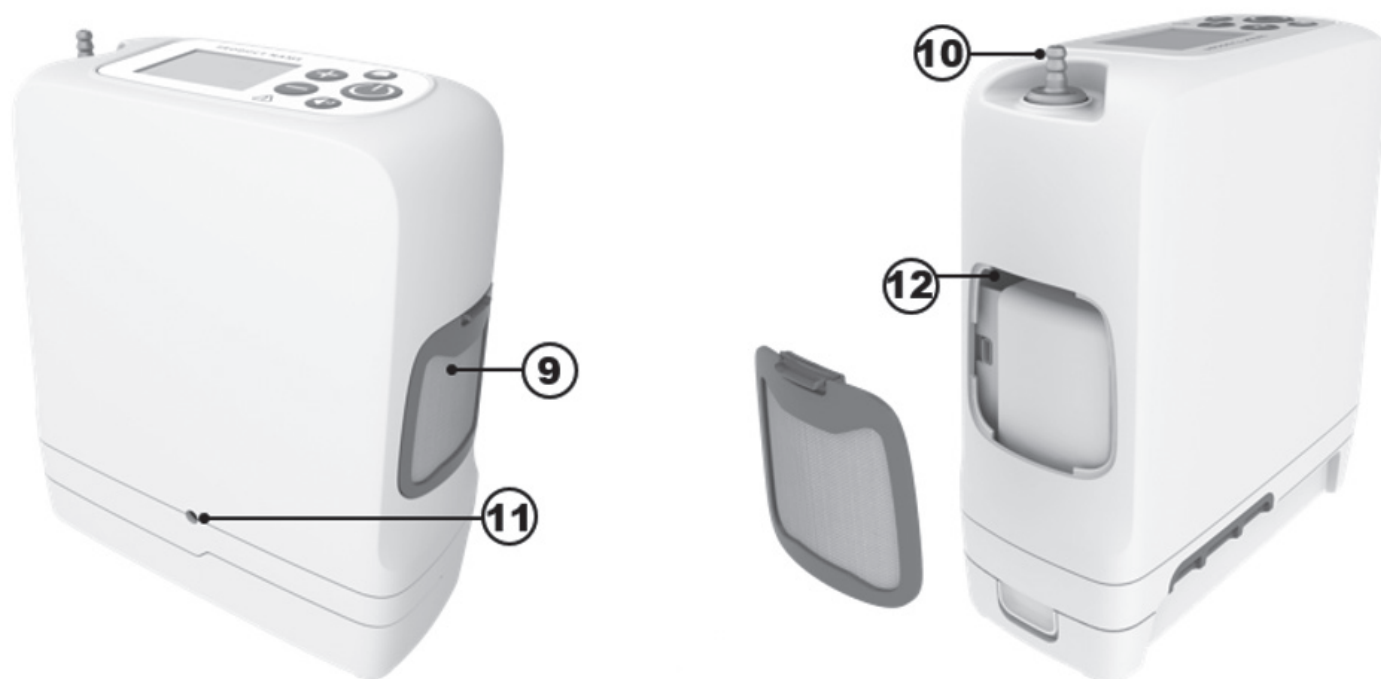

Item	Description	Function
9	Particle filter	• The filters must be always in place during operation to keep the air going into the device free of large particles.
10	Cannula barb	• The nasal cannula connects to the device through this barb.
11	Power in	• Connection for external power from the AC power supply or DC power cord.
12	USB port	• For service use only.

6. GENERAL INSTRUCTIONS BEFORE USE

A variety of accessories can enhance the portability and use of the Inogen Rove 6 Portable Oxygen Concentrator. In addition to the device, the package contains accessories to get started and a user manual. Contact your home oxygen provider for a complete list of available accessories.

Always inspect the device and its accessories for any sign of damage before use.

Important: While the box or packaging may exhibit some damage, e.g., tears or dents, the device may still be in a usable condition. If the device or any accessory shows any sign of damage, contact your home oxygen provider.

Before you get started, check to make sure you have the following:

- Concentrator
- Battery
- Carry bag
- AC power supply
- DC power cord

6.1 ACCESSORIES AND REPLACEMENT PARTS LIST

WARNING!

Risk of death, injury or damage

To avoid injury or damage which will void warranty use only Inogen-specified power supplies.

Only use power supplies/adapters or accessories specified in this manual. Using accessories that are not specified may create a hazard and/or negatively affect the performance of the device. Not all accessories are included with your system and can be purchased separately. The following optional accessories and replacement parts can be purchased from the manufacturer at www.inogen.com or by calling 1-877-466-4364.

Accessory	Catalog Number
Standard battery	BA-500/BA-508
Extended battery	BA-516
AC power supply	BA-502/BA-501
AC power – European cord	RP-116
AC power – UK Cord	RP-115
AC power – North America cord	RP-109
AC power – Switzerland cord	RP-227
AC power – Australia	RP-120

Accessory	Catalog Number
AC power – South Africa	RP-145
Carry bag	CA-500
Backpack	CA-550
External battery charger	BA-503
DC power cord	BA-306
Cannula barb kit	RP-506
Replacement columns	RP-502
Replacement particle filters	RP-501

WARNING!

Do not use the device or any accessory that shows any sign of damage.

6.2 RECHARGEABLE BATTERY PACKS (BA-500, BA-508 AND BA-516)

The battery will power the device without connection to an external power source. Your device may come with 1 or more batteries, depending on the configuration that you've ordered. This device is compatible with three different batteries: BA-500 and BA-508 are standard, 8-cell batteries while BA-516 is the extended, 16-cell battery. These batteries will power the device for different lengths of time, depending on the flow setting.













This table shows the typical durations for a new battery pack.

Device Setting	Standard battery duration (BA-500/BA-508)	Extended battery duration (BA-516)
1	Up to 6:15	Up to 12:45
2	Up to 5:00	Up to 10:15
3	Up to 3:15	Up to 6:30
4	Up to 2:15	Up to 5:15
5	Up to 1:45	Up to 3:30
6	Up to 1:15	Up to 2:30

NOTE: Battery time varies with flow setting and environmental conditions. Time shown is an average and may vary $\pm 10\%$.

6.2.1 CHECKING THE BATTERY STATUS WHEN INSTALLED ON THE DEVICE

When operating on battery, the display will show the estimated percentage (%) or minutes of charge remaining. These icons indicate the device is operating on battery power and is not charging:

	Battery is empty or battery status is not available		Battery has less than 10% charge remaining
	Battery has less than 20% charge remaining		Battery has less than 30% charge remaining
	Battery has less than 40% charge remaining		Battery has less than 50% charge remaining
	Battery has less than 60% charge remaining		Battery has less than 70% charge remaining
	Battery has less than 80% charge remaining		Battery has less than 90% charge remaining
	Battery is full		

IMPORTANT: When the device detects that the battery has less than 10 minutes remaining, a low priority alarm will sound. When the battery is empty, the alarm will change to a higher priority.

When the battery has less than 10 minutes remaining, do one of the following:

- Plug the device into an AC or DC power source using the AC power supply or DC power cord.
- Turn off the device and replace the depleted battery with a charged battery. To remove the battery, press and hold the battery latch button and slide the battery off the device.

If the battery is drained, charge the battery by plugging the device into external power or charging it with the external battery charger.





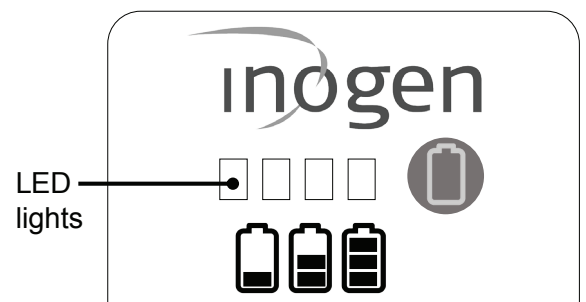







6.2.2 CHECKING THE BATTERY STATUS WHEN NOT INSTALLED ON THE DEVICE

- To check the battery charge when it is not installed in the device, press the green battery icon button. The battery gauge indicator lights (<10% - 100%) will illuminate to the left of the green battery icon button to indicate the level of the battery pack charge:
 - 4 LEDs light up: 75% to 100% full
 - 3 LEDs light up: 50% to 75% full
 - 2 LEDs light up: 25% to 50% full
 - 1 LED lights up: 10% to 25% full
 - 1 LED Blinks: Battery is less than 10% full and needs to be recharged



6.2.3 CHARGING THE BATTERIES

The concentrator will recharge the battery any time the battery is installed and the device is connected to an external AC or DC power source (except on an airplane). You will know the battery is charging when the battery icon on the device's display has a lightning bolt going through it as shown:

	The battery is fully charged and is charging as necessary to maintain its charge.		Battery is charging with charge level <98%
	Battery is charging with charge level <89%		Battery is charging with charge level <79%
	Battery is charging with charge level <69%		Battery is charging with charge level <59%
	Battery is charging with charge level <49%		Battery is charging with charge level <39%
	Battery is charging with charge level <29%		Battery is charging with charge level <19%
	Battery is charging with charge level <10%		The device is operating from an external power source with no battery present, or the external power source is insufficient to charge the battery.

When starting to charge a fully drained battery, the charging process may start and stop during the first few minutes. This is normal.

Leaving your device plugged in past the full charge time will not harm the device or the battery. If using multiple batteries, make sure that each battery is labeled (1, 2, 3 or A, B, C, etc.) and rotate on a regular basis.

6.2.4 BATTERY LIFETIME AND CARE

The device's batteries are designed to last 500 charge/discharge cycles. To extend the run-time of your battery:

- Avoid running the device in temperatures less than 41°F (5°C) or higher than 95°F (35°C) for extended periods of time.
- Store in a cool, dry place with a charge of at least 40-50%.
- Keep liquids away from batteries. If batteries become wet, discontinue use immediately and dispose of battery properly.

Batteries should be charged up to a full charge and discharged down to 0% at least once every 90 days to maintain maximum life.

6.3 USING THE NASAL CANNULA

CAUTION!

Risk of minor injury or discomfort

The proper placement and positioning of the prongs of the nasal cannula in the nose is critical for oxygen to be delivered. Make sure the nasal cannula is properly connected to the nozzle fitting and that the tubing is not kinked or pinched in any way. Replace the nasal cannula on a regular basis.

WARNING!

Risk of injury

Nasal cannula should be rated for 6 liters per minute to ensure proper oxygen delivery. Note that cannulas may be rated in “liters per minute” even though your prescribed pulse dose setting number does not represent a constant flow in liters per minute.



A nasal cannula must be used with the device to provide oxygen from the concentrator. A single lumen cannula up to 25 feet in length is recommended to ensure proper breath detection and oxygen delivery. Reference manufacturer’s instructions for use.

6.4 AC POWER SUPPLY (BA-502/BA-501)

The AC power supply includes an AC power supply that connects to the device and an AC power cable to connect to the power supply and corresponding AC outlet. The AC power supply will automatically adapt to input voltages from 100V-240V (50-60Hz).

To use AC power, do the following:

1. Connect the AC power brick to the power supply cable.
2. Plug the power supply cable into a standard wall outlet.
3. Insert the power supply cable into the power port located near the particle filter on the back of the concentrator.

The AC power supply will charge the batteries when the device is plugged into AC power (except on airplanes).



6.5 DC POWER CORD (BA-306)

The system may or may not include a DC power cord. If it does not include a DC power cord, it can be purchased as a separate accessory from the manufacturer.

WARNING!

Risk of death, injury or damage

Do not touch the tip of the DC power cord after use because it will be hot. Touching the tip of the DC power cord immediately after removal from the cigarette lighter adaptor may cause injury.

The DC power cord consists of a single cable with one end that plugs directly into the device and another end that goes into the DC outlet.

To use the DC power cord:

1. Plug one end of the DC power cord into the cigarette lighter or auxiliary DC power supply.
2. Plug the other end of the DC power cord into the device.
3. Make sure device is secure before operating the car or other vehicle. Power on your device and use normally.







6.6 EXTERNAL BATTERY CHARGER (BA-503, OPTIONAL ACCESSORY NOT INCLUDED)

The concentrator you have will recharge the battery any time the battery is installed and the device is connected to an external AC or DC power source (except on an airplane).

The external battery charger will charge the standard (BA-500/BA-508) and extended (BA-516) battery. It is not included as a standard accessory with the system but can be purchased separately. You can also use your device to charge the battery when it is plugged into an AC or DC power supply.

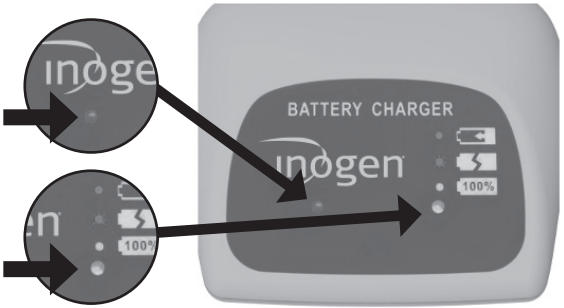
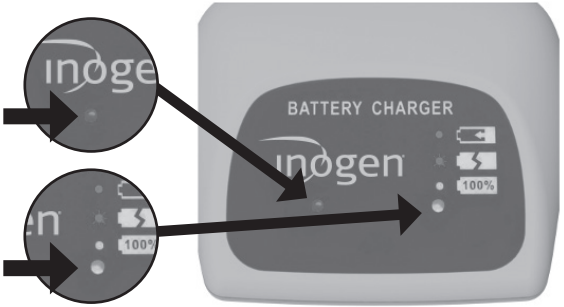
To use the external battery charger, follow these steps:

Step	Description
<p>1</p>	<p>Connect the external battery charger to power</p> <p>1.1 Plug the external battery charger AC power supply cord into an electrical outlet.</p> <p>1.2 Plug the external battery charger AC power supply into the battery charger.</p> <p>1.3 A green light on the bottom of the charger will light up.</p> 
<p>2</p>	<p>Attach the battery</p> <p>2.1 Slide the charger onto the battery until it audibly clicks.</p> <p>2.2 The battery should lock onto the charger.</p> 
<p>3</p>	<p>Check the status of the battery</p> <p>3.1 When the battery is in the correct position, a solid red light will indicate that the battery is charging.</p> <p>3.2 When the green light illuminates, the battery is fully charged.</p> 
<p>4</p>	<p>Check for errors</p> <p>4.1 If the red light is flashing, unplug the unit and complete steps 2 and 3 again.</p> <p>4.2 If the flashing continues after these steps, contact your equipment provider.</p> 

Step	Description
5	<p>Remove the battery when charged</p> <p>5.1 When charged, press down on the battery latch and slide the charger off the battery.</p> 

7. OPERATING INSTRUCTIONS

7.1 OPERATING PRINCIPALS & ESSENTIAL PERFORMANCE

This device works by separating oxygen from air using a pressure swing adsorption (PSA) process. Normal air consists of 21% oxygen; this device increases the amount of oxygen up to 96% by removing the nitrogen and concentrating the output of oxygen. To accomplish this, air is pulled into the device through a small air compressor, nitrogen is separated from the oxygen and finally, the oxygen is collected and delivered to the patient on each breath.

Because the oxygen you breathe comes from your immediate environment, it is very important to keep your device clean. Although there are many filters built into the device, exposing your device to dirty and dusty environments will reduce the life of the filters causing them to need to be replaced more often.

The device maintains the following as essential performance requirements without the need for recurrent testing: (1) Alarm condition when the delivery of oxygen, in both normal and single fault conditions, is not within the performance levels as indicated in this manual. (2) Technical alarm condition when there is a power supply failure. (3) Technical alarm condition when the battery nears depletion. (4) Technical alarm condition when the oxygen concentration is below 82% volume fraction. (5) Malfunction technical alarm condition. (6) The delivery of an oxygen dose, in normal condition or an indication of abnormal operation.

7.2 PNEUMATIC DIAGRAM

Process flows from left to right

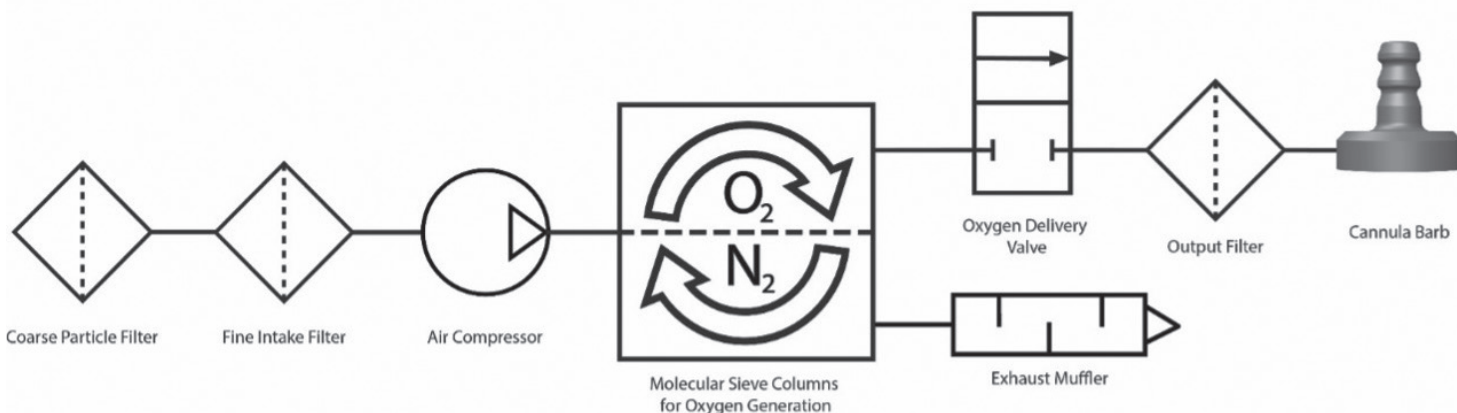

7.3 PREPARING YOUR CONCENTRATOR FOR USE

IMPORTANT: Make sure you have a backup oxygen supply in addition to this portable oxygen concentrator.



What is your back up oxygen supply? _____

DO NOT USE:

- With a humidifier, nebulizer, CPAP or in series or parralel with any other device.
- Near flames, smoke or anything flammable
- Near pollutants, smoke, fumes, flammable anesthetics, cleaning agents or chemical vapors.
- In environments where your concentrator could become submerged in water.
- Near oil grease or petroleum-based products.

Step	Instruction
7.3.1	<p>Ensure your concentrator is in a well-ventilated location</p> <ol style="list-style-type: none">1.1 Air intake and exhaust must have clear access.1.2. Orient your concentrator in such a way that any auditory alarms may be heard.1.3. Always operate in an upright position1.4. Ensure particle filters are in place on both sides of the device.1.5. Ensure you are in a location where you can hear and/or see any alarms that may occur.



Step **Instruction**

7.3.2

Connect your concentrator to an appropriate power source

IMPORTANT: Using the wrong cords can lead to a fire. Only use compatible cords from the manufacturer.

It is recommended to keep a battery always installed on the device, as the battery will charge when the concentrator is plugged into external power. To install a battery:

- 2.1 Align the battery with the bottom housing of the device.
- 2.2. Slide the battery into place until you hear an audible click, meaning the latch has returned to the upper position.
- 2.3. You will hear a single beep and you will see the indicator lights and display light up briefly before shutting off. This means the concentrator has successfully been connected to your battery.

DO NOT use a battery other than those specified in this manual.

If using AC power, do the following:

- 2.4 Connect the AC power brick to the power supply cable.
- 2.5 Plug the power supply cable into a standard wall outlet.
- 2.6 Insert the power supply cable into the power port located near the particle filter on the back of the concentrator.
- 2.7 You will hear a single beep and you will see the indicator lights and display screen light up briefly before shutting off. This means the concentrator has successfully been connected to your power supply.

DO NOT use a power supply other than those specified in this manual.

DO NOT use power cables, or accessories other than those specified in this manual.



Step	Instruction
73.3	<p>Connect an appropriate cannula to your concentrator</p> <p>3.1 Using a single lumen cannula up to 25 feet in length is recommended. This ensures proper breath detection and oxygen delivery.</p> <p>IMPORTANT: Consult your physician if additional titration may be needed to ensure proper oxygen delivery when using a particular cannula.</p> <p>DO NOT lubricate fittings, connections, tubing, or other accessories of your concentrator.</p> <p>3.2 Connect the nasal cannula tubing by inserting it onto the metal cannula barb on the top of the device.</p> <p>3.3 Replace your cannula routinely to avoid contamination or poor cannula performance. See 'Using your nasal cannula' (section 6.3) for more details.</p>



7.4 USING YOUR CONCENTRATOR



DO NOT USE NEAR:

• Grease • Oil • Lubricants • Smoke • Flame



DO NOT USE WITH:

• CPAP • Humidifier • Connected to other devices

Step	Instruction
74.1	<p>Turn on your concentrator</p> <p>1.1 Press and hold the Power button until you hear a single short beep.</p> <p>1.2 The display will light up and the Inogen logo will appear on the display.</p> <p>IMPORTANT: If the display light immediately turns off after the Inogen logo appears, you have not held the power button long enough. Retry the step 1.1 and hold the power button longer.</p> <p>1.3 The 'please wait' icon (⌘) will appear while the concentrator starts up.</p> <p>1.4 The display will indicate the current flow setting and power condition.</p> <p>1.5 Following a brief start-up sequence, a warmup period up to 2 minutes will initiate. During this time-period the oxygen concentration is building to but may not have reached specification. Additional warm up time may be needed if your device has been stored in extremely cold temperatures.</p>



Step	Instruction
7.4.2	<p>Check your concentrator's battery level</p> <p>2.1 Once your concentrator has started up fully, the display light will turn off.</p> <p>2.2 At this time, you will see a battery percentage appear on the screen where the 'please wait' icon (✱) was previously.</p> <p>2.3 If the battery is low, connect your concentrator to an external power supply, as described in step 2.4 or switch it out for a fully charged battery.</p> <p>2.4 If the battery has been removed, go back to section 3.6, part 4, "charging your concentrator's battery" for steps to re-charge the battery.</p>
7.4.3	<p>Set your concentrator's flow setting</p> <p>3.1 The flow setting(s) are prescribed by your physician or clinician.</p> <p>3.2 Use the + or – setting buttons to adjust to the desired setting.</p> <p>3.3 The current setting can be viewed on the display.</p> <p>IMPORTANT: It is normal to hear a difference in sound as you change the flow setting.</p> <p>DO NOT set your concentrator to flow settings not prescribed by your doctor.</p> <div data-bbox="1003 571 1513 787" data-label="Image"> </div> <div data-bbox="1027 856 1503 1024" data-label="Text"> <p>The flow rate is prescribed by your physician; it is a "dose" of oxygen. Too high or too low a rate may eventually lead to harm.</p> </div>

7.4.4

Use your concentrator

- 4.1 Position the nasal cannula below your nose with the small tubes directed into your nose and loop the tubing snugly around your ears per the cannula manufacturer's instructions.
- 4.2 Breathe through your nose.
- 4.3 A green light will flash each time a breath is detected.
- 4.4 Make certain the nasal cannula is properly aligned on your face and you are breathing through your nose.
- 4.5 Your concentrator will sense the onset of inhalation and deliver a burst of oxygen at a precise time when you inhale. The device will sense each breath and continue to deliver oxygen in this manner.
- 4.6 As your breathing rate changes, it will sense these changes and deliver oxygen as you need it.

DO NOT use your concentrator if:

- You feel ill or uncomfortable.
- The concentrator does not signal an oxygen pulse.
- You are unable to hear and/or feel the oxygen pulse.
- You cannot hear the audible alarms.

DO NOT:

- Allow smoking or open flames within 6.56 ft / 2 m of your concentrator.
- Actively smoke while using your concentrator.
 - If you smoke, you must always turn your concentrator off, remove the cannula, and leave the room where either the cannula or your concentrator are located. If unable to leave the room, you must wait 10 minutes after the flow of oxygen has been stopped.
- Leave the nasal cannula on bed coverings or chair cushions.

IMPORTANT: If you inhale very quickly between breaths, the device may ignore one of the breaths, giving the appearance of a missed breath. This is normal, as the device senses and monitors the changes in your breathing pattern. The device will normally sense the next breath and deliver oxygen accordingly.



For maintenance of the cannula, refer to the cannula manufacturer's instructions or follow the advice of your healthcare professional.



Step	Instruction
<p>7.4.5</p>	<p>Optional: use accessories to make your concentrator portable</p> <p>To use the Carry Bag (CA-500) if desired:</p> <p>5.1 Attach a battery.</p> <p>5.2 Insert the device into the Carry Bag through the bottom zippered opening with the cannula barb facing up on the right front side.</p> <p>5.3 Zip up the bottom flap</p> <p>IMPORTANT: Make sure both intake vents are visible through the open mesh panels on the sides of the bag and that the exhaust vent is visible from the open mesh panel on the front of the bag.</p> <p>5.4 Store items such as extra cannulas or ID cards in the zippered closure under the front flap of the carry bag.</p> <p>IMPORTANT: This bag can be attached to a luggage or cart handle.</p> <p>You may purchase and use the Backpack (CA-550).</p> <p>5.5 Insert the device into these bags so that the particle filters are not obstructed, and the power input is accessible.</p> <p>The backpack is not included with the system but may be purchased separately.</p>
<p>7.4.6</p>	<p>Turn off your concentrator</p> <p>6.1 Turn the device off by pressing and holding the power button.</p>

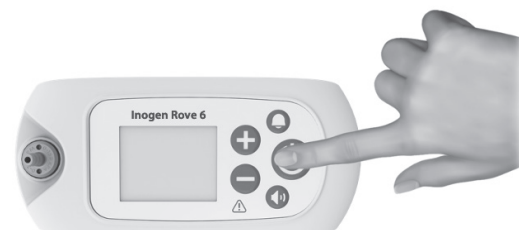

7.5 STORING YOUR CONCENTRATOR

Step	Instruction
7.5.1	<p>Store your concentrator</p> <p>1.1 Remove the battery from the concentrator.</p> <p>1.2 Store concentrator, battery and power accessories in a cool, dry place.</p> <p>1.3 Store your battery with a charge of 40-50%.</p> <p>DO NOT store in temperatures less than 41°F (5°C) or higher than 95°F (35°C) for extended periods of time.</p> <p>DO NOT place objects on top of the concentrator or packaged concentrator.</p>

7.6 RESPONDING TO ALARMS

WARNING:

If you are unable to hear or see alarms, do not have normal tactile sensitivity, or cannot communicate discomfort, consult your clinician before using this device.

Pressing the bell button will enable (turn on) and disable (turn off) the no-breath-detect alarm. When the audible no-breath-detect alarm is ON (because the concentrator has not detected a breath for 60 seconds, see Section 8: alarms for no-breath-detect alarm conditions), the concentrator will emit three beeps, repeated every 25 seconds and will have a flashing yellow light. When this alarm is triggered, the concentrator will begin to deliver pulses of oxygen at a rate of 20 boluses per minute. When the audible no-breath-detect alarm is OFF, the concentrator will respond the same way when no breath is detected for 60 seconds BUT the repeating 3 beeps will not be produced. Whether the no-breath-detect mode is on or off, it does not impact the alarm functionality of any other device alarms or notifications.

Important: The alarm system is tested during the startup sequence. You should see all alarm lights briefly turn on and the audible alarm indicator chirp. If alarms are suspected of misoperating, contact your distributor for verification that alarms are working correctly.

7.7 TRAVELING WITH YOUR CONCENTRATOR

The FAA allows this device on board most U.S. aircrafts.

IMPORTANT: It is the responsibility of the patient to check with the specific airline carrier when traveling domestically and internationally.

When traveling with the device, be sure to bring the AC Power Supply and the External Battery Charger (if you have one) with you. It is advisable to use external power (i.e., plugged into a wall) whenever it is available to keep the battery fully charged.

Bring enough charged batteries with you to power your concentrator for no less than 150% of the expected duration of your flight, ground time before and after the flight, security screenings, connections and a conservative estimate for unanticipated delays. Note that per FAA regulations, all extra batteries are to be individually wrapped and protected to prevent short circuits and carried in carry-on baggage onboard aircraft only.

The AC Power Supply cannot be used to charge the device battery when onboard aircraft. If traveling by bus, train or boat, contact your carrier to find out about power port availability.

8. ALARM INDICATORS & DEVICE ICON GLOSSARY





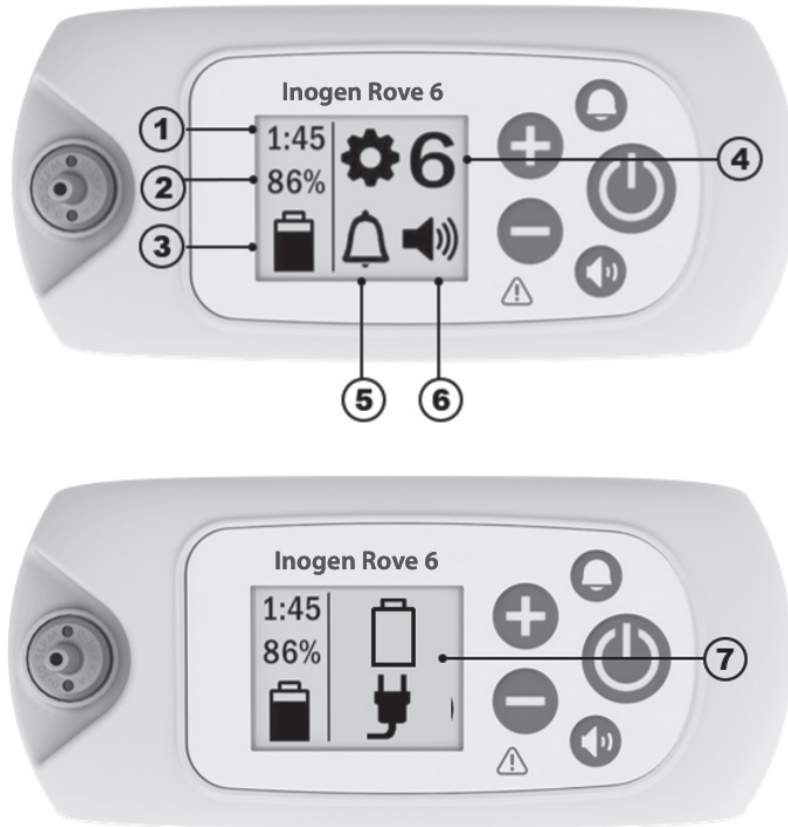

8.1 OVERVIEW INFORMATION

The device uses icons and alarms to communicate status. This glossary outlines all icons and alarms to correctly interpret the status of the device.







1	Battery status icon #1: will show approximately how much time is left on the current battery charge at the current flow setting	2	Battery status icon #2: will show the % that the battery is charged
3	Battery & power supply informational icon: communicates whether or not a battery is inserted, the charge level of the battery, whether the device is connected to a power supply and whether or not the battery is charging. See power supply section for list of icons.	4	Flow setting: shows which flow setting the device is on, from 1 to 6
5	No-breath detect alarm icon: communicates whether the audible alarm is ON or OFF	6	Volume icon: communicates alarm volume levels
7	Informational icons or alarm icons: informational signals or visual alarms. This may be displayed as a single icon or multiple icons and may or may not be accompanied by audible alarms.		

8.2 MODE ICONS





	The no-breath-detect audible alarm is ON.		The no-breath-detect audible alarm is disabled (OFF). This is the default condition.
	Buzzer level 1		Buzzer level 3
	Buzzer level 2		Buzzer level 4







8.3 BLUETOOTH ICONS (FOR MODELS WITH BLUETOOTH)

	Bluetooth turned off.		Bluetooth turned on.
	Pairing with Inogen Connect application.		Concentrator unpaired from mobile device.

8.4 INFORMATIONAL ICONS

The following displayed icons are not accompanied by any audible feedback or any visual change in the indicator lights.

Display Icons	Description & Action (if needed)
	<p>Flow setting</p> <p>“X” represents the selected flow setting (e.g., setting 2).</p>
	<p>Please wait indicator</p> <p>This symbol will appear while the concentrator starts up. Following a brief start-up sequence, a warmup period up to 2 minutes will initiate. During this time-period the oxygen concentration is building to but may not have reached specification.</p>
HH:MM	<p>Time remaining on battery charge</p> <p>“HH:MM” represents the approximate time remaining on the battery charge in hours:minutes (e.g., 1:45).</p>
	<p>Battery charge and charging status</p> <p>This symbol indicates that the battery is installed and is charging. For a complete list of battery charging symbols, see ‘charging the battery with the concentrator’ (section 3.6.4).</p>
	<p>Battery level status</p> <p>This symbol indicates the battery level (about 50% in this example). Refer to ‘checking the battery status when installed on the device’ (section 3.6.2).</p>
XX%	<p>Battery % charged</p> <p>This symbol will be displayed when the concentrator is plugged in and is being used to charge a battery (not being used for oxygen production). It is normal to see a fully charged battery read between 95% and 100% when external power is removed. This feature maximizes the useful life of the battery.</p>

Display Icons	Description & Action (if needed)
	Sieve (columns) reset This symbol is displayed when column maintenance is required and once the replacement columns have been installed.
	Sieve reset success This symbol is displayed once the sieve columns have been successfully reset.
	Data log transfer in progress or update in progress (app only) This icon is displayed during all data log transfers and software updates initiated through the Inogen Connect app.
	Data log transfer success (app only) This icon is displayed after data log transfers have been successfully completed through the Inogen Connect app.
The following displayed icons are accompanied by a single, short beep.	
	Please wait, shutting down Power button has been pressed for 2 seconds. Concentrator is performing system shut down.
	Life Clock (HH:MM), software version & serial number display (Vx.x:SN) This will show up when the 'No-breath-detect' audible alarm button (bell button) has been pressed for five seconds while the concentrator is running.

8.5. ALARMS

The device monitors various parameters during operation and utilizes an intelligent alarm system to indicate a malfunction of the concentrator. Mathematical algorithms and time delays are used to reduce the probability of false alarms while still ensuring proper notification of an alarm condition. If multiple alarm conditions are detected, the highest priority alarm will be displayed. Note that failure to respond to the cause of an alarm condition potentially will result in discomfort or reversible minor injury only (e.g., reduced oxygen supply or a burn). In case of an alarm, seek to address the issue and/or switch to a backup source of oxygen.

WARNING!

Risk of injury or damage

- Audible alarms are to warn the user of problems. To ensure that audible alarms may be heard, the maximum distance that the user can move away from it must be determined based on the surrounding noise level. Make sure the device is in a location where the alarms can be heard or seen if they occur.

The following section provides a listing and description of every possible alarm condition. The alarm system is intended to notify an operator while wearing the device in a shoulder bag or while the device is set down within range of an acceptable nasal cannula.

The device performs an alarm system auto-check on startup by illuminating all LED's and briefly activating the audible alert signal. If the power plug is removed when a battery is connected, the alarms will work normally. If there is

no battery or the device is not connected to AC or DC power, the alarms will not activate because there is no power. With the battery connected, a power loss lasting less than 30 seconds will have no effect on the alarm system.

IMPORTANT: If multiple alarm conditions are detected, the highest priority alarm will be displayed.

IMPORTANT: Failure to respond to the cause of an alarm condition for low, medium and high priority alarms potentially will result in discomfort or reversible minor injury only and develop within a period of time sufficient to switch to a backup source of oxygen.



8.5.1 ALARM LOG

The device maintains a patient accessible alarm log that allows for the last alarm to be accessed and viewed on the LCD (except for the no-breath-detect, check cannula, battery low / attach plug and batter empty / attach plug alarms). The alarm log is retained in memory after the device experiences a total loss of power. To access the alarm log, ensure the concentrator is plugged and turned off. Then hold the plus (+) button for 5 seconds. Alternatively, the alarm log can be found in the Advanced Tab of the Inogen Connect App under Error Recall.

Once a new alarm is activated the new alarm overwrites the previous alarm. The alarm log is retained in memory after the device is powered down. The time elapsed since the error occurred is displayed with the last alarm on the alarm log. The device also maintains a service and repair alarm log that is not accessible by the patient.

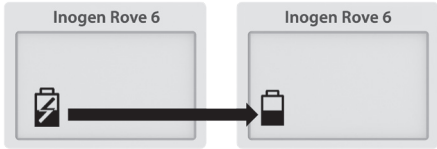
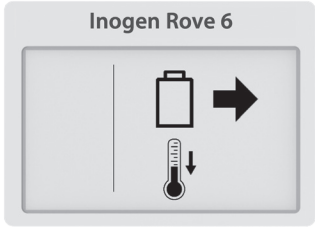

8.5.2 INFORMATIONAL SIGNALS (LEVEL 1)

The following notification icons are accompanied by a **single, short beep**.

Display Icon	Description	What To Do
	<p>Power supply failure or loss of external power</p> <p>The battery has stopped charging and the device has switched to battery power. Eventually the battery will be depleted.</p>	<p>Plug in the power supply to continue charging the battery.</p>
	<p>Battery hot</p> <p>Remove battery to cool.</p>	<p>The battery needs to be removed and must be cooled before reuse.</p>
	<p>Battery error</p> <p>Check battery.</p>	<p>Check the connection of your battery and ensure that it is properly attached and latched to the concentrator. If the battery error persists with same battery, stop using the battery and switch to a new battery or remove the battery and operate the concentrator using an external power supply.</p>

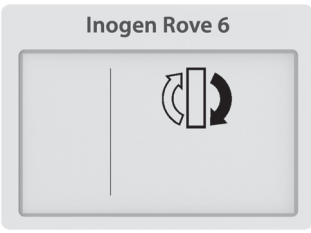

8.5.3 LOW PRIORITY ALARM (LEVEL 2)



The following low priority alarms are accompanied by **one beep** and a **solid yellow light**.

Display Icon	Description	What To Do
 <p>The display icon for 'Replace columns' shows the text 'Inogen Rove 6' at the top, a vertical line on the left, and a circular arrow icon pointing to a column symbol on the right.</p>	<p>Replace columns</p> <p>Column replacement is required within 30 days.</p>	<p>Contact your equipment provider to arrange for service and/or order new columns from the manufacturer.</p>
 <p>The display icon for 'Extended start up' shows the text 'Inogen Rove 6' at the top, a vertical line on the left, and two gear icons (one solid, one dashed) on the right.</p>	<p>Extended start up</p> <p>Oxygen concentration is <87% two minutes after the device's start up sequence and at least 10 breaths have been detected within the last minute.</p>	<p>Wait a few minutes to see if the oxygen concentration improves (alarm will clear). If condition persists, a secondary alarm will sound. Follow the instructions for that alarm or contact your equipment provider. If alarm occurs frequently at start up, this may indicate that maintenance (column replacement) will soon be required.</p>

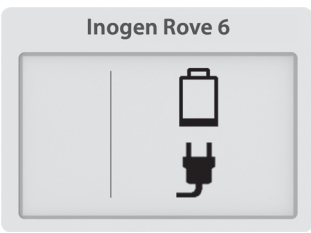
8.5.4 LOW PRIORITY ALARM (LEVEL 3)

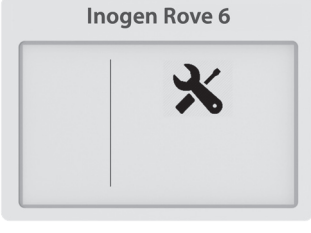

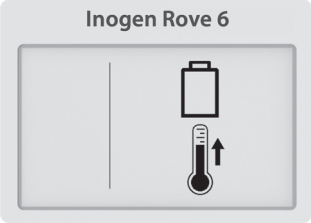
The following low priority alarms are accompanied by **two beeps** and a **solid yellow light**.



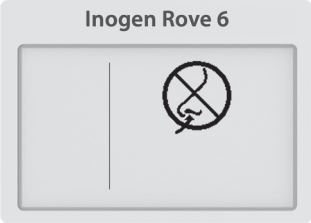

Display Icon	Description	What To Do
 <p>The display icon for 'Battery low, attach plug' shows the text 'Inogen Rove 6' at the top, a vertical line on the left, and a battery icon with a plug symbol on the right.</p>	<p>Battery low, attach plug</p> <p>Battery power is low with less than 10 minutes remaining.</p>	<p>Attach an external power supply turn off and insert a fully charged battery.</p>
 <p>The display icon for 'Oxygen low' shows the text 'Inogen Rove 6' at the top, a vertical line on the left, and the text 'O2' with a downward arrow on the right.</p>	<p>Oxygen low</p> <p>The concentrator has been producing oxygen at a slightly low level (<82%) for a period of 10 minutes.</p>	<p>If condition persists, contact your equipment provider.</p>
 <p>The display icon for 'Service soon' shows the text 'Inogen Rove 6' at the top, a vertical line on the left, and a wrench and screwdriver icon on the right.</p>	<p>Service soon</p> <p>The concentrator requires servicing at the earliest convenience. The concentrator is operating to specification and may continue to be used.</p>	<p>Contact your equipment provider to arrange for service.</p>

Display Icon	Description	What To Do
	<p>Battery HOT warning</p> <p>The battery temperature is nearing the temperature limit while concentrator is running on battery power.</p>	<p>If possible, move the concentrator to a cooler location or power unit with an external power supply and remove battery. If condition persists, contact your equipment provider.</p>
	<p>System HOT warning</p> <p>Concentrator temperature is nearing temperature limit.</p>	<p>If possible, move the concentrator to a cooler location. Ensure air intake and outlet vents have clear access and particle filters are clean. If condition persists, contact your equipment provider.</p>

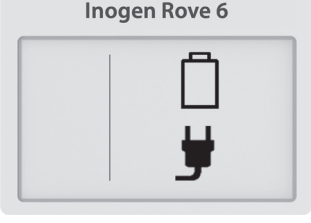
8.5.5 MEDIUM PRIORITY ALARMS (LEVEL 4)

The following medium priority alerts are accompanied by **three beeps**, repeated every 25 seconds, and a **flashing yellow light**.

Display Icon	Description	What To Do
	<p>No-breath-detect: check cannula</p> <p>The concentrator has not detected a breath for 60 seconds.</p>	<p>Check that cannula is connected to concentrator, there are no kinks in tubing and the cannula is positioned properly in your nose.</p>
	<p>Oxygen error</p> <p>Oxygen output concentration has been below 50% for 10 minutes.</p>	<p>If condition persists, switch to your backup oxygen source and contact your equipment provider to arrange for service.</p>
	<p>Oxygen delivery error</p> <p>A breath has been recognized, but proper oxygen delivery has not been detected.</p>	<p>If condition persists, switch to backup oxygen source and contact your equipment provider to arrange for service.</p>
	<p>Battery empty, attach plug</p> <p>The concentrator has insufficient battery power. The concentrator will shut down and stop producing oxygen.</p>	<p>Attach an external power supply or replace with a full charged battery. If the device has turned off, press and hold the power button to turn back on.</p>

Display Icon	Description	What To Do
	<p>Battery HOT</p> <p>The battery has exceeded temperature limit while concentrator is running on battery power. The concentrator will shut down and stop producing oxygen.</p>	<p>If possible, move concentrator to a cooler location, then turn power off and back on. Ensure air intake and outlet vents have clear access and particle filters are clean. If condition persists, switch to external power or a backup source of oxygen and contact your equipment provider.</p>
	<p>System HOT</p> <p>Concentrator temperature is too high. The concentrator will shut down and stop producing oxygen.</p>	<p>Ensure air intake and outlet vents have clear access and particle filters are clean. If condition persists, switch to a backup source of oxygen and contact your equipment provider.</p>
	<p>Sensor fail</p> <p>The concentrator's oxygen sensor has malfunctioned.</p>	<p>You may continue to use the concentrator. If the condition persists, contact your equipment provider.</p>
	<p>System COLD</p> <p>The system is cold (<math><2^{\circ}\text{C}</math>). The concentrator will shut down and stop producing oxygen.</p>	<p>Move to a warmer environment to allow the unit to warm up before starting it. If condition persists, switch to a backup source of oxygen and contact your equipment provider.</p>
	<p>System Error</p> <p>The concentrator has stopped producing oxygen and is shutting down.</p>	<p>Switch to backup oxygen source and contact your equipment provider.</p>

9. TROUBLESHOOTING

Problem	Possible Cause	Recommended Solution
Any problem accompanied by information on concentrator display, indicator lights and/or audible signals	Refer to device icon & alarm glossary	Refer to device icon & alarm glossary

Problem	Possible Cause	Recommended Solution
Concentrator does not power on when On/Off button is pressed	Battery is discharged or no battery is present	Use external power supply or replace battery with one that is fully charged
	AC Power supply is not connected properly	Check power supply connection and verify green light is solid
	DC power cord is not connected properly	Check DC power cord connection at the device and at cigarette lighter or auxiliary DC power cord
	Malfunction	Contact your equipment provider
No oxygen	Concentrator is not powered on	Press On/Off button to power concentrator
	Cannula is not connected properly or is kinked or obstructed	Check cannula and its connection to concentrator nozzle
Does not connect to Bluetooth	Other devices maybe causing interference, or the devices are too far apart.	Move the concentrator away from other electronic devices and/or move it close to your mobile device.

10. CLEANING, CARE AND MAINTENANCE

Operator should perform periodic visual inspection of the device. ISO 80601-2-67 Clause 201.79.2.12

WARNING!

Risk of death, injury or damage

- DO NOT perform service or maintenance while the equipment is in use.
- DO NOT disassemble the device or any of the accessories or attempt any maintenance other than tasks described in these instructions for use; disassembly creates a hazard of electrical shock and will void your warranty. Do not remove the tamper evident label. For events other than those described in this manual, contact your equipment provider for servicing by authorized personnel.
- DO NOT use any columns other than those specified in this user manual. The use of non-specified columns may create a safety hazard and/or impair equipment performance and will void your warranty.
- Use only spare parts recommended by the manufacturer to ensure proper function and to avoid the risk of fire and burns.
- Periodic visual inspection of the device is required to ensure no damage to the exposed components is apparent. A typical visual inspection includes:
 - Battery connectors- these should not be bent or deformed.
 - Cannula barb- this should be straight and fully seated against the housing.
 - Housing- the housing should be fully seated and secure with no cracking or other visible damage.
 - Course particle filters - these should be in place and clear of debris, dust or other obstructions.
 - Fine particle filter- this should be secure and in place.

Replacement parts can be purchased from the manufacturer at www.inogen.com or by calling 1-877-466-4364.

10.1 CANNULA REPLACEMENT

Your nasal cannula should be replaced on a regular basis per the manufacturer's instructions for use. Consult with your physician and/or equipment provider and/or cannula manufacturer's instructions for replacement information.

10.2 CASE CLEANING

DANGER!

Risk of injury or damage

Liquid will damage the internal components of the concentrator and its equipment. To avoid damage or injury from electrical shock:

- Turn Off the concentrator and unplug the power cord before cleaning.
- DO NOT allow any cleaning agent to drip inside the air inlet and outlet openings.
- DO NOT spray or apply any cleaning agent directly to the cabinet.
- DO NOT hose down the product.
- DO NOT submerge the device or accessories in liquid

WARNING!

Risk of death, injury or damage

Harsh chemical agents can damage the concentrator and filters

- DO NOT clean with alcohol and alcohol-based products (isopropyl alcohol), concentrated chlorine-based products (ethylene chloride), and petroleum-based products or any other harsh chemical agents. Only use mild liquid dish detergent.

Periodically clean the case as follows:

1. Make sure the concentrator is off and is removed from the carry bag.
2. Clean the outside case using a cloth dampened with a mild liquid detergent and water.
3. Allow the concentrator to air dry, or use a dry towel, before returning the concentrator to the carry bag or backpack and prior to operating the concentrator.

IMPORTANT: The device should receive an external cleaning weekly; accessories should be cleaned as needed. The device exterior should be cleaned and the output filter replaced prior to delivering to a new patient.

10.3 FILTER CLEANING & REPLACEMENT (RP-501)

The particle filters must be cleaned **weekly** to ensure the ease of air flow.





To clean:

1. Remove the particle filters from both intake ends of the device.
2. Clean the particle filters with a mild liquid detergent and water, rinse in water and dry fully before reuse.

To purchase additional particle filters, contact your equipment provider or Inogen.

10.4 CANNULA BARB AND OUTPUT FILTER REPLACEMENT (RP-506)

The cannula barb connects the gas pathway to the cannula while the output filter is designed to protect the user from breathing in small particles when using the device. The output filter is located behind the cannula barb and should be replaced between patients or when replacing the cannula barb. To replace the cannula barb and output filter, follow these steps:

Step	Instruction	
1	1.1 Turn the spanner wrench tool counterclockwise to unscrew the cannula barb.	
2	2.1 Remove the cannula barb.	
3	3.1 Check that there is no debris left inside. 3.2 Insert the new integrated cannula barb and output filter.	
4	4.1 Turn the spanner wrench tool clockwise until the cannula barb is securely attached. Do not overtighten.	

10.5 DC POWER CORD FUSE REPLACEMENT (RP-125)

The cigarette lighter DC power cord contains a fuse. If the DC power cord is being used with a known good power source and the device is not receiving power, the fuse may need to be replaced.

WARNING

CHOKING HAZARD: small parts exposed when changing the fuse, keep away from small children and pets.



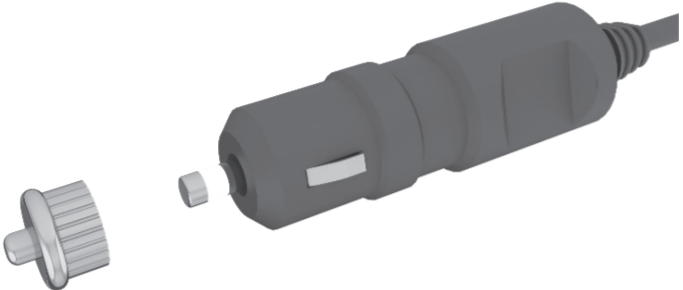

- **CRITICAL FUSE SIZING:** incorrect fuse replacement size may result in fire or inadequate equipment protection. Replace only with same type and rating of fuse.
- **ELECTRICAL SHOCK:** complete disconnect the cable before attempting to change the fuse.
- Do not hang any type of accessory or accessory bracket from plug.





To replace the fuse:

Step	Instruction	
1	1.1 Remove the tip by unscrewing the retainer. Use a tool if necessary.	
2	2.1 Remove the retainer, tip, and fuse.	
3	3.1 The spring should remain inside the cigarette lighter adaptor housing. 3.2 If the spring is removed, replace the spring first before inserting the replacement fuse.	
4	4.1 Install a replacement fuse. 4.2 Reassemble the tip. 4.3 Ensure the retainer ring is properly seated and tightened.	

10.6 COLUMN CHANGE

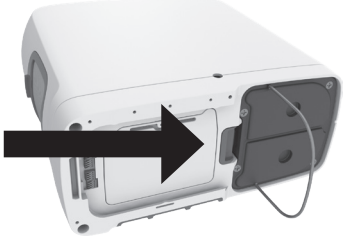
The device is programmed to alert you when the columns should be replaced (see 'Alarms' section). Although will need to purchase columns from the manufacturer or your service provider, the columns are designed to be easily changed by the patient by following these steps:

Step	Description	
1	1.1 Turn off the device by pressing and holding the power button.	 A close-up photograph of the Inogen Rove 6 device. A hand is shown with the index finger pressing the power button, which is a circular button with a power symbol. The device has a small screen and several other buttons around it.
2	2.1 If using, remove the device from the carry case.	 A photograph showing the Inogen Rove 6 device being lifted out of its black carry case. The case is open, and the device is being held by a strap.
3	3.1 Remove the battery from the device.	 A photograph of the Inogen Rove 6 device with the battery compartment cover removed. The cover is shown to the right of the device, revealing the battery compartment.
4	4.1 Place the device on its side so that the underside is visible. 4.2 The columns are on one side of the device.	 A photograph of the Inogen Rove 6 device lying on its side. The underside of the device is visible, showing the battery compartment and the column access panel.

Step	Description	
5	<p>5.1 Unlock the columns by pushing the latch button away from the columns.</p> <p>5.2 While holding the latch button open, slide column assembly out of the device by lifting and pulling on the metal pull handle.</p>	
6	<p>6.1 Remove the columns completely from the device by pulling outward on the metal pull handle.</p> <p>6.2 Both columns are removed as one piece.</p>	
7	<p>7.1 To install new columns, first remove the four (4) dust caps from the new columns.</p> <p>7.2 Make sure there is no dust or debris where the dust caps were located.</p>	
8	<p>8.1 Insert the new columns into the device immediately after removing the dust caps.</p> <p>8.2 Push the columns until the latch makes an audible click and returns to the closed position.</p> <p>8.3 Push and fold metal pull handle flush to bottom of columns.</p> <p>DO NOT: leave the column ends exposed.</p>	

IMPORTANT: You need to notify the device that you have replaced the columns. This can be done through the device itself or through the Inogen Connect App.

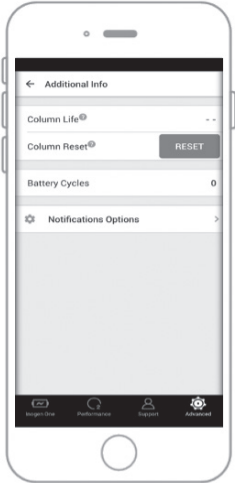
Step	Description	
<p>9</p>	<p>Resetting the columns through the device</p> <p>9.1 Connect the device to AC power but DO NOT power on the device.</p> <p>9.2 Press and hold the plus (+) and (-) minus button for 5 seconds. The screen will display the 'sieve reset' informational icon.</p> <p>9.3 Release the buttons once the 'sieve reset' icon is displayed on screen.</p> <p>9.4 Press the bell button once. The screen will display the 'sieve reset success' informational icon.</p> <p>9.5 Press and hold the power button to turn on the device.</p>	
<p>10</p>	<p>Resetting the columns through Inogen Connect App</p> <p>10.1 Open the Inogen Connect App on your mobile device or tablet.</p> <p>10.2 Navigate to the <i>Advanced</i> screen.</p> <p>10.3 Click on <i>Additional Information</i>.</p> <p>10.4 Click the <i>Column Reset</i> button.</p>	

10.7 BATTERY CARE AND MAINTENANCE

Lithium-ion batteries require special care to ensure proper performance and long life. Use only compatible batteries with your device.

- **Keep Dry:** Always keep liquids away from batteries. If batteries become wet, discontinue use immediately and dispose of battery properly.
- **Effect of temperature on battery performance:** The battery powers the device under most environmental conditions. To extend the run-time of your battery, avoid running in temperatures less than 41°F (5°C) or higher than 95°F (35°C) for extended periods of time.
- **Battery Storage:** Remove your battery from the device when it is not in use to avoid inadvertent discharge. Store battery in a cool, dry place. Store with a charge of at least 40-50%. Batteries should be charged up to full charge and discharged down to 0% at least once every 90 days to maintain maximum lifetime. Avoid storing your device Battery in extreme temperatures, below -4°F (-20°C) or above 140°F (60°C), for any amount of time.
- **Battery Disposal:** Contact your provider for proper battery disposal. Lithium-ion batteries, like all rechargeable batteries, are recyclable and should never be incinerated.

10.8 SERVICE LIFE

The expected service life of the device is 5 years, except for the sieve beds (plastic columns) which have an expected life of 1 year and the batteries, which have an expected life of 500 full charge/discharge cycles.

11. PAIRING YOUR DEVICE WITH THE CONNECT APP



The Inogen Connect App pairs your portable oxygen concentrator to your mobile device or tablet using Bluetooth technology. It is not available in every country – contact your equipment provider for more information.





IMPORTANT: the app is not intended to replace the user interface panel, which is the primary source of information to which the patient should refer when operating the device.

IMPORTANT: Connection of the Inogen Rove 6 to a Bluetooth connection that includes other equipment could result in previously unidentified risks to patients, operators or other third parties. The responsible organization should identify, analyze, evaluate and control these risks. Subsequent changes to the Bluetooth connection could introduce new risks and require additional analysis. Changes to the Bluetooth connection include:

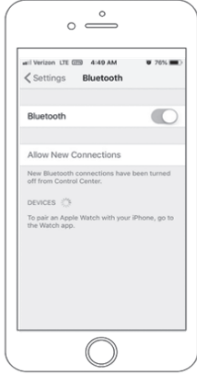
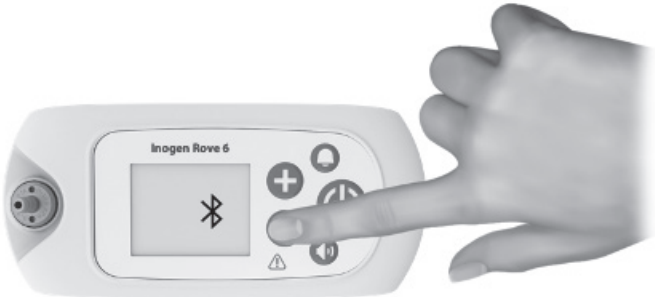
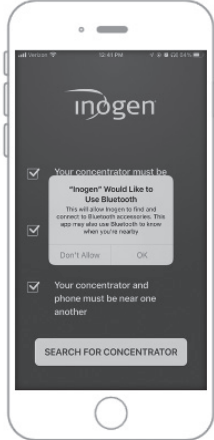
- Changes in the Bluetooth configuration.
- Connection of additional items to the Bluetooth connection.
- Disconnecting items from the Bluetooth connection.
- Update of equipment connected to the Bluetooth connection.
- Upgrade of equipment connected to the Bluetooth connection.

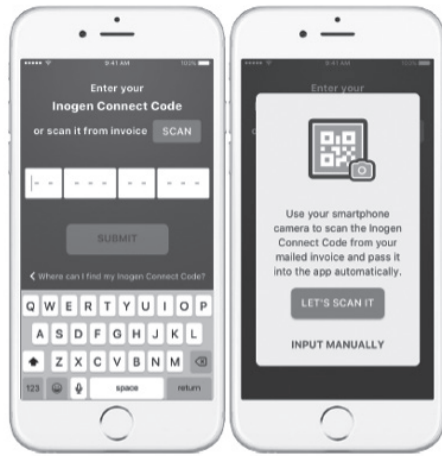
11.1 PAIRING YOUR DEVICE WITH THE MOBILE APPLICATION

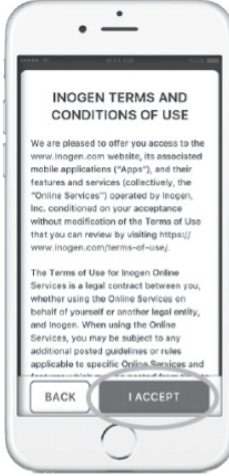
Step	Description	
1	<p>Download the Inogen Connect App</p> <p>1.1 On your smart phone or tablet, search for 'Inogen Connect' in the App Store (Apple) or Google Play (Android).</p>	
2	<p>Put the device in standby mode</p> <p>2.1 Connect the AC power supply cord to your portable oxygen concentrator</p> <p>2.2 Plug into an electrical outlet.</p> <p>2.3 DO NOT power on the device.</p>	
3	<p>Make sure your mobile device or tablet has Bluetooth turned on</p> <p>3.1 Navigating to <i>Settings</i></p> <p>3.2 Click on <i>Bluetooth</i></p> <p>3.3 Turn "on" using the slider</p>	
4	<p>Activate Bluetooth on your device</p> <p>4.1 Make sure the device is <u>not</u> powered on.</p> <p>4.2 Press and hold the minus button until the Bluetooth icon appears on the display.</p>	
5	<p>Pair the concentrator to your mobile device or tablet</p> <p>5.1 Open the Connect App on your mobile device.</p> <p>5.2 Accept the connection to Bluetooth by clicking OK.</p>	

Step	Description	
	<p>5.3 Locate your unique provider code</p> <p>5.3.1 If purchased from Inogen: the provider code will be in the confirmation email or invoice</p> <p>5.3.2 If purchased from a home care provider or other third party: the provide code will be in the paperwork provided by them.</p> <p>5.4 Input your provider code manually or by scanning the QR code.</p>	
	<p>5.5 Search for your concentrator & serial number by clicking the 'Search for Concentrator' button located towards the bottom of the screen.</p> <p>5.6 When the device is found, click on the corresponding serial number.</p>	
	<p>5.7 Read the Terms and Conditions.</p> <p>5.8 If you choose to accept, click on I Accept at the bottom of your screen.</p> <p>IMPORTANT: If you do not agree with the Terms and Conditions, you will not be able to continue pairing your concentrator to your mobile device.</p>	
	<p>5.9 Press and hold the bell button to finish pairing. This may take a few minutes.</p> <p>DO NOT close the app while pairing.</p>	

Step	Description	
6	<p>Pairing complete. Use device normally.</p> <p>6.1 Once pairing is complete, you may turn on your concentrator and use it normally.</p> <p>6.2 The information shown on your Inogen Connect screen will vary depending on your portable oxygen concentrator's current state.</p> <p>For more information, visit www.Inogen.com/app.</p>	

11.2 CYBERSECURITY

Medical device security is a shared responsibility between patients, providers, and manufacturers of medical devices. Failure to maintain cybersecurity may result in compromised device functionality, loss of data availability or integrity, or exposure of other connected devices or networks to security threats.

If using the Inogen Connect App, it is important to ensure the following:

- Make sure to keep your OS updated
- Make sure to keep your app updated
- Make sure to enable passwords
- Turn off the concentrator's Bluetooth when not paired with the Inogen Connect App

The Inogen Connect App is compatible with the following devices: iPhone 6 and later; iPad Air, iPad Air 2, iOS 9 and later, Samsung S5 and later; Nexus 5, Nexus 6, Nexus 9, Android 6 and later.

12. DEVICE REPAIR & DISPOSAL

12.1 REPAIR

Do not attempt to repair the device unless otherwise specified in these instructions for use. Contact your home oxygen provider or manufacturer for assistance.

12.2 DISPOSAL

Follow your local governing ordinances for disposal and recycling of the device and accessories. If WEEE regulations apply, do not dispose of in unsorted municipal waste. Within Europe, contact the EU Authorized Representative for disposal instructions. The battery contains lithium-ion cells and should be recycled. The battery must not be incinerated.

13. LIMITED WARRANTY STATEMENT

The device comes with a 3 year warranty (refer to customer invoice). The Product is warranted by Inogen to be free from defects in materials and workmanship under normal use and service and when correctly maintained for the time set out in the warranty statement provided with the Product, which period shall begin on the Original Shipment Date. As used herein, "Original Shipment Date" means the original date of shipment of the Product by Inogen to Customer. The warranties hereunder are granted by Inogen only to the original Customer of the Products and are non-transferable. Customer's original purchase receipt for the Products and proof of identity are required for the limited warranties hereunder to be effective. For the limited warranty set forth herein to be effective, Customer shall inspect each Product within two (2) days of delivery and before such Product is used. Customer agrees that the warranties provided by Inogen with respect to the Product are subject to use of the Product in accordance with Inogen's instructions as provided and that failure to do so shall void the warranties. Inogen's sole liability and Customer's sole and exclusive remedy arising out of or relating to the Products, including for a breach of warranty, is limited to, at Inogen's sole option, repair or replacement of the Product or part thereof which is returned at Customer's expense to Inogen. This warranty shall apply only if Customer notifies Inogen in writing of the defective Product promptly after the discovery of the defect and within the warranty period. Products may be returned only by Customer and only when accompanied by an RMA reference number issued by Inogen. Inogen will not be responsible for any alleged breach of warranty for which Inogen determines to have arisen from a cause not covered by this warranty. Inogen shall make the final determination as to the existence and/or cause of any alleged defect.

Columns, rechargeable batteries, carry bag and power accessories are covered for a period of 1 year only.

For complete warranty statement, please visit www.inogen.com/warranty

14. TRADEMARKS AND DISCLAIMER

14.1 TRADEMARK

All trademarks are the property of their respective owners.

14.2 DISCLAIMER

The information in this document has been carefully examined and is believed to be reliable. Furthermore, the manufacturer reserves the right to make changes to any products herein to improve readability, function, or design. The manufacturer does not assume any liability arising out of the application or use of any product or circuit described herein; neither does it cover any license under its patent rights nor the rights of others.

14.3 THIS DOCUMENT

The information in this document is subject to change without notice. This document contains proprietary information that is protected by copyright. No part of this document may be reproduced in any manner, in whole or in part (except for brief excerpts in reviews and scientific papers), without the prior written consent of the manufacturer. Be sure to read carefully and understand all manuals provided with the product.

14.4 FOR HELP

If you have questions about the information in these instructions or about the safe operation of this device, contact your home oxygen provider or distributor.

15. TECHNICAL DESCRIPTION

15.1 SPECIFICATIONS

Inogen Rove 6 Portable Oxygen Concentrator (Model # IO-501)	
Mains Isolation	Remove both the DC input cord from device as well as the battery pack.
Dimensions with standard battery	7.2 x 3.3 x 8.2 in (18.3 x 8.3 x 20.5 cm)
Dimensions with extended battery	7.2 x 3.3 x 9 in (18.3 x 8.3 x 22.9 cm)
Weight with standard battery	4.8 pounds (2.2kg)
Weight with extended battery	5.8 pounds (2.6kg)
Nominal sound level	39 dBA typical at setting 2 (MDS-Hi) Maximum system sound power of 62 dBA Maximum system sound pressure of 54 dBA Typical lowest alarm sound pressure of 62.3 dBA (Measured in the carry bag) Typical highest alarm sound pressure of 67.5 dBA (Measured in the carry bag) (Sound pressures measured at 1 meter per ISO 3744)
Warm up time	2 minutes
Oxygen concentration*	90% + 6% and - 3% at all settings
Inspiratory trigger pressure sensitivity	<0.12 cm H2O
Flow control settings	Pulse dose setting 1,2,3,4,5,6
Maximum outlet pressure	< 22 PSI 18.7 PSI (129 kPa) ± 10%
AC Power	100 to 240 VAC, 50 to 60 Hz Autosensing 2.0 – 1.0A
DC Power	13.5-15.0VDC, 100W Max voltage: 12.0 to 16.8 VDC (+ 0.5)
Battery type	Lithium ion
Rechargeable battery:	12.0 to 16.8 VDC (± 0.5V)
Battery re-charge time	Standard (BA-500 & BA-508): up to 3 hours Extended (BA-516): up to 4 hours
Operating temperature**	41 to 104°F (5 to 40°C)
Operating humidity	15% to 90%, non-condensing
Operating atmospheric pressure	70 kPa to 106 kPa
Operating altitude**	0 to 10,000 ft (0 to 3048 meters)
Shipping and storage temperature	-13 to 158°F (-25 to 70°C)
Shipping and storage humidity	Up to 90%, non-condensing Store in a dry environment.
Measurement uncertainties:	Pulse volumes: ± 15% of rated volume Pressure: ± 0.03 psig (General) / ± 0.05 cm H2O (Inspiratory Trigger Sensitivity) Oxygen concentration: ± 3% (not accounting for temperature, barometric pressure, and time from measurement device calibration)

*Based on atmospheric pressure of 101.3 kPa (14.69 psi) at 20° C (68° F) & Dry (STPD).

**Operating outside of these operational specifications can limit the concentrator's ability to meeting Oxygen Concentration specification at higher liter flow settings.

15.2 PULSE VOLUME FLOW SETTINGS*

Inogen Rove 6 Pulse Volumes per Flow Setting (mL/breath ± 15% per ISO 80601-2-67)						
BREATHS PER MINUTE	1	2	3	4	5	6
10	21.6	43.4	65.7	85.8	104.5	123.1
15	14.2	29.2	43.3	56.7	69.2	82.1
20	10.9	22.1	32.9	43.2	52.9	62.4
25	8.9	17.5	26.7	35.0	42.9	50.7
30	7.4	14.8	22.0	29.3	36.0	42.6
35	6.3	12.8	18.8	25.0	30.4	36.7
40	5.4	11.3	16.6	21.7	26.5	31.6
TOTAL VOLUME PER MINUTE (ml/min)	210	420	630	840	1050	1260

15.3 ELECTROMAGNETIC COMPATIBILITY (EMC) INFORMATION

WARNING!

Risk of death, injury or damage

- Use of accessories, transducers and cables other than those specified or provided by the manufacturer of this equipment could result in increased electromagnetic emissions or decreased electromagnetic immunity of this equipment and result in improper operation.
- Avoid exposure to known sources of EMI (electromagnetic interference) such as diathermy, lithotripsy, electrocautery, RFID (Radio Frequency Identification), and electromagnetic security systems such as anti-theft/electronic article surveillance systems, metal detectors. Note that the presence of RFID devices may not be obvious. If such interference is suspected, reposition the equipment, if possible, to maximize distances.
- Portable RF communications equipment (including peripherals such as antenna cables and external antennas) should be used no closer than 30 cm (12 inches) to any part of the device, including cables specified by the manufacturer. Otherwise, degradation of the performance of this equipment could result.
- The device should not be used adjacent to or stacked with other equipment. If adjacent or stacked use is necessary, the device should be observed to verify normal operation. If operation is not normal, the device or the other equipment should be moved.

Medical electrical equipment needs to be installed and used according to the EMC information in this manual.

This equipment has been tested and found to comply with EMC limits specified in IEC 60601-1-2. These limits are designed to provide a reasonable protection against electromagnetic interference in a typical home environment.

This concentrator contains Transmitter Module IC: 2417C-BX31A. Contains FCC ID: N7NBX31A. This device complies with Part 15 of the FCC rules. Operation is subject to the following two conditions: (1) this device may not cause harmful interference, and (2) this device must accept any interference received, including interference that may cause undesired operation.

15.3.1 GUIDANCE AND MANUFACTURER’S DECLARATION – ELECTROMAGNETIC IMMUNITY:

The Concentrator is intended for use in the electromagnetic environment of home, institution, vehicle, train, airplane, boats and other transport modalities. The user of the concentrator should make sure it is used in such an environment. During the immunity testing specified below the Rove 6 will continue to deliver oxygen within specification.

Immunity Test	IEC 60601 Test Level	Electromagnetic Environment Guidance
Conducted RF IEC 61000-4-6	3 Vrms 150 kHz to 80 MHz 6Vrms ISM and amateur frequencies	The Rove 6 Portable Oxygen Concentrator is suitable for the electromagnetic environment of typical home, institution, vehicle, train, airplane, boat and other transportation environments.
Radiated RF IEC 61000-4-3	10V/m 80 MHz to 2.7 GHz	
Electrostatic discharge (ESD) IEC 61000-4-2	± 8 kV contact ± 2, 4, 6, 8 and 15 kV air	Floors should be wood, concrete or ceramic tile. If floors are covered with synthetic material, the relative humidity should be at least 30%.
Electrical fast transient/burst EC 61000-4-4	± 2 kV for power supply lines	Mains power quality should be that of a typical home, institution, vehicle or other transpiration and mobile environments.
Surge IEC 61000-4-5	± 1 kV line(s) to line(s)	Mains power quality should be that of a typical home, institution, vehicle or other transpiration and mobile environments.
Voltage dips, short interruptions and voltage variations on power supply input lines IEC 61000-4-11	0% UT for 0.5 cycle at 0°, 45°, 90°, 135°, 180°, 225°, 270°, and 315°. 0% UT for 1 cycle 70% UT for 25/30 cycle 0% UT for 200/300 cycle	Mains power quality should be that of a typical home, institution, vehicle and other transportation and mobile environments. If the user of the Rove 6 requires continued operation during power mains interruptions, it is recommended that the device be powered from an uninterrupted power supply.
Power frequency (50/60 Hz) Magnetic field IEC 61000-4-8	30 A/m	Power frequency magnetic fields should be at levels characteristic of a typical home, institution, vehicle and various mobile environments. Power frequency magnetic fields from common appliances in the home are not expected to affect the device.

NOTE: UT is the a.c. main voltage prior to application of the test level.

15.3.2 GUIDANCE AND MANUFACTURER’S DECLARATION – ELECTROMAGNETIC EMISSIONS

The concentrator is intended for use in al home, institution, vehicle and other transportation and mobile environments. The user of the concentrator should assure that it is used in such an environment.

Emissions Test	Compliance	Electromagnetic Environment Guidance
RF emissions CISPR 11	Group 1	The concentrator uses RF energy only for its internal function. Therefore, its RF emissions are very low and not likely to cause any interference in nearby equipment.
RF emissions CISPR 11	Class B	The concentrator is suitable for use in all establishments, including domestic establishments and those directly connected to the public low- voltage power supply network that supplies buildings used for domestic purposes.
Harmonic Emissions IEC 61000-3-2	Class A	
Voltage fluctuations / flicker emissions IEC 61000-3-3	Complies	

ELECTRICAL ISOLATION DEVICE

The external power supply provides the means for electrical isolation where the AC inlet is incorporated into the power supply.





16 WIRELESS COMMUNICATION SPECIFICATIONS & COMPLIANCE

16.1. BLUETOOTH SPECIAL INTEREST GROUP (SIG) BLUETOOTH BASIC RATE / ENHANCED DATA RATE (BR/EDR) BLUETOOTH SPECIAL INTEREST GROUP (SIG) BLUETOOTH LOW ENERGY (BLE)

Specification	Characteristic
Standard compliance	Bluetooth™ 4.2 BR/EDR and BLE
Effective RF radiated power output	7 dBm
Operating range	≤ 7.62m
Modulation	DQPSK & DPSK
Bandwidth of receiving section	2.400 to 2.485 GHz

See FCC, Canada and Taiwan statements





































16.2 TRANSMITTER APPROVAL INFORMATION

Country	Approval	
United States	FCC ID: N7NBX31A	
Canada	ISED: 2417C-BX31A - IC: 12246A-BM71S2 - HVIN: BM71BLES1FC2	
Europe	RED	
Japan	MIC: 003-180196	Contains transmitter module with certificate number:  R 003-180196
Korea	KCC: R-C-SWK-BX31A	 MSIP-CRM-mcp-BM71BLES1FC2
Taiwan	NCC No: CCAN16LP0011T7	 CCAN16LP0011T7
China	CMIIT ID: 2018DJ6590	
Brazil	ANATEL: 06670-18-01568	<div style="border: 1px solid black; padding: 5px;"> <p>Modelo: RN4871</p>  <p>06670-18-01568</p> <p>"Este equipamento não tem direito à proteção contra interferência prejudicial e não pode causar interferência em sistemas devidamente autorizados".</p> </div> <div style="border: 1px solid black; padding: 2px; margin-top: 5px;"> <p>Este producto contém a placa Modelo RN4871 código de homologação ANATEL 02699-19-08759.</p> </div>

16.3 POTENTIAL FOR RADIO/TELEVISION INTERFERENCE

Country	Statements
United States	<ul style="list-style-type: none"> • This equipment has been tested and found to comply with the limits for a Class B digital device, pursuant to Part 15 of the FCC Rules. • These limits are designed to provide reasonable protection against harmful interference in a residential installation. This equipment generates, uses and can radiate radio frequency energy, and if not installed and used in accordance with the instructions, may cause harmful interference to radio communications. However, there is no guarantee that interference will not occur in a particular installation. If this equipment does cause harmful interference to radio or television reception, which can be determined by turning the equipment off and on, the user is encouraged to try to correct the interference by one or more of the following measures: <ul style="list-style-type: none"> ◦ Reorient or relocate the receiving antenna. ◦ Increase the separation between the equipment and receiver. ◦ Connect the equipment into an outlet on a circuit different from that to which the receiver is connected. ◦ Consult the dealer or an experienced radio/TV technician for help.
Canada	<p>This device contains license-exempt transmitter(s)/receiver(s) that comply with Innovation, Science and Economic Development Canada's license-exempt RSS(s). Operation is subject to the following two conditions:</p> <ul style="list-style-type: none"> • This device may not cause interference. • This device must accept any interference, including interference that may cause undesired operation of the device. <p>L'émetteur/récepteur exempt de licence contenu dans le présent appareil est conforme aux CNR d'Innovation, Sciences et Développement économique Canada applicables aux appareils radio exempts de licence. L'exploitation est autorisée aux deux conditions suivantes:</p> <ul style="list-style-type: none"> • L'appareil ne doit pas produire de brouillage. • L'appareil doit accepter tout brouillage radioélectrique subi, même si le brouillage est susceptible d'en compromettre le fonctionnement.
Taiwan	<p>注意！</p> <p>依據 低功率電波輻射性電機管理辦法 第十二條 經型式認證合格之低功率射頻電機， 非經許可， 公司、商號或使用者均不得擅自變更頻率、加大 功率或變更原設計 之特性及功能。 第十四條 低功率射頻電機之使用不得影響飛航安 全及干擾合法通信； 經發現有干擾現象時，應立即停用，並改善至無 干擾時方得繼續使用。 前項合法通信，指依電信規定作業之無線電信。 低功率射頻電機須忍受合法通信或工業、科學及 醫療用電波輻射性 電機設備之干擾。</p>

17. SYMBOLS

	U.S. Federal Regulation Restricts this Device to Sale by order of Physician. May also be applicable in other Countries		Keep Dry
	Type BF Applied Part		Indoor or Dry Location Use Only, Do Not Get Wet
	Class II Equipment		AC Power
	No Open Flames (Concentrator); Do not incinerate (Battery).		DC Power
	No smoking		Refer to instruction manual/booklet
	No oil or grease		Manufacturer
	Importer		Authorized Representative in the European Community/European Union
	Electrical Safety Agency Certificate		Indicates use of the automobile DC power cord (BA-306)
	European Conformity		Indicates not for use in MRI environment
	The manufacturer of this POC has determined this device conforms to all applicable FAA requirements for POC carriage and use on board aircraft.		The Federal Communications Commission
	Medical device		Unique Device Identification
	Protected from touch by fingers and objects greater than 0.5 in (12.5 mm). Protected from dripping water less than 15 degrees from vertical.		Serial Number
	Indicates the range of humidity to which the medical device can be safely exposed		Patient information website Some information for use are available on the web
	Warning or caution. Attention required.		Catalog Number
	Packaging is recyclable		United Kingdom Conformity Assessment
	Compliant with the Waste Electrical and Electronic Equipment/Restriction of the Use of Certain Hazardous Substances in Electrical and Electronic Equipment (WEEE/RoHS) recycling directive.		Indicates the maximum and minimum temperature limits at which the item shall be stored, transported or used.
	Date of Manufacture		Atmospheric pressure limitation to which the medical device can be safely exposed (operating)
	Contents		This side up
	CH Authorized Representative		



Inogen, Inc.
301 Coromar Drive
Goleta, CA 93117
Toll Free: 877-466-4362
+1-805-562-0515 (Outside the USA)

E-mail: info@inogen.net
www.inogen.com

USA United States



EMERGO EUROPE
Prinsessegracht 20
2514 AP, The Hague
The Netherlands



UK Responsible Person:
Emergo Consulting (UK) Limited
c/o Cr360 – UL International
Compass House, Vision Park Histon
Cambridge CB24 9BZ
United Kingdom

Independent Living Specialists
Unit 1 / 12 Mars Road
Lane Cove West NSW 2066
Tel: 02 9427 4995

BOC Limited
10 Julius Avenue, North Ryde,
NSW 2113,
Australia
Tel: 1800 050 999
988 Great South Road,
Penrose Auckland,
New Zealand
Tel: 0800 699 2273

Air Liquide Healthcare
Level 4, Suite 3-4 247 Coward Street
Mascot NSW 2020
Tel: 1300 360 202