



**MOULDINGS | STAIR PARTS | BOARDS | EXTERIOR MILLWORK**  
**MIDWEST CHICAGO DISTRIBUTION CENTER**



# our STORY

## DEEP ROOTS. HIGH STANDARDS. BRIGHT FUTURE.

Founded in 1946 Empire has grown into one of the largest millwork distribution and manufacturing companies in the United States.

With a geographic footprint that touches the majority of the eastern half of the United States, Empire is positioned for continued expansion.

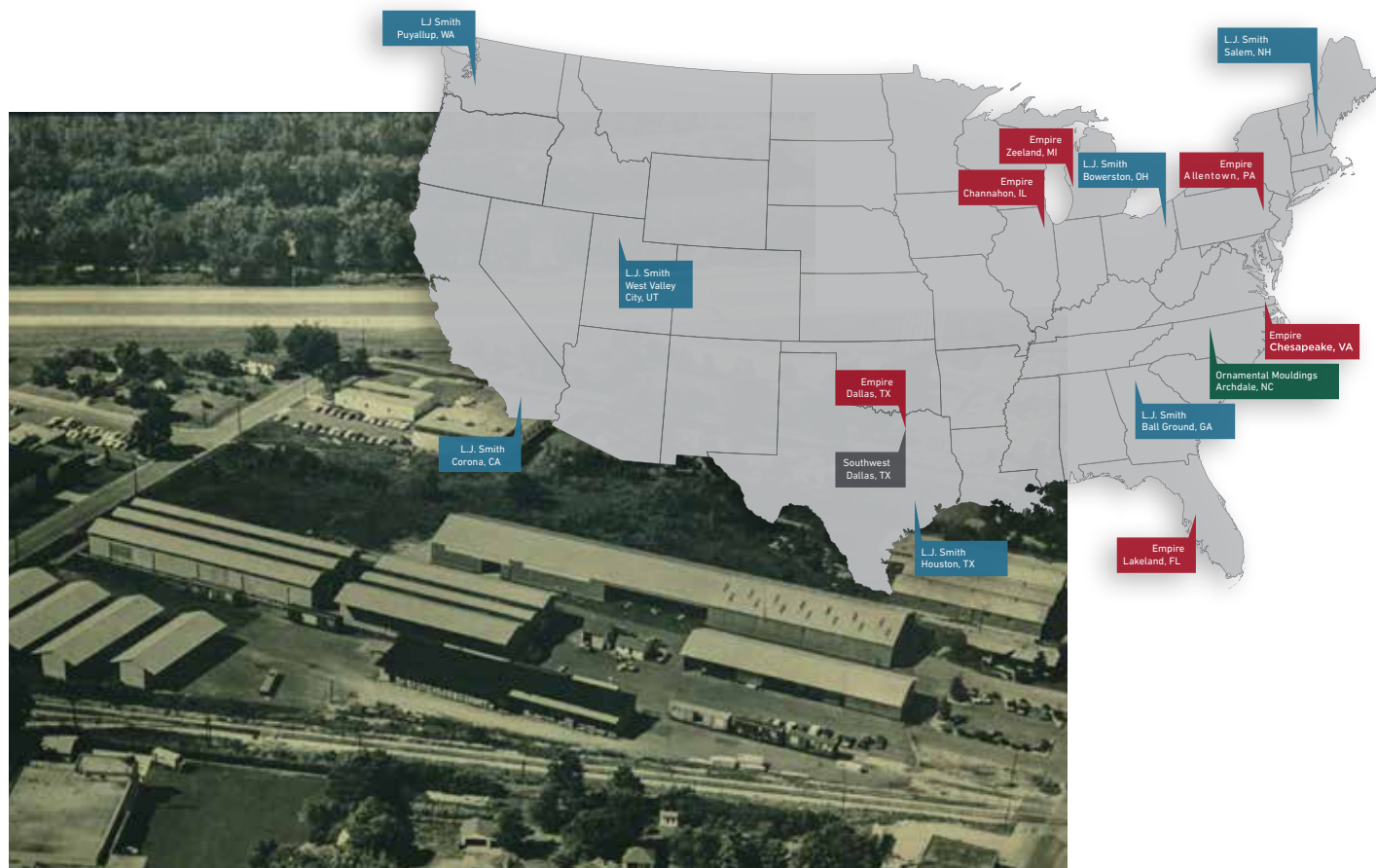

# our FAMILY

## EMPIRE IS NOW A PART OF THE NOVO FAMILY.

Novo Building Products is the industry leading manufacturer and distributor of mouldings, stair parts, doors, and specialty building products. We are proud to serve building material dealers (lumberyards),

door shops, retail home centers, and millwork manufacturing partners throughout the United States and parts of Canada and Mexico.

Learn more at [novobp.com](http://novobp.com).





Style is individual, personal, and unique.  
Make your room a reflection of you...

# DISCOVER YOUR STYLE HERE



The new and improved **Empireco.com**. Explore our comprehensive collections of mouldings, stair parts, boards, and exterior millwork as well as find inspiration for every room in the home.

*Pictured: 1x6 Shiplap | 327 Casing | 723 Base*

## TABLE OF CONTENTS

INSPIRATION.....	5-11	DOOR JAMBS   FRAMES .....	27
DECORATIVE MOULDING ACCESSORIES.....	12-15	BASE CAPS   BASE BLOCKS .....	28
BUILD-UPS.....	16	BASE.....	29-37
BOARDS .....	17	CHAIR RAIL   PANEL MOULD.....	38
SPECIES DEFINITIONS .....	18	WAINSCOTING   SHIPLAP .....	39
GENERAL GRADE / REQUIREMENTS.....	18	COVE   BED.....	40
CASING.....	19-23	CROWN.....	40-44
CASING BLOCKS.....	23	CROWN BLOCKS.....	45
ARCHITRAVES.....	24	GENERAL PURPOSE .....	46-47
STOPS   MULLIONS.....	25	PVC MOULDING .....	48-49
BRICKS   STOOLS.....	26	MOULDING INDEX .....	50



*Achieve a similar look using: P 450 Chair Rail | 041 Crown | 5030 Architrave | 312 Casing | L 163E Base*

## Classic

Colonial, Ranch, Traditional, Midwestern, Early American, Inviting and Timeless...

Classic Mouldings enhance any home style from Midwestern to Early American, and blend perfectly with the classic style furnishing and timeless building materials of today. Empire has a vast selection of classic style mouldings to match and enhance your style.



**P 450 (CASING)  
CHAIR RAIL**  
11/16 x 3-1/2



**041  
CROWN**  
1-3/16 x 6-5/16



**5030  
ARCHITRAVE**  
1-3/16 x 6-1/4



**312  
CASING**  
19/32 x 3

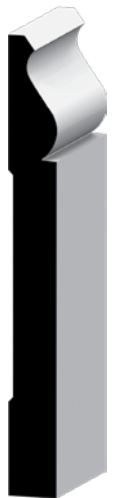

**L 163E  
BASE**  
9/16 x 5-1/4

PROFILES SHOWN ARE NOT TO SCALE.





Achieve a similar look using: **1x3** S4S Board | **E 1035** Extended Half Round | **1x4** Casing | **1x6** Base | **126** Shoe

# Bohemian

Eclectic, Artistic, Avant-Garde; Full of life, culture, color, texture, unique and found objects.

The Bohemian look is unique as your own personality, combining color, texture, and finishes in a room that is both full of variety and styles that reflect your taste. Its is full of life and yet inviting you in to relax. Empire have a wide variety of moulding styles that can be combined to make a room as unique as you. Use any moulding style with a mix of eclectic furnishings and accessories to create a one of a kind flair.



**E 1035 EXTENSION HALF ROUND**  
1/2 x 1-3/8



**1X6 BOARD**



**1X4 BOARD**



**126 SHOE**  
1/2 x 3/4



**2x4 S4S STOCK**  
3/4 x 2-3/4



**L 724 BASE**  
7/16 x 3



**316 CASING**  
11/16 x 2-1/4

Options



Achieve a similar look using: **L 47** Crown | **L 390** Chair Rail | **PT3** Casing | **163** Base Cap | **B312** Base | **126** Shoe

# Glam

Ornate, Art Deco, Baroque, Southern Plantation, Colonial Estate...

Decorative Mouldings can transform the bland into a bold statement of line and form. Ornate mouldings can be combined to restore a great Painted Lady or just a subtle flair and richness to add Glam to any room in your home.



**L 47 CROWN**  
9/16 x 4-5/8



**L 390 CHAIR RAIL**  
9/16 x 2-5/8



**PT3 CASING**  
1 x 3-1/4



**B 312 BASE**  
19/32 x 5-1/4



**163 BASE CAP**  
11/16 x 1-3/8



**126 SHOE**  
1/2 x 3/4





Achieve a similar look using: **1x4 EC** Wainscoting | **L 340** Crown | **1x6** Shiplap | **5010** Architrave | **E412 E2E** Casing | **512E E1E** Base | **126** Shoe



Achieve a similar look using: **400** Crown | **5010** Architrave | **G412** Casing | **G514** Base | **L 254** Shoe

# Rustic

Natural and Painted Woods, Handcrafted, Cottage, Frontier Simplicity...

Empire stocks a wide variety of hardwood and primed mouldings, boards, and wall panels from wainscoting, bead-board to shiplap that combine to create a rich rustic space. From ceiling to walls, fill your home with the timeless warmth and comfort of simpler days.



**1 X 6**  
Actual: 11/16-in x 5-3/8-in  
**SHIPLAP**



**1 X 4**  
Actual: 11/16-in x 3-1/2-in  
**TRIM BOARD**

## Rustic Shiplap and Trim Options



**WOODSHED**  
4 WOOD RBWPP 8' | 12'  
6 WOOD RBWPP 8' | 12'



**SILO**  
4 SILO RBWPP 8' | 12'  
6 SILO RBWPP 8' | 12'



**BARNWOOD**  
4 BARN RBWPP 12'  
6 BARN RBWPP 12'

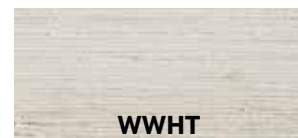

**WEATHERED WHITE**  
4 WWHT RBWPP 8' | 12'  
6 WWHT RBWPP 8' | 12'

# Craftsman

Handcrafted, Architectural, Craftsman, Modern-Farmhouse, Western Ranch...

Craftsman Mouldings are unique in their adaptability to style from Modern Industrial, Arts and Crafts Architectural and Bungalow to Modern-Farmhouse and Art Deco. They are easily combined with other mouldings complimenting your style.



**400 CROWN**  
11/16 x 4-1/4



**5010 ARCHITRAVE**  
1-3/16 x 4-1/4



**G412 CASING**  
19/32 x 3-1/2



**G514 BASE**  
1/2 x 5-1/4

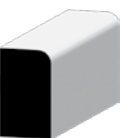

**L254 SHOE**  
7/16 x 3/4

Crown

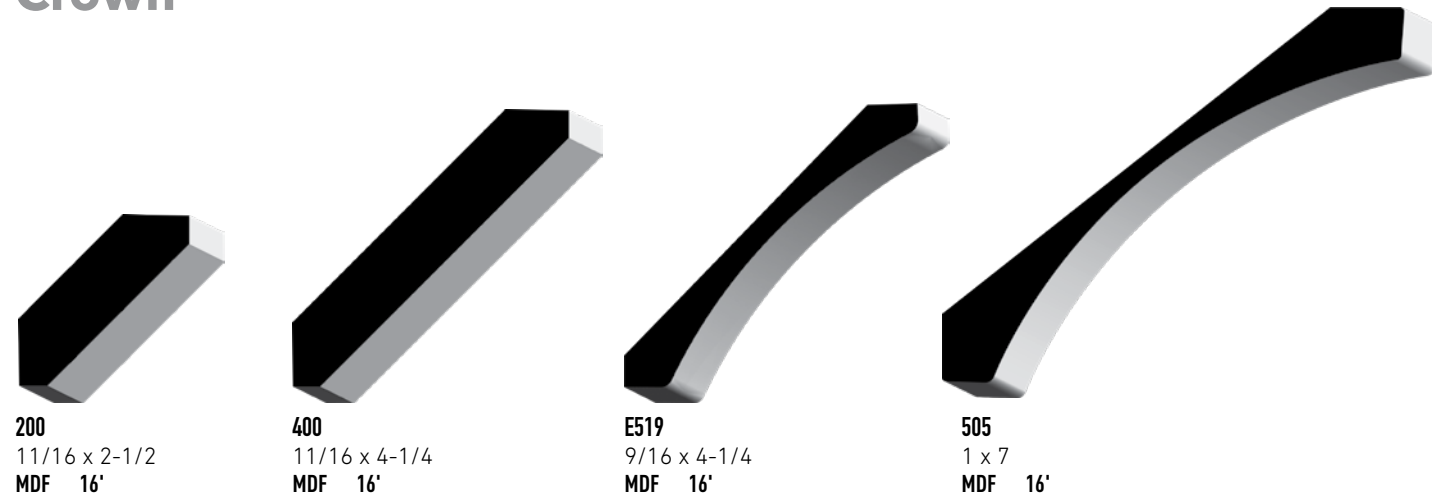

**200**  
11/16 x 2-1/2  
MDF 16'

**400**  
11/16 x 4-1/4  
MDF 16'

**E519**  
9/16 x 4-1/4  
MDF 16'

**505**  
1 x 7  
MDF 16'

Base

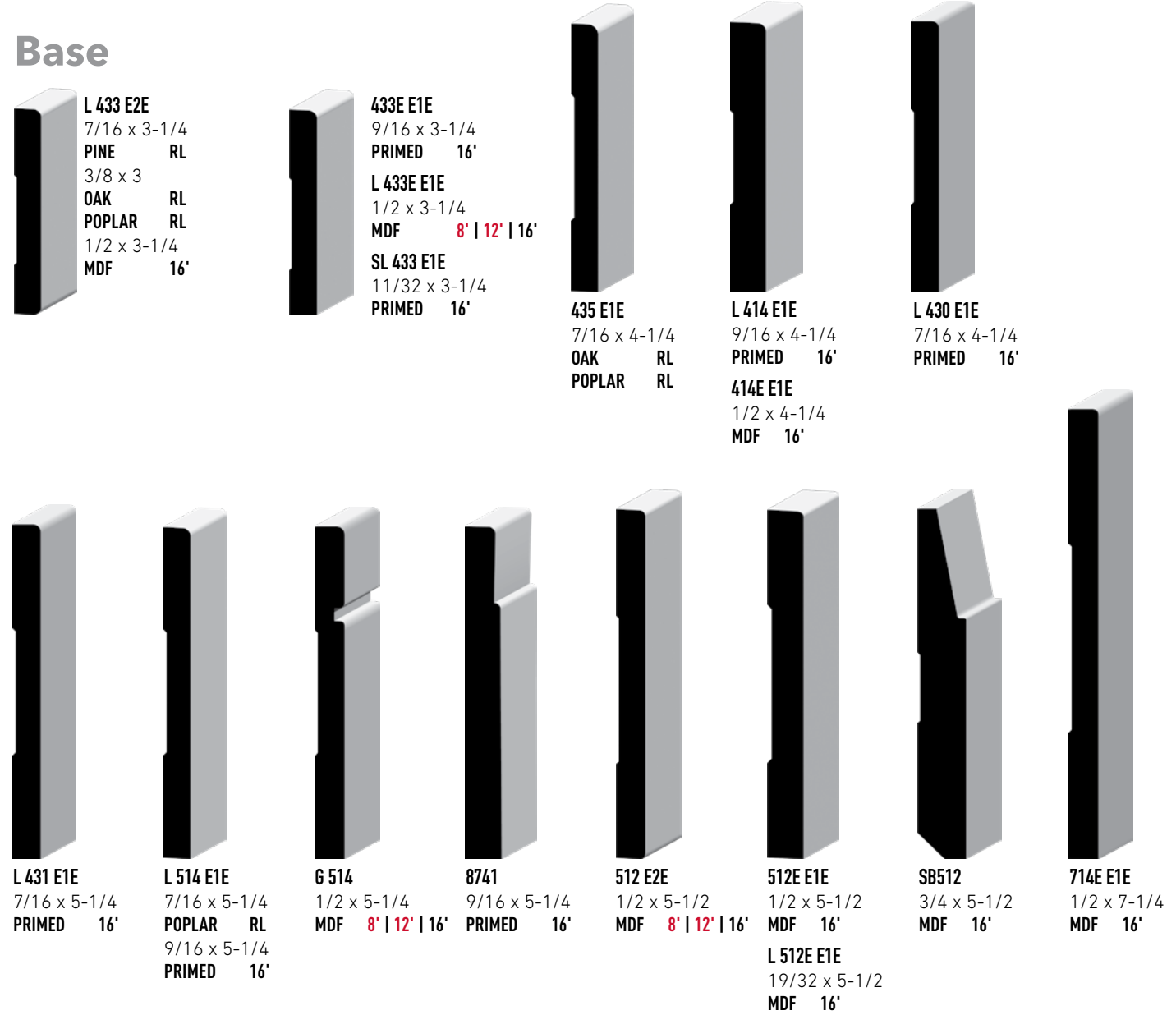

**L 433 E2E**  
7/16 x 3-1/4  
PINE RL  
3/8 x 3  
OAK RL  
POPLAR RL  
1/2 x 3-1/4  
MDF 16'

**433E E1E**  
9/16 x 3-1/4  
PRIMED 16'  
**L 433E E1E**  
1/2 x 3-1/4  
MDF 8' | 12' | 16'  
**SL 433 E1E**  
11/32 x 3-1/4  
PRIMED 16'

**435 E1E**  
7/16 x 4-1/4  
OAK RL  
POPLAR RL

**L 414 E1E**  
9/16 x 4-1/4  
PRIMED 16'  
**414E E1E**  
1/2 x 4-1/4  
MDF 16'

**L 430 E1E**  
7/16 x 4-1/4  
PRIMED 16'

**L 431 E1E**  
7/16 x 5-1/4  
PRIMED 16'

**L 514 E1E**  
7/16 x 5-1/4  
POPLAR RL  
9/16 x 5-1/4  
PRIMED 16'

**G 514**  
1/2 x 5-1/4  
MDF 8' | 12' | 16'

**8741**  
9/16 x 5-1/4  
PRIMED 16'

**512 E2E**  
1/2 x 5-1/2  
MDF 8' | 12' | 16'

**512E E1E**  
1/2 x 5-1/2  
MDF 16'

**SB512**  
3/4 x 5-1/2  
MDF 16'

**714E E1E**  
1/2 x 7-1/4  
MDF 16'

**L 512E E1E**  
19/32 x 5-1/2  
MDF 16'

Casing

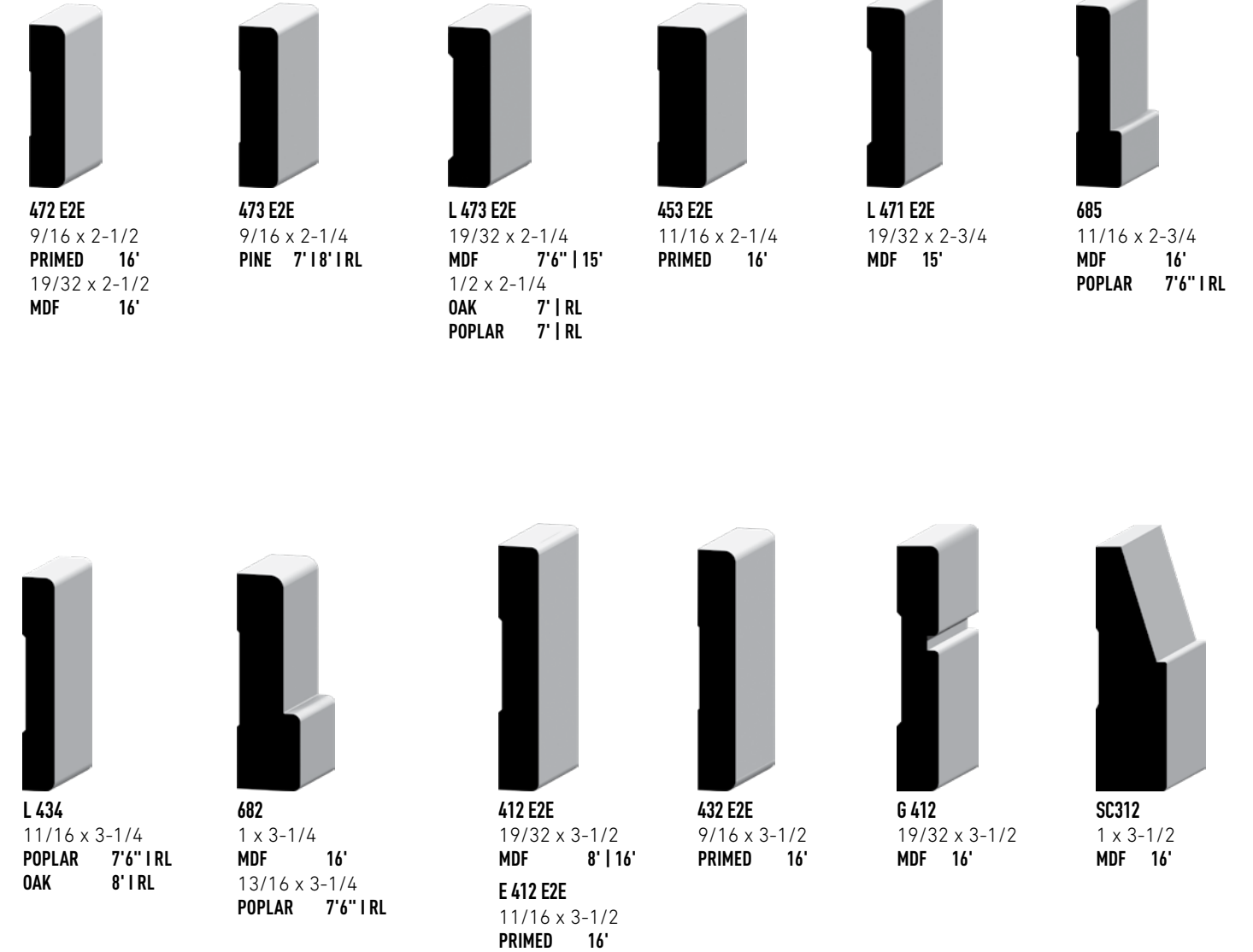

**472 E2E**  
9/16 x 2-1/2  
PRIMED 16'  
19/32 x 2-1/2  
MDF 16'

**473 E2E**  
9/16 x 2-1/4  
PINE 7' | 8' | RL

**L 473 E2E**  
19/32 x 2-1/4  
MDF 7'6" | 15'  
1/2 x 2-1/4  
OAK 7' | RL  
POPLAR 7' | RL

**453 E2E**  
11/16 x 2-1/4  
PRIMED 16'

**L 471 E2E**  
19/32 x 2-3/4  
MDF 15'

**685**  
11/16 x 2-3/4  
MDF 16'  
POPLAR 7'6" | RL

**L 434**  
11/16 x 3-1/4  
POPLAR 7'6" | RL  
OAK 8' | RL

**682**  
1 x 3-1/4  
MDF 16'  
13/16 x 3-1/4  
POPLAR 7'6" | RL

**412 E2E**  
19/32 x 3-1/2  
MDF 8' | 16'  
**E 412 E2E**  
11/16 x 3-1/2  
PRIMED 16'

**432 E2E**  
9/16 x 3-1/2  
PRIMED 16'

**G 412**  
19/32 x 3-1/2  
MDF 16'

**SC312**  
1 x 3-1/2  
MDF 16'

Miscellaneous

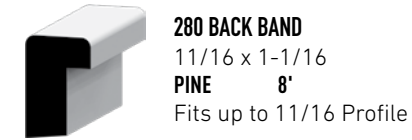

**280 BACK BAND**  
11/16 x 1-1/16  
PINE 8'  
Fits up to 11/16 Profile

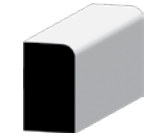

**L 254 SHOE**  
7/16 x 3/4  
PRIMED 8' | 12' | 16'  
POPLAR 2L





# Decorative Accessories

## ORNAMENTAL

DECORATIVE MILLWORK

A NOVO Building Products Company

Expressing a style comes easier and has greater impact when your choices—from ceiling to floor—are all unified. For nearly 100 years, Ornamental Mouldings has been providing distinctive, high-quality millwork to make entire living spaces more beautiful. Our decorative accessory styles inspired by tradition and shaped by the latest trends complement one another for unmatched selection, all in one place.

### Mantels and Floating Shelves



Whenever people enter a room, their eyes instantly take stock of the space. Reward their gaze with our Mantels and Floating Shelves, which marry function with details that convey a discerning sensibility.

Pattern	Product	H	D	L	Species
3 Ft. Mantel	<b>RUSTIC3WM</b>	5	7	36	Rustic maple
4 Ft. Mantel	<b>RUSTIC4WM</b>	5	7	48	
5 Ft. Mantel	<b>RUSTIC5WM</b>	5	7	60	
6 Ft. Mantel	<b>RUSTIC6WM</b>	5	7	72	

3 Ft. Mantel with insert	<b>RUSTIC3WM-01BK</b>	5	7	36	Rustic maple with aspen insert
4 Ft. Mantel with insert	<b>RUSTIC4WM-01BK</b>	5	7	48	
5 Ft. Mantel with insert	<b>RUSTIC5WM-01BK</b>	5	7	60	
6 Ft. Mantel with insert	<b>RUSTIC6WM-01BK</b>	5	7	72	

4 Ft. Mantel	<b>CLASSIC4WHW</b>	3 3/4	7 3/4	48	WHW
5 Ft. Mantel	<b>CLASSIC5WHW</b>	3 3/4	7 3/4	60	WHW
6 Ft. Mantel	<b>CLASSIC6WHW</b>	3 3/4	7 3/4	72	WHW

5 Ft. Mantel	<b>CLASSIC5OAK</b>	3 3/4	7 3/4	60	Oak
6 Ft. Mantel	<b>CLASSIC6OAK</b>	3 3/4	7 3/4	72	Oak



Farmhouse | **OML14B, OML24C** | Mantel and Beams

### Wood Beams



Practical elements like ceiling beams and wooden stairs are prime places for expressing your style. Our Wood Beams and Decorative Stair Parts give you the tools to achieve drama or convey delicate detailing.

Pattern	Product	H	W	L	Species
Prefinished gray beam	<b>BEAMGRAY-8WHW5x3</b>	3	5	96	Gray WHW
Prefinished gray beam	<b>BEAMGRAY-8WHW5x5</b>	5	5	96	Gray WHW

Rustic maple beam	<b>BEAMRUSTIC-8WM5x3</b>	3	5	96	Rustic maple
Wood beam	<b>BEAMRUSTIC-8WM5x5</b>	5	5	96	Rustic maple

3 inch metal beam-band/bracket	<b>BR-0003MTL</b>	3 9/64	1 1/2	6 7/16	Metal
5 inch metal beam-band/bracket	<b>BR-0005MTL</b>	5 17/64	1 1/2	6 5/16	Metal



Rustic | BR-0001WM, BEAMGRAY-8WHW5x5, 1248C, 1536, 917PB, 1537



Modern Farmhouse | PD001MD742PRIM

## Decorative Boards

Create an impact that is more than meets the eye. Use our Decorative Boards to express your creativity with combinations that even at first glance speak volumes about your personal style.



Pattern	Product	W	T	L	Species
Decorative boards	<b>AMAP 1/2X2X96</b>	1 1/2	7/16	96	Ambrosia Maple
	<b>WOAK 1/2x2x96</b>	1 1/2	7/16	96	White Oak
Decorative boards eased edge two sides	<b>1538-8GRAY</b>	1 1/2	7/16	96	Gray Stain
	<b>1538-8BLACK</b>	1 1/2	7/16	96	Black Stain
Decorative boards	<b>AMAP 1/2X4X96</b>	3 1/2	7/16	96	Ambrosia Maple
	<b>WOAK 1/2X4X96</b>	3 1/2	7/16	96	White Oak
Decorative boards eased edge two sides	<b>1536-8GRAY</b>	3 1/2	7/16	96	Gray Stain
	<b>1536-8BLACK</b>	3 1/2	7/16	96	Black Stain
Decorative boards	<b>AMAP 1/2X6X96</b>	5 1/2	7/16	96	Ambrosia Maple
	<b>WOAK 1/2X6X96</b>	5 1/2	7/16	96	White Oak
Decorative boards eased edge two sides	<b>1537-8GRAY</b>	5 1/2	7/16	96	Gray Stain
	<b>1537-8BLACK</b>	5 1/2	7/16	96	Black Stain

## Decorative Stair Parts

Pattern	Product	H	W	T	Species
Primed reversible decorative stair riser	<b>PD001MD742PRIM</b>	7 1/2	42	11/32	MDF
	<b>PD001MD748PRIM</b>	7 1/2	48	11/32	MDF

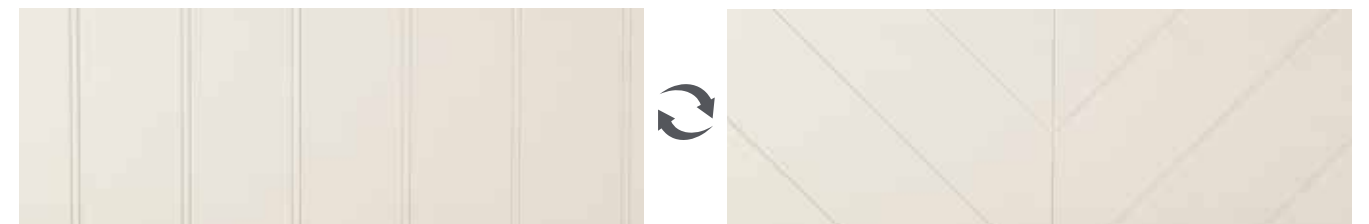

Primed reversible decorative oak stair riser	<b>PD0020AK742PRIM1</b>	7 1/2	42	11/32	Oak/Prime
	<b>PD0020AK748PRIM1</b>	7 1/2	48	11/32	Oak/Prime





# Build-Ups

## Combine moulding patterns to create a unique home style.

- Combine crowns, bases, casing, panel moulds, shoe or quarter rounds and more, to create detail, line and pattern.
- Use boards or square stock to build up depth.
- Combine square and eased edges to create richer detail.
- Use moulding with the same style families for a harmonious feel.
- Create completely unique build-ups to fit your own style.



Build-Up Option

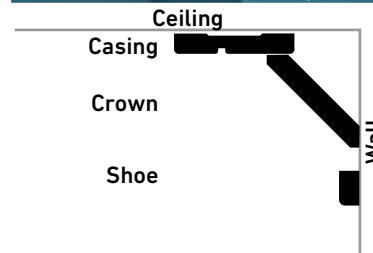

Build-Up Option

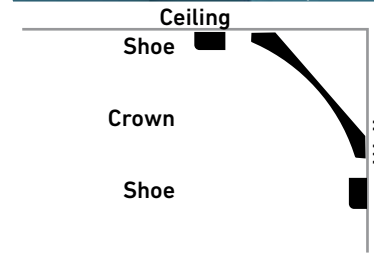

### Crown

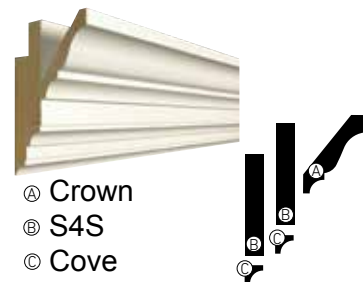

- Ⓐ Crown
- Ⓑ S4S
- Ⓒ Cove

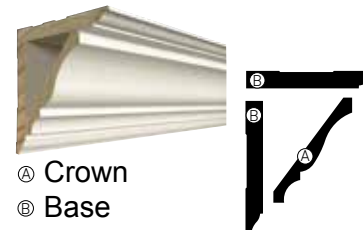

- Ⓐ Crown
- Ⓑ Base

### Chair Rail



- Ⓐ Cove
- Ⓑ S4S
- Ⓒ Chair Rail

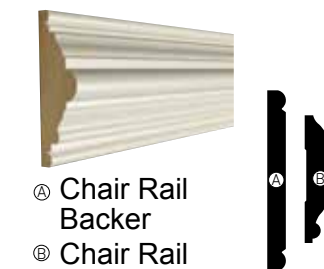

- Ⓐ Chair Rail Backer
- Ⓑ Chair Rail

### Casing

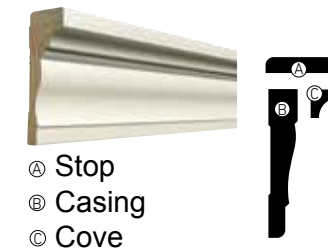

- Ⓐ Stop
- Ⓑ Casing
- Ⓒ Cove



- Ⓐ Cove
- Ⓑ Casing
- Ⓒ Shoe

### Base

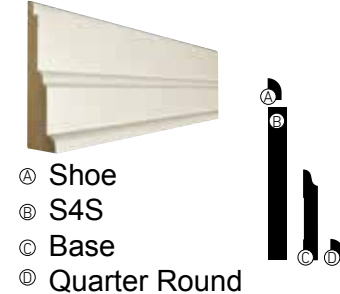

- Ⓐ Shoe
- Ⓑ S4S
- Ⓒ Base
- Ⓓ Quarter Round



- Ⓐ Cap
- Ⓑ S4S
- Ⓒ Quarter Round

SOFTWOOD   MDF			
L 248	11/16 x 1-3/4	CLEAR PINE	RL
(1X2)	11/16 x 1-3/4	PRIMED	16'
L 246	11/16 x 2-3/4	CLEAR PINE	RL
(1X3)	11/16 x 2-3/4	PRIMED	16'
1X4	11/16 x 3-1/2	CLEAR PINE	4'   6'   8'   10'   12'   14'   16'
	11/16 x 3-1/2	PRIMED	8'   12'
	(18mm) 11/16 x 3-1/2	MDF	16'
1X6	11/16 x 5-1/2	CLEAR PINE	6'   8'   10'   12'   14'   16'
	11/16 x 5-1/2	PRIMED	8'   12'
	(18mm) 11/16 x 5-1/2	MDF	16'
1X8	3/4 x 7-1/4	CLEAR PINE	8'   10'   12'   14'   16'
	3/4 x 7-1/4	PRIMED	8'   12'
	(18mm) 11/16 x 7-1/4	MDF	16'
1X10	3/4 x 9-1/4	CLEAR PINE	8'   10'   12'   14'   16'
	23/32 x 9-1/4	PRIMED	16'
	(18mm) 11/16 x 9-1/4	MDF	16'
1X12	3/4 x 11-1/4	CLEAR PINE	6'   8'   10'   12'   14'   16'
	23/32 x 11-1/4	PRIMED	8'   16'
	(18mm) 11/16 x 11-1/4	MDF	16'
5/4X4	1-1/16 x 3-1/2	PRIMED	12'   16'
	(25mm) 1 x 3-1/2	MDF	16'
5/4X6	1-1/16 x 5-1/2	PRIMED	12'   16'
	(25mm) 1 x 5-1/2	MDF	16'
5/4X8	1-1/16 x 7-1/4	PRIMED	16'
	(25mm) 1 x 7-1/4	MDF	16'
5/4X10	1-1/16 x 9-1/4	PRIMED	16'
5/4X12	1-1/16 x 11-1/4	PRIMED	16'
	(25mm) 1 x 11-1/4	MDF	16'

EASED EDGE MDF BOARDS		
E1X2	(17mm) 11/16 x 1-1/2	8'   10'
E1X3	(17mm) 11/16 x 2-1/2	8'
E1X4	(17mm) 11/16 x 3-1/2	8'   10'   12'   16' (18mm thick)
E1X6	(17mm) 11/16 x 5-1/2	8'   12'   16' (18mm thick)
E1X8	(17mm) 11/16 x 7-1/4	8'   16' (18mm thick)

SKIRTBOARDS			
1X12	3/4 x 11-1/4	OAK VENEER, POPLAR VENEER	18'
914E	1/2 x 9-1/4	MDF (S4S E1E BASE)	10'   18'
9713	(12mm) 1/2 x 9-1/4	MDF	10'   16'   18'
9623	(12mm) 1/2 x 9-1/4	MDF	10'   16'

HARDWOOD			
248	3/4 x 1-3/4	OAK	8'   RL
		POPLAR	8'   RL
246	3/4 x 2-3/4	OAK	8'
		POPLAR	RL
1X4	3/4 x 3-1/2	POPLAR, OAK	4'   6'   8'   10'   12'   14'   16'
		PRIMED FJ POPLAR	16'
		MAPLE	RL (Sold in unit quantities only)
1X6	3/4 x 5-1/2	POPLAR, OAK	4'   6'   8'   10'   12'   14'   16'
		PRIMED FJ POPLAR	16'
		MAPLE	RL (Sold in unit quantities only)
1X8	3/4 x 7-1/4	POPLAR, OAK	4'   6'   8'   10'   12'   14'   16'
		PRIMED FJ POPLAR	16'
		MAPLE	RL (Sold in unit quantities only)
1X10	3/4 x 9-1/4	POPLAR, OAK	8'   10'   12'   14'   16'
		MAPLE	RL (Sold in unit quantities only)
1X12	3/4 x 11-1/4	POPLAR	4'   6'   8'   10'   12'   14'   16'
		PRIMED FJ POPLAR	16'
		OAK	10'   12'   14'
		OAK VENEER	16'
5/4X4	1-1/16 x 3-1/2	POPLAR	RL
5/4X6	1-1/16 x 5-1/2	POPLAR	RL
5/4X8	1-1/16 x 7-1/4	POPLAR	RL
5/4X10	1-1/16 x 9-1/4	POPLAR	RL
5/4X12	1-1/16 x 11-1/4	POPLAR	RL

PVC			
TRIM BOARD - EMBOSSED / SMOOTH			
7833	1X3	3/4 x 2-1/2	8'
7318	1X4	3/4 x 3-1/2	8'   12'
9767	1X4	3/4 x 3-1/2	18'
7311	1X6	3/4 x 5-1/2	8'   12'
9769	1X6	3/4 x 5-1/2	18'
9770	1X8	3/4 x 7-1/4	18'
9771	1X10	3/4 x 9-1/4	18'
9772	1X12	3/4 x 11-1/4	18'
9775	5/4X4	1 x 3-1/2	18'
9777	5/4X6	1 x 5-1/2	18'
9778	5/4X8	1 x 7-1/4	18'
9779	5/4X10	1 x 9-1/4	18'
9780	5/4X12	1 x 11-1/4	18'

SHEETS		
PVC SHEETS - SMOOTH OR EMBOSSED		
4' x 8' PVC Sheets		
Available in thicknesses:		
3/8"   1/2"   3/4"   1"		
E 2878	3/8"	PVC
E 2871	1/2"	PVC
E 2837	3/4"	PVC
E 2864	1"	PVC

Reversible Finish  
Embossed / Smooth





## Species Definitions

DFIR	Doug Fir
DOUBLE PRIMED (FJPD)	Finger Joint Primed Pine (Double Pass)
MAPLE	Maple
MAPLS	Maple Boards
MDF (FBDPM)	Primed MDF Fiber Board
OAK (OAKSL)	Red Oak
OAKBD	Oak Board
PINE	Pine
PINEV	Pine Veneer
SPINE	Southern Yellow Pine
PRIMED (FJPM)	Finger Joint Primed Pine
POPLAR (POPLR)	Poplar
POPBD	Poplar Board
POPFP	Poplar Finger Joint Primed
VNLVL	Vinyl Wrapped Wood
WHITE	PVC Vinyl

**Finger-Jointed Moulding** from our quality suppliers is precision milled using advanced technology in a wide selection of profiles. The advanced manufacturing methods and the woods superior moulding characteristics result in long lengths and very few defects.

- All products should be inspected for manufacturing defects prior to painting or installing.
- Please store horizontally and off the floor, and let acclimate 72 hours prior to installation.
- Install with 15-18ga pin nails with proper air pressure to counter sink fastener 1/16".
- Use light weight spackle and paintable latex caulk when filling and sand with 80-120 grit paper.
- Finish with a good quality latex paint applied following the manufacturer's specifications.
- Manufacturing guidelines encompass tolerances of up to 1/32 inch.

**MDF** from our quality suppliers is light-weight and manufactured using eco-friendly standards. The superior workability of our MDF mouldings offers an ease of cutting, mitering and finishing, making it excellent for any size job. The combination of light-weight substrate, consistent easy to paint surface and long lengths, result in superior workmanship and a streamlined final finishing process.

- All products should be inspected for manufacturing defects prior to painting or installing.
- Please store horizontally and off the floor, and let acclimate 72 hours prior to installation.
- Install with 15-18ga pin nails with air pressure set 90-110psi to counter sink fastener 1/16".
- Use light weight spackle and paintable latex caulk when filling and sand with 80 grit paper.
- Finish with a good quality latex paint applied following the manufacturer's specifications.



**316**  
11/16 x 2-1/4  
PINE 7' | 10' | 14'  
PRIMED 7' | 10' | 14'  
5/8 x 2-1/4  
OAK 7' | RL



**321**  
11/16 x 2-1/4  
PINE RL



**324**  
11/16 x 2-1/4  
PINE RL  
PRIMED 7' | 10'



**L 324**  
1/2 x 2-1/4  
OAK 7' | RL



**327**  
11/16 x 2-1/4  
PINE 7' | 10' | 14' | RL  
PRIMED 14'



**356C**  
11/16 x 2-1/4  
PRIMED 15'



**L 356**  
1/2 x 2-1/4  
OAK 7' | 10' | RL  
**L 356 (14mm)**  
9/16 x 2-1/4  
MDF 7' | 10'



**356**  
11/16 x 2-1/4  
PINE 7' | 10' | 14'  
16' | RL  
PRIMED 7' | 14'  
19/32 x 2-1/4  
MDF 14'  
5/8 x 2-1/4  
OAK 7' | 8' | 10' | RL  
POPLAR 7' | RL



**366**  
11/16 x 2-1/4  
PINE 7' | 14'  
PRIMED 7' | 7'2" | 10' | 14'



**L 366 (14mm)**  
9/16 x 2-1/4  
OAK 7' | 10'



**366A**  
19/32 x 2-1/4  
MDF 7' | 14'



**376**  
11/16 x 2-1/4  
PRIMED 7'



**473 E2E**  
9/16 x 2-1/4  
PINE 7' | 8' | RL



**L 473 E2E**  
7/16 x 2-1/4  
PRIMED 16'  
19/32 x 2-1/4  
MDF 7'6" | 15'  
1/2 x 2-1/4  
OAK 7' | RL  
POPLAR 7' | RL



**453 E2E**  
11/16 x 2-1/4  
PRIMED 16'



# Casing



**472 E2E**  
9/16 x 2-1/2  
PRIMED 16'  
19/32 x 2-1/2  
MDF 16'



**351**  
11/16 x 2-1/2  
PINE 14'  
PRIMED 7' | 14'



**361**  
11/16 x 2-1/2  
PINE RL  
PRIMED 14'  
19/32 x 2-1/2  
MDF 14'  
9/16 x 2-1/2  
OAK RL



**4532**  
11/16 x 2-1/2  
MDF 15'



**P 380**  
11/16 x 2-3/4  
PINE RL  
PRIMED 7'4" | 7'6" | 15'  
MDF 16'  
POPLAR RL



**445**  
11/16 x 3-1/4  
PRIMED 15'



**445A**  
11/16 x 3-1/4  
MDF 8' | 16'



**L 444**  
11/16 x 3-1/4  
PINE 16' | RL  
PRIMED 7'6" | 15'  
POPLAR RL  
19/32 x 3-1/4  
MDF 16'  
3/4 x 3-1/4  
OAK 8' | RL



**795**  
11/16 x 2-1/2  
MDF 14'



**L 471 E2E**  
19/32 x 2-3/4  
MDF 15'



**474**  
11/16 x 2-3/4  
PRIMED 15'



**685**  
11/16 x 2-3/4  
MDF 16'  
POPLAR 7'6" | RL



**4520**  
11/16 x 2-3/4  
MDF 15'



**L 434**  
11/16 x 3-1/4  
POPLAR 7'6" | RL  
OAK 8' | RL



**683**  
11/16 x 3-1/4  
PRIMED 16'  
MDF 16'



**682**  
1 x 3-1/4  
MDF 16'  
13/16 x 3-1/4  
POPLAR 7'6" | RL



**L CC14**  
3/4 x 3-1/4  
MDF 16'



**PT3**  
1 x 3-1/4  
MDF 8' | 12' | 16'



**2496**  
11/16 x 3  
PRIMED 16'



**312**  
19/32 x 3  
MDF 8' | 16'



**411**  
11/16 x 3  
MDF 16'



**40**  
9/16 x 3-1/4  
OAK RL



**L 366**  
11/16 x 3-1/4  
PRIMED 15'



**L 338**  
9/16 x 3-3/8  
MDF 8'



**374**  
11/16 x 3-1/2  
PRIMED 16'  
MDF 16'  
3/4 x 3-1/2  
OAK RL



**L 361**  
11/16 x 3-1/2  
PRIMED 7'4" | 15'



**L 361C**  
11/16 x 3-1/2  
PRIMED 16'



**B G312**  
11/16 x 3-1/2  
MDF 16'



**G 412**  
19/32 x 3-1/2  
MDF 16'



**412 E2E**  
19/32 x 3-1/2  
MDF 8' | 16'

**E412 E2E**  
11/16 x 3-1/2  
PRIMED 16'

**432 E2E**  
9/16 x 3-1/2  
PRIMED 16'



**535**  
11/16 x 3-1/2  
MDF 16'

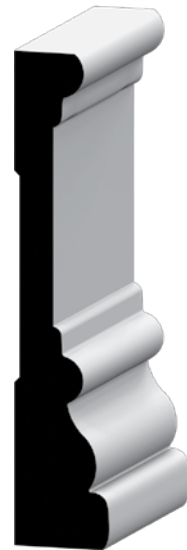

**P 450**  
11/16 x 3-1/2  
PRIMED 7'4" | 10' | 16'  
MDF 16'



**RB3**  
1 x 3-1/2  
MDF 16'



**S RB3**  
1-1/16 x 3-1/2  
PRIMED 16'



**SC312**  
1 x 3-1/2  
MDF 16'



**465**  
11/16 x 4-1/4  
MDF 16'



**B G412**  
11/16 x 4-1/2  
MDF



**444**  
11/16 x 3-1/2  
PINE 8'  
PRIMED 8' | 12' | 16'



**444A**  
11/16 x 3-1/2  
MDF 16'



**C PT11**  
3/4 x 3-1/2  
MDF 16'



**446**  
11/16 x 3-1/2  
MDF 16'



**EDC97**  
1 x 3-1/2  
MDF 16'



**BULLSEYE ROSETTE**  
**642**  
5/8 x 2-1/2  
PINE  
WHITE WOOD  
OAK

**734**  
27/32 x 3-1/2  
13/16 x 3-1/2  
WHITE WOOD  
OAK

**740**  
27/32 x 4-1/2  
WHITE WOOD

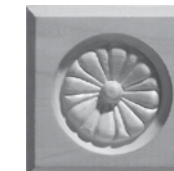

**FLORAL ROSETTE - BEVELED**  
**871**  
1-1/16 x 3-1/2  
PINE  
WHITE WOOD  
OAK

**915**  
27/32 x 2-1/2  
PINE  
WHITE WOOD  
OAK



**BULLSEYE ROSETTE - BEVELED**  
**1400**  
7/8 x 2-3/4  
PRIMED  
OAK

**1402**  
7/8 x 3-3/4  
PRIMED  
OAK



**STAR ROSETTE**  
**1200**  
1-1/16 x 3-1/2  
WHITE WOOD



**BULLSEYE ROSETTE - BEVELED**  
**3**  
7/8 x 3  
MDF

**334**  
7/8 x 3-3/4  
MDF

**438**  
1 x 4-3/8  
MDF



**BULLSEYE ROSETTE - BEVELED**  
**P 358 35**  
1 x 3-5/8  
POPLAR





Pictured: **SL16** Shiplap | **5030** Architrave | **E412 E2E** Casing

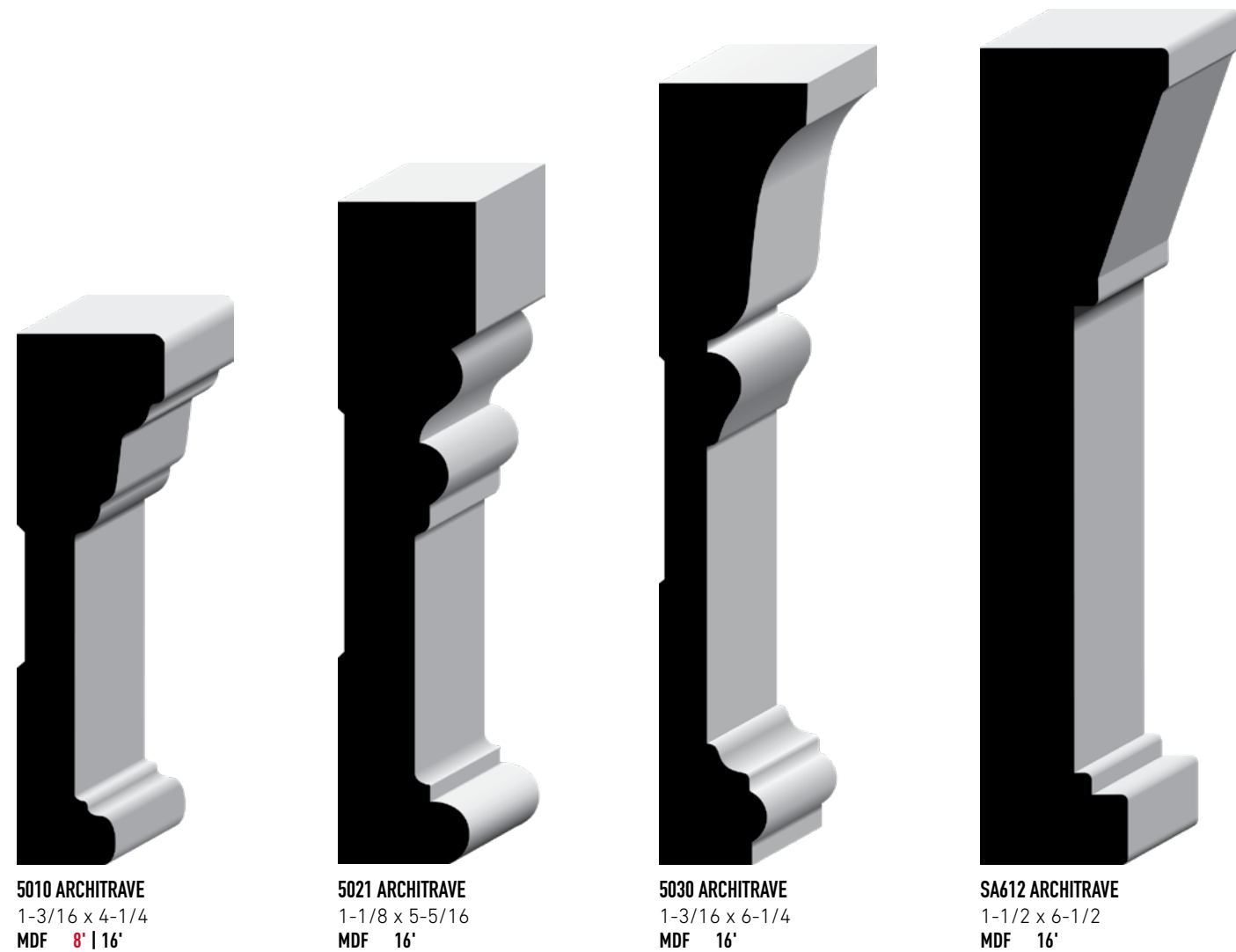

**5010 ARCHITRAVE**  
1-3/16 x 4-1/4  
MDF **8'** | 16'

**5021 ARCHITRAVE**  
1-1/8 x 5-5/16  
MDF 16'

**5030 ARCHITRAVE**  
1-3/16 x 6-1/4  
MDF 16'

**SA612 ARCHITRAVE**  
1-1/2 x 6-1/2  
MDF 16'

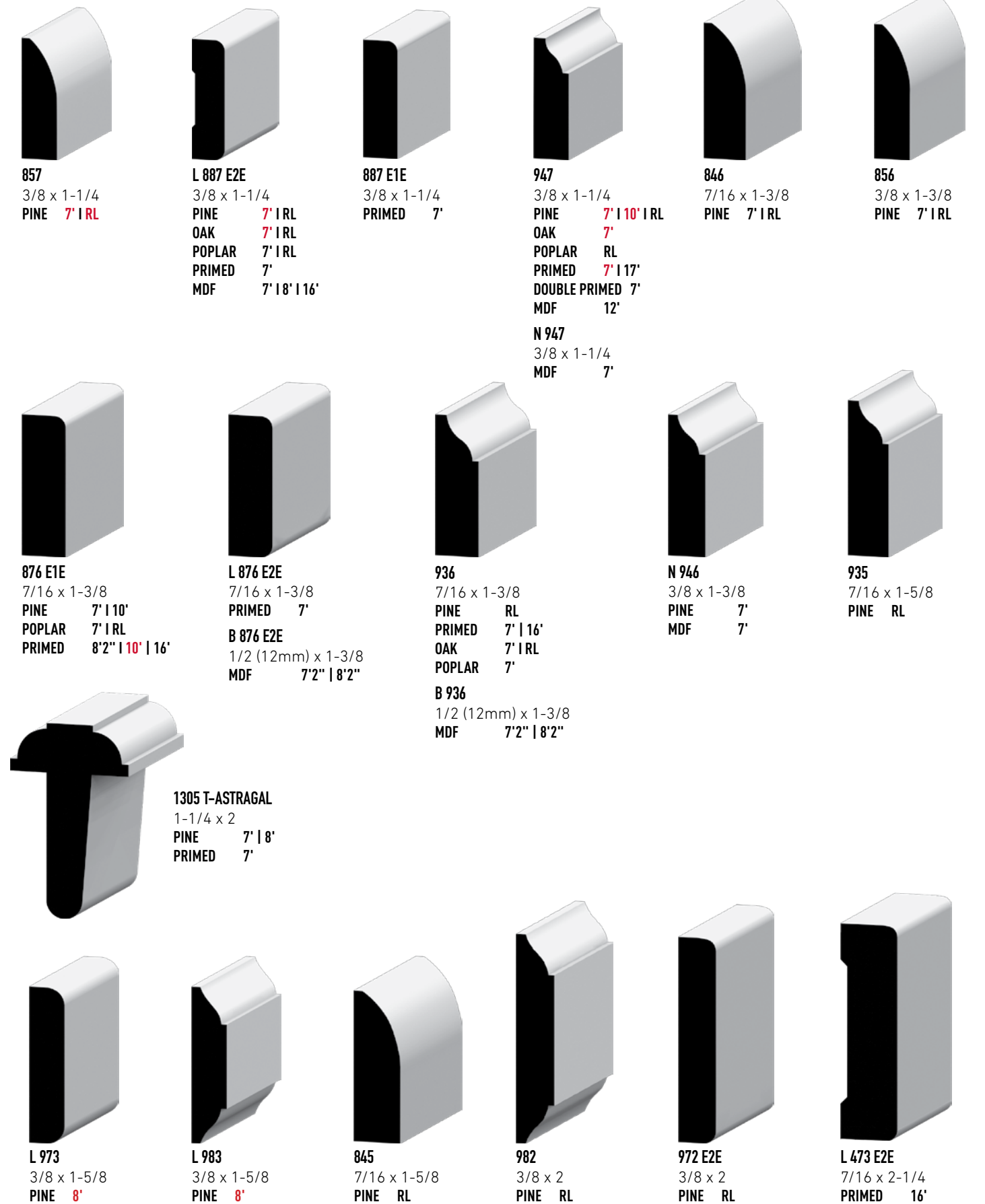

**857**  
3/8 x 1-1/4  
PINE **7'** | RL

**L 887 E2E**  
3/8 x 1-1/4  
PINE **7'** | RL  
OAK **7'** | RL  
POPLAR **7'** | RL  
PRIMED 7'  
MDF 7' | 18' | 116'

**887 E1E**  
3/8 x 1-1/4  
PRIMED 7'

**947**  
3/8 x 1-1/4  
PINE **7'** | **10'** | RL  
OAK **7'**  
POPLAR RL  
PRIMED **7'** | 17'  
DOUBLE PRIMED 7'  
MDF 12'

**846**  
7/16 x 1-3/8  
PINE 7' | RL

**856**  
3/8 x 1-3/8  
PINE 7' | RL

**N 947**  
3/8 x 1-1/4  
MDF 7'



**876 E1E**  
7/16 x 1-3/8  
PINE 7' | 10'  
POPLAR 7' | RL  
PRIMED **8'2"** | **10'** | 16'



**L 876 E2E**  
7/16 x 1-3/8  
PRIMED 7'  
**B 876 E2E**  
1/2 (12mm) x 1-3/8  
MDF 7'2" | 8'2"



**936**  
7/16 x 1-3/8  
PINE RL  
PRIMED 7' | 16'  
OAK 7' | RL  
POPLAR 7'



**N 946**  
3/8 x 1-3/8  
PINE 7'  
MDF 7'



**935**  
7/16 x 1-5/8  
PINE RL



**1305 T-ASTRAGAL**  
1-1/4 x 2  
PINE 7' | 8'  
PRIMED 7'



**L 973**  
3/8 x 1-5/8  
PINE **8'**



**L 983**  
3/8 x 1-5/8  
PINE **8'**



**845**  
7/16 x 1-5/8  
PINE RL



**982**  
3/8 x 2  
PINE RL



**972 E2E**  
3/8 x 2  
PINE RL

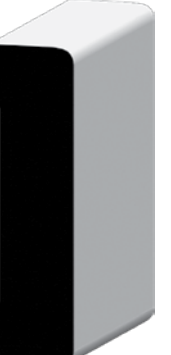

**L 473 E2E**  
7/16 x 2-1/4  
PRIMED 16'

# Brick | Stool

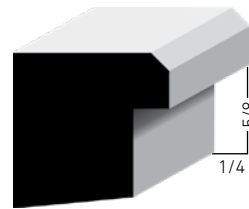

**B 6200 BEVEL NOSE  
BACK BAND**  
1-1/16 x 1-1/16  
PRIMED 16'

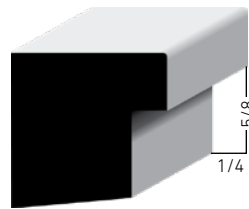

**B 6250 BACK BAND**  
1-1/16 x 1-1/16  
PRIMED 16'

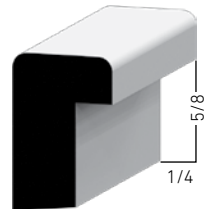

**280 BACK BAND**  
11/16 x 1-1/16  
PINE 8'  
Fits up to 11/16 Profile

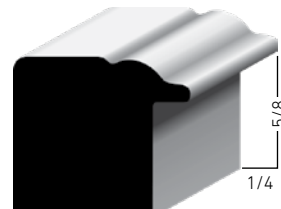

**279 BACK BAND**  
1-1/16 x 1-1/8  
PRIMED 16'

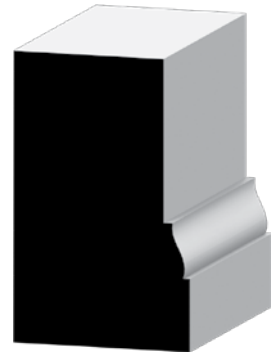

**180 BRICK MOULD**  
1-1/4 x 2  
PRIMED 8' | 10' | 117'



**L 197 DRIP CAP**  
5/8 x 1-5/8  
PINE RL



**H 282 BACK BAND**  
2 x 1-1/4  
POPLAR RL

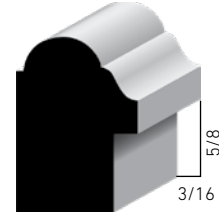

**227 BACK BAND**  
1-1/16 x 1-17/32  
PRIMED 16'



**E 1035 EXTENDED  
HALF ROUND**  
1/2 x 1-3/8  
MDF 8'  
POPLAR 8' | 1RL



**4 1021**  
11/16 x 4-1/2  
PRIMED 16'



**1153 STOOL**  
11/16 x 3-1/4  
PINE RL



**1021 STOOL**  
11/16 x 5-1/4  
PINE RL  
MDF 16'  
PRIMED 16'



**7 1021 STOOL**  
11/16 x 7-1/4  
PRIMED 16'

# Jambs | Frames

EMPIRE SKU	LENGTH	SPECIE	DESCRIPTION
458 68 FJPMDF	6'8"	Finger Joint Primed Pine	11/16 X 4-5/8 JAMB PAIR 81BD
458 80 FJPMDF	8'	Finger Joint Primed Pine	11/16 X 4-5/8 JAMB PAIR 97BD
478 68 FJPMDF	6'8"	Finger Joint Primed Pine	11/16 X 4-7/8 FLAT JAMB PAIR 81BD
478 70 FJPMDF	7'	Finger Joint Primed Pine	11/16 X 4-7/8 FLAT JAMB PAIR 85BD
478 80 FJPMDF	8'	Finger Joint Primed Pine	11/16 X 4-7/8 FLAT JAMB PAIR 97BD
5 70 FJPMDF	7'	Finger Joint Primed Pine	11/16 X 5 JAMB PAIR 85BD
5 80 FJPMDF	8'	Finger Joint Primed Pine	11/16 X 5 JAMB PAIR 97BD
514 68 FJPMDF	6'8"	Finger Joint Primed Pine	11/16 X 5-1/4 FLAT JAMB PAIR 81BD
678 68 FJPMDF	6'8"	Finger Joint Primed Pine	11/16 X 6-7/8 FLAT JAMB PAIR 81BD
678 80 FJPMDF	8'	Finger Joint Primed Pine	11/16 X 6-7/8 FLAT JAMB PAIR 97BD
4916 68 FJPMDF	6'8"	Finger Joint Primed Pine	11/16 X 4-9/16 JAMB PAIR 81BD
2 4916 68 SPTFP	6'8"	Finger Joint Primed Pine	4-9/16 X 2-3/4 X 2-1/2 SPLIT JAMB PAIR
4916 70 FJPMDF	7'	Finger Joint Primed Pine	11/16 X 4-9/16 JAMB PAIR 85BD
4916 R7 FJPMDF	17'	Finger Joint Primed Pine	11/16 X 4-9/16 JAMB LINEAL
6916 70 FJPMDF	7'	Finger Joint Primed Pine	11/16 X 6-9/16 JAMB PAIR 85BD
6916 80 FJPMDF	8'	Finger Joint Primed Pine	11/16 X 6-9/16 JAMB PAIR 97BD
714 80 FJPMDF	8'	Finger Joint Primed Pine	11/16 X 7-1/4 JAMB PAIR 97BD
2 4916 68 SPLTS	6'8"	Pine	4-9/16 X 2-3/4 FM X 2-1/2 M SPLIT JAMB PAIR
<b>X4916 68 PINEV</b>	6'8"	Pine Veneer w/FJ Core	11/16 X 4-9/16 JAMB PAIR
478 68 PINEV	6'8"	Pine Veneer w/FJ Core	11/16 X 4-7/8 JAMB PAIR 81BD
514 68 PINEV	6'8"	Pine Veneer w/FJ Core	11/16 X 5-1/4 JAMB PAIR
6916 68 PINEV	6'8"	Pine Veneer w/FJ Core	11/16 X 6-9/16 JAMB PAIR 81BD
4916 68 POPFP	6'8"	FJ Primed Poplar	11/16 X 4-9/16 JAMB PAIR 81BD
458 68 MDF	6'8"	MDF	11/16 X 4-5/8 JAMB PAIR 81BD
4131 68 FBDPM	6'8"	MDF	17MM(11/16)X 4-13/16 FLAT JAMB PAIR 81BD
3 4131 68 FBDPM	6'8"	MDF	17MM(11/16)X 4-13/16 FLAT JAMB PAIR 81-3/8BD
3 4916 68 FBDPM	6'8"	MDF	PR17MM(11/16) X 4-9/16 FLT JAMB 81-3/8BD
X 4916 68 FBDPM	6'8"	MDF	11/16 X 4-9/16 JAMB SIDE 81BD
V 4916 68 OAKOV	6'8"	OAK Veneer	11/16 X 4-9/16 JAMB PAIR 81BD



# Base Block | Base Cap

# Base



**PLINTH BLOCK - BEVELED**  
**1401 PB**  
 7/8 x 2-3/4 x 4-1/2 **PRIMED OAK**

**1403 PB**  
 7/8 x 3-3/4 x 6 **PRIMED OAK**

**917 PB**  
 1-1/8 x 3-1/2 x 6-1/2 **PINE OAK**



**PLINTH BLOCK - MOULDED**  
**887 PB**  
 27/32 x 2-1/2 x 5-3/4 **WHITE WOOD**

**742 PB**  
 1-1/8 x 3-1/2 x 6-1/2 **PINE OAK WHITE WOOD**

**334 PB**  
 1 x 3-3/4 x 9 **MDF**

**438 PB**  
 1 x 4-3/8 x 9 **MDF**

**743 PB**  
 1-1/16 x 4-1/2 x 8 **WHITE WOOD**



**L 634**  
 7/16 x 3  
**PINE 8' | 12' | RL**  
**PRIMED 8' | 12' | 16'**  
 3/8 x 2-3/4  
**OAK 8' | 12'**



**L 724**  
 7/16 x 3  
**PINE 8' | 12' | 16'**  
**PRIMED 8' | 12' | 16'**  
 3/8 x 2-3/4  
**OAK 8' | 12'**



**714**  
 9/16 x 3  
**PINE RL**

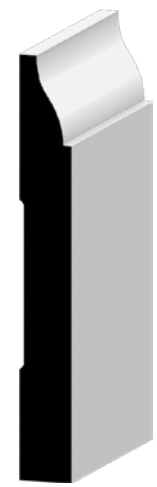

**L 635**  
 3/8 x 3  
**OAK 2L**



**BASE BLOCK - OUTSIDE CORNER**  
**892**  
 1-1/8 x 6-3/4 **WHITE WOOD**

**8920**  
 1-1/8 x 6-3/4 **PINE OAK**

**9 0S**  
 1-1/4 x 9 **MDF**



**BASE BLOCK - OUTSIDE CORNER**  
**1892**  
 1-1/8 x 6-1/2 **PRIMED OAK**

**BASE BLOCK - INSIDE CORNER**  
**1895**  
 1-1/8 x 6-1/2 **PRIMED OAK**

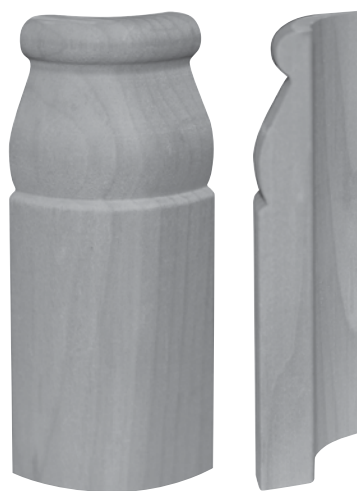

**RADIUS BASE BLOCK**  
**P 808**  
 9/16 x 4-1/4 x 3/4 **RAD**  
**POPLAR**

**P 813**  
 9/16 x 5-1/4 x 3/4 **RAD**  
**POPLAR**

**BASE BLOCK - INSIDE CORNER**  
**895**  
 7/8 x 6-3/4 **WHITE WOOD**

**8951**  
 7/8 x 6-3/4 **PINE OAK**

**9 1S**  
 7/8 x 9 **MDF**



**166 BASE CAP**  
 11/16 x 1-1/4  
**PINE RL**  
**PRIMED 16'**



**163 BASE CAP**  
 11/16 x 1-3/8  
**MDF 16'**  
**POPLAR RL**

**L 163 BASE CAP**  
 5/8 x 1-3/8  
**PRIMED 8' | 12'**



**8740 BASE CAP**  
 5/8 x 1-3/4  
**PRIMED 16'**



**L 433 E2E**  
 7/16 x 3-1/4  
**PINE RL**  
 3/8 x 3  
**OAK RL**  
**POPLAR RL**  
 1/2 x 3-1/4  
**MDF 16'**



**433E E1E**  
 9/16 x 3-1/4  
**PRIMED 16'**

**L 433E E1E**  
 1/2 x 3-1/4  
**MDF 8' | 12' | 16'**

**S L433 E1E**  
 11/32 x 3-1/4  
**PRIMED 16'**



**623**  
 9/16 x 3-1/4  
**PINE 8' | 12' | 16' | RL**  
**PRIMED 8' | 10' | 12' | 16'**  
 1/2 x 3-1/4  
**MDF 8' | 12' | 16'**



**L 633**  
 7/16 x 3-1/4  
**PINE RL**  
**PRIMED 16'**



**H 633**  
1/2 x 3-1/4  
OAK RL  
POPLAR RL



**663**  
9/16 x 3-1/4  
PINE RL  
PRIMED 16'  
1/2 x 3-1/4  
MDF 16'



**P 805**  
9/16 x 3-1/4  
PRIMED 8' | 12'  
PRIMED 16'



**B366**  
9/16 x 3-1/4  
MDF 16'



**L 414 E1E**  
9/16 x 4-1/4  
PRIMED 16'



**414E E1E**  
1/2 x 4-1/4  
MDF 16'



**L 430 E1E**  
7/16 x 4-1/4  
PRIMED 16'



**435 E1E**  
7/16 x 4-1/4  
OAK RL  
POPLAR RL



**713**  
9/16 x 3-1/4  
PINE 8' | 16'  
PRIMED 8' | 12' | 16'



**L 723**  
7/16 x 3-1/4  
PINE RL



**620**  
9/16 x 4-1/4  
PINE 8' | 12' | 16' | RL  
PRIMED 8' | 12' | 16'  
1/2 x 4-1/4  
MDF 8' | 12' | 16'



**L 620**  
1/2 x 4-1/4  
OAK 2L  
POPLAR RL



**410**  
19/32 x 4-1/4  
MDF 16'



**BC14**  
11/16 x 4-1/4  
MDF 16'



**P 808**  
9/16 x 4-1/4  
PINE RL  
PRIMED 8' | 12' | 16'  
1/2 x 4-1/4  
MDF 16'  
OAK RL  
POPLAR RL





**B PT11**  
9/16 x 4-1/2  
MDF 16'



**545**  
19/32 x 5  
MDF 16'



**163E**  
19/32 x 5-1/4  
MDF 16'



**763**  
19/32 x 5-1/4  
MDF 16'



**B 312**  
19/32 x 5-1/4  
MDF 16'



**L 618**  
1/2 x 5-1/4  
MDF 16'



**L 431 E1E**  
7/16 x 5-1/4  
PRIMED 16'



**L 514 E1E**  
7/16 x 5-1/4  
POPLAR RL  
9/16 x 5-1/4  
PRIMED 16'



**G 514**  
1/2 x 5-1/4  
MDF 8' | 12' | 16'



**674**  
9/16 x 5-1/4  
PRIMED 16'  
1/2 x 5-1/4  
OAK RL



**658**  
9/16 x 5-1/4  
PRIMED 16'



**695**  
1/2 x 5-1/4  
OAK RL

**L 163E**  
1/2 x 5-1/4  
MDF 8' | 12'  
9/16 x 5-1/4  
PRIMED 8' | 12' | 16'

**618**  
9/16 x 5-1/4  
PINE RL  
PRIMED 8' | 12' | 16'



**P 813**  
9/16 x 5-1/4  
PINE RL  
PRIMED 16'  
1/2 x 5-1/4  
MDF 16'  
POPLAR RL



**L P 813**  
19/32 x 5-1/4  
MDF 16'



**512 EZE**  
1/2 x 5-1/2  
MDF 8' | 12' | 16'



**B G512**  
9/16 x 5-1/2  
MDF 16'

**8740 BASE CAP**  
5/8 x 1-3/4  
PRIMED 16'



**8741**  
9/16 x 5-1/4  
PRIMED 16'



**512E E1E**  
1/2 x 5-1/2  
MDF 16'



**L 512E E1E**  
19/32 x 5-1/2  
MDF 16'



**8263**  
19/32 x 6-1/2  
MDF 16'



**SB512**  
3/4 x 5-1/2  
MDF 16'

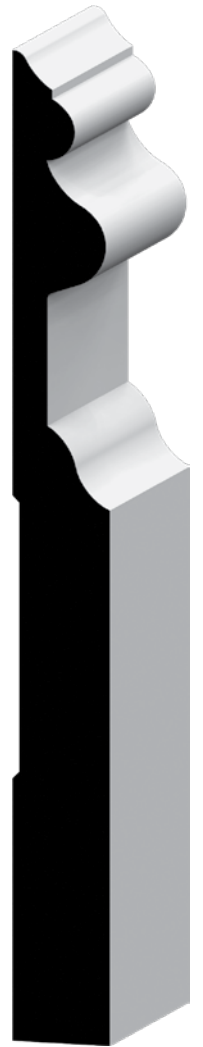

**263**  
11/16 x 7  
PRIMED 16'





**L P815**  
19/32 x 7-1/4  
MDF 16'



**765**  
19/32 x 7-1/4  
MDF 16'



**7163**  
19/32 x 7-1/4  
MDF 16'



**G 714**  
1/2 x 7-1/4  
MDF 16'



**714E E1E**  
1/2 x 7-1/4  
MDF 16'



**207**  
19/32 x 7-1/4  
MDF 16'



**B G712**  
9/16 x 7-1/2  
MDF 16'



**9713 SKIRTBOARD**  
(12mm) 1/2 x 9-1/4  
MDF 10' | 16' | 18'



**9623 SKIRTBOARD**  
1/2 x 9-1/4  
MDF 10' | 16'



**914E SKIRTBOARD**  
1/2 x 9-1/4  
MDF 10' | 18'

# Chair Rail | Panel Mould



**2464**  
3/4 X 2  
PRIMED 16'



**391**  
11/16 x 2-1/4  
PINE RL



**L 390**  
9/16 x 2-5/8  
MDF 8' | 12'

**390**  
11/16 x 2-5/8  
PINE 8' | RL  
PRIMED 16'  
19/32 x 2-5/8  
MDF 16'  
5/8 x 2-5/8  
OAK 8' | RL  
POPLAR RL



**L 300**  
1 x 2-7/8  
MDF 16'



**L 301**  
1 x 3-1/4  
MDF 16'



**171 SHELF EDGE**  
9/16 x 3/4  
POPLAR 8'



**427 (A9) PANEL MOULD**  
9/16 x 1-1/8  
PRIMED 16'



**260 SHELF EDGE**  
11/16 x 1-1/4  
OAK 8'  
POPLAR 8'



**185 PANEL MOULD**  
9/32 x 1-3/8  
PINE RL



**L 184 PANEL MOULD**  
1/2 x 1-1/2  
PRIMED 16'



**2448 PANEL MOULD**  
3/4 x 1-1/2  
PRIMED 16'



**182 PANEL MOULD**  
11/16 x 1-5/8  
PRIMED 16'



**281 BACK BAND**  
11/16 x 1-1/8  
PINE RL  
Fits up to 11/16 Profile



**292 PLY CAP**  
9/16 x 1-1/8  
PINE 8' | RL



**L 294 CAP**  
11/16 x 1-1/16  
OAK 8'



**L WCAP WAINSCOTING CAP**  
11/16 x 2  
MDF 8'



**190 PANEL MOULD**  
1 x 2  
POPLAR RL

# Wainscoting | Shiplap

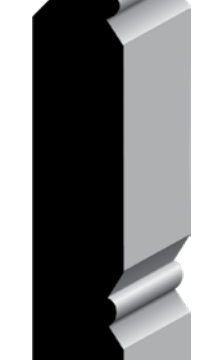

**1x4 EC WAINSCOTING**  
23/32 x 3-1/2  
PRIMED 16'  
Reversible



**1x6 EC WAINSCOTING**  
23/32 x 5-1/2  
PRIMED 16'  
Reversible



**L WP4 WAINSCOTING**  
19/32 x 5  
MDF 16'  
Reversible



**L SBW4 WAINSCOTING**  
19/32 x 5-1/4  
MDF 16'



**E WP4 WAINSCOTING**  
19/32 x 5  
MDF 16'  
Primed 3 sides only



**L BEAD WAINSCOTING**  
19/32 x 5-1/4  
MDF 16'  
Primed only three sides

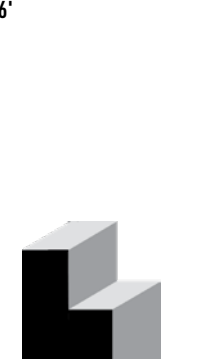

**L SL16 NICKEL GAP**  
5/8 x 5-3/8  
PRIMED 16'



**L SL18 NICKEL GAP**  
5/8 x 7-3/8  
PRIMED 16'



**SL16 TONGUE & GROOVE SHIPLAP**  
11/16 x 5-1/4  
MDF 16'



**SL18 TONGUE & GROOVE SHIPLAP**  
11/16 x 7-1/4  
MDF 16'



# Cove | Bed | Crown

# Crown

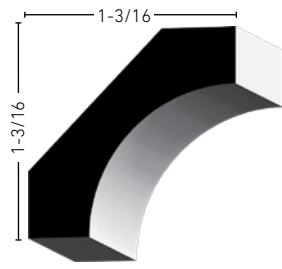

**85**  
9/16 x 1-3/4  
PINE **8' | 12'** | RL

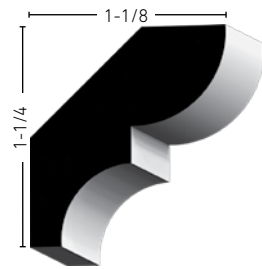

**75**  
9/16 x 1-5/8  
PINE RL

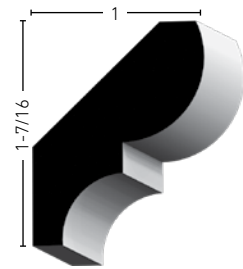

**74**  
9/16 x 1-3/4  
PINE RL  
PRIMED **8' | 12'** | 16'

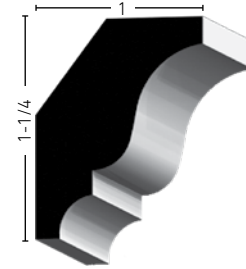

**68**  
9/16 x 1-5/8  
PINE RL

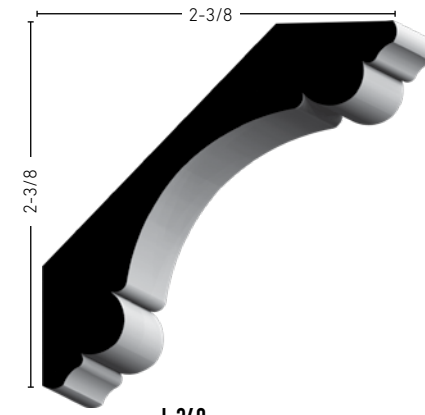

**L 340**  
11/16 x 3-3/8  
MDF **8' | 12'** | 16'

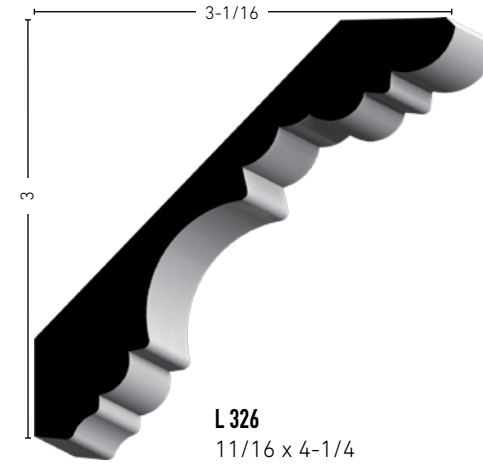

**L 326**  
11/16 x 4-1/4  
MDF 16'

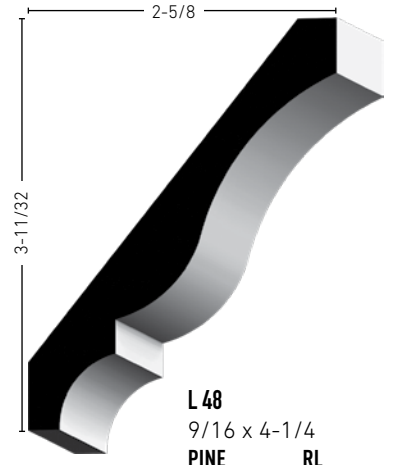

**L 48**  
9/16 x 4-1/4  
PINE RL  
PRIMED 16'  
19/32 x 4-1/4  
MDF 16'

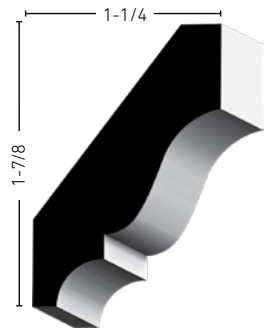

**54**  
9/16 x 2-1/4  
PINE **8'** | RL  
PRIMED 16'

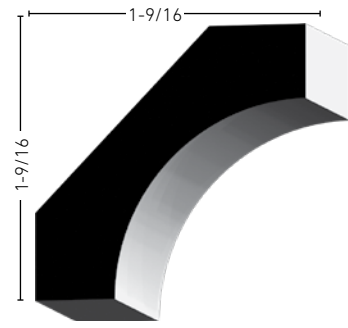

**84**  
9/16 x 2-1/4  
PINE RL

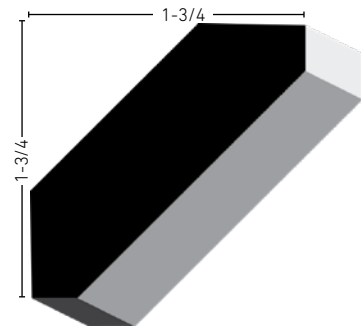

**200**  
11/16 x 2-1/2  
MDF 16'

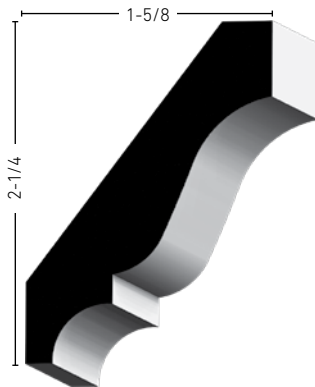

**52**  
9/16 x 2-3/4  
PINE RL

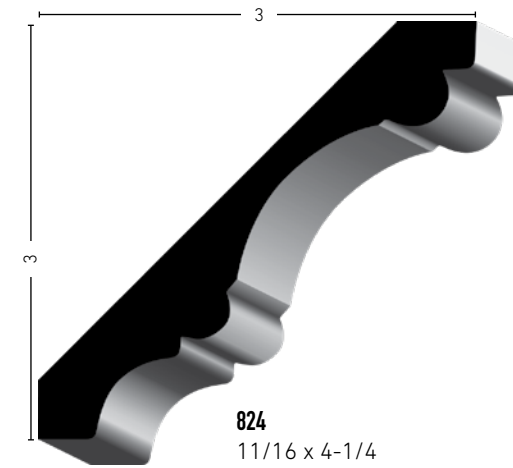

**824**  
11/16 x 4-1/4  
MDF 16'

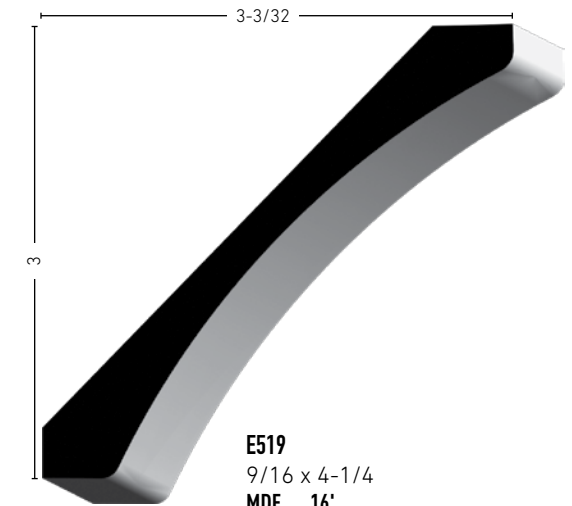

**E519**  
9/16 x 4-1/4  
MDF 16'

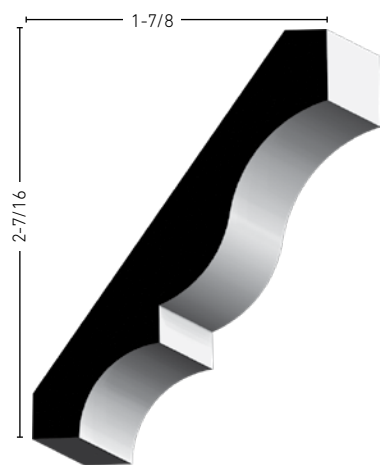

**51**  
1/2 x 3-1/4  
OAK RL

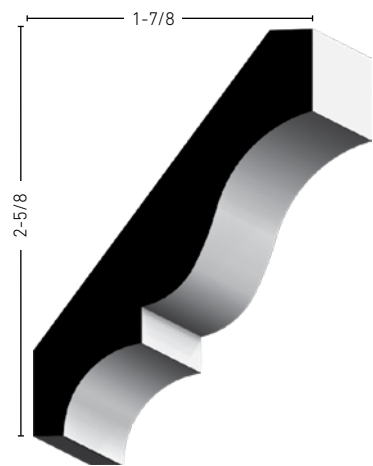

**L 51**  
9/16 x 3-1/4  
PINE **12'** | RL  
PRIMED **8' | 12'** | 16'

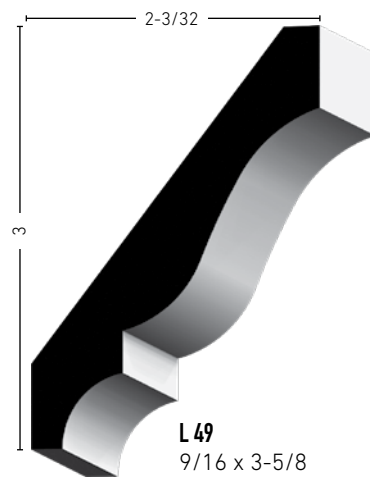

**L 49**  
9/16 x 3-5/8  
PINE RL  
PRIMED 16'  
19/32 x 3-5/8  
MDF 16'

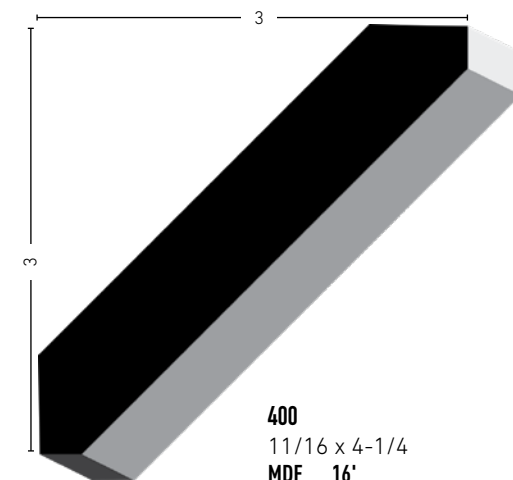

**400**  
11/16 x 4-1/4  
MDF 16'

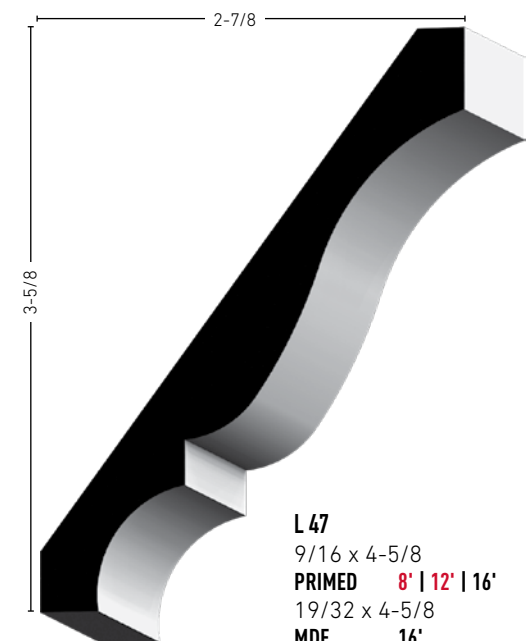

**L 47**  
9/16 x 4-5/8  
PRIMED **8' | 12'** | 16'  
19/32 x 4-5/8  
MDF 16'

# Crown

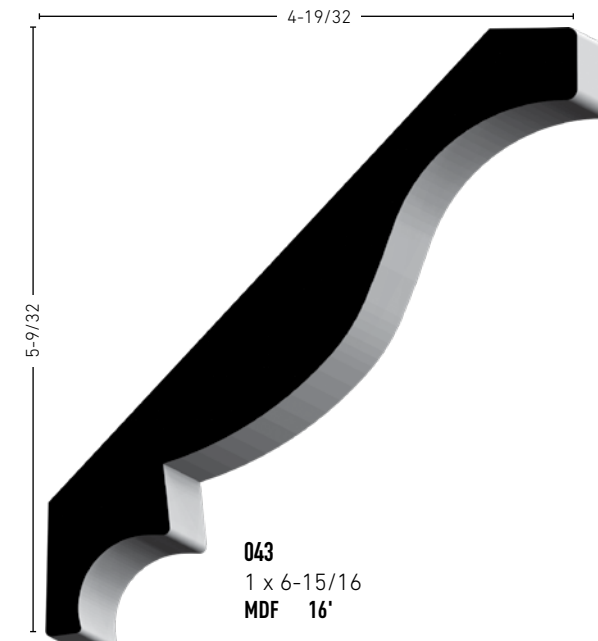
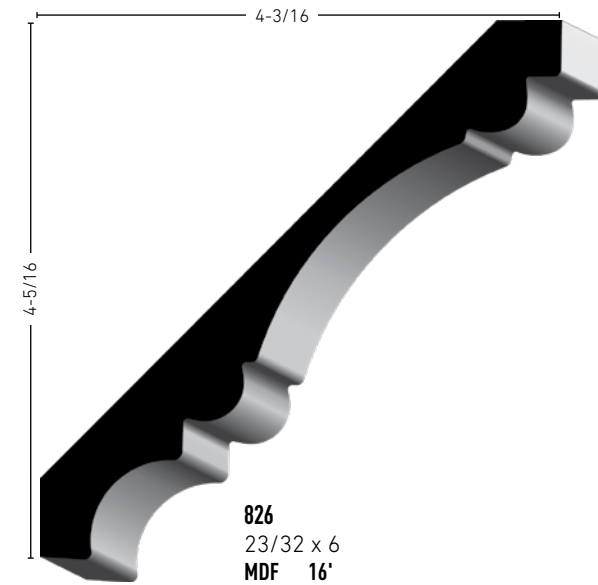
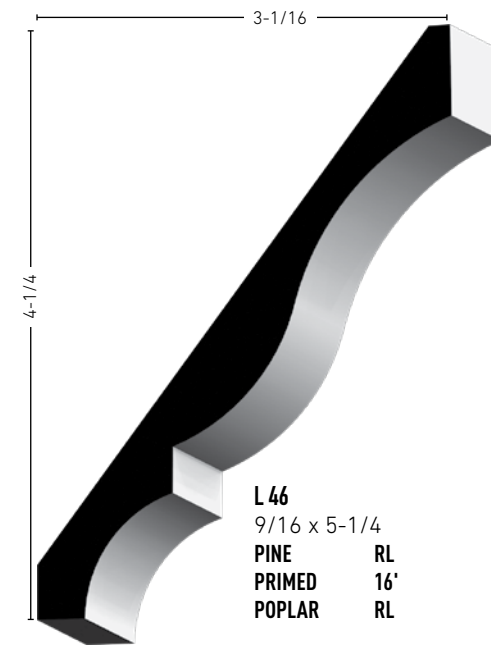
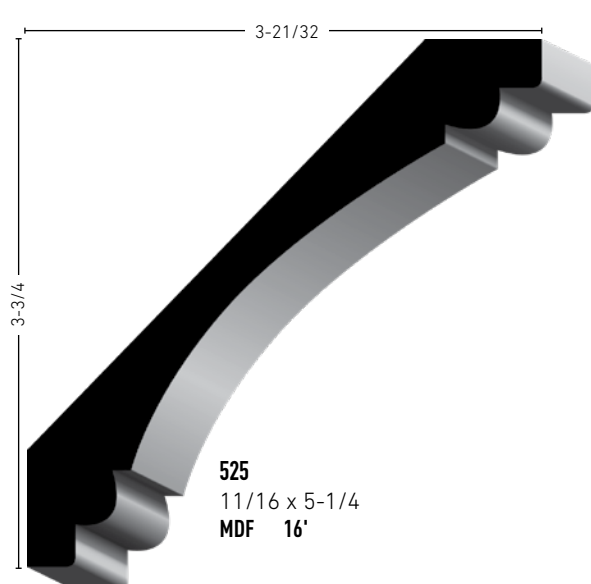
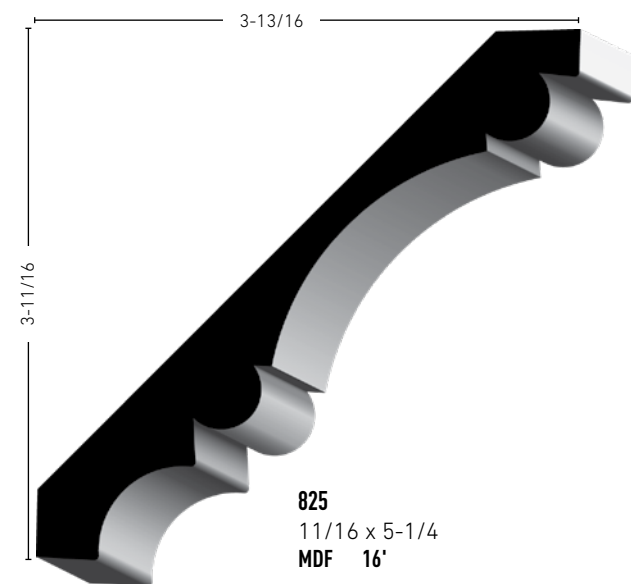
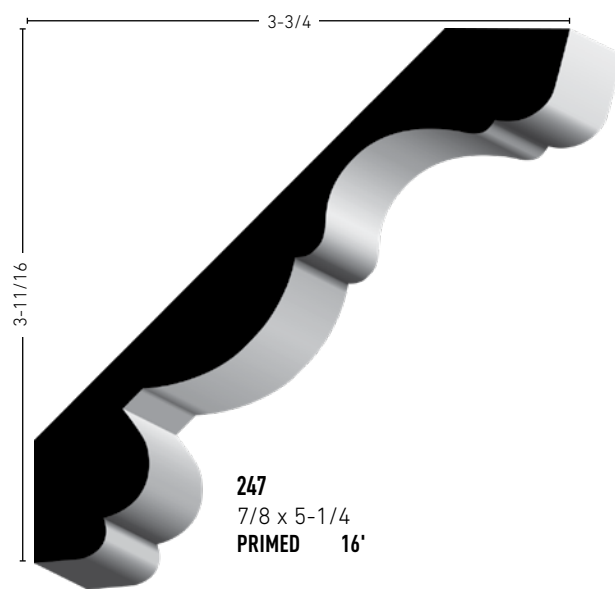
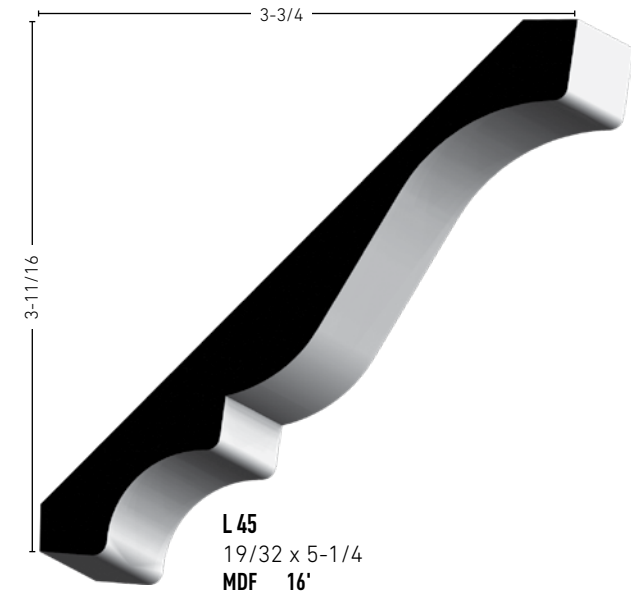
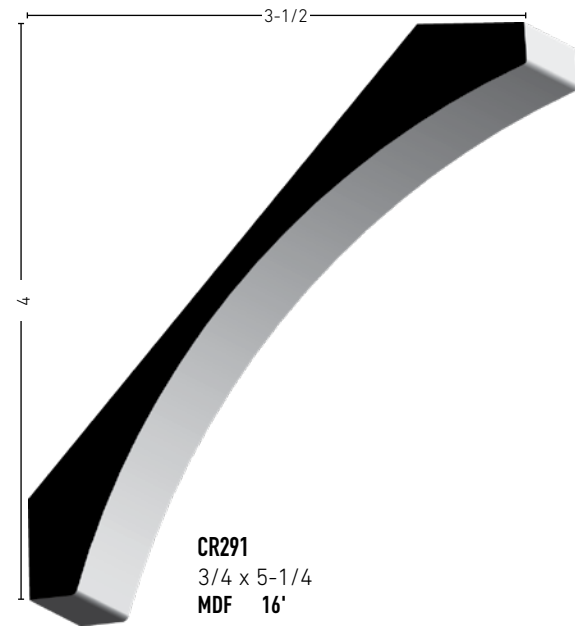
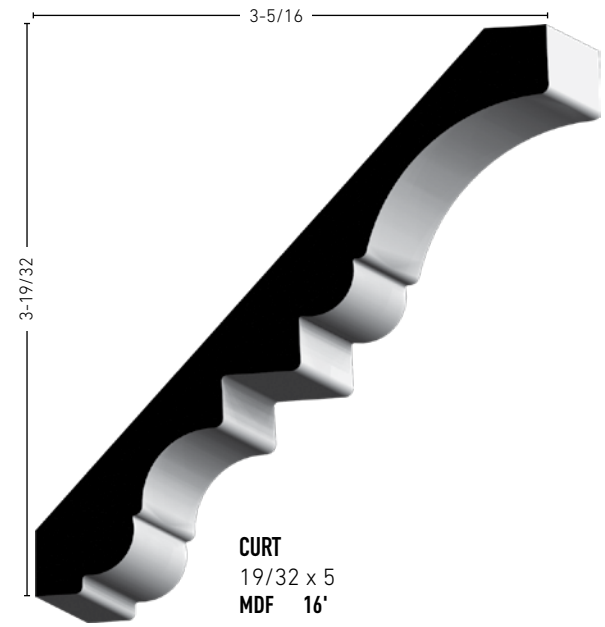

# Crown

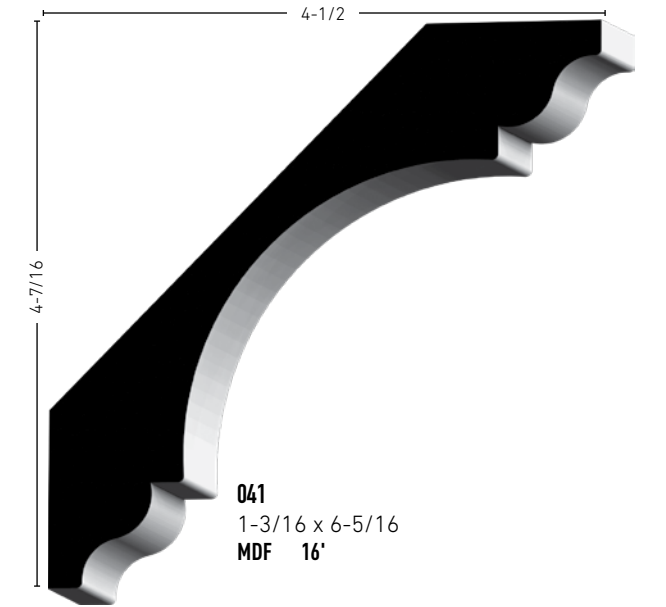
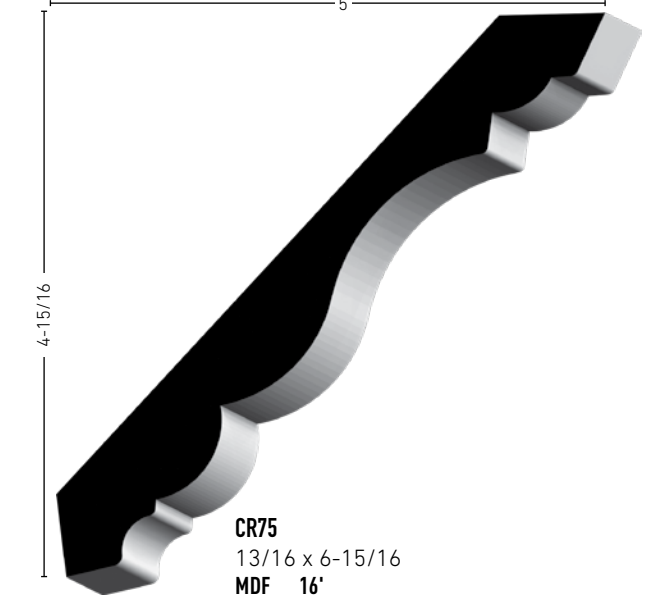
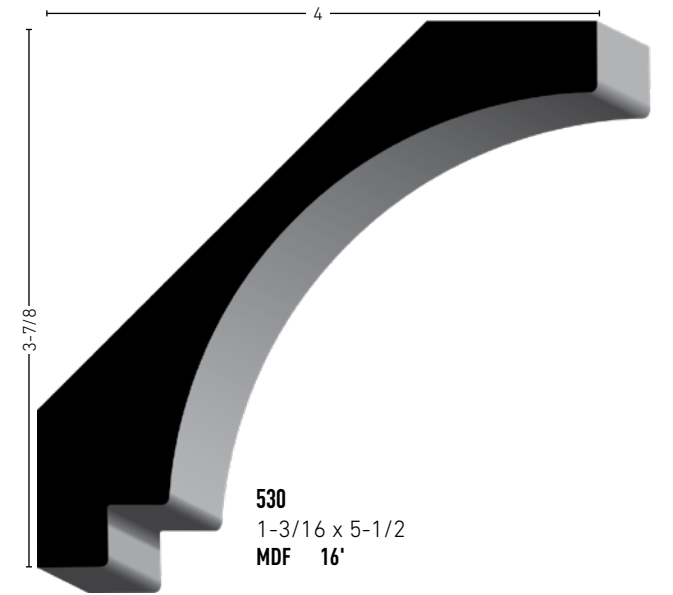





# General Purpose

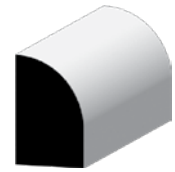

**126 SHOE**  
1/2 x 3/4  
PINE 8' | 12' | 10' | RL  
PRIMED 12' | 16'  
OAK 8' | 10' | RL  
POPLAR RL  
POPP 16'  
MAPLE RL



**34 CLOVER LEAF SHOE**  
3/4 x 3/4  
PINE RL  
OAK RL  
PRIMED 16'

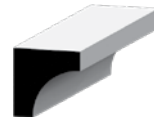

**93 COVE**  
3/4 x 3/4  
PINE 8' | RL  
PRIMED 16'  
OAK 8' | RL  
**100**  
11/16 x 11/16  
PINE 8' | RL  
PRIMED 8'  
POPLAR RL



**L 94 COVE**  
5/8 x 1-1/8  
PINE RL



**L 263 LATTICE**  
1/4 x 2-1/4  
PINE 8'  
**L 265**  
1/4 x 1-3/4  
PINE 8' | RL  
**L 266**  
1/4 x 1-1/2  
PRIMED 8'  
**L 267**  
1/4 x 1-3/8  
PINE 8' | RL  
**L 268**  
1/4 x 1-1/8  
PINE 8' | RL



**L 246 SCREEN STOCK**  
11/16 x 2-3/4  
PINE RL  
PRIMED 16'  
**246**  
3/4 x 2-3/4  
OAK 8'  
POPLAR RL  
**L 248**  
11/16 x 1-3/4  
PINE RL  
PRIMED 16'  
**248**  
3/4 x 1-3/4  
OAK 8' | RL  
POPLAR 8' | RL

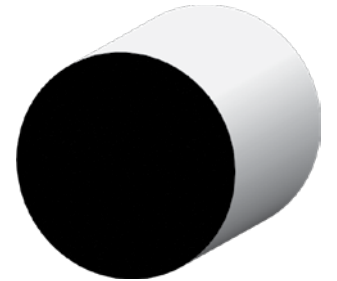

**L 232 CLOSET POLE**  
1-9/16 Full Round  
DFIR 8'

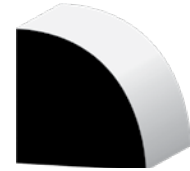

**103 QUARTER ROUND**  
1-1/16 x 1-1/16  
PINE RL



**L 254 CRAFTSMAN SHOE**  
7/16 x 3/4  
PRIMED 8' | 12' | 16'  
POPLAR 2L (12' & Longer)



**123 HALF ROUND**  
5/16 x 5/8  
PINE RL

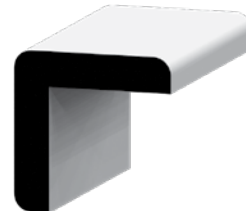

**204 CORNER GUARD**  
1-5/16 x 1-5/16  
PINE 8' | RL

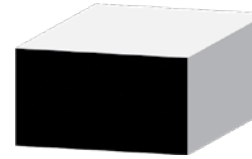

**L 252 BLIND STOP**  
11/16 x 1-1/4  
PINE 8' | RL

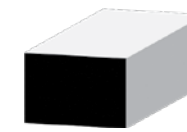

**254 CHECK STOP**  
1/2 x 3/4  
PINE 8' | RL

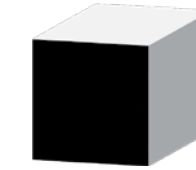

**238 SQUARE**  
1-1/16 x 1-1/16  
PINE 8'

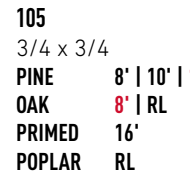

**105**  
3/4 x 3/4  
PINE 8' | 10' | 12' | RL  
OAK 8' | RL  
PRIMED 16'  
POPLAR RL



**137 SCREEN MOULD-CLOVER**  
3/8 x 3/4  
PINE 8'



**147 GLASS BEAD**  
1/2 x 9/16  
PINE 8' | RL

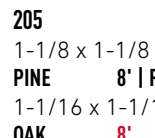

**205**  
1-1/8 x 1-1/8  
PINE 8' | RL  
1-1/16 x 1-1/16  
OAK 8'  
**206**  
3/4 x 3/4  
PINE 8' | RL  
OAK 8'

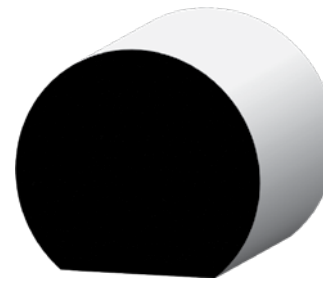

**231 HAND RAIL**  
1-1/2 x 1-11/16  
DFIR 12' | 14' | 16' | RL  
SPINE 8' | 12' | 16'  
POPLAR 16'

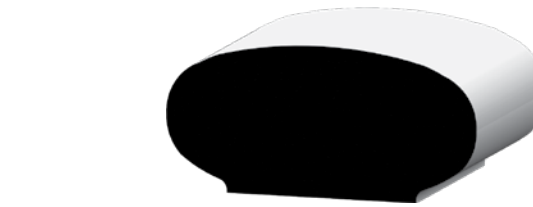

**240 HAND RAIL**  
1-1/4 x 2-1/4  
DFIR 16' | RL  
SPINE 16'

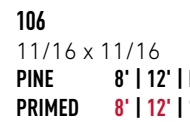

**106**  
11/16 x 11/16  
PINE 8' | 12' | RL  
PRIMED 8' | 12' | 16'



**144 SCREEN MOULD-BEADED**  
1/4 x 3/4  
PINE 8'



**995 CHAMFER**  
3/4 x 3/4  
PINE RL



**E 208 SHINGLE**  
5/8 x 2-1/4  
PRIMED 16'

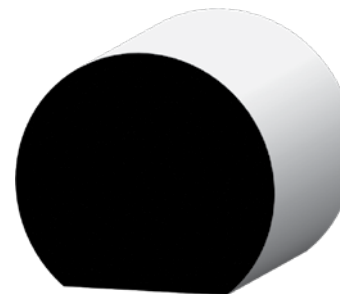

**6040 HAND RAIL**  
1-3/4 x 1-5/8  
OAK 8' | 12' | 14' | 16' | 18'  
POPLAR 8' | 10' | 12' | 16' | 18'  
MAPLE 12' | 16' | 18'  
WOAK 16'

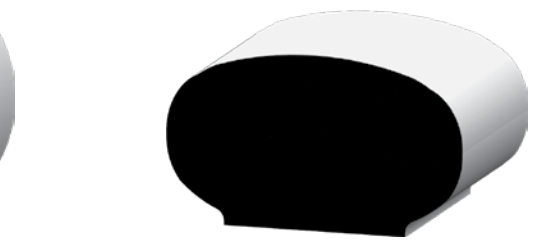

**6042 HAND RAIL**  
2-1/4 x 1-9/32  
OAK 8' | 12' | 14' | 16'  
POPLAR 10' | 12' | 16' | 18'



**E 1035 EXTENDED HALF ROUND**  
1/2 x 1-3/8  
MDF 8'  
POPLAR 8' | RL



**142 SCREEN MOULD**  
1/4 x 3/4  
PINE 8' | RL  
PRIMED 8'  
OAK 8'  
POPLAR RL



**L 210 SHINGLE**  
5/8 x 1-5/8  
PRIMED 8' | 12' | 16'



**L 230 HAND RAIL**  
1-1/4 x 2  
DFIR 16'  
1-3/32 x 2  
POPLAR 16'

Window / Door



**2355 CASING (356)**  
11/16 x 2-1/4  
WHITE 8' | 12'



**2449 DRIP CAP**  
11/16 x 1-5/8  
WHITE 12' | 16'



**2599 SHINGLE MOULDING**  
11/16 x 1-5/8  
WHITE 8'



**7526 BRICK MOULD**  
1-1/4 x 2  
WHITE 8' | 10' | 17'  
(3-0 mitered sets available)



**2448 BRICK MOULD (180)**  
1-1/4 x 2  
BROWN 8'



**2497 JAMB**  
3/4 x 5-7/8  
WHITE 7' | 10'



**2100 THERMO STOP**  
7/16 x 1-7/8  
WHITE 7' | 9' | 16'



**2149 THERMO STOP**  
7/16 x 2  
BROWN 9'  
SANDSTONE 9'



**2150 STOP**  
5/8 x 1-1/2  
WHITE 12'



**2330 BLIND STOP**  
5/8 x 5/8  
WHITE 8'



**7788 COLONIAL STOP**  
3/8 x 1-1/4  
WHITE 8'

Floor



**2450 BASE CAP**  
11/16 x 1-1/8  
WHITE 8'



**7527 BASE**  
9/16 x 3-1/4  
WHITE 8' | 12'



**2024 QUARTER ROUND**  
1/2 x 1/2  
WHITE 8'



**2689 QUARTER ROUND**  
3/4 x 3/4  
WHITE 8' | 12'



**2046 SHOE**  
5/16 x 3/4  
WHITE 8'

Ceiling



**2021 COVE**  
3/4 x 3/4  
WHITE 8'



**2598 BED MOULD**  
9/16 x 1-5/8  
WHITE 12'

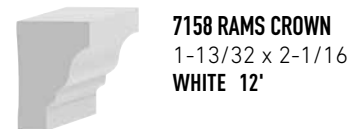

**7158 RAMS CROWN**  
1-13/32 x 2-1/16  
WHITE 12'



**2435 CROWN**  
9/16 x 3-5/8  
WHITE 12'



**7901 SHINGLE PANEL**  
21/32 x 1-23/32  
WHITE 8'



**2258 EXTERIOR BEAD**  
1/2 x 13/32  
WHITE 8'

Wall & Trim



**N 2878 PANEL**  
3/8 x 4  
WHITE 8'



**2352 EXTERIOR PLANKING**  
3/8 x 5-15/32  
WHITE 8'



**9825 REVERSIBLE BEADED/ V-GROOVE NICKEL GAP PANEL**  
5/16 x 7-5/16  
WHITE 8'

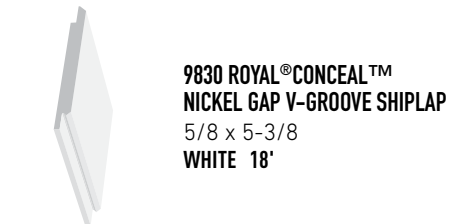

**9830 ROYAL®CONCEAL™ NICKEL GAP V-GROOVE SHIPLAP**  
5/8 x 5-3/8  
WHITE 18'



**9834 ROYAL®CONCEAL™ NICKEL GAP V-GROOVE SHIPLAP**  
5/8 x 7-1/8  
WHITE 18'



**7209 FLAT UTILITY TRIM**  
5/16 x 5-3/16  
WHITE 8' | 12'



**7318 (1X4) TRIM PLANK**  
3/4 x 3-1/2  
WHITE 8' | 12'



**7311 (1X6) TRIM PLANK**  
3/4 x 5-1/2  
WHITE 8' | 12'



**8983 TRIM PLANK**  
5/8 x 1-1/2  
WHITE 8'



**9836 CRAFTSMAN CHAIR RAIL / BASE TRIM KIT**  
5/8 x 2-1/2  
WHITE 8'



**7719 PVC SMOOTH OS CRNR (WM205)**  
1-1/8 x 1-1/8  
WHITE 8' | 12'

Miscellaneous



**2807 RAKE MOULDING**  
1x2  
WHITE 12'



**9134 SCREEN MOULD**  
1/4 x 3/4  
WHITE 8'



**2018 LATTICE**  
1/4 x 1-1/2  
WHITE 8'

PVC Boards & Sheets

TRIM BOARD - EMBOSSED / SMOOTH			
<b>7833</b>	1X3	3/4 x 2-1/2	8'
<b>7318</b>	1X4	3/4 x 3-1/2	8'   12'
<b>9767</b>	1X4	3/4 x 3-1/2	18'
<b>7311</b>	1X6	3/4 x 5-1/2	8'   12'
<b>9769</b>	1X6	3/4 x 5-1/2	18'
<b>9770</b>	1X8	3/4 x 7-1/4	18'
<b>9771</b>	1X10	3/4 x 9-1/4	18'
<b>9772</b>	1X12	3/4 x 11-1/4	18'
<b>9775</b>	5/4X4	1 x 3-1/2	18'
<b>9777</b>	5/4X6	1 x 5-1/2	18'
<b>9778</b>	5/4X8	1 x 7-1/4	18'
<b>9779</b>	5/4X10	1 x 9-1/4	18'
<b>9780</b>	5/4X12	1 x 11-1/4	18'

SHEETS		
PVC SHEETS - SMOOTH OR EMBOSSED		
4' x 8' PVC Sheets Available in thicknesses:		
3/8"   1/2"   3/4"   1"		
<b>E 2878</b>	3/8"	PVC
<b>E 2871</b>	1/2"	PVC
<b>E 2837</b>	3/4"	PVC
<b>E 2864</b>	1"	PVC

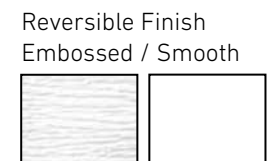

# Moulding Index

Part#	Pg#	Part#	Pg#	Part#	Pg#	Part#	Pg#	Part#	Pg#	Part#	Pg#
3	23	231	47	P 380	20	L 633	29	N947	25	7526	48
9 IS	28	L 232	47	L 390	38	H 633	30	972	25	7527	48
9 OS	28	233	47	390	38	L 634	29	L 973	25	7719	48
34	46	L 233	47	391	38	L 635	29	982	25	7788	48
40	20	238	47	400	41	642	23	L 983	25	7901	48
041	43	239	47	410	31	658	33	995	46	8263	36
42	44	240	47	411	20	663	30	4 1021	26	8740	28, 35
043	43	L 246	47	412	22	674	33	7 1021	26	8741	35
L 45	42	246	47	B 6412	23	682	21	1021	26	8920	28
L 46	43	247	42	E412	22	683	21	E 1035	26, 46	8951	28
L 47	41	L 248	47	G 412	22	685	20	1153	26	8983	49
L 48	41	248	47	414E	31	695	33	1200	23	9134	49
L 49	40	B G250	26	L 414	31	B 6712	37	1305	25	9623	37
L 51	40	L 252	47	427	38	713	30	1400	23	9713	37
51	40	L 254	46	L 430	31	G 714	37	1401 PB	28	9825	49
52	40	254	47	L 431	32	714	29	1402	23	9830	49
54	40	260	38	432	22	714E	37	1403 PB	28	9834	49
68	40	L 263	47	L 433	29	L 723	30	1888	45	9836	49
74	40	263	35	L 433E	29	L 724	29	1889	45	1X4 EC	39
CR75	43	L 265	47	SL 433	29	730	44	1892	28	1X6 EC	39
75	40	L 266	47	433E	29	734	23	1895	28	BC14	31
84	40	L 267	47	L 434	21	740	23	1897	45	L BEAD	39
85	40	L 268	47	435	31	742 PB	28	1898	45	L CC14	21
93	46	279	26	438	23	743 PB	28	1899	45	CURT	42
L 94	46	280	26	438 PB	28	763	33	2018	49	C PT11	22
EDC97	23	281	38	L 444	21	765	36	2021	48	B PT11	32
100	46	H 282	26	444A	22	795	20	2024	48	PT3	21
103	46	CR291	42	444	22	P 805	30	2046	48	RB3	23
105	46	292	38	445	21	P 808	31	2100	48	SL16	39
106	46	L 294	38	445A	21	P 808 Block	28	2149	48	L SL16	39
108	46	L 300	38	446	22	L P813	34	2150	48	SL18	39
110	46	L 301	38	P 450	22	P 813	34	2258	48	L SL18	39
123	46	312	20	453	19	P 813 Block	28	2330	48	S RB3	23
126	46	B 312	33	465	23	L P815	36	2352	49	L SBW4	39
137	46	B G312	22	L 471	20	P 815	36	2355	48	L WCAP	38
142	46	SC312	23	472	20	824	41	2435	48	E WP4	39
144	46	316	19	L 473 Casing	19	825	42	2448	38	L WP4	39
147	46	321	19	L 473 Stop	25	826	43	2448 (180)	48	New Rustic Collection Shiplap Boards & Trim	8
L163	28	L 324	19	473	19	827	44	2449	48	Boards	17
L163E	32	324	19	474	20	845	25	2450	48	Jambs	27
163E	32	L 326	41	505	44	846	25	2464	38		
163	28	327	19	512	34	856	25	2496	20		
166	28	334	23	512E	35	857	25	2497	48		
171	38	334 PB	28	B 6512	34	871	23	2598	48		
180	26	L 338	21	SB512	34	B 876	25	2599	48		
182	38	L 340	41	L 512	34	L 876	25	2689	48		
L 184	38	351	20	L 512E	35	876	25	2709	49		
185	38	L 356	19	G 514	32	L 887	25	2807	49		
190	38	356C	19	L 514	32	887	25	N 2878	49		
L 197	26	356	19	E519	41	887 PB	28	4520	20		
200 Crown	40	P358 35	23	525	42	892	28	4532	20		
B G200	26	L 361	21	530	43	895	28	5010	24		
204	46	361	20	535	22	914E	39	5021	24		
205	46	L 361C	21	545	32	915	23	5030	24		
206	46	B 366	30	SA612	24	917 PB	28	6040	47		
207	37	L 366	19, 20	L 618	33	935	25	6042	47		
E 208	46	366	19	618	33	B 936	25	7158	48		
L 210	46	366A	19	L 620	30	936	25	7163	36		
227	26	374	21	620	30	N 946	25	7311	49		
L 230	47	376	19	623	29	947	25	7318	49		

# Quality Products



## Mouldings

- Softwood Mouldings
- Hardwood Mouldings
- Blocks
- Flexible Mouldings



## Boards

- Softwood Boards
- Hardwood Boards
- Interior/Exterior
- S4S & Eased Edged
- Unfinished, Primed
- PVC



## Stair Parts

- Wood Balusters & Newels
- Iron Balusters & Newels
- Post to Post Components
- Over the Post Components
- Stock, Special Order, Custom

## New Cable Styles

- Marine grade 316 stainless steel cable and hardware for interior or exterior use
- Sleek exclusive swageless cable fittings require no special tools for installation
- Newels are precut and predrilled saving hours and hours of installation time
- Hollow tube infill option available
- Solid box treads for a total industrial modern design
- New code compliant handrail profile

A NOVO Building Products Company



## Columns

- Architectural Wood
- Wood Colonial
- Poly-Classic
- Poly-Classic DuraGlass Square
- Poly-Classic Craftsman
- Poly-Classic Porch Posts
- Wood Porch Posts

## Decorative Millwork

# ORNAMENTAL

- Decorative Wood Mouldings
- Mantels, Wood Beams,
- Decorative Risers
- Stained Boards

DECORATIVE MILLWORK

A NOVO Building Products Company





Explore our comprehensive collections of mouldings, stair parts, boards, and exterior millwork as well as find inspiration for every room in the home.



## Midwest Chicago Distribution Center

Proudly Supplied By



© 2020 EMPIRE CO. J1(Rev.09/20)

Empire reserves the right to make changes to