

THE PROFESSIONALS' CHOICE

DURAFLEX

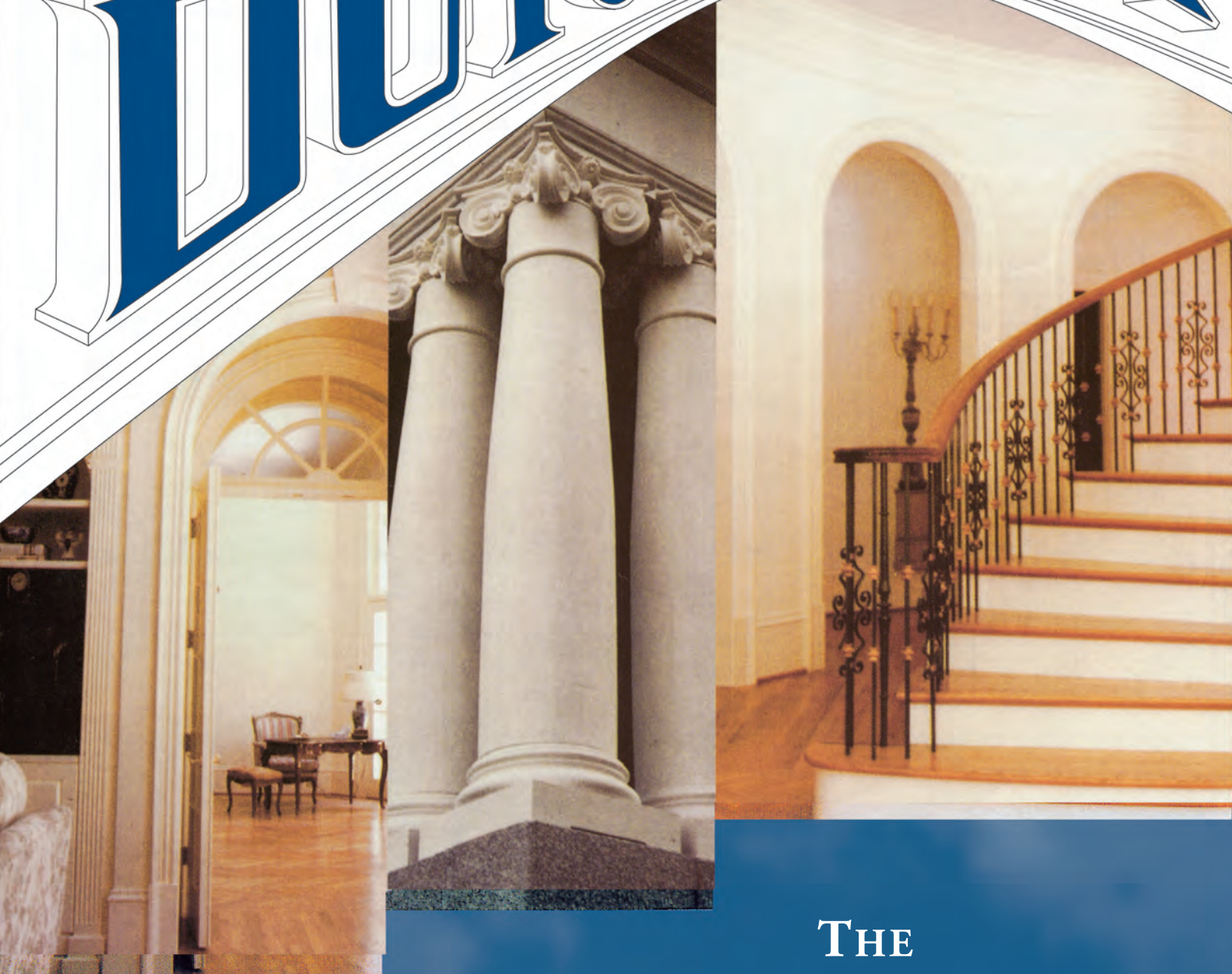

THE
ORIGINAL
FLEXIBLE
MOULDING™

2008 CATALOG

DURAFLEX™

The Original Flexible Moulding

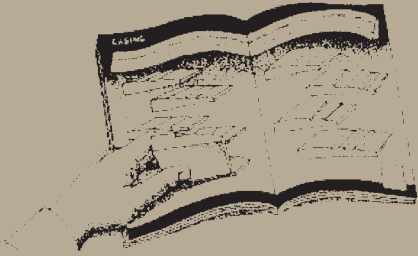

Duraflex™ – The Original Flexible Moulding is an exclusive product of ResinArt. This catalog illustrates many popular styles of moulding but these are only a portion of the 6,000 patterns we offer. Check the Table of Contents for a specific moulding number or a general category of mouldings. Locate the page number and match your actual wood moulding to the illustrated full-scale drawing.

When ordering, please specify the part number, length – (lineal feet) and surface; smooth finish, oak or pine texture. Duraflex is the easy, economical alternative for radius installations, and because of its quality, flexibility and superior longevity, it is unequaled by wooden millwork.

The Advantages of Duraflex™:

- The appearance of real wood.
- Ease of installation using standard woodworking equipment—cut, sand, shape and finish like wood.
- Seamless construction without lamination defects.
- Can accommodate VIRTUALLY ANY RADIUS WHICH IS THREE TIMES A PROFILE WIDTH OR GREATER.
- Moisture proof. Insect proof. Can withstand extreme heat and cold temperatures without warping, cracking or deteriorating.



If you don't find the moulding that you are looking for, we can produce custom moulding from your wooden original. We can also work from a tracing – (paper pattern) for any arch, circular window, curved wall or curved frame. For additional information on sizing, ordering, pricing, shipping, warranties, installation or our other fine products, refer to the back of the catalog for information.

TABLE OF CONTENTS

Order Form	2
General Product Information and Guidelines	3
Templates Required	4
Flexible Limitations & Ranges of Movement	5
Casing	6-27
Base	28-44
Base Cap/Base Shoe	45
Crown	46-69
Cove	70
Rabbeted Panel	71
Panel	72
Chair Rail	73-76
Chair Rail Backer	77-78
Half Round and Quarter Round	79
Miscellaneous—Shingle, Stop, Dentil	80
Miscellaneous—Apron, Insert, Mullion, Drip Cap, Outside Corners, Hand Rail	81
Miscellaneous—Radius Base Corners, Picture Moulding	82
Miscellaneous—Flatstock, Jambstock, Back Band	83
Miscellaneous	84
Decorative Trim	85-89
Architectural Accents	90-92
DuraCraft Columns	93-95
Index of Profiles	96-97

RESINART EAST, INC.

"Flexible Trim Mouldings" 201 Old Airport Rd. Fletcher, NC 28732 (800) 497-4376 Fax (828) 687-0182 www.Resinart.com

ORDER FORM

Date: _____
 Company: _____

P.O. # _____
 Ship To: _____

Radius Half Circle Window & Door Casing

All Casing is made with thick edge to outside unless specified

Part No.	Quantity	Length	Radius	Dura Flex	Xtra Flex

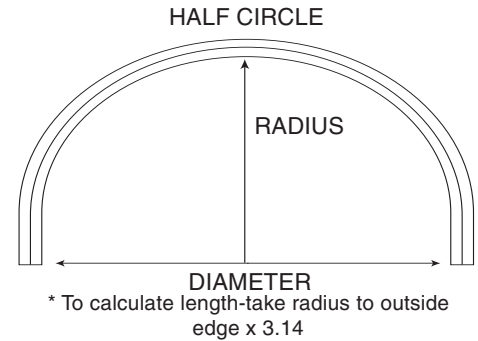

Arched Window & Door Casings

Part No.	Quantity	Length	Height (Rise)	Width	Dura Flex	Xtra Flex

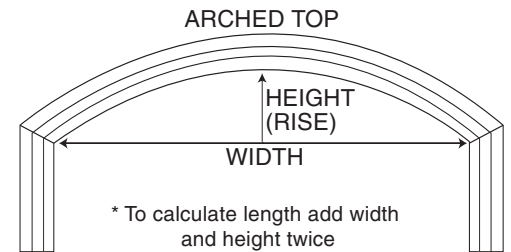

Elliptical or Oval (Template must be provided) Please # if more than one	Part No.	Qty.	Template #	Dura Flex	Xtra Flex

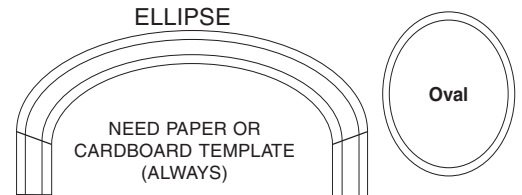

Crown & Cornice

Part No.	Quantity	Length	Radius	Concave (ISR)	Convex (OSR)
				Check <input checked="" type="checkbox"/> ()	()
				OSR ()	()
				or ()	()
				ISR ()	()
				()	()
				()	()

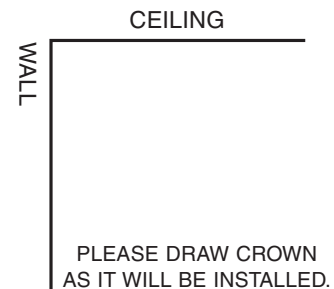

Straight Parts

Part No.	Quantity	Length	Dura Flex	Xtra Flex

IMPORTANT NOTES

- * Note: Smallest radius that can be made is 3 times the width of any Profile.
- * Note: Jamb stock flex, order as straights

GENERAL PRODUCT INFORMATION AND GUIDELINES

FASTENING

Polyurethane construction adhesive in addition to pneumatic pin nailing is recommended. Use of tape or clamps may be helpful in securing material in position while adhesives bond. Nails should be kept to a minimum and 3/8" from any edge.

For best results, we recommend using Duraflex Adhesive— our fast-drying super-hold adhesive. Perfect for eliminating nail holes, where there are no studs to nail into, or at seams for a close, neat fit. For even faster installation, use our Instant Adhesive Accelerator. (See page 92)

CUTTING

Material can be cut, shaped and sanded using standard woodworking equipment. Note that the wood grain on Stain grade material is only on the surface and will be eliminated if sanded.

STAIN

The use of water based stain such as Minwax works well. Apply with brush or rag and wipe off. Additional coats may be applied if necessary to match wood. Be sure to allow first coat to dry completely before applying more stain. Finish with clear coat after staining.

PAINT

Primer coats are not recommended. Use water based Acrylic Latex Paint. When using Alkyd Enamels an exterior primer such as Kilz® is required. When using Alkyd Enamels additional drying time may be necessary. Never paint before installation. The material is flexible and the paint may crack during installation.

HOW TO ORDER BUILD UP DETAILS

Understanding what Radius information is needed and which details will be made straight:

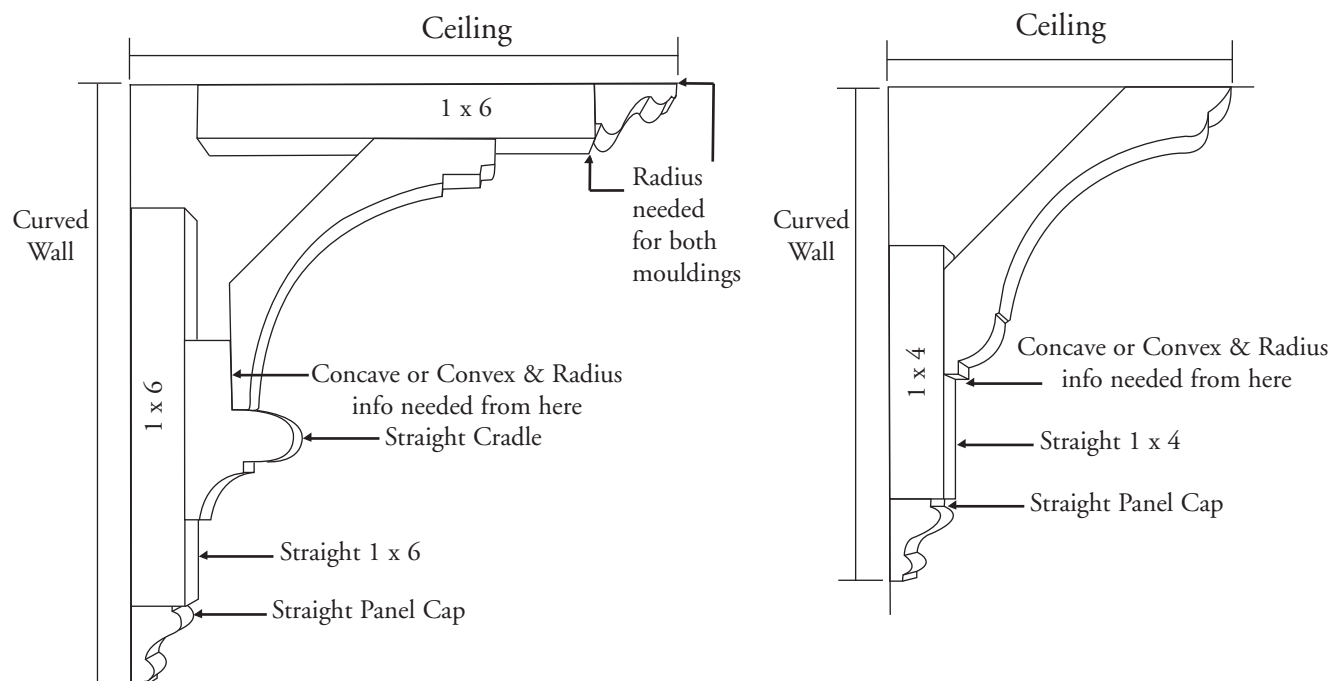

TEMPLATES REQUIRED FOR OVALS, ELLIPTICAL, & IRREGULAR RADIUS CROWN

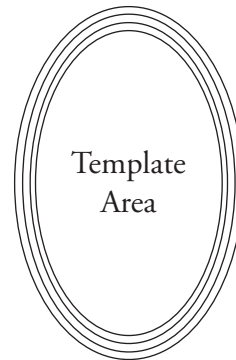
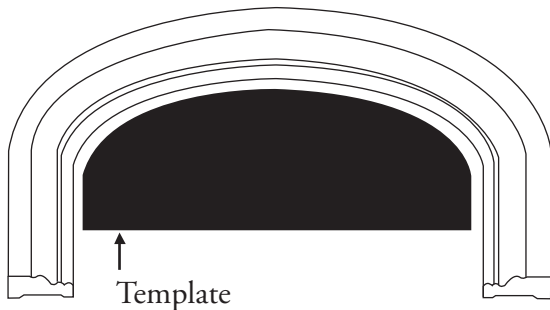

RADIUS CROWN AND DORMER APPLICATIONS

What we need to know:

- Supply radius dimension of wall or radius to outside edge of Dormer.
- Any curved segment dimension should be converted to a radius.
- ISR (Inside Radius) wall curves away from you.
- OSR (Outside Radius) wall curves toward you.
- Dormer application is always an OSR.
- Profile or description confirming crown orientation on wall (i.e., position on wall)
- Calculate length needed and add extra footage for waste, to trim and install.

Convex
Curves "Outward" O.S.R.

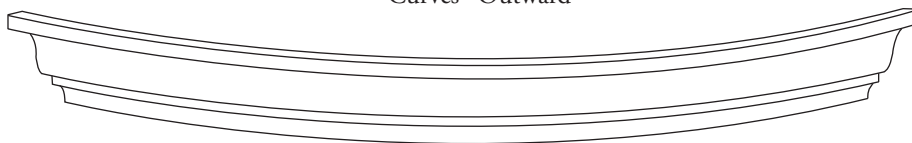

Example of orientation

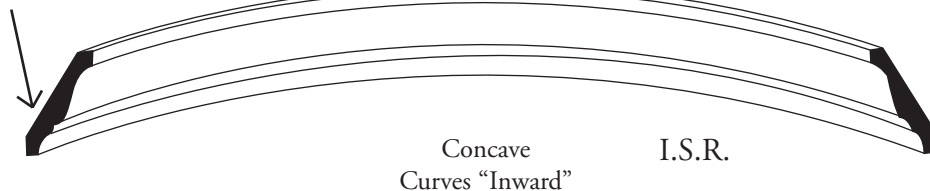

FLEXIBLE LIMITATIONS & RANGES OF MOVEMENT

STRAIGHT BASE OR CASING BENDING AGAINST THICKNESS

Applications bending against the smaller dimension usually the 1/2" - 1-1/2" thick (i.e. Base with measurements 5/8 x 4-1/2) will bend easily in the direction of the lesser dimension with no pre-curving necessary.

Minimum radius 10".

Product has a tendency to cup when bent too tight on wall.

Moulding will not bend around 3/4" or 1-1/2" bullnose corners.

STRAIGHT CROWN

NOT ADVISABLE. Customer should supply radius information to allow Resinart to confirm if straight will work.

MEASURING

Calculate approximate lengths needed using radius B in inches and round up to nearest foot.

Use Radius A and Width A dimension for ordering actual part.

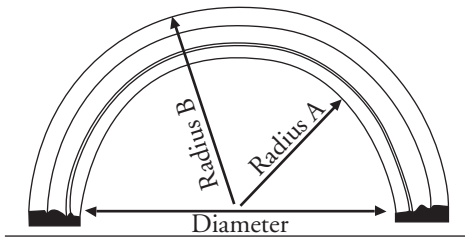

Radius B (x) 3.14 (÷) 2 = minimum length needed

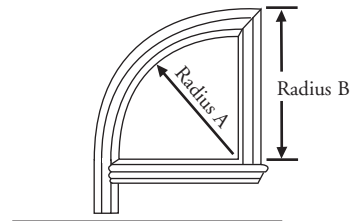

Radius B (x) 3.14 (÷) 2 (÷) 2 = minimum length needed

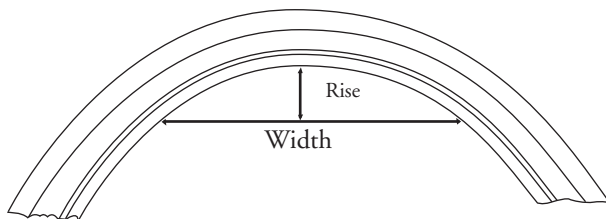

Rise (x) 2 (+) Width = minimum length needed

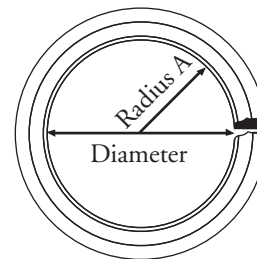

Diameter (x) 3.14 (÷) 2 = minimum length needed

CASING

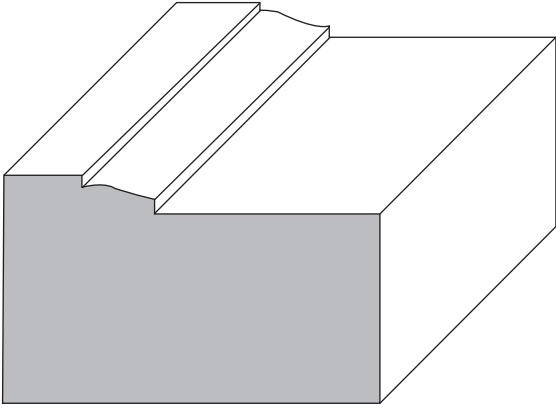

T-WM180
1 1/4 x 2

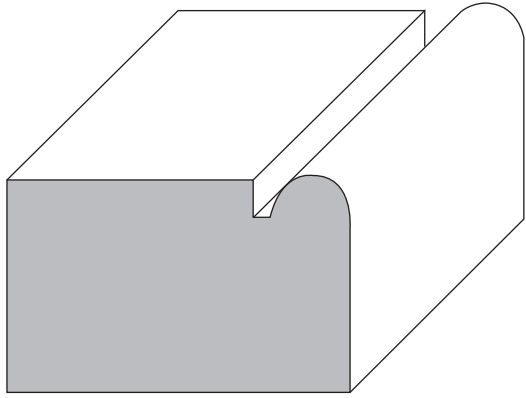

T-WM176
1 1/16 x 1 3/4

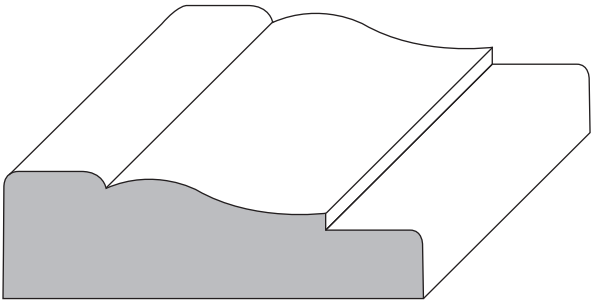

T-WM356
1 1/16 x 2 1/4

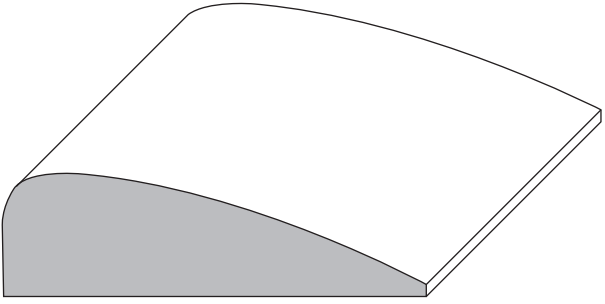

T-WM327
1 1/16 x 2 1/4

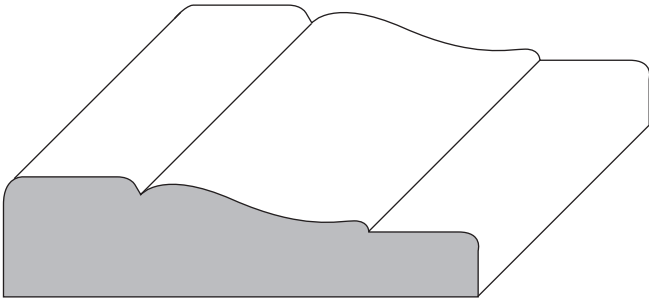

T-WM351
1 1/16 x 2 1/2

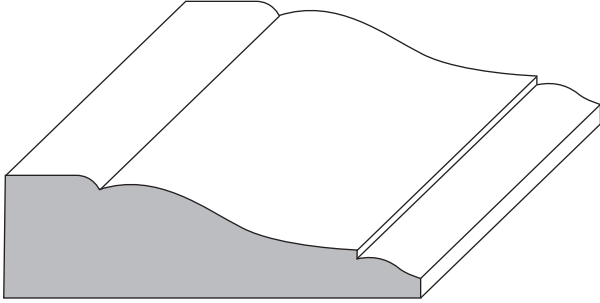

T-WM442
1 1/16 x 2 1/4

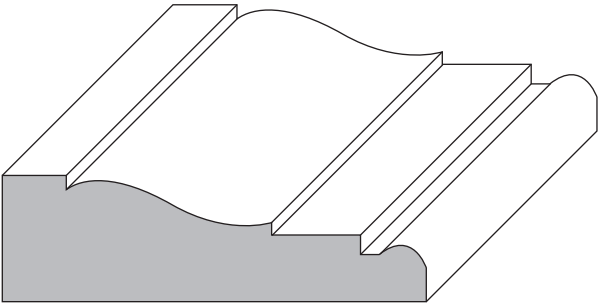

T-WM376
1 1/16 x 2 1/4



CASING

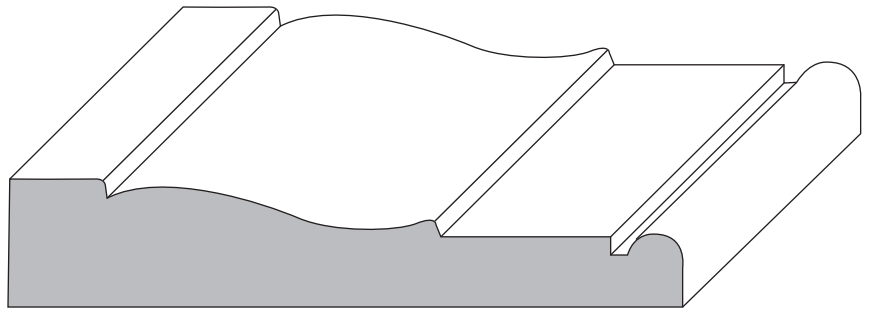

C-LW445
5/8 x 3 1/2

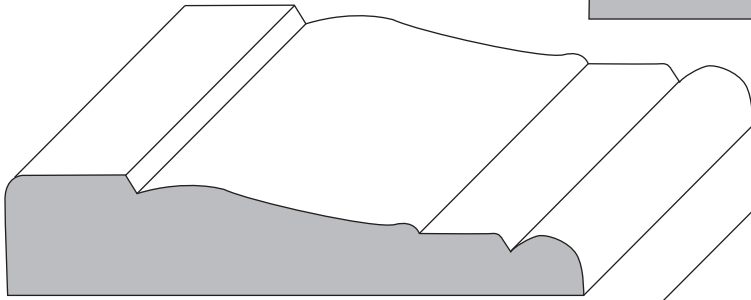

C-LW371
5/8 x 3

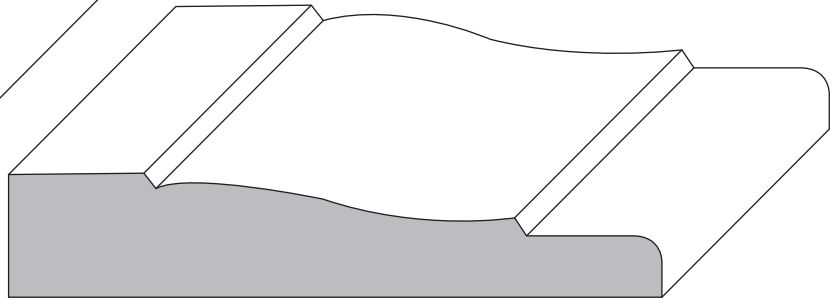

T-WM444
1 1/16 x 3 1/2

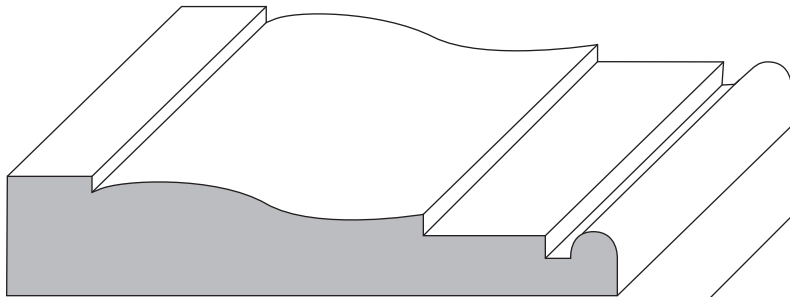

T-WM445
1 1/16 x 3 1/4

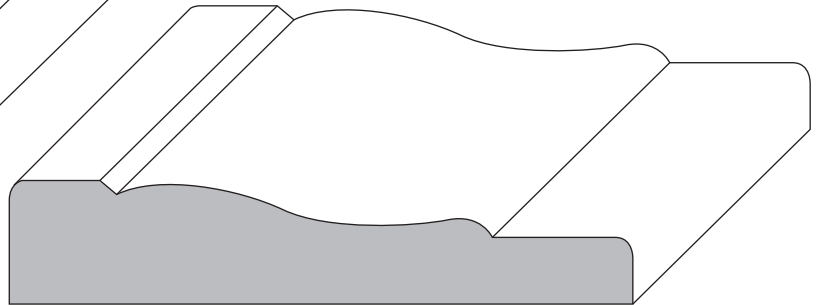

T-CT444
1 1/16 x 3 1/4

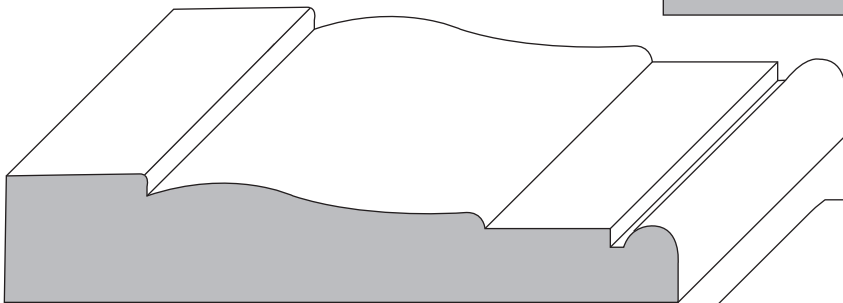

C-SDC99
5/8 x 3 1/2

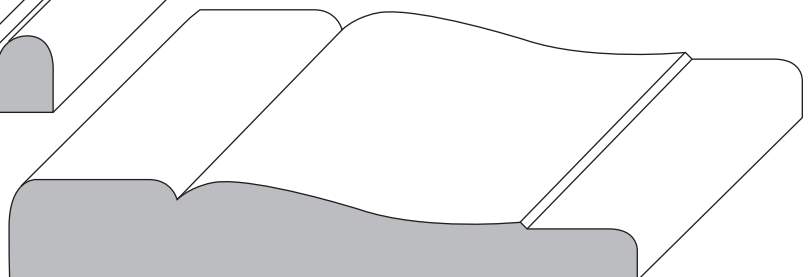

C-LW356
5/8 x 3 1/4

CASING



T-WM430
 $\frac{9}{16} \times 4\frac{1}{4}$

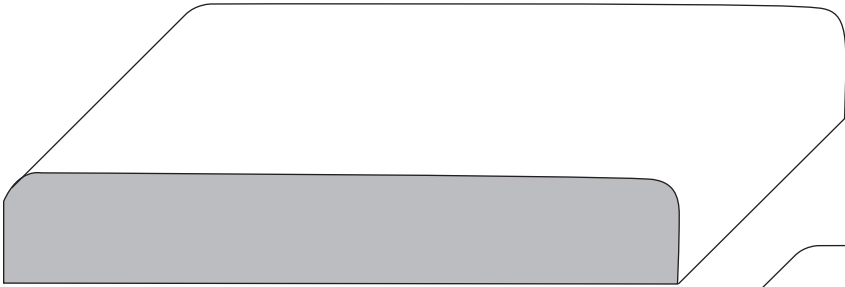

T-WM432
 $\frac{9}{16} \times 3\frac{1}{2}$

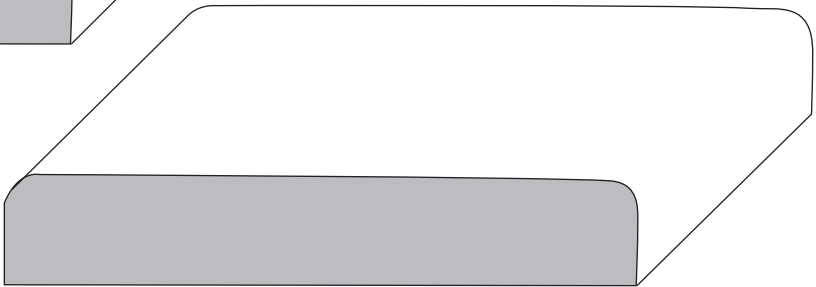

T-WM433
 $\frac{9}{16} \times 3\frac{3}{4}$

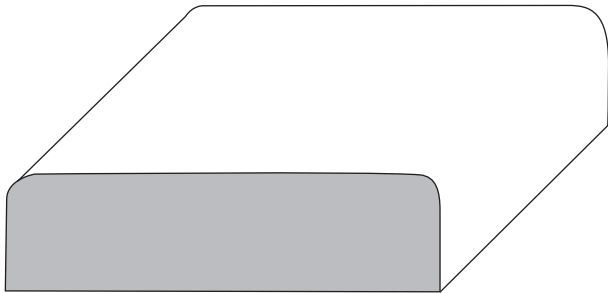

T-WM473
 $\frac{9}{16} \times 2\frac{1}{4}$

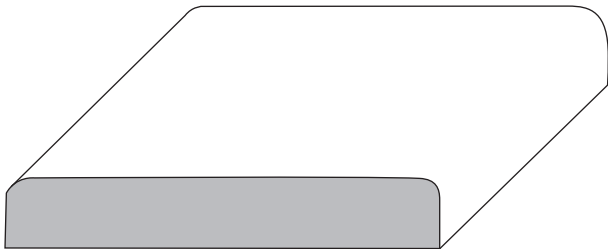

T-WM493
 $\frac{7}{16} \times 2\frac{1}{4}$

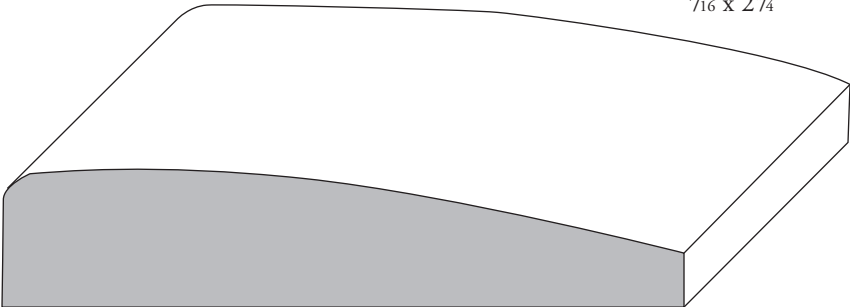

C-P2050
 $\frac{3}{4} \times 3\frac{1}{2}$

CASING

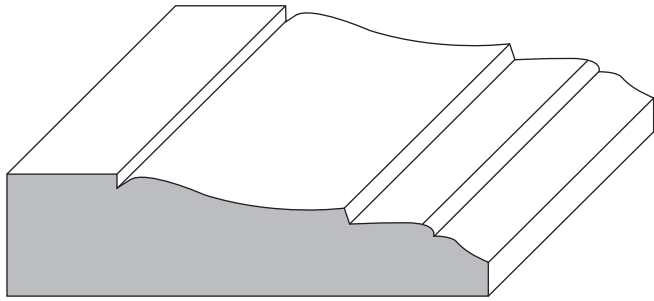

C-NJ149
 $\frac{11}{16} \times 2\frac{1}{2}$

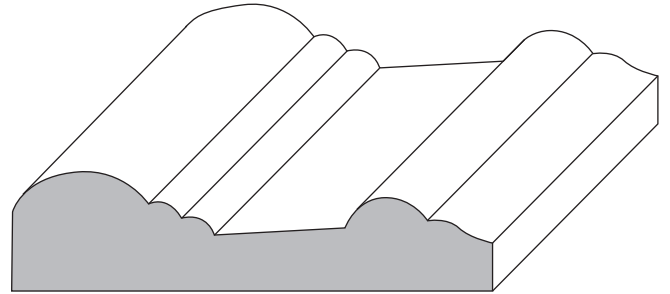

T-SL207
 $\frac{5}{8} \times 2\frac{1}{2}$

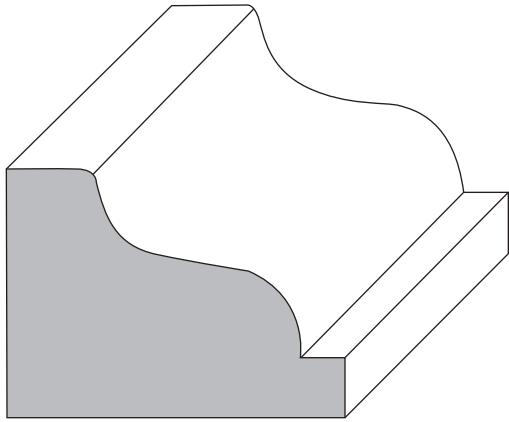

C-RRL03
 $1\frac{1}{4} \times 1\frac{3}{4}$

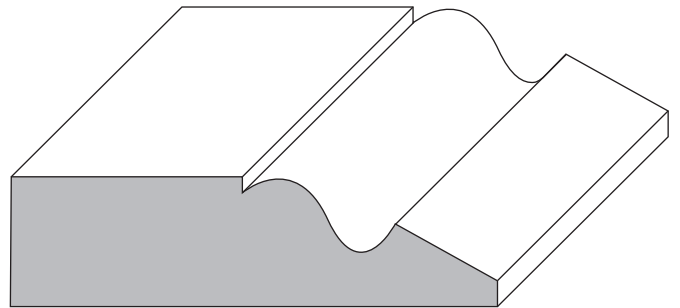

C-PO215
 $\frac{11}{16} \times 2\frac{1}{2}$

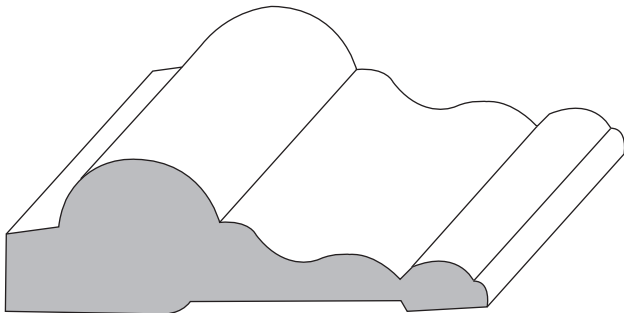

C-RB426
 $\frac{3}{4} \times 2\frac{1}{2}$

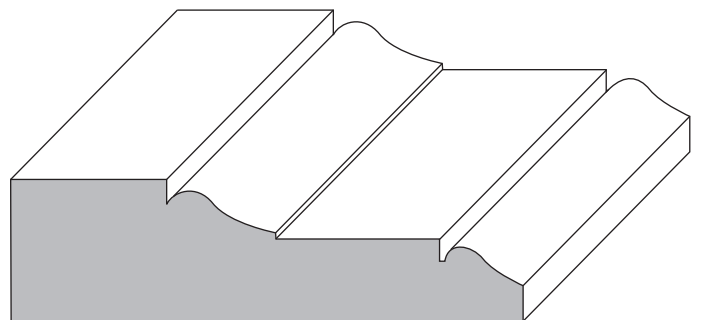

C-SS220
 $\frac{3}{4} \times 2\frac{5}{8}$

CASING

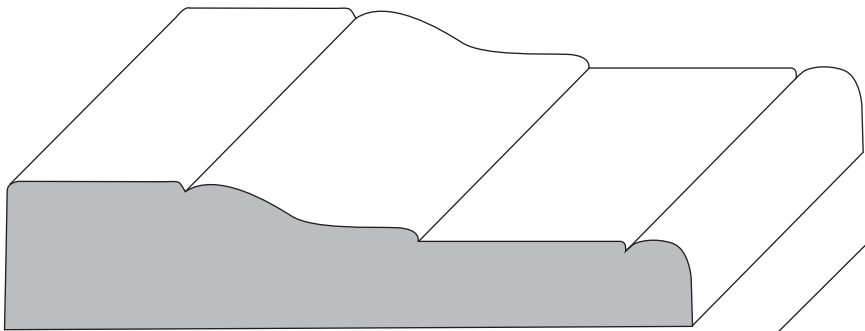

C-PM351
 $\frac{3}{4} \times 3\frac{1}{2}$

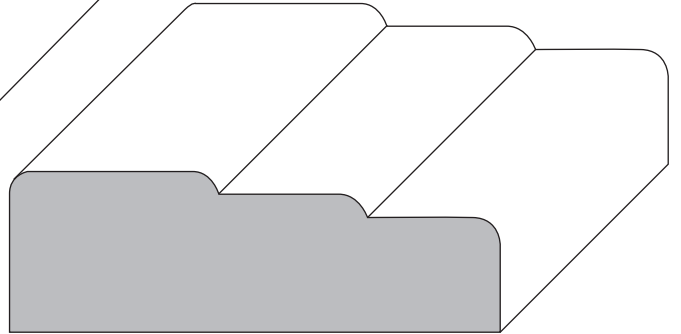

C-TH250
 $\frac{13}{16} \times 2\frac{1}{2}$

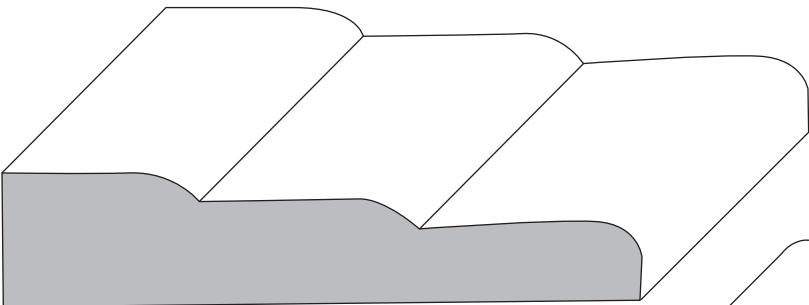

C-DC325
 $\frac{11}{16} \times 3\frac{1}{4}$

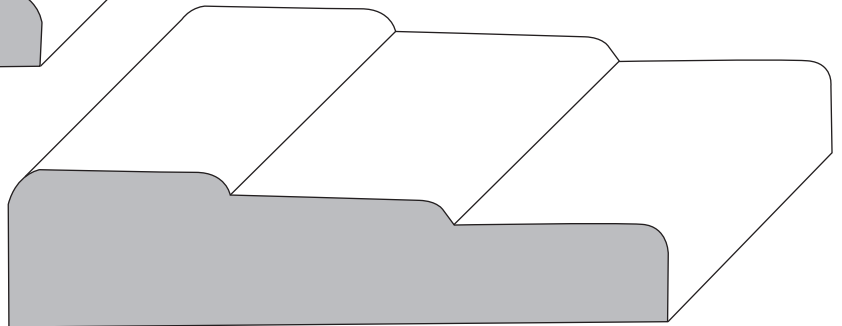

C-LM608
 $\frac{13}{16} \times 3\frac{1}{2}$

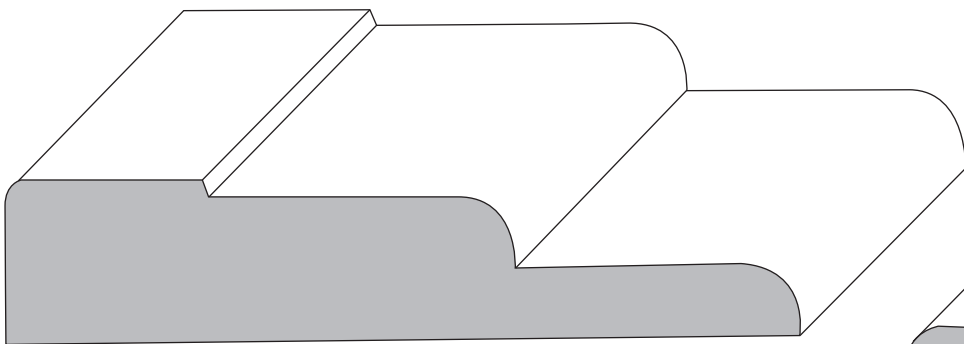

C-DE418
 $\frac{13}{16} \times 4\frac{1}{16}$

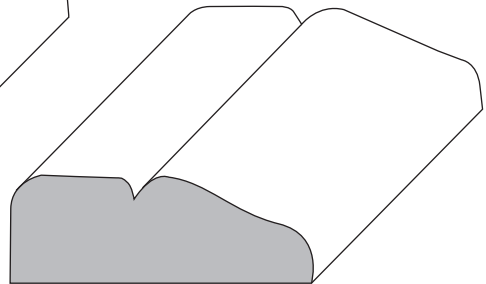

T-SL203
 $\frac{9}{16} \times 1\frac{5}{8}$

CASING

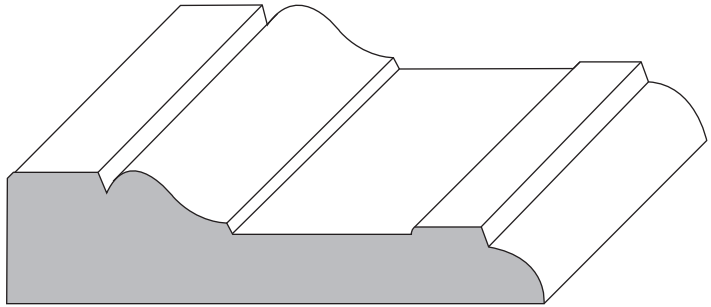

C-DY233
5/8 x 2 3/4

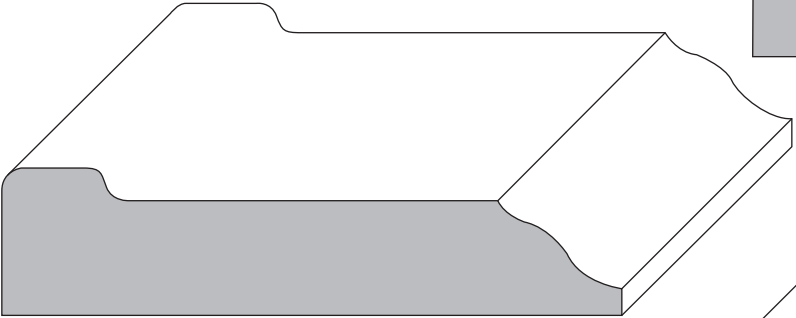

C-LD403
3/4 x 3 1/4

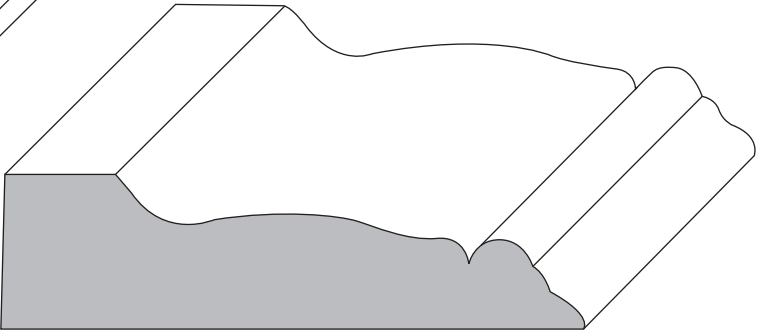

C-EM300
3/4 x 3

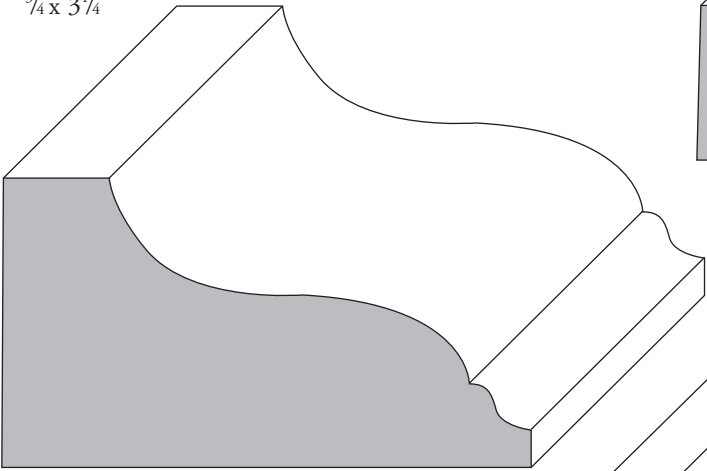

C-NJ802
1 1/2 x 2 3/4

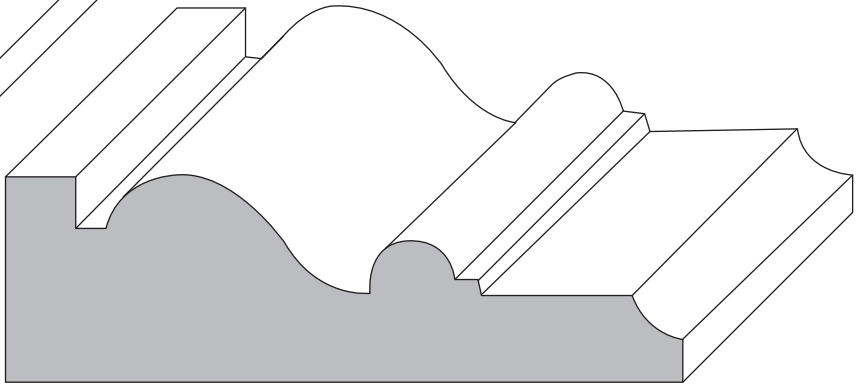

C-AS535
1 1/16 x 3 1/2

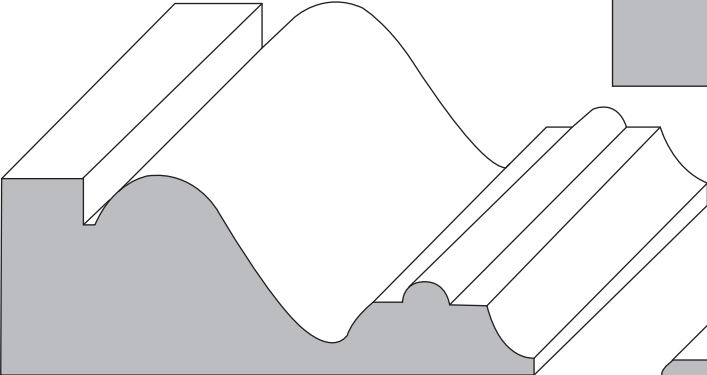

C-AM530
1 1/4 x 2 3/4

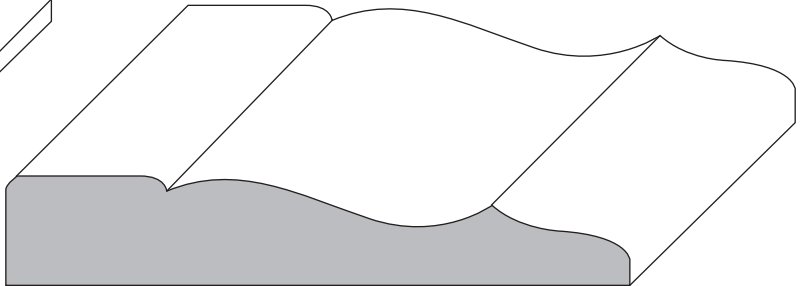

C-RLC22
9/16 x 3 1/4



CASING

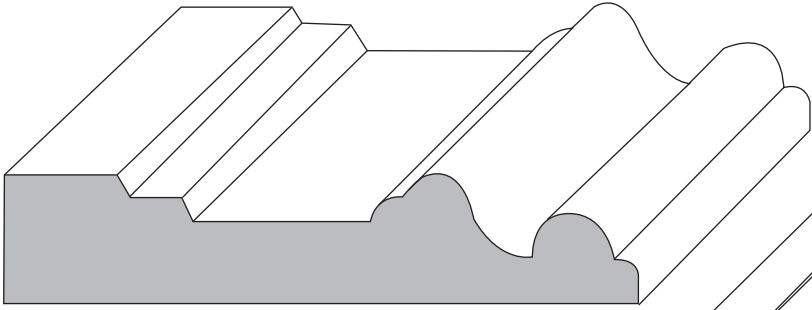

C-CHARL
 $\frac{5}{8} \times 3\frac{1}{4}$

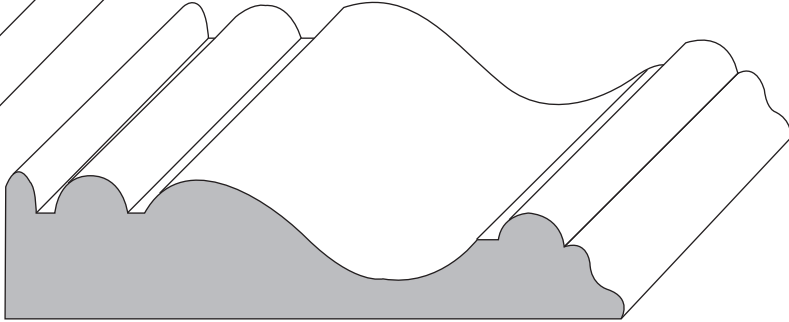

C-R265U
 $\frac{3}{4} \times 3\frac{1}{4}$

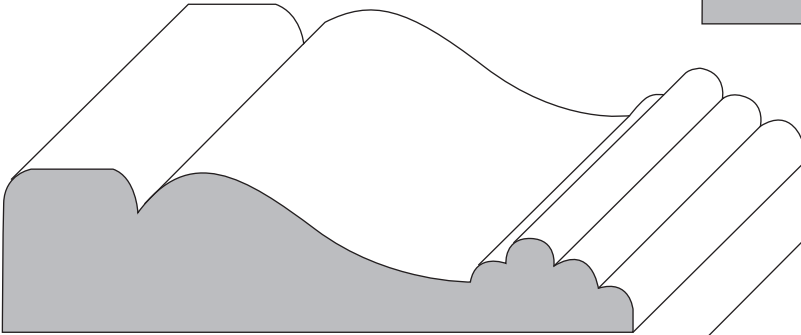

T-SL225
 $\frac{7}{8} \times 3\frac{1}{4}$

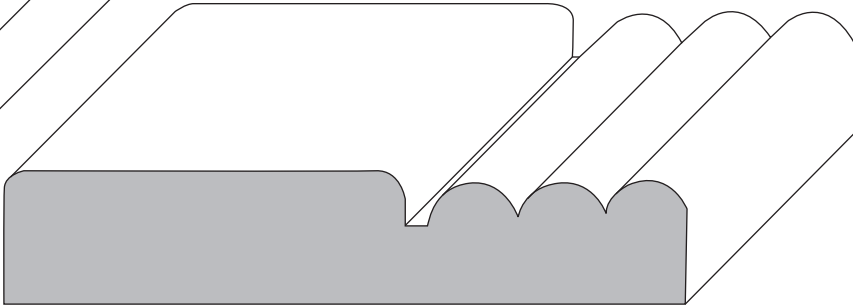

C-PM350
 $\frac{11}{16} \times 3\frac{1}{2}$

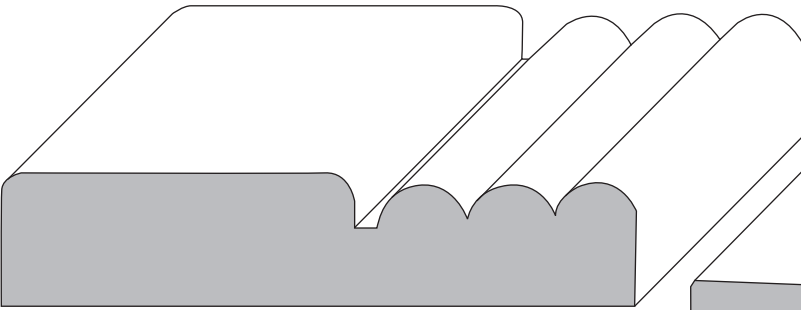

C-DC338
 $\frac{5}{8} \times 3\frac{3}{8}$

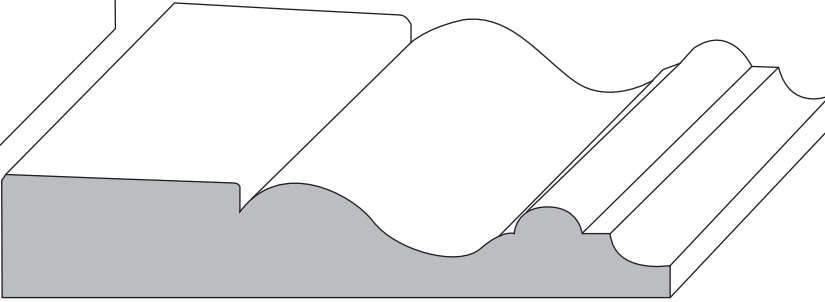

C-VI350
 $\frac{5}{8} \times 3\frac{1}{2}$

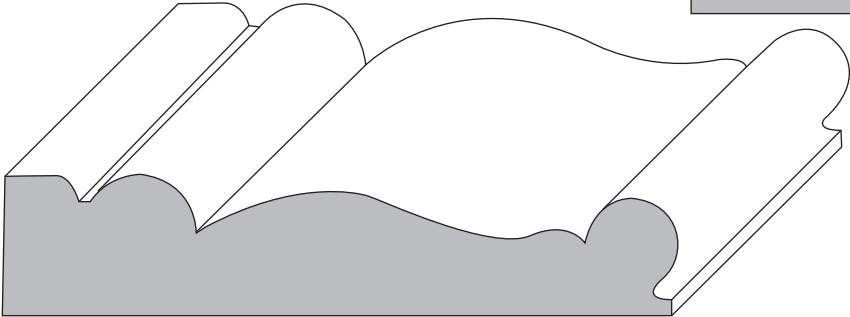

C-DS102
 $\frac{11}{16} \times 3\frac{1}{2}$



CASING

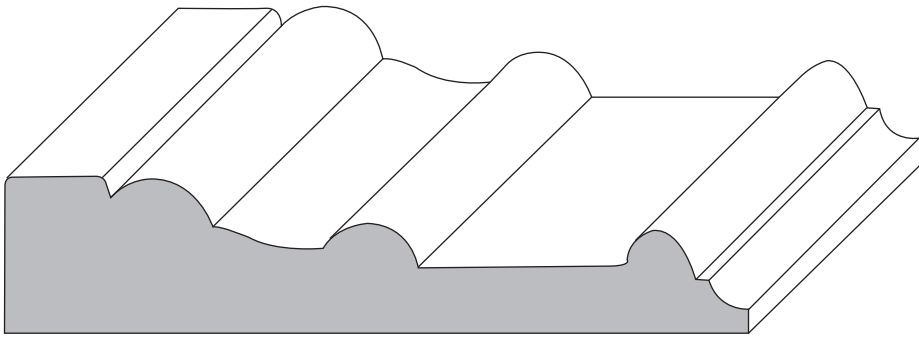

C-EM104
 $\frac{13}{16} \times 3\frac{3}{4}$

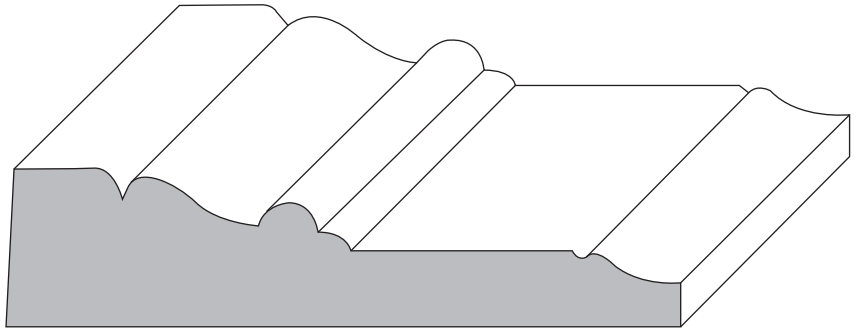

C-SMM3
 $\frac{13}{16} \times 3\frac{1}{2}$

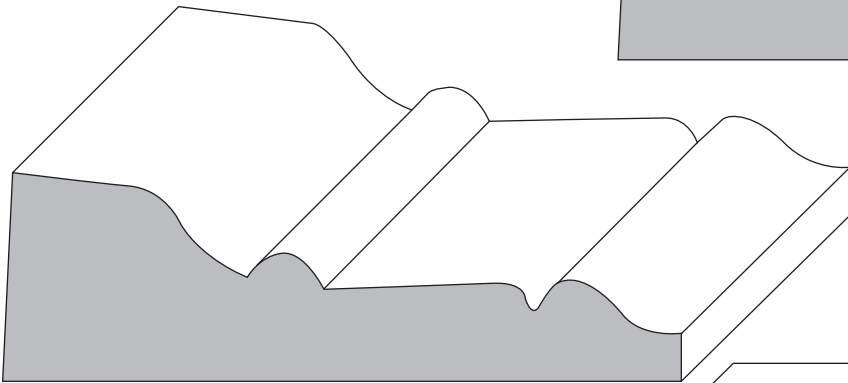

T-C1100
 $1 \times 3\frac{1}{2}$

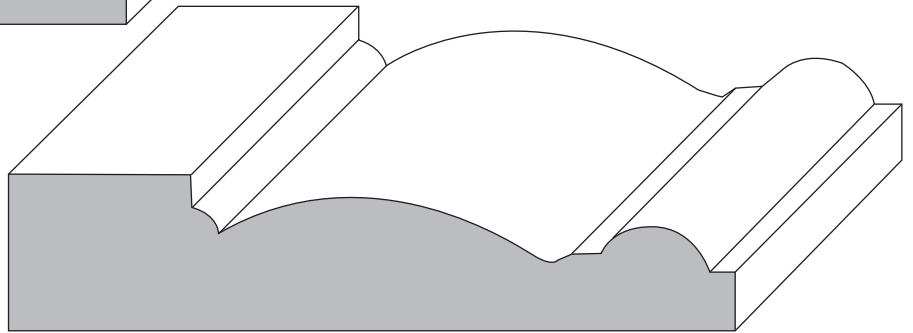

C-PM848
 $\frac{13}{16} \times 3\frac{3}{4}$

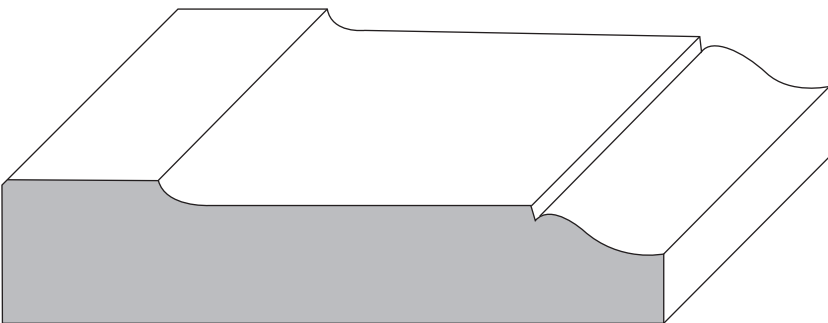

C-M21A
 $\frac{3}{4} \times 3\frac{3}{8}$

CASING

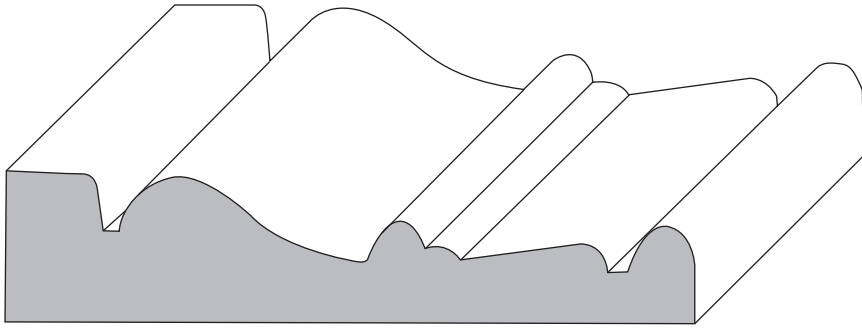

C-HLGRM
 $\frac{3}{4} \times 3\frac{5}{8}$

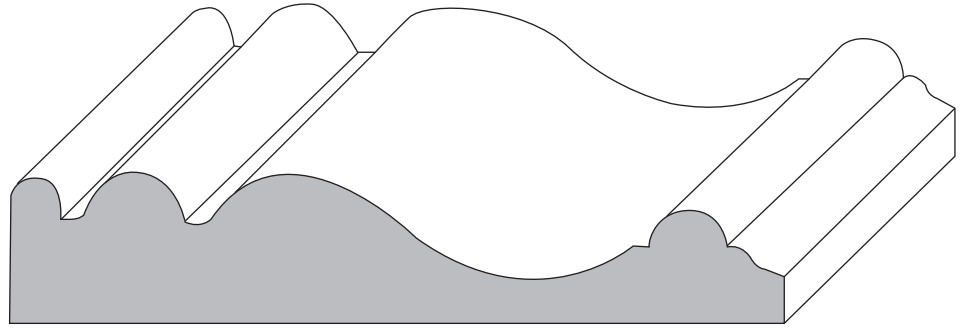

C-R270U
 $\frac{3}{4} \times 4$

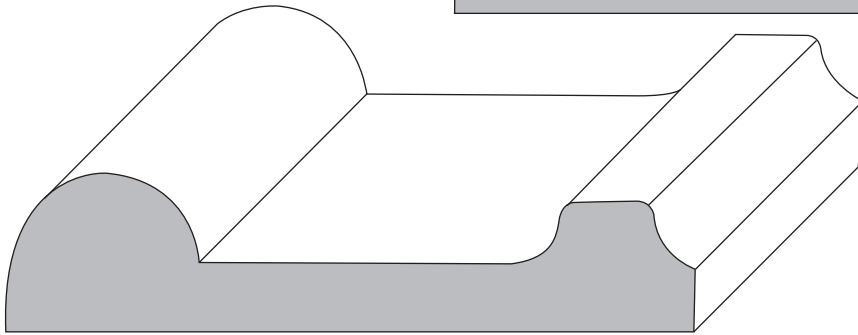

C-GROSS
 $\frac{13}{16} \times 3\frac{1}{2}$

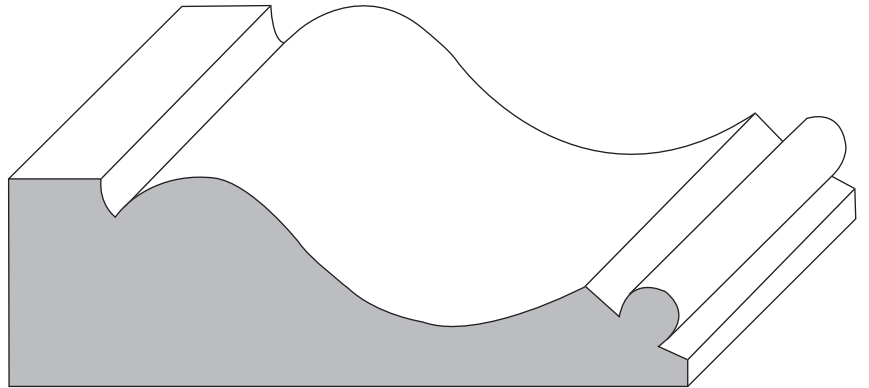

C-NJ177
 $1\frac{1}{16} \times 3\frac{1}{2}$

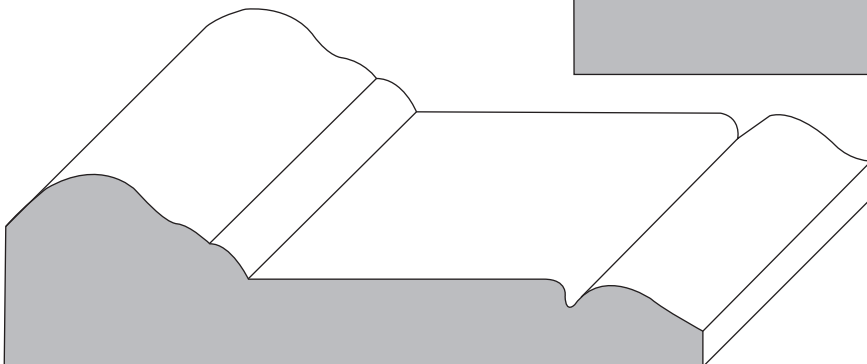

C-WP460
 $1 \times 3\frac{3}{8}$

CASING

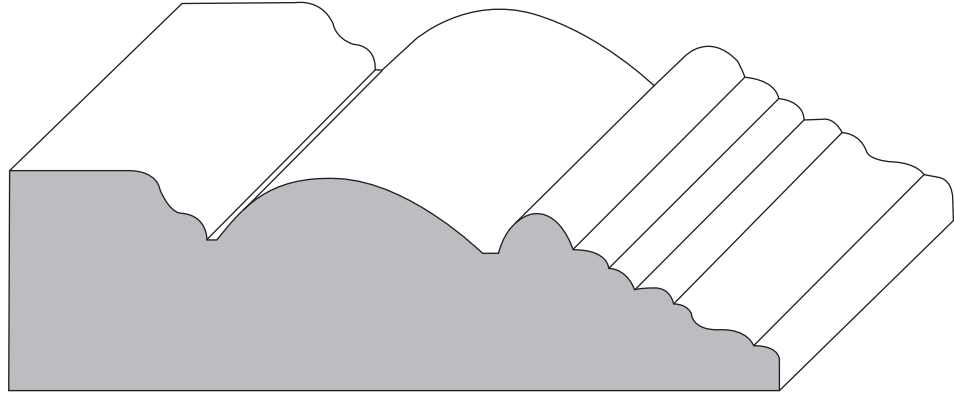

C-MD065
1 1/8 x 4

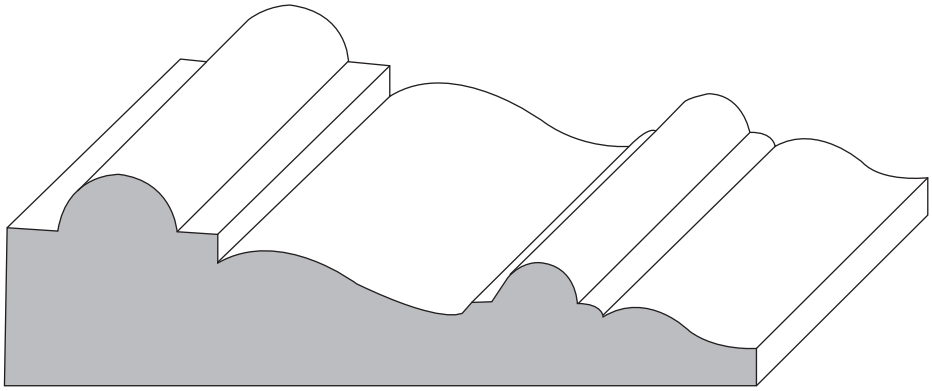

C-RR380
1 1/16 x 3 7/8

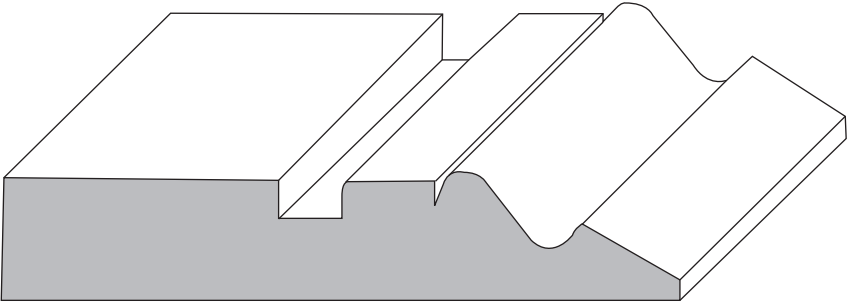

C-SE303
5/8 x 3 1/2

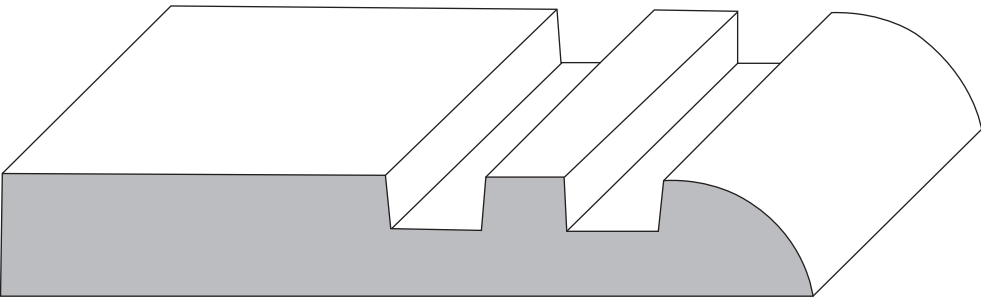

C-MD415
5/8 x 4 1/8

CASING

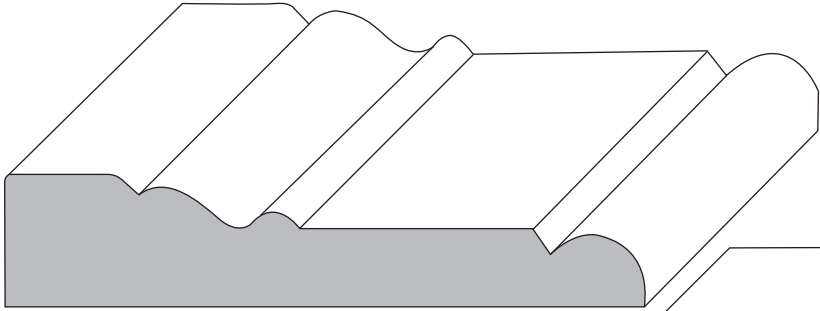

C-HERIT
 $\frac{1}{16} \times \frac{3}{4}$

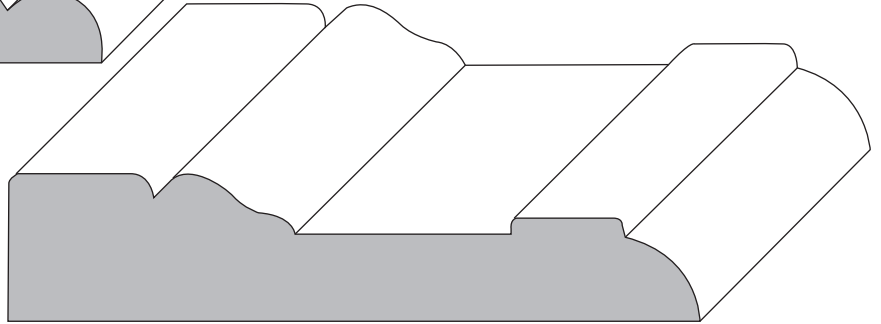

C-NJ128
 $\frac{3}{4} \times \frac{3}{16}$

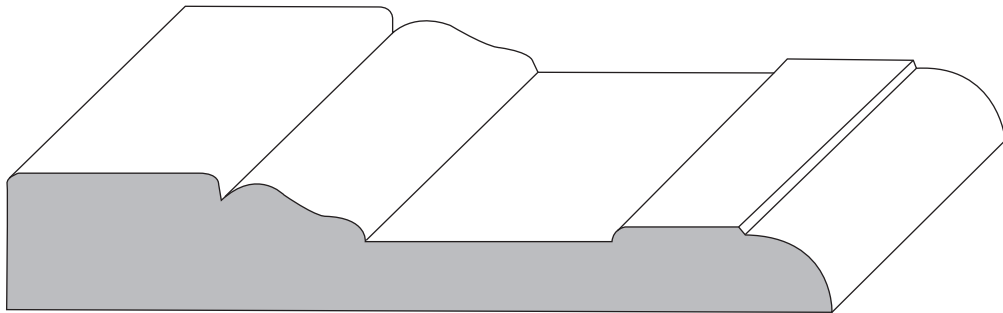

C-DI235
 $\frac{1}{16} \times \frac{4}{4}$

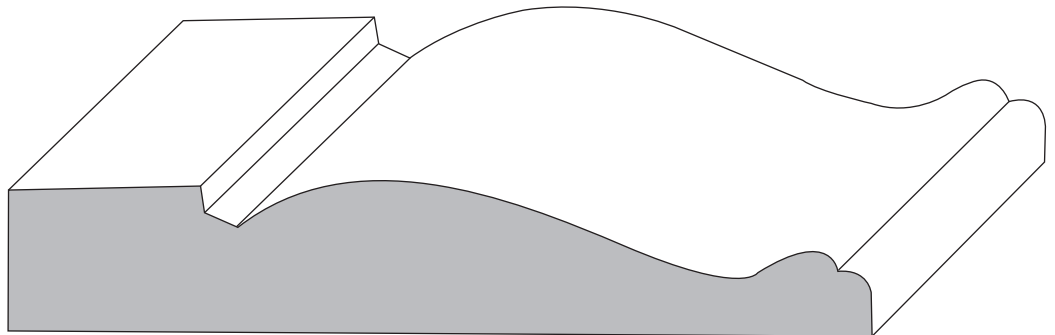

C-SM450
 $\frac{3}{4} \times \frac{4}{2}$

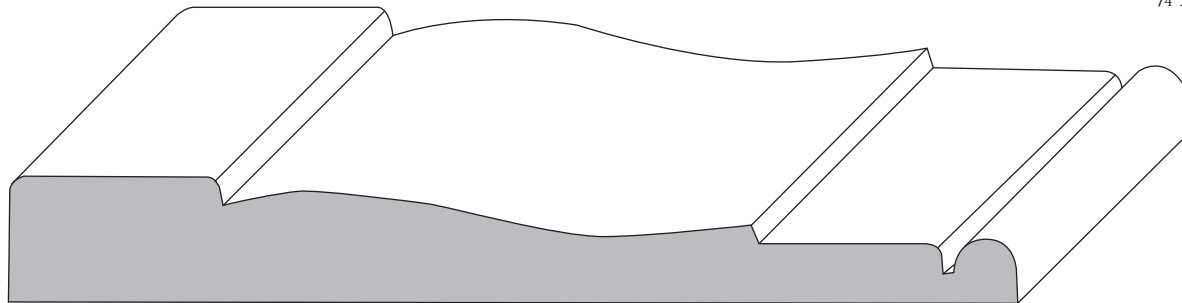

C-PM931
 $\frac{5}{8} \times \frac{5}{4}$

CASING

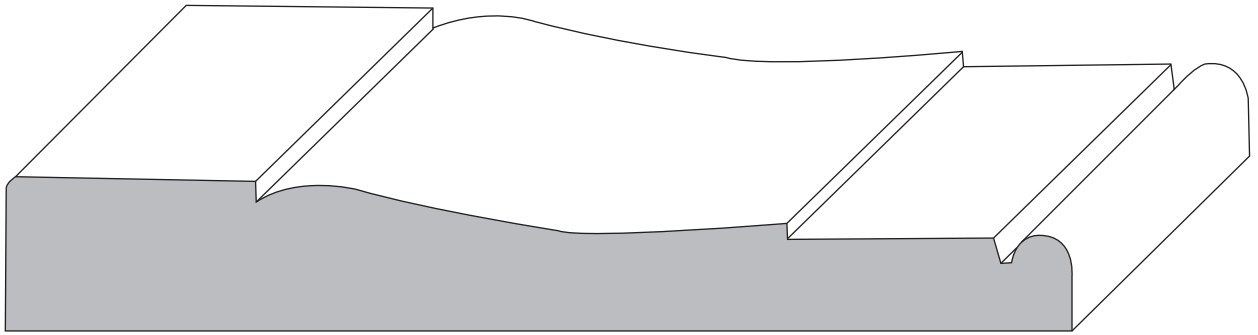

C-SM315
 $\frac{3}{4} \times 5\frac{1}{2}$

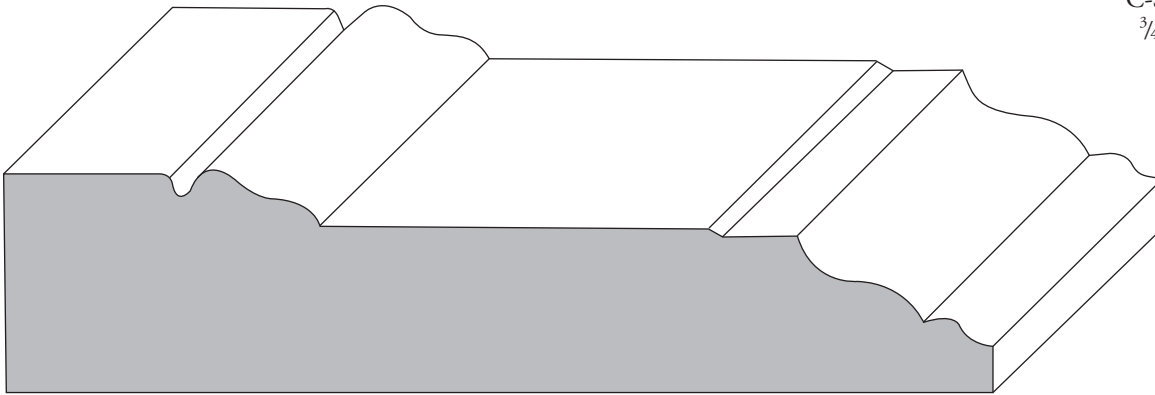

C-TH141
 $1\frac{1}{8} \times 5\frac{1}{8}$

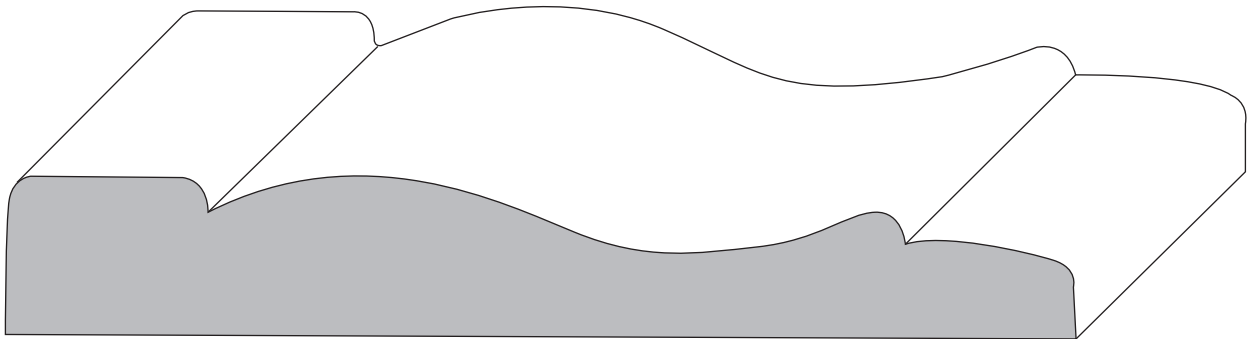

C-PA550
 $1\frac{3}{16} \times 5\frac{1}{2}$

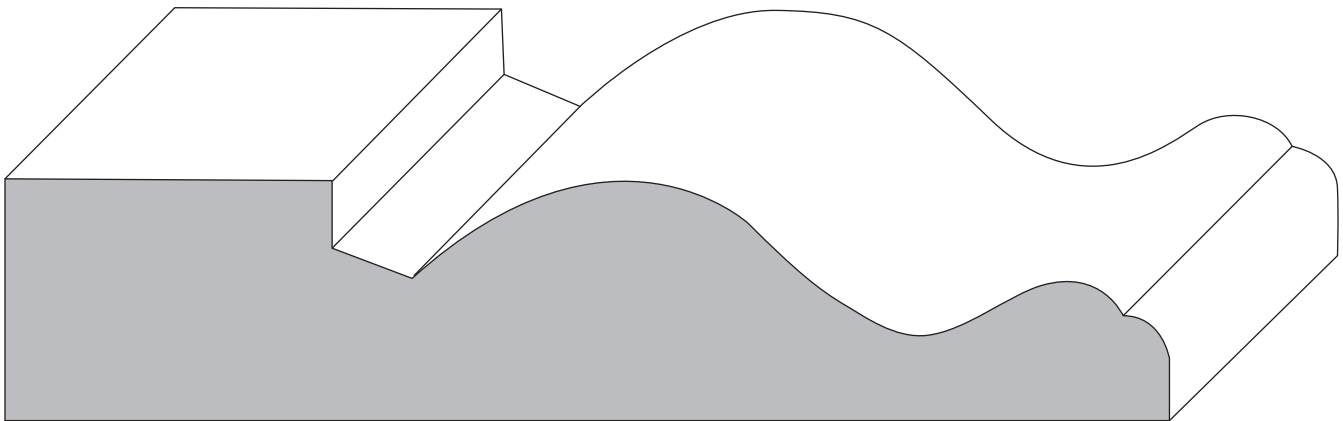

C-SM600
 $1\frac{1}{4} \times 6$

CASING

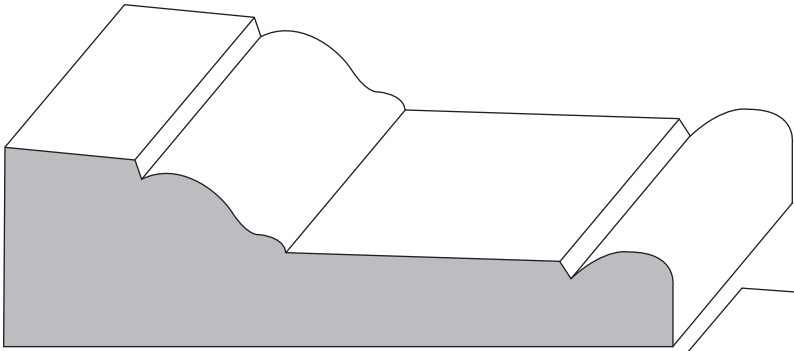

WM097
1 x 3½

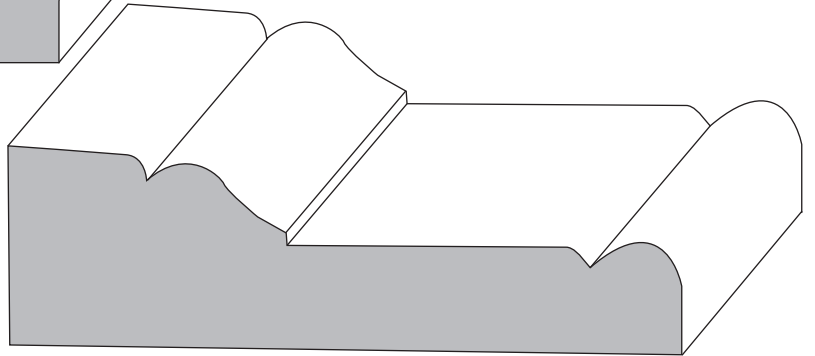

C-EC20
1 x 3½

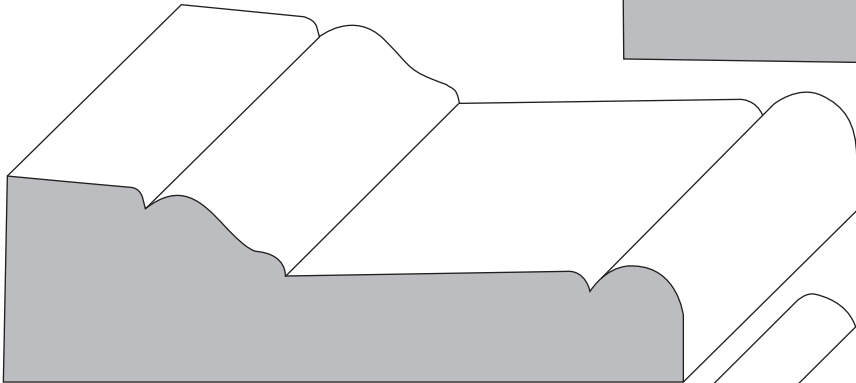

C-SSD97
1½ x 3⅞

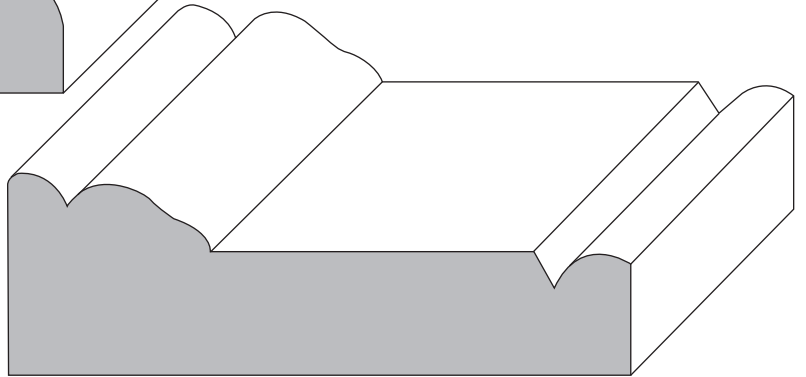

C-DYKSP
1 x 3¼

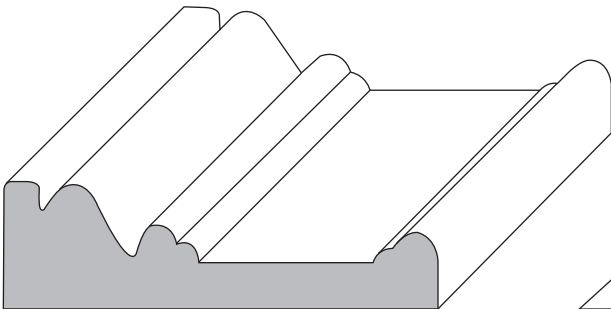

T-RB1
⅝ x 2¼

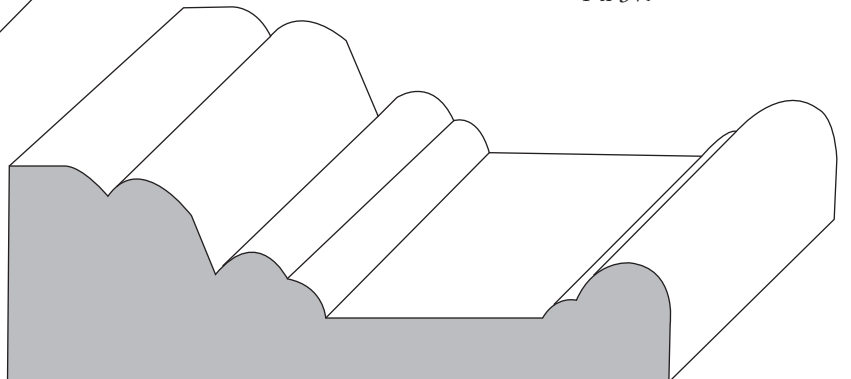

C-TT302
1½ x 3⅞

CASING

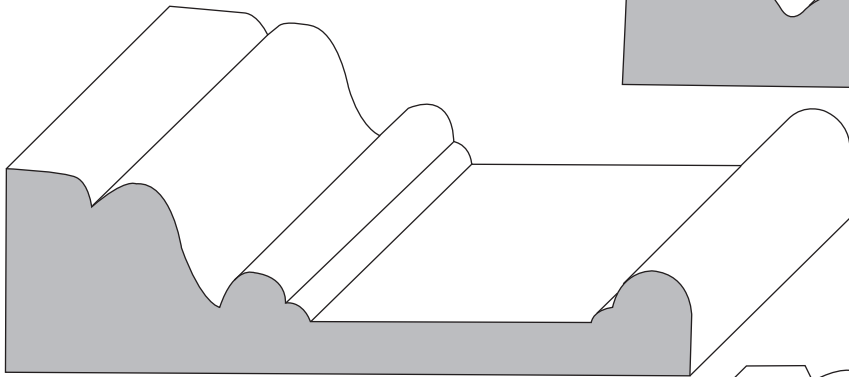

C-DHOWE
1 x 3½

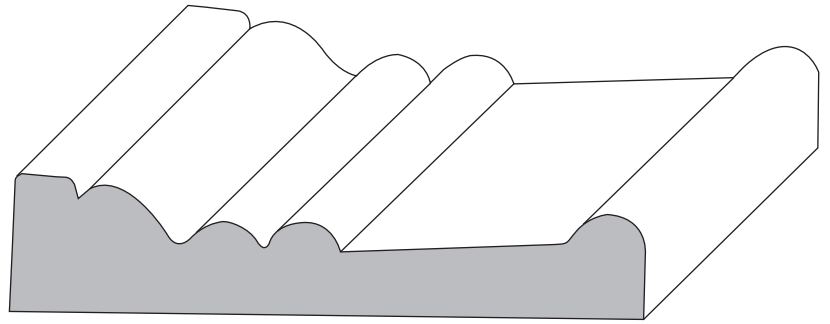

C-HSD-1
1¼ x 3¼

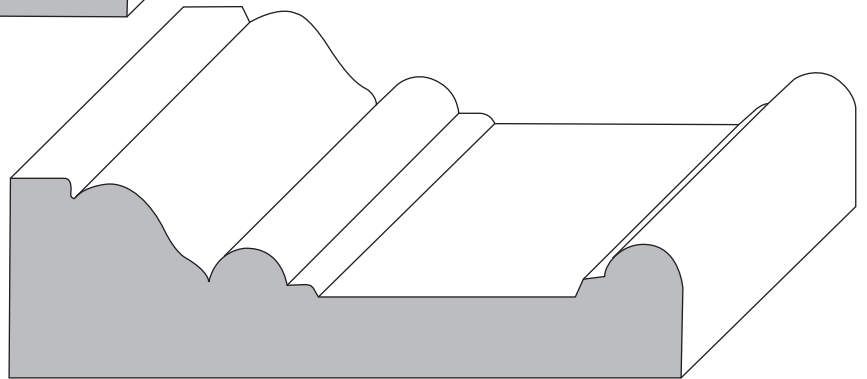

T-RB300
1 x 3½

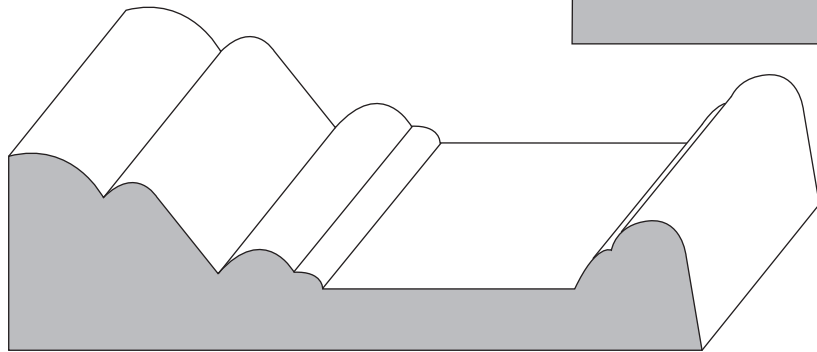

C-MSAL3
1 x 3½

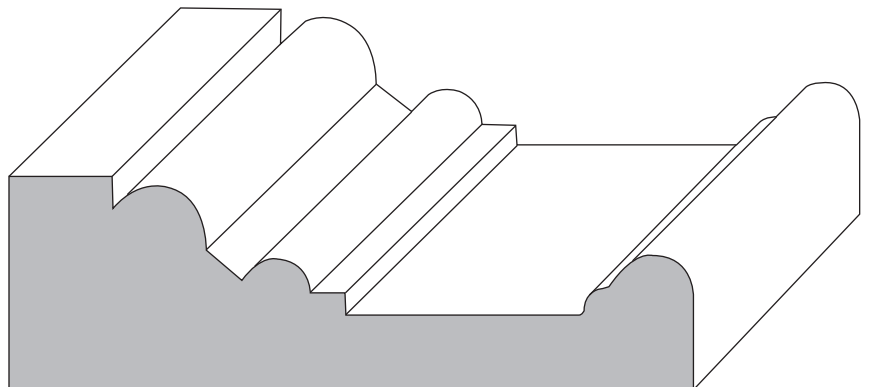

C-P2575
1⅛ x 3½

CASING

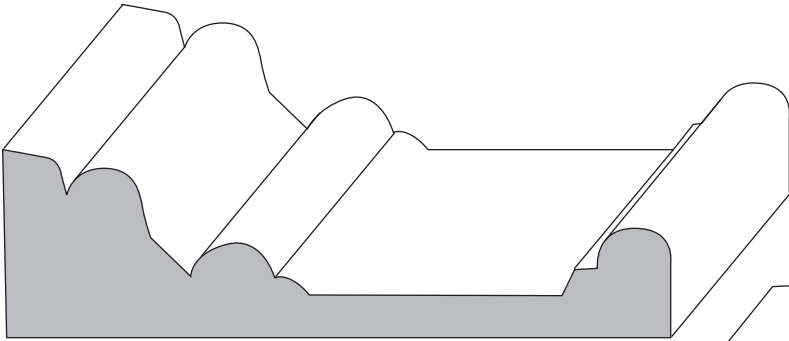

C-EC1
3½ x 1

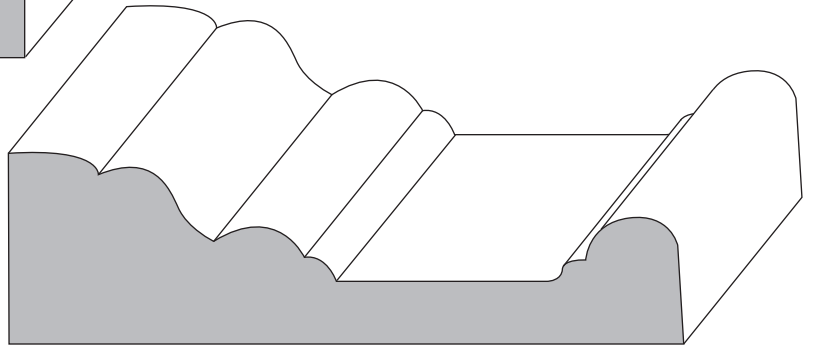

C-ECMD1
1 x 3½

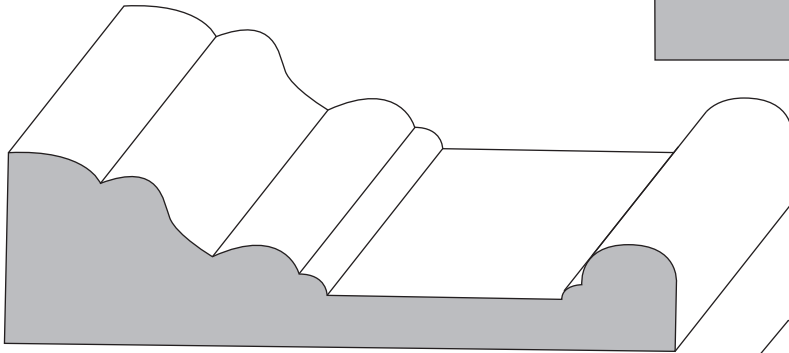

C-RB3M
1 x 3½

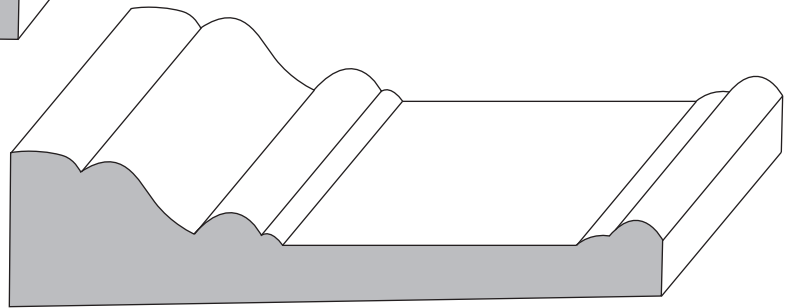

C-HB-78
7/8 x 3½

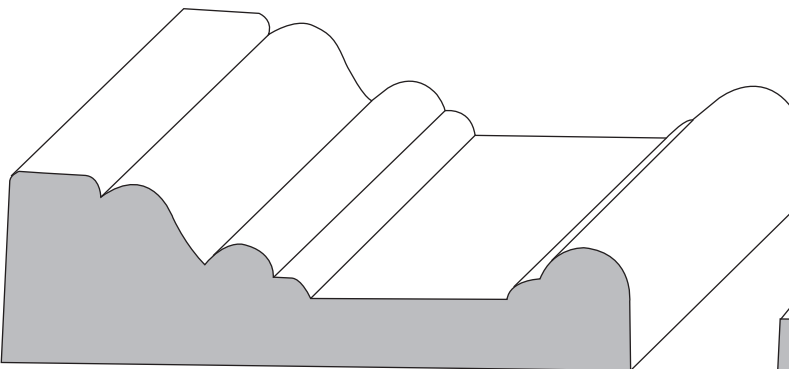

C-VS300
1 x 3¼

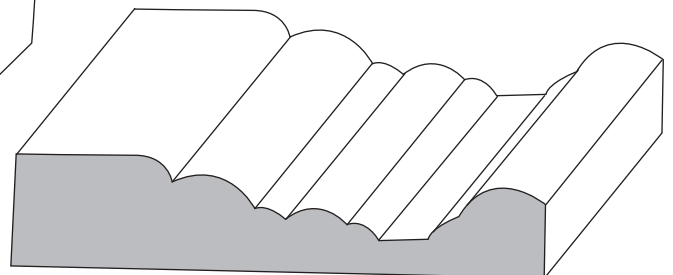

C-HS-2
5/8 x 2¾

CASING

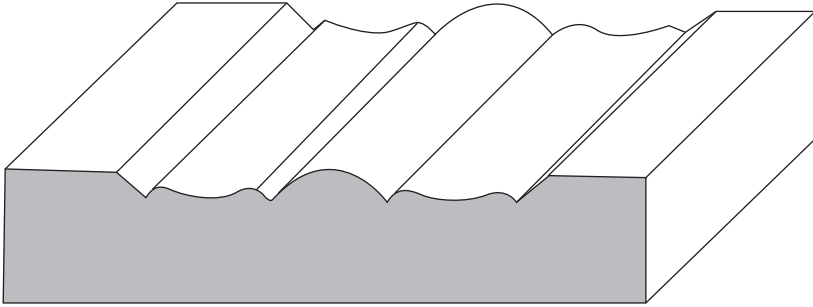

C-DC358
 $1\frac{1}{16} \times 3\frac{3}{8}$

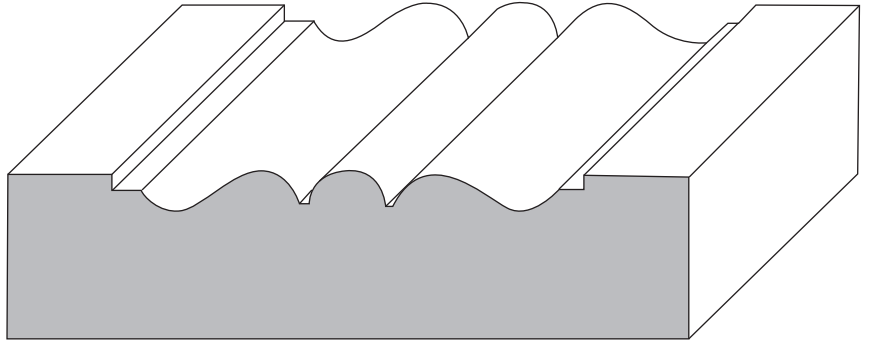

C-SS281
 $\frac{7}{8} \times 3\frac{1}{2}$

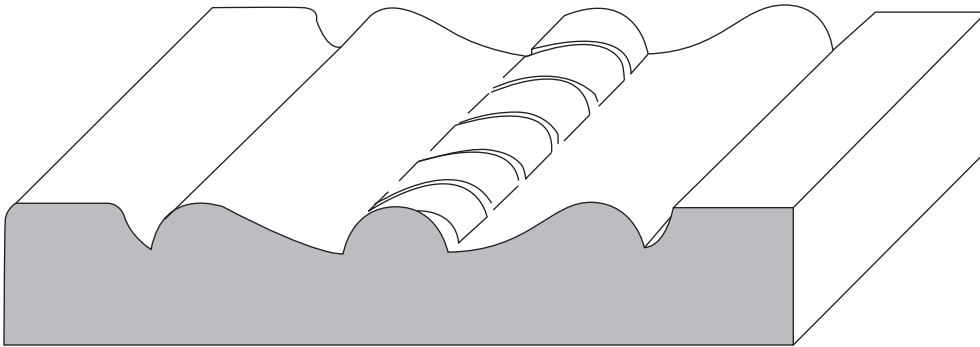

C-RR272
 $\frac{3}{4} \times 4$

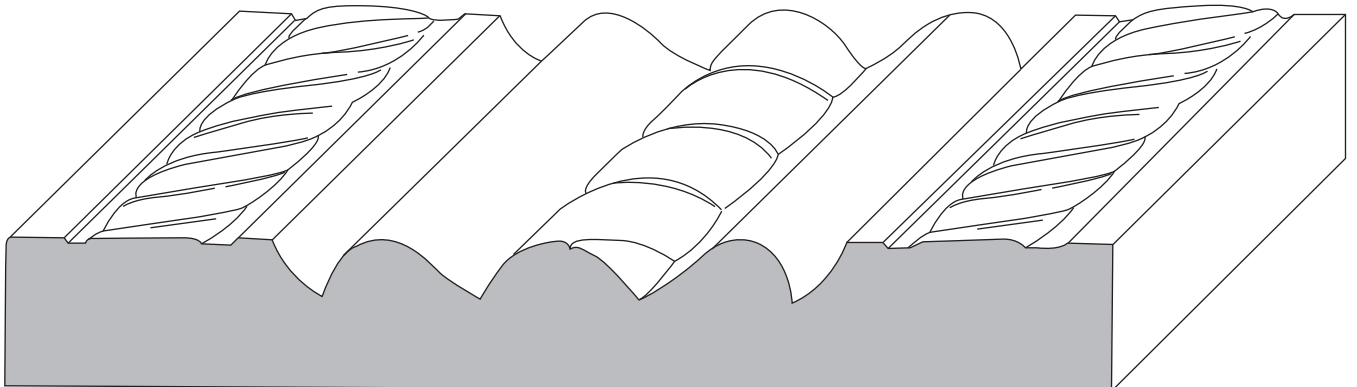

C-RR271
 $\frac{3}{4} \times 5\frac{3}{4}$

CASING

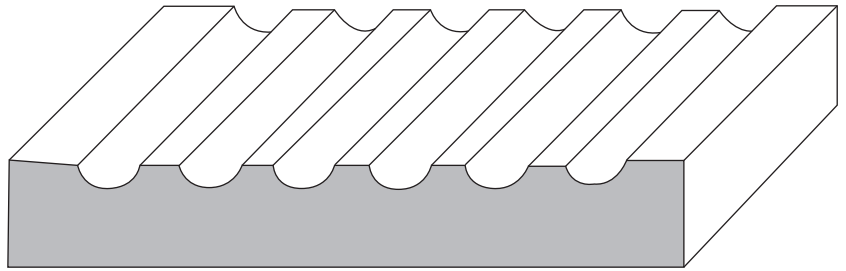

C-B1002
 $\frac{1}{2} \times 3\frac{9}{16}$

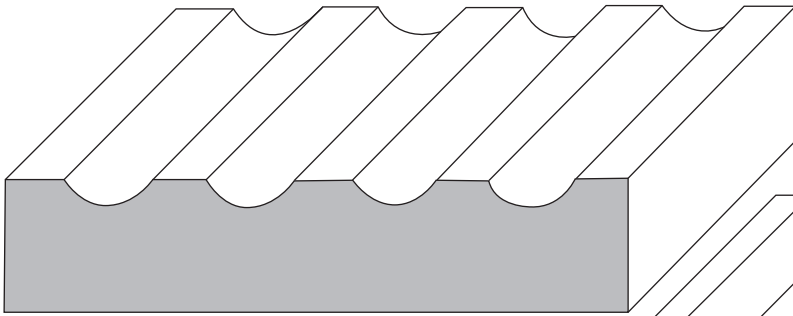

C-FLUTT
 $\frac{11}{16} \times 3\frac{1}{4}$

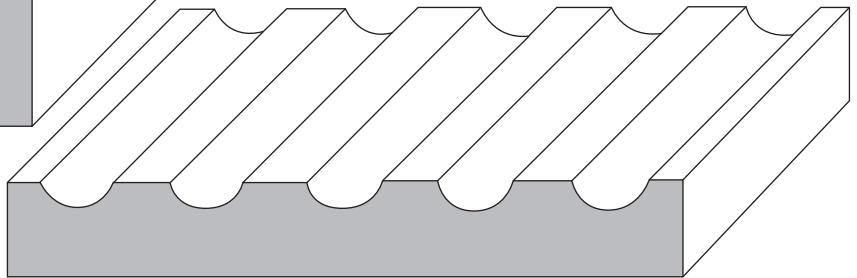

T-SL311
 $\frac{1}{2} \times 3\frac{1}{2}$

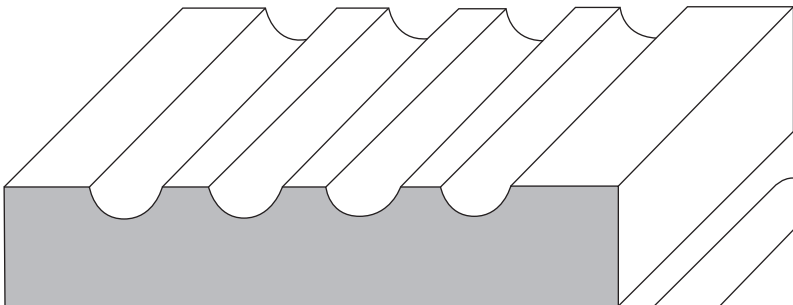

C-RRL05
 $\frac{5}{8} \times 3\frac{1}{4}$

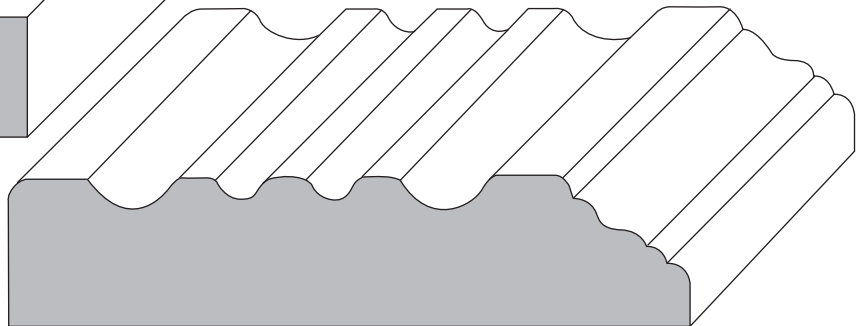

C-HI312
 $\frac{3}{4} \times 3\frac{1}{2}$

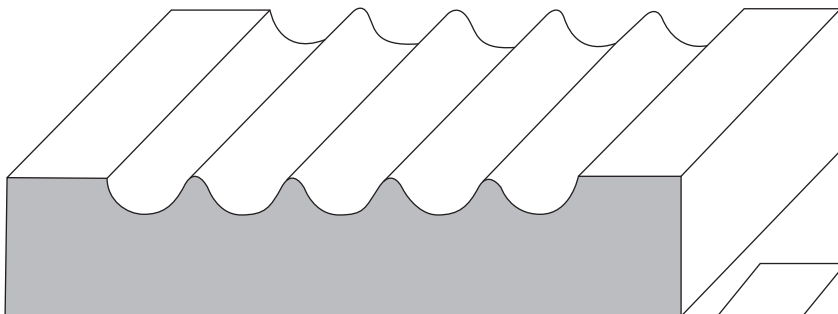

C-CL312
 $\frac{3}{4} \times 3\frac{1}{2}$

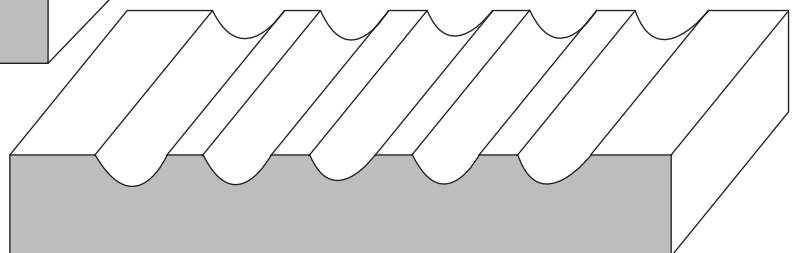

C-RB6F
 $\frac{5}{8} \times 3\frac{1}{2}$

CASING

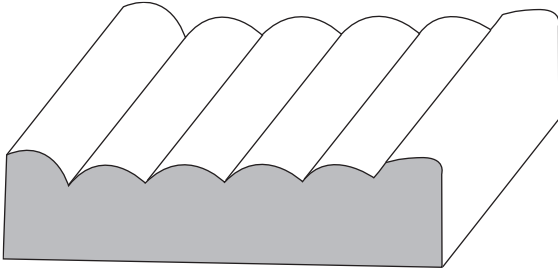

C-1002M
 $\frac{9}{16} \times 2\frac{1}{4}$

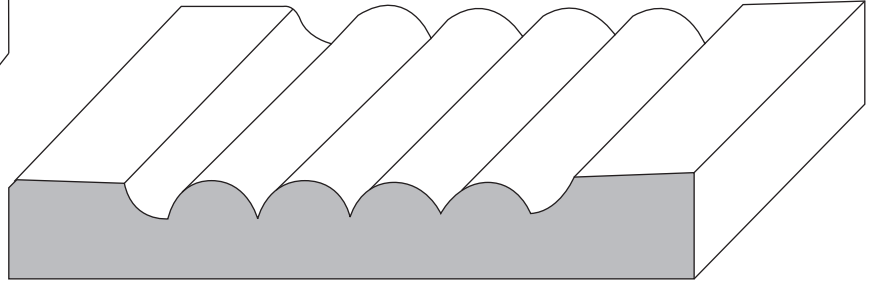

C-M15
 $\frac{1}{2} \times 3\frac{1}{2}$

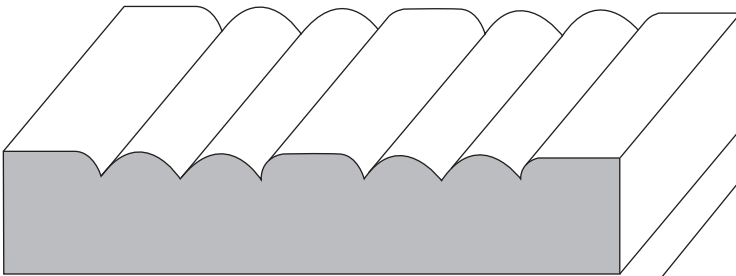

C-EC14R
 $\frac{5}{8} \times 3\frac{1}{4}$

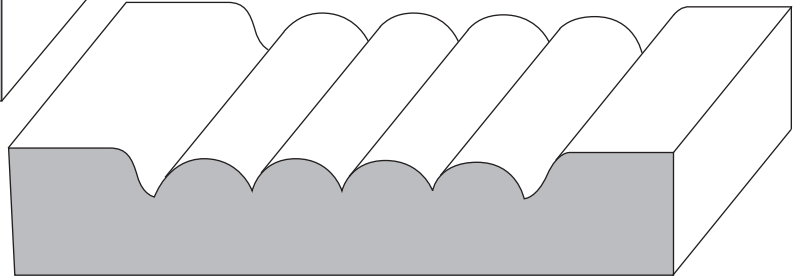

C-RB6R
 $\frac{5}{8} \times 3\frac{1}{2}$

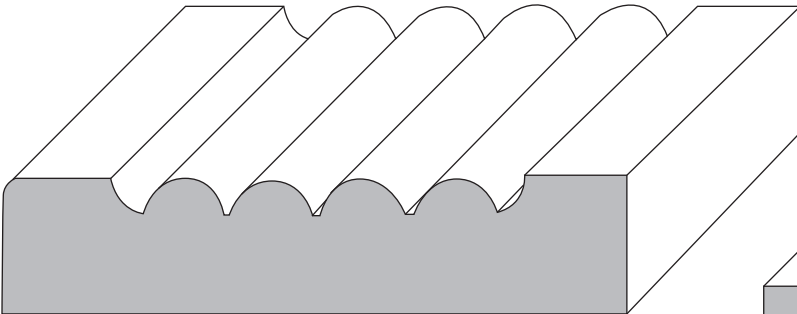

C-RR260
 $1\frac{1}{16} \times 3\frac{1}{4}$

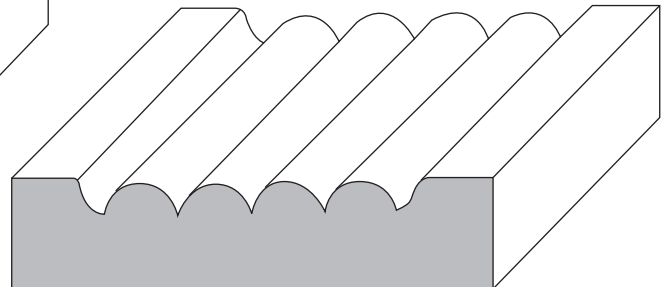

C-RR255
 $\frac{9}{16} \times 2\frac{1}{2}$

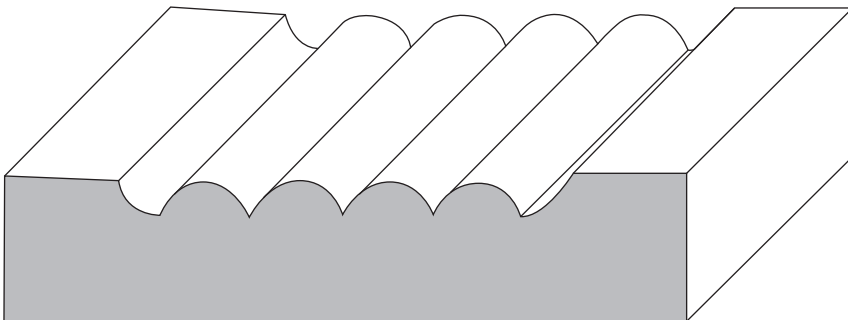

C-RAM15
 $\frac{3}{4} \times 3\frac{1}{2}$

CASING

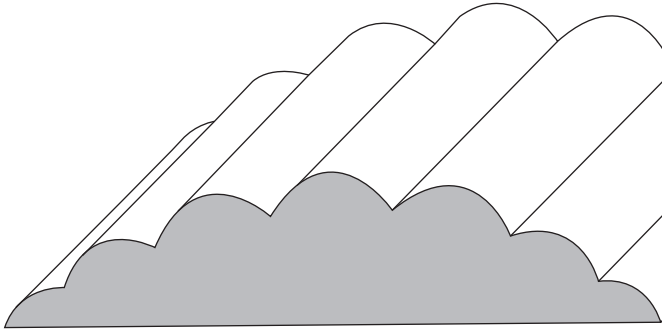

C-M14
 $1\frac{3}{16} \times 3\frac{3}{8}$

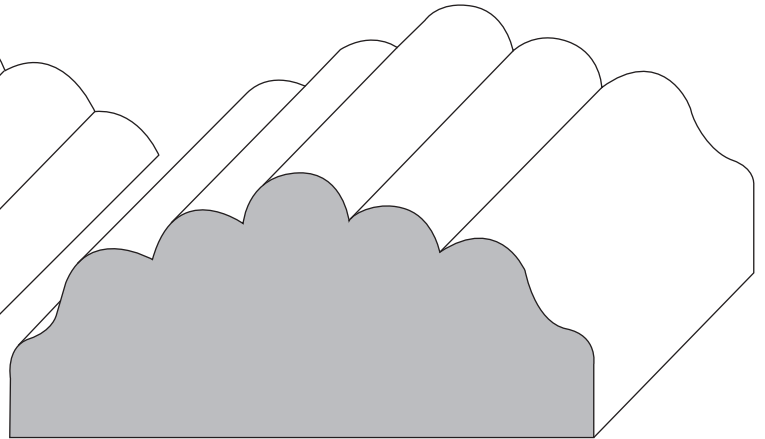

C-RR300
 $1\frac{5}{16} \times 3$

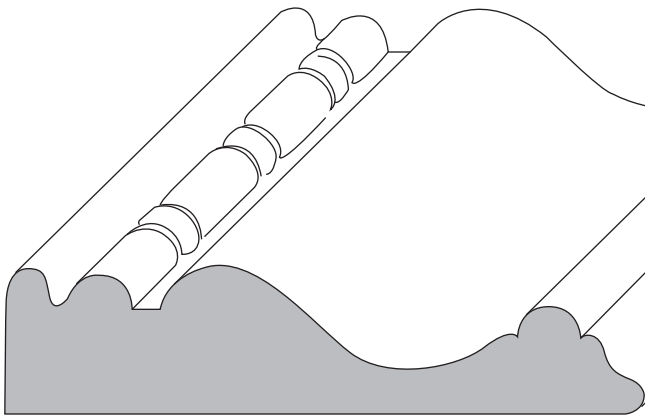

C-RR265
 $\frac{3}{4} \times 3\frac{1}{4}$

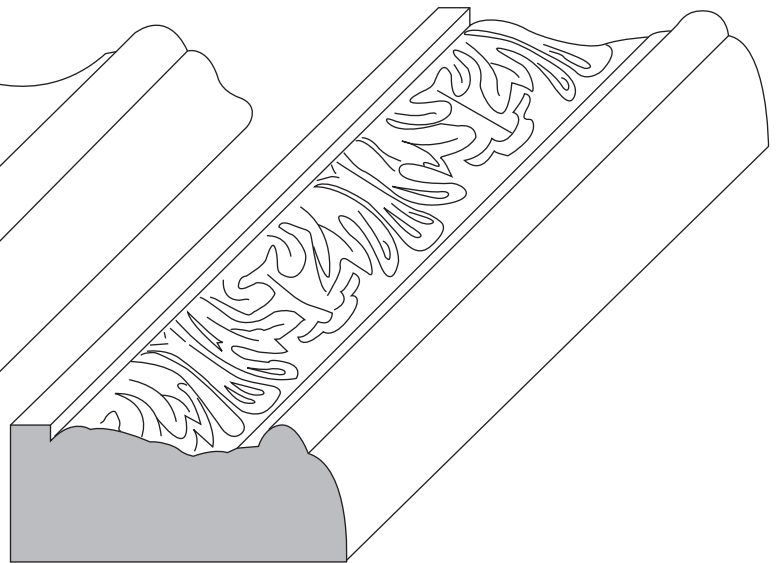

C-EM61S
 $\frac{3}{4} \times 1\frac{3}{4}$

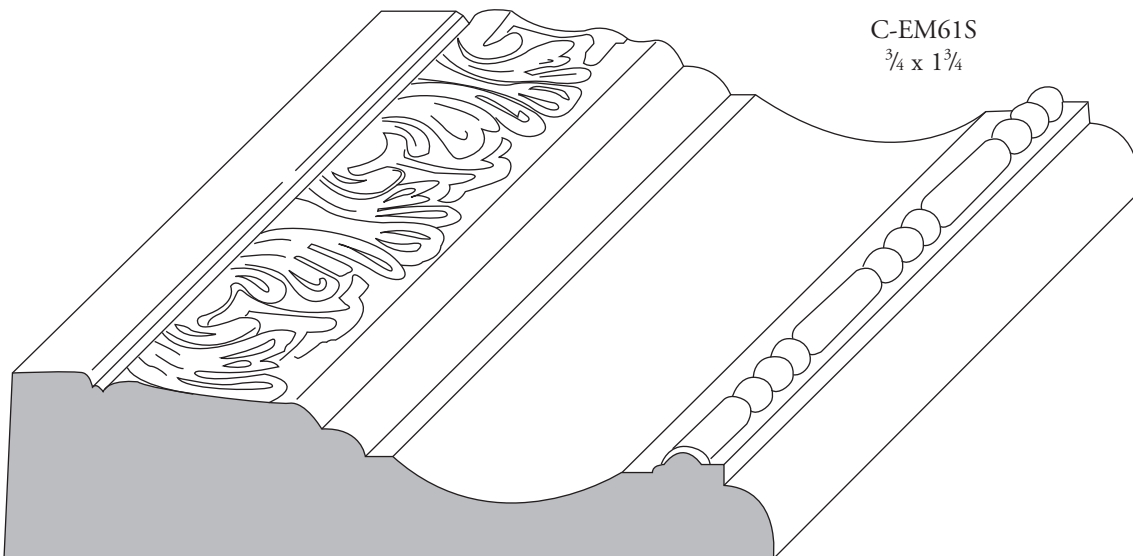

C-DS408
 1×4

CASING

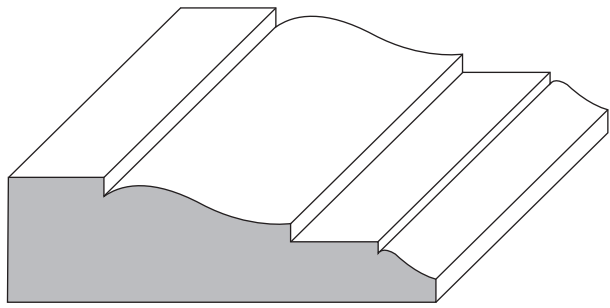

T-WM366
1¹¹/₁₆ x 2¹/₄

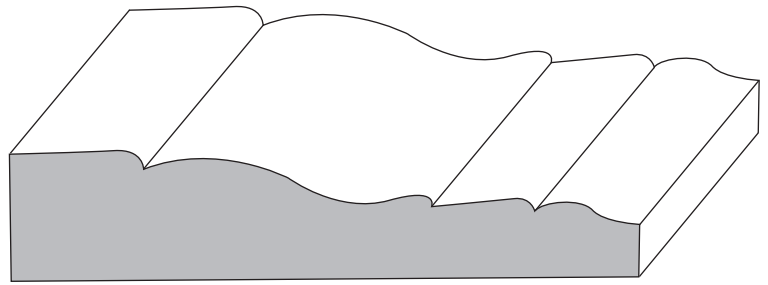

C-EC361
1¹¹/₁₆ x 3³/₄

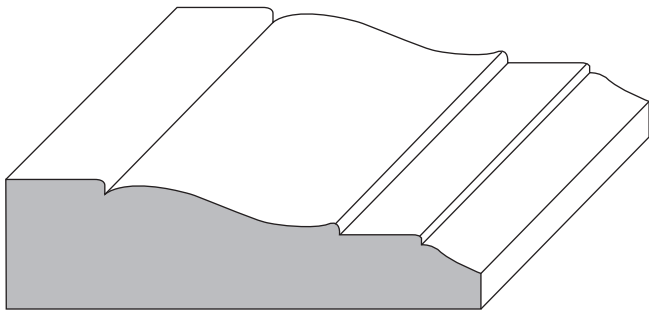

T-WM361
1¹¹/₁₆ x 2¹/₂

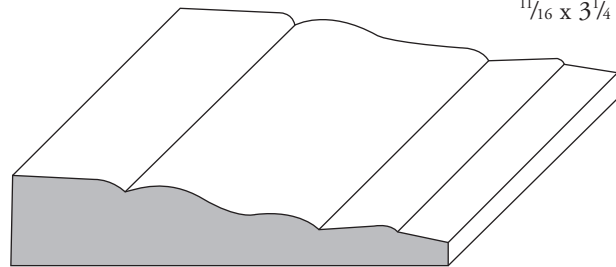

T-FL366
7⁷/₁₆ x 2¹/₄

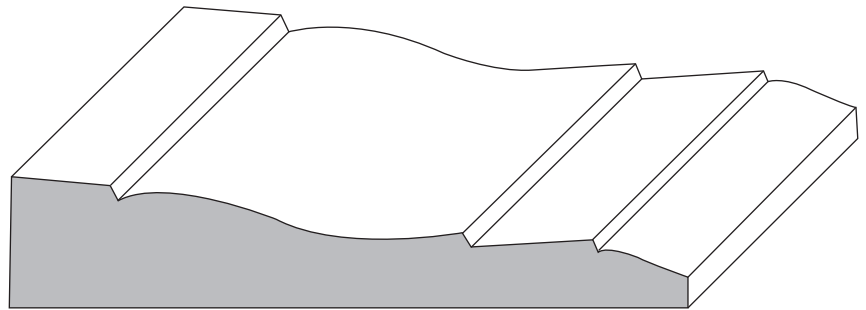

C-L8753
5⁵/₈ x 3¹/₂

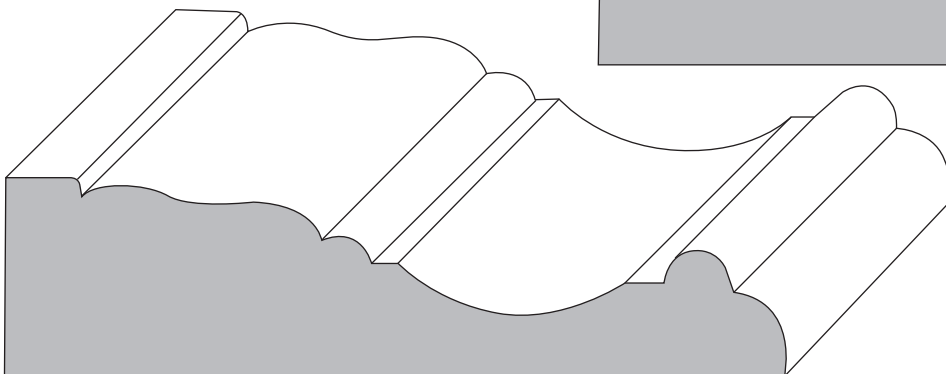

C-DS400
1 x 4

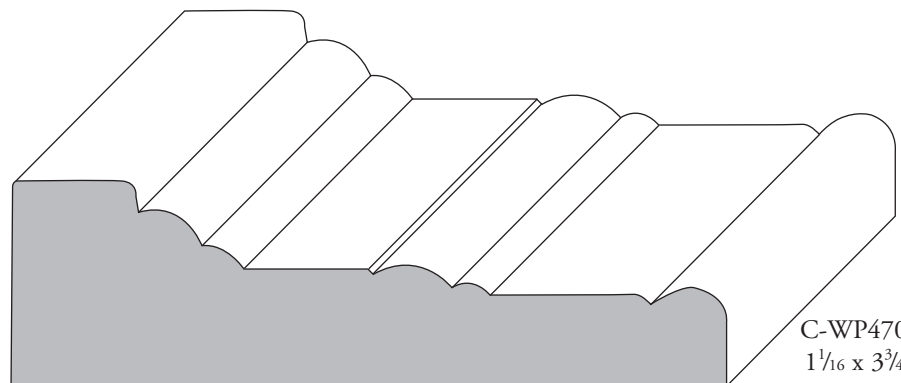

C-WP470
1¹/₁₆ x 3³/₄

CASING

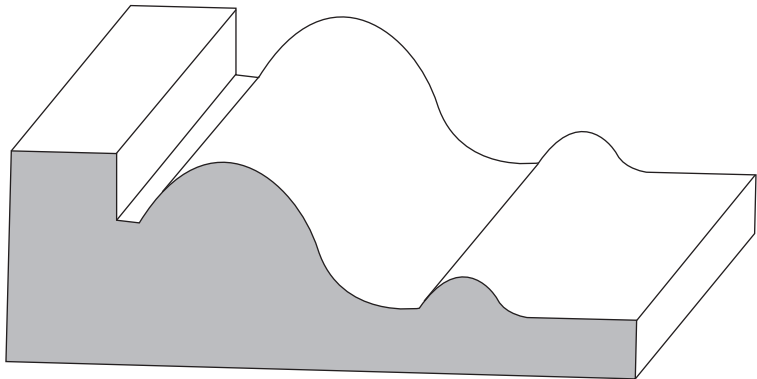

C-SPRAT
1 1/8 x 3 1/4

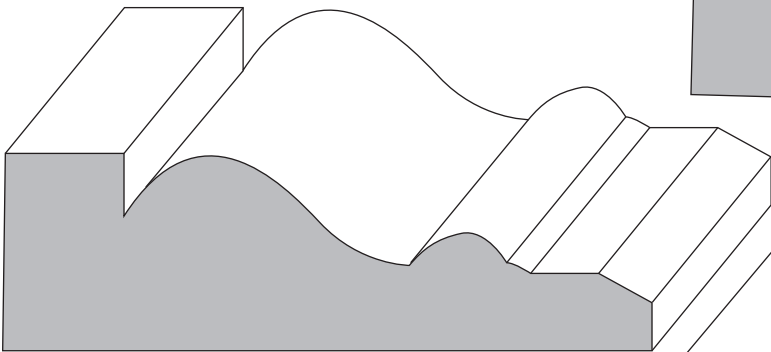

C-SPRTL
1 x 3 1/2

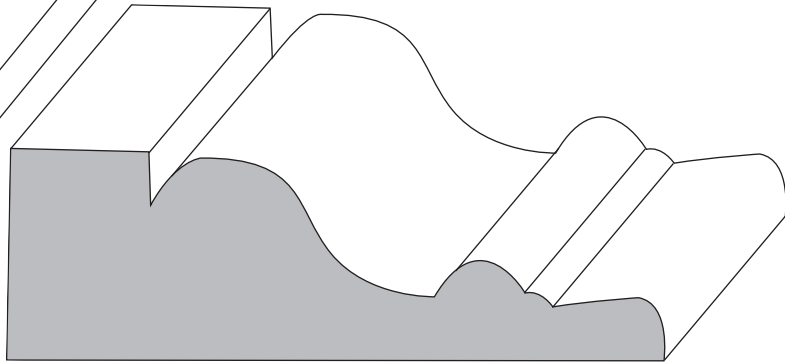

C-M1661
1 1/8 x 3 3/8

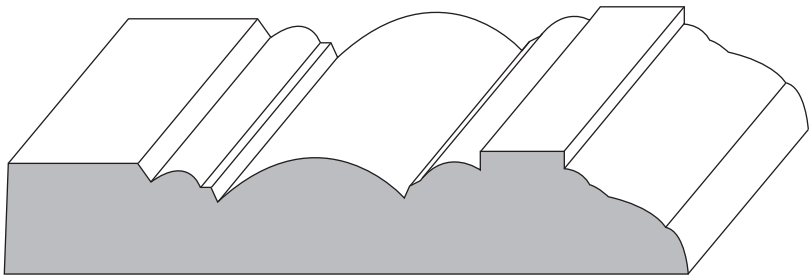

C-HB341
5/8 x 3 1/2

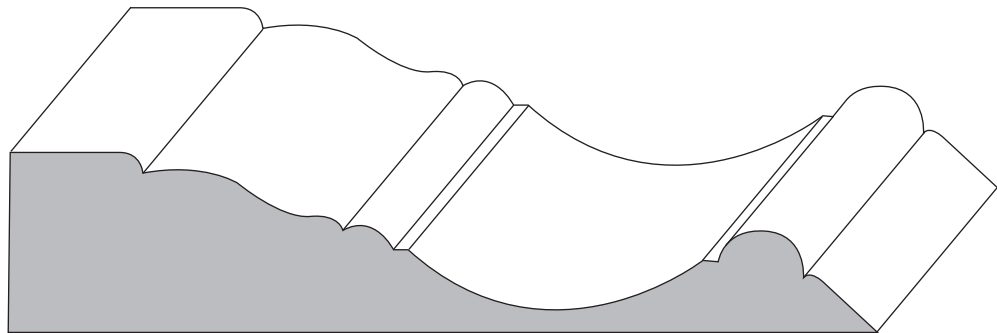

C-441WM
1 1/16 x 4 1/2

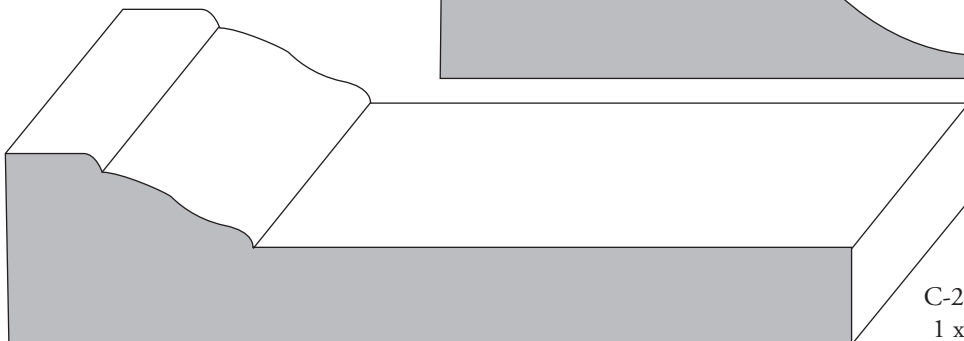

C-281-4
1 x 4 1/2

CASING

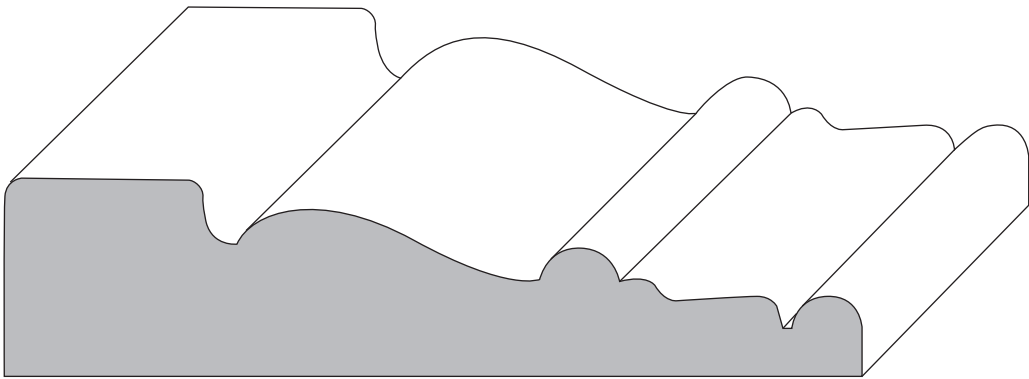

C-NJ419
1 x 4³/₈

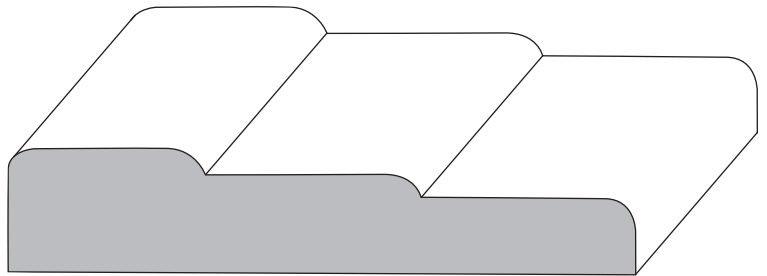

C-EC683
5/8 x 3¹/₄

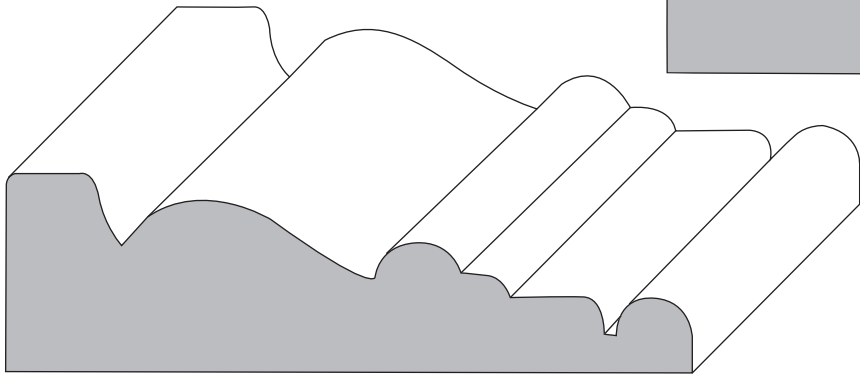

C-NJ119
1 x 3¹/₂

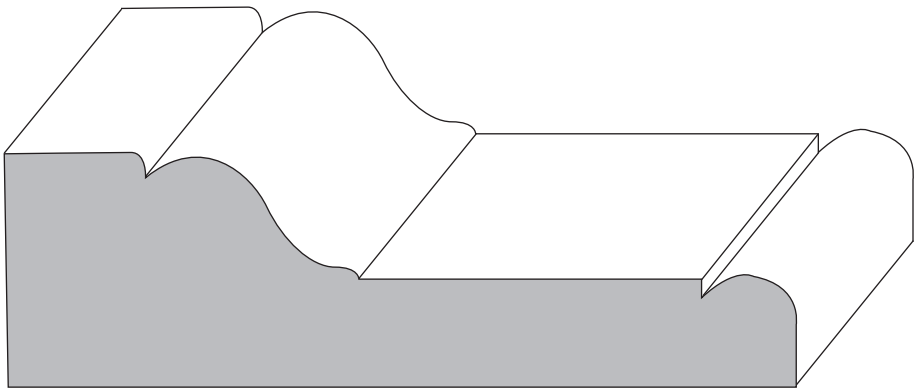

C-TC304
1¹/₄ x 4¹/₁₆

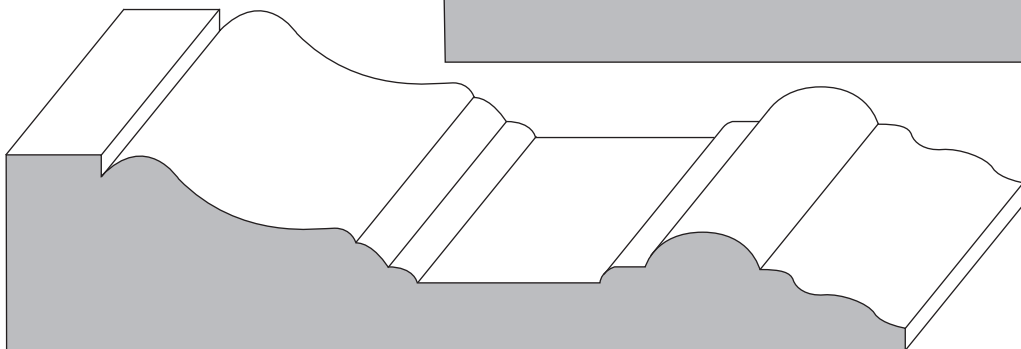

C-AH466
1¹/₁₆ x 4⁵/₈

BASE

T-WM623
 $\frac{9}{16} \times 3\frac{1}{4}$

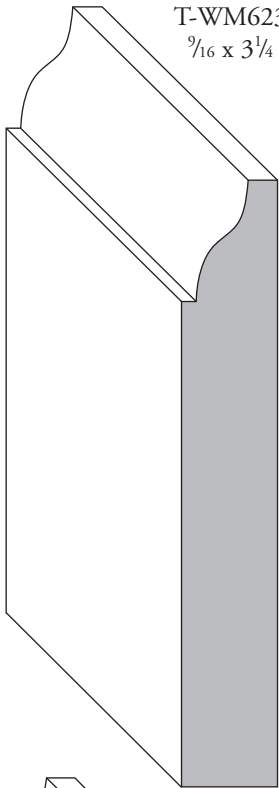

T-WM753
 $\frac{9}{16} \times 3\frac{1}{4}$

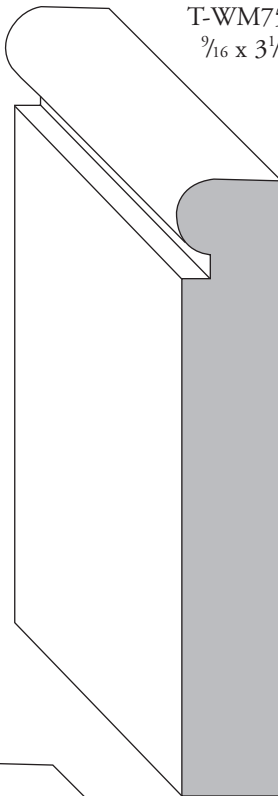

T-WM663
 $\frac{9}{16} \times 3$

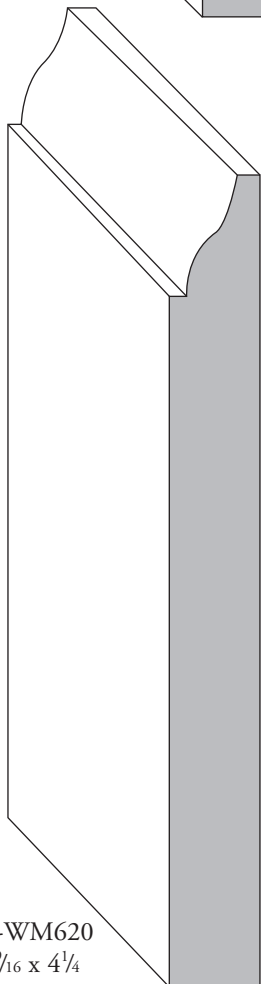
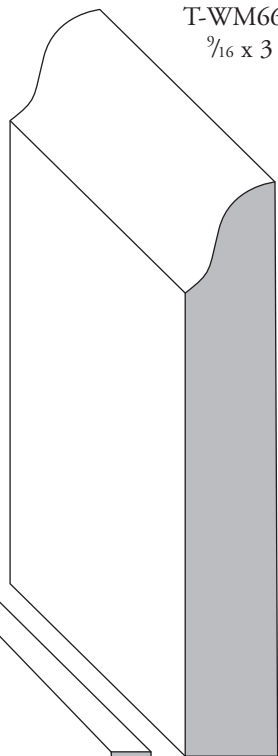

T-WM620
 $\frac{9}{16} \times 4\frac{1}{4}$

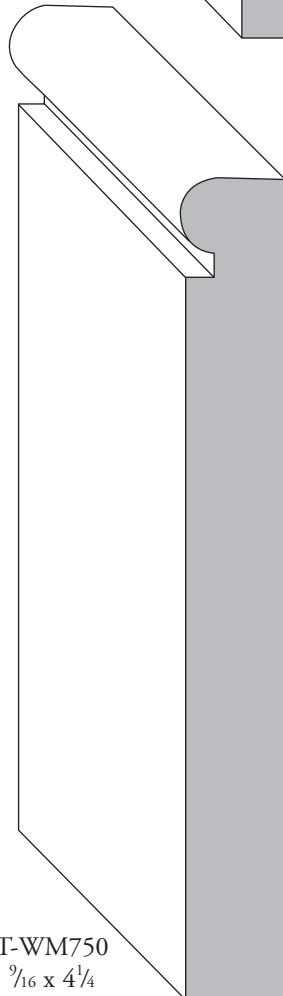

T-WM750
 $\frac{9}{16} \times 4\frac{1}{4}$

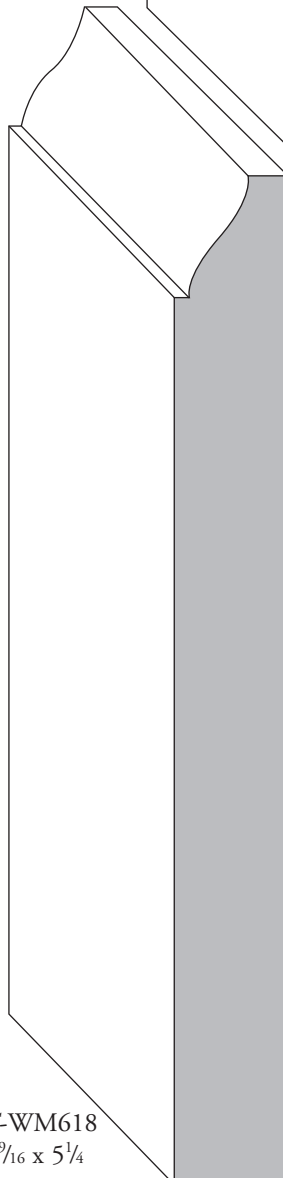

T-WM618
 $\frac{9}{16} \times 5\frac{1}{4}$

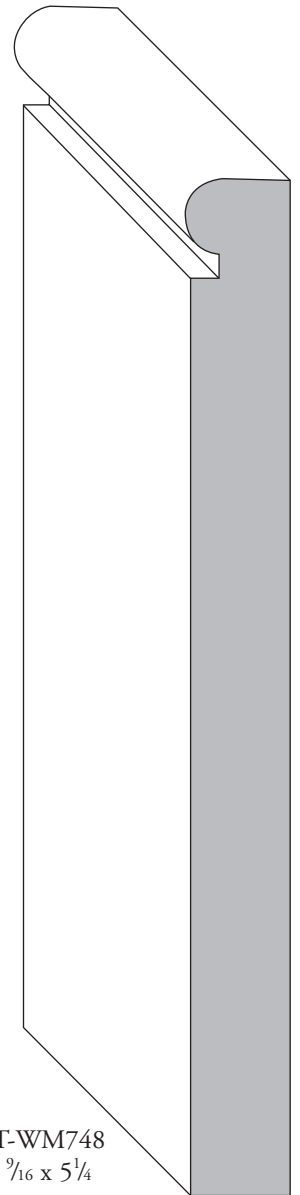

T-WM748
 $\frac{9}{16} \times 5\frac{1}{4}$

BASE

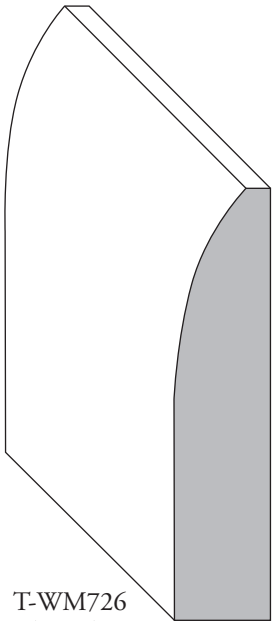

T-WM726
 $\frac{1}{2} \times 2\frac{1}{4}$

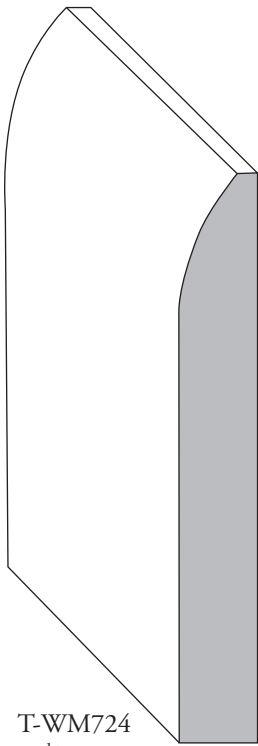

T-WM724
 $\frac{1}{2} \times 3$

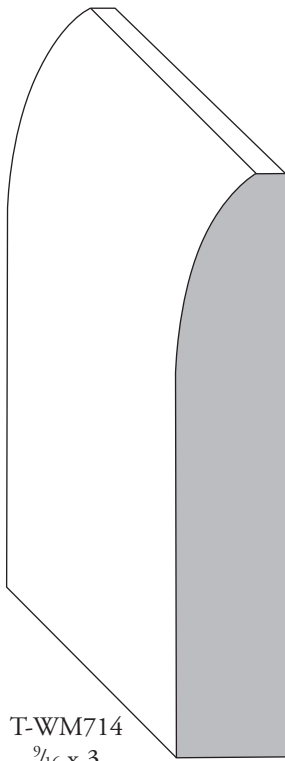

T-WM714
 $\frac{9}{16} \times 3$

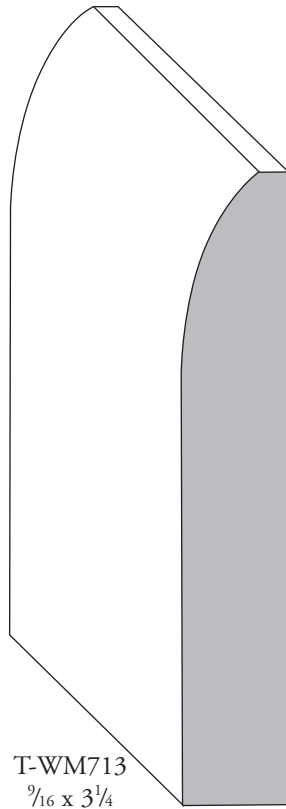

T-WM713
 $\frac{9}{16} \times 3\frac{1}{4}$

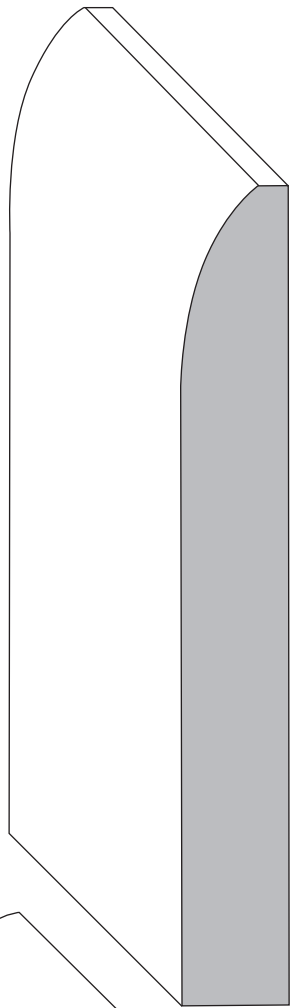

T-WM710
 $\frac{9}{16} \times 4\frac{1}{4}$

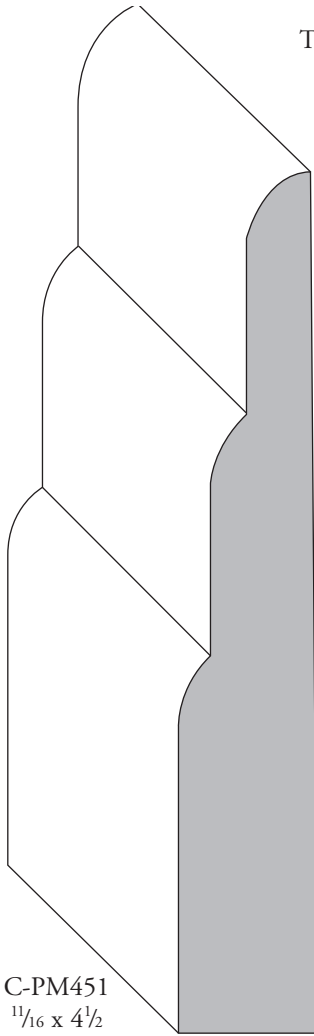

C-PM451
 $\frac{11}{16} \times 4\frac{1}{2}$

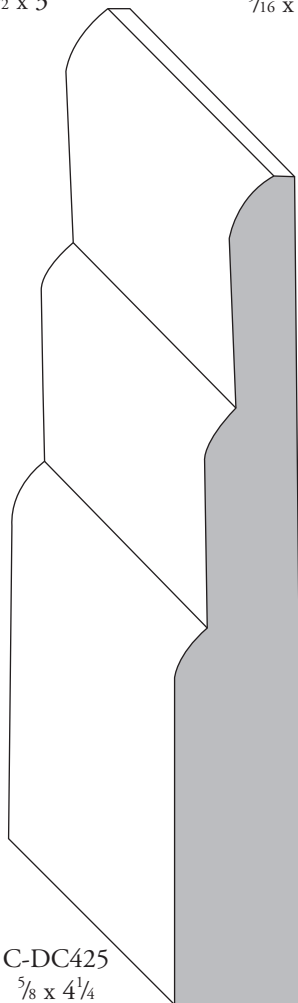

C-DC425
 $\frac{5}{8} \times 4\frac{1}{4}$

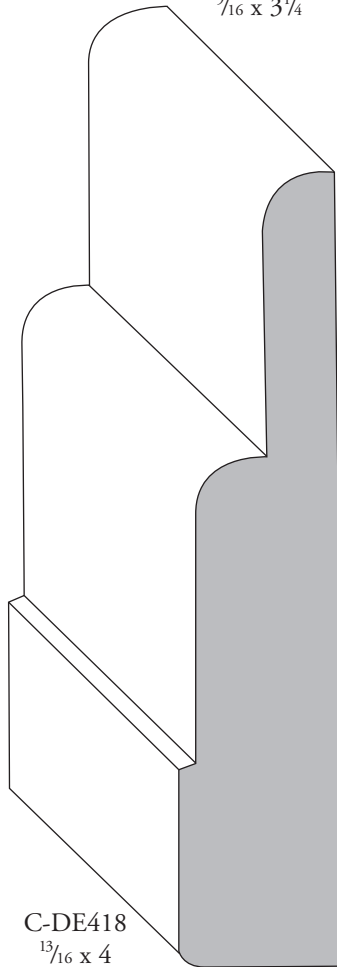

C-DE418
 $\frac{13}{16} \times 4$

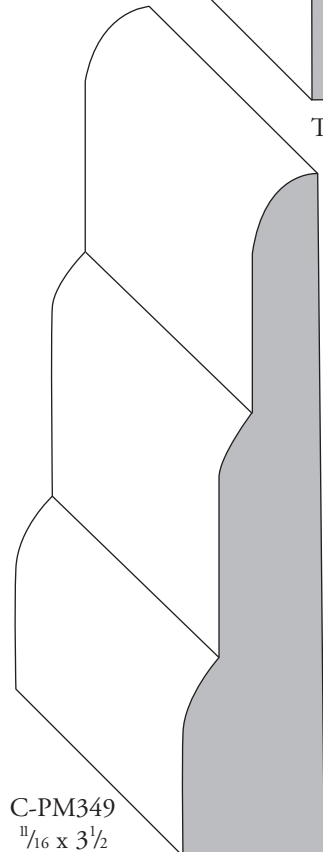

C-PM349
 $\frac{11}{16} \times 3\frac{1}{2}$

BASE

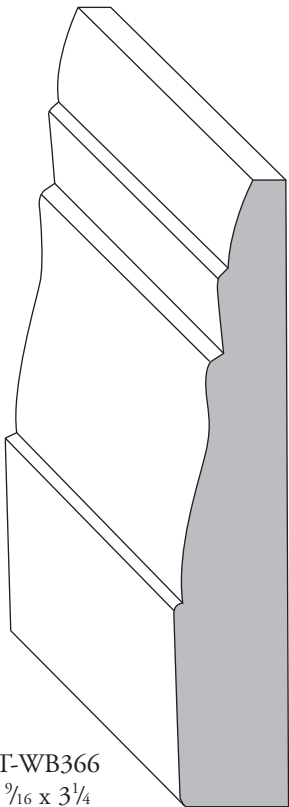
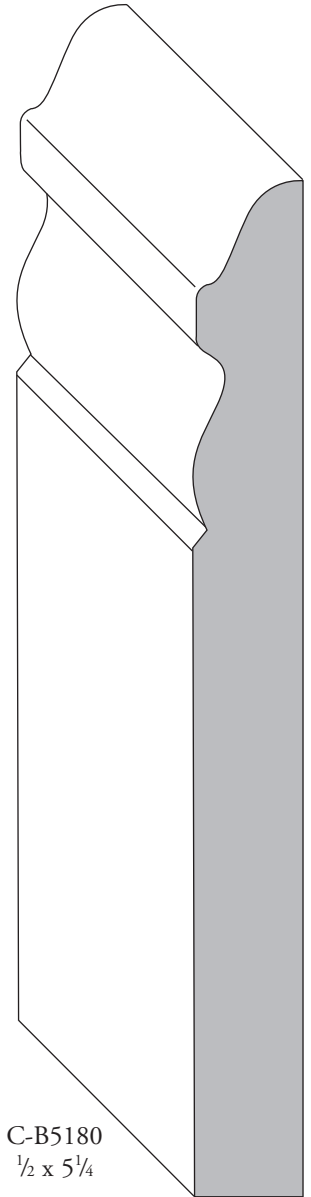
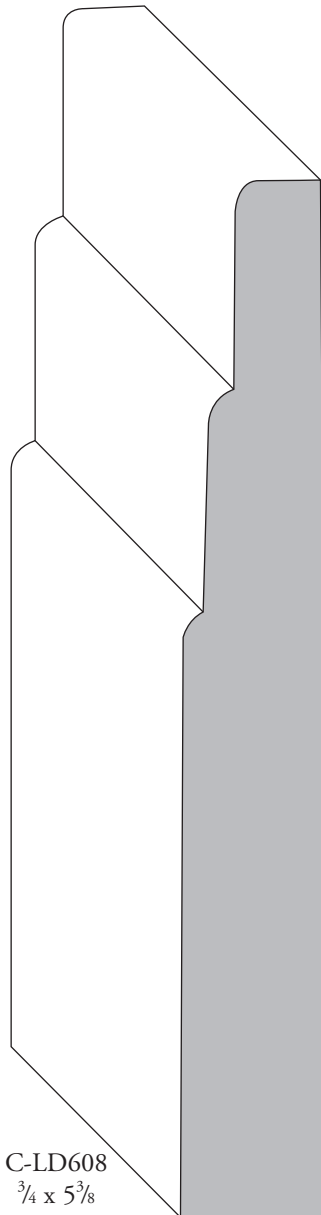
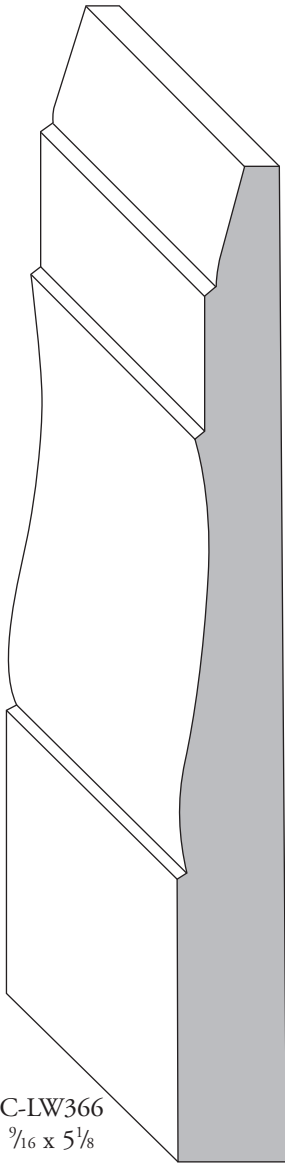
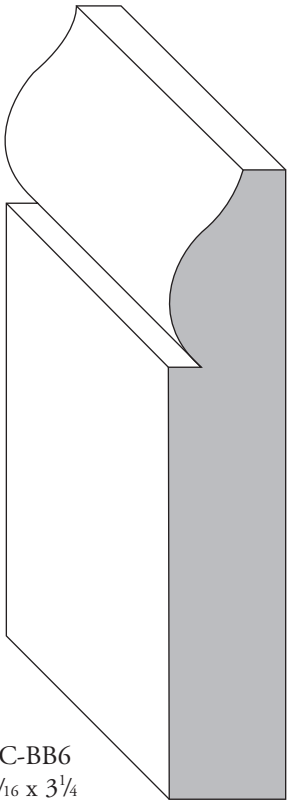

BASE

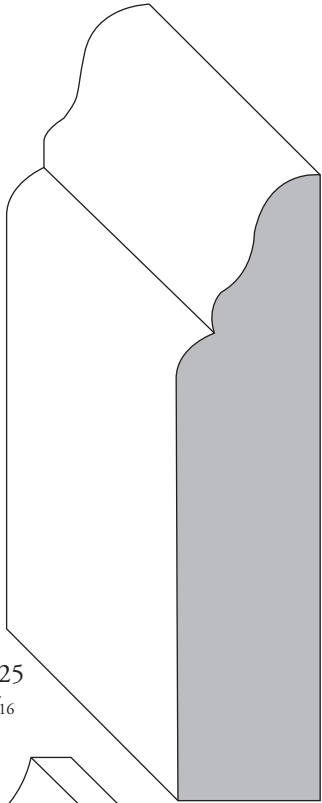

C-FM325
 $\frac{3}{4} \times 3\frac{3}{16}$

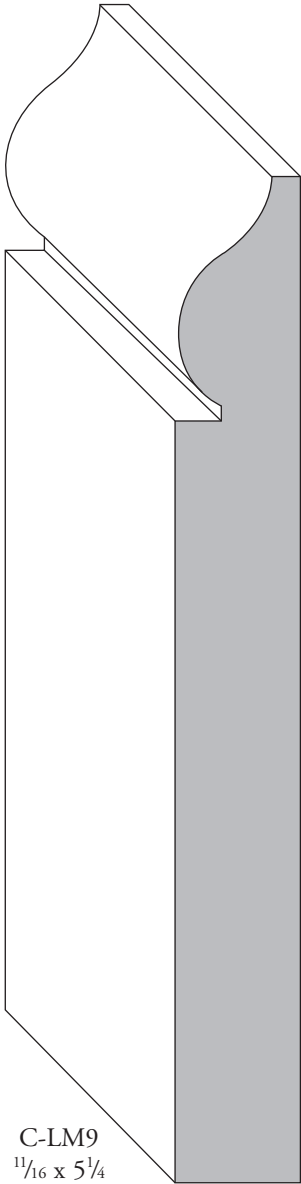

C-LM9
 $\frac{1}{16} \times 5\frac{1}{4}$

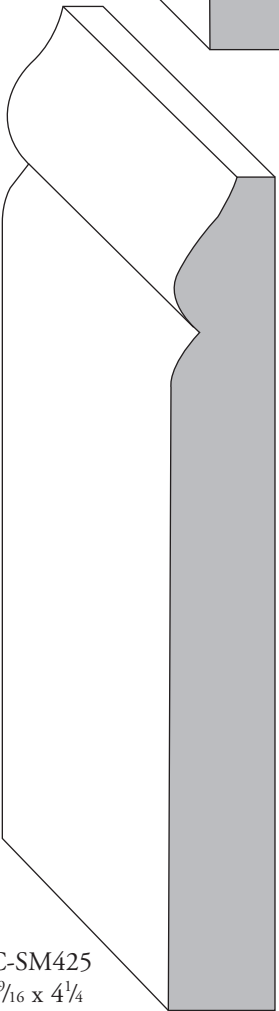

C-SM425
 $\frac{9}{16} \times 4\frac{1}{4}$

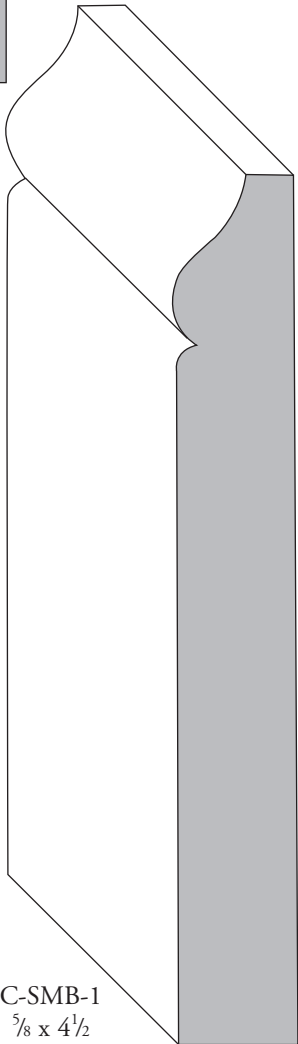

C-SMB-1
 $\frac{5}{8} \times 4\frac{1}{2}$

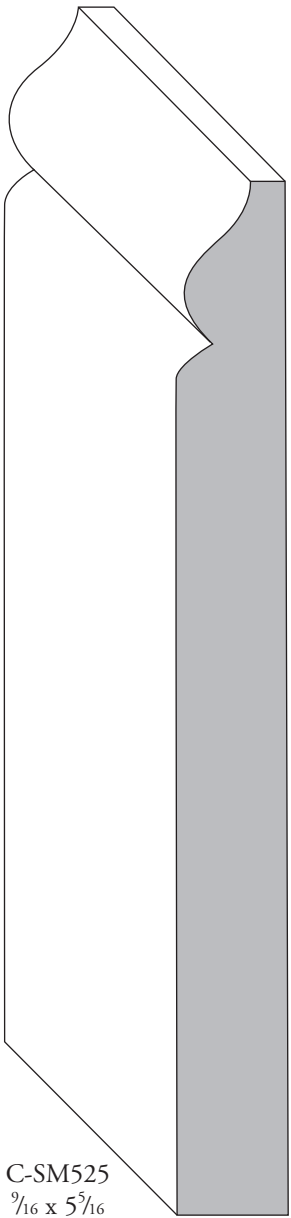

C-SM525
 $\frac{9}{16} \times 5\frac{5}{16}$

BASE

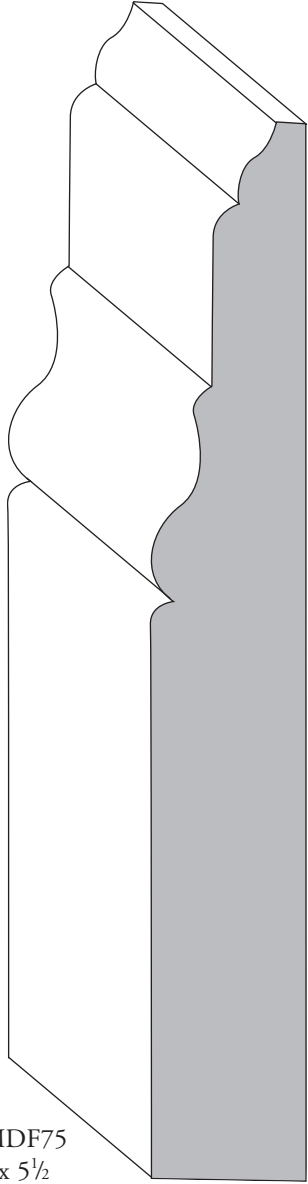
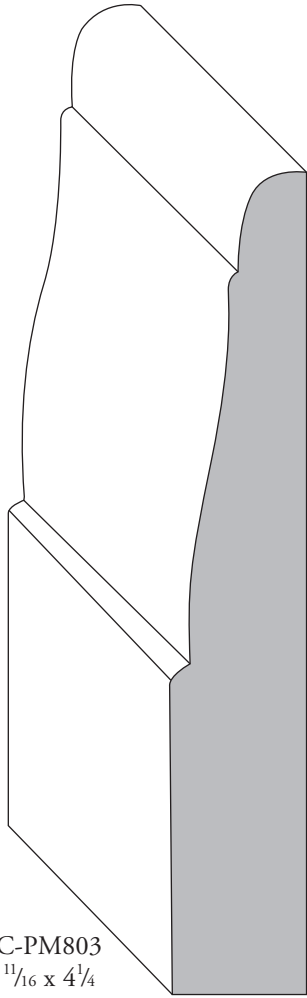
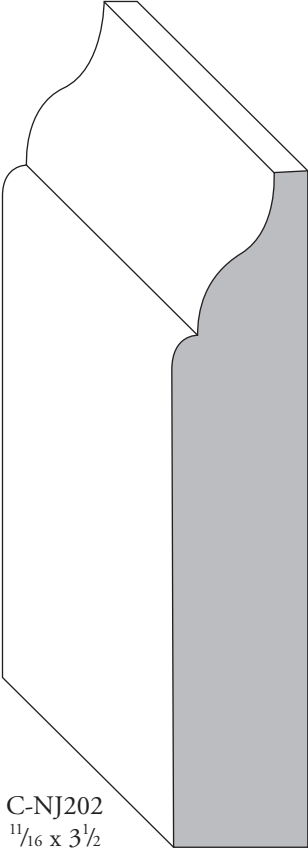
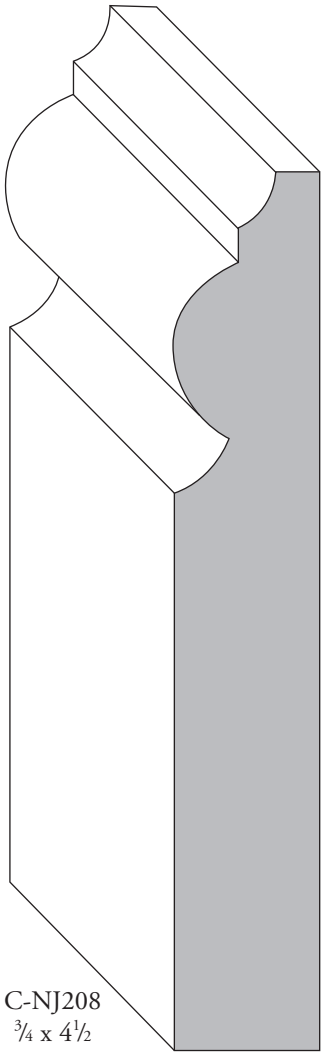

BASE

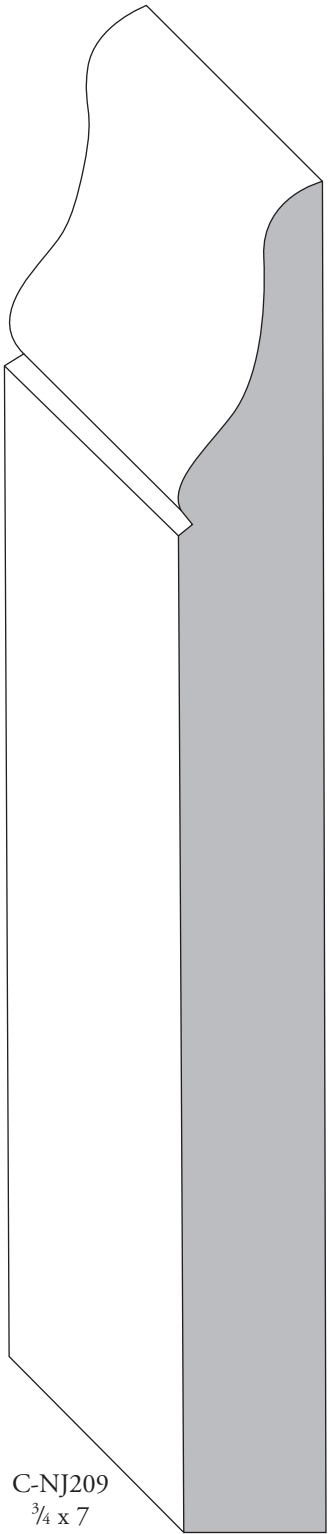

C-NJ209
 $\frac{3}{4} \times 7$

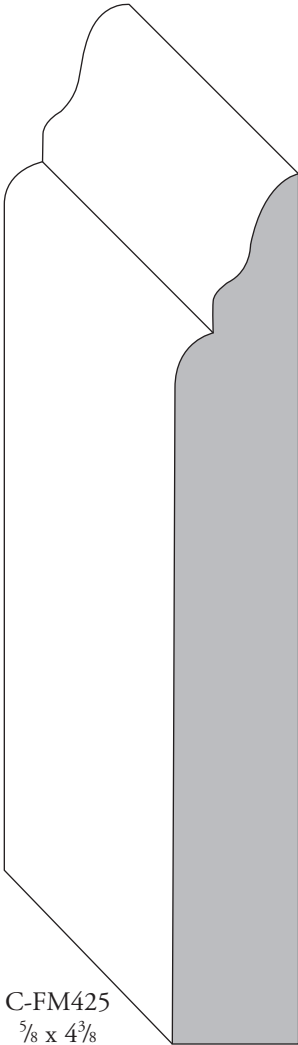

C-FM425
 $\frac{5}{8} \times 4\frac{3}{8}$

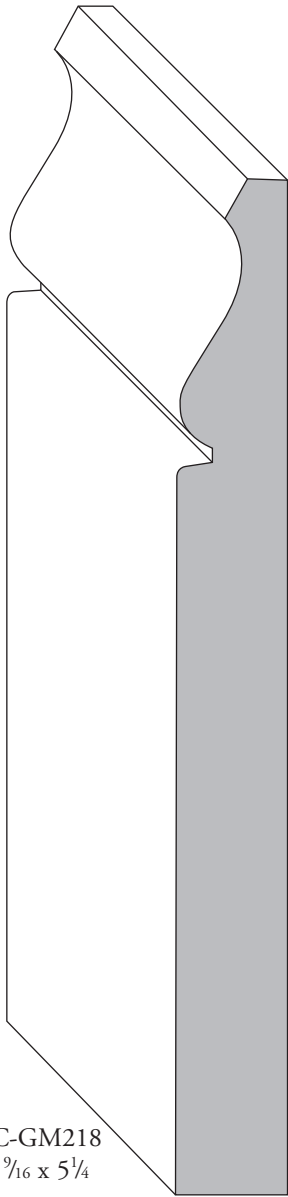

C-GM218
 $\frac{9}{16} \times 5\frac{1}{4}$

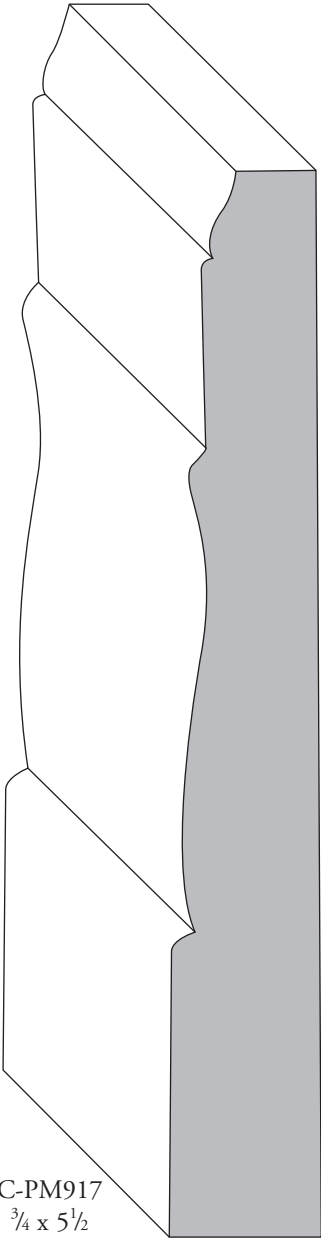

C-PM917
 $\frac{3}{4} \times 5\frac{1}{2}$

BASE

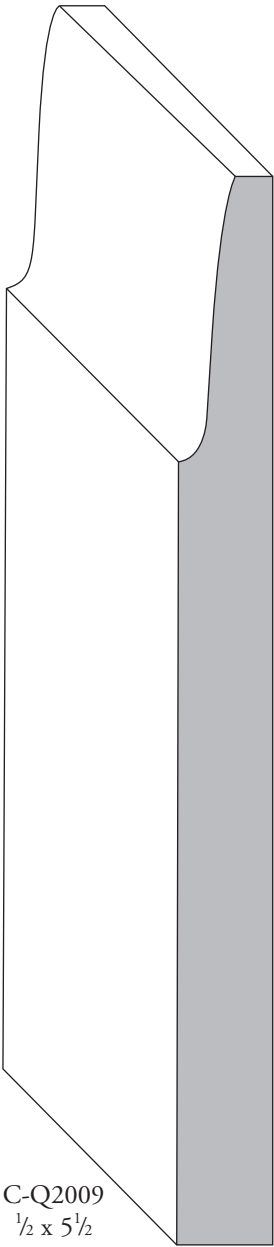
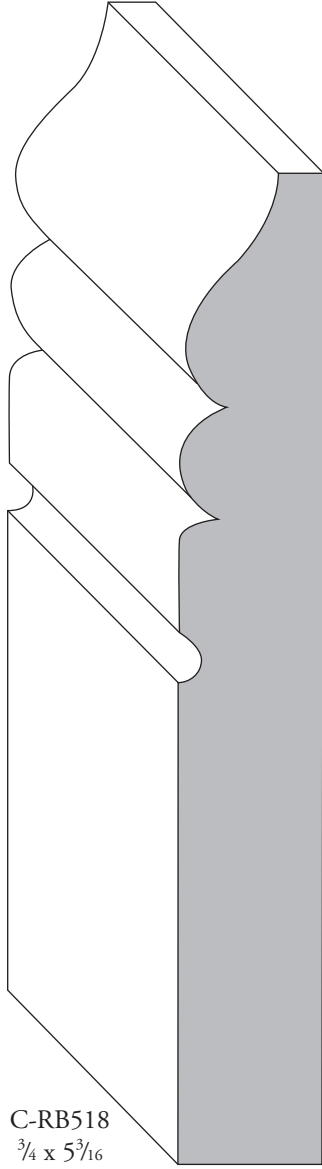
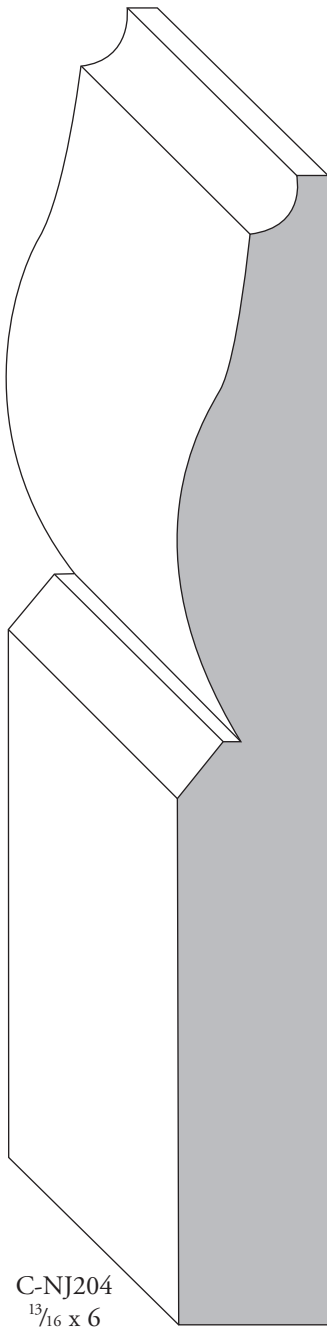
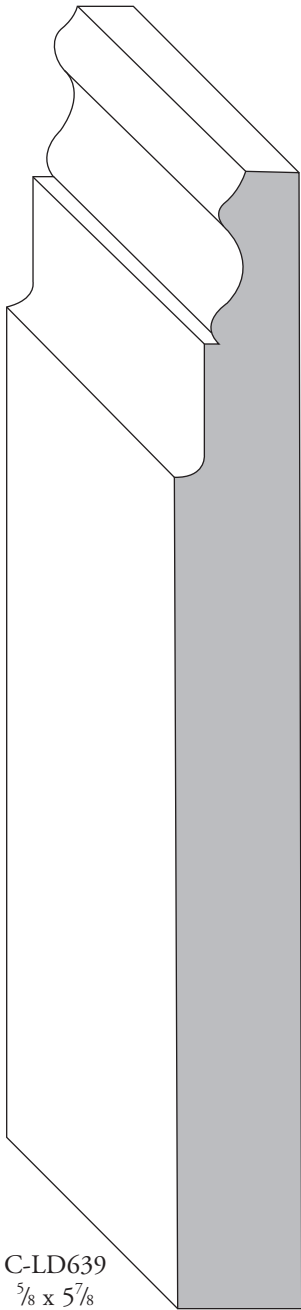

BASE

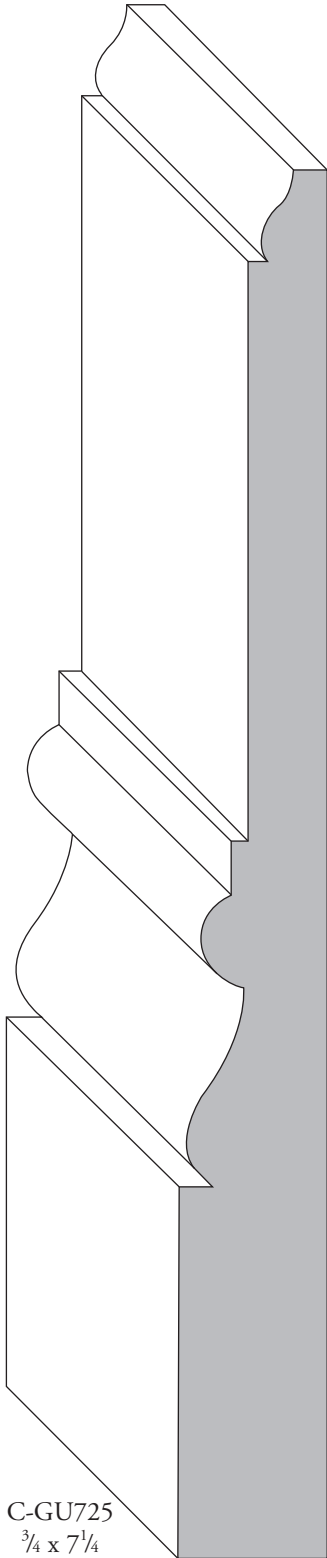

C-GU725
 $\frac{3}{4} \times 7\frac{1}{4}$

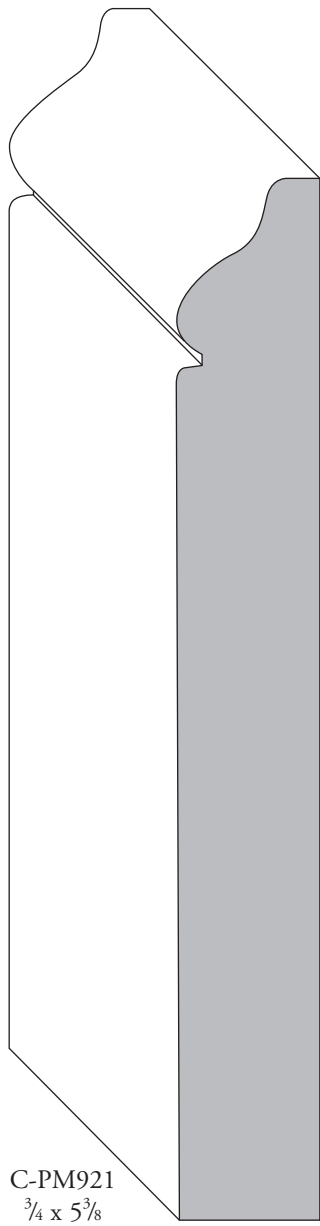

C-PM921
 $\frac{3}{4} \times 5\frac{3}{8}$

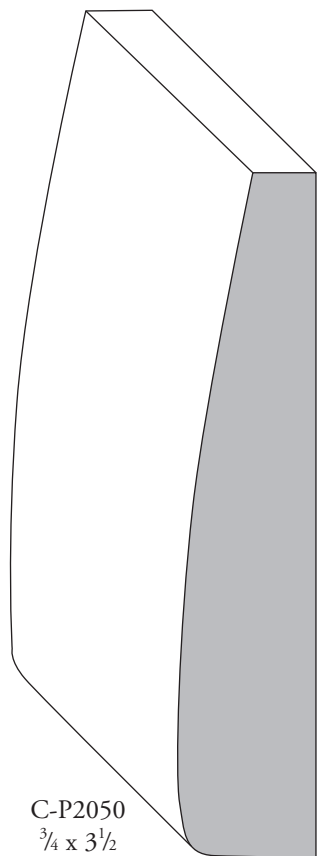

C-P2050
 $\frac{3}{4} \times 3\frac{1}{2}$

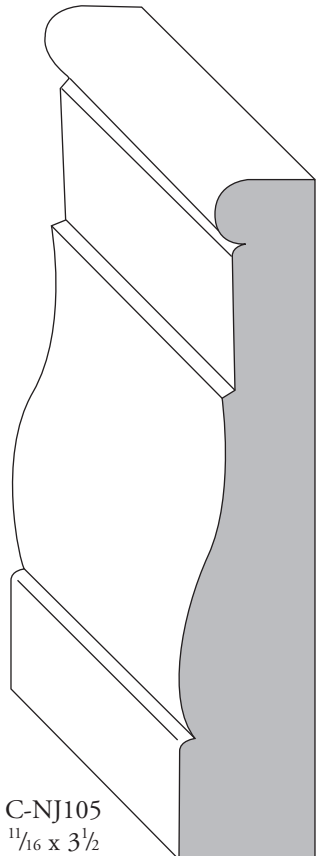

C-NJ105
 $\frac{1}{16} \times 3\frac{1}{2}$

BASE

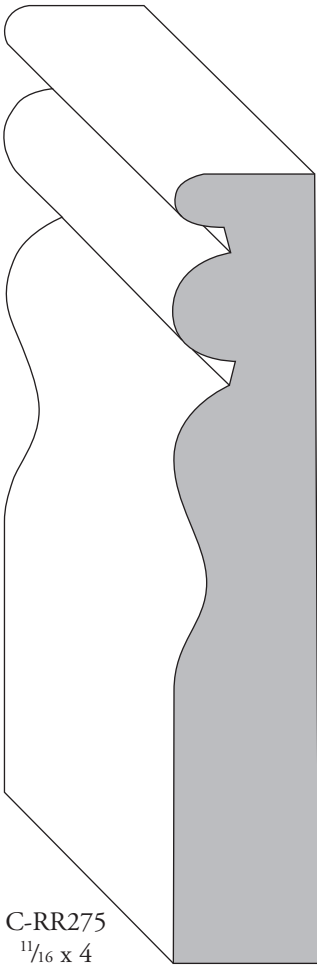

C-RR275
 $1\frac{1}{16} \times 4$

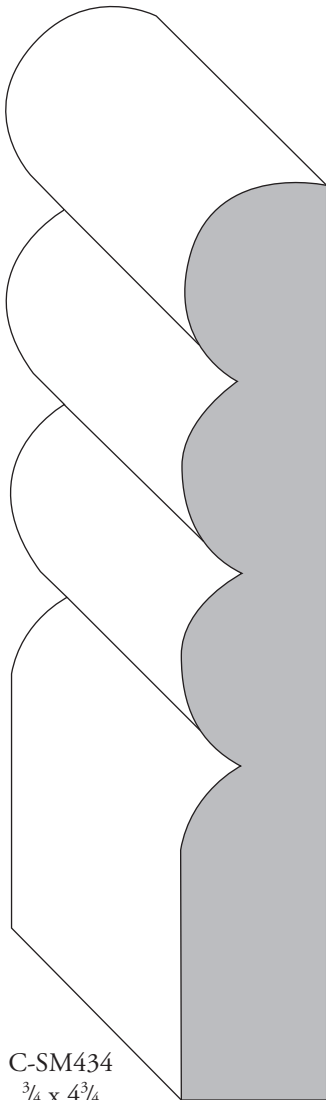

C-SM434
 $\frac{3}{4} \times 4\frac{3}{4}$

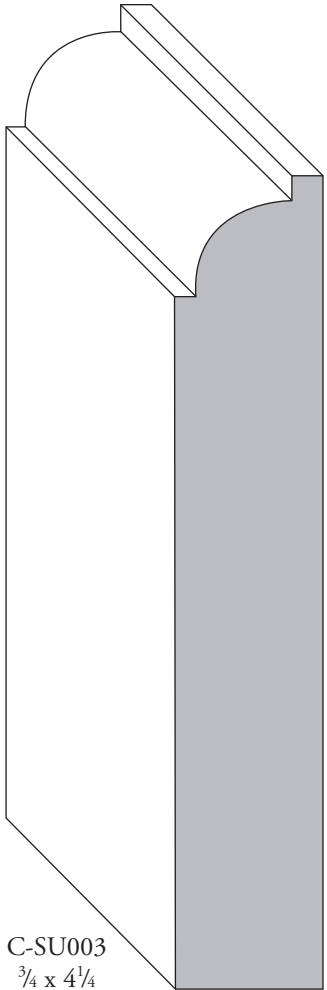

C-SU003
 $\frac{3}{4} \times 4\frac{1}{4}$



BASE

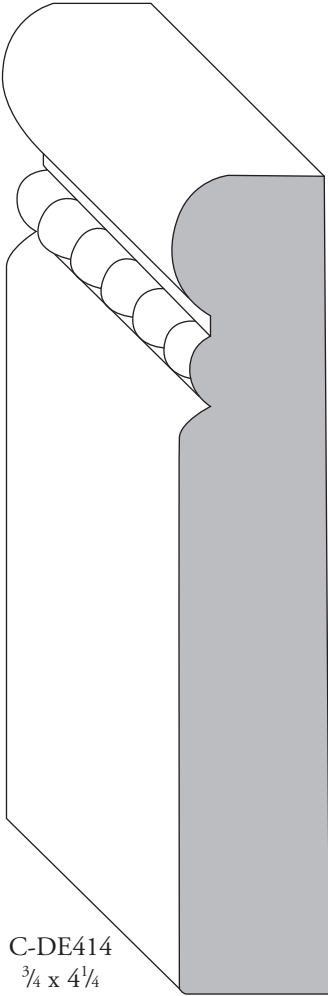

C-DE414
 $\frac{3}{4} \times 4\frac{1}{4}$

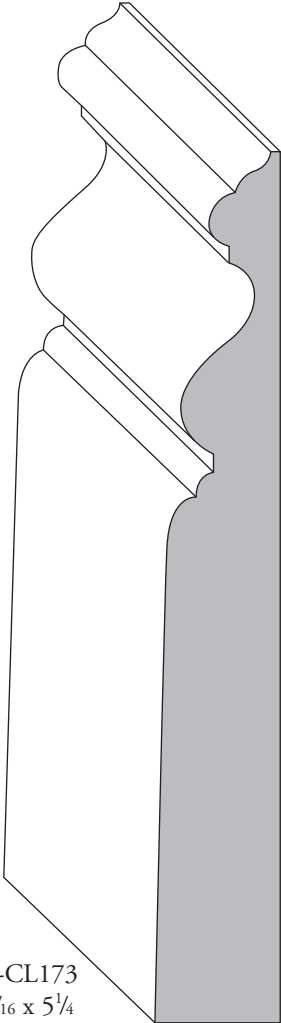

C-CL173
 $\frac{11}{16} \times 5\frac{1}{4}$

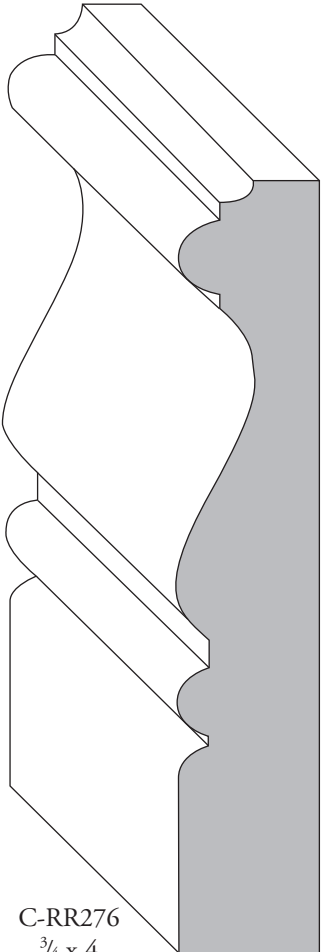

C-RR276
 $\frac{3}{4} \times 4$

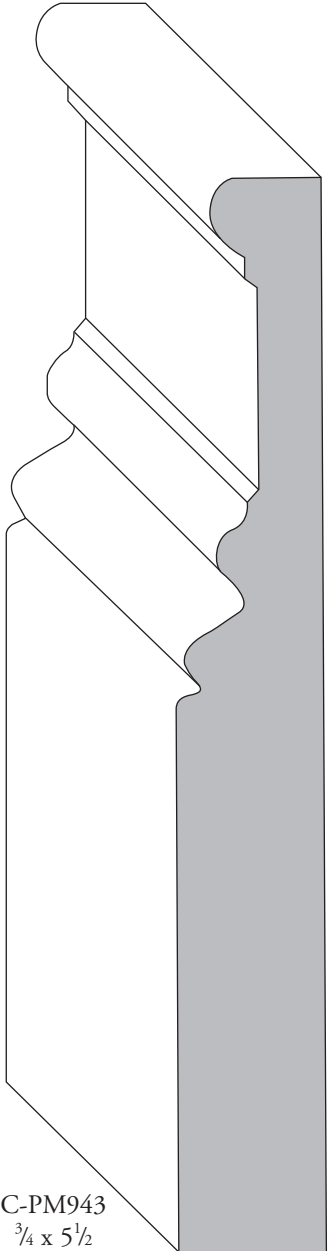

C-PM943
 $\frac{3}{4} \times 5\frac{1}{2}$

BASE

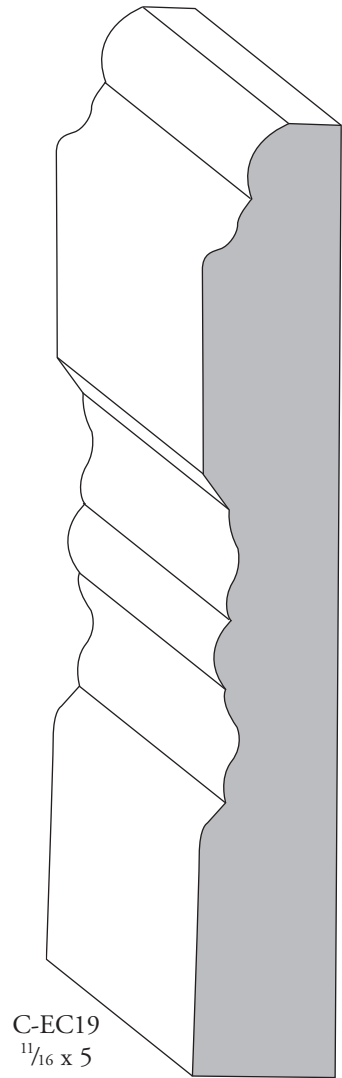
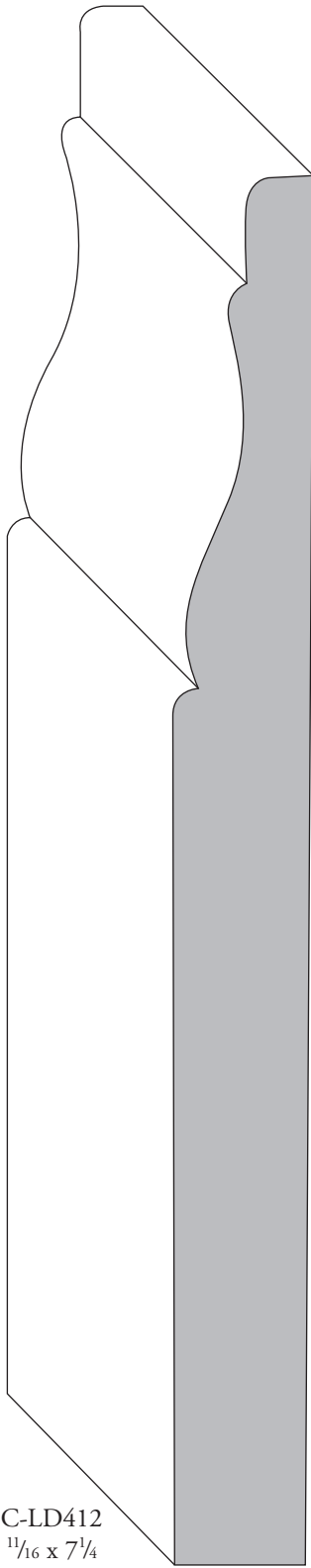
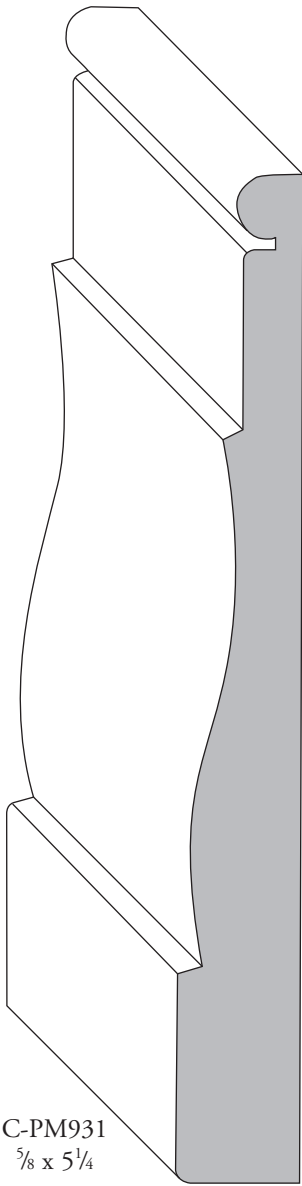

BASE

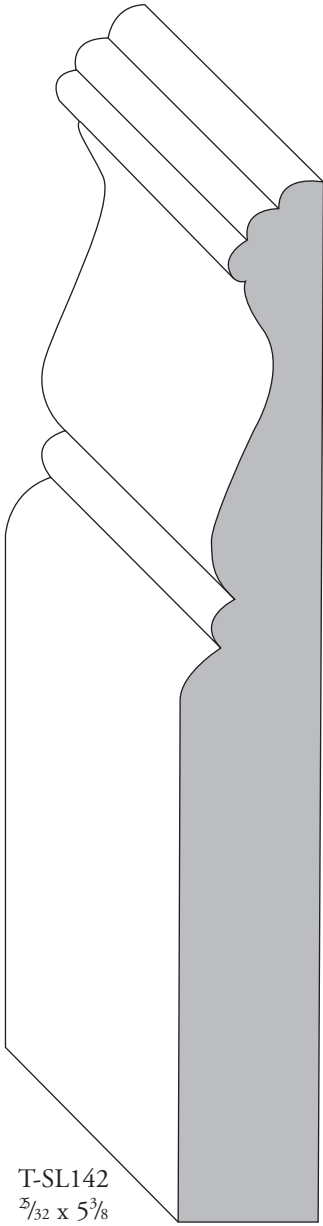

T-SL142
 $\frac{5}{32} \times 5\frac{3}{8}$

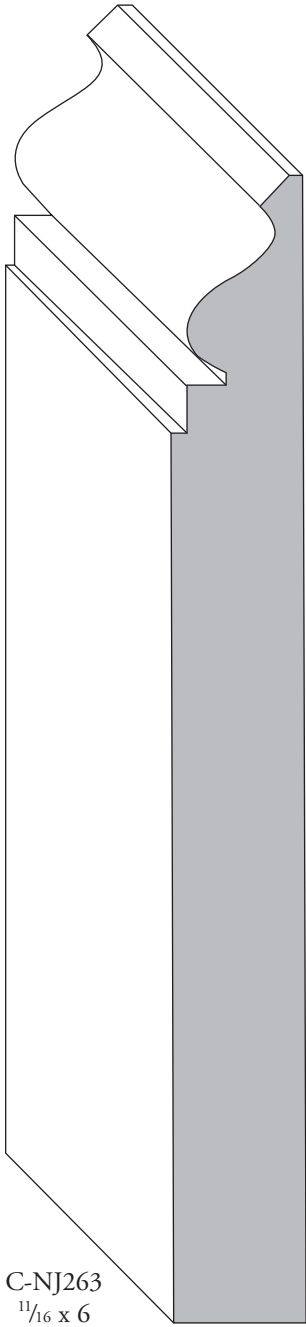

C-NJ263
 $\frac{11}{16} \times 6$

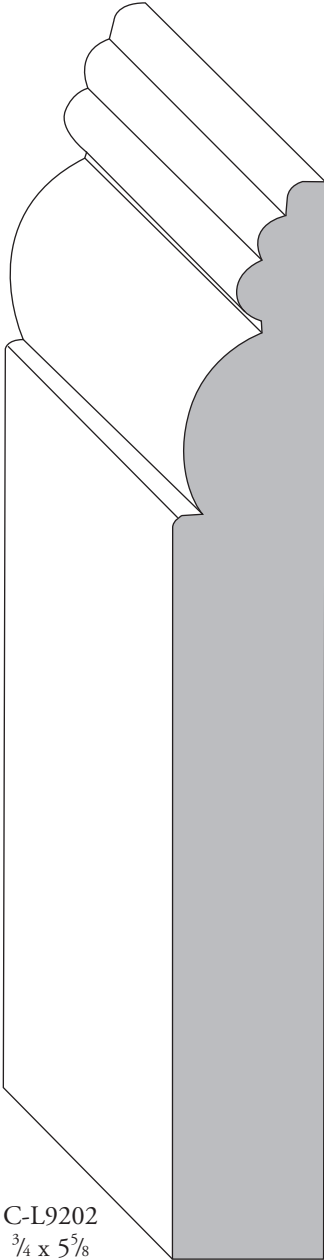

C-L9202
 $\frac{3}{4} \times 5\frac{5}{8}$

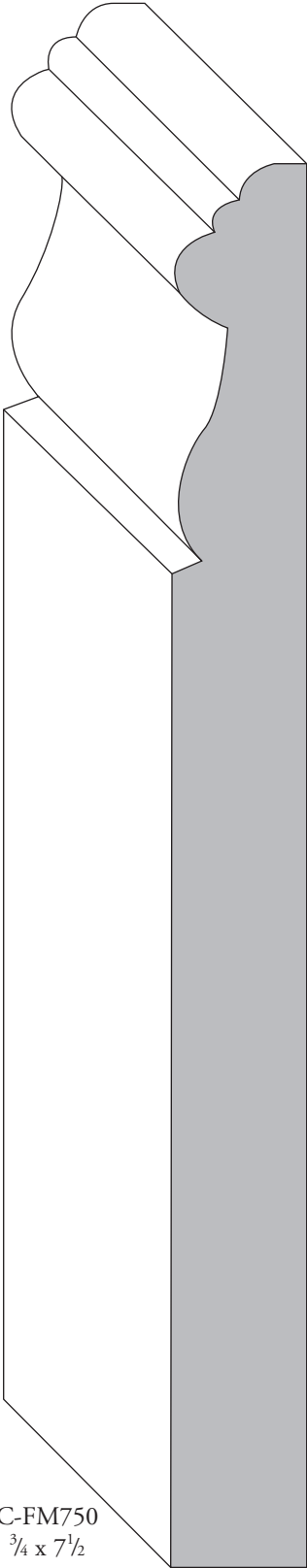

C-FM750
 $\frac{3}{4} \times 7\frac{1}{2}$

BASE

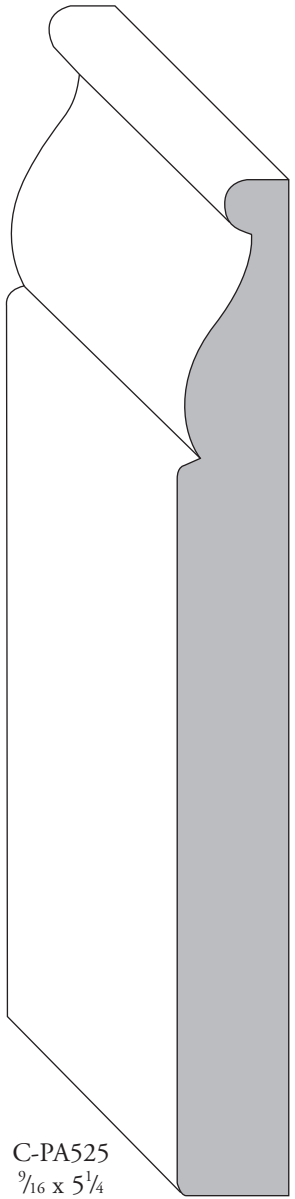
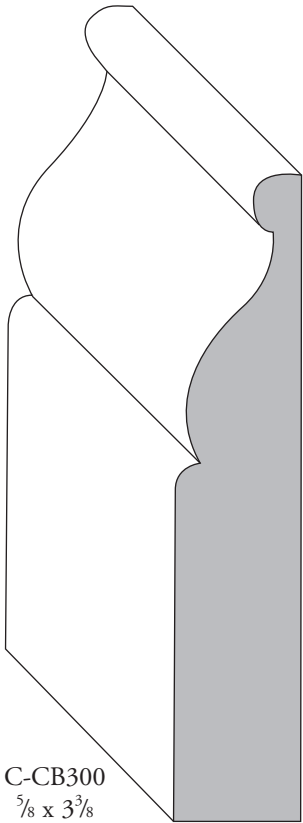
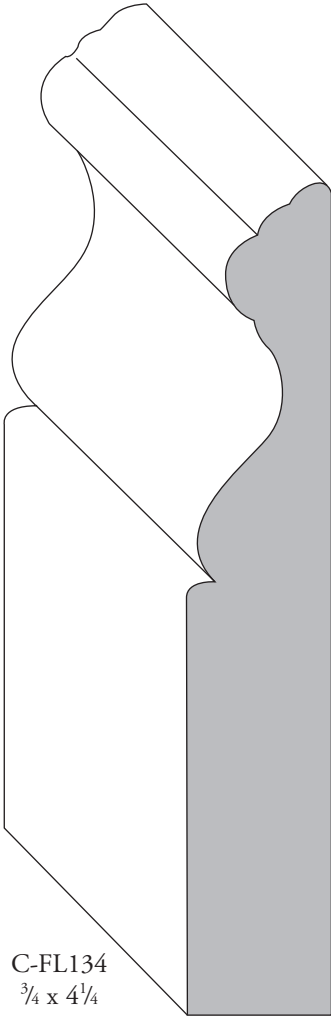
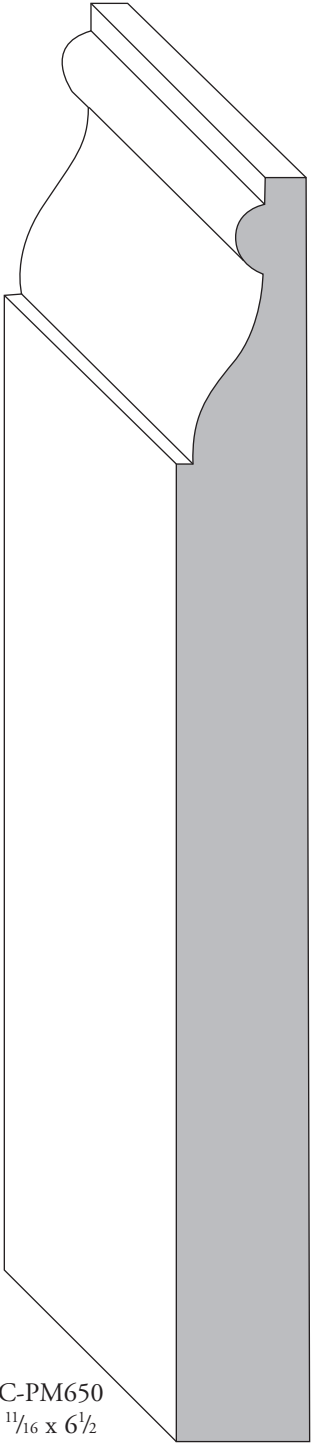

BASE

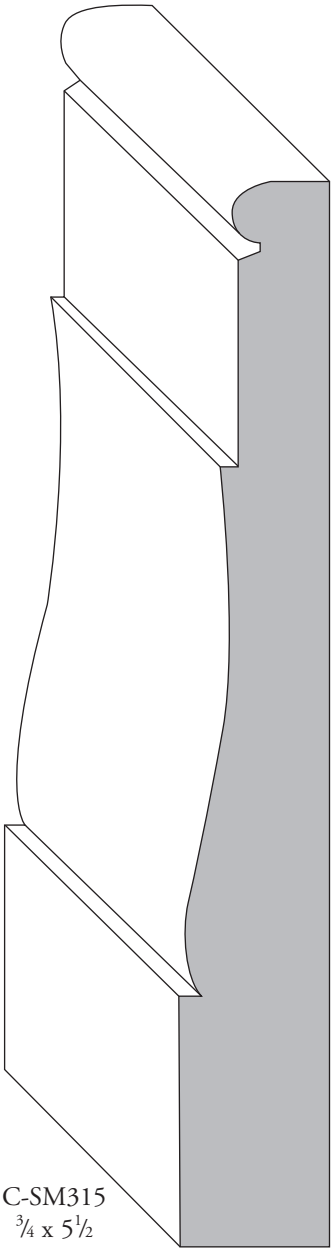
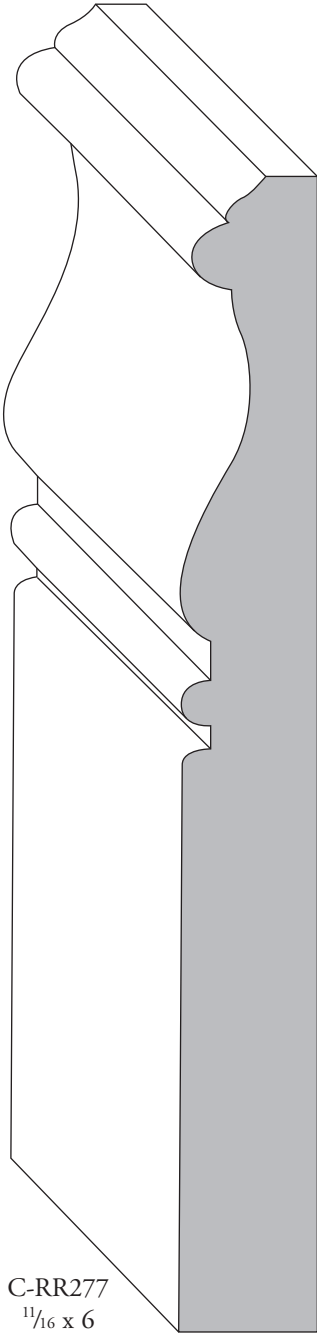
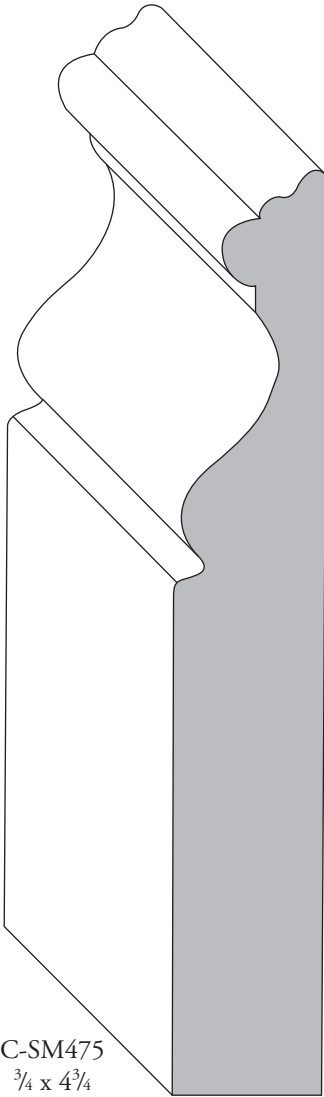

BASE

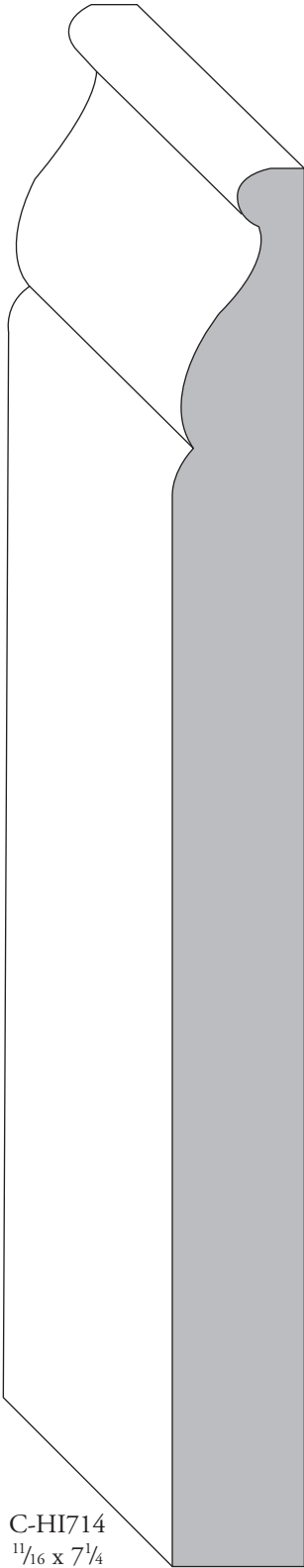

C-HI714
 $1\frac{1}{16} \times 7\frac{1}{4}$

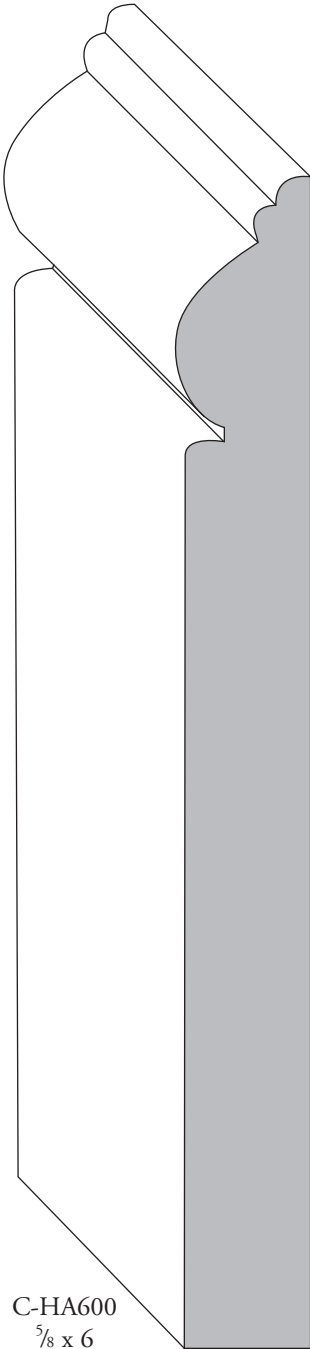

C-HA600
 $\frac{5}{8} \times 6$

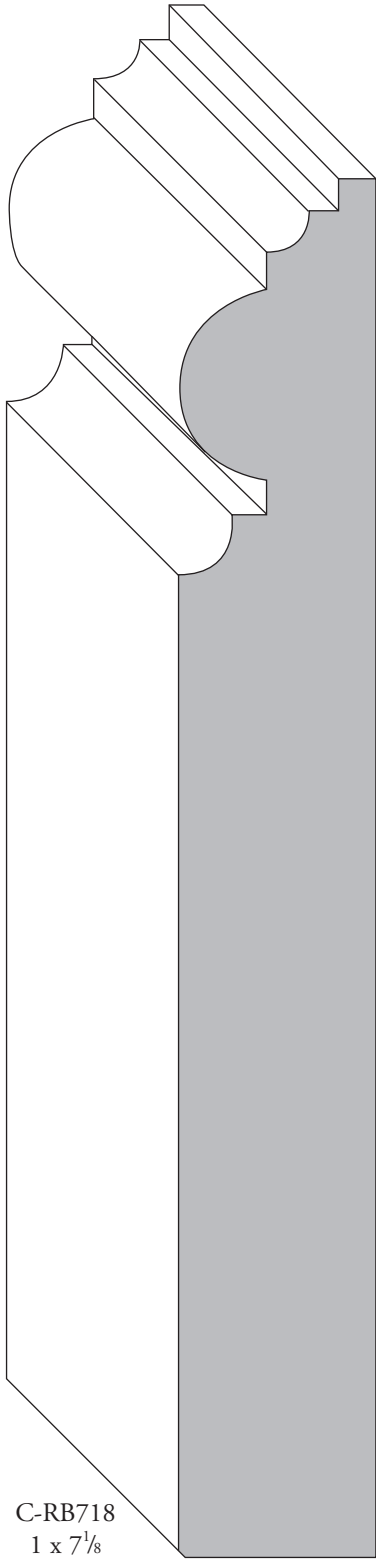

C-RB718
 $1 \times 7\frac{1}{8}$

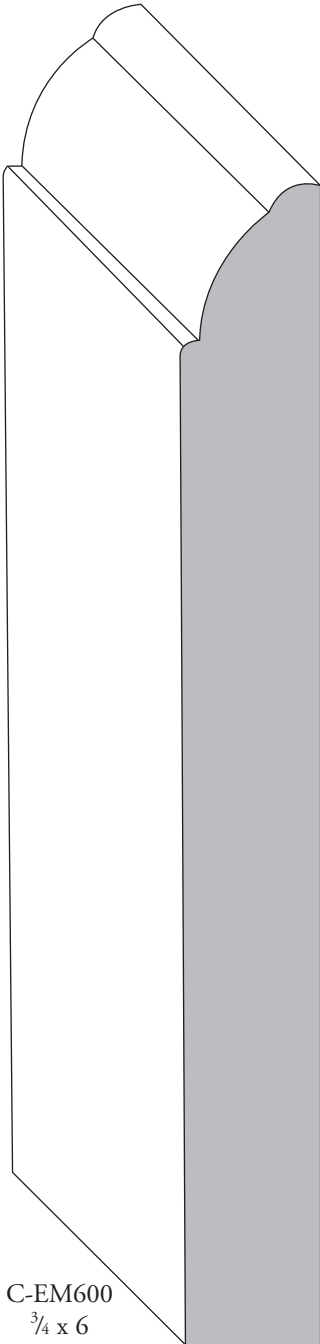

C-EM600
 $\frac{3}{4} \times 6$

BASE

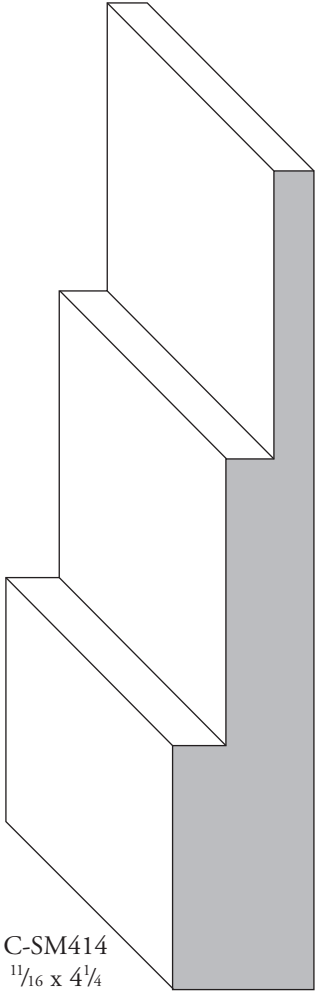

C-SM414
 $1\frac{1}{16} \times 4\frac{1}{4}$

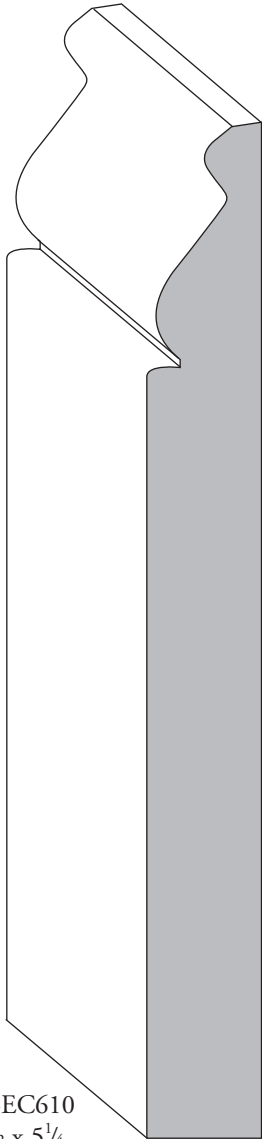

C-EC610
 $\frac{1}{2} \times 5\frac{1}{4}$

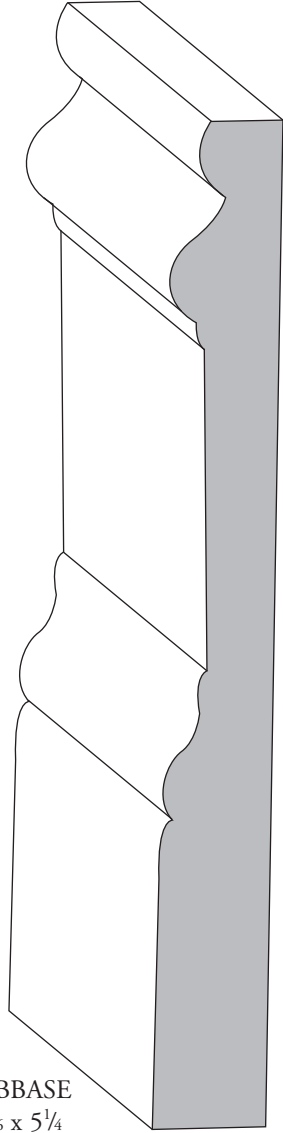

C-BBASE
 $\frac{9}{16} \times 5\frac{1}{4}$

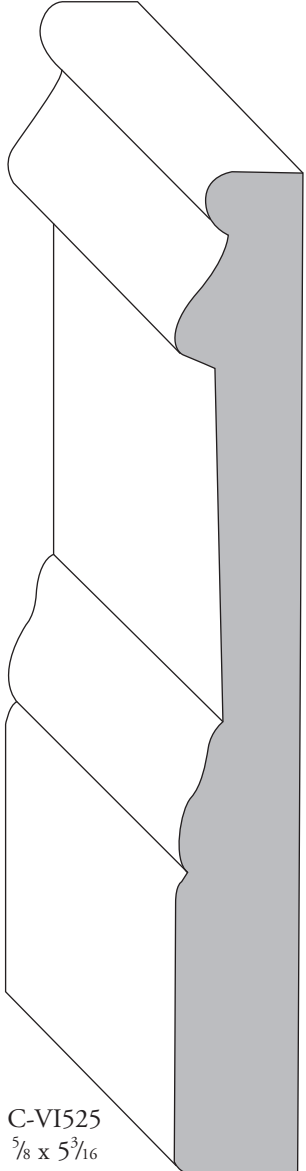

C-VI525
 $\frac{5}{8} \times 5\frac{3}{16}$

BASE

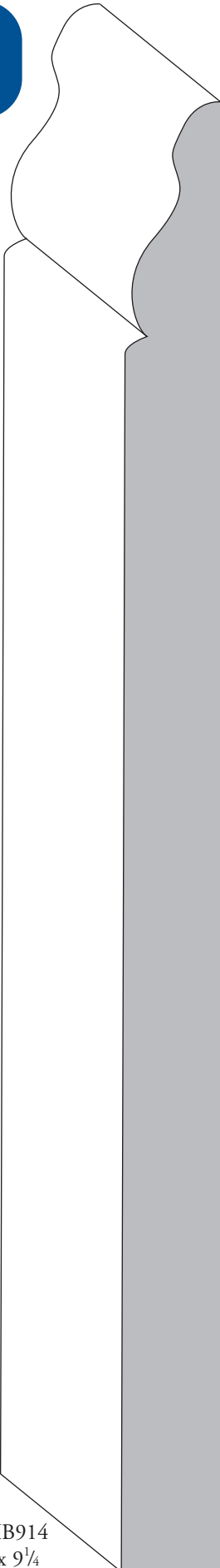
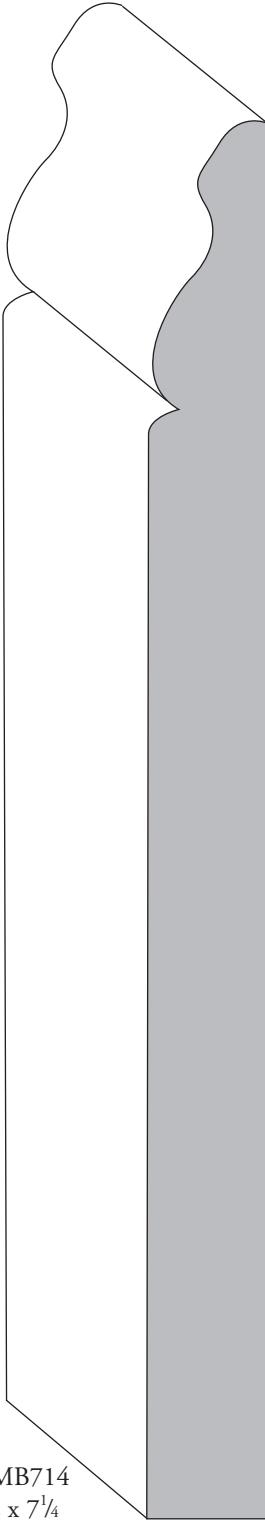
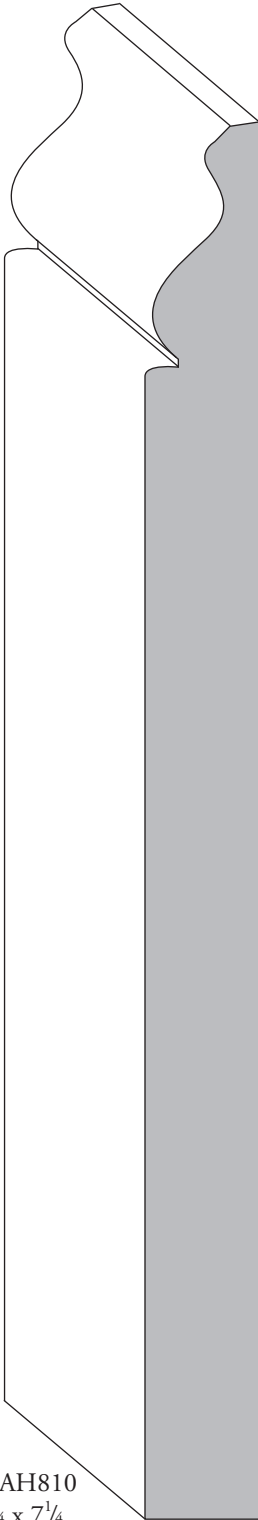

BASE CAP/BASE SHOE

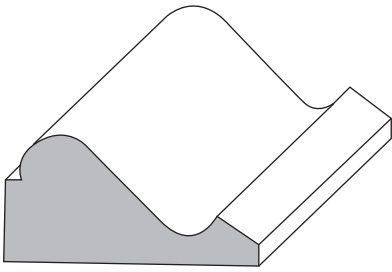

T-WM163
 $\frac{11}{16} \times 1\frac{3}{8}$

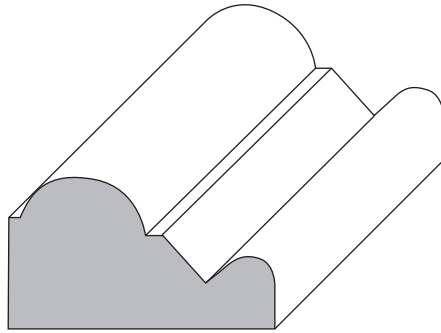

C-SM30
 $\frac{3}{4} \times 1\frac{3}{8}$

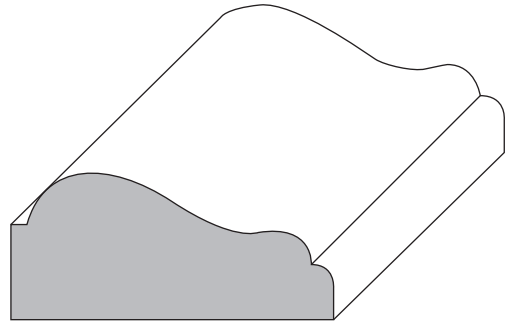

T-SL435
 $\frac{3}{4} \times 1\frac{5}{8}$

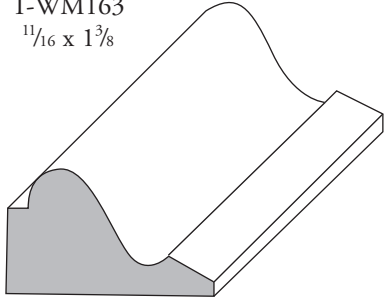

T-WM164
 $\frac{11}{16} \times 1\frac{1}{8}$

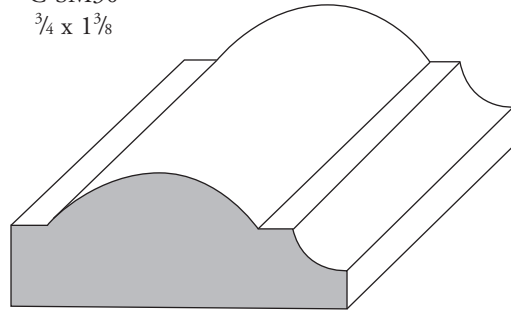

C-R42
 $\frac{11}{16} \times 1\frac{3}{4}$

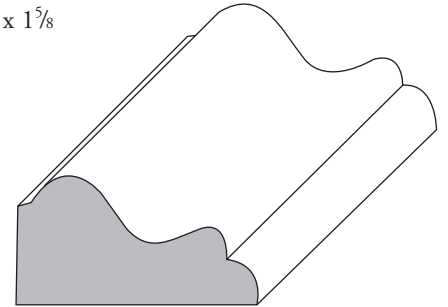

T-SL436
 $\frac{5}{8} \times 1\frac{1}{4}$

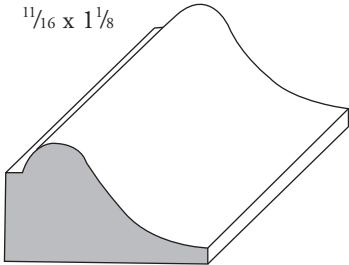

T-WM167
 $\frac{11}{16} \times 1\frac{1}{8}$

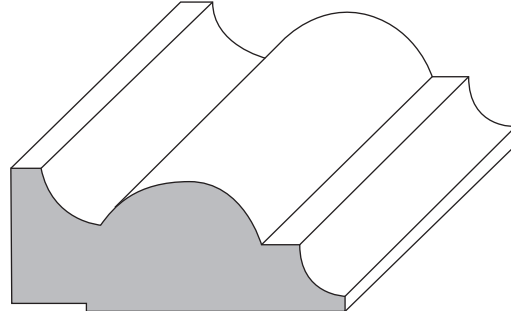

C-DSCAP
 $\frac{3}{4} \times 1\frac{3}{4}$

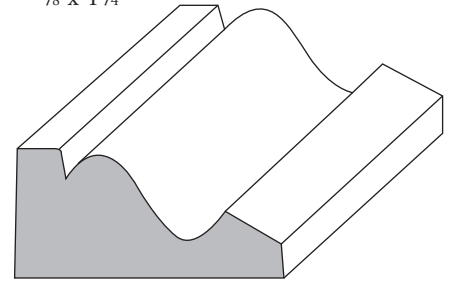

C-GB218
 $\frac{3}{4} \times 1\frac{1}{2}$

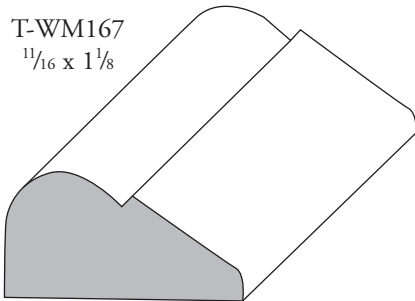

C-BO125
 $\frac{5}{8} \times 1\frac{1}{4}$

C-DSCAP
 $\frac{3}{4} \times 1\frac{3}{4}$

C-GB218
 $\frac{3}{4} \times 1\frac{1}{2}$

BASE SHOE

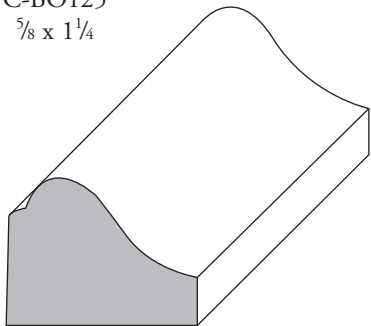

T-SL408
 $\frac{3}{4} \times 1$

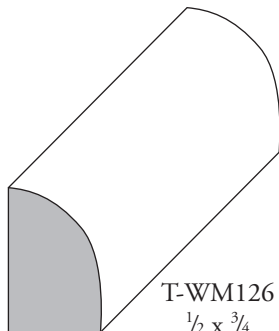

T-WM126
 $\frac{1}{2} \times \frac{3}{4}$

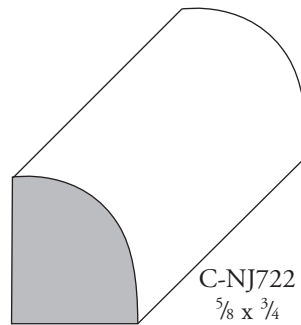

C-NJ722
 $\frac{5}{8} \times \frac{3}{4}$

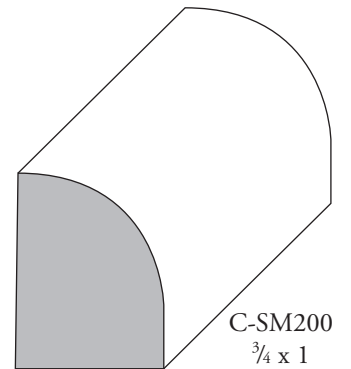

C-SM200
 $\frac{3}{4} \times 1$

CROWN

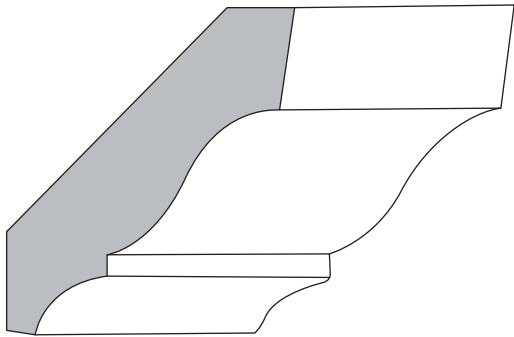

T-WM054
 $\frac{1}{16} \times 2\frac{1}{4}$

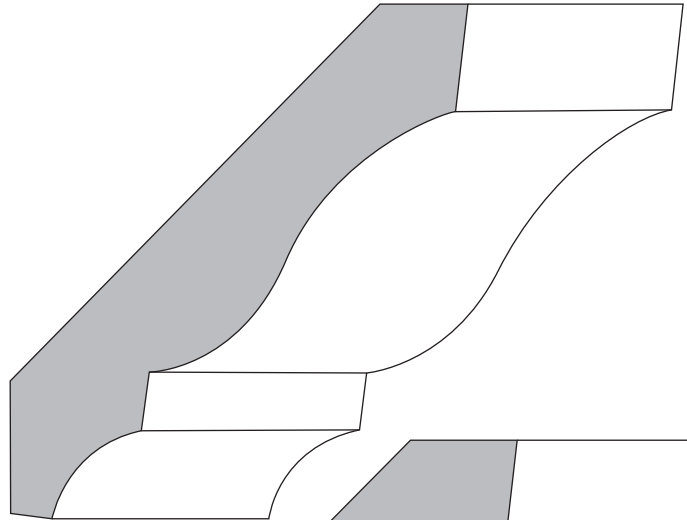

T-WM049
 $\frac{1}{16} \times 3\frac{5}{8}$

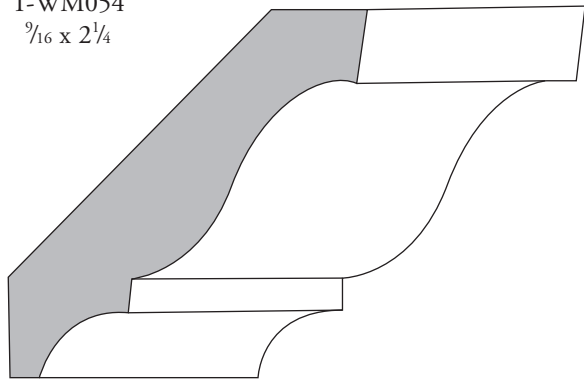

T-WM053
 $\frac{1}{16} \times 2\frac{5}{8}$

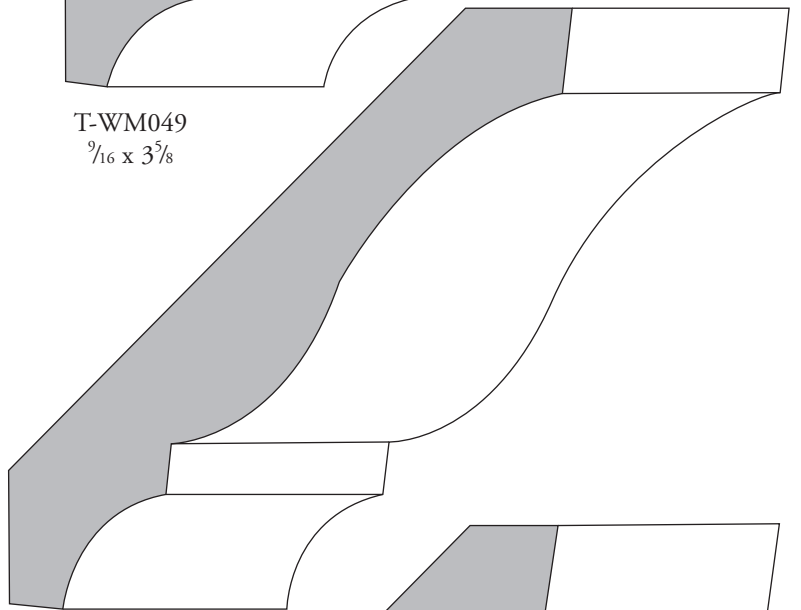

T-WM048
 $\frac{1}{16} \times 4\frac{1}{4}$

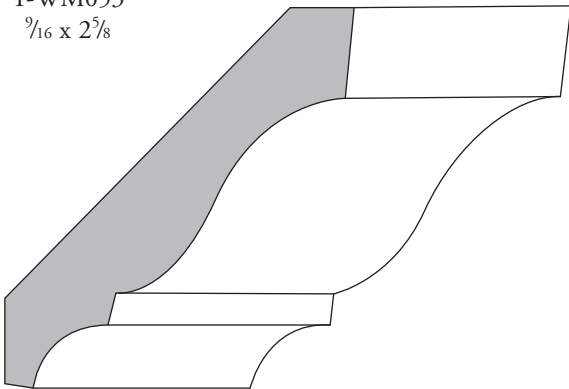

T-WM052
 $\frac{1}{16} \times 2\frac{3}{4}$

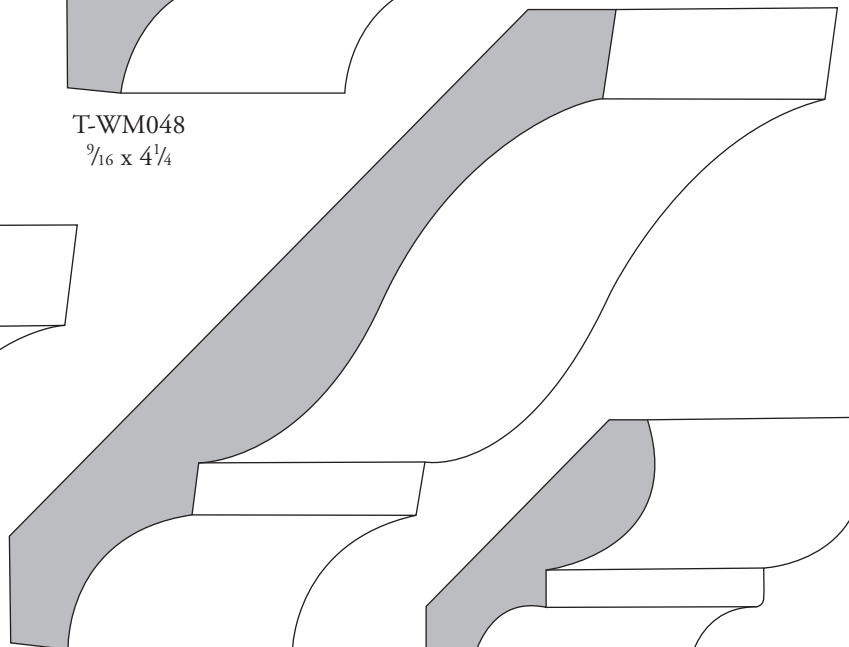

T-WM047
 $\frac{1}{16} \times 4\frac{5}{8}$

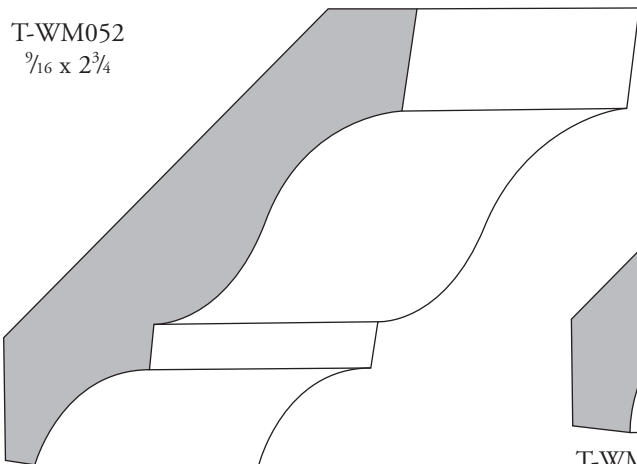

T-WM051
 $\frac{1}{16} \times 3\frac{1}{4}$

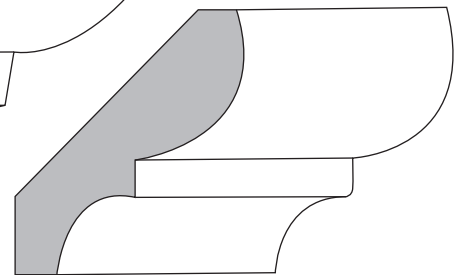

T-WM074
 $\frac{1}{16} \times 1\frac{3}{4}$

CROWN

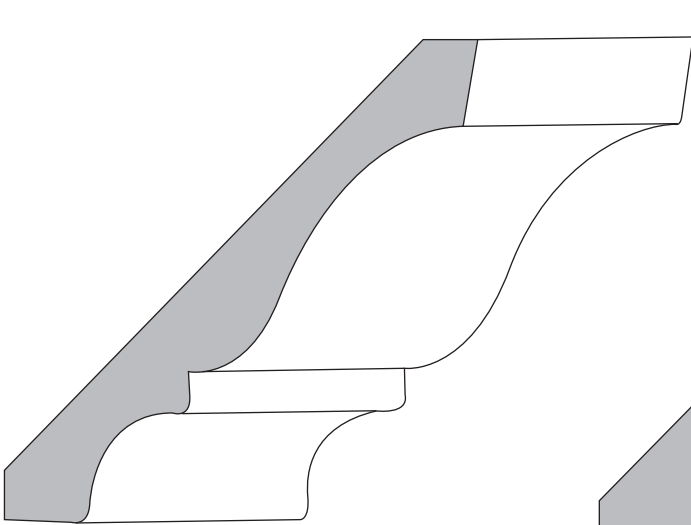

T-SL287
 $\frac{1}{2} \times 3\frac{1}{2}$

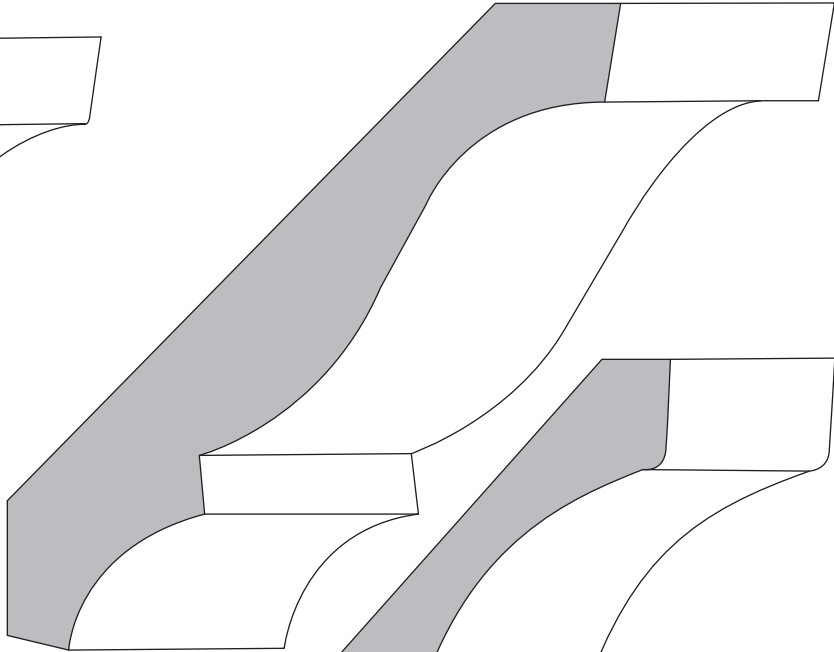

T-SL288
 $\frac{3}{4} \times 4\frac{1}{2}$

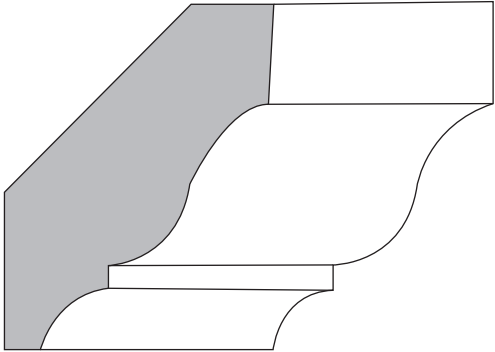

C-PO540
 $\frac{3}{4} \times 2\frac{1}{4}$

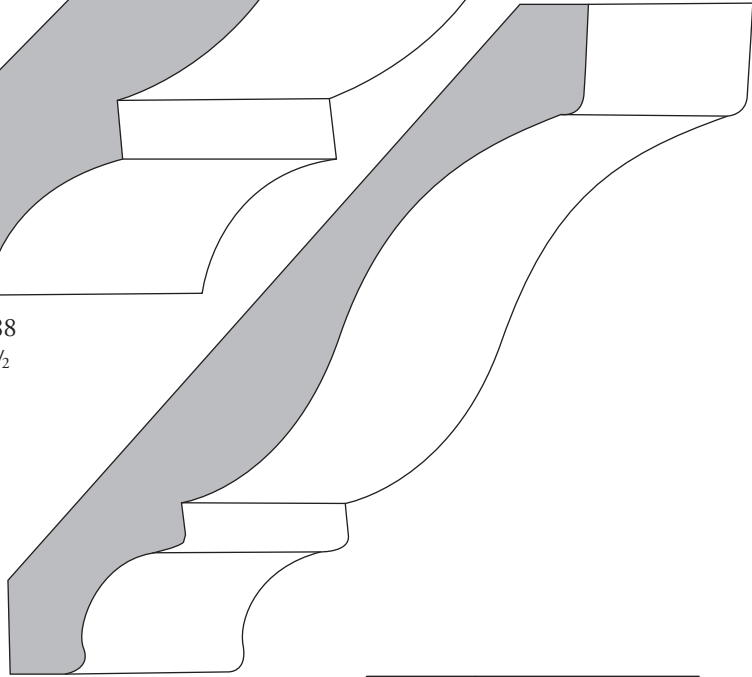

T-RB17
 $\frac{5}{8} \times 5\frac{5}{8}$

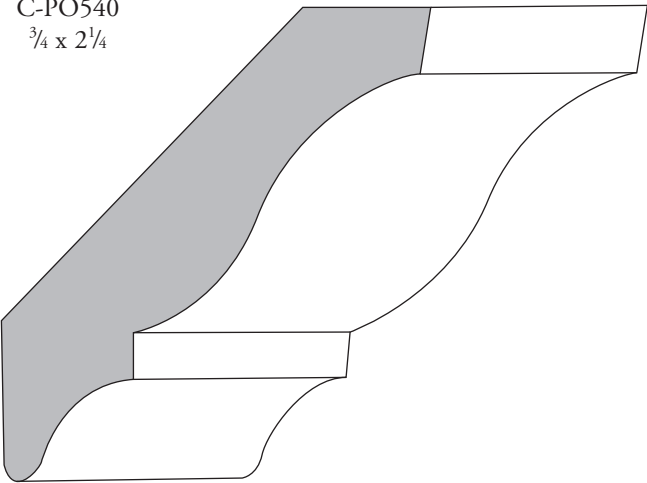

C-NJ319
 $1\frac{1}{16} \times 3\frac{1}{4}$

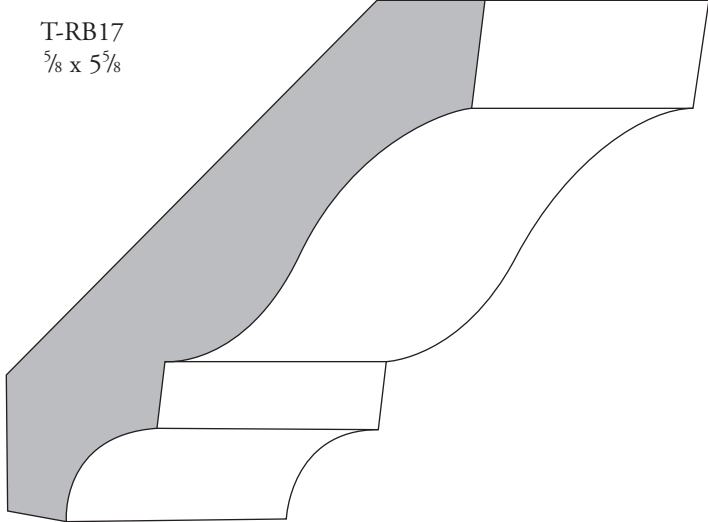

C-PO525
 $\frac{3}{4} \times 3\frac{5}{8}$

CROWN

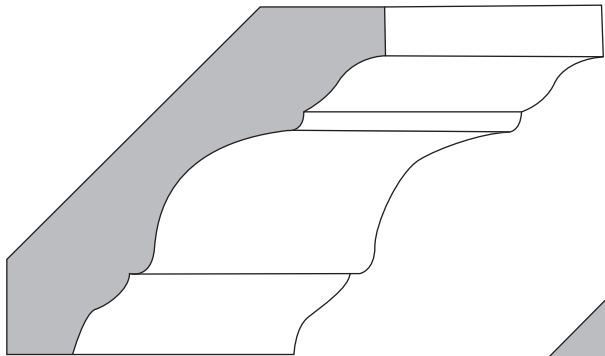

C-OC215
 $\frac{5}{8} \times 2\frac{5}{8}$

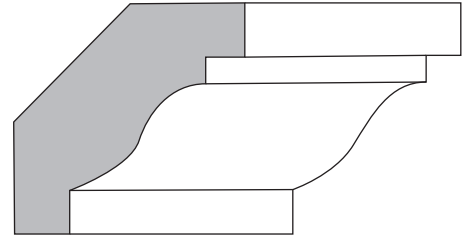

C-OC230
 $\frac{5}{8} \times 1\frac{5}{8}$

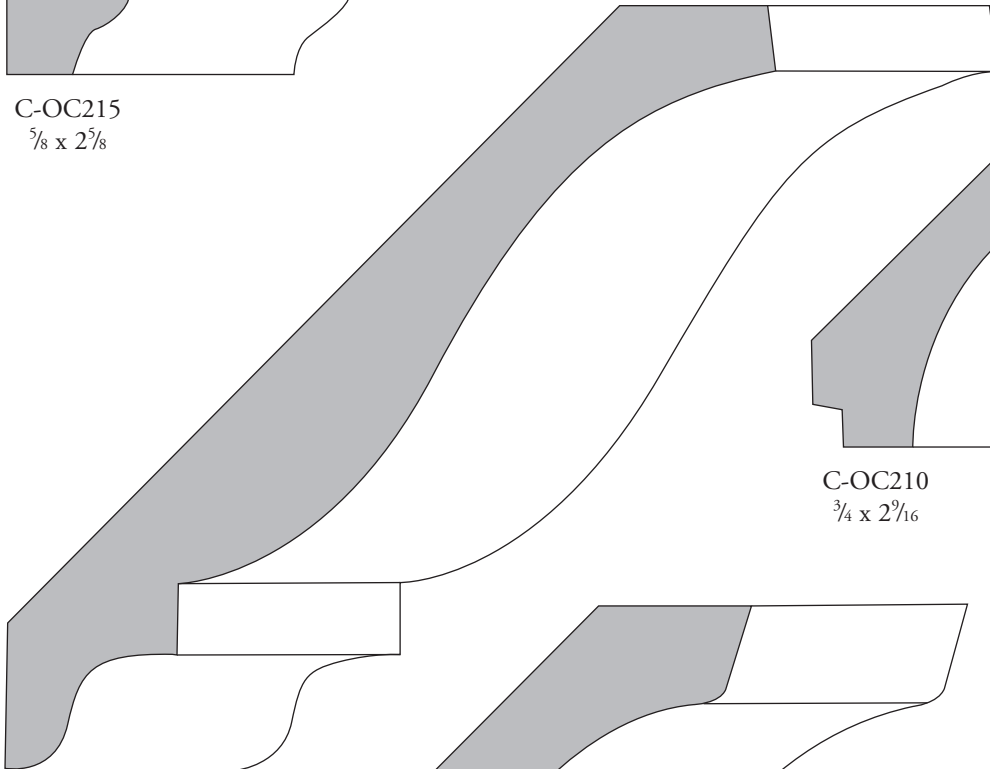

C-WW525
 $\frac{3}{4} \times 5\frac{3}{8}$

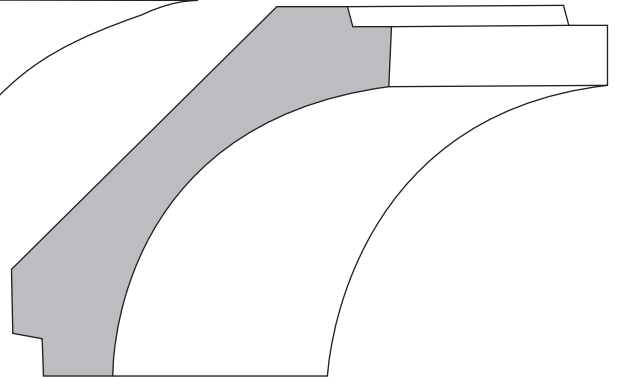

C-OC210
 $\frac{3}{4} \times 2\frac{9}{16}$

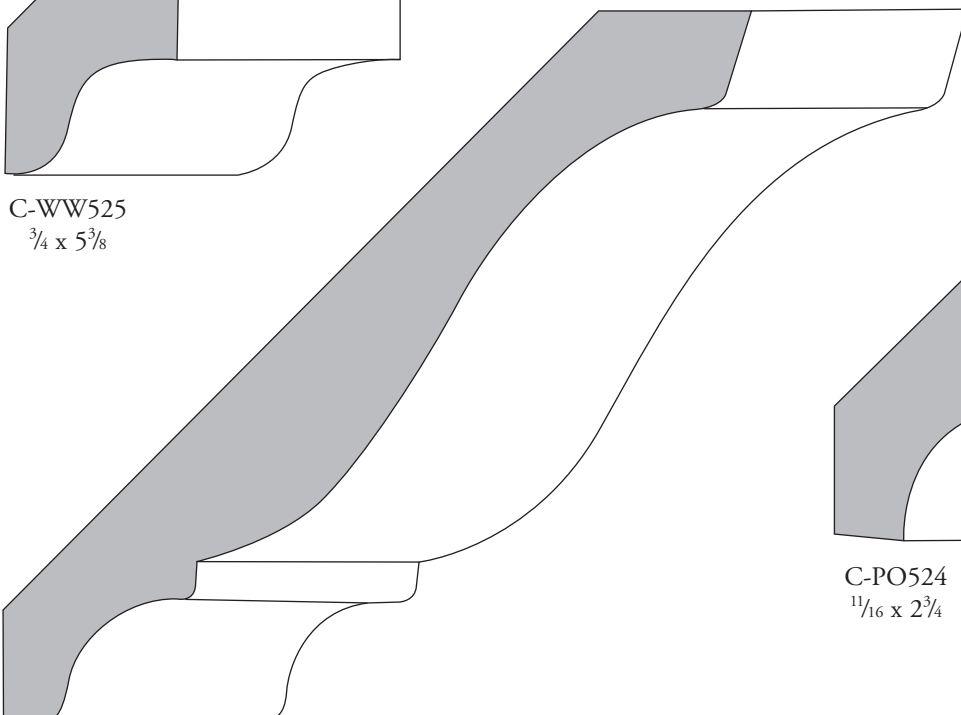

C-CM49
 $\frac{3}{4} \times 5\frac{1}{4}$

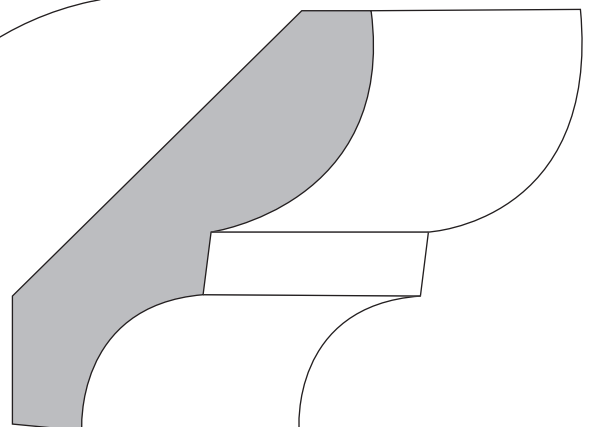

C-PO524
 $1\frac{1}{16} \times 2\frac{3}{4}$

CROWN

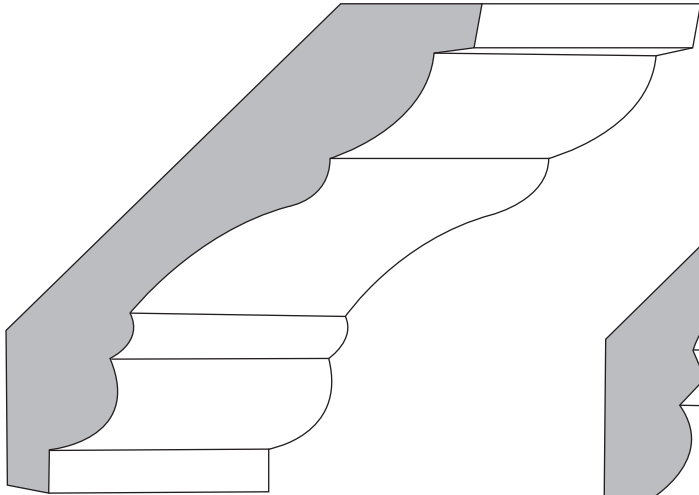

C-NJ311
 $1\frac{1}{16} \times 3\frac{1}{2}$

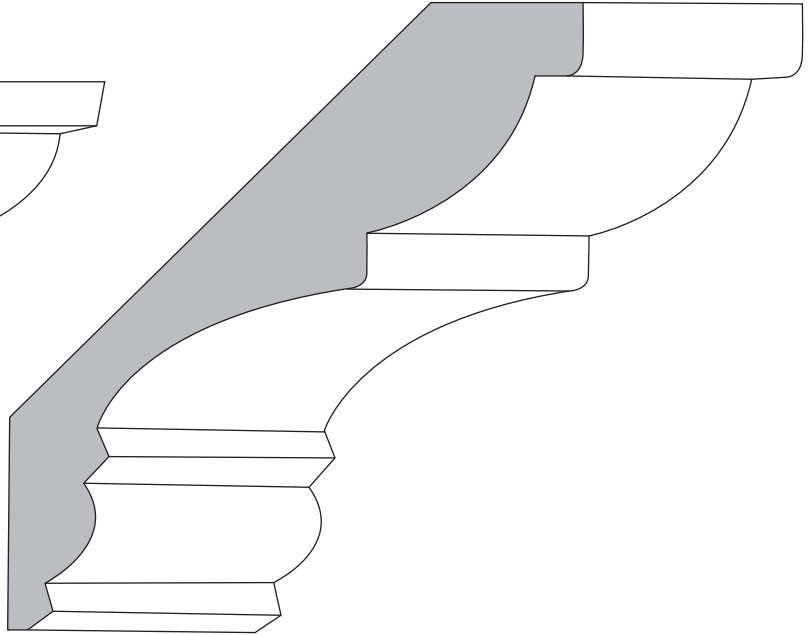

C-NJ330
 $\frac{7}{8} \times 4\frac{1}{2}$

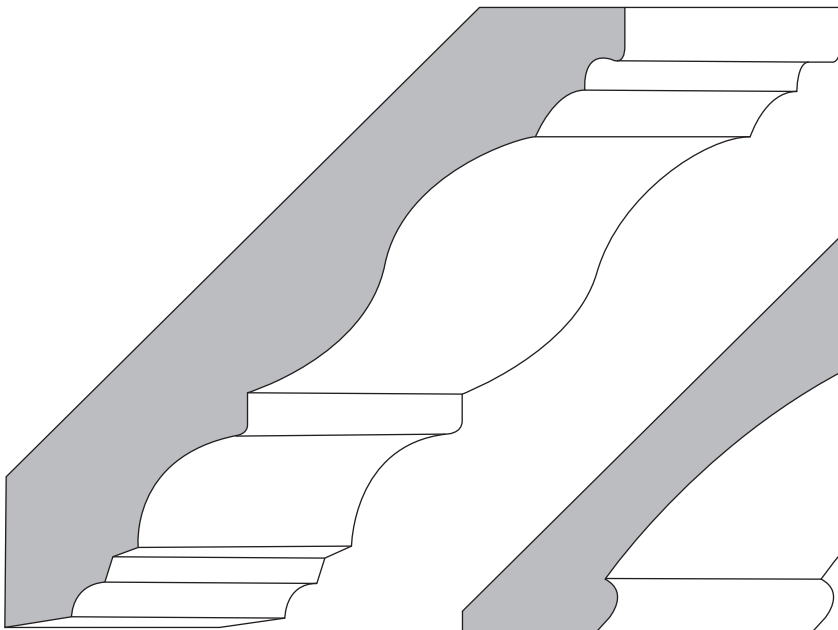

C-TH424
 $1\frac{3}{16} \times 4\frac{1}{2}$

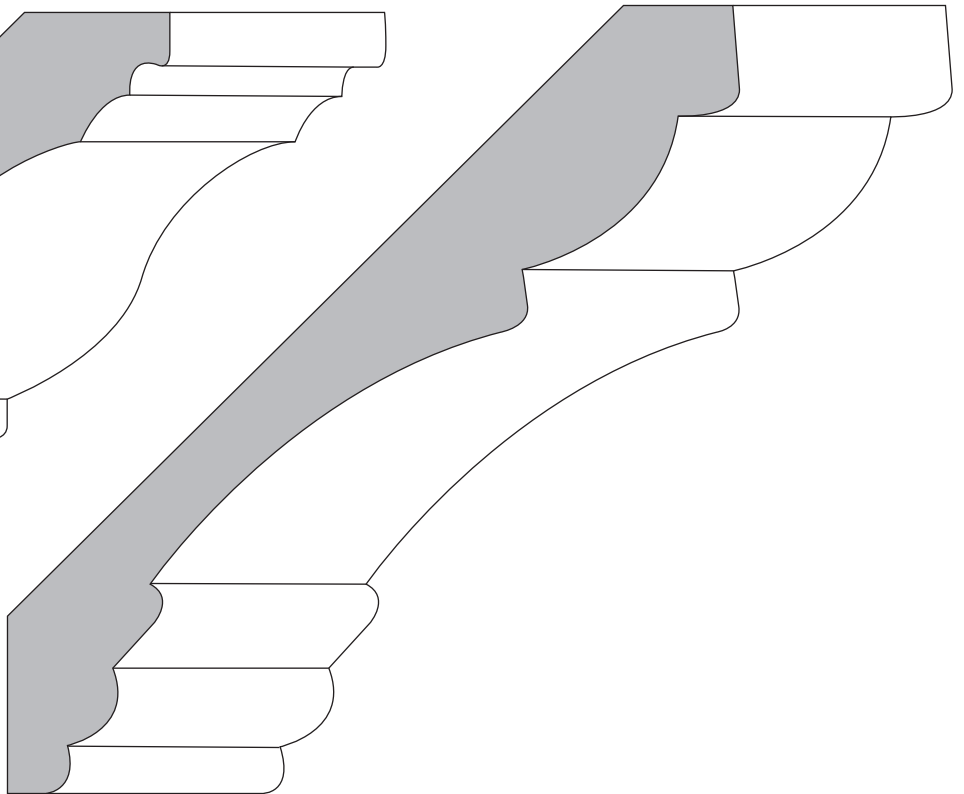

C-DM550
 $\frac{3}{4} \times 5\frac{1}{2}$

CROWN

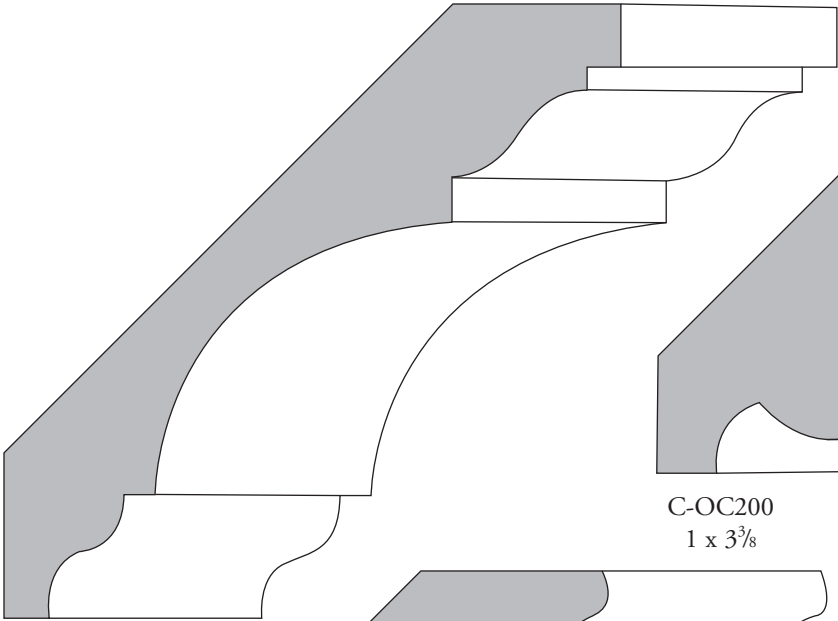

C-OC213
 $\frac{7}{8} \times 4\frac{1}{2}$

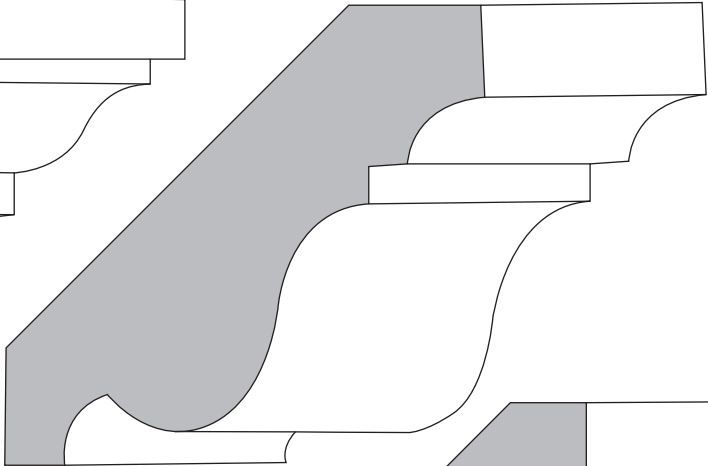

C-OC200
 $1 \times 3\frac{3}{8}$

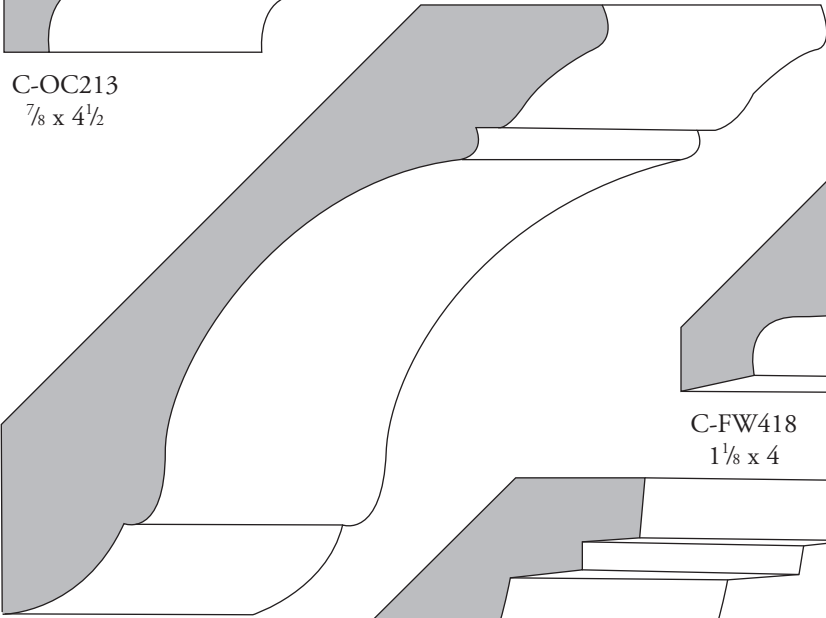

C-DB491
 $\frac{7}{8} \times 4\frac{3}{8}$

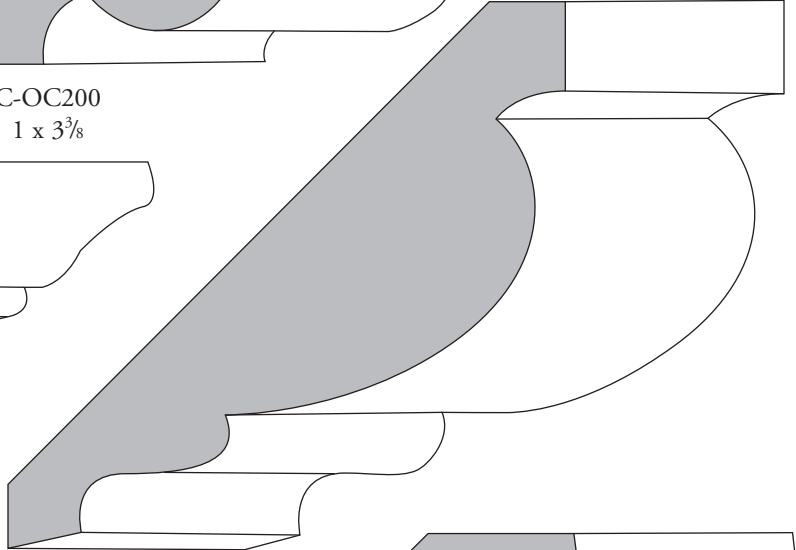

C-FW418
 $1\frac{1}{8} \times 4$

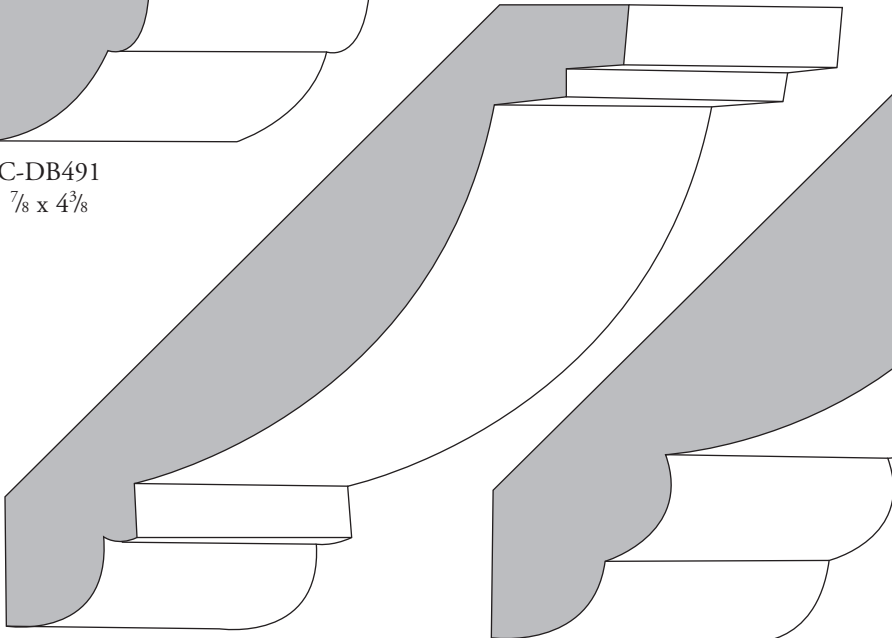

C-PO533
 $\frac{3}{4} \times 4\frac{1}{2}$

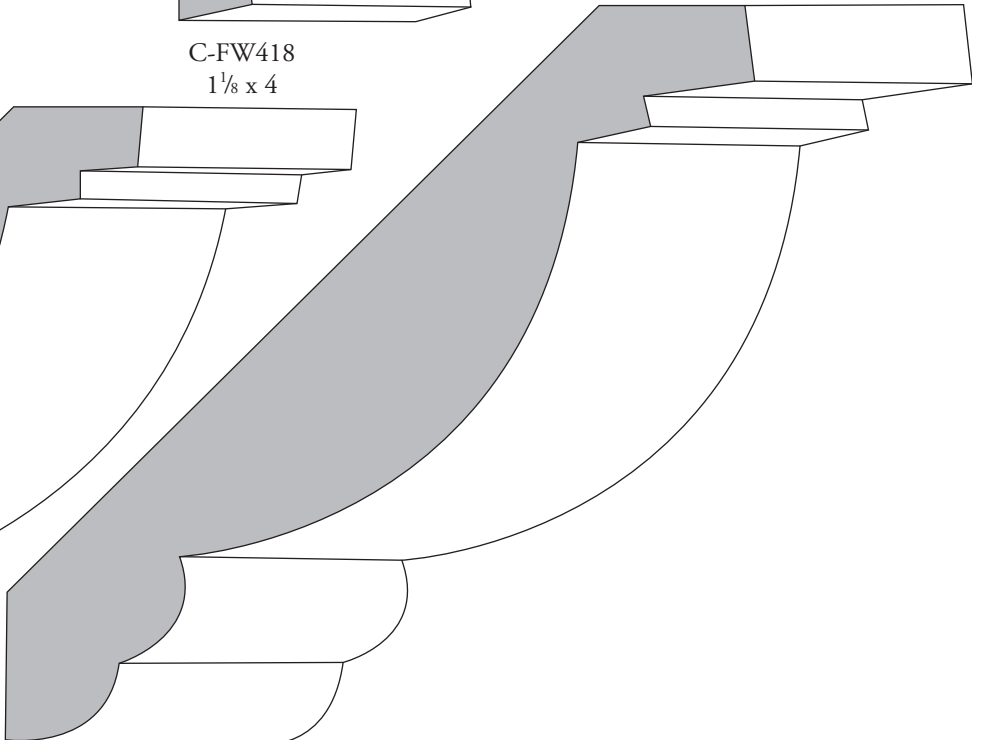

C-PO534
 $1 \times 5\frac{1}{4}$

CROWN

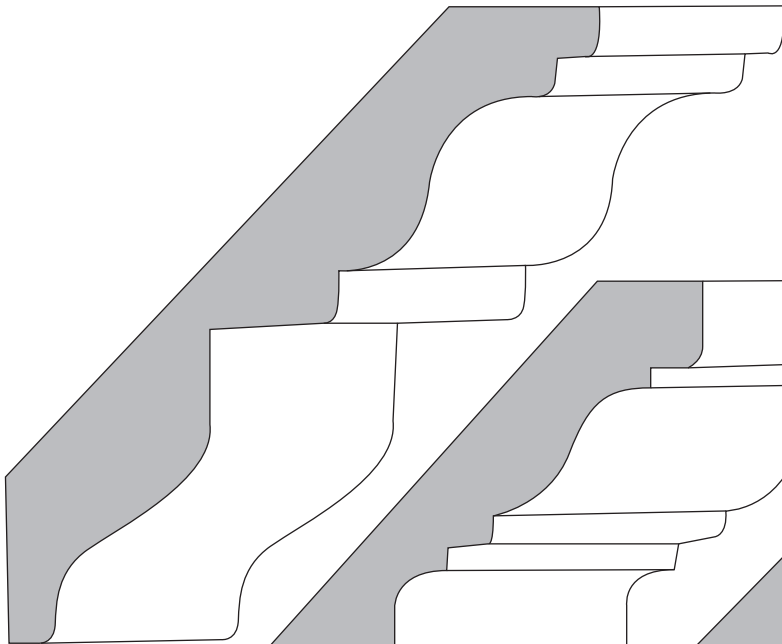

C-21469
 $\frac{3}{4} \times 5\frac{1}{4}$

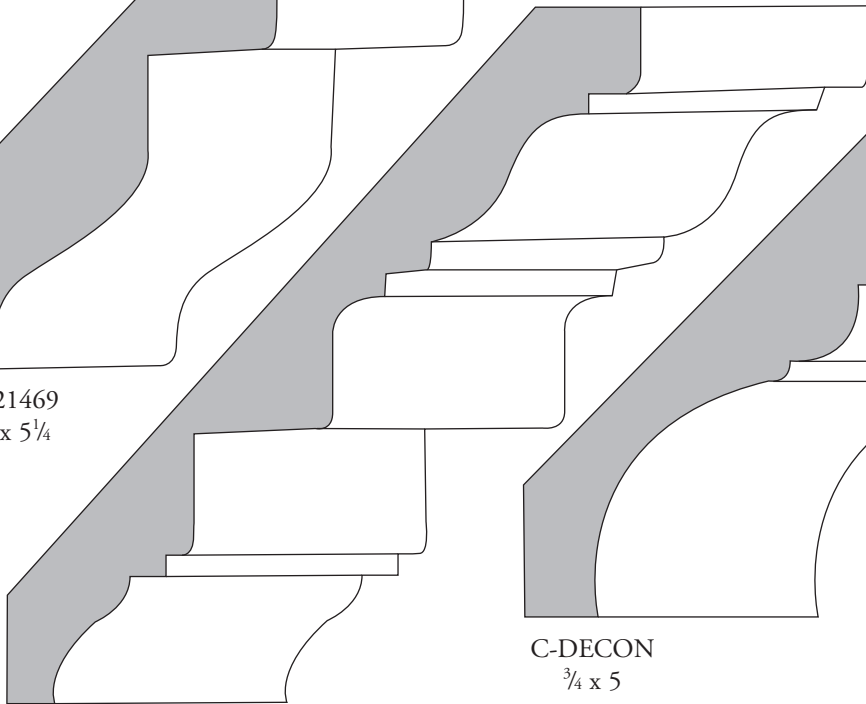

C-DECON
 $\frac{3}{4} \times 5$

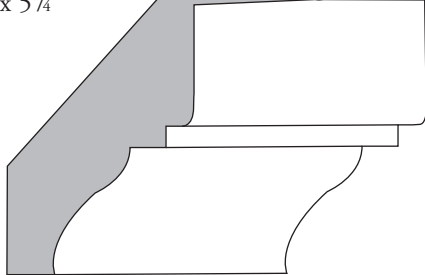

C-SM32
 $\frac{11}{16} \times 5\frac{1}{4}$

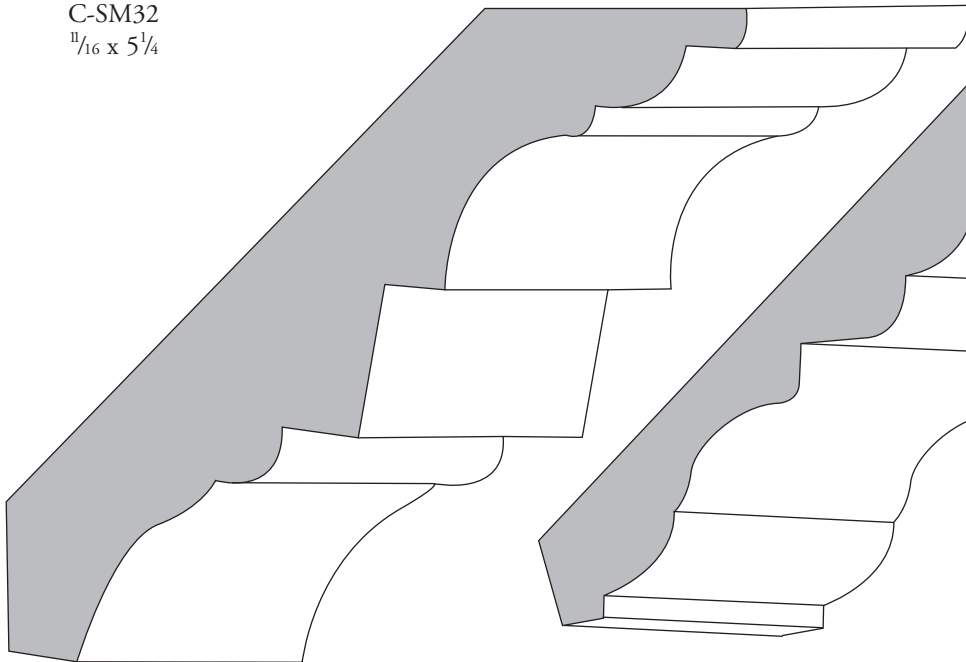

C-SM29
1 x 5

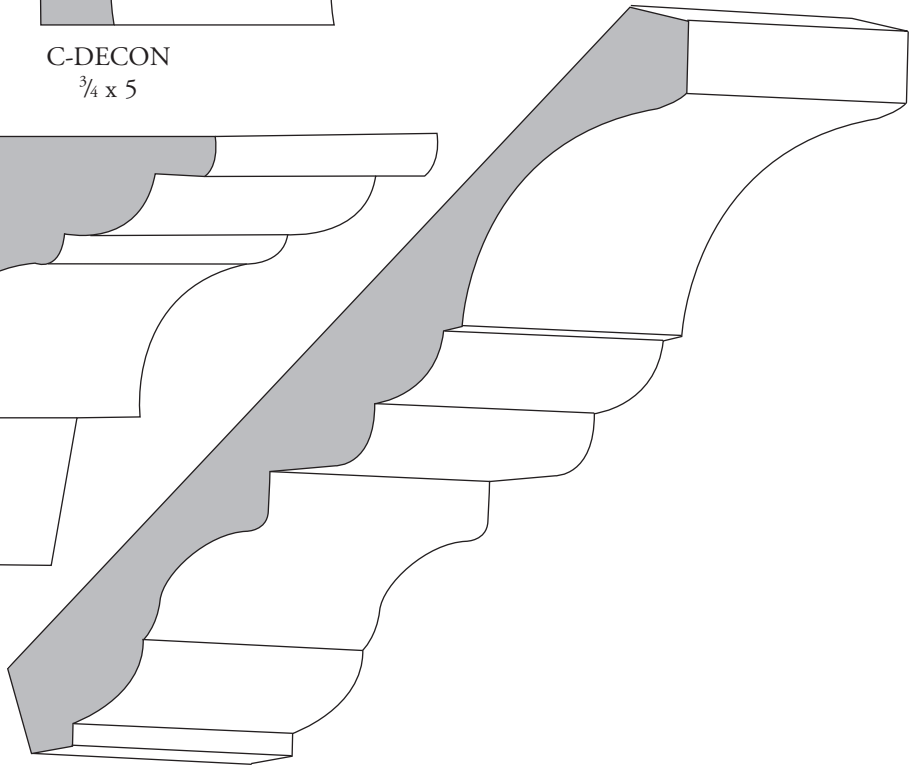

C-EC37
 $\frac{11}{16} \times 5\frac{1}{16}$

CROWN

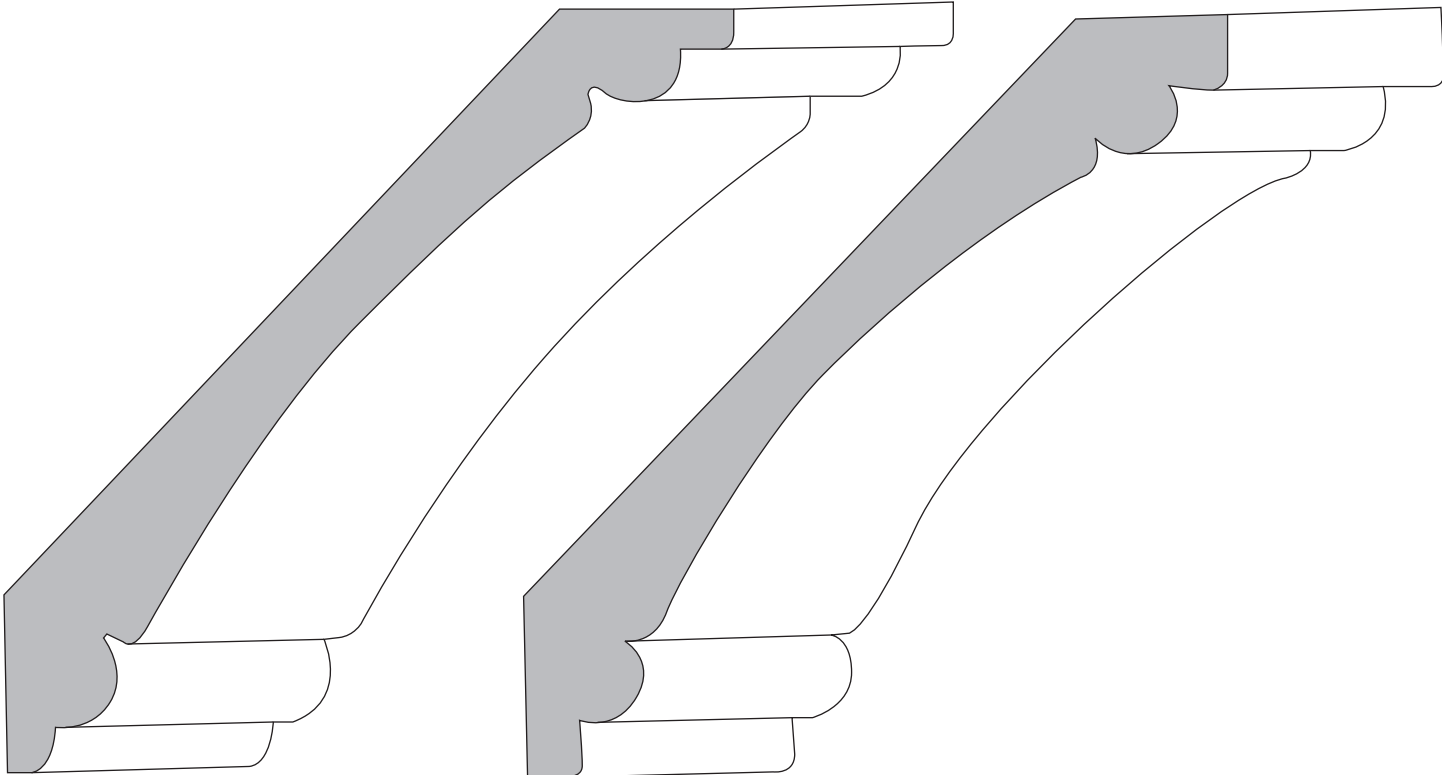

C-BO538
 $\frac{3}{4} \times 5\frac{3}{8}$

C-CM449
 $\frac{13}{16} \times 5\frac{1}{4}$

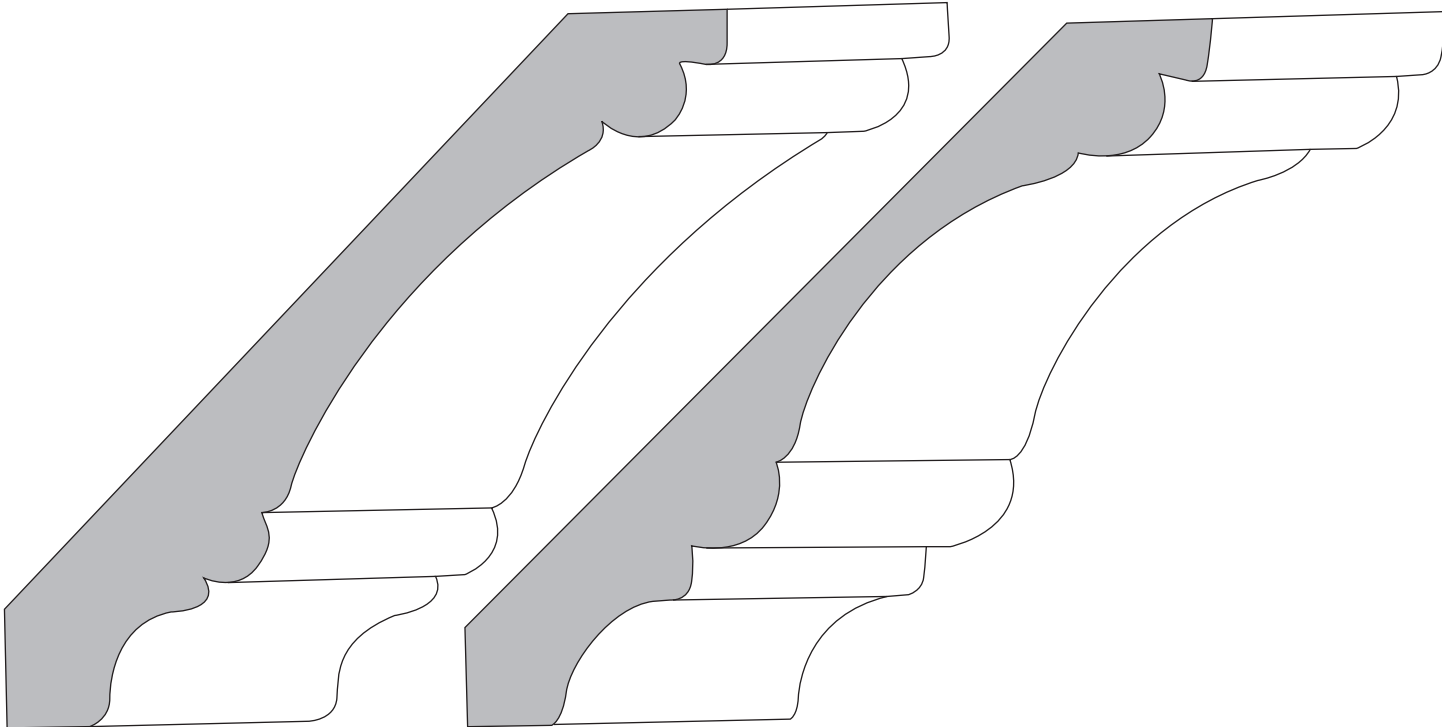

C-CM525
 $\frac{3}{4} \times 5\frac{1}{4}$

C-KB334
 $\frac{3}{4} \times 5\frac{1}{8}$

CROWN

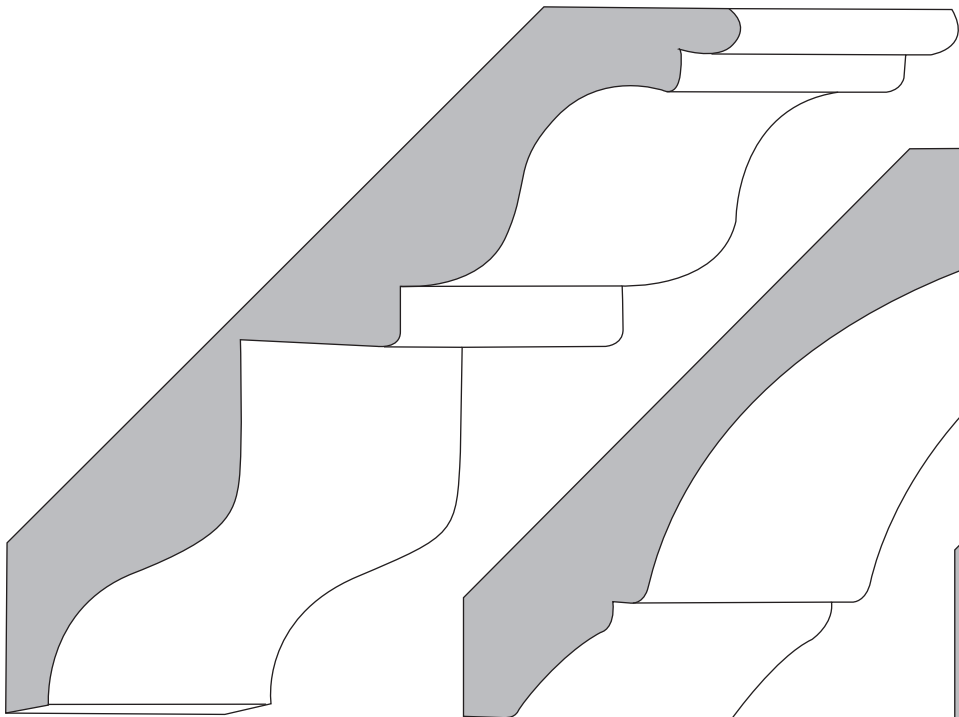

C-PA526
 $\frac{3}{4} \times 5\frac{1}{4}$

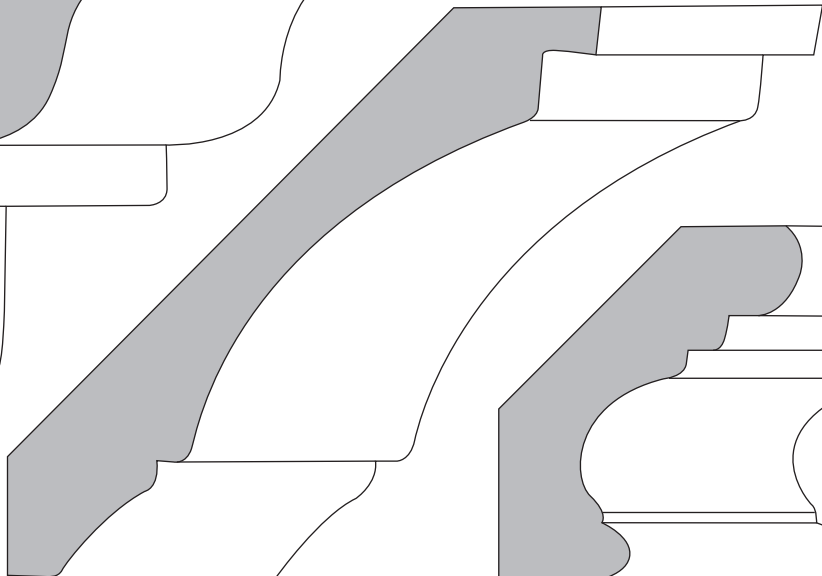

C-CT425
 $\frac{5}{8} \times 4\frac{1}{4}$

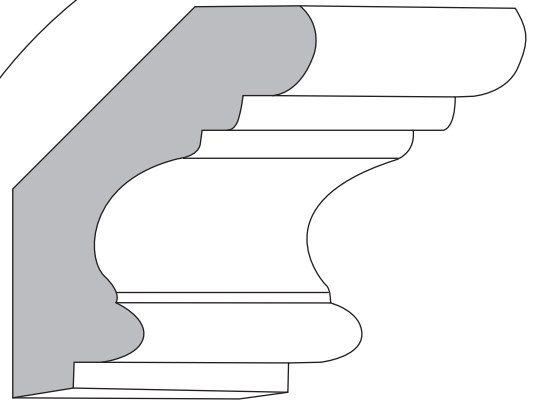

C-OC322
 $1 \times 2\frac{7}{16}$

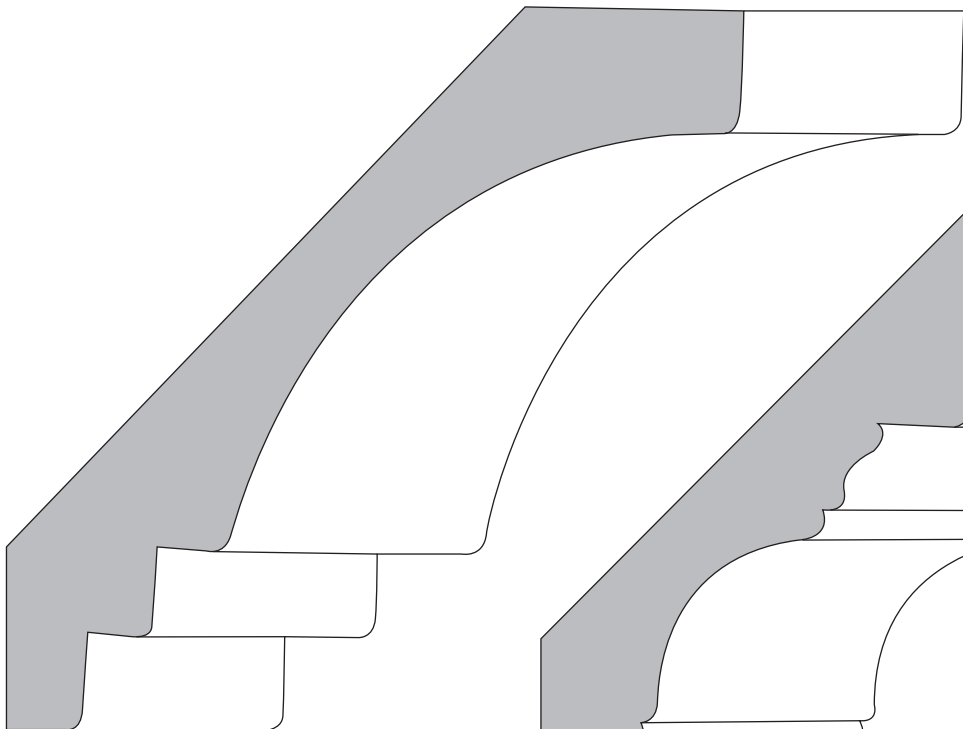

C-MI558
 $1\frac{1}{8} \times 5\frac{7}{8}$

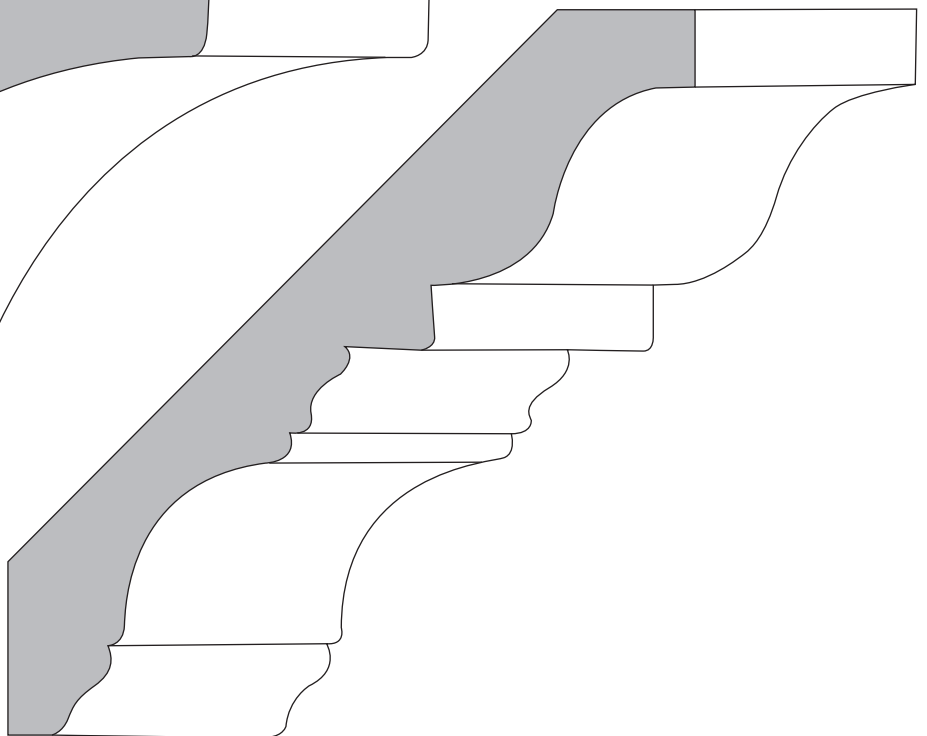

C-PM628
 $\frac{3}{4} \times 5\frac{1}{8}$

CROWN

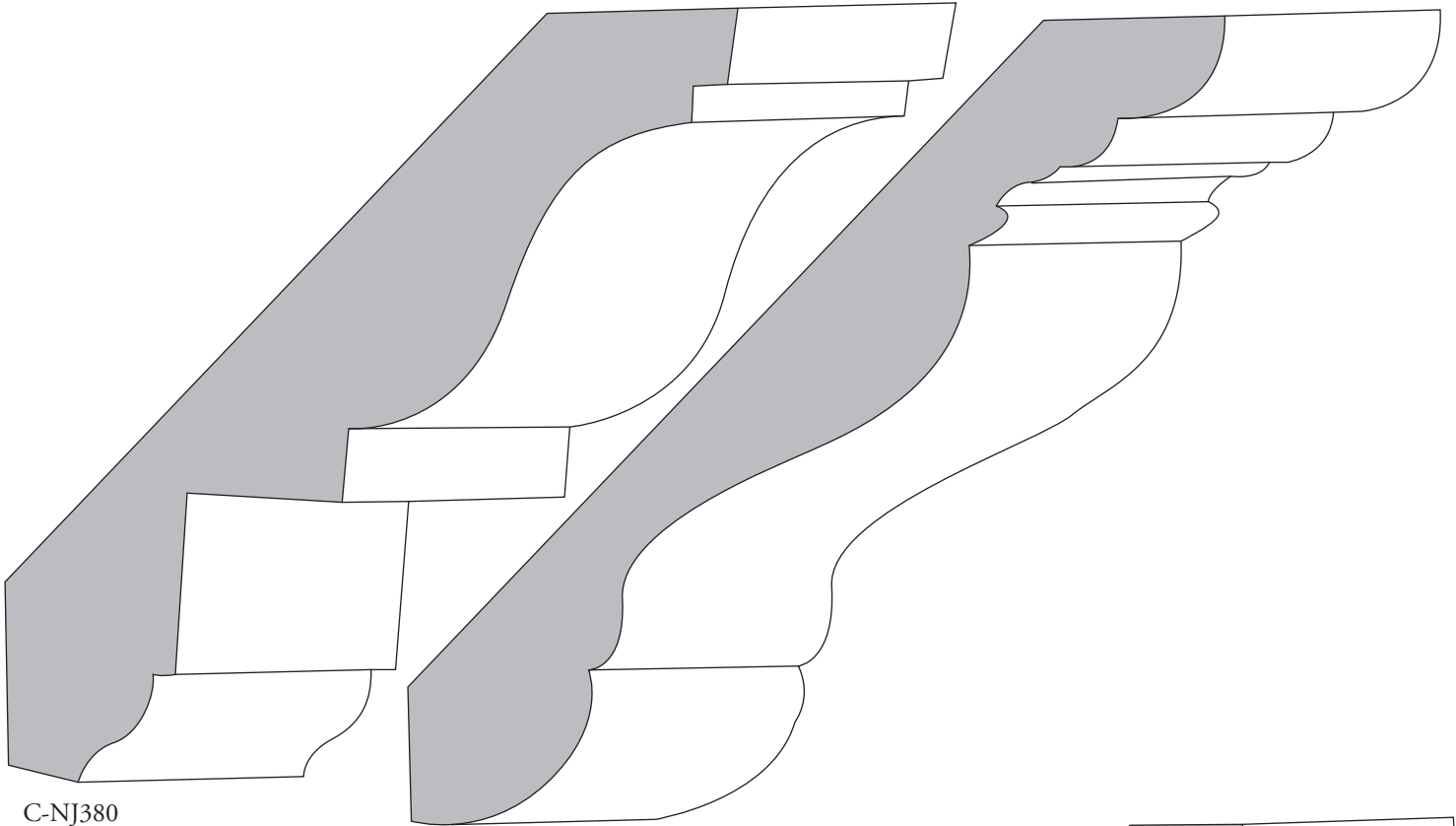

C-NJ380
1 x 5 1/2

T-SL260
1 3/16 x 6

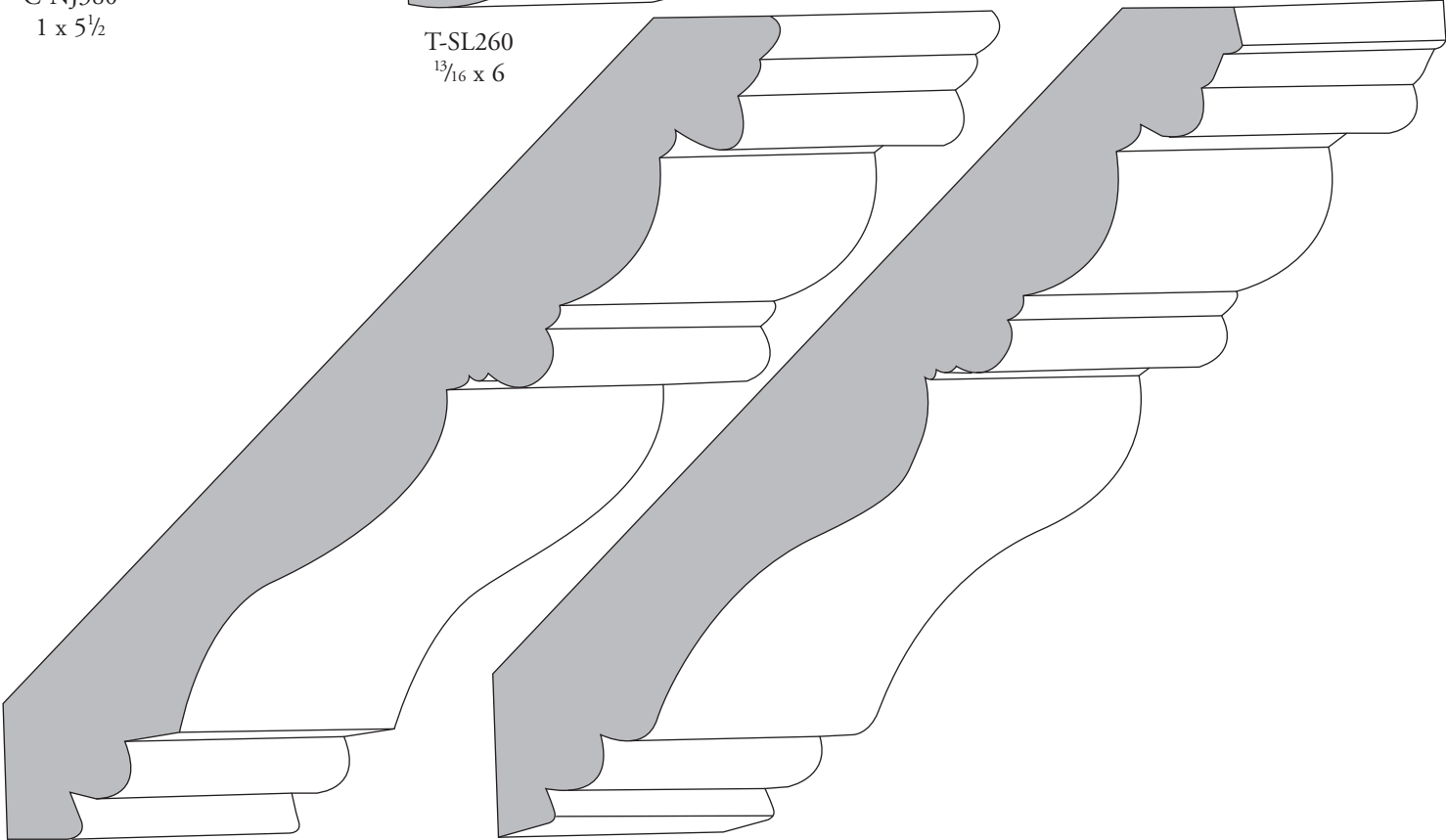

C-FRIED
7/8 x 5 7/8

C-EM227
1 3/16 x 5 7/8



CROWN

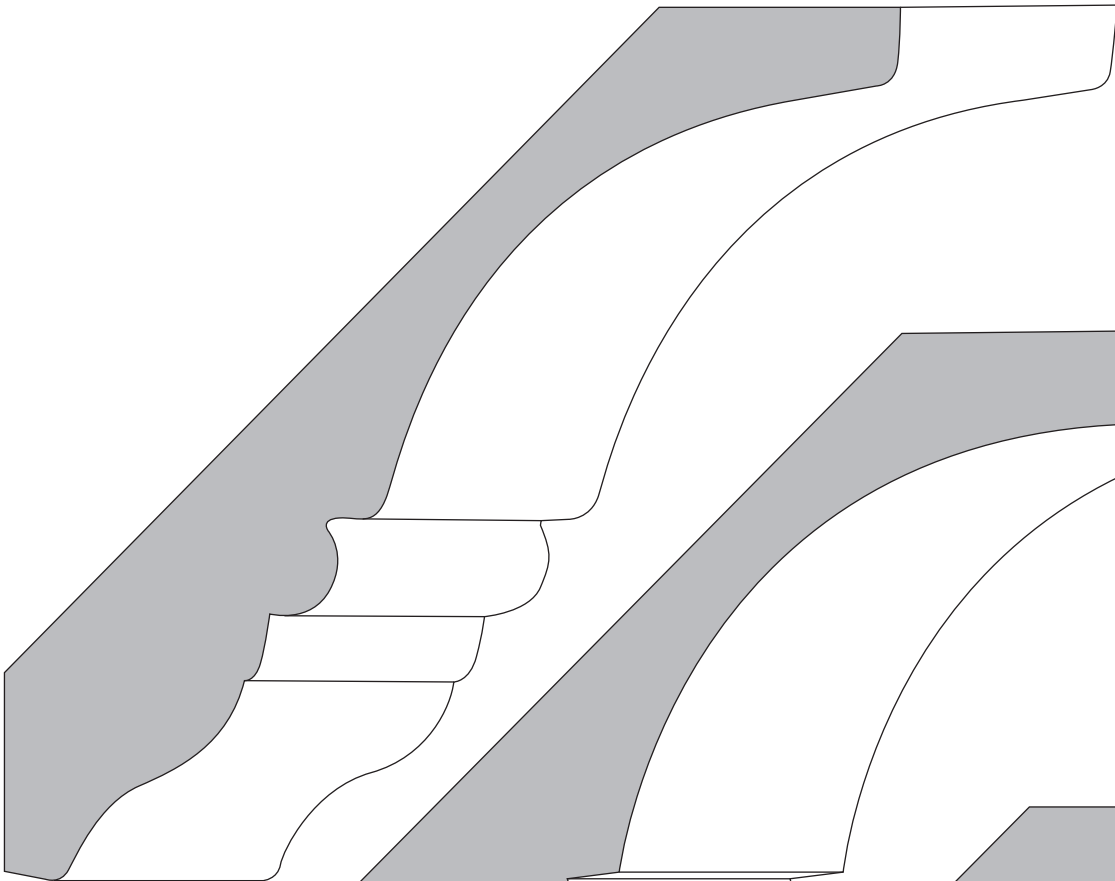

C-LD226
1 x 6³/₈



C-P4440
1¹/₁₆ x 6¹/₂

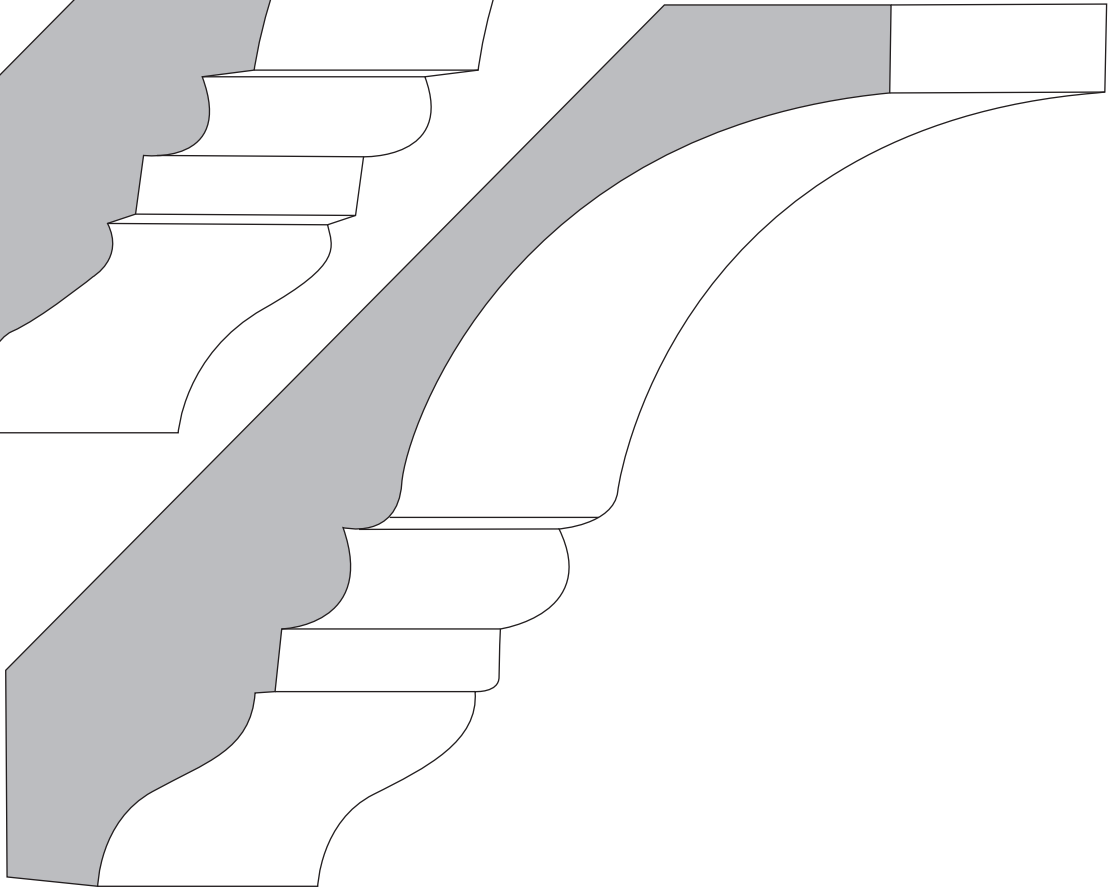

C-C21
1¹/₈ x 6¹/₂

CROWN

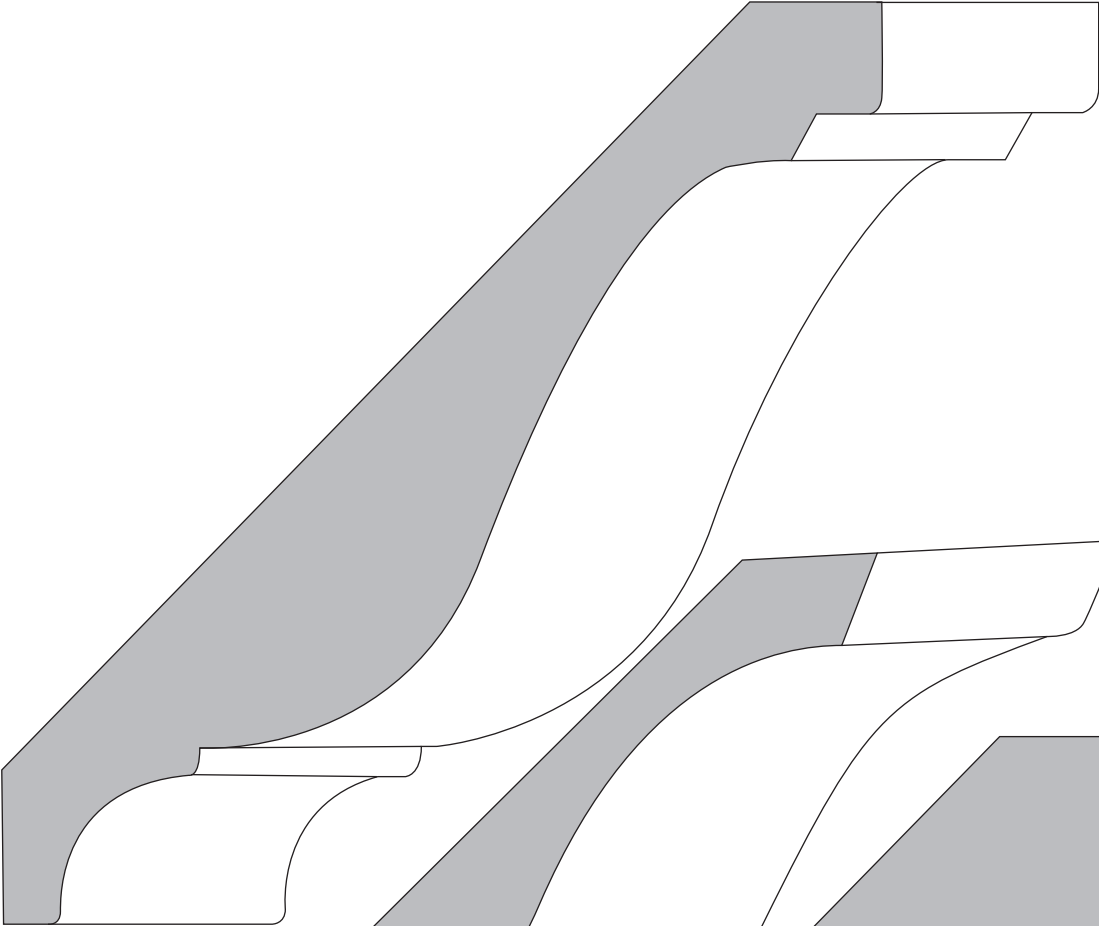

C-BM1
 $1\frac{1}{8} \times 6\frac{5}{8}$



C-CM70
 $1\frac{3}{16} \times 7\frac{1}{16}$

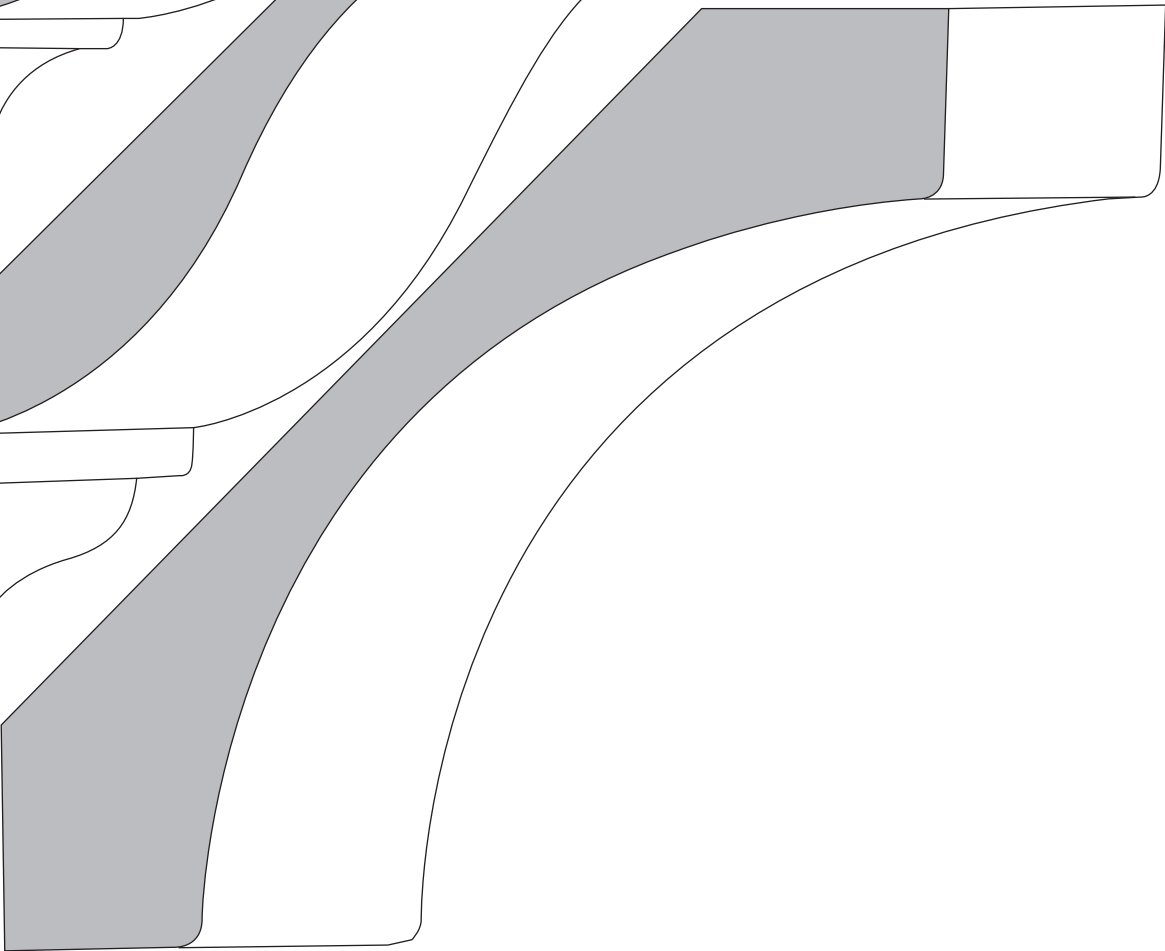

C-SM700
 $1\frac{1}{2} \times 7$

CROWN

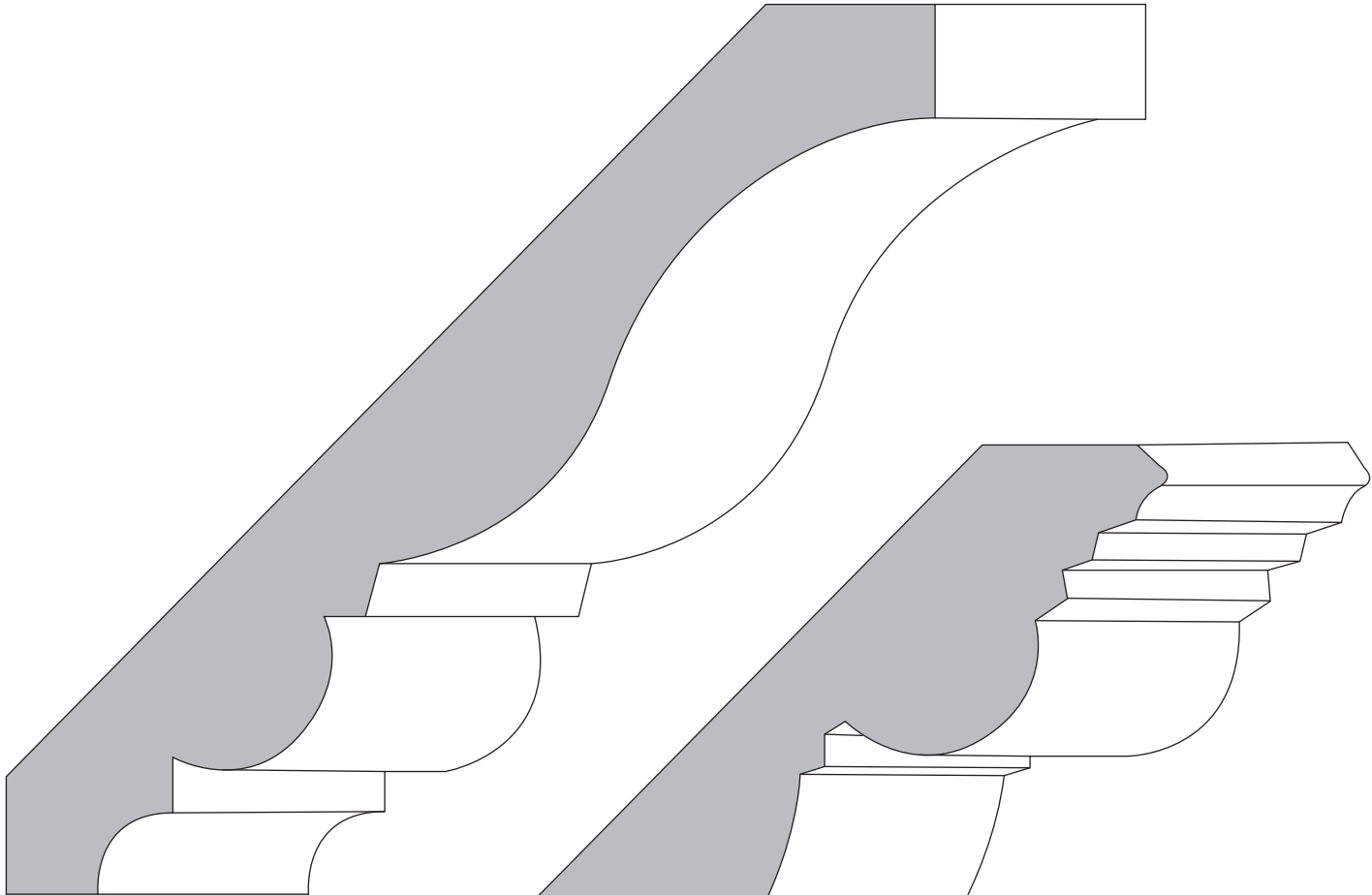

C-RR700
1 x 7

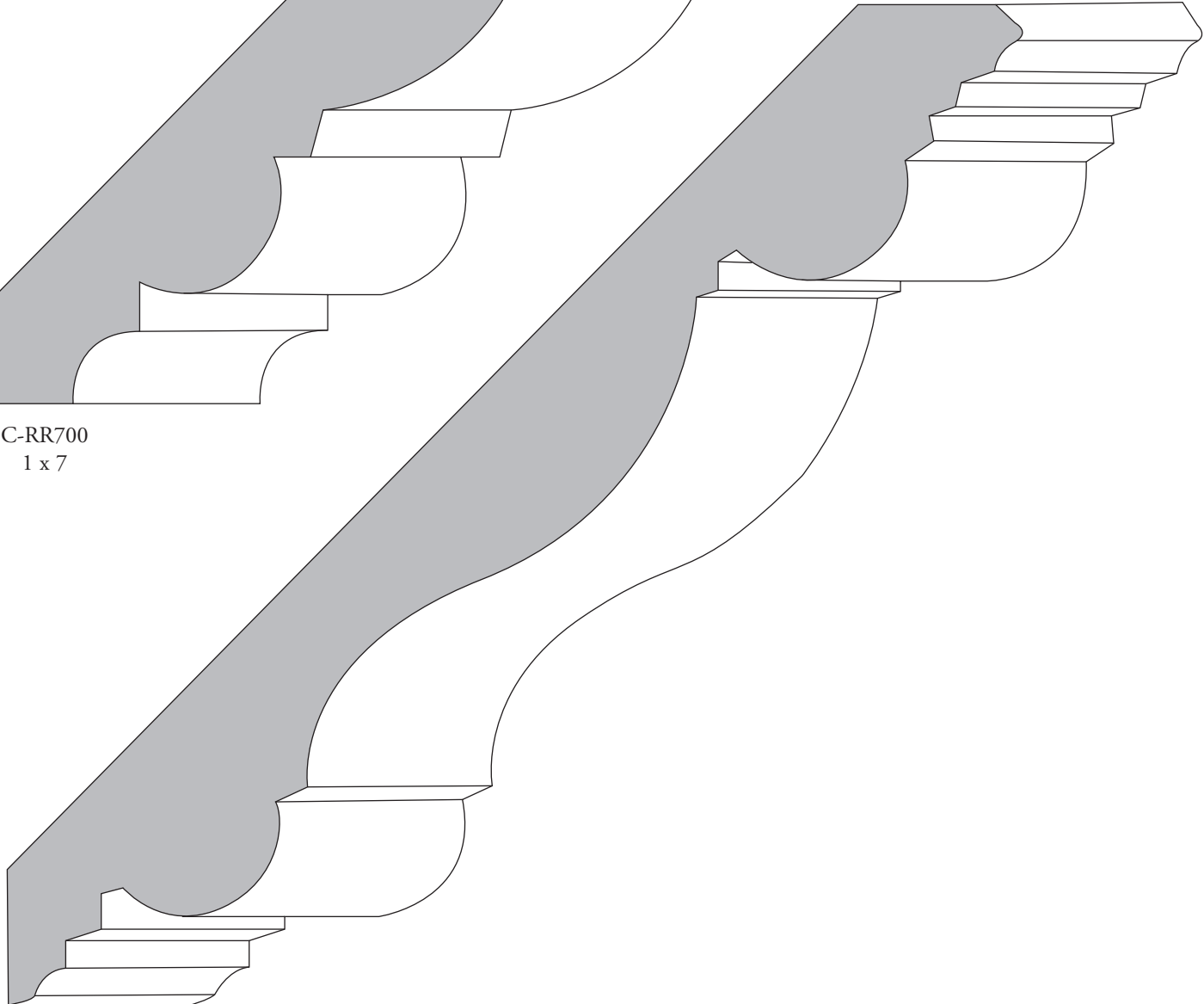

C-RC858
1 1/8 x 8 1/2

CROWN

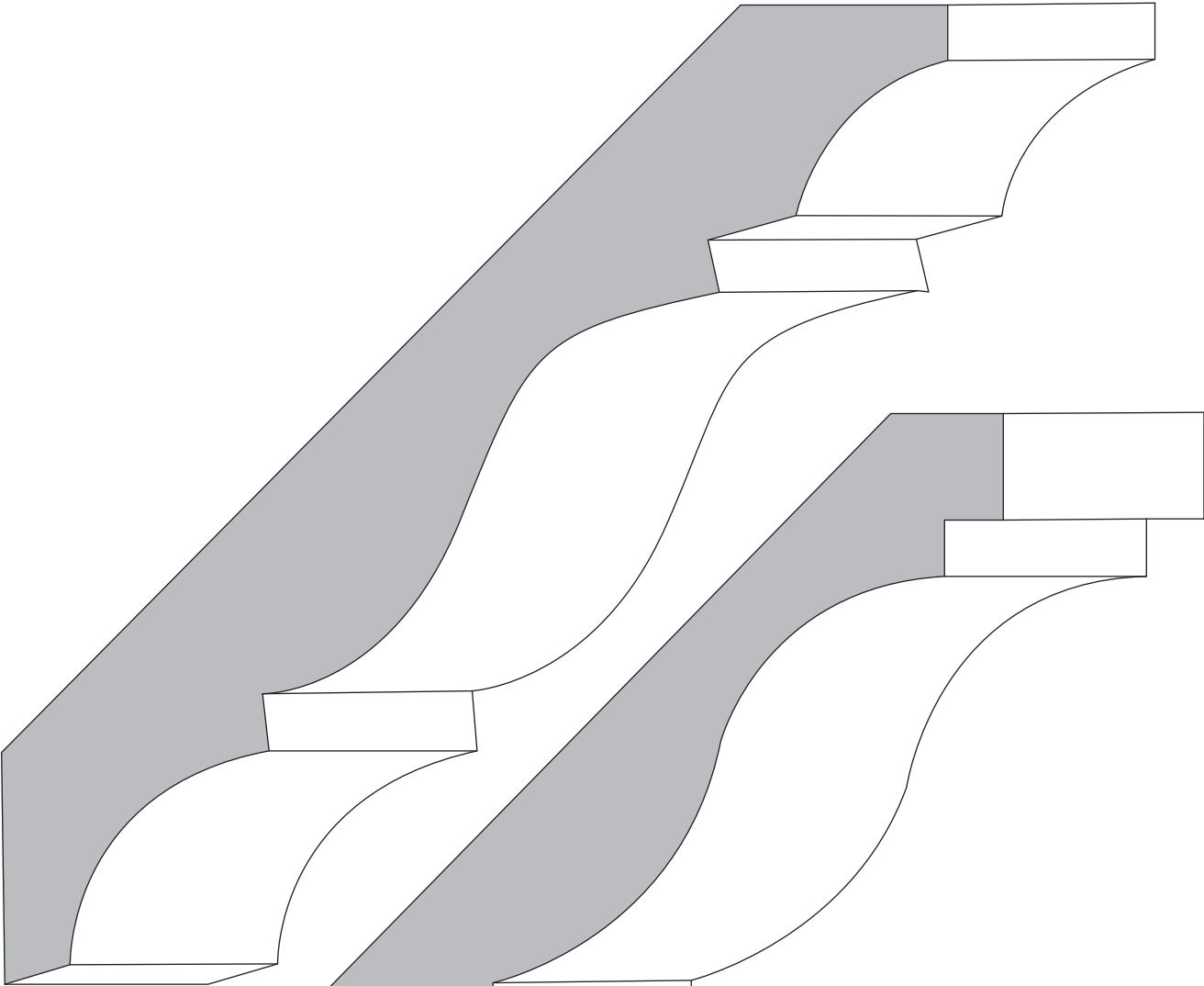

C-BM256
1 1/8 x 7 5/16

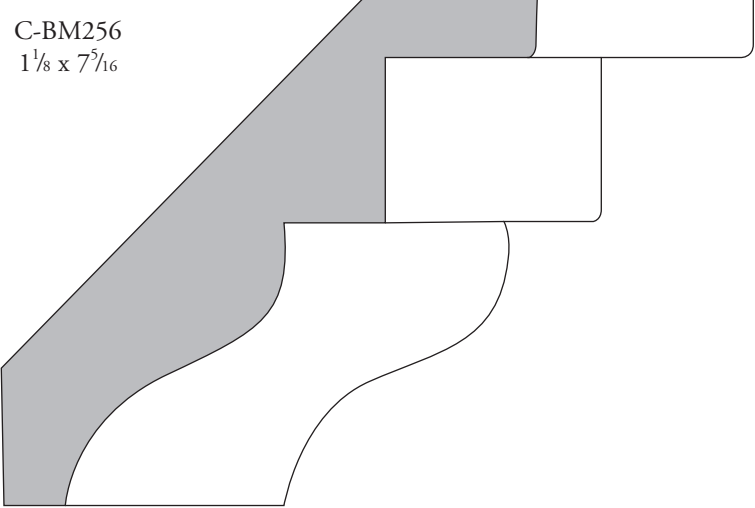

C-NA800
7/8 x 8



CROWN

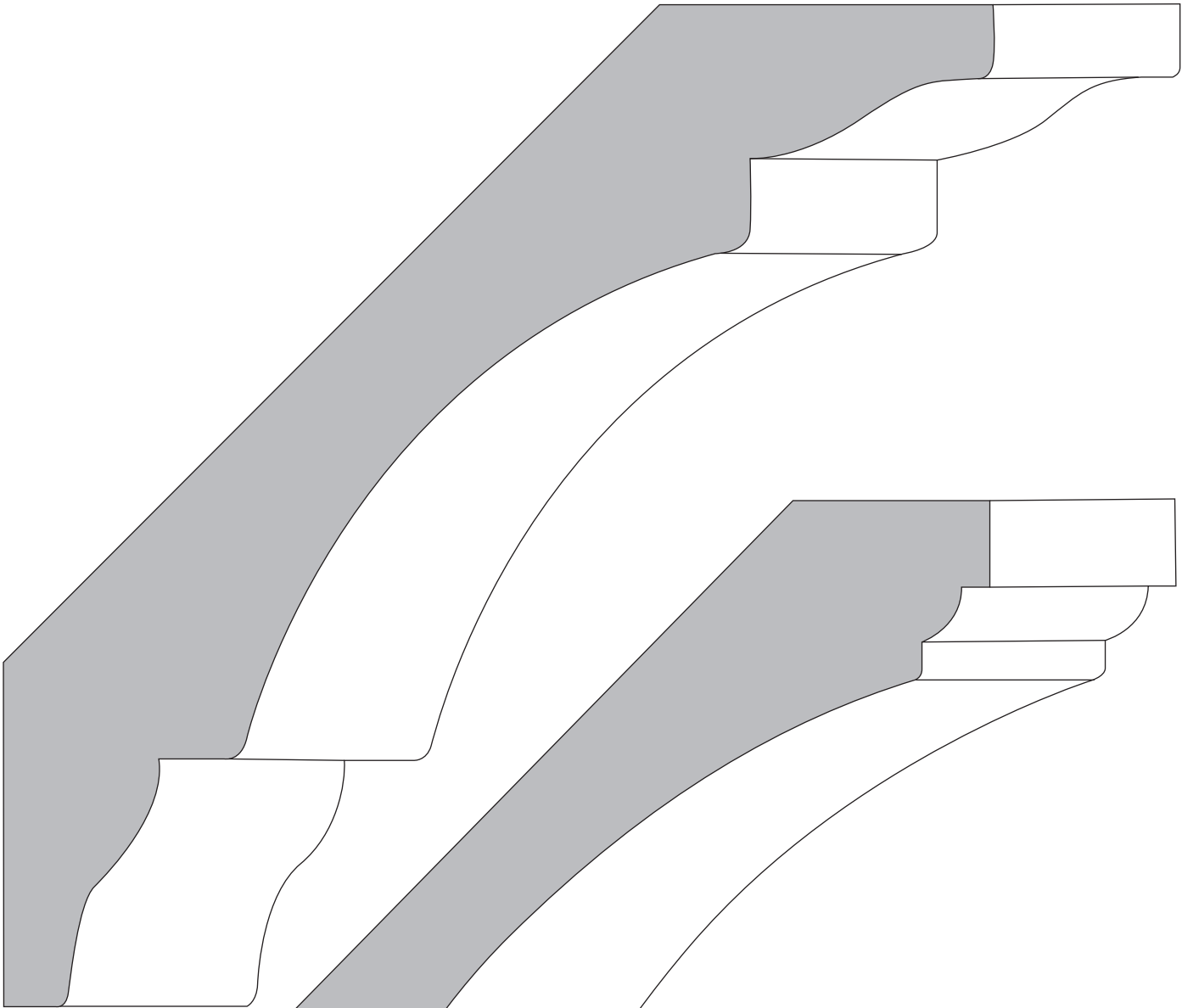

C-TH428
1³/₄ x 8⁵/₈

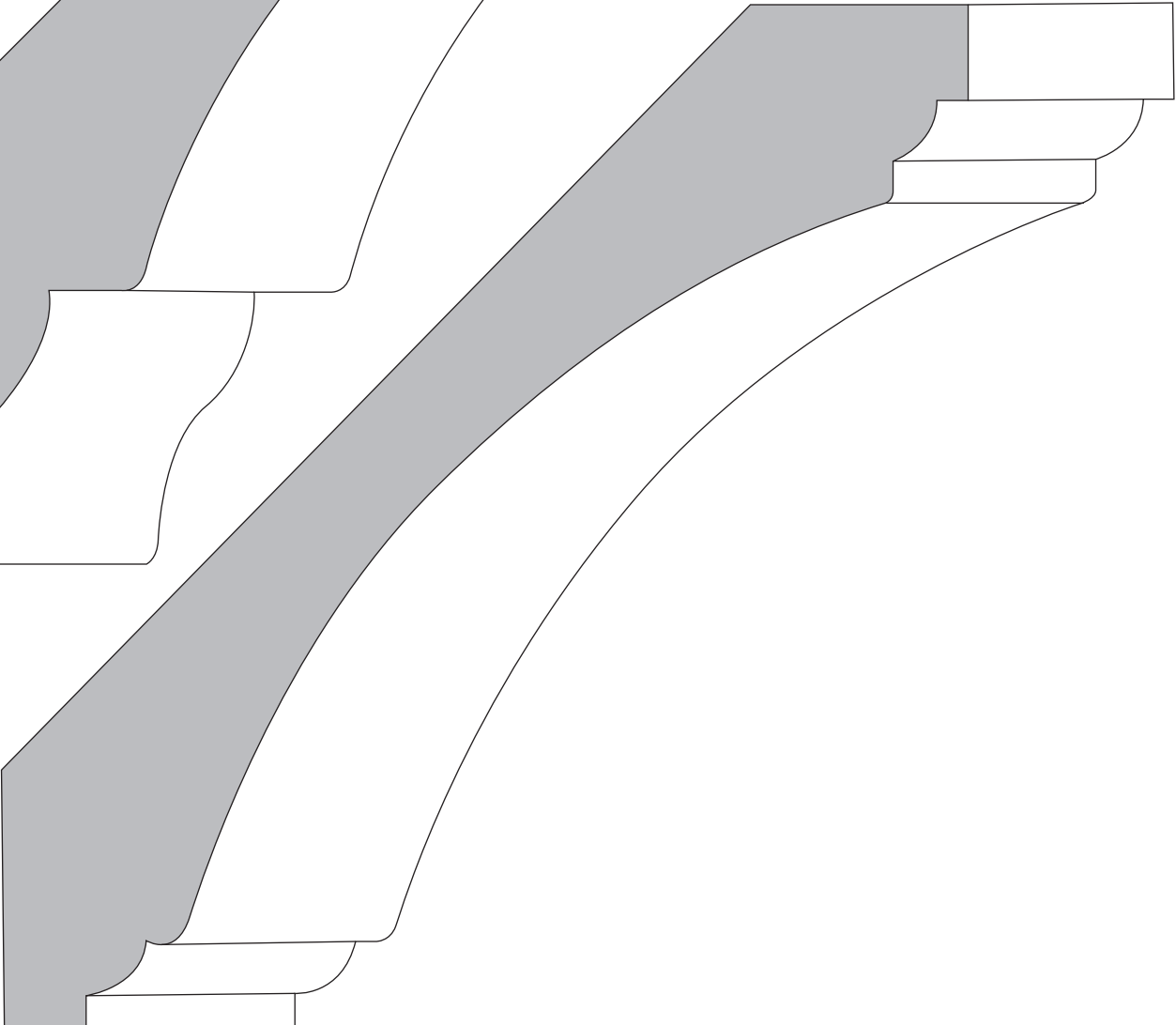

C-LD248
1⁵/₈ x 7³/₄

CROWN

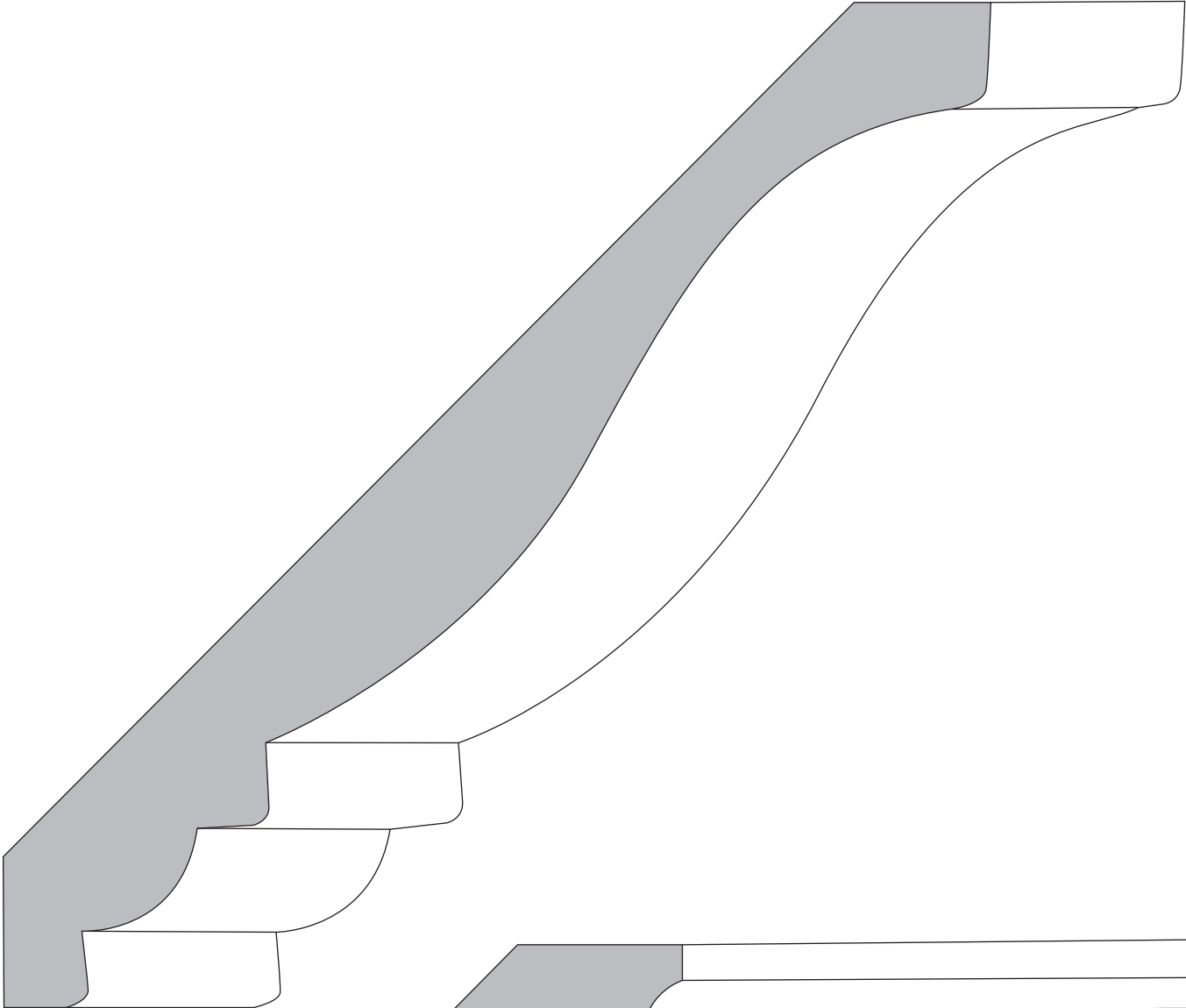

C-PM611
 $1\frac{5}{16} \times 8\frac{1}{4}$

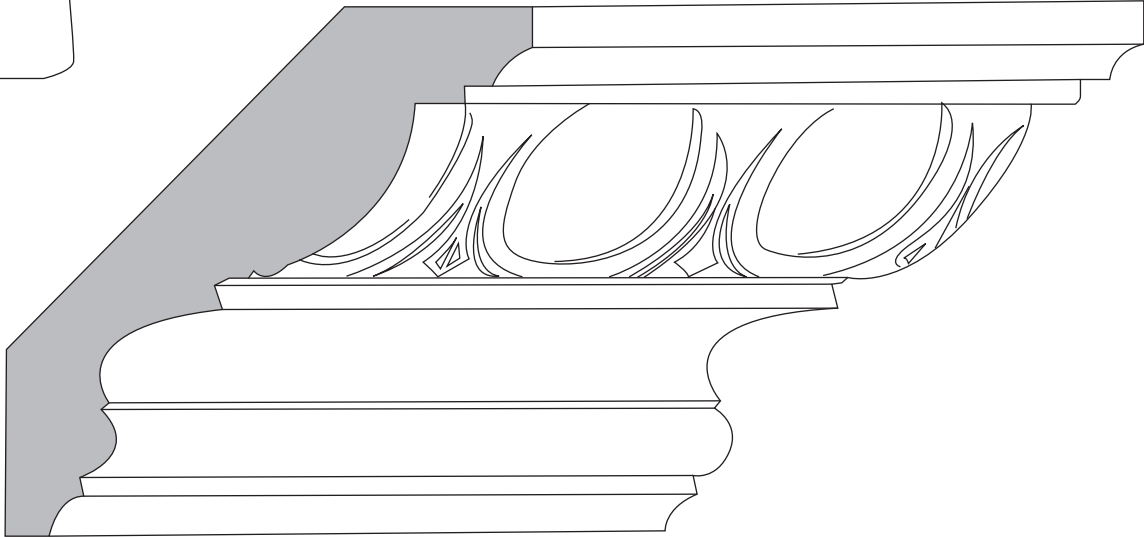

C-RR215
 $1\frac{3}{16} \times 3\frac{3}{4}$

CROWN

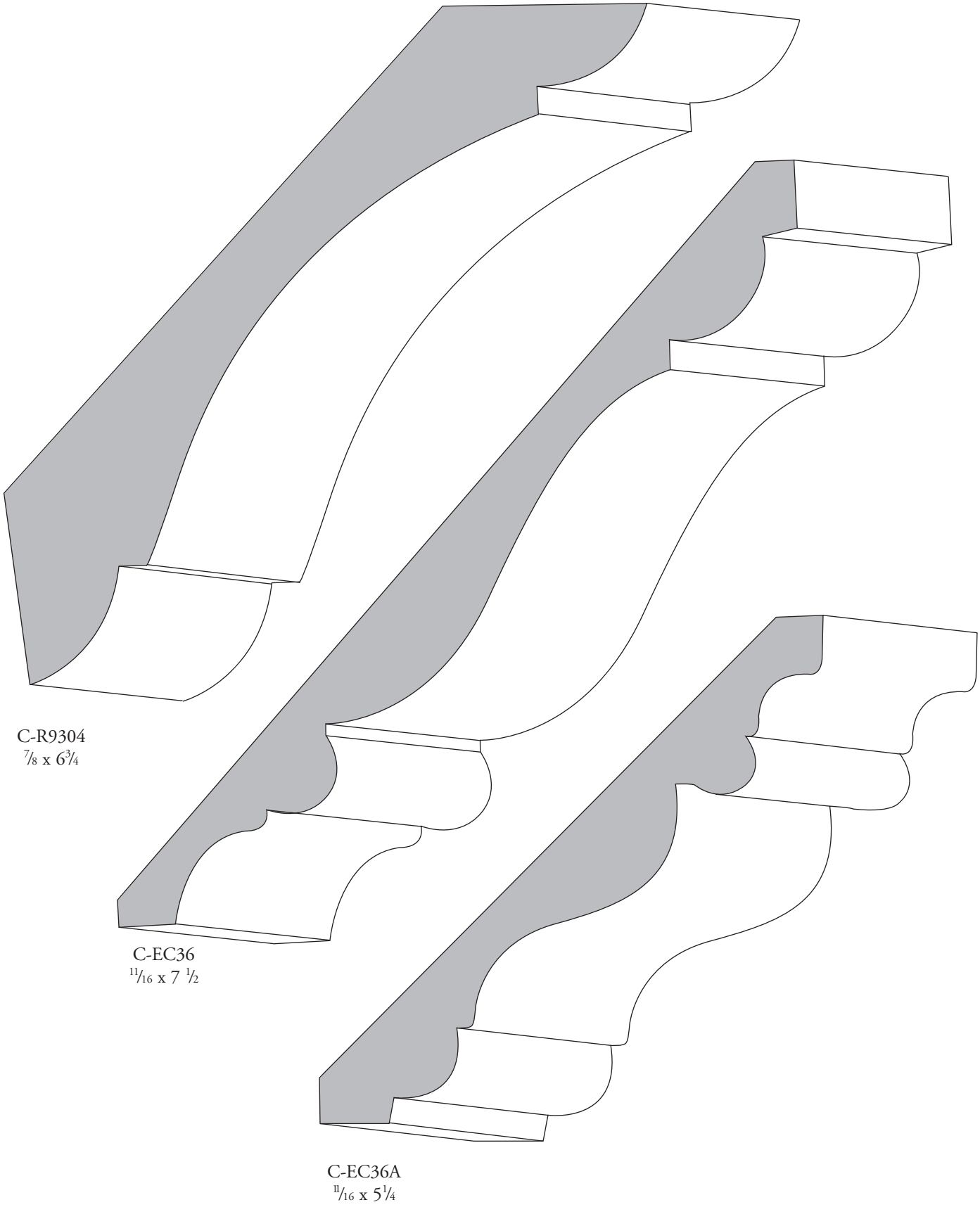

CROWN

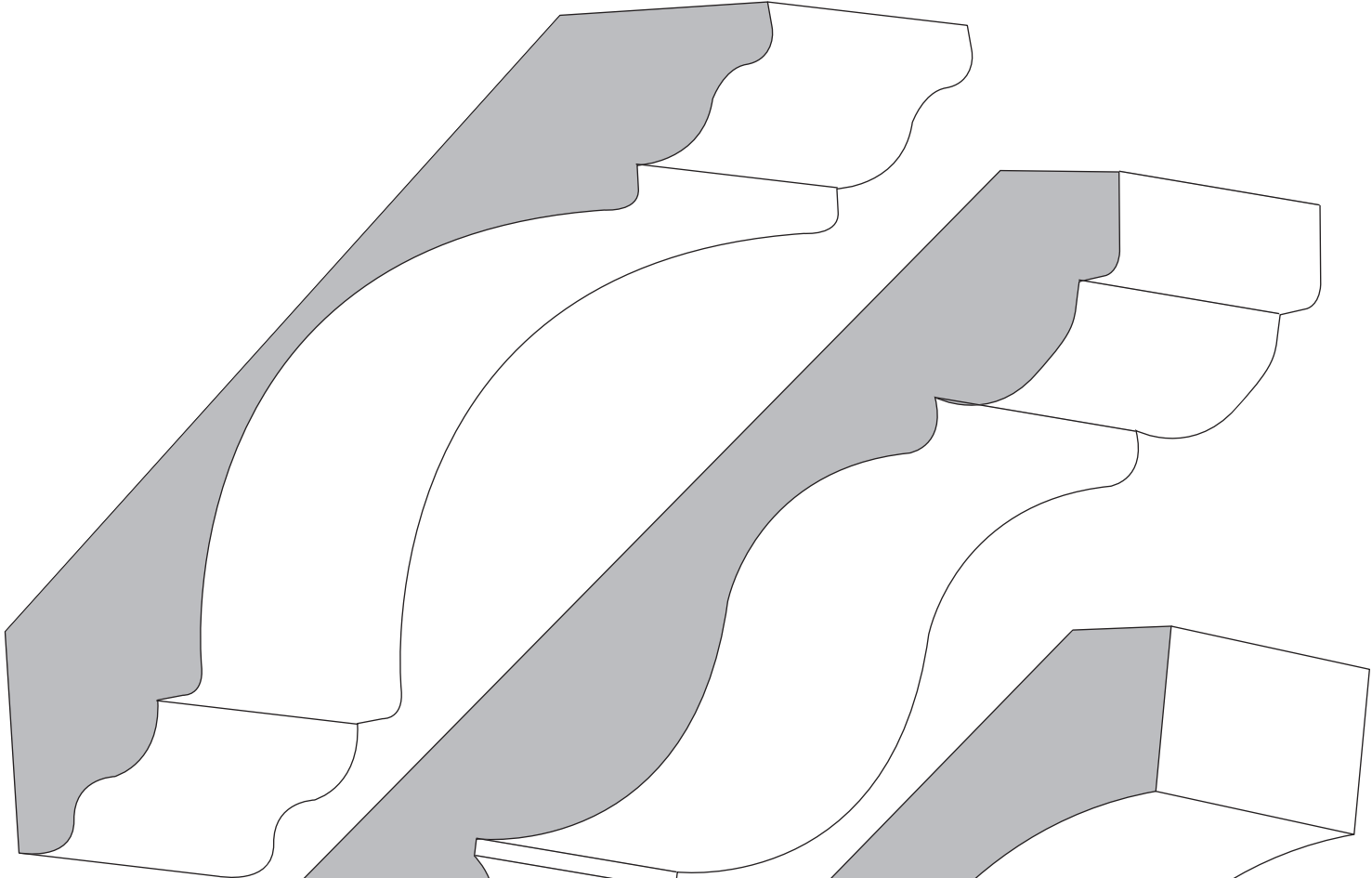

C-MD329
1 1/8 x 6 5/16

C-USC42
1 x 7 1/4

C-AH41
1 x 7



CROWN

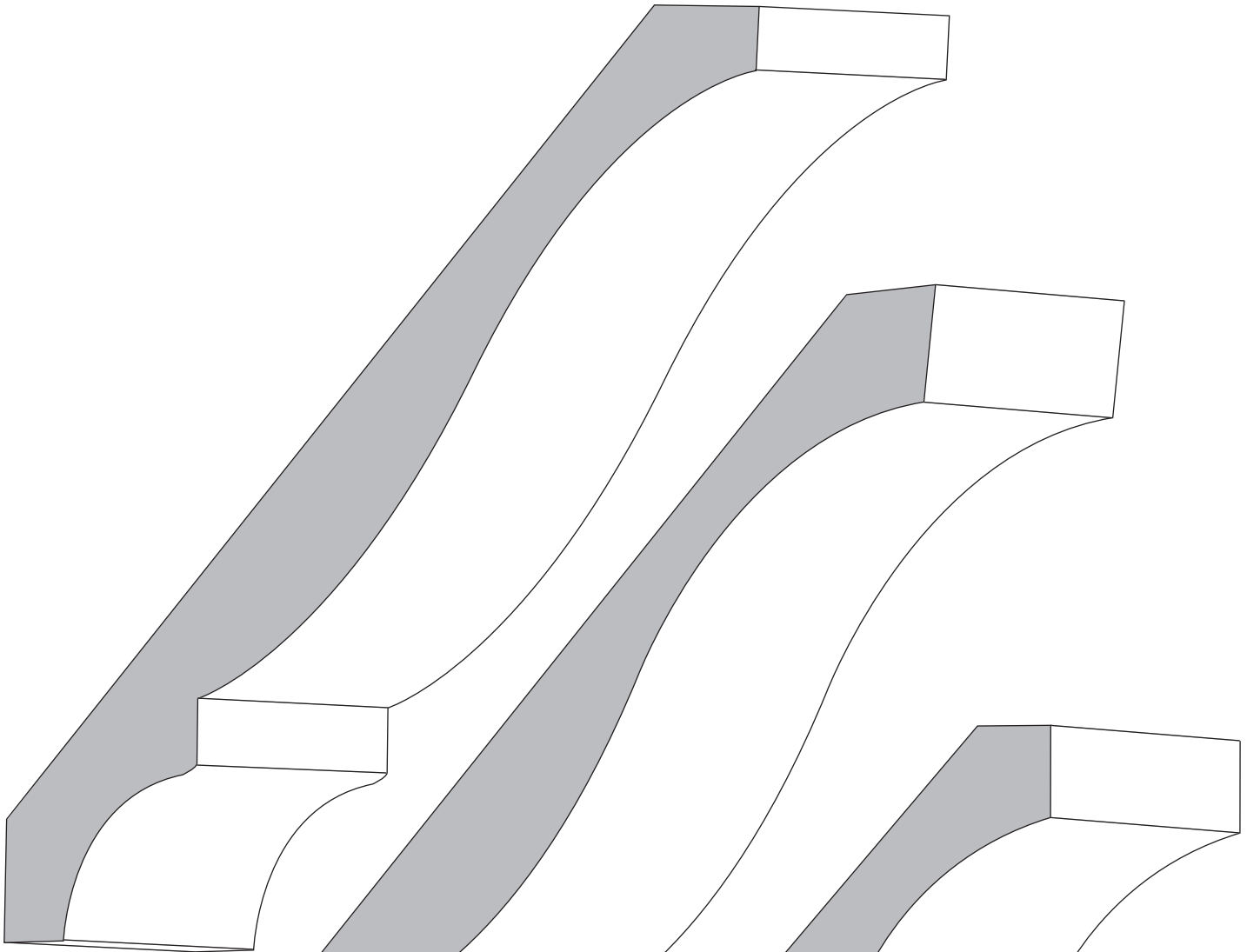

C-FM725
 $\frac{5}{8} \times 7\frac{1}{4}$

C-CO725
 $1\frac{1}{16} \times 7\frac{1}{4}$

C-LWM46
 $\frac{1}{2} \times 5\frac{1}{4}$

CROWN

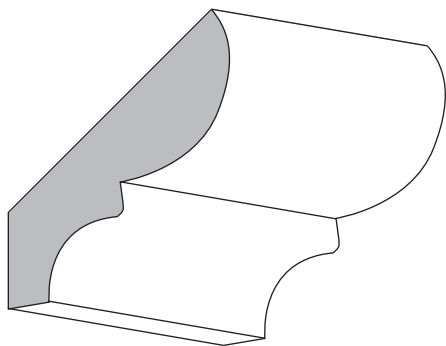

T-WM074
 $\frac{9}{16} \times 1\frac{3}{4}$

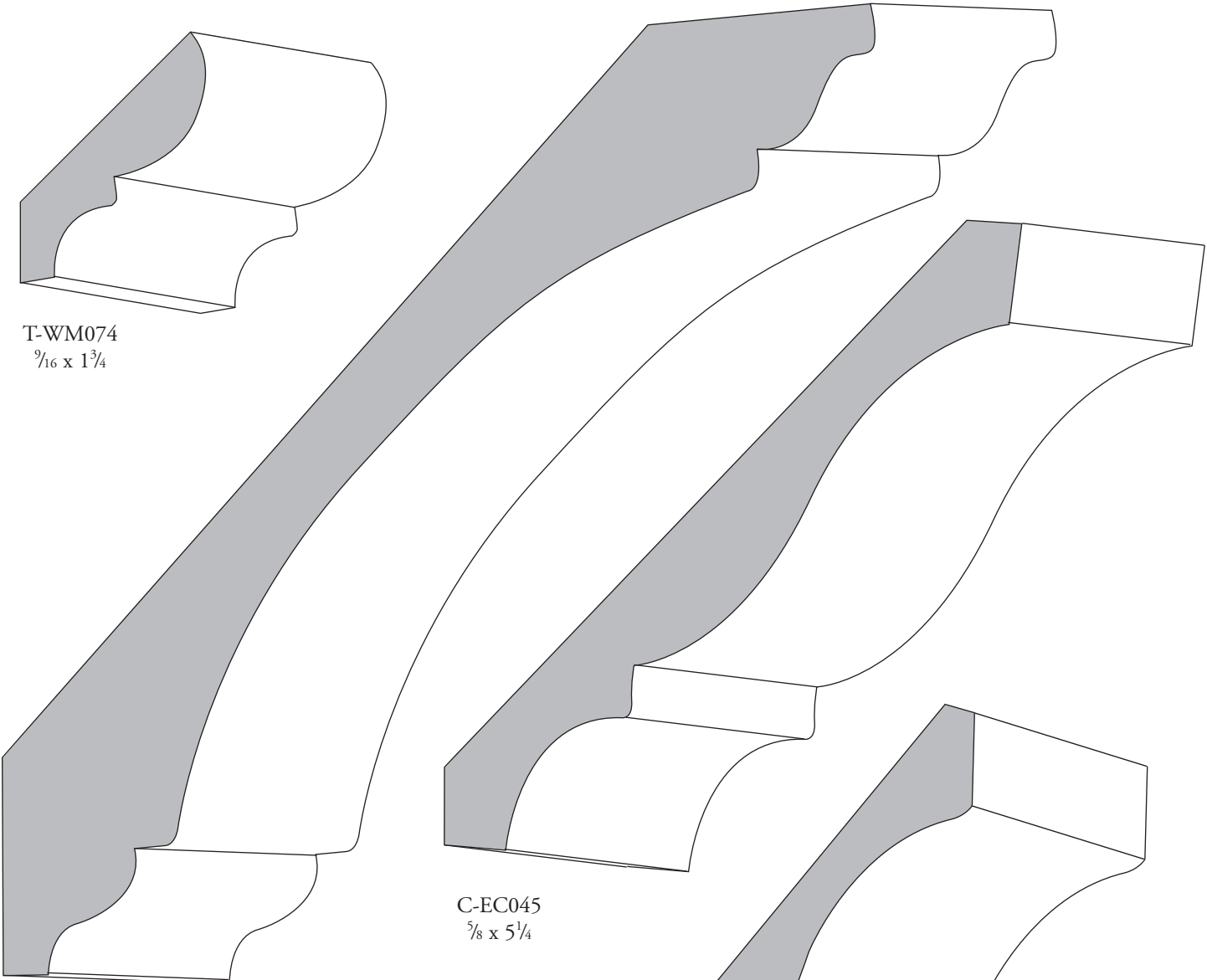

C-MD513
 $1\frac{1}{8} \times 8$

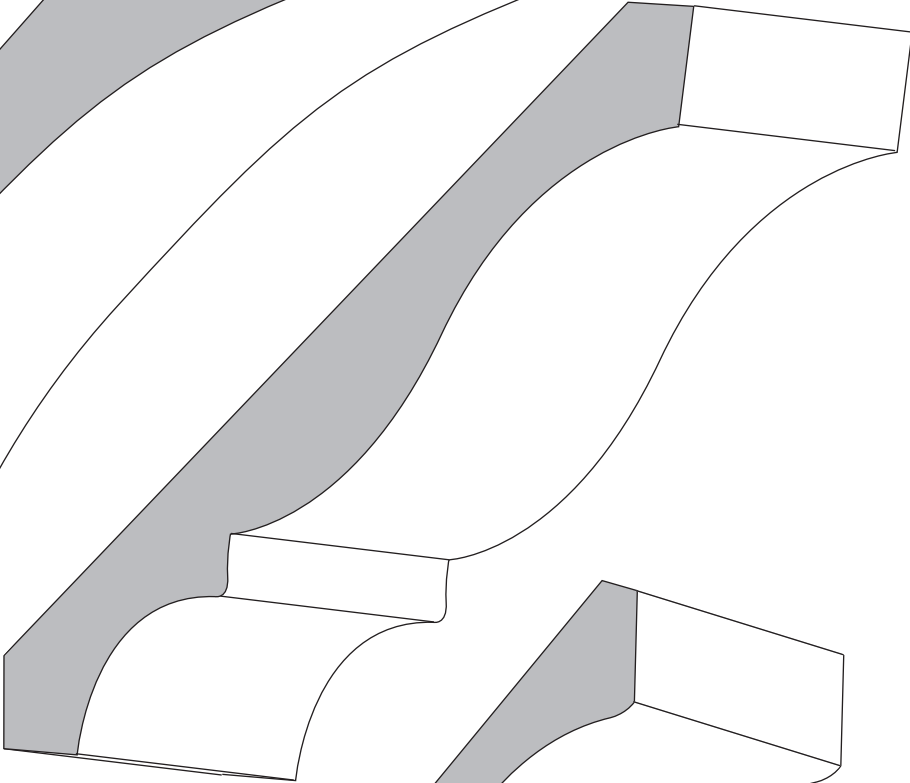

C-EC045
 $\frac{5}{8} \times 5\frac{1}{4}$

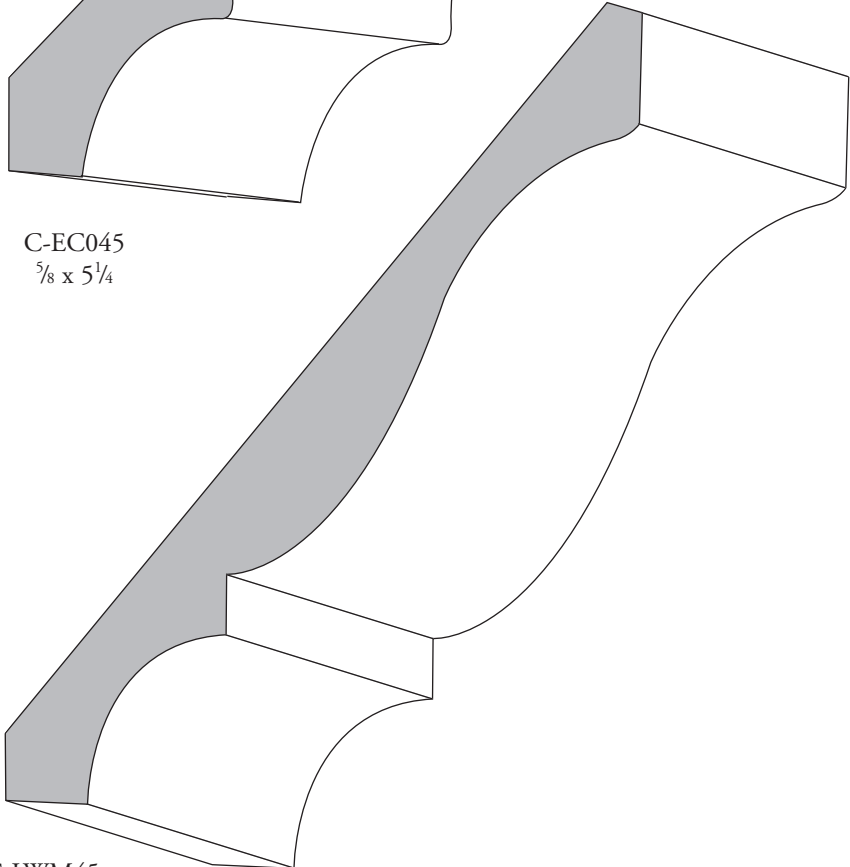

C-LWM45
 $\frac{9}{16} \times 5\frac{1}{4}$



CROWN

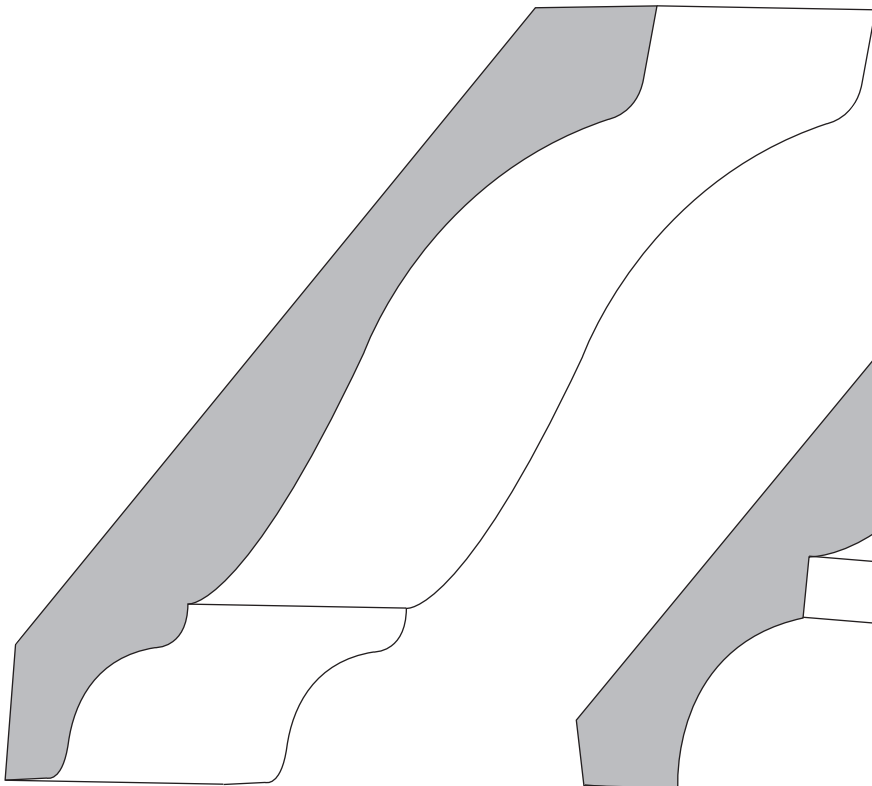

C-45FJ
 $\frac{5}{8} \times 5\frac{1}{4}$

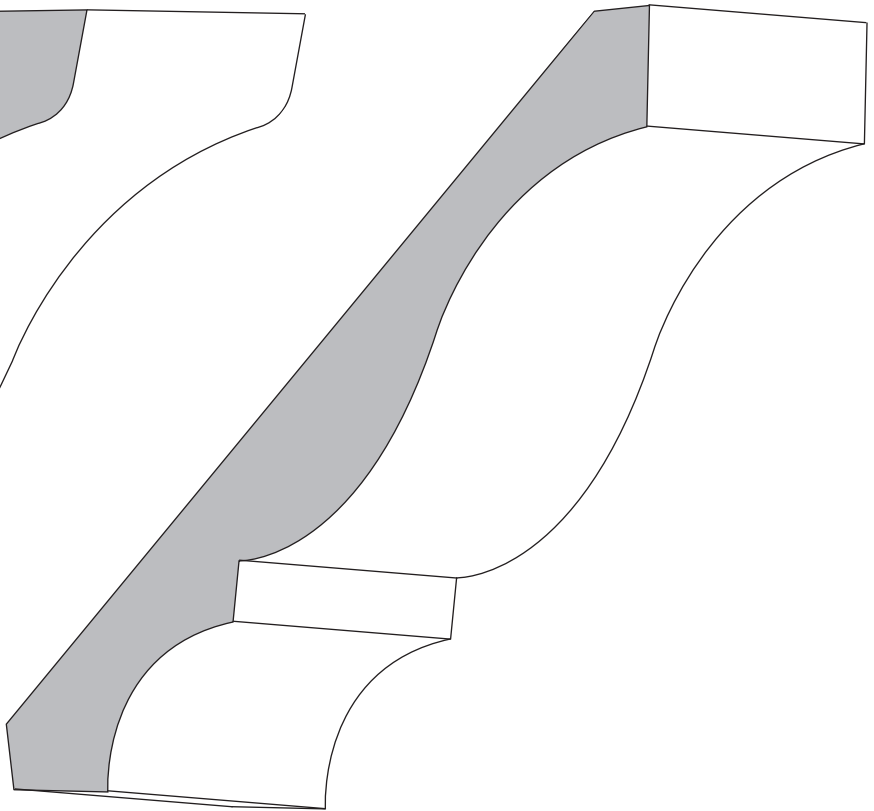

C-45M
 $\frac{5}{8} \times 5\frac{1}{4}$

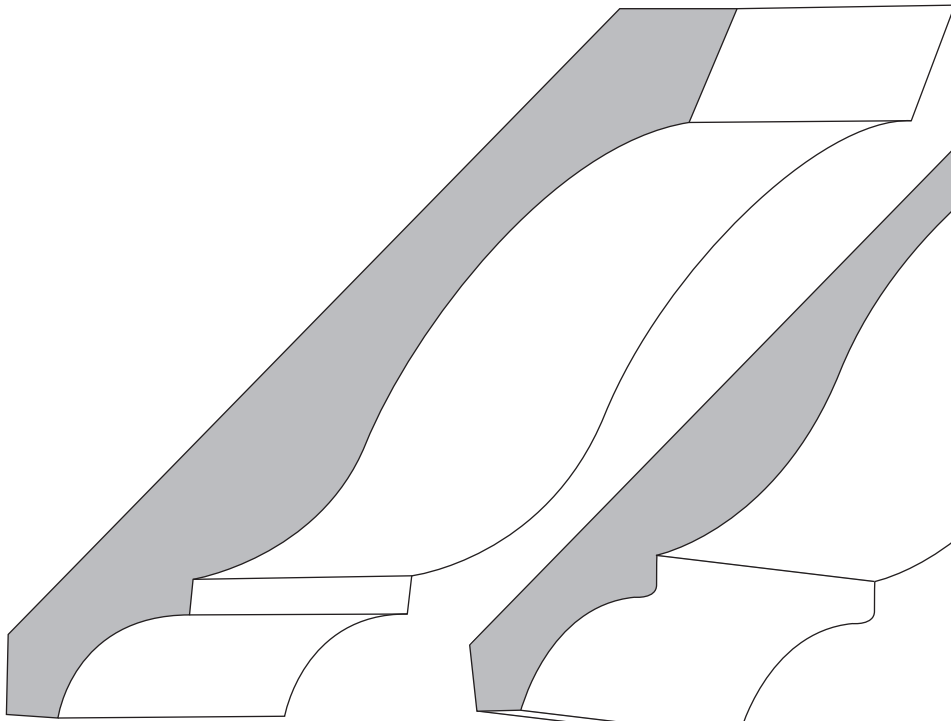

T-WM045
 $\frac{9}{16} \times 5\frac{1}{4}$

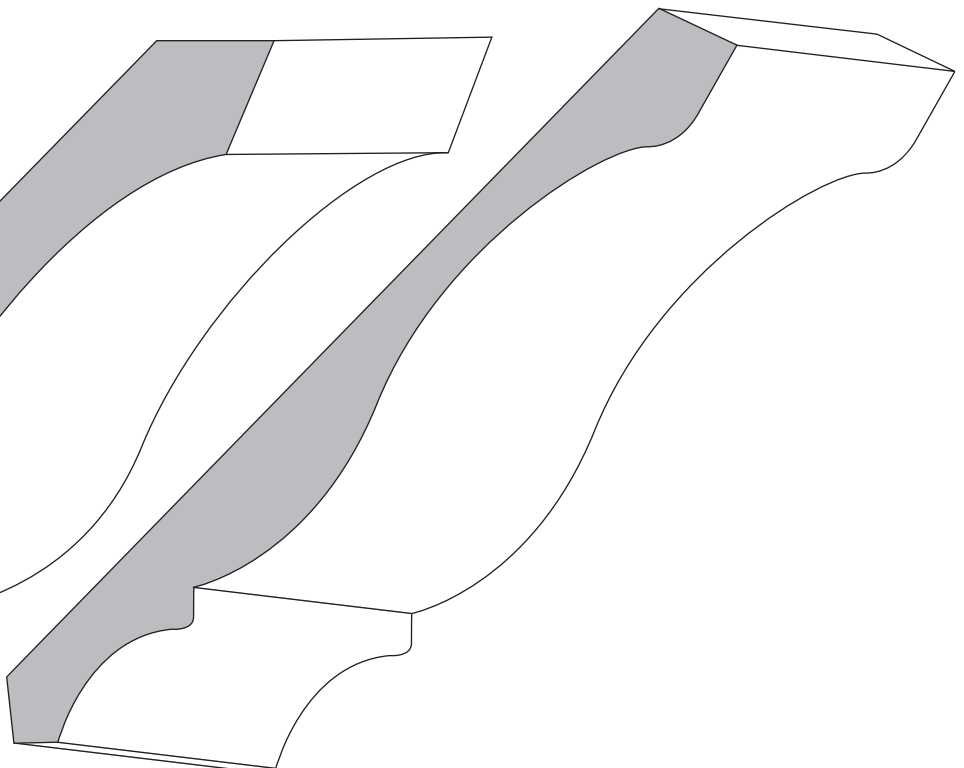

C-LSM46
 $\frac{1}{2} \times 5\frac{1}{4}$

CROWN

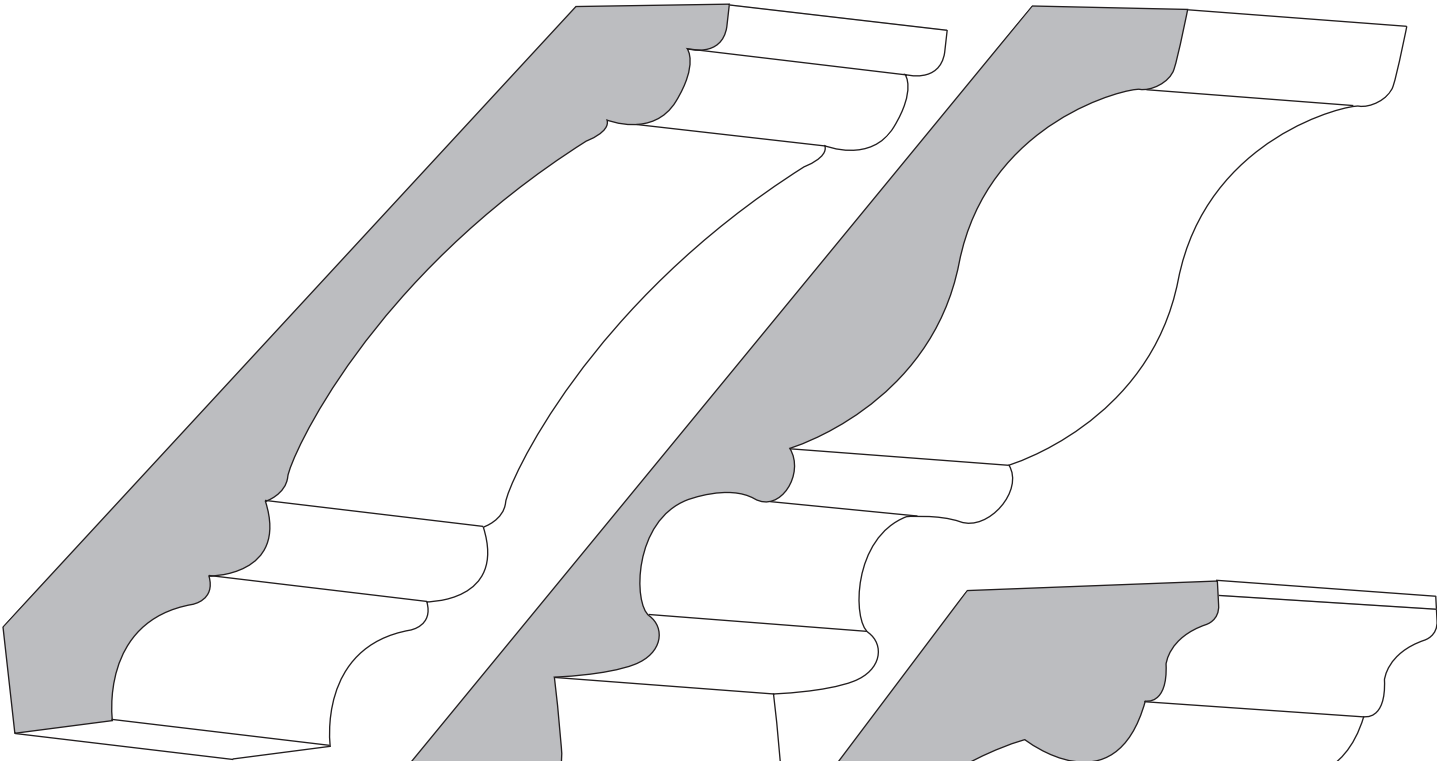

C-MD655
 $\frac{3}{4} \times 5\frac{1}{4}$

C-MDF42
 $1\frac{1}{16} \times 7$

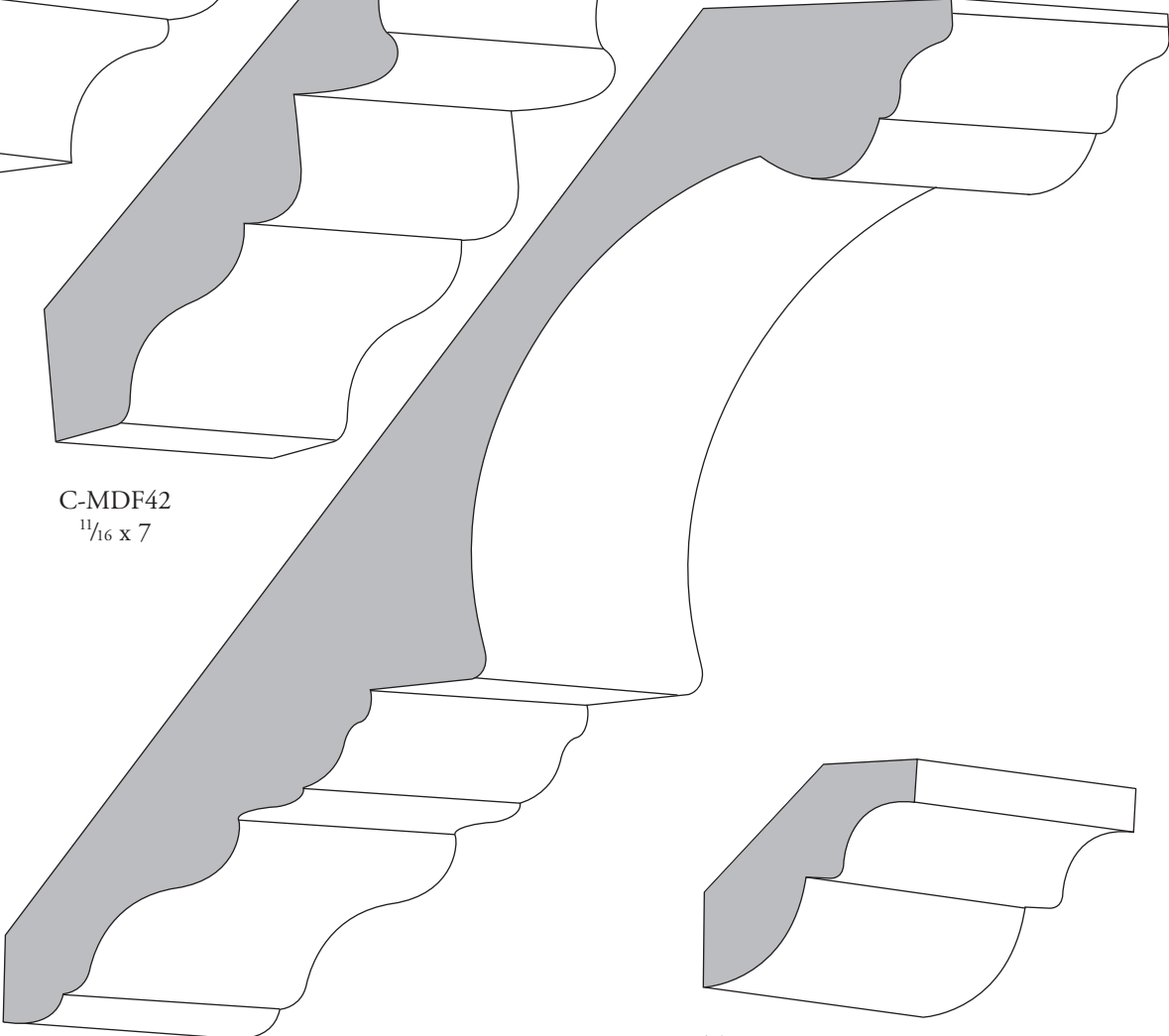

C-LG562
 $1\frac{1}{4} \times 7\frac{1}{4}$

T-WM075
 $\frac{9}{16} \times 1\frac{5}{8}$



CROWN

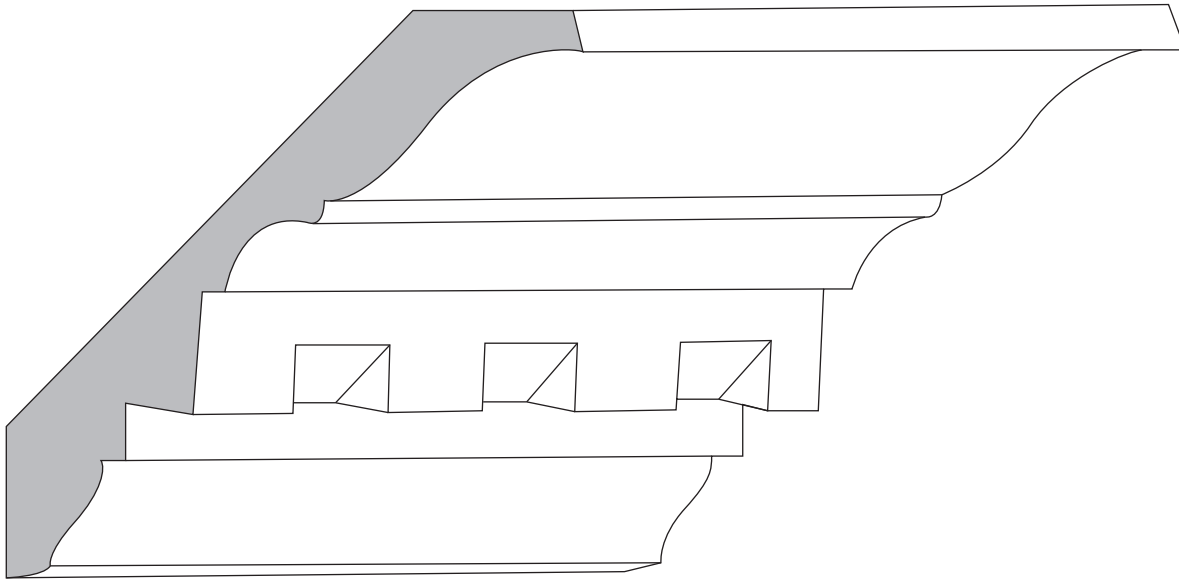

C-RL425
 $\frac{3}{4} \times 4\frac{1}{4}$

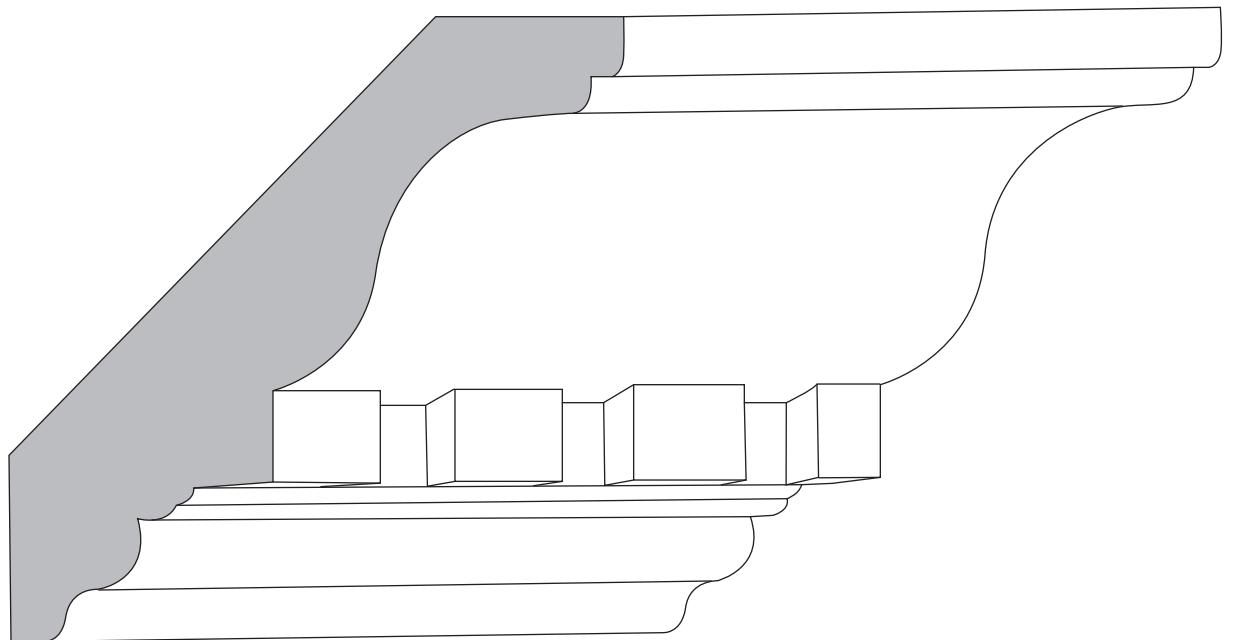

C-MD012
 $1\frac{1}{16} \times 4\frac{1}{2}$

CROWN

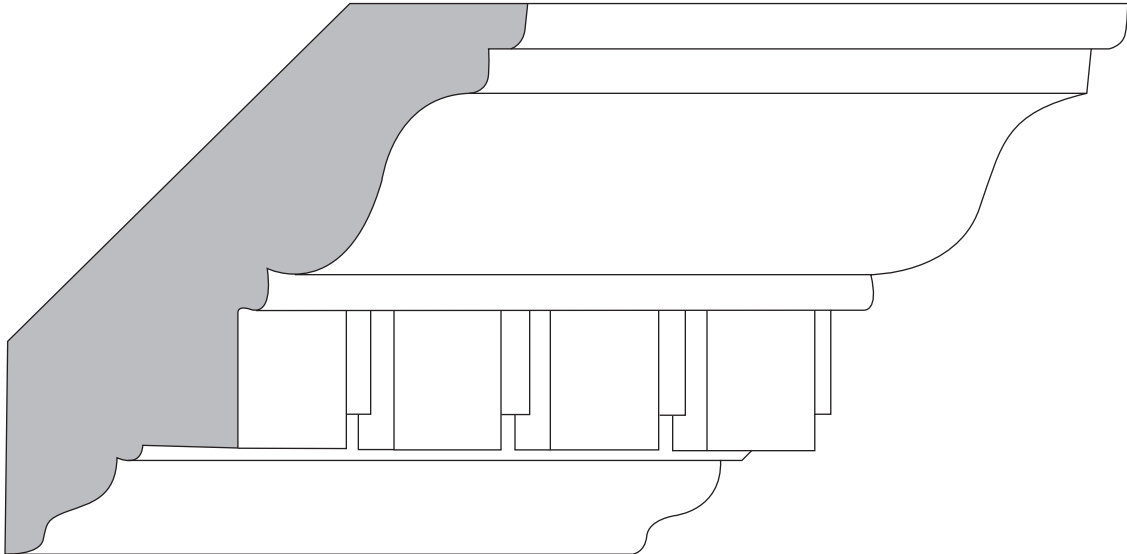

C-RR205
1³/₁₆ x 3⁷/₈

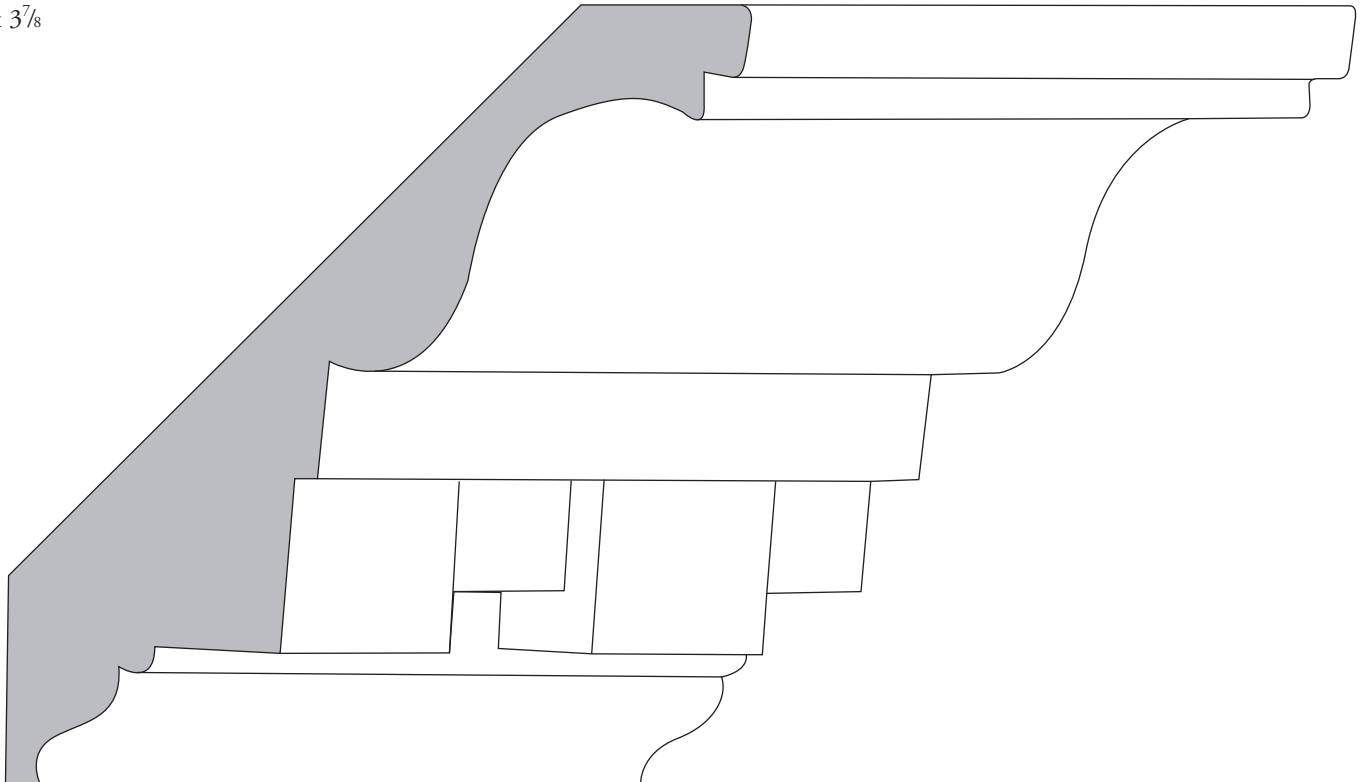

C-RR201
1¹/₄ x 5¹/₂

CROWN

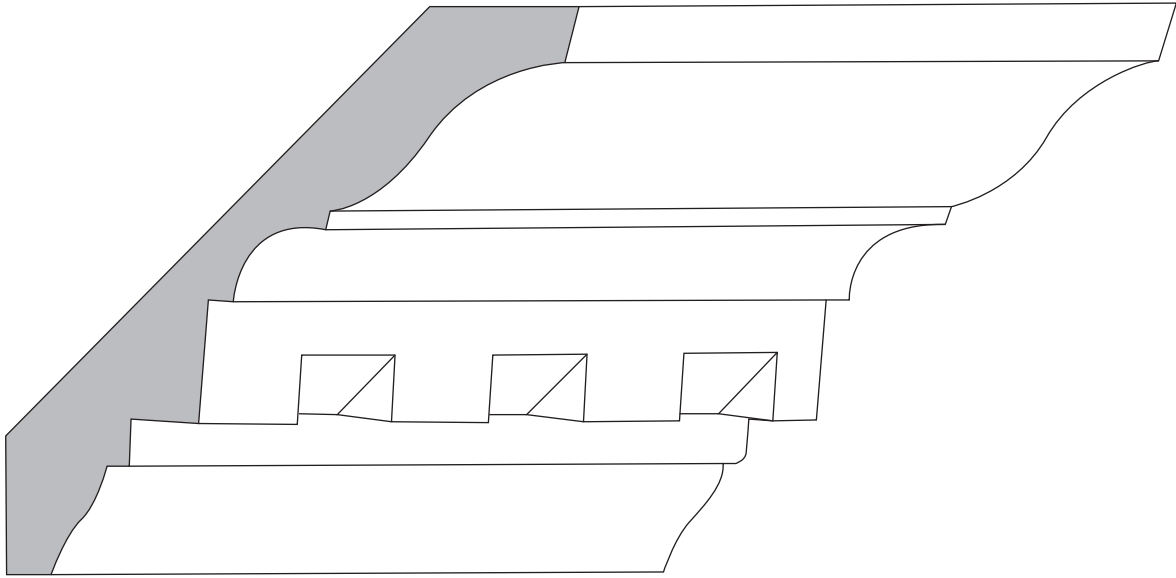

C-SS425
 $\frac{5}{8} \times 4\frac{1}{4}$

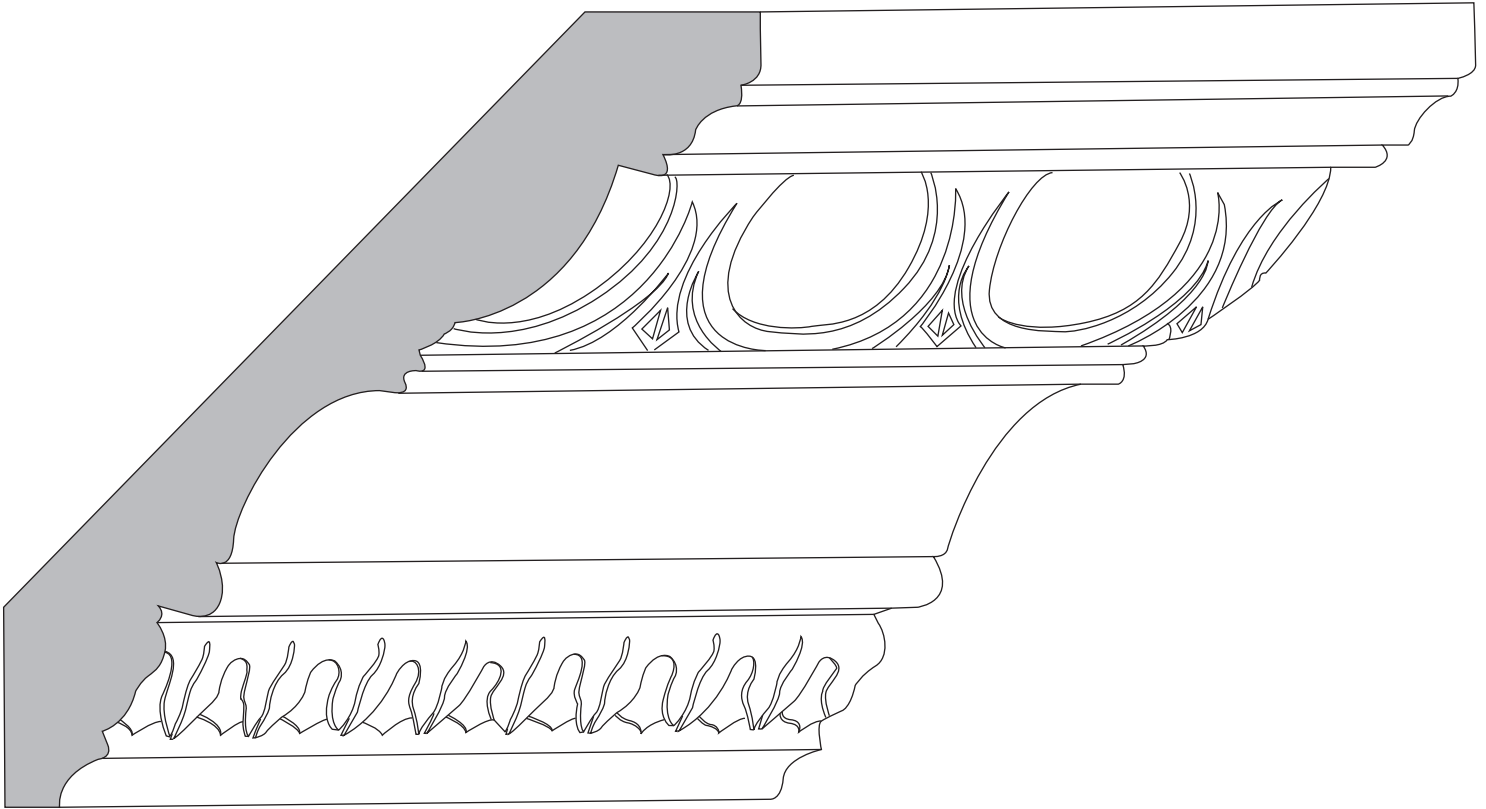

C-RR210
 $\frac{7}{8} \times 5\frac{3}{4}$

COVE

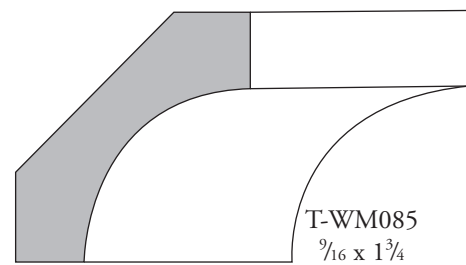
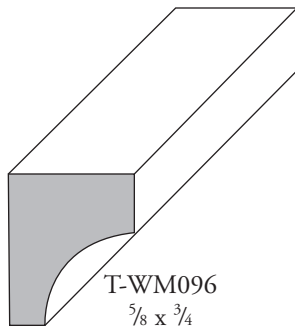
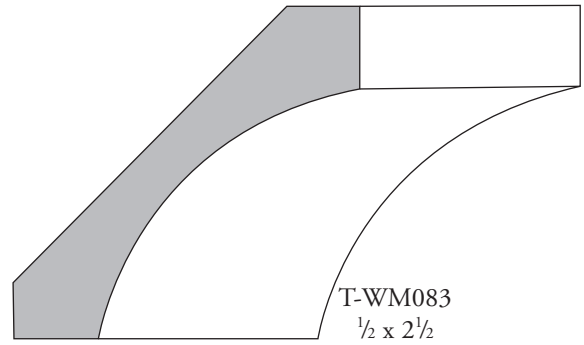
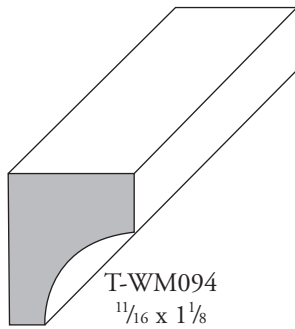
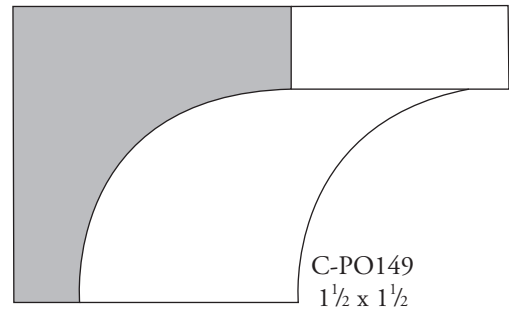
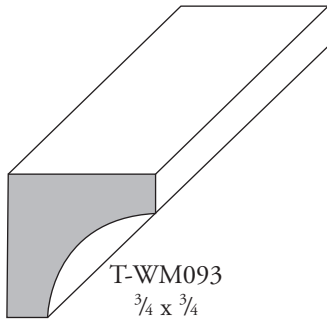
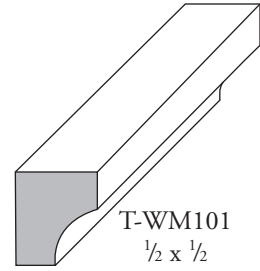
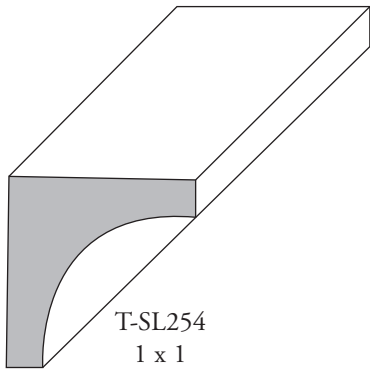

RABBETED PANEL

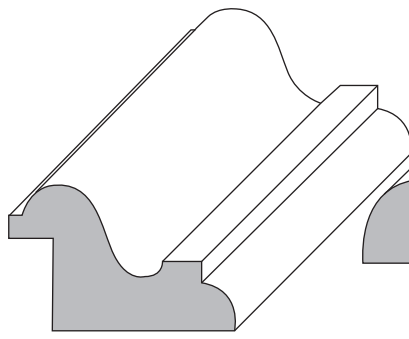

T-SL424
3/4 x 1 1/4

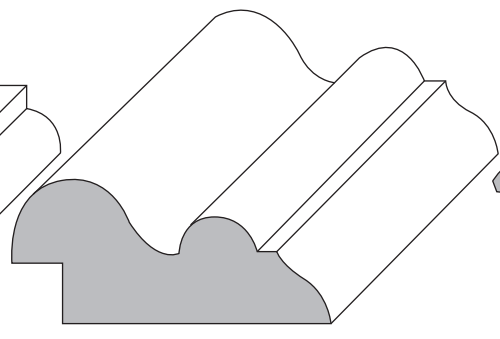

C-EMS58
3/4 x 1 5/8

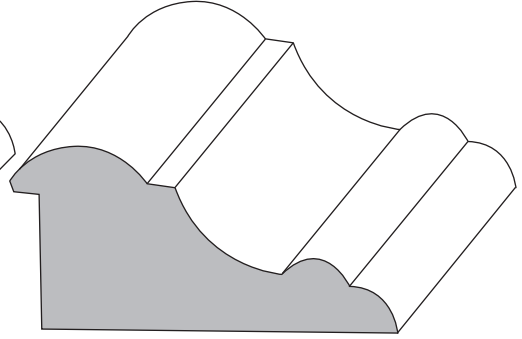

C-ST134
1 x 2

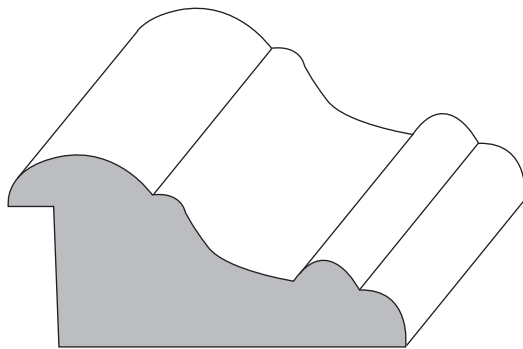

C-5103
1 x 2

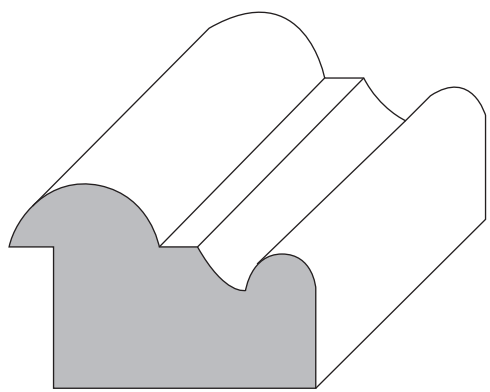

C-RB42
1 1/16 x 1 1/2

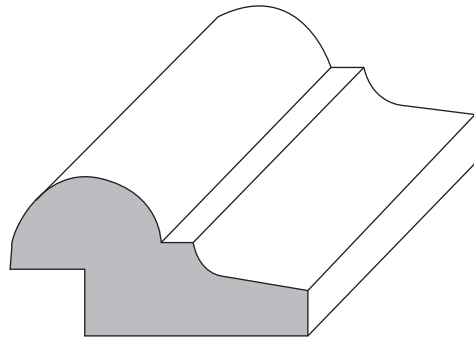

C-PO150
1 3/16 x 1 1/2

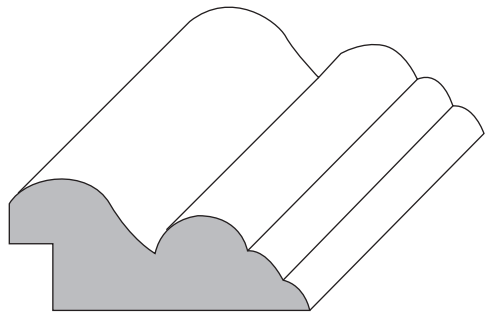

C-NJ236
5/8 x 1 1/2

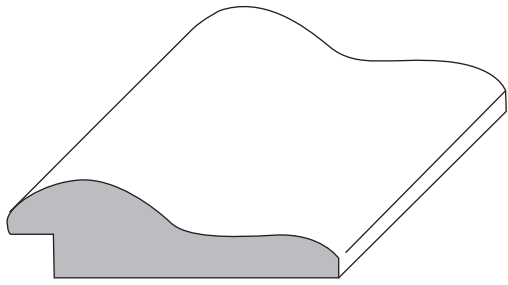

C-Q2010
1/2 x 1 3/4

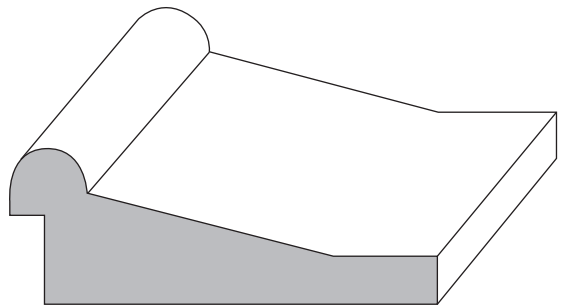

C-214PR
3/4 x 2 1/4



PANEL

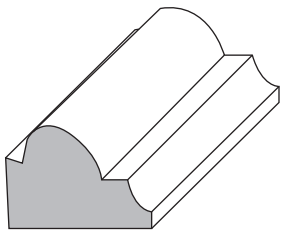

T-SL401
1/2 x 3/4

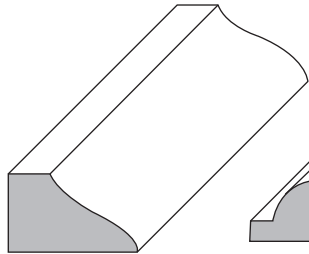

C-RRL06
3/8 x 5/8

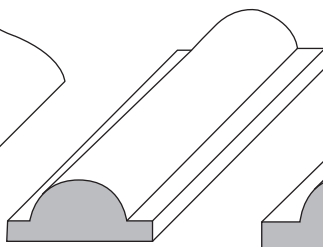

C-TH075
5/16 x 3/4

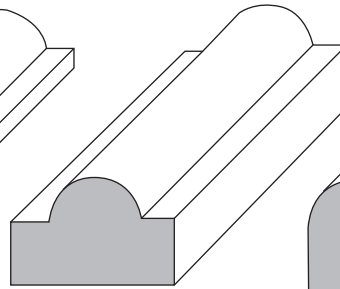

C-TH080
9/16 x 7/8

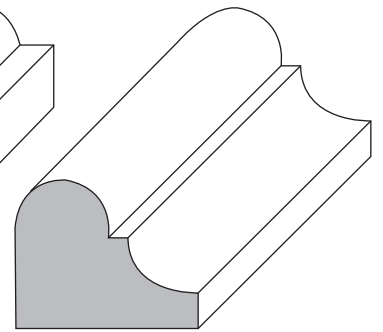

C-GM13
3/4 x 1

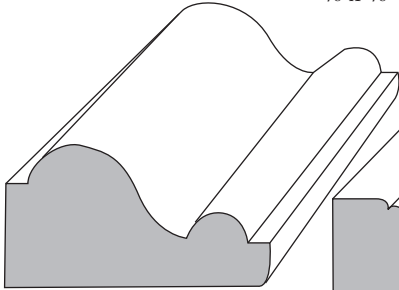

C-35955
11/16 x 1 5/16

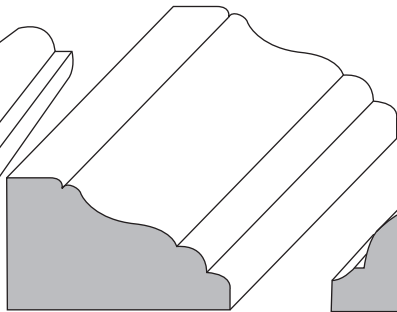

C-RRL07
5/8 x 1 1/8

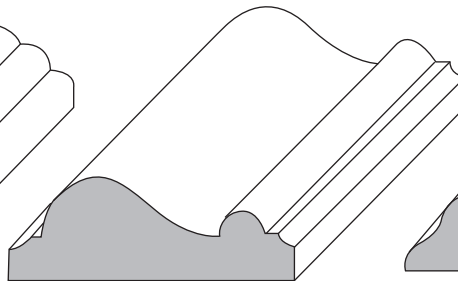

C-PS112
1/2 x 1 1/2

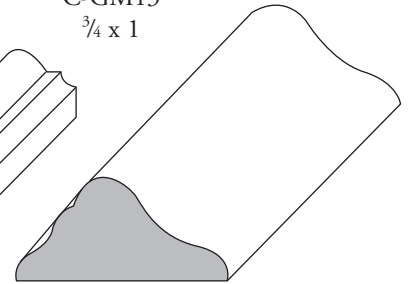

T-WM183
1/2 x 1 1/8

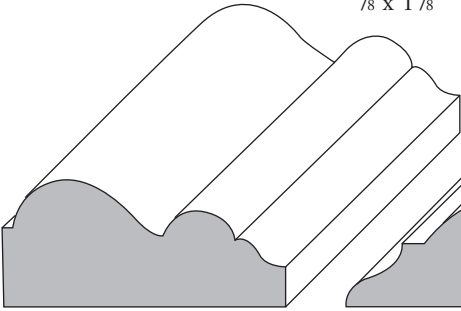

C-NJ232
11/16 x 1 3/8

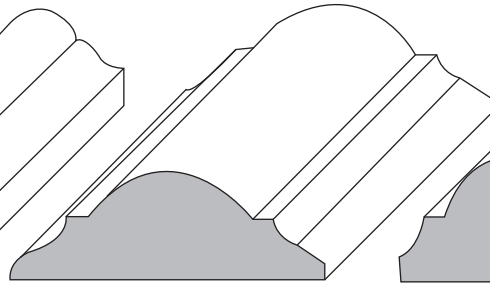

C-NJ425
1/2 x 1 5/8

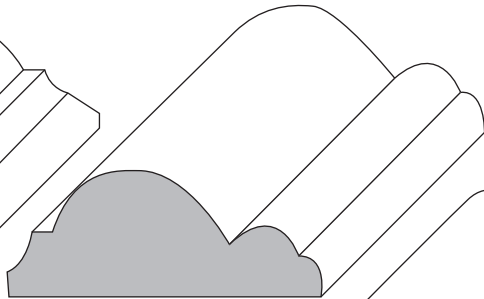

C-NJ918
11/16 x 1 5/8

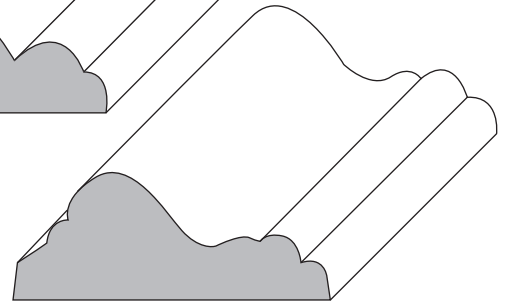

C-P8030
5/8 x 1 5/8

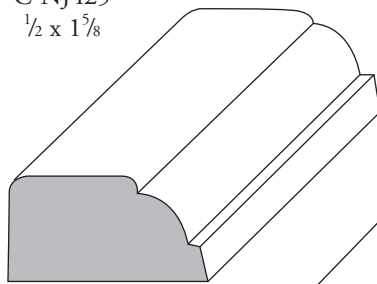

C-P9050
1/2 x 1



C-PO118
1 x 1 1/8

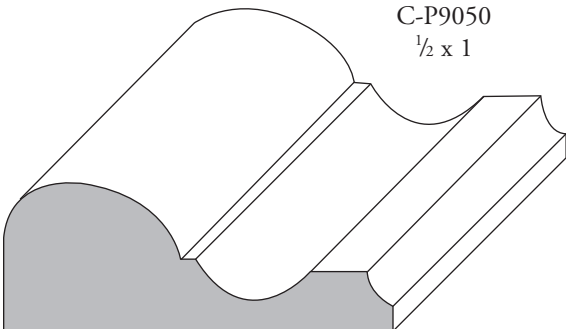

C-PM250
3/4 x 2

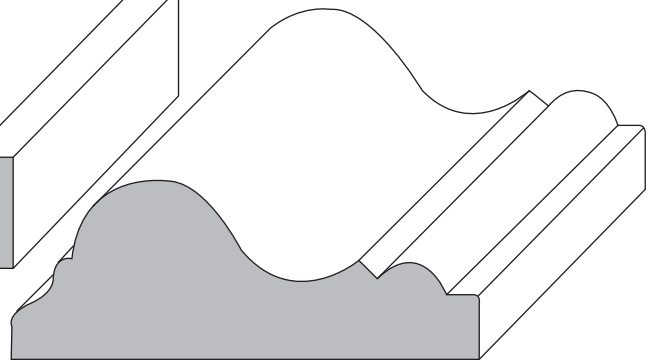

C-P8020
15/16 x 2 3/8

CHAIR RAIL

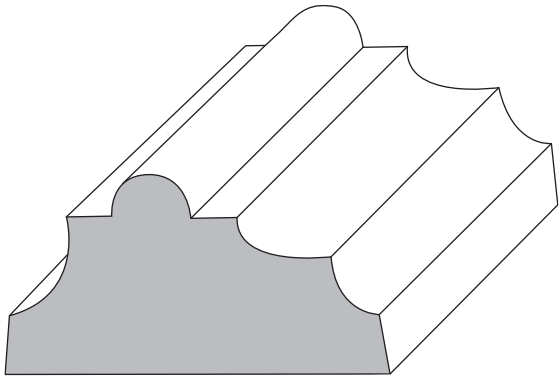

C-P9040
1 x 2

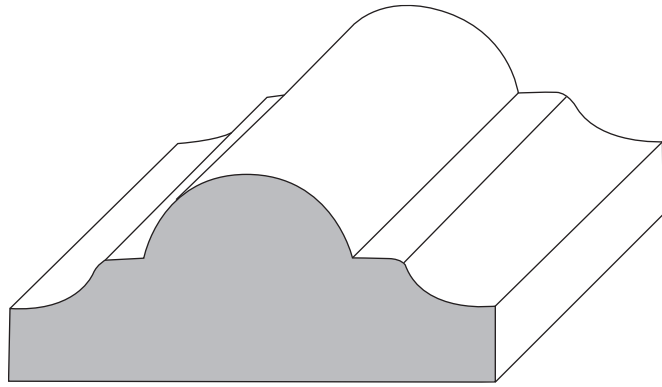

C-BO136
1¹/₁₆ x 2¹/₂

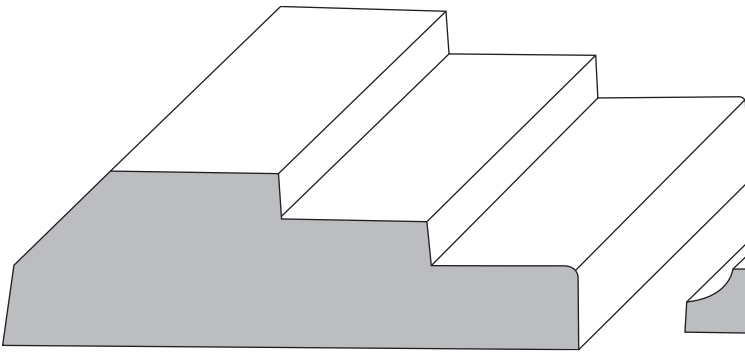

C-P7070
7⁷/₈ x 3

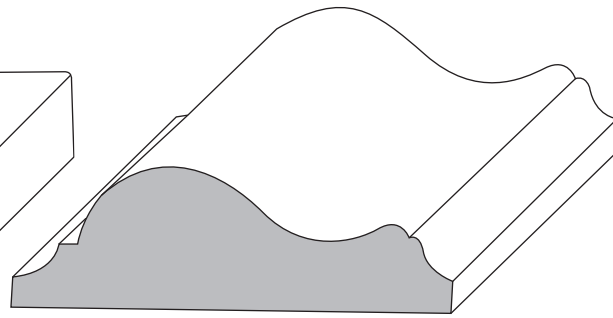

C-PM510
3³/₄ x 2¹/₄

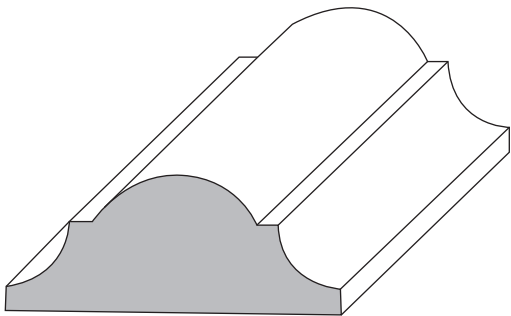

T-SL101
3³/₄ x 1³/₄

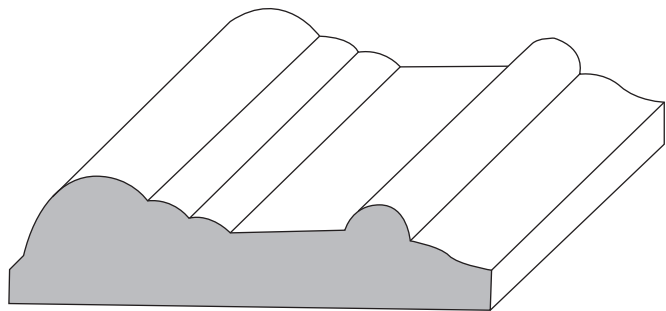

C-RLC10
1¹/₁₆ x 2¹/₂

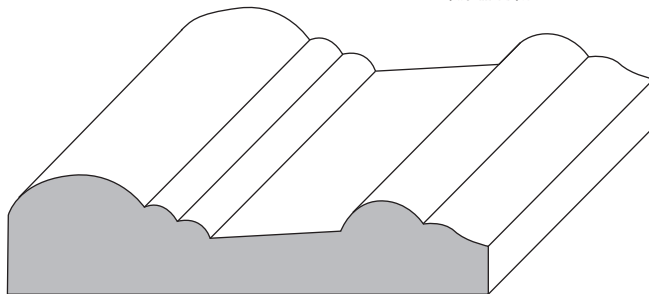

T-SL207
3³/₈ x 2¹/₂

CHAIR RAIL

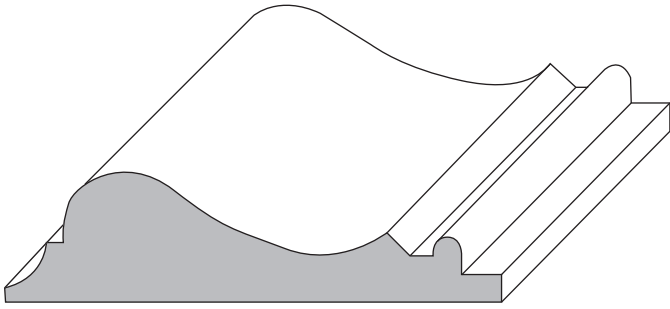

T-WM390
1¹/₁₆ x 2⁵/₈

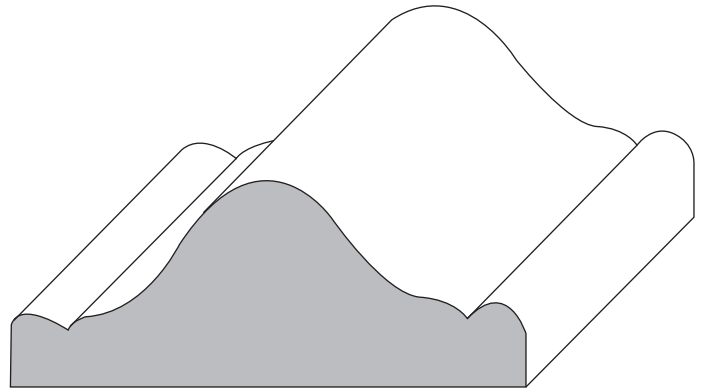

T-WM302
1¹/₁₆ x 2³/₄

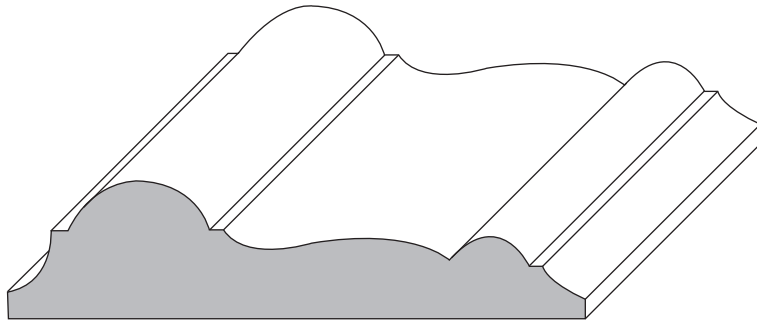

T-WM297
1¹/₁₆ x 3

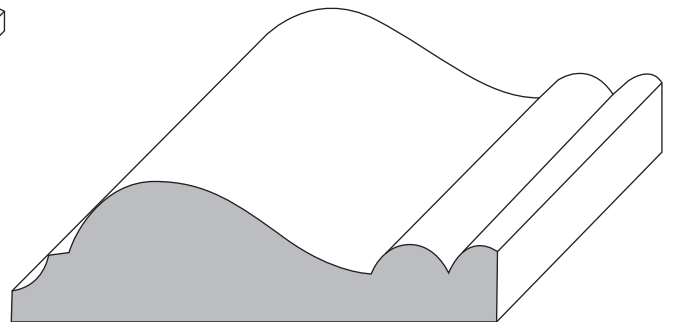

C-R242U
1¹/₁₆ x 2¹/₂

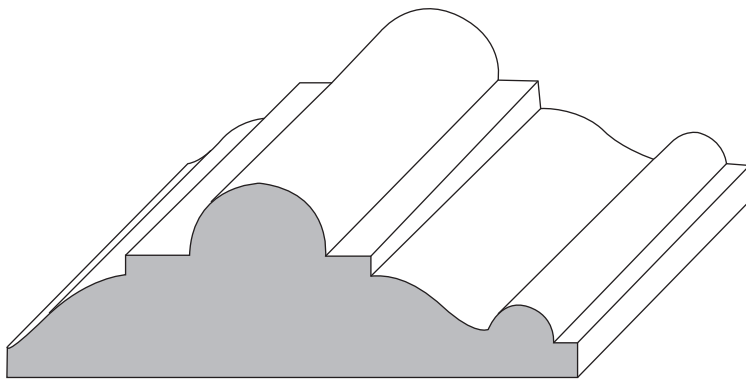

T-WM300
1 x 3

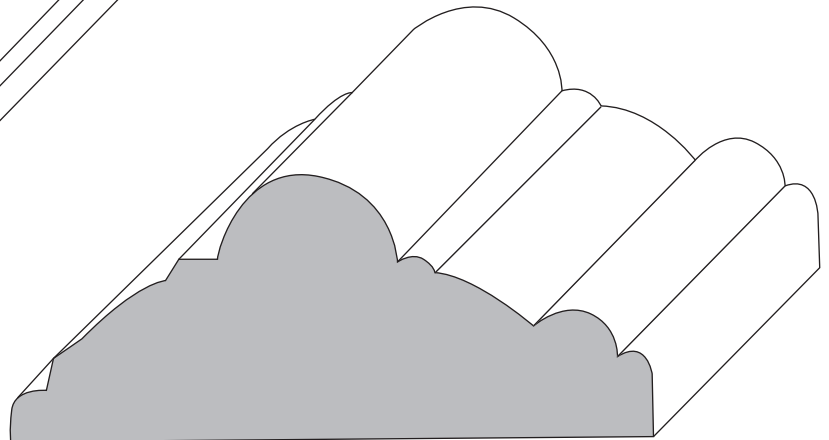

C-CT325
1³/₈ x 3⁷/₁₆

CHAIR RAIL

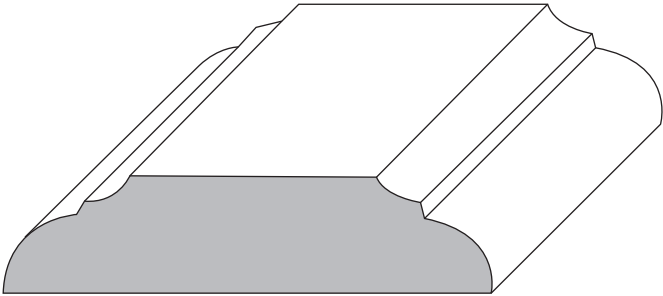

T-SL231
 $\frac{9}{16} \times 2\frac{1}{2}$

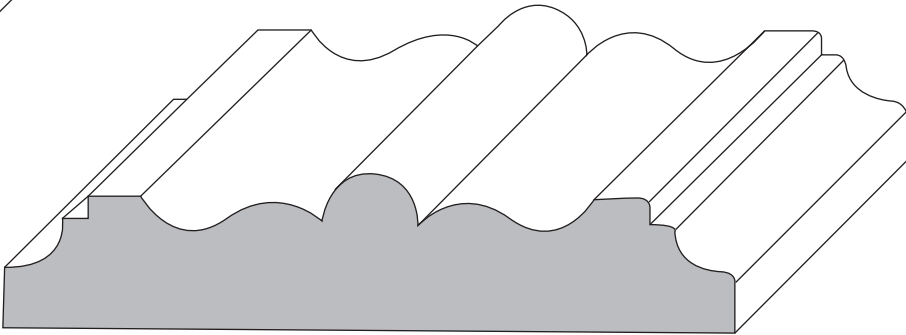

C-P9020
 $\frac{13}{16} \times 3\frac{3}{4}$

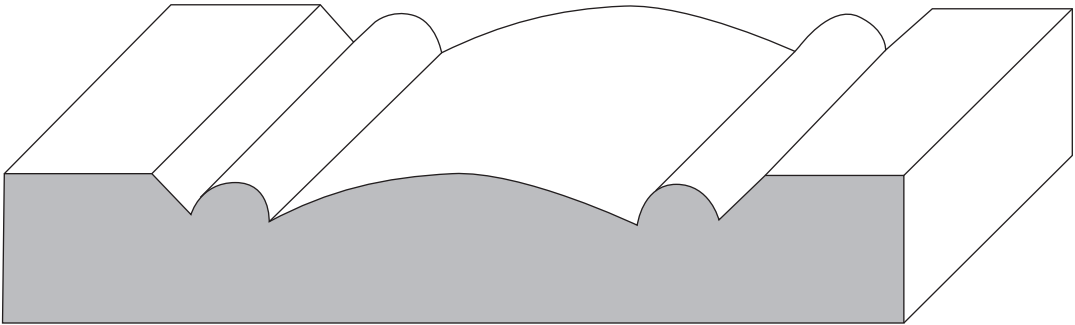

C-ES12P
 $\frac{3}{4} \times 4\frac{5}{8}$

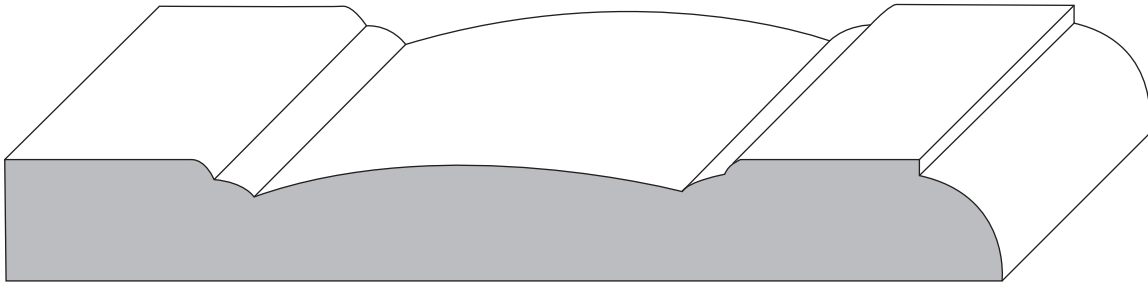

C-BA518
 $\frac{5}{8} \times 5\frac{1}{8}$

CHAIR RAIL

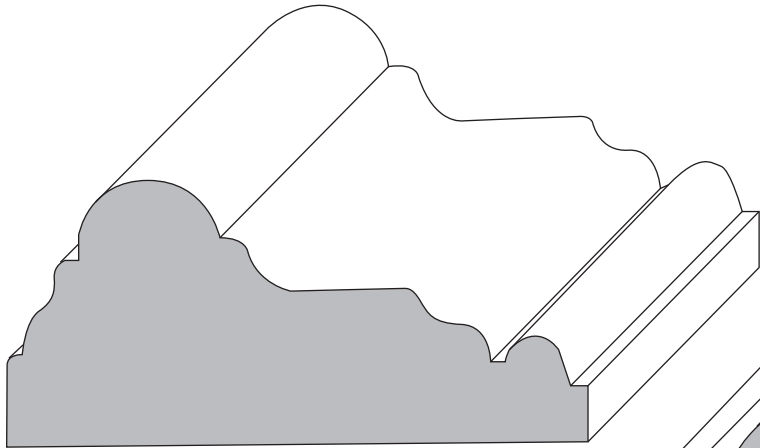

C-SI540
1 5/16 x 3

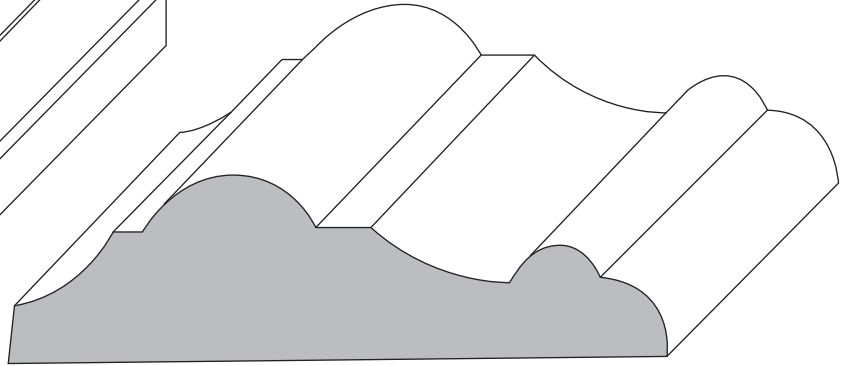

C-AH397
1 1/8 x 3 3/8

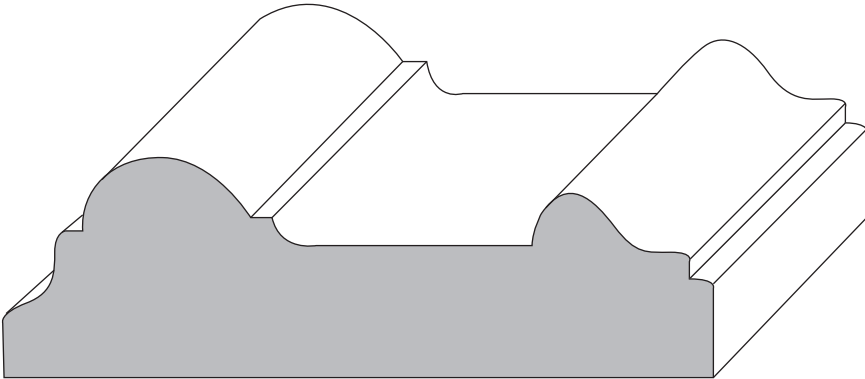

C-P9010
1 1/8 x 3 5/8

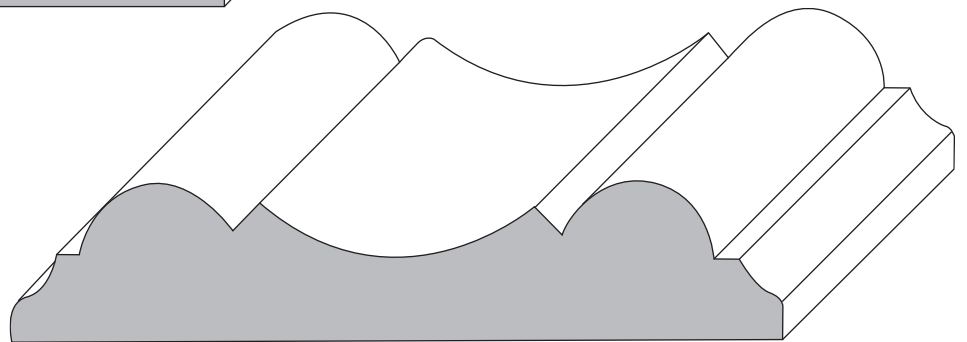

C-P8040
3/4 x 4

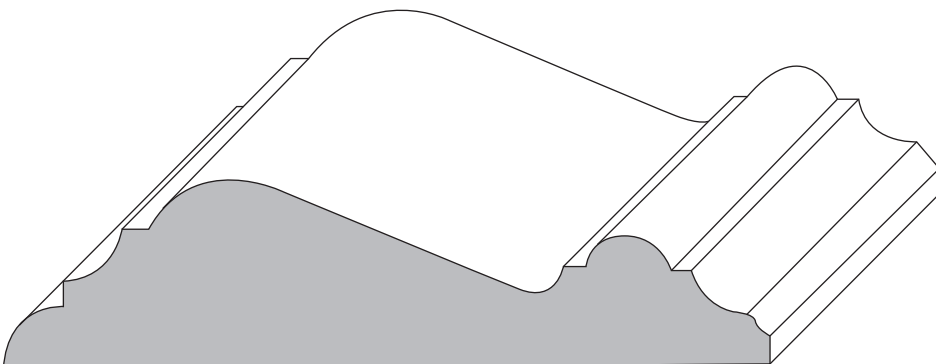

C-DS401
1 x 4

CHAIR RAIL BACKER

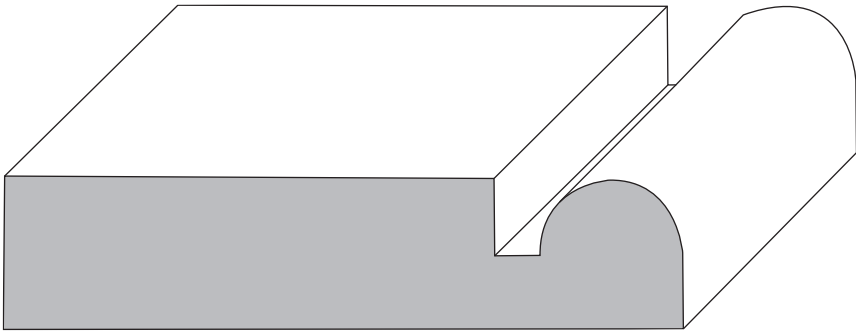

C-SM231
 $\frac{3}{4} \times 3\frac{1}{2}$

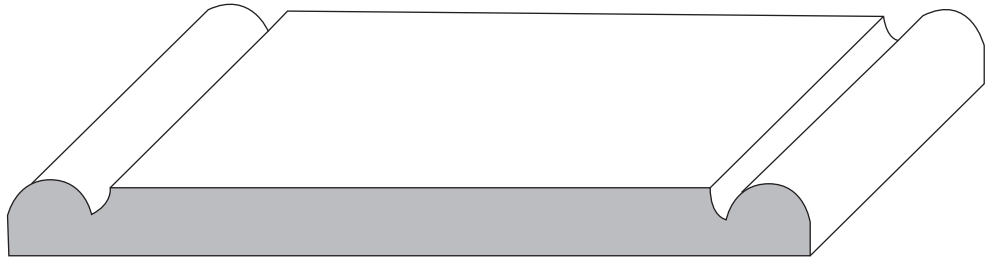

C-LO425
 $\frac{3}{8} \times 4\frac{1}{8}$

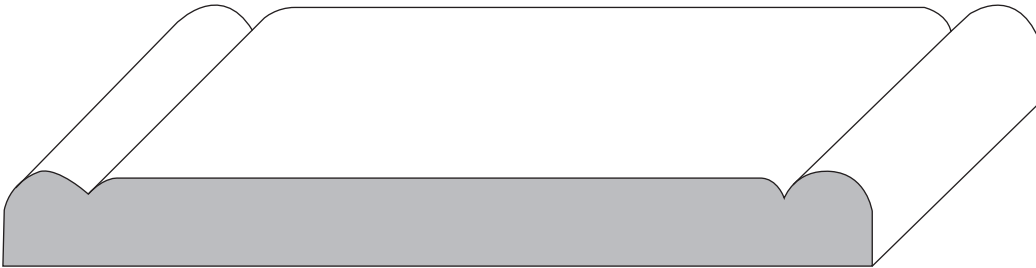

C-BO135
 $\frac{1}{2} \times 4\frac{1}{2}$

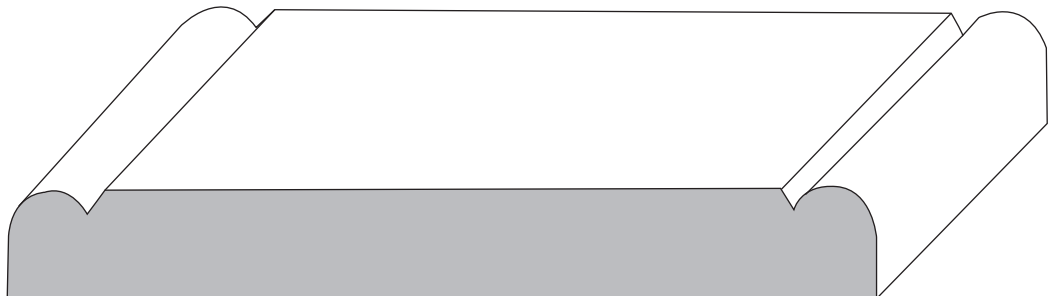

C-SM304
 $\frac{5}{8} \times 4\frac{1}{2}$

CHAIR RAIL BACKER



C-SE13
 $\frac{3}{4} \times 5\frac{1}{2}$

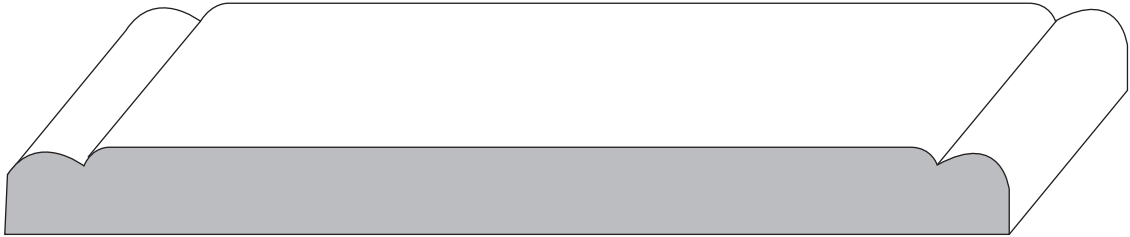

C-AH398
 $\frac{1}{2} \times 5\frac{1}{4}$

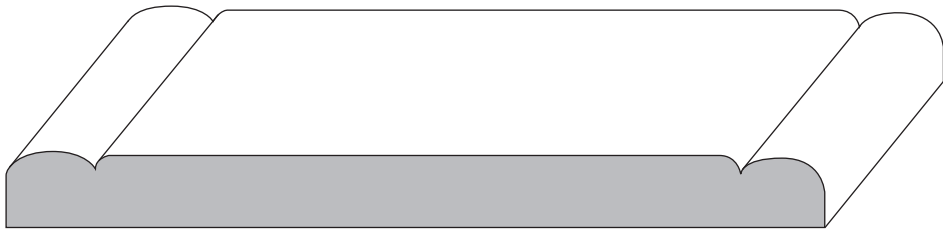

T-WM956
 $\frac{3}{8} \times 4\frac{1}{4}$

HALF ROUND / QUARTER ROUND

HALF ROUND

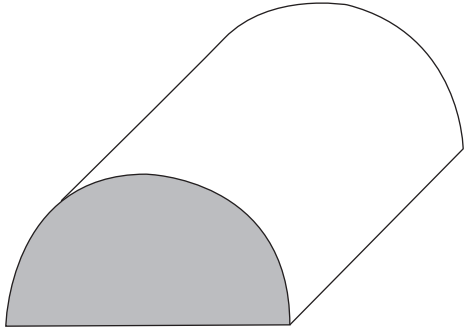

C-NJ714
 $\frac{3}{4} \times 1\frac{1}{2}$

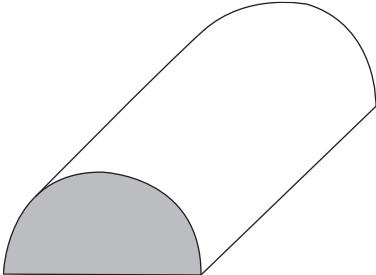

T-WM120
 $\frac{1}{2} \times 1$

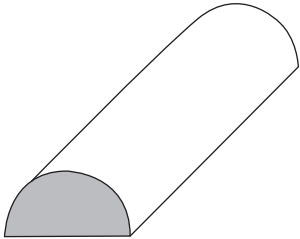

T-WM123
 $\frac{5}{16} \times \frac{5}{8}$

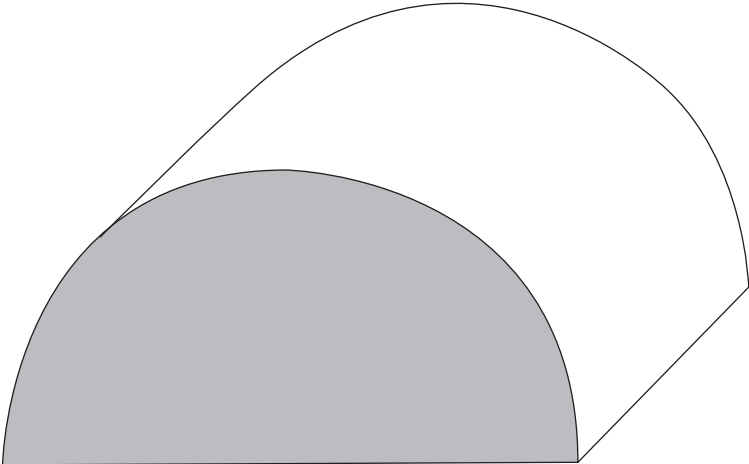

T-1.5 x 3
 $1\frac{1}{2} \times 3$

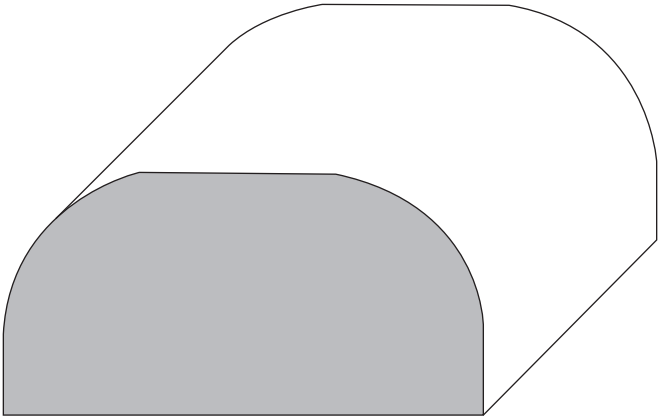

C-SM250
 $1\frac{1}{4} \times 2\frac{1}{2}$

QUARTER ROUND

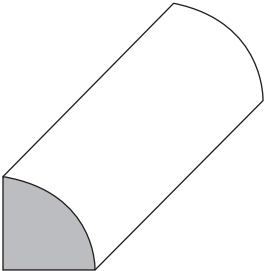

T-WM108
 $\frac{1}{2} \times \frac{1}{2}$

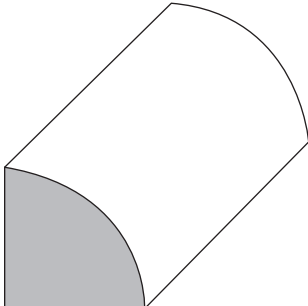

T-WM105
 $\frac{3}{4} \times \frac{3}{4}$

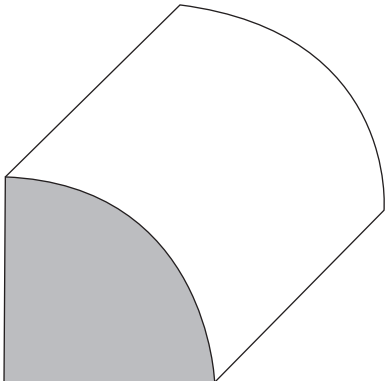

T-WM103
 $1\frac{1}{16} \times 1\frac{1}{16}$

MISCELLANEOUS

STOP

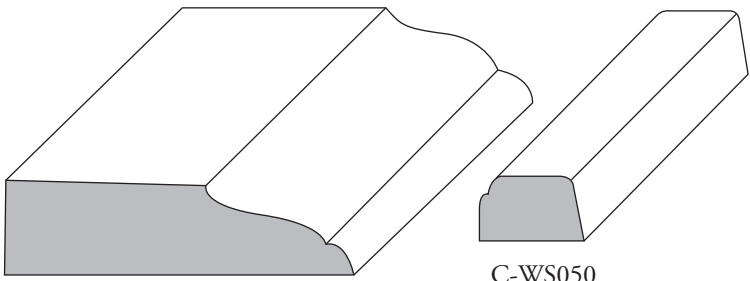

T-SL303
1/2 x 1 3/4

C-WS050
3/8 x 1/2

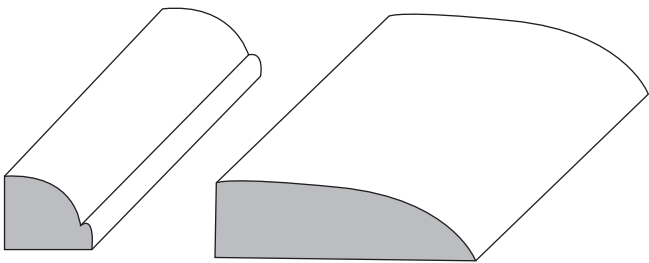

C-WS045
3/8 x 1/2

T-WM826
3/8 x 1 3/8

SHINGLE

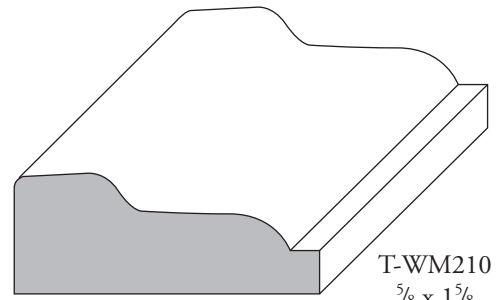

T-WM210
5/8 x 1 5/8

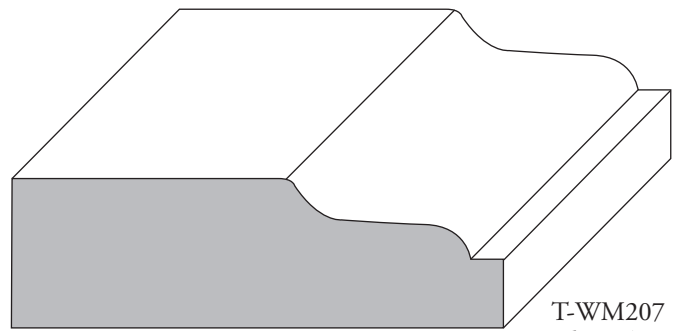

T-WM207
5/8 x 2 1/2

DENTIL

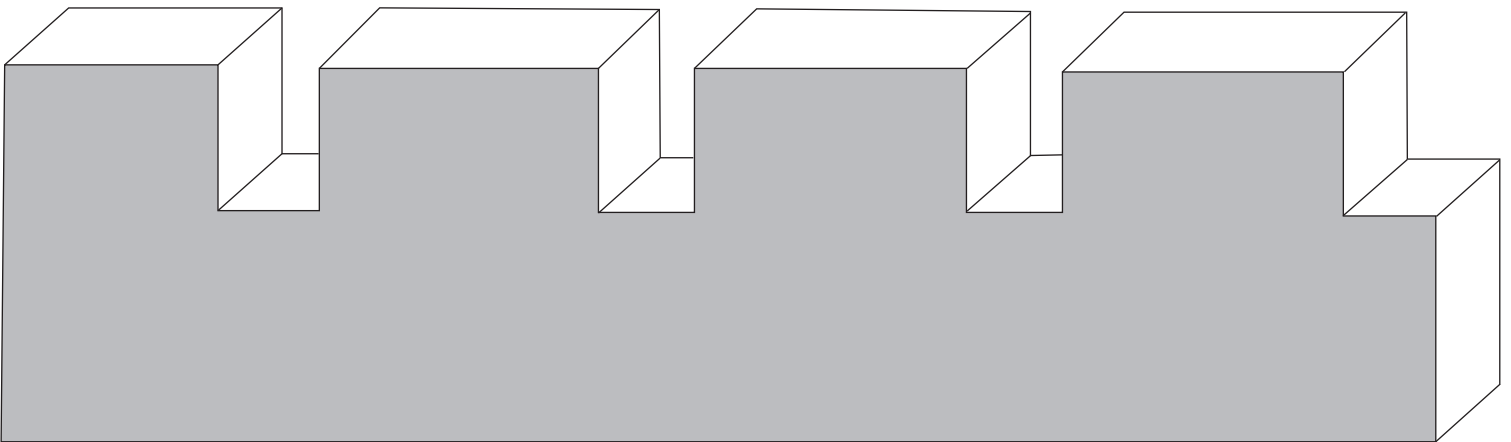

C-DN200
1/2 x 2

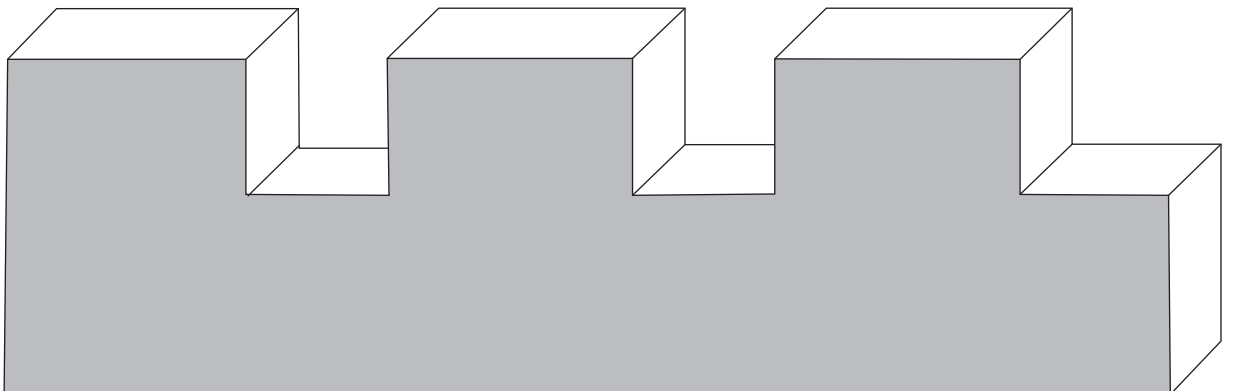

C-DN175
1/2 x 1 3/4

MISCELLANEOUS

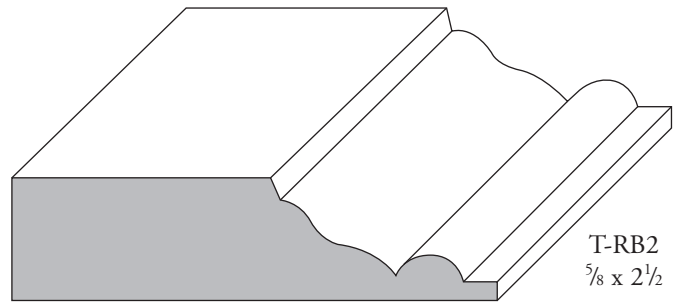
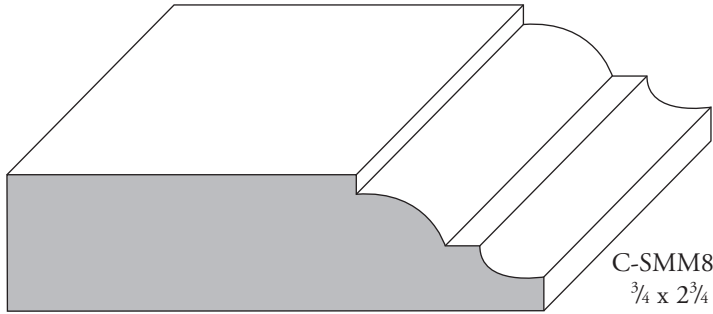

APRON

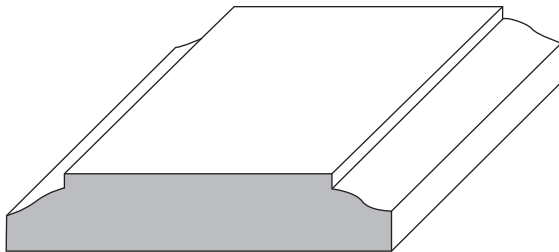
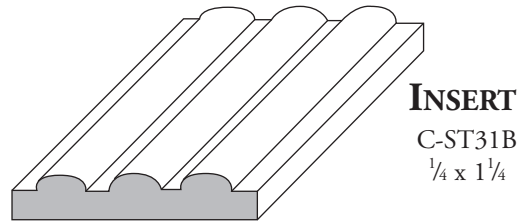
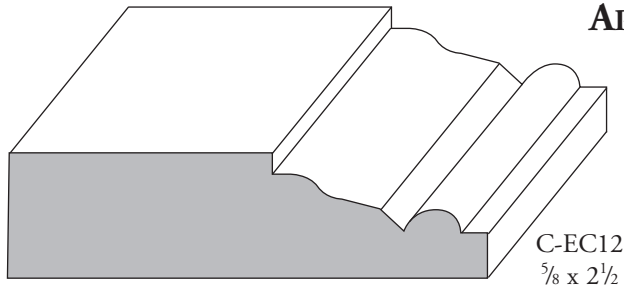

MULLION

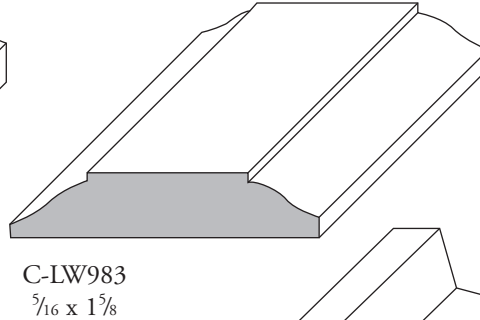

DRIP CAP

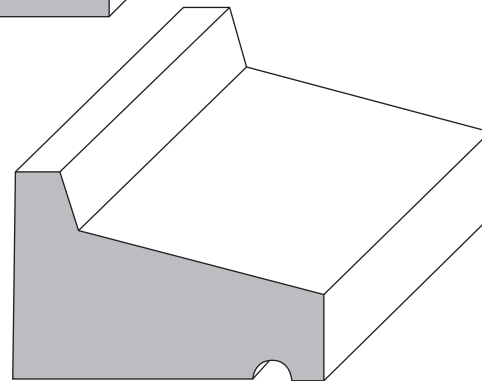

OUTSIDE CORNERS

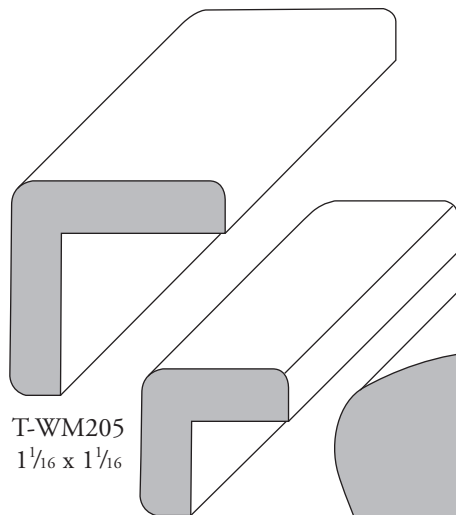

HAND RAIL

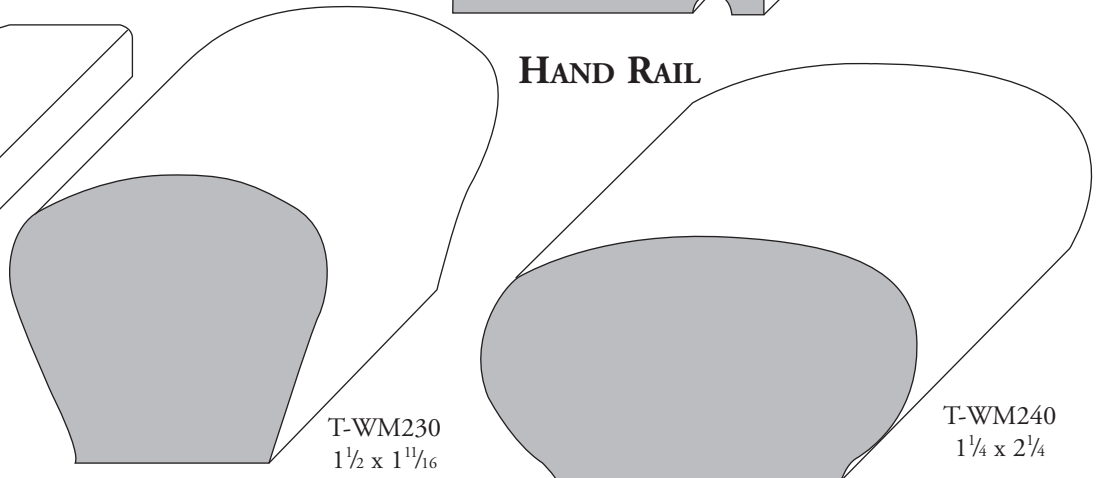

MISCELLANEOUS

RADIUS BASE CORNERS

Custom Radius Base Corners are designed to be used on $\frac{3}{4}$ " radius drywall corners and are available for any base profile desired.

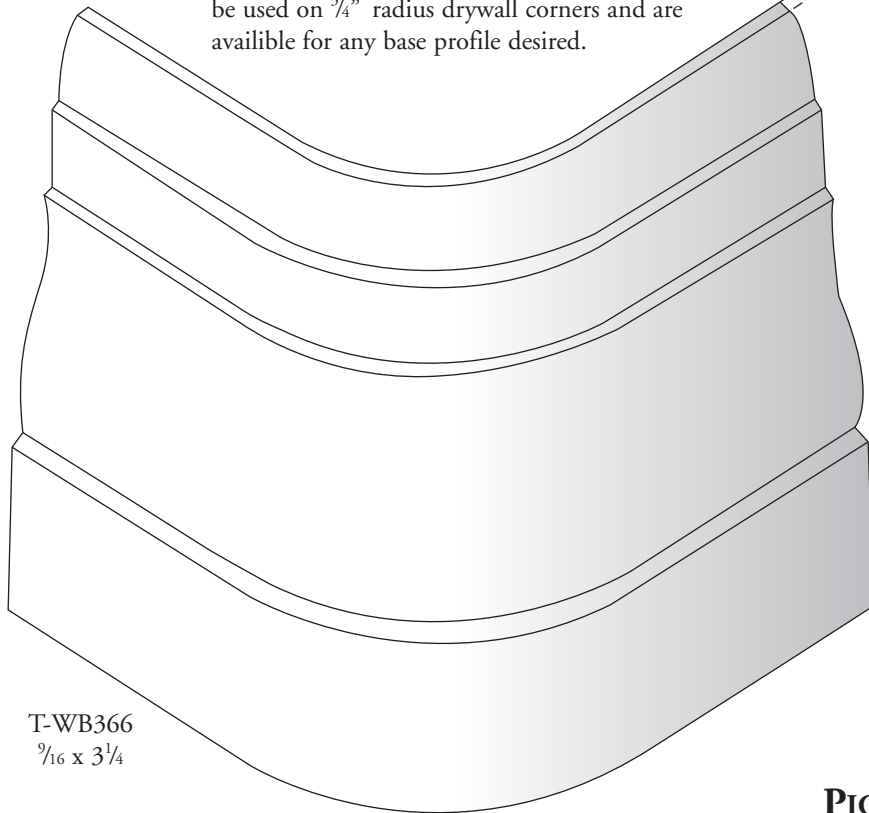

T-WB366
 $\frac{7}{16} \times 3\frac{1}{4}$

PICTURE MOULDING

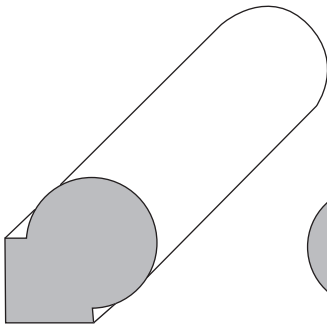

C-HA100
 $\frac{3}{4} \times \frac{3}{4}$

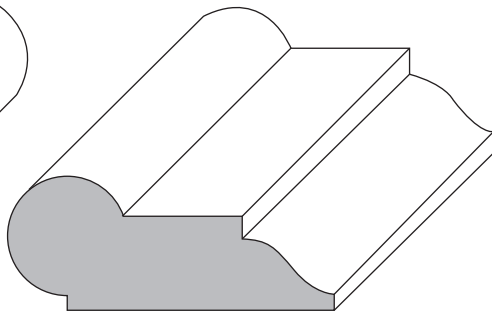

T-WM273
 $1\frac{1}{16} \times 1\frac{11}{16}$

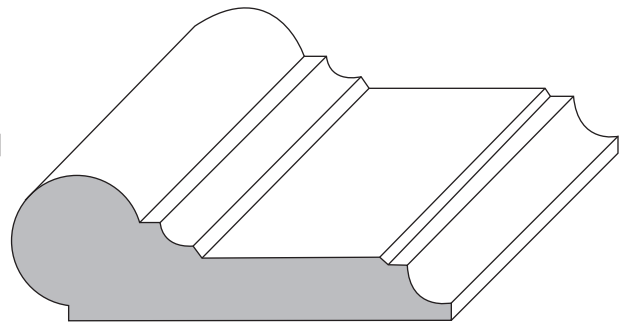

C-D1210
 $\frac{3}{4} \times 2\frac{1}{4}$

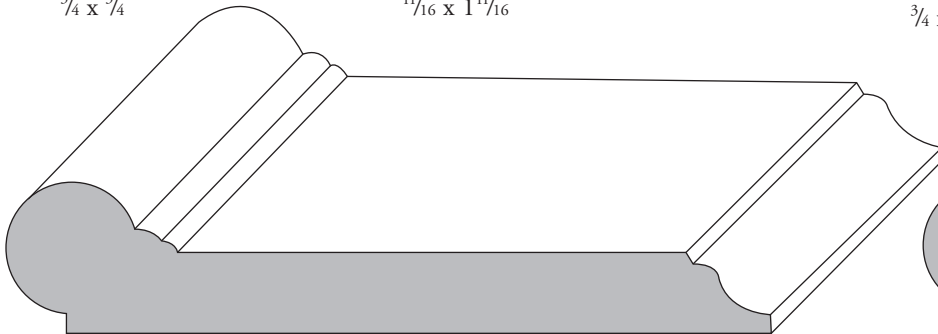

C-24128
 $\frac{3}{4} \times 4$

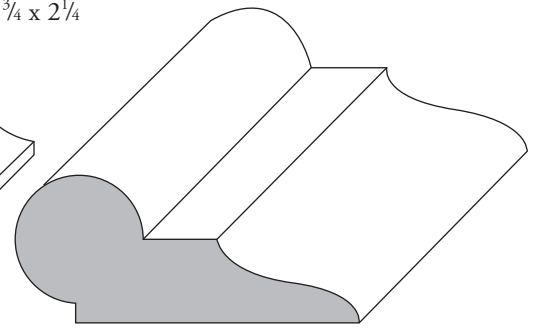

T-WM276
 $\frac{3}{4} \times 1\frac{3}{4}$

MISCELLANEOUS

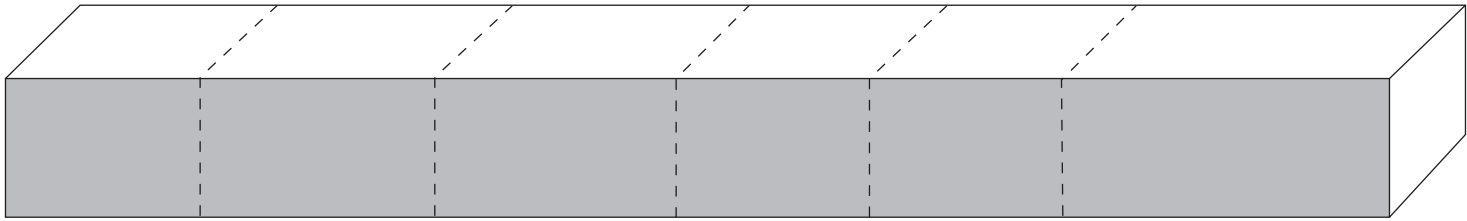

C-FC341 $\frac{3}{4} \times 1$ T-1 x 225 $\frac{3}{4} \times 2\frac{1}{4}$ T-WM1 x 4 $\frac{3}{4} \times 3\frac{1}{2}$ T-WM1 x 5 $\frac{3}{4} \times 4\frac{1}{2}$ T-WM1 x 6 $\frac{3}{4} \times 5\frac{1}{2}$ T-WM1 x 8 $\frac{3}{4} \times 7\frac{1}{4}$ **FLATSTOCK**

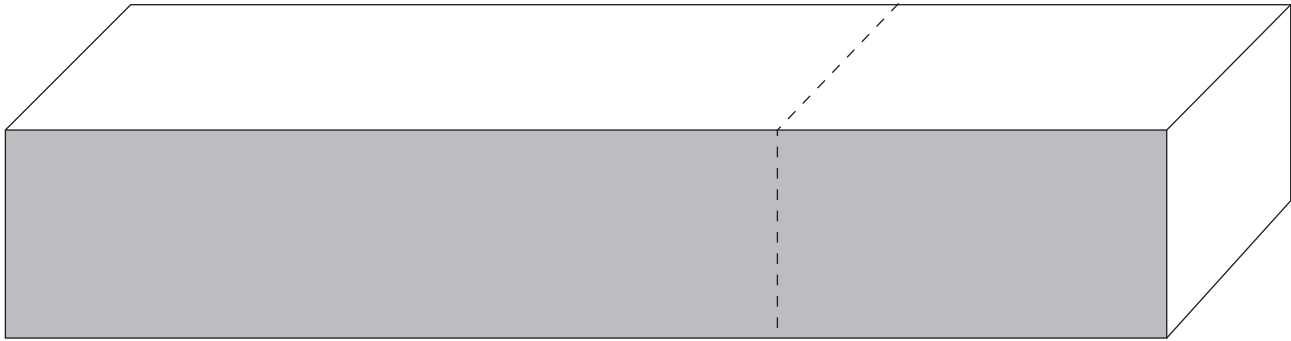

T-1 x 4SH 1 x 4 T-1 x 6SH 1 x 6 **FLATSTOCK**



T-SL368 $\frac{3}{4} \times 4\frac{9}{16}$ T-SL369 $\frac{3}{4} \times 4\frac{13}{16}$ **JAMBSTOCK**

BACK BAND

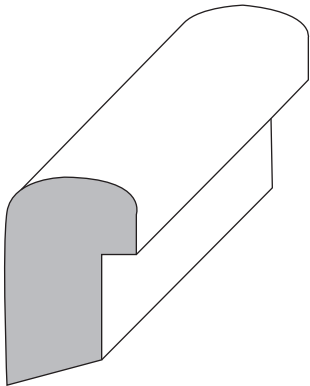

C-NJ612 $\frac{11}{16} \times 1\frac{1}{8}$

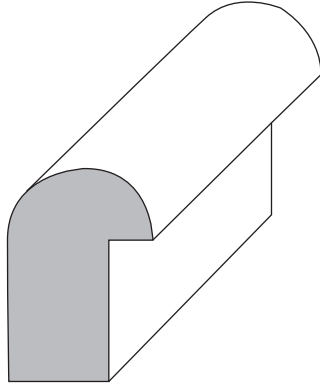

C-ST54B $\frac{11}{16} \times 1\frac{1}{16}$

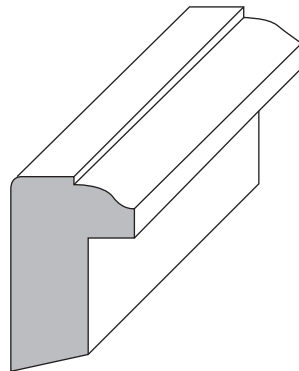

T-WM281 $\frac{11}{16} \times 1$

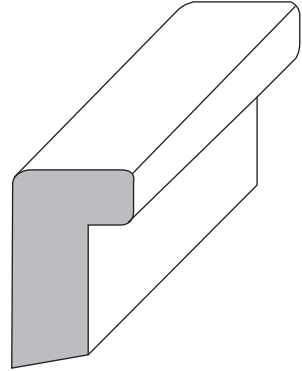

T-WM280 $\frac{11}{16} \times 1$

MISCELLANEOUS

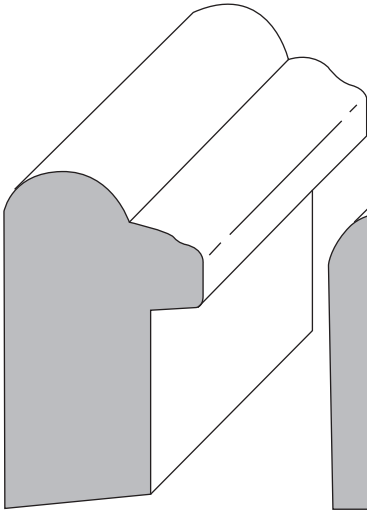

C-BB200
1 x 1⁵/₈

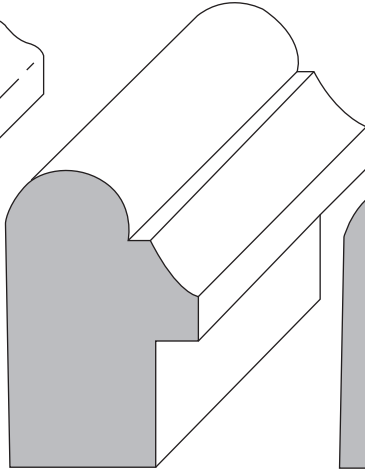

C-EC289
1 x 1⁹/₁₆

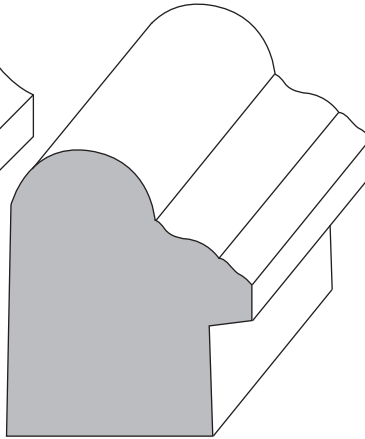

C-282MD
1⁵/₈ x 1¹/₈

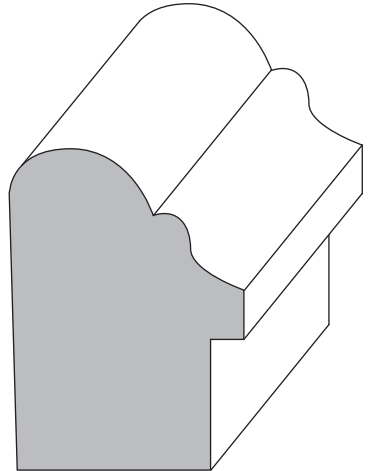

C-WM288
1¹/₈ x 1¹⁵/₁₆

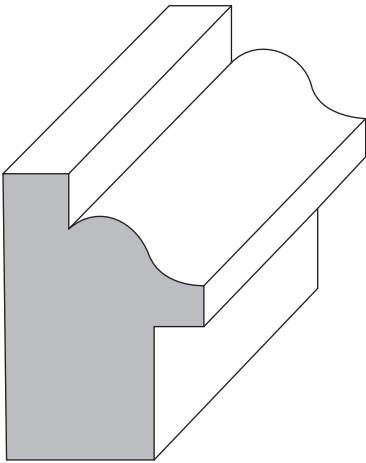

C-EC282
1 x 1¹/₂

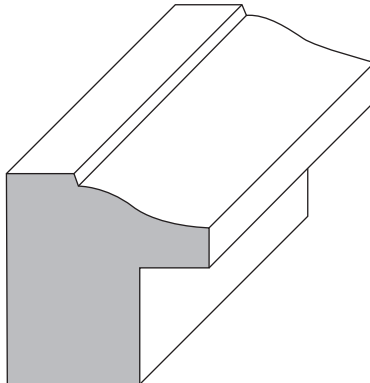

C-DC281
1 x 1¹/₈

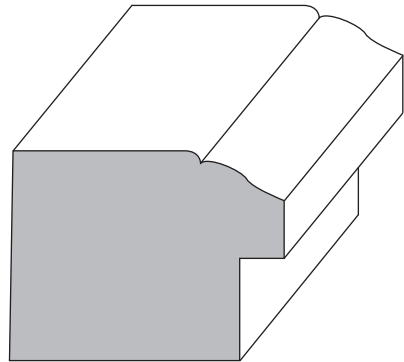

C-EC283
1¹/₈ x 1³/₈

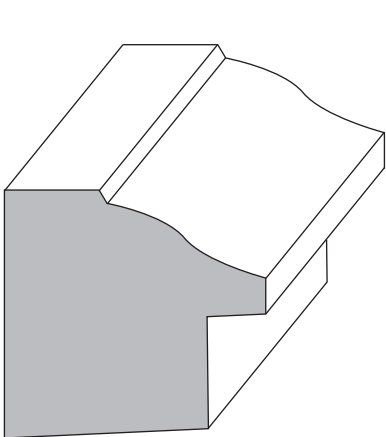

C-RB281
1¹/₄ x 1³/₈

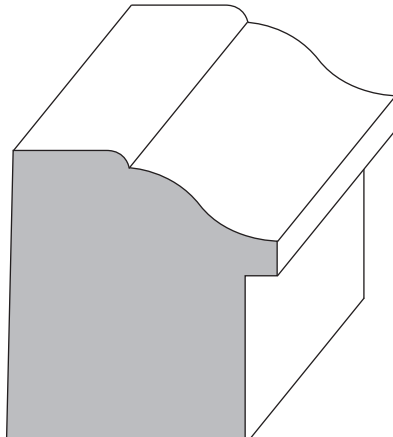

C-RB880
1³/₈ x 1⁵/₈

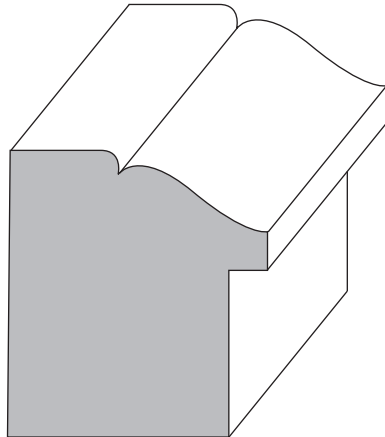

C-282FJ
1¹/₂ x 1³/₈

DECORATIVE TRIM MOULDINGS

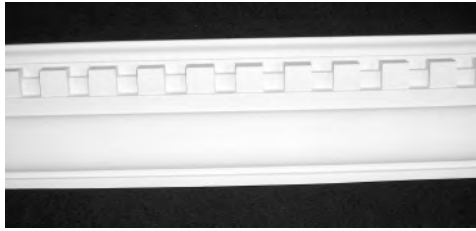

C-DE 100 $4\frac{3}{8} \times 3\frac{1}{2}$ pattern repeats $1\frac{3}{4}$



C-DE 110 $1\frac{7}{8} \times 2\frac{5}{16}$



C-DE 106 $1\frac{5}{16} \times 1\frac{3}{8}$



C-DE 112 $1\frac{7}{8} \times 2\frac{3}{8}$ pattern repeats $3\frac{3}{16}$



C-DE 107 $2\frac{15}{16} \times 1\frac{3}{16}$



C-DE 200 $1\frac{5}{8} \times \frac{3}{4}$

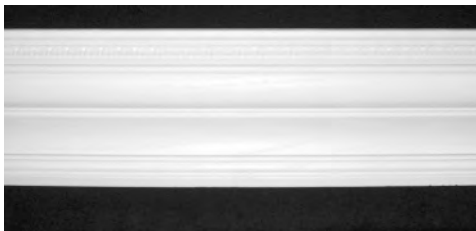

C-DE 108 4 x 4



C-DE 207 4 x 1



C-DE 109 $2\frac{11}{16} \times 2\frac{1}{2}$



C-DE 208 $2\frac{1}{2} \times \frac{3}{4}$ pattern repeats $1\frac{15}{16}$

DECORATIVE TRIM MOULDINGS



C-DE 209 $2\frac{1}{2} \times \frac{7}{8}$ pattern repeats $1\frac{5}{8}$



C-DE 216 $7\frac{1}{2} \times 1\frac{1}{2}$ pattern repeats 1



C-DE 210 $2\frac{3}{4} \times 3\frac{3}{4}$ pattern repeats $2\frac{5}{8}$



C-DE 218 $3 \times \frac{3}{4}$



C-DE 211 $2\frac{1}{2} \times 1\frac{5}{8}$ pattern repeats $4\frac{1}{2}$



C-DE 219 $4 \times \frac{3}{4}$



C-DE 214 3×1



C-DE 220 $5\frac{1}{2} \times \frac{3}{4}$



C-DE 215 $4\frac{1}{4} \times \frac{3}{4}$

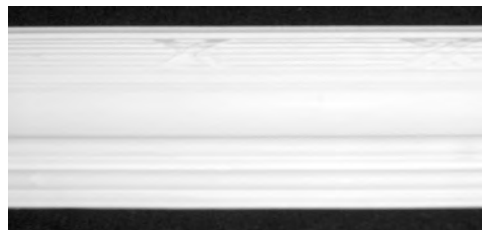

C-DE 221 $4 \times \frac{15}{16}$

DECORATIVE TRIM MOULDINGS



C-DE 222 $3\frac{7}{8} \times 1$



C-DE 227 $4\frac{3}{4} \times 2$



C-DE 223 $3\frac{1}{4} \times \frac{3}{4}$

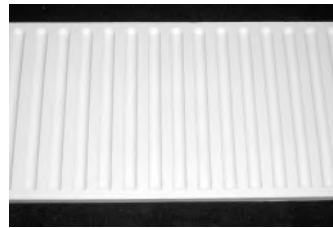

C-DE 228 $7\frac{15}{16} \times \frac{1}{2}$ pattern repeats 1



C-DE 224 $3\frac{5}{8} \times \frac{13}{16}$



C-DE 400 $2\frac{3}{8} \times 1\frac{1}{2}$



C-DE 225 $2\frac{7}{8} \times \frac{3}{4}$



C-DE 403 $1\frac{1}{2} \times 1$



C-DE 226 $3\frac{7}{16} \times \frac{3}{4}$ (DE 215 $4\frac{1}{4} \times \frac{3}{4}$)



C-DE 404 $\frac{13}{16} \times \frac{1}{2}$

DECORATIVE TRIM MOULDINGS

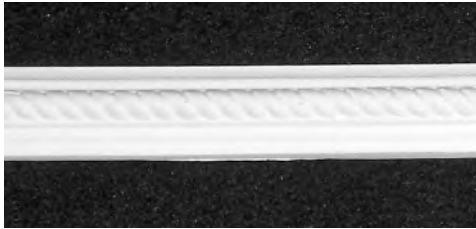

C-DE 406 $1\frac{7}{16} \times \frac{1}{2}$



C-DE 414 $1\frac{1}{2} \times \frac{5}{8}$ pattern repeats $1\frac{1}{8}$



C-DE 407 $\frac{7}{8} \times \frac{3}{8}$



C-DE 415 $1\frac{1}{4} \times \frac{1}{2}$



C-DE 408 $3\frac{1}{4} \times \frac{5}{8}$



C-DE 416 $1 \times \frac{9}{16}$



C-DE 409 $3\frac{3}{4} \times \frac{5}{8}$



C-DE 900 $1\frac{3}{4} \times \frac{1}{2}$



C-DE 412 $1\frac{1}{4} \times \frac{5}{8}$



C-DE 902 $1\frac{3}{16} \times \frac{7}{16}$

DECORATIVE TRIM MOULDINGS



C-DE 903 1 x 3/8



C-DE 915 1 1/4 x 1 1/2



C-DE 904 5/16 x 3/4

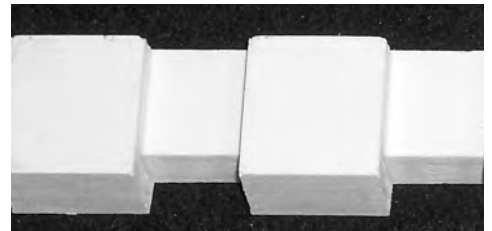

C-DE 916 1 1/4 x 7/8

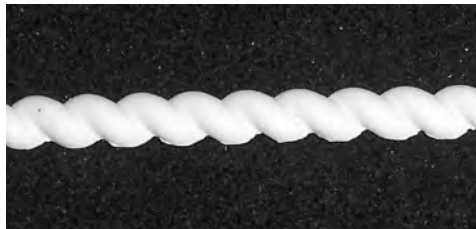

C-DE 905 7/16 x 1/2



C-DE 919 1 3/16 x 5/8



C-DE 911 1 x 3/8



C-DE 920 2 3/8 x 2 1/8



C-DE 914 1/2 x 7/16

ARCHITECTURAL ACCENTS AND ACCESSORIES

ResinArt Architectural Accents and Accessories are produced from only the finest original wooden carvings and sculptures.

U-ONL10 16 1/2 x 4 1/4 x 3/8



U-ONL20 7 3/4 x 4 1/4 x 5/8



U-ONL21 12 1/2 x 4 3/8 x 5/8



U-ONL30 7 1/8 x 3 x 3/8



U-ONL31 11 x 4 3/4 x 1



U-ONL61
6 1/4



U-ONL62
6 1/2 x 9



U-ONL33 4 1/4 x 20 1/2 x 1/2



U-COR54
12 x 6 x 6 1/2



U-COR55
15 x 7 x 9



U-ONL60
5 x 3 1/2 x 5/8



U-COR40
6 1/2 x 3 7/8 x 3



U-COR41
8 1/4 x 4 7/8 x 3 1/4



U-COR42
10 x 5 3/4 x 3 7/8



U-COR11
10 x 5 x 5 5/8



U-COR22
15 x 10 x 7 3/4



U-COR47
13 5/8 x 8 x 6



U-COR12
10 x 7 1/4 x 3 1/2



U-COR45
4 x 4 7/8 x 3 1/2



U-COR21
6 3/4 x 3 3/8 x 3 3/4



U-COR91
5 7/8 x 3 1/8 x 5 1/8



U-COR44
8 x 5 3/4 x 3 1/8



U-COR10
3 1/2 x 6 1/2



U-COR30
21 x 5 3/4 x 7 3/4

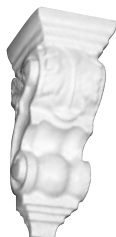

U-AA300
7 1/8 x 3 x 3 1/2



U-AA301
5 5/8 x 2 7/8 x 3 1/2



U-AA304
6 1/4 x 3 1/4 x 3 1/2



U-B1541
5 x 4 x 2 7/8

ARCHITECTURAL ACCENTS AND ACCESSORIES

ResinArt Architectural Accents and Accessories are produced from only the finest original wooden carvings and sculptures.



U-COR49
11³/₈ x 5⁹/₁₆ x 6³/₄



U-COR50
11³/₈ x 4⁵/₈



U-COR51
10⁵/₈ x 3³/₄ x 4¹/₂



U-COR20
9 x 3³/₄ x 4¹/₈



U-COR58
14 x 6 x 8¹/₄



U-AA308
12¹/₄ x 5 x 4¹/₈



U-COR 56
12 x 3¹/₂ x 8¹/₂



U-COR31
15³/₄ x 5¹/₂ x 7³/₈



U-COR46
16⁵/₈ x 5¹/₂ x 6



U-STA30
7⁵/₁₆ x 7⁵/₁₆



U-STA20
12³/₈ x 6¹/₄



U-STA10
12³/₈ x 7³/₈



U-STA15
9¹/₂ x 5



U-STA50
10⁷/₈ x 7



U-STA52
9³/₄ x 6⁷/₈



U-STA42
11 x 7¹/₄



U-STA41
14 x 7⁵/₈



U-STA40
11¹/₄ x 7¹/₄

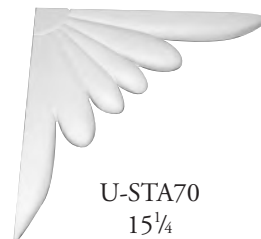

U-STA70
15¹/₄



ARCHITECTURAL ACCENTS AND ACCESSORIES

ResinArt Architectural Accents and Accessories are produced from only the finest original wooden carvings and sculptures.



T-AC250
2⁵/₈ x 2⁵/₈



T-AC258
2⁵/₈ x 2⁵/₈



T-AC350
3⁵/₈ x 3⁵/₈



T-AC375
3³/₄ x 3³/₄



U-KEY20
3¹/₂, 4¹/₂, 6¹/₂



U-KEY30
3¹/₂, 4¹/₂, 6¹/₂



U-KEY40
3¹/₂, 4¹/₂, 6¹/₂



U-CU427
7³/₄



U-CAP10
3³/₈



U-CAP20
4³/₈



U-CAP25
4¹/₄



U-CAP30
5³/₈



U-MED20
7⁵/₈ x 7⁵/₈



U-MED10
13⁷/₈ x 1



U-KEY50
3¹/₂, 4¹/₂, 6¹/₂



U-KEYST
3¹/₂, 4¹/₂, 6¹/₂

Duraflex Adhesive and Accelerator

Duraflex Adhesive (A-Glue)

It's easy to install DuraFlex Flexible Moulding with our fast-drying super-hold Adhesive. Perfect for eliminating nail holes, where there are no studs to nail into, and at seams for a close, neat fit.

Duraflex Accelerator (A-Accel)

For even faster installation, use our Instant Adhesive Accelerator. Dries in just a few seconds.

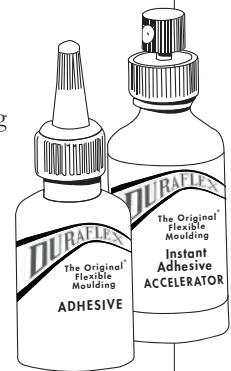

DURACRAFT COLUMNS

COLUMN CAPITALS



Corinthian - U-Cap 6" to 18"

	A	B	C
R-CAPIT-C-8"	6 1/2"	9 1/4"	11 1/2"
R-CAPIT-C-10"	8 1/8"	10 7/8"	14"
R-CAPIT-C-12"	10 1/4"	13 5/8"	19 1/4"



Greek Erectheum - U-Cap 6" to 12"

	A	B	C
R-CAPIT-G-8"	6 1/8"	3 1/2"	7 1/4" x 7 1/4"
R-CAPIT-G-10"	8 1/8"	4 7/8"	10 1/4" x 9 1/4"
R-CAPIT-G-12"	10 1/4"	5 1/2"	12 1/4" x 12 1/4"



Modern Composite - U-Cap 6" to 18"

	A	B	C
R-CAPIT-M-8"	6 1/2"	10 1/4"	14 1/2"
R-CAPIT-M-10"	8 1/4"	11 3/4"	14 3/8"
R-CAPIT-M-12"	10 1/4"	12 1/8"	17 1/8"



Roman Ionic - U-Cap 6" to 18"

	A	B	C
R-CAPIT-R-8"	6 1/8"	3"	7 1/4" x 7 1/2"
R-CAPIT-R-10"	8 1/8"	4 1/8"	9 1/4" x 10 1/4"
R-CAPIT-R-12"	10 1/4"	4 1/2"	12 1/8" x 13 1/4"



Temple of the Winds - U-Cap 6" to 18"

	A	B	C
R-CAPIT-T-8"	6 1/8"	7 1/4"	10 5/8"
R-CAPIT-T-10"	8 1/4"	9 1/4"	13 1/2"
R-CAPIT-T-12"	10 1/4"	11 3/8"	16 1/8"



Scamozzi - U-Cap 6" to 20"

	A	B	C
R-CAPIT-S-8"	6 1/4"	2 7/8"	9 1/2"
R-CAPIT-S-10"	8 1/4"	3 1/2"	13"
R-CAPIT-S-12"	10 1/8"	4 7/8"	16 1/2"

ResinArt East, Inc. Column Material has been tested for smoke development and flame spread under test standard: ASTM E84. Also, all ResinArt Columns have been tested for load bearing capability. Documentation available upon request.

WARRANTEES

ResinArt East, Inc. guarantees its DuraCraft Columns™ for the "lifetime" of ownership. Our warranty insures that DuraCraft Columns™ are not defective in material and/or workmanship. The "Lifetime Limited Warranty" is effective as long as the original purchaser owns the structure to which the column was originally and properly installed according to ResinArt's column installation instructions.

ResinArt East, Inc. will be solely responsible for determining whether to repair or replace its products that have not met performance standards due to material and/or workmanship deficiencies. ResinArt East, Inc. "Limited Lifetime Warranty" will cover up to the original cost of the product in question.

ResinArt East, Inc. "Limited Lifetime Warranty" does not cover damages resulting from the replacement of a substandard product. The "Limited Lifetime Warranty" will be in effect so long as the customer uses ResinArt East, Inc. products in a manner consistent with design capacities of the item.

How to Order ResinArt capitals:

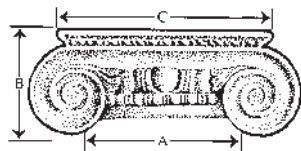

A=Base B=Height
C=Abacus

To assure a proper fit simply measure the top diameter of your column (see "A" in diagram) and match it to the bottom diameter of the capitals.

DURACRAFT COLUMNS

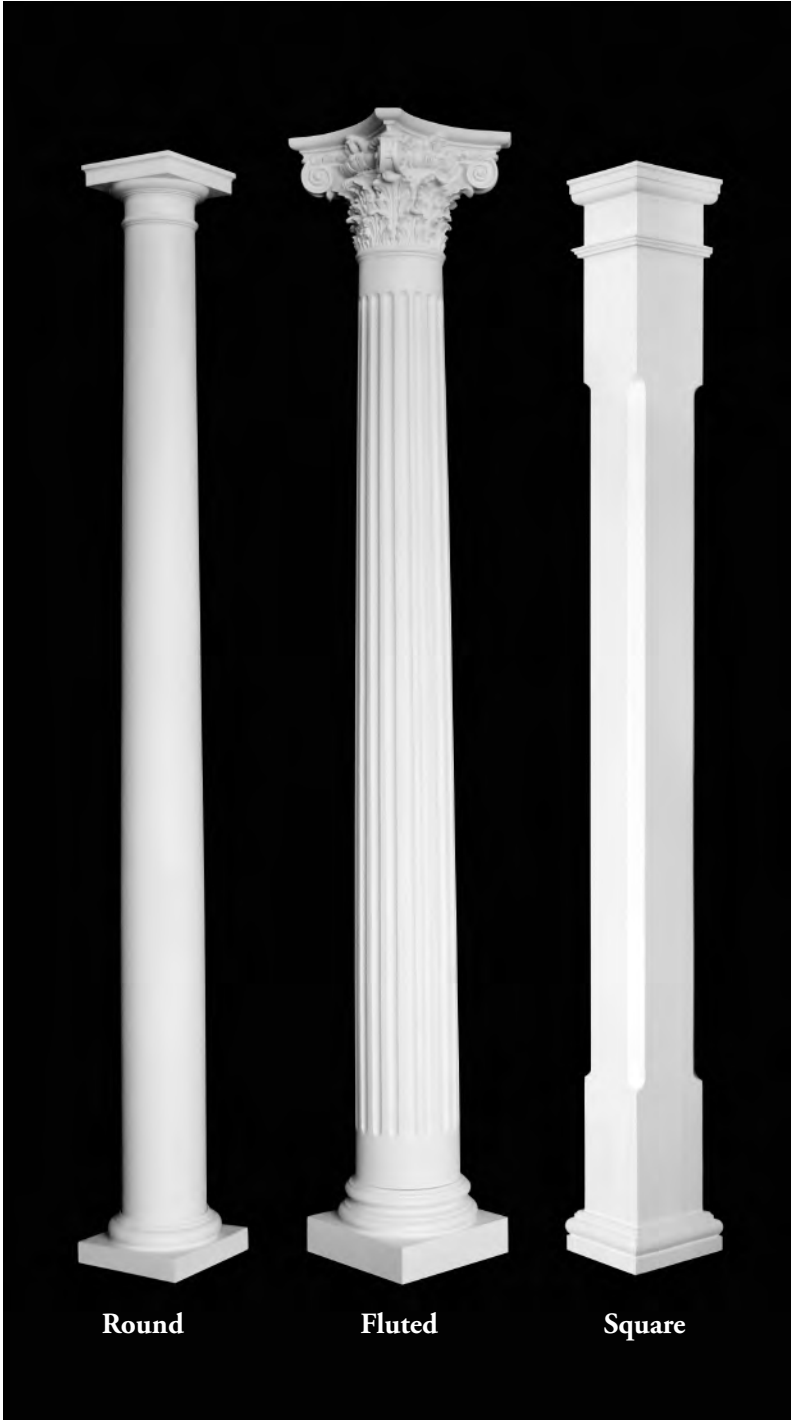

- Load Bearing
- Will not rot, bow, or crack, and are substantially more impact resistant than wood.
- No priming necessary for painting.
- Quick and easy to install.
- Maintenance free.
- Tapered in the Greek Tradition.

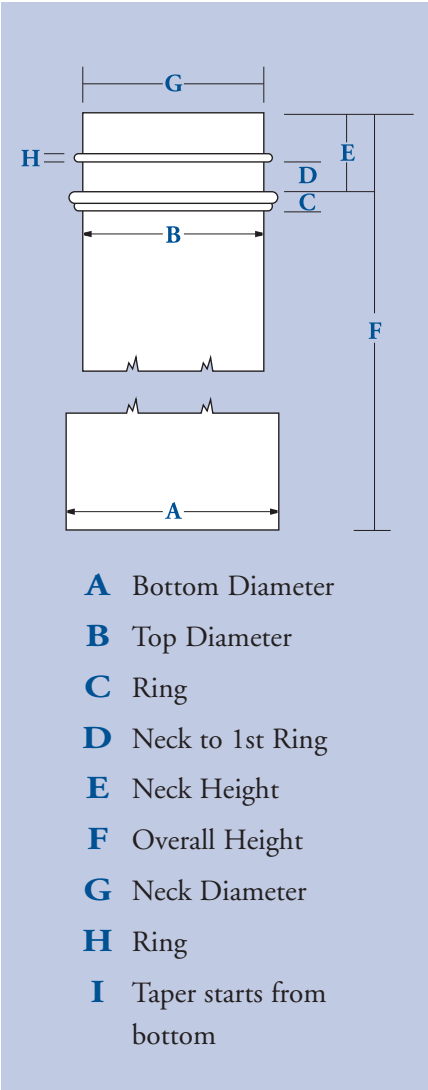

FITS COLUMN DIAMETER			
DURACRAFT	8"	10"	12"
Load Limit	12,000 lbs. Max	16,000 lbs. Max	20,000 lbs. Max



DURACRAFT COLUMNS

SQUARE COLUMNS

	COLUMN SIZE	ACTUAL WIDTH	CAP WIDTH	CAP HEIGHT	BASE WIDTH	BASE HEIGHT	TOTAL LENGTH	CHAMFER STARTS
R-SQCOL-S-8 x 8,10,12	8" sq.	7 ³ / ₄ "	10"	2 ¹ / ₄ ,2 ¹ / ₂ ,3"	10"	3 ¹ / ₂ ,4,4 ¹ / ₂ "	8,10,12'	16"
R-SQCOL-S-10 x 8,10,12	10" sq.	9 ³ / ₄ "	12"	2 ¹ / ₄ ,2 ¹ / ₂ ,3"	12"	3 ¹ / ₂ ,4,4 ¹ / ₂ "	8,10,12'	17"
R-SQCOL-S-12 x 8,10,12	12" sq.	11 ³ / ₄ "	14"	2 ¹ / ₄ ,2 ¹ / ₂ ,3"	14"	3 ¹ / ₂ ,4,4 ¹ / ₂ "	8,10,12'	18"

Square columns available with or without chamfer

ROUND COLUMNS/FLUTED

COLUMN SIZE	A	B	C	D	E	F	G	H	I	
R-COLUM-S-8 x 8	8" x 8'	7 ³ / ₄ "	6 ¹ / ₄ "	1"	1 ¹ / ₂ "	4 ⁷ / ₈ "	96"	6 ¹ / ₄ "	3 ³ / ₈ "	33"
R-COLUM-S-8 x 9	8" x 9'	7 ³ / ₄ "	6 ¹ / ₄ "	1"	1 ¹ / ₂ "	4 ¹ / ₂ "	108"	6 ¹ / ₄ "	3 ³ / ₈ "	30"
R-COLUM-S-8 x 10	8" x 10'	7 ³ / ₄ "	6 ¹ / ₄ "	1"	1 ¹ / ₂ "	4 ⁷ / ₈ "	120"	6 ¹ / ₄ "	3 ³ / ₈ "	42"
R-COLUM-S-10 x 8	10" x 8'	9 ³ / ₄ "	8"	1"	1 ¹ / ₂ "	5 ¹ / ₂ "	96"	8"	3 ³ / ₈ "	33"
R-COLUM-S-10 x 9	10" x 9'	9 ³ / ₄ "	8"	1"	1 ¹ / ₂ "	5 ¹ / ₂ "	108"	8"	3 ³ / ₈ "	30"
R-COLUM-S-10 x 10	10" x 10'	9 ³ / ₄ "	8"	1"	1 ¹ / ₂ "	5 ¹ / ₂ "	120"	8"	3 ³ / ₈ "	42"
R-COLUM-S-10 x 12	10" x 12'	9 ³ / ₄ "	8"	1"	1 ¹ / ₂ "	5 ¹ / ₂ "	144"	8"	3 ³ / ₈ "	48"
R-COLUM-S-12 x 8	12" x 8'	11 ³ / ₄ "	10"	1"	1 ¹ / ₂ "	6"	96"	10"	3 ³ / ₈ "	33"
R-COLUM-S-12 x 9	12" x 9'	11 ³ / ₄ "	10"	1"	1 ¹ / ₂ "	6"	108"	10"	3 ³ / ₈ "	30"
R-COLUM-S-12 x 10	12" x 10'	11 ³ / ₄ "	10"	1"	1 ¹ / ₂ "	6"	120"	10"	3 ³ / ₈ "	42"
R-COLUM-S-12 x 12	12" x 12'	11 ³ / ₄ "	10"	1"	1 ¹ / ₂ "	6"	144"	10"	3 ³ / ₈ "	48"

For 8" Fluted Column: Flutes start 8" up from bottom and 2" down from C Ring

For 10" Fluted Column: Flutes start 10" up from bottom and 2" down from C Ring

For 12" Fluted Column: Flutes start 10" up from bottom and 2" down from C Ring

TUSCAN CAP & BASE



Tuscan - U-Cap 6" to 18"

	BASE COL.	DIA.	HT.
R-TUSCN-S-8CAP	9 ¹ / ₂ "	8"	2 ¹ / ₄ "
R-TUSCN-S-10CAP	11 ¹ / ₄ "	10"	3 ¹ / ₂ "
R-TUSCN-S-12CAP	14 ¹ / ₄ "	12"	4"



	BASE COL.	DIA.	HT.
R-TUSCN-S-8BAS	10 ¹ / ₄ "	8"	4 ¹ / ₄ "
R-TUSCN-S-10BAS	13 ¹ / ₄ "	10"	5 ¹ / ₄ "
R-TUSCN-S-12BAS	16 ¹ / ₂ "	12"	6"

ATTIC BASE

	BASE COL.	DIA.	HT.
R-MSAT-S-8"	10 ⁷ / ₁₆ "	8"	6"
R-MSAT-S-10"	12 ¹ / ₄ "	10"	7"
R-MSAT-S-12"	15 ¹ / ₂ "	12"	8"



INDEX OF PROFILES

PROFILE	PAGE #	PROFILE	PAGE #	PROFILE	PAGE #	PROFILE	PAGE #	PROFILE	PAGE #
C-5103	71	C-DE 208	85	C-EC12	81	C-LW356	7	C-P8040	76
C-1002M	23	C-DE 209	86	C-EC14R	23	C-LW366	30	C-P9010	76
C-21469	51	C-DE 210	86	C-EC19	38	C-LW371	7	C-P9020	75
C-214PR	71	C-DE 211	86	C-EC20	18	C-LW445	7	C-P9040	73
C-24128	82	C-DE 214	86	C-EC282	84	C-LW983	81	C-P9050	72
C-281-4	26	C-DE 215	86	C-EC283	84	C-LWM45	64	C-PA525	40
C-282FJ	84	C-DE 216	86	C-EC289	84	C-LWM46	63	C-PA526	53
C-282MD	84	C-DE 218	86	C-EC36	61	C-M14	24	C-PA550	17
C-35955	72	C-DE 219	86	C-EC361	25	C-M15	23	C-PM250	72
C-441WM	26	C-DE 220	86	C-EC36A	61	C-M1661	26	C-PM349	29
C-45FJ	65	C-DE 221	86	C-EC37	51	C-M21A	13	C-PM350	12
C-45M	65	C-DE 222	87	C-EC610	43	C-MB714	44	C-PM351	10
C-AH397	76	C-DE 223	87	C-EC683	27	C-MB914	44	C-PM451	29
C-AH398	78	C-DE 224	87	C-ECMD1	20	C-MD012	67	C-PM510	73
C-AH41	62	C-DE 225	87	C-EM104	13	C-MD065	15	C-PM611	60
C-AH466	27	C-DE 226	87	C-EM227	54	C-MD329	62	C-PM628	53
C-AH810	44	C-DE 227	87	C-EM300	11	C-MD415	15	C-PM650	40
C-AM530	11	C-DE 228	87	C-EM600	42	C-MD513	64	C-PM803	32
C-AS535	11	C-DE 400	87	C-EM61S	24	C-MD655	66	C-PM848	13
C-B1002	22	C-DE 403	87	C-EMS58	71	C-MDF42	66	C-PM917	33
C-B5180	30	C-DE 404	87	C-ES12P	75	C-MDF75	32	C-PM921	35
C-BA518	75	C-DE 406	88	C-FC341	83	C-MI558	53	C-PM931	16 and 38
C-BB200	84	C-DE 407	88	C-FL134	40	C-MSAL3	19	C-PM943	37
C-BB6	30	C-DE 408	88	C-FLUTT	22	C-NA800	58	C-PO118	72
C-BBASE	43	C-DE 409	88	C-FM325	31	C-NJ105	35	C-PO149	70
C-BM1	56	C-DE 411	88	C-FM425	33	C-NJ119	27	C-PO150	71
C-BM256	58	C-DE 412	88	C-FM725	63	C-NJ128	16	C-PO215	9
C-BO125	45	C-DE 414	88	C-FM750	39	C-NJ149	9	C-PO524	48
C-BO135	77	C-DE 415	88	C-FRIED	54	C-NJ177	14	C-PO525	47
C-BO136	73	C-DE 416	88	C-FW418	50	C-NJ202	32	C-PO533	50
C-BO538	52	C-DE 900	88	C-GB218	45	C-NJ204	34	C-PO534	50
C-C21	55	C-DE 902	88	C-GM13	72	C-NJ208	32	C-PO540	47
C-CB300	40	C-DE 903	89	C-GM218	33	C-NJ209	33	C-PS112	72
C-CHARL	12	C-DE 904	89	C-GROSS	14	C-NJ232	72	C-Q2009	34
C-CL173	37	C-DE 905	89	C-GU725	35	C-NJ236	71	C-Q2010	71
C-CL312	22	C-DE 911	89	C-HA100	82	C-NJ263	39	C-R242U	74
C-CM449	52	C-DE 914	89	C-HA600	42	C-NJ311	49	C-R265U	12
C-CM49	48	C-DE 915	89	C-HB341	26	C-NJ319	47	C-R270U	14
C-CM525	52	C-DE 916	89	C-HB-78	20	C-NJ330	49	C-R42	45
C-CM70	56	C-DE 919	89	C-HERIT	16	C-NJ380	54	C-R9304	61
C-CO725	63	C-DE 920	89	C-HI312	22	C-NJ419	27	C-RAM15	23
C-CT325	74	C-DE414	37	C-HI714	42	C-NJ425	72	C-RB281	84
C-CT425	53	C-DE418	10 and 29	C-HLGRM	14	C-NJ612	83	C-RB3M	20
C-D1210	82	C-DECON	51	C-HS-2	20	C-NJ714	79	C-RB42	71
C-DB491	50	C-DHOWE	19	C-HSD-1	19	C-NJ722	45	C-RB426	9
C-DC281	84	C-DI235	16	C-KB334	52	C-NJ802	11	C-RB518	34
C-DC325	10	C-DM550	49	C-L8753	25	C-NJ918	72	C-RB6F	23
C-DC338	12	C-DN175	80	C-L9202	39	C-OC200	50	C-RB6R	23
C-DC358	21	C-DN200	80	C-LD226	55	C-OC210	48	C-RB718	42
C-DC425	29	C-DS102	12	C-LD248	59	C-OC213	50	C-RB880	84
C-DE 100	85	C-DS400	25	C-LD403	11	C-OC215	48	C-RC858	57
C-DE 106	85	C-DS401	76	C-LD412	38	C-OC230	48	C-RL425	67
C-DE 107	85	C-DS408	24	C-LD608	30	C-OC322	53	C-RLC10	73
C-DE 108	85	C-DSCAP	45	C-LD639	34	C-P2050	8 and 35	C-RLC22	11
C-DE 109	85	C-DY233	11	C-LG562	66	C-P2575	19	C-RR201	68
C-DE 110	85	C-DYKSP	18	C-LM608	10	C-P4440	55	C-RR205	68
C-DE 112	85	C-EC045	48	C-LM9	31	C-P7070	73	C-RR210	69
C-DE 200	85	C-EC045	64	C-LO425	77	C-P8020	72	C-RR215	60
C-DE 207	85	C-EC1	20	C-LSM46	65	C-P8030	72	C-RR255	23



INDEX OF PROFILES

PROFILE	PAGE #	PROFILE	PAGE #	PROFILE	PAGE #	PROFILE	PAGE #	PROFILE	PAGE #
C-RR260	23	C-WS045	80	T-RB2	81	T-WM240	81	U-COR46	91
C-RR265	24	C-WS050	80	T-RB300	19	T-WM273	82	U-COR47	90
C-RR271	21	C-WW525	48	T-SL101	73	T-WM276	82	U-COR49	91
C-RR272	21	DuraCraft 10" Column	94	T-SL142	39	T-WM280	83	U-COR50	91
C-RR275	36	DuraCraft 12" Column	94	T-SL203	10	T-WM281	83	U-COR51	91
C-RR276	37	DuraCraft 8" Column	94	T-SL207	9 and 73	T-WM288	84	U-COR54	90
C-RR277	41	R-CAPIT-C-10"	93	T-SL225	12	T-WM297	74	U-COR55	90
C-RR300	24	R-CAPIT-C-12"	93	T-SL231	75	T-WM300	74	U-COR56	91
C-RR380	15	R-CAPIT-C-8"	93	T-SL254	70	T-WM302	74	U-COR58	91
C-RR700	57	R-CAPIT-G-10"	93	T-SL260	54	T-WM327	6	U-COR91	90
C-RRL03	9	R-CAPIT-G-12"	93	T-SL287	47	T-WM351	6	U-CU427	92
C-RRL05	22	R-CAPIT-G-8"	93	T-SL288	47	T-WM356	6	U-KEY20	92
C-RRL06	72	R-CAPIT-M-10"	93	T-SL303	80	T-WM361	25	U-KEY30	92
C-RRL07	72	R-CAPIT-M-12"	93	T-SL311	22	T-WM366	25	U-KEY40	92
C-SDC99	7	R-CAPIT-M-8"	93	T-SL368	83	T-WM376	7	U-KEY50	92
C-SE13	78	R-CAPIT-R-10"	93	T-SL369	83	T-WM390	74	U-KEYST	92
C-SE303	15	R-CAPIT-R-12"	93	T-SL401	72	T-WM430	8	U-MED10	92
C-SI540	76	R-CAPIT-R-8"	93	T-SL408	45	T-WM432	8	U-MED20	92
C-SM200	45	R-CAPIT-S-10"	93	T-SL424	71	T-WM433	8	U-ONL10	90
C-SM231	77	R-CAPIT-S-12"	93	T-SL435	45	T-WM442	7	U-ONL20	90
C-SM250	79	R-CAPIT-S-8"	93	T-SL436	45	T-WM444	7	U-ONL21	90
C-SM29	51	R-CAPIT-T-10"	93	T-WB366	30 and 82	T-WM445	7	U-ONL30	90
C-SM30	45	R-CAPIT-T-12"	93	T-WM045	65	T-WM473	8	U-ONL31	90
C-SM304	77	R-CAPIT-T-8"	93	T-WM047	46	T-WM493	8	U-ONL33	90
C-SM315	17 and 41	R-COLUM-S-10 x 10	95	T-WM048	46	T-WM618	28	U-ONL60	90
C-SM32	51	R-COLUM-S-10 x 12	95	T-WM049	46	T-WM620	28	U-ONL61	90
C-SM414	43	R-COLUM-S-10 x 8	95	T-WM051	46	T-WM623	28	U-ONL62	90
C-SM425	31	R-COLUM-S-10 x 9	95	T-WM052	46	T-WM663	28	U-STA10	91
C-SM434	36	R-COLUM-S-12 x 10	95	T-WM053	46	T-WM710	29	U-STA15	91
C-SM450	16	R-COLUM-S-12 x 12	95	T-WM054	46	T-WM713	29	U-STA20	91
C-SM475	41	R-COLUM-S-12 x 8	95	T-WM074	46	T-WM714	29	U-STA30	91
C-SM525	31	R-COLUM-S-12 x 9	95	T-WM074	64	T-WM724	29	U-STA40	91
C-SM600	17	R-COLUM-S-8 x 10	95	T-WM075	66	T-WM726	29	U-STA41	91
C-SM700	56	R-COLUM-S-8 x 8	95	T-WM083	70	T-WM748	28	U-STA42	91
C-SMB-1	31	R-COLUM-S-8 x 9	95	T-WM085	70	T-WM750	28	U-STA50	91
C-SMM3	13	R-MSAT-S-10"	95	T-WM093	70	T-WM753	28	U-STA52	91
C-SMM89	81	R-MSAT-S-12"	95	T-WM094	70	T-WM826	80	U-STA70	91
C-SPRAT	26	R-MSAT-S-8"	95	T-WM096	70	T-WM956	78		
C-SPRTL	26	R-SQCOL-S-10	95	T-WM097	18	T-WM987	81		
C-SS220	9	R-SQCOL-S-12	95	T-WM1 x 4	83	U-AA300	90	DuraFlex Adhesive and Instant Adhesive Accelerator	
C-SS281	21	R-SQCOL-S-8	95	T-WM1 x 5	83	U-AA301	90	A-Glue	92
C-SS425	69	R-TUSCN-S-10BAS	95	T-WM1 x 6	83	U-AA304	90	A-Accel	92
C-SSD97	18	R-TUSCN-S-10CAP	95	T-WM1 x 8	83	U-AA308	91		
C-ST134	71	R-TUSCN-S-12BAS	95	T-WM101	70	U-B1541	90		
C-ST31B	81	R-TUSCN-S-12CAP?	95	T-WM103	79	U-CAP10	92		
C-ST54B	83	R-TUSCN-S-8BAS	95	T-WM105	79	U-CAP20	92		
C-SU003	36	R-TUSCN-S-8CAP	95	T-WM108	79	U-CAP25	92		
C-TC304	27	T-1 x 225	83	T-WM120	79	U-CAP30	92		
C-TH075	72	T-1 x 4SH	83	T-WM123	79	U-COR10	90		
C-TH080	72	T-1 x 6SH	83	T-WM126	45	U-COR11	90		
C-TH141	17	T-1.5 x 3	79	T-WM163	45	U-COR12	90		
C-TH250	10	T-AC250	92	T-WM164	45	U-COR20	91		
C-TH424	49	T-AC258	92	T-WM167	45	U-COR21	90		
C-TH428	59	T-AC350	92	T-WM176	6	U-COR22	90		
C-TT302	18	T-AC375	92	T-WM180	6	U-COR30	90		
C-USC42	62	T-C1100	13	T-WM183	72	U-COR31	91		
C-VI350	12	T-CT444	7	T-WM205	81	U-COR40	90		
C-VI525	43	T-FL366	25	T-WM206	81	U-COR41	90		
C-VS300	20	T-NC500	81	T-WM207	80	U-COR42	90		
C-WP460	14	T-RB1	18	T-WM210	80	U-COR44	90		
C-WP470	25	T-RB17	47	T-WM230	81	U-COR45	90		



GENERAL CONDITIONS

RETURNS

All returned merchandise must be in new, resalable condition, returned prepaid and is subject to a 25% restocking charge. Custom profiles or sizes other than those listed on the standard price list cannot be returned. All returns are subject to prior approval and must be authorized in advance by ResinArt East, Inc. No unauthorized returns will be accepted.

WARRANTIES

ResinArt East, Inc. warrants all products to be free from defects in material and workmanship for a period of one year from date of purchase. In the event the material is received defective, ResinArt East, Inc. will replace the material at no charge to the customer or refund the purchase price.

SHIPPING

All orders are generally shipped U.P.S. within one week from receipt of order. Large orders of 50 pieces or more require a longer lead time and may be shipped on pallets via truck line. ResinArt East, Inc. does not accept responsibility for any back charges.

CLAIMS

Claims for damaged goods must be made directly with the transportation company within five days from receipt of merchandise.

PRICES

All prices are subject to change without notice.



Proudly Supplied By

**RIVER CITY
MILLWORK**

1-815-965-9439 | www.rivercitymillwork.com