

Coffman[®]

STAIR PARTS

BUYER'S GUIDE



Handrail
6010

Baluster
PLA44
1KNUC
2KNUC





Coffman Stair Parts has been a leading name in the stair part industry since 1874. For over 140 years, Coffman Stair Parts has been committed to providing the highest quality and workmanship of wood and iron stair parts. With a name you can trust, Coffman's focus on our customer's needs has us constantly looking for ways to offer improved service with programs, technology and the highest level of sales support.

www.WM-Coffman.com

800.810.9204

Coffman[®]
STAIR PARTS



Rail
C-6010

Balusters
2TW44
2KNUCIBASK
M301
M06



Table of Contents

Steps To Create Your Stairs	4
Product Summary	6
Wood Collection	10
Box Newels	14
Interchangeable Box Newels	20
Wood Newels & Balusters Series	22
Iron Collection	34
Iron Balusters Series	38
Shoe & Knuckle Options	58
Modern Collection	60
Swageless Fittings	62
Modern Railings	62
Hollow Tubes	62
SL-Tools & Accessories	63
Handrails & Details	64
Rail Series	66
Rail Fittings	70
Details	74
Stair Anatomy	80
Ordering Specifications	81
Index	87

Six Easy Steps to Create an Elegant Staircase

Step by Step Guide

Creating a staircase just the way you want it is easier than ever with Coffman Stair Parts. Whatever your personal style or type of home, you'll enjoy turning the stairway that you imagine into a beautiful creation. Our step-by-step process below will help guide you to a perfectly crafted staircase.

Have any questions? Our dedicated team of stair professionals are here to help. Contact us at **(800) 810-9204** or email us at **sales@wm-coffman.com** and also check us out at **www.wm-coffman.com**.

1. Choose an Over-the-Post or Post-to-Post System

Over-the-Post stairways incorporate a continuous handrail that is set atop the newels and balusters for the length of the stair run and allow for the use of a variety of decorative fittings.

Post-to-Post stairways feature a handrail that connects into an upper square block on the newel.



OVER-THE-POST



POST-TO-POST

2. Select Your Wood Species

Give your staircase a personal touch with beautiful wood. Consider selecting from our standard species that include Red Oak, White Oak, Poplar, Hard Maple, and Beech. Add a higher degree of distinction with virtually any custom wood species. We will craft virtually any style of stair in the exotic specie of your choice.

Contact us today for information at **sales@wm-coffman.com**.



RED OAK



WHITE OAK



POPLAR



HARD MAPLE



BEECH



MAHOGANY

3. Select Your Baluster Style

All wood balusters are either pin top or square top. Pin top balusters have turned, round tops that are inserted into holes drilled into an unplowed handrail (as well as Iron Balusters). Square top balusters have a turned portion, leaving a square upper and lower portion. Square top balusters require a plowed handrail and fillet.



PIN TOP



SQUARE TOP

4. Choose Your Collection

Our extensive Collections are created to fit your style and your home's interior setting. Their design possibilities are almost limitless. Find the look that works best for you. Choose the profile you like and combine it with your preference of Newel design.

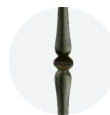

5. Select Your Handrail

Most handrails are available either plowed or unplowed, as shown in the pictures, and are designed to correspond to your selection of baluster type.



PLOWED



UNPLOWED

6. Add Detail with Design Options

Enhance your staircase with a wealth of decorative design accessories. Our appealing array of starting steps, rosettes and tread brackets provides finishing touches to create a richly decorated stairway that you and your family will cherish. You will find many finely crafted options throughout this book to help you create your perfect stairway.



ROSETTE



STARTING STEP



TREAD BRACKET

Product Summary

Box Newels



4075

4290

4291-ADJ

4091

4077

4695/4691

4095

4891-FP

4891-RP

4090

4690

4790

4890

4092

4094

Page 14

Page 16

Page 17

Page 18

Page 19

Post-to-Post Systems



4040/4042
4045/4046
4055

4540/4542
4545/4546
4547/4548

4550/4555
4556

4001/4002
4003/4007
4008/4009

4240/4242
4245

4004/4005
4006

4070

4840/4845

4172/4175
4176

4179

4280/4280L
4285

4282/4282L
4287

4440/4442
/4445/4446

4074/4076

3040/3042
3045/3046

Page 25

Page 26

Page 27-28

Page 28

Page 29

Page 30

Page 31

Page 31

Page 32

Over-the-Post Systems



4010/4011
4015

4014

4019

4030/4035

4065

4210/4211
4215

4662

4810/4815

4862

4111/4115

4270/4275

4272/4277

4410/4415

4419

3010/3011
3015

Page 24

Page 26

Page 27

Page 28

Page 29

Page 30

Page 31

Page 32

1/2" Iron Baluster Options

TWIST & BASKET SERIES

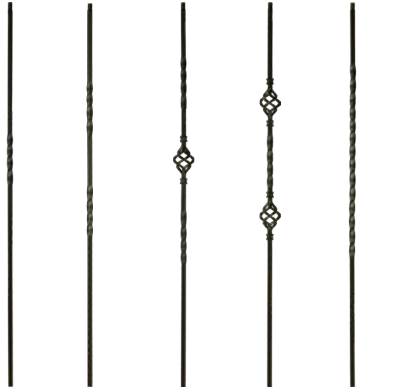

2550 2551 2552 2553 2554
1TW 2TW 1BASK 2BASK 1TW22

Page 38

KNEE WALL SERIES

VERSATILE SERIES

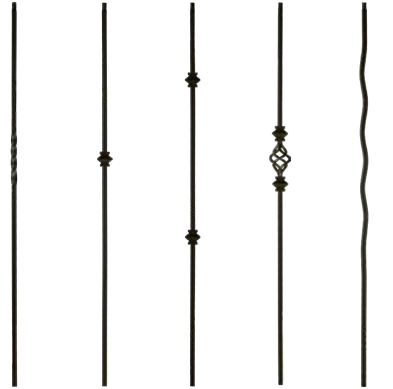

2555 2556 2557 2558 2968
PLA 1KNUC 2KNUC 2K1BA WAVE

Page 39

SCROLL SERIES

RIBBON SERIES



2560 2561 2962 2963
1RIB 2RIB M80 M85

Page 40

MEDALLION SERIES

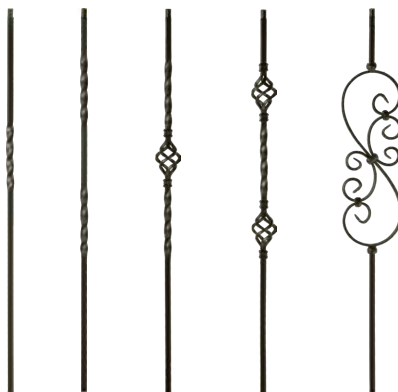

2650 2651 2652 2653 2685
KW1TW KW2TW KW1BA KW2BA KWM501

Page 41

BELLY SERIES

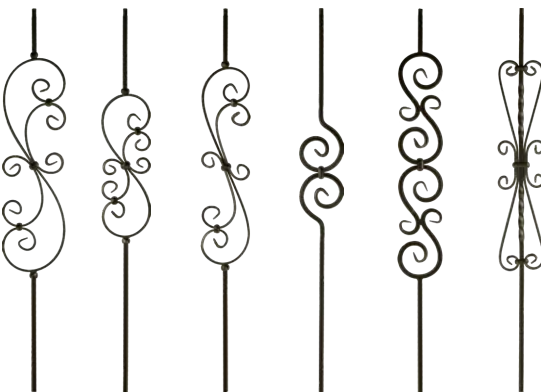

2580 2585 2581 2582 2583 2982
M301 M501 M601 M325 M326 M331

Page 42-43

ROUND SERIES

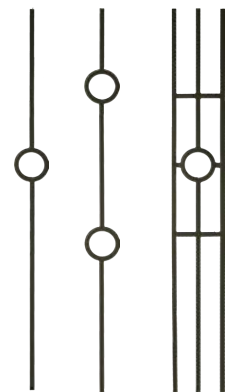

2930 2931 2933
M401 M402 M411

Page 44

LIBERTY SERIES

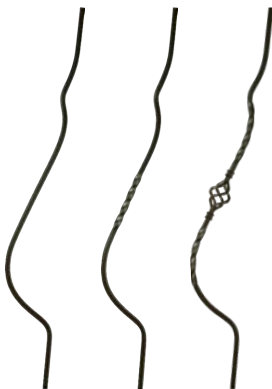

2986 2987 2988
PLA-BLY 1TW-BLY 1BASK-BLY

Page 45

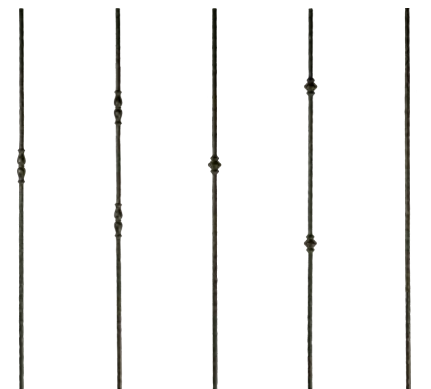

2770 2771 2772 2773 2775
R601 R602 R611 R612 R600

Page 48

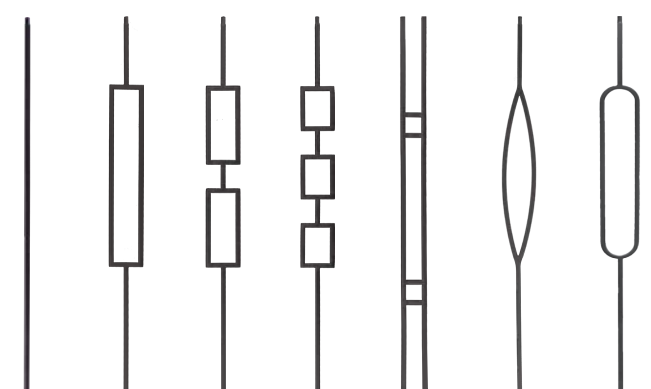

2555 2670 2671 2672 2673 2677 2674
PLA M435 M438 M439 M436 M432 M437

Page 57

9/16" Iron Baluster Options

MEDITERRANEAN

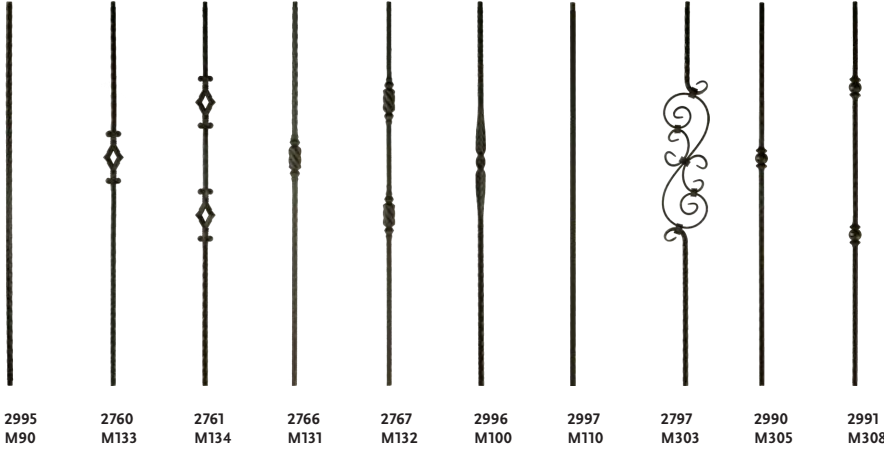

2995 M90 2760 M133 2761 M134 2766 M131 2767 M132 2996 M100 2997 M110 2797 M303 2990 M305 2991 M308

Page 46-47

GOTHIC



2570 M140 2571 M150 2572 M160 2575 M143

Page 50

5/8" Iron Baluster Options

9/16" ROUND SERIES



2970 R543 2971 R540 2972 R550

Page 49

VENETIAN SERIES



2595 M651 2596 M652 2597 M653 2598 M650

Page 51

MODERN VENETIAN SERIES

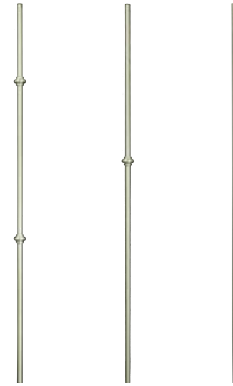

2974 R54844 2973 R54544 2970 R54344

Page 56

3/4" Iron Baluster Options

MEGA BALUSTER SERIES



2850 M-1TW 2851 M-2TW 2852 M-1BASK 2853 M-2BASK 2855 M-PLA 2856 M-1KNUC 2857 M-2KNUC 2881 M-M601

Page 52-53

Iron Newels



2450 N-IBASK
2452 N-ITW
2940 N-140
2455 NEWL-PLA48

Page 55

DECORATIVE PANELS



2490 M590

Page 54



2491 M399



2492 M555

Shoe & Knuckle Options

1/2" SHOES

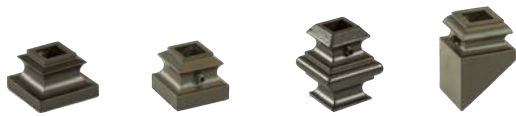

2340 FSH-01
2342 M-06
2345 AK-01
2350 PSH-02

Page 58

1/2" ROUND SHOES



2910 SCR-04
2911 M-020
2912 M-022

2370 R 08F
2371 R 09P

Page 59

5/8" SHOES



2375 R-10
2352 RAK-01

Page 59

9/16" SHOES



2341 H-03
2915 H-06
2351 H-05P

Page 58

9/16" ROUND SHOES



2916 R 07F
2917 R-06P
2918 RAK-03

Page 59

3/4" SHOES

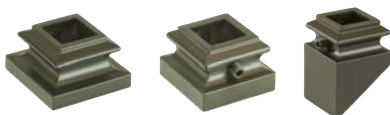

2391 M-FSH-08
2392 M-M-08
2390 M-PSH-08

Page 58

UNIVERSAL (1/2" OR 9/16") SHOES



2330 RM-301
2331 RM-201
2919 RD-201
2929 SQ-301

Page 59

NEWEL KIT



2360 NC-101

Page 59

Wood Collection



Coffman offers a wide range of in-stock species. Select your personal preference of style from a range of series. These inspired classics will accentuate your home and can be mixed and matched to create a personal touch. If you want to get a better visual, we invite you to visit our website and try our Stair Artist feature to see your vision realized. We offer a wide range of wooden stair parts in our 6 in-stock species with the option of additional custom species. For more information about our custom stair parts program, please reach out to one of our representatives at sales@wm-coffman.com.

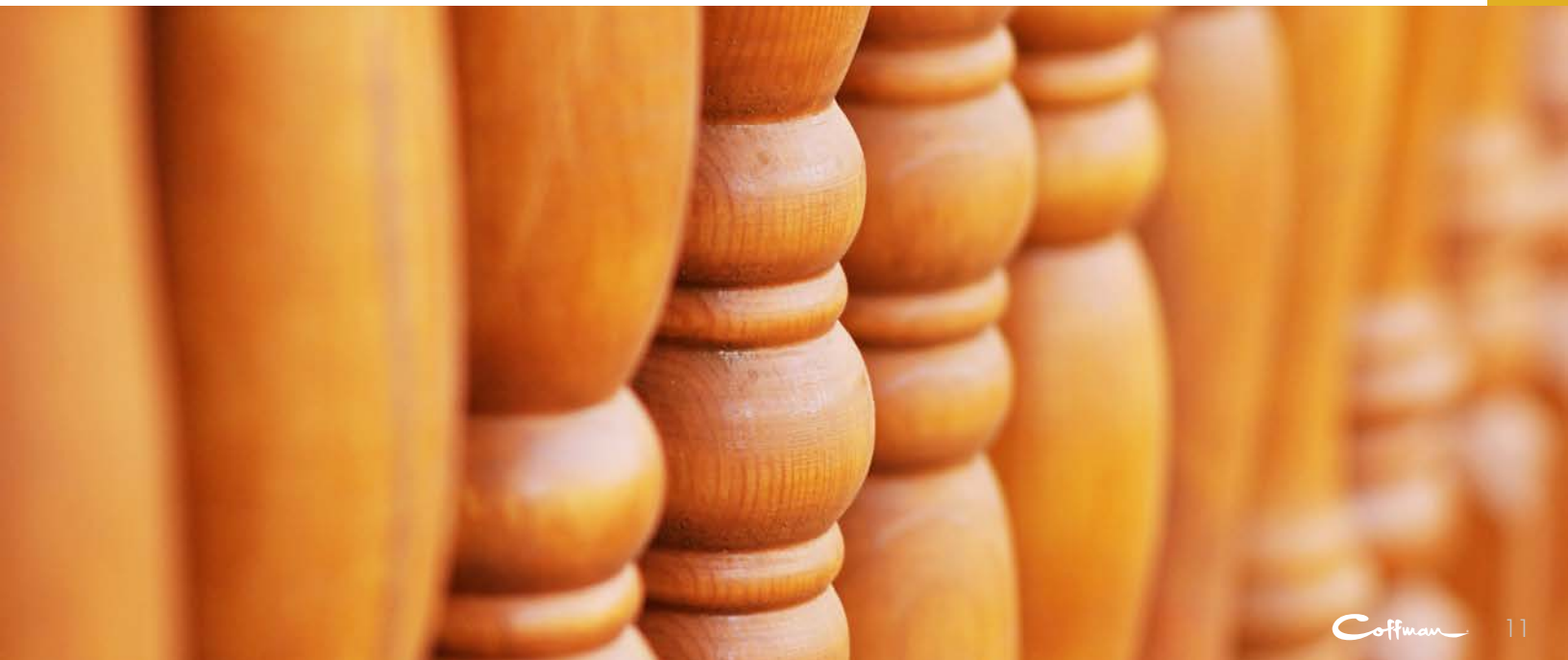

Wood Species Guide

Stocking:



Custom:



Available Stocking Wood Species

Coffman Stair Parts offers a large selection of quality stair parts in the most popular wood species including Red Oak, White Oak, Poplar, Hard Maple, and Beech. We also offer a wide range of Primed White options.

Box Newels

Removable Cap Style



Peak Cap



Flat Cap

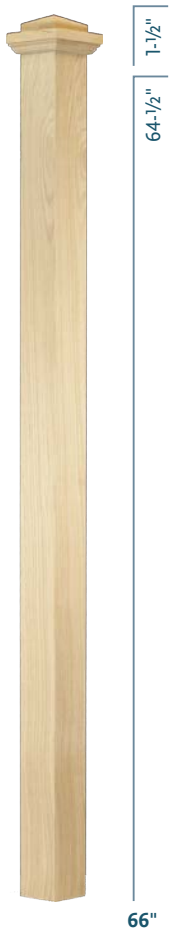

C-4075
Landing
Base Width 3-1/2"
*Also available in 50"
Length

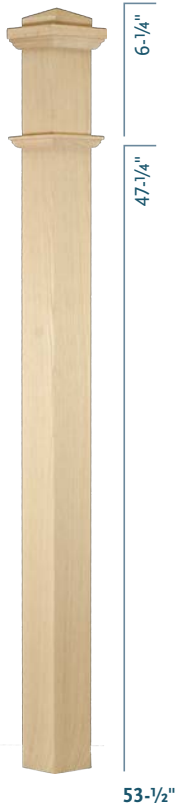

C-4290
Landing
Base Width 3-1/2"



C-4291ADJ
Adjustable
Base Width 3-1/2" without sleeve
Base Width 5" with sleeve



C-4091
Plain
Base Width 6-1/4"
*RO, POP, and PR do not
include EZ Mount Block



C-4091-F
Fluted
Base Width 6-1/4"



Fluted Panel



Raised Panel



Flat Panel



C-4091-FP
Flat Panel
Base Width 6-1/4"

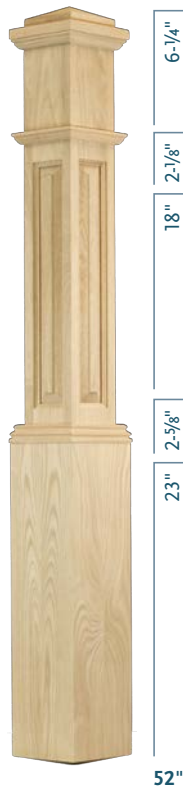

C-4091-RP
Raised Panel
Base Width 6-1/4"



C-4091-IP
Int. Panel
Base Width 6-1/4"

*RO, POP, and PR do not include EZ Mount Block

Each Box Newel Family has unique Cap and Trim designs. Ex: Removable Cap Style Box Newels have a different Cap and Trim as the Fixed Cap Style Box Newels, etc.

All Removable Cap Style Box Newels come with a Flat Cap and a Pyramid Cap to give more design options.

All 3-1/2" and 4-1/2" Box Newels have solid bases. All 6-1/4" and 7-1/2" Box Newels have a hollow base for easier installation (using the Coffman EZ Mount Installation Block).

Box Newels

Fixed Cap Style



4695 Fixed Cap



4691 Flat Panel



4691 Raised Panel



C-4077
Landing
Base Width 3-1/2"

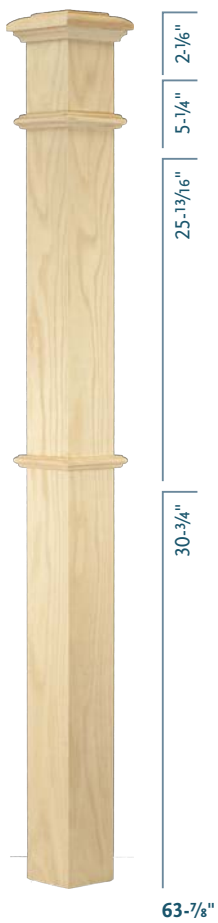

C-4695
Plain
Base Width 4-1/2"

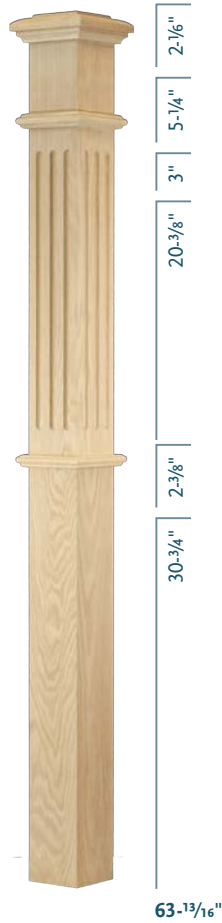

C-4695-F
Fluted
Base Width 4-1/2"

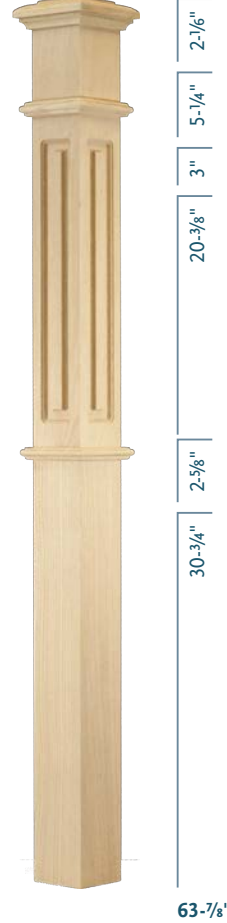

C-4695-RP
Raised Panel
Base Width 4-1/2"

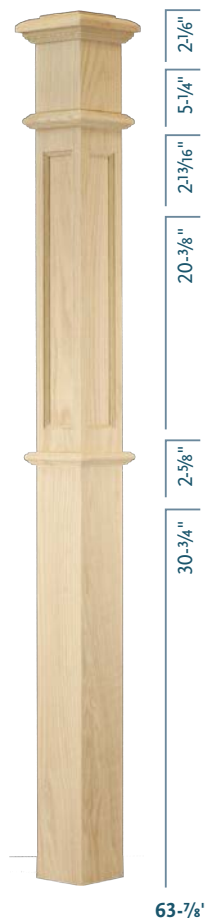

C-4691-FP
Flat Panel
Base Width 4-1/2"

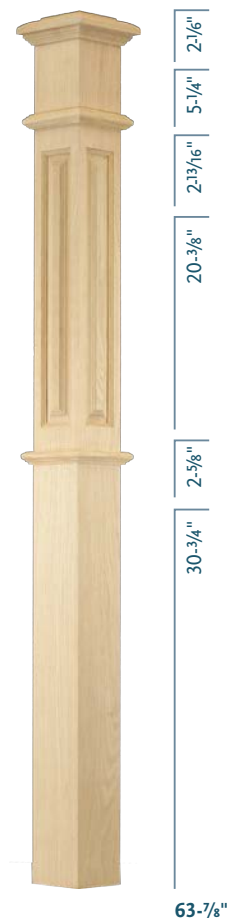

C-4691-RP
Raised Panel
Base Width 4-1/2"



4095 Fluted Panel



4095 Raised Panel



C-4095
Plain
Base Width 7-1/2"

C-4095-F
Fluted
Base Width 7-1/2"

C-4095-RP
Raised Panel
Base Width 7-1/2"

Box Newels

Fixed Cap Style



4891 Flat Panel



4891 Raised Panel

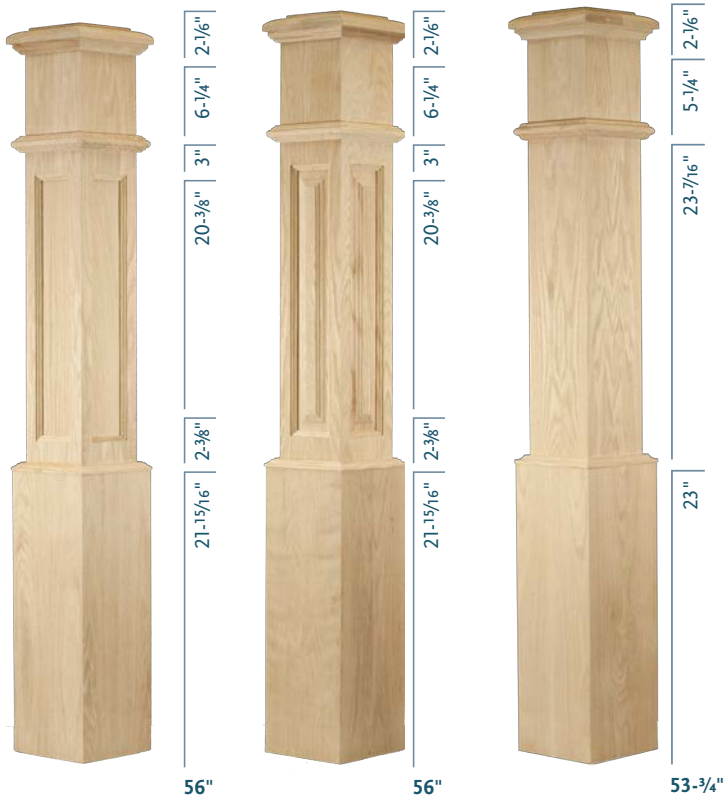

C-4891-FP
Flat Panel
Base Width 7-1/2"

C-4891-RP
Raised Panel
Base Width 7-1/2"

C-4090
Plain
Base Width 6-1/4"

Mission Style

Craftsman style



4890 Mission Panel



4092 & 4094 Craftsman Panel



C-4690
Mission
Base Width 4-1/2"



C-4790
Mission
Base Width 6-1/4"



C-4890
Mission
Base Width 7-1/2"



C-4092
Craftsman
Base Width 5"



C-4094
Craftsman
Base Width 6-1/2"

Interchangeable Box Newels

Coffman's new interchangeable Box Newel collection offers you the ability to create the perfect box newel for any stair. Caps for our IBN series come with loose trim to enable a perfect fit on our IBN posts. Sleeves for our IBN series come with loose top sleeve trim to ensure a tight fit on the post.

To Create Your Own Custom Box Newel, Select:

1. Plain or Flat Panel



PLAIN

OR

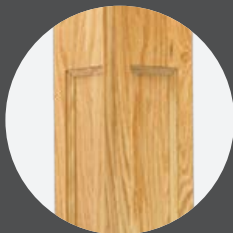

FLAT PANEL

Mission Panel
also available

2. Sleeve & Width

Available to fit all
size posts
3-1/2", 4-1/2",
or 5-1/2"



Overall Sleeve Width
3-1/2" post – 5" overall
4-1/2" post – 6" overall
5-1/2" post – 7" overall



Craftsman Sleeve Trim available

3. Cap & Trim

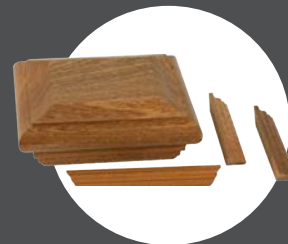

WMC IBN CAP & TRIM

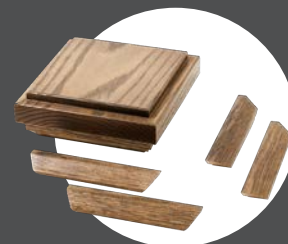

CRAFTSMAN IBN CAP
& TRIM

Available to fit
all size posts
3-1/2", 4-1/2" or 5-1/2"

Available in: Red Oak, Poplar, Primed,
Hard Maple, White Oak, & Mahogany

Ask us about our New England Cap Style



Craftsman Cap & Trim



Plain Primed Post



Plain Primed Post with Red Oak Cap



Plain Primed Post with Red Oak Cap & Trim Set



Plain Primed Post with Red Oak Cap, Trim Set & Primed Sleeve



Plain Primed Post with Mahogany Cap, Trim Set & Primed Sleeve

Standard IBN

- C-4378**
3-1/2"
- C-4078**
4-1/2"
- C-4578**
5-1/2"

Craftsman Trim/Cap

- C-312-TC**
3-1/2"
- C-412-TC**
4-1/2"
- C-512-TC**
5-1/2"

Wood Series





Coffman Stair Parts has a rich history of offering a variety of beautifully crafted wood stair parts. Our attention to detail and focus on quality has allowed Coffman to be an industry leader for over 140 years. We offer a wide range of styles in the most popular species (Red Oak, White Oak, Poplar, Hard Maple, and Beech) and can create any part you need in virtually any species.

Traditional Series

Over-the-Post Pintop Newels

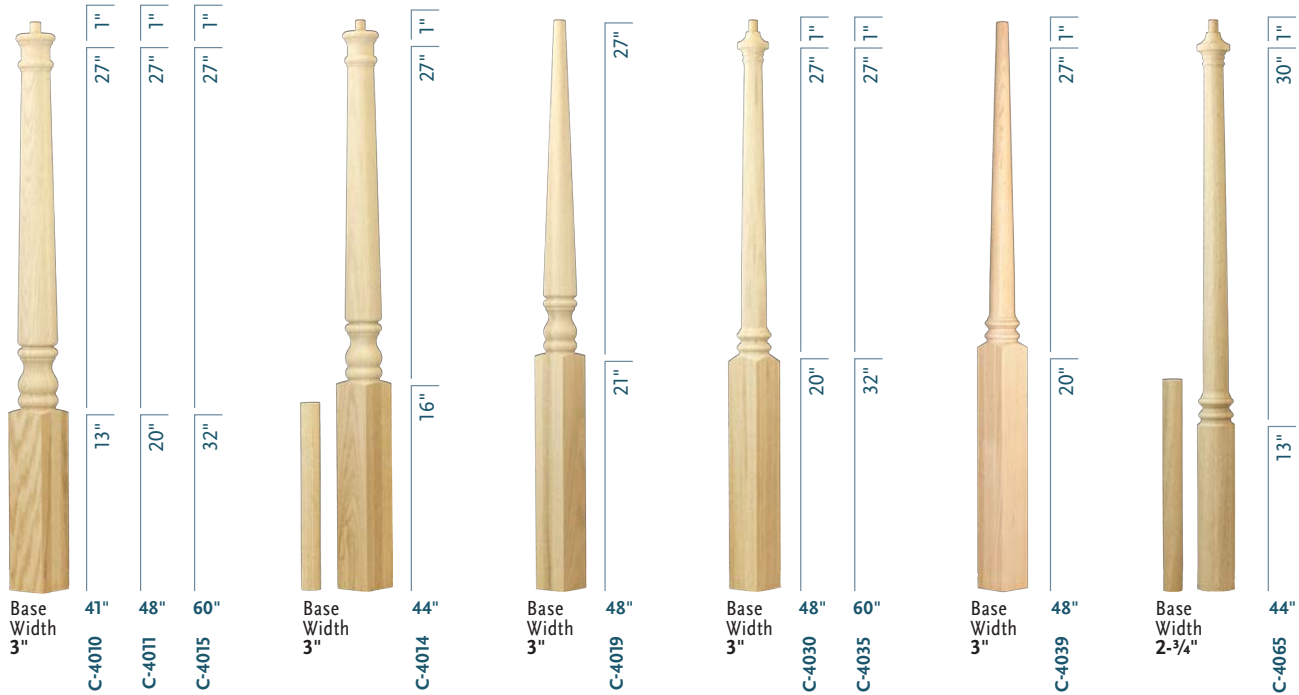



Pintop Balusters

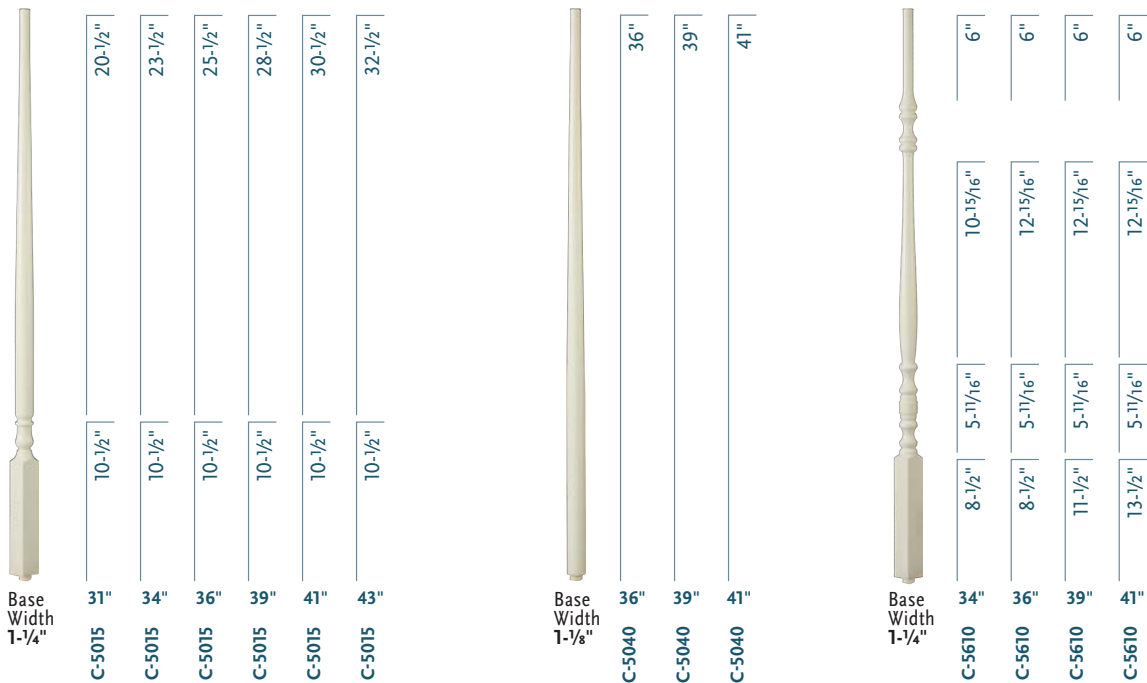





USE WITH NON-PLOWED HANDRAIL





Post-to-Post Newels

	16-7/8"	23-1/4"	5"	2-3/8"
C-4040	47-1/2"			
	22-7/8"	23-1/4"	5"	2-3/8"
C-4042	53-1/2"			
	23-7/8"	23-1/4"	10"	2-3/8"
C-4045	59-1/2"			
	20-7/8"	23-1/4"	13"	2-3/8"
C-4046	59-1/2"			
	25-7/8"	18-1/4"	13"	2-3/8"
C-4046S	59-1/2"			
	37-3/8"	23-1/4"	5"	2-3/8"
C-4055	68"			





	16-7/8"	23-1/4"	5"	2-3/8"
C-4040-1	47-1/2"			





	18"	20-1/2"	6-1/2"	3"
C-4540	48"			
	24"	20-1/2"	6-1/2"	3"
C-4542	54"			
	25-1/2"	15-1/2"	10"	3"
C-4545	54"			
	22-1/2"	15-1/2"	13"	3"
C-4546	54"			
	26-1/2"	15-1/2"	15"	3"
C-4547	60"			
	31-1/2"	20-1/2"	6-1/2"	3"
C-4548	61-1/2"			

	20"	17-1/2"	6-1/2"	4"
C-4550BT	48"			
	26"	17-1/2"	6-1/2"	4"
C-4555BT	54"			
	19-1/2"	17-1/2"	13"	4"
C-4556BT	54"			

Square Top Balusters

USE WITH 1-1/4" PLOWED HANDRAIL

	9-1/2"	16-1/8"	5-3/8"
C-5070	31"		
	9-1/2"	19-1/8"	5-3/8"
C-5070	34"		
	9-1/2"	21-1/8"	5-3/8"
C-5070	36"		
	9-1/2"	24-1/8"	5-3/8"
C-5070	39"		
	9-1/2"	26-1/8"	5-3/8"
C-5070	41"		

	6-7/8"	19"	5-1/8"
C-5067	31"		
	6-7/8"	22"	5-1/8"
C-5067	34"		
	6-7/8"	24"	5-1/8"
C-5067	36"		
	9-7/8"	24"	5-1/8"
C-5067	39"		
	11-7/8"	24"	5-1/8"
C-5067	41"		

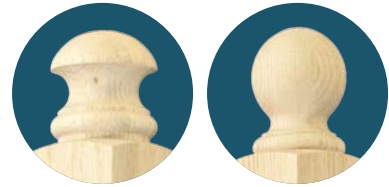

4040 SERIES NEWELS AVAILABLE
IN MUSHROOM & BALL TOP









Hampton Series

Over-the-Post Pintop Newels

	13"	5-11/16"	12-15/16"	2-7/8"	5-1/2"	1"
C-4210	41"					
	20"	5-11/16"	12-15/16"	2-7/8"	5-1/2"	1"
C-4211	48"					
	32"	5-11/16"	12-15/16"	2-7/8"	5-1/2"	1"
C-4215	60"					
	16"	5-11/16"	12-15/16"	2-7/8"	5-1/2"	1"
C-4662	44"					





Round Base

Post-to-Post Newels

	20"	17-1/2"	6-1/2"	3-1/2"		
C-4007	47-1/2"					
	28-1/2"	17-1/2"	6-1/2"	3-1/2"		
C-4008	56"					
	22"	17-1/2"	13"	5-1/2"		
C-4009	58"					
	16"	5-11/16"	10-15/16"	2-7/8"	7-3/16"	4-3/16"
C-4240	46-7/8"					
	24-1/2"	5-11/16"	10-15/16"	2-7/8"	7-3/16"	4-3/16"
C-4242	55-3/8"					
	22-3/16"	5-11/16"	10-15/16"	2-7/8"	13"	4-3/16"
C-4245	58-7/8"					
	17"	17-1/2"	9-1/2"	3-1/2"		
C-4001	47-1/2"					
	25-1/2"	17-1/2"	9-1/2"	3-1/2"		
C-4002	56"					
	22-1/2"	17-1/2"	16"	3-1/2"		
C-4003	59-1/2"					

Pintop Balusters

USE WITH NON-PLOWED HANDRAIL

	8-1/2"	5-11/16"	10-15/16"	2-7/8"	6"
C-5611	34"				
	8-1/2"	5-11/16"	12-15/16"	2-7/8"	6"
C-5611	36"				
	11-1/2"	5-11/16"	12-15/16"	2-7/8"	6"
C-5611	39"				
	13-1/2"	5-11/16"	12-15/16"	2-7/8"	6"
C-5611	41"				

Square Top Balusters

USE WITH 1-3/4" PLOWED HANDRAIL

	12-3/4"	17-1/2"	5-3/4"		
C-5005	36"				
	17-3/4"	17-1/2"	5-3/4"		
C-5005	41"				
	8-1/2"	5-11/16"	10-15/16"	2-7/8"	6"
C-5601	34"				
	8-1/2"	5-11/16"	12-15/16"	2-7/8"	6"
C-5601	36"				
	11-1/2"	5-11/16"	12-15/16"	2-7/8"	6"
C-5601	39"				
	13-1/2"	5-11/16"	12-15/16"	2-7/8"	6"
C-5601	41"				



Art Deco Series

Over-the-Post Pintop Newels

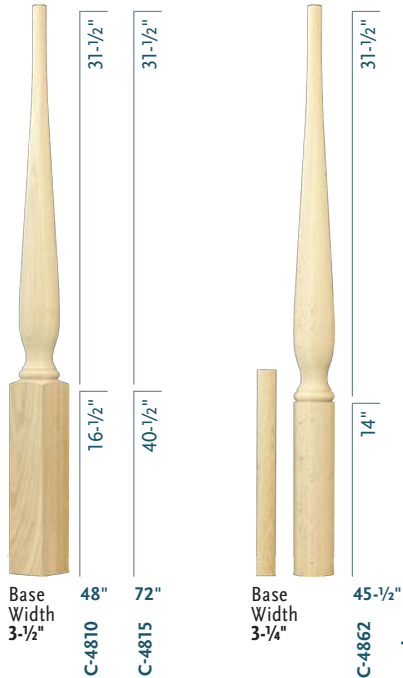

Round Base

Post-to-Post Newels



Classic Series

Pintop Balusters

USE WITH NONPLOWED HANDRAIL

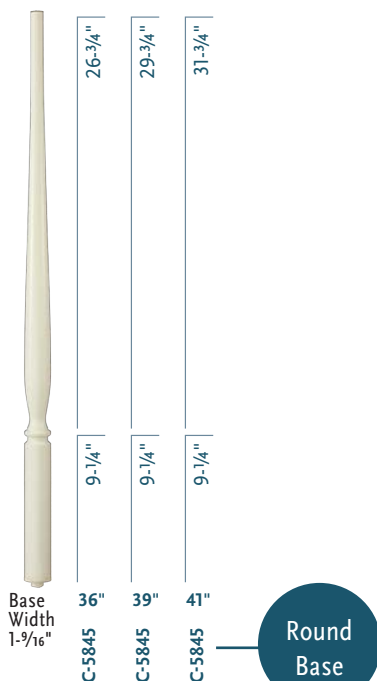

Round Base

Post-to-Post newels

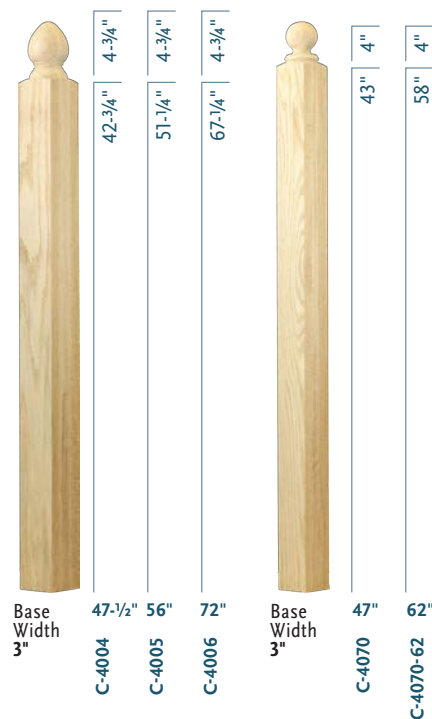

Bristol Series

Over-the-Post Pintop Newels

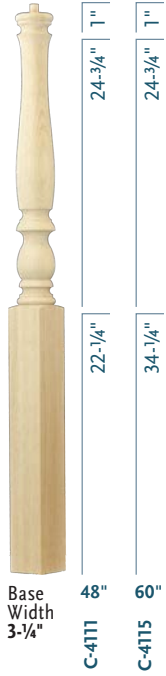

Post-to-Post Newels



Pintop Balusters

USE WITH NON-PLOWED HANDRAIL

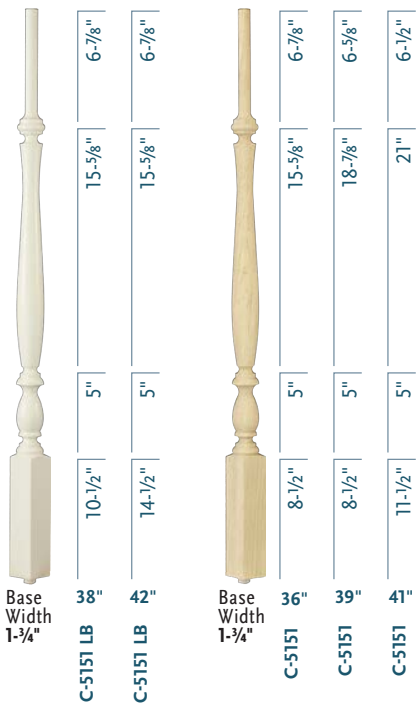

Square Top Balusters

USE WITH 1-3/4" PLOWED HANDRAIL

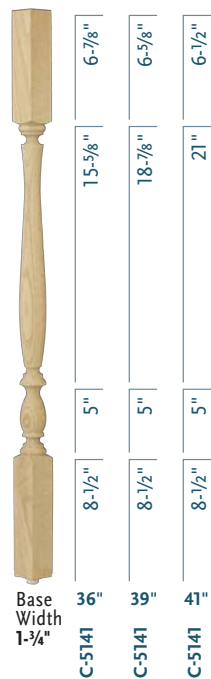

Chippendale Series

Over-the-Post Pintop Newels



Base Width 3-1/2"	41"	12"	28"	1"
	C-4270			
	60"	31"	28"	1"
	C-4275			

Post-to-Post Newels



Base Width 3-1/2"	48"	16"	6-3/4"	13"	5"	4-1/2"
	C-4280					
	56"	24"	6-3/4"	13"	5"	4-1/2"
	C-4280L					
	60"	24"	6-3/4"	9"	13"	4-1/2"
	C-4285					

Pintop Balusters

USE WITH NON-PLOWED HANDRAIL



Base Width 1-3/4"	34"	8-1/2"	5-1/2"	9-1/2"	10-1/2"
	C-5211				
	36"	8-1/2"	5-1/2"	9-1/2"	12-1/2"
	C-5211				
	39"	8-1/2"	5-1/2"	9-1/2"	15-1/2"
	C-5211				
	41"	8-1/2"	5-1/2"	9-1/2"	17-1/2"
	C-5211				

Square Top Balusters

USE WITH 1-3/4" PLOWED HANDRAIL

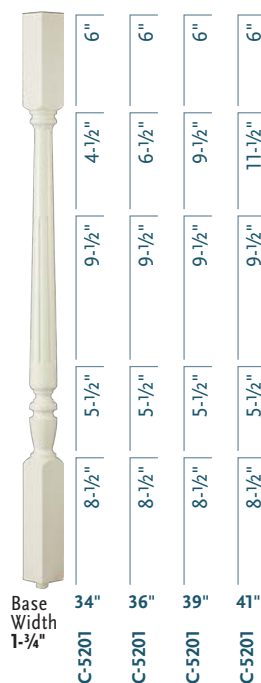

Base Width 1-3/4"	34"	8-1/2"	5-1/2"	9-1/2"	4-1/2"	6"
	C-5201					
	36"	8-1/2"	5-1/2"	9-1/2"	6-1/2"	6"
	C-5201					
	39"	8-1/2"	5-1/2"	9-1/2"	9-1/2"	6"
	C-5201					
	41"	8-1/2"	5-1/2"	9-1/2"	11-1/2"	6"
	C-5201					

Marion Series

Over-the-Post Pintop Newels

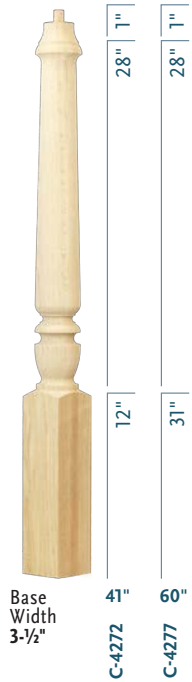

Post-to-Post Newels

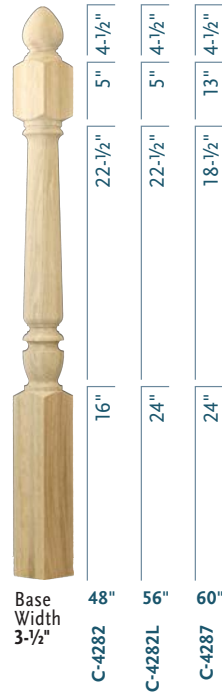

Pintop Balusters

USE WITH NON-PLOWED HANDRAIL

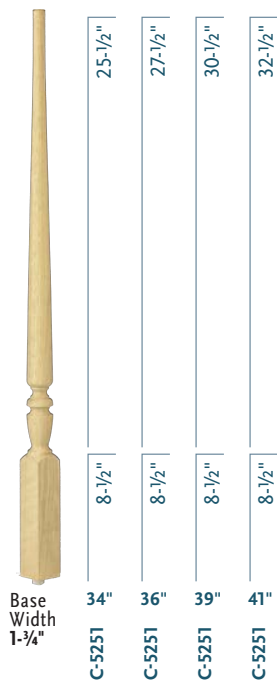

Square Top Balusters

USE WITH 1-3/4" PLOWED HANDRAIL

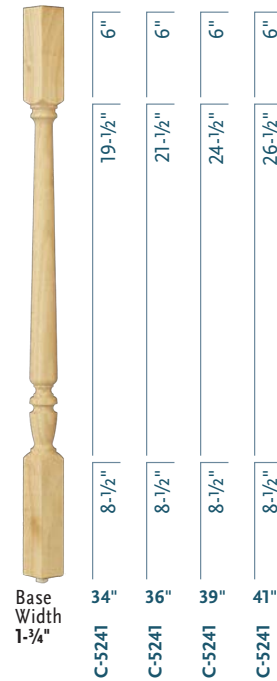

Richmond Series

Over-the-Post Pintop Newels

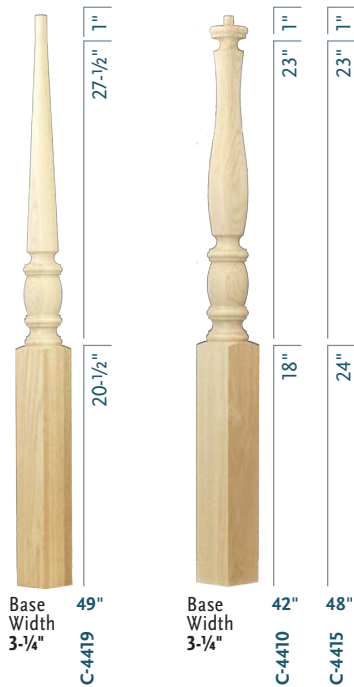

Post-to-Post Newels

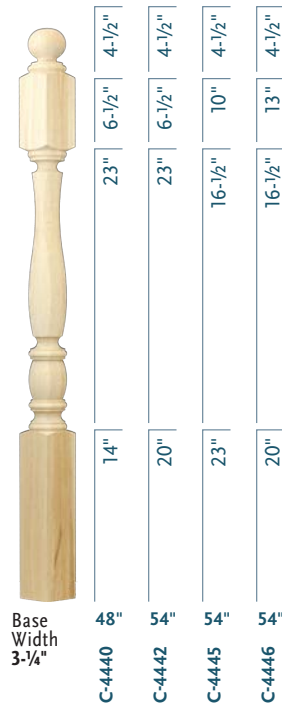

Craftsman Series

Post-to-Post Newels



Square Top Balusters

USE WITH PLOWED HANDRAIL



Gatlin Series

Over-the-Post Pintop Newels



Base Width 3-1/2"	43"	15"	27"	1"
	C-3010	20"	27"	1"
	C-3015	32"	27"	1"

Post-to-Post Newels



Base Width 3-1/2"	48"	15-3/4"	22-1/2"	5-1/4"	5"
	C-3040	23-1/4"	22-1/2"	5-1/4"	5"
	C-3042	23-1/2"	17-1/2"	10"	5"
	C-3045	19"	17-1/2"	14"	5"
C-3046					

Pintop Balusters

USE WITH NON-PLOWED HANDRAIL



Base Width 1-3/4"	35"	7-1/2"	27-1/2"
	C-2015	7-1/2"	29-1/2"
	C-2015	7-1/2"	31-1/2"
	C-2015	7-1/2"	33-1/2"
	C-2015	7-1/2"	35-1/2"

Square Top Balusters

USE WITH 1-3/4" PLOWED HANDRAIL



Base Width 1-3/4"	35"	8-1/2"	19-3/4"	6-3/4"
	C-2005	16-1/2"	19-3/4"	6-3/4"
C-2005				



GATLIN SERIES

WOOD COLLECTION

Iron Collection



Coffman Stair Parts offers a vast collection of quality iron balusters in both Hollow and Solid. Our offerings include 8 finishes (Flat Black, Satin Black, Powder Coat (Gray/Black), Antique Bronze, Oil Rubbed Bronze, Oil Rubbed Copper, Ash Gray, and Brushed Nickel). We also offer Horizontal Tubing and Silver Lining Cable Railing in Stainless Steel.

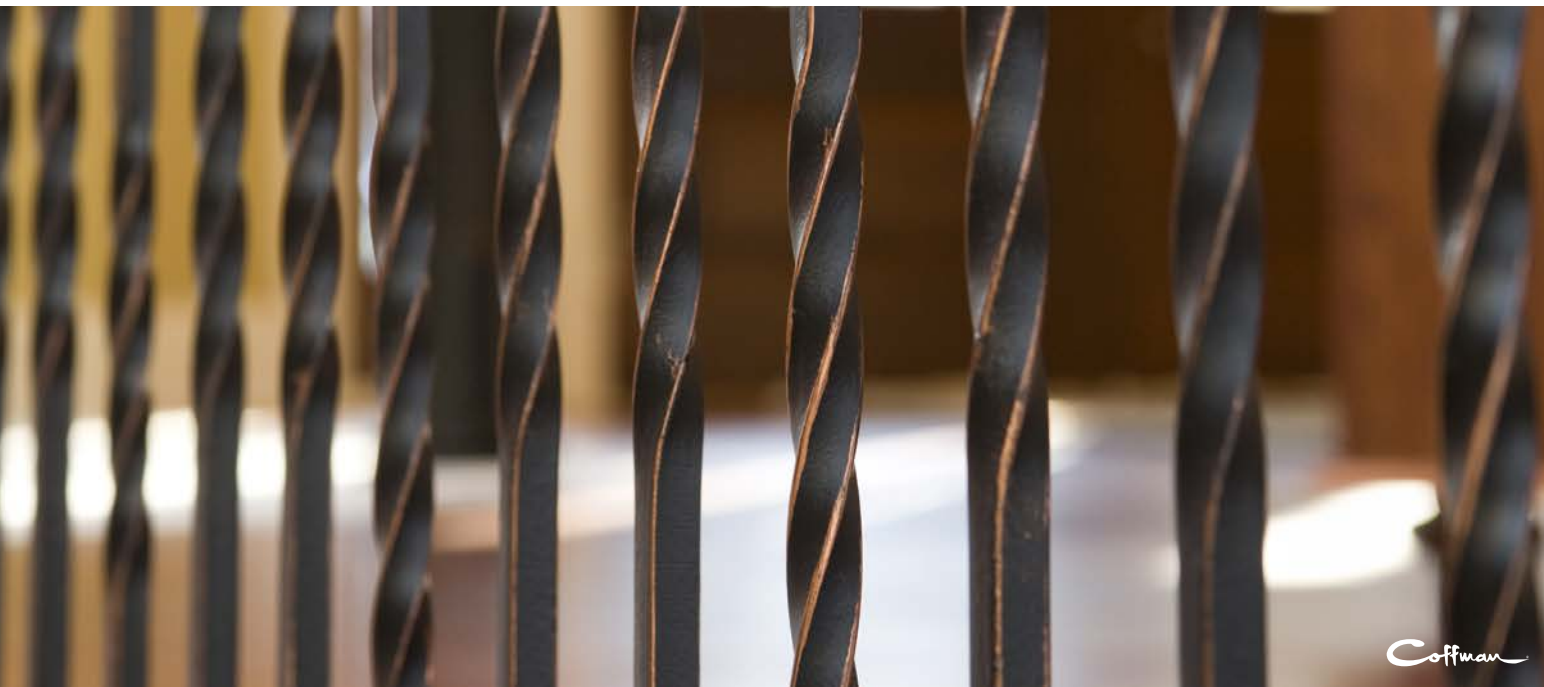

Iron Finish Guide



BLK
Flat
Black



SAT
Satin
Black



PC
Powder
Coat



ABZ
Antique
Bronze



ORB
Oil Rubbed
Bronze





ORC
Oil Rubbed
Copper



AG
Ash
Gray



BN
Brushed
Nickel



Available Iron Finishes

Coffman Stair Parts 8 finishes offer the options you need to create a welcoming staircase with the warmth of iron. Use the Coffman Stair Artist tool (wm-coffman.com) to create a unique pattern for your stairway.

Twist & Basket Series

USE WITH 1/2" SQUARE SHOES FOUND ON PAGE 58



2550
1TW44
1/2" x 44"
Solid Iron
ABZ, BLK, ORB, ORC, SAT

Lite Iron
ABZ, BLK, ORB, ORC, PC,
SAT, AG

2551
2TW44
1/2" x 44"
Solid Iron
ABZ, BLK, ORB, ORC, SAT

Lite Iron
ABZ, BLK, ORB, ORC, PC,
SAT, AG

2552
1BASK44
1/2" x 44"
Solid Iron
ABZ, BLK, ORB, ORC, SAT

Lite Iron
ABZ, BLK, ORB, ORC, PC,
SAT, AG

2553
2BASK44
1/2" x 44"
Solid Iron
ABZ, BLK, ORB, ORC, SAT

Lite Iron
ABZ, BLK, ORB, ORC, PC,
SAT, AG

2554
1TW22
1/2" x 44"
Solid Iron
ABZ, BLK, ORB, ORC, SAT

Lite Iron
ABZ, BLK, ORB, ORC, SAT

BASKET DETAIL

TWIST DETAIL

Versatile Series

USE WITH 1/2" SQUARE SHOES FOUND ON PAGE 58

NEW & IMPROVED
KNUCKLE COMING
IN 2020



2555
PLA44
1/2" x 44"

Solid Iron
ABZ, BLK, ORB, ORC, SAT

Lite Iron
ABZ, BLK, ORB, ORC, PC,
SAT, AG



2556
1KNUC44
1/2" x 44"

Solid Iron
ABZ, BLK, ORB, ORC, SAT

Lite Iron
ABZ, BLK, ORB, ORC, PC,
SAT, AG



2557
2KNUC44
1/2" x 44"

Solid Iron
ABZ, BLK, ORB, ORC, SAT

Lite Iron
ABZ, BLK, ORB, ORC, PC,
SAT, AG



2558
2KNUC1BASK44
1/2" x 44"

Lite Iron
ABZ, BLK, ORB, ORC, SAT



2968
WAVE44
1/2" x 44"

Lite Iron
ABZ, BLK, ORB, ORC, SAT



KNUCKLE DETAIL
(ORIGINAL)



KNUCKLE BASKET DETAIL

VERSATILE SERIES

TWIST & BASKET SERIES

IRON COLLECTION

Ribbon Series

USE WITH 1/2" SQUARE SHOES FOUND ON PAGE 58



2560
1RIB44
1/2" x 44"
Solid Iron
ABZ, BLK, ORB, ORC, SAT
Lite Iron
ABZ, BLK, ORB, ORC, SAT



2561
2RIB44
1/2" x 44"
Solid Iron
ABZ, BLK, ORB, ORC, SAT
Lite Iron
ABZ, BLK, ORB, ORC, SAT



2962
M8044
1/2" x 44"
Solid Iron
SAT
Lite Iron
ABZ, BLK, ORB, ORC, SAT



2963
M8544
1/2" x 44"
Solid Iron
SAT
Lite Iron
ABZ, BLK, ORB, ORC, SAT



RIBBON DETAIL

Knee Wall Series

USE WITH 1/2" SQUARE SHOES FOUND ON PAGE 58



2650
KW-1TW44
1/2" x 36"

Lite Iron
ORB, SAT



2651
KW-2TW44
1/2" x 36"

Lite Iron
ORB, SAT



2652
KW-1BASK44
1/2" x 36"

Lite Iron
ORB, SAT



2653
KW-2BASK44
1/2" x 36"

Lite Iron
ORB, SAT



2685
KW-M501
1/2" x 36"

Lite Iron
ORB, SAT



KW BASKET DETAIL



M501 DETAIL

KNEE WALL SERIES

RIBBON SERIES

IRON COLLECTION

Scroll Series

USE WITH 1/2" SQUARE SHOES FOUND ON PAGE 58



2580
M30144
1/2" x 44"
Solid Iron
ABZ, BLK, ORC, ORB, PC, SAT,
Lite Iron
ABZ, BLK, ORB, ORC, PC, SAT



2585
M50144
1/2" x 44"
Lite Iron
ABZ, BLK, ORB, ORC, SAT



2581
M60144
1/2" x 44"
Solid Iron
ABZ, BLK, ORB, ORC, SAT
Lite Iron
ABZ, BLK, ORB, ORC, SAT



2582
M32544
1/2" x 44"
Lite Iron
ABZ, BLK, ORB, ORC, SAT



2583
M32644
1/2" x 44"

Lite Iron
BLK, ORB, SAT



2982
M33144
1/2" x 44"

Solid Iron
SAT
Lite Iron
SAT



M301 DETAIL



M325 DETAIL



M326 DETAIL

Medallion Series

USE WITH 1/2" SQUARE SHOES FOUND ON PAGE 58

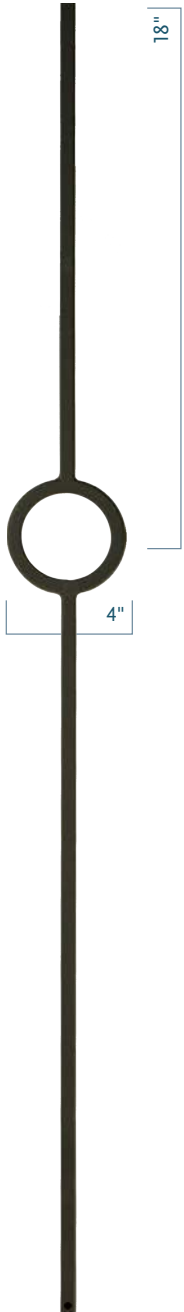

2930
M40144
1/2" x 44"
Solid Iron
BLK
Lite Iron
BLK, SAT, AG



2931
M40244
1/2" x 44"
Solid Iron
BLK
Lite Iron
BLK, SAT, AG

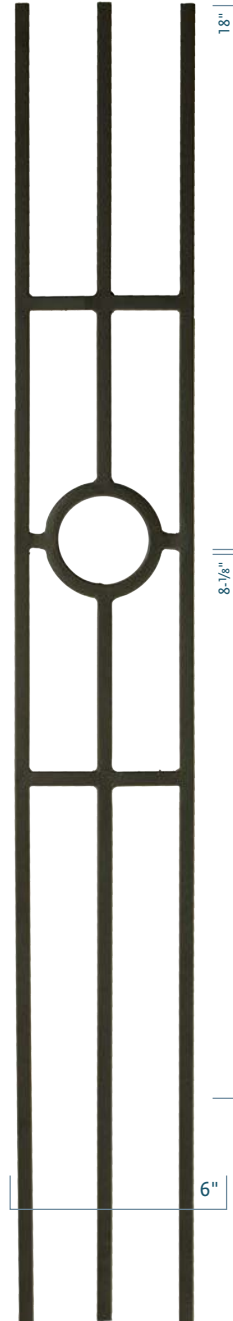

2933
M41144
1/2" x 44"
Solid Iron
BLK
Lite Iron
BLK, SAT, AG



MEDALLION DETAIL



M41144 DETAIL

Belly Series

USE WITH 1/2" SQUARE SHOES FOUND ON PAGE 58



2986
PLA40-BLY
1/2" x 40"
Solid Iron
SAT
Lite Iron
SAT



2987
1TW40-BLY
1/2" x 40"
Solid Iron
SAT
Lite Iron
SAT



2988
1BASK40-BLY
1/2" x 40"
Solid Iron
SAT
Lite Iron
SAT

Mediterranean Series

USE WITH 9/16" SQUARE SHOES FOUND ON PAGE 58

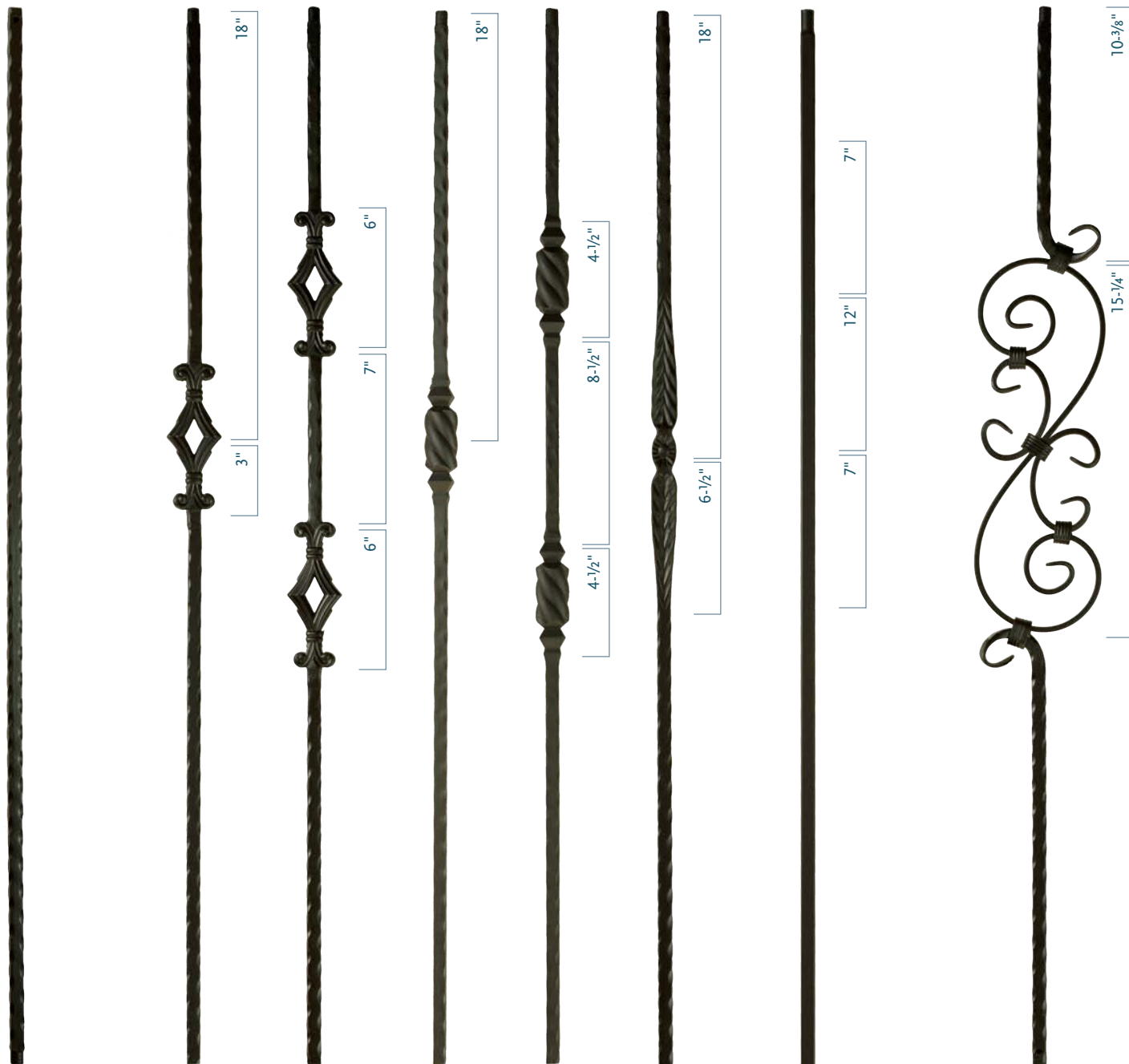

- | | | | | | | | |
|--|--|--|---|---|--|---|--|
| 2995
M9044
9/16" x 44"
Solid Iron
ABZ, BLK, ORB, ORC, SAT | 2760
M13344
9/16" x 44"
Solid Iron
ORB, SAT | 2761
M13444
9/16" x 44"
Solid Iron
ORB, SAT | 2766
M13144
9/16" x 44"
Solid Iron
BLK, ORB, SAT | 2767
M13244
9/16" x 44"
Solid Iron
BLK, ORB, SAT | 2996
M10044
9/16" x 44"
Solid Iron
BLK, ORB, ORC, SAT | 2997
M11044
9/16" x 44"
Solid Iron
ABZ, BLK, ORB, ORC, SAT | 2797
M30344
9/16" x 44"
Solid Iron
ORB, SAT |
| Lite Iron
ABZ, BLK, ORB, ORC, SAT | | | | | Lite Iron
ORB, ORC, SAT | Lite Iron
ORB, ORC, SAT | |



FLOWER & ARROW



BEEHIVE



ARROW



BALL



WINDOW



PLAIN



3 PIECE SCROLL

2990
 M30544
 9/16" x 44"
 Solid Iron
ABZ, BLK, ORB, ORC, SAT
 Lite Iron
ABZ, BLK, ORB, ORC, SAT

2991
 M30844
 9/16" x 44"
 Solid Iron
ABZ, BLK, ORB, ORC, SAT
 Lite Iron
ABZ, BLK, ORB, ORC, SAT

1/2" Round Series

USE WITH 1/2" ROUND SHOES FOUND ON PAGE 59



2770
R60144
1/2" x 44"
Solid Iron
ORB, SAT



2771
R60244
1/2" x 44"
Solid Iron
ORB, SAT



2772
R61144
1/2" x 44"
Solid Iron
ORB, SAT



2773
R61244
1/2" x 44"
Solid Iron
ORB, SAT



2775
R60044
1/2" x 44"
Solid Iron
ORB, SAT



URN



VICTORIAN



PLAIN ROUND

9/16" Round Series

USE WITH 9/16" ROUND SHOES FOUND ON PAGE 59



2970
R54344
9/16" x 44"
Solid Iron
BLK
Lite Iron
BLK



2971
R54044
9/16" x 44"
Solid Iron
BLK
Lite Iron
BLK



2972
R55044
9/16" x 44"
Solid Iron
BLK
Lite Iron
BLK



GOTHIC

Gothic Series

USE WITH 9/16" SQUARE SHOES FOUND ON PAGE 58



2575
M14344
9/16" x 44"
Solid Iron
ABZ, BLK, ORB, ORC, SAT
Lite Iron
ABZ, BLK, ORB, ORC, SAT



2570
M14044
9/16" x 44"
Solid Iron
ABZ, BLK, ORB, ORC, SAT
Lite Iron
ABZ, BLK, ORB, ORC, SAT



2571
M15044
9/16" x 44"
Solid Iron
ABZ, BLK, ORB, ORC, SAT
Lite Iron
ABZ, BLK, ORB, ORC, SAT



2572
M16044
9/16" x 44"
Solid Iron
ABZ, BLK, ORB, ORC, SAT
Lite Iron
ABZ, BLK, ORB, ORC, SAT



KNUCKLE DETAIL



HAMMERED DETAIL



BASKET DETAIL

Venetian Series

USE WITH 5/8" ROUND SHOES FOUND ON PAGE 59



2595
M65144
5/8" x 44"

Lite Iron
BLK, ORB, ORC, SAT



2596
M6522
5/8" x 44"

Lite Iron
BLK, ORB, ORC, SAT



2597
M65344
5/8" x 44"

Lite Iron
BLK, ORB, ORC, SAT



2598
M65044
5/8" x 44"

Lite Iron
BLK, ORB, ORC, SAT



VENETIAN KNUCKLE



M650 DETAIL



VENETIAN FLUTE DETAIL

Mega Series

USE WITH 3/4" SQUARE SHOES FOUND ON PAGE 58



2850
MEGA-1TW
3/4" x 44"

Lite Iron
ABZ, BLK, ORB, ORC, SAT



2851
MEGA-2TW
3/4" x 44"

Lite Iron
ABZ, BLK, ORB, ORC, SAT



2852
MEGA-1BASK
3/4" x 44"

Lite Iron
ABZ, BLK, ORB, ORC, SAT



2853
MEGA-2BASK
3/4" x 44"

Lite Iron
ABZ, BLK, ORB, ORC, SAT



2855
MEGA-PLA
3/4" x 44"

Lite Iron
ABZ, BLK, ORB, ORC, SAT



2856
MEGA-1KNUC
3/4" x 44"

Lite Iron
ABZ, BLK, ORB, ORC, SAT



2857
MEGA-2KNUC
3/4" x 44"

Lite Iron
ABZ, BLK, ORB, ORC, SAT

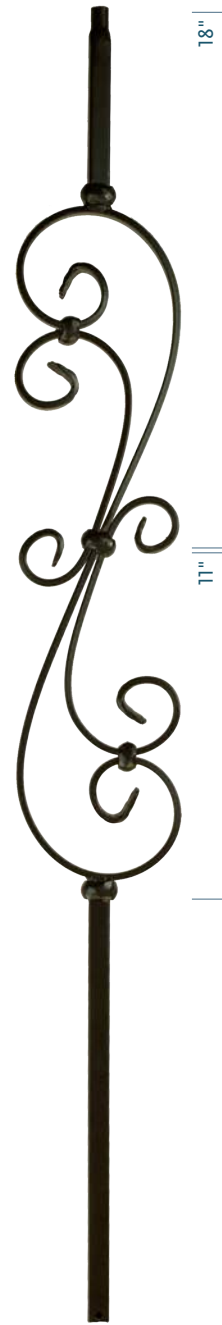

2881
MEGA-M601
3/4" x 44"

Lite Iron
ABZ, BLK, ORB, ORC, SAT

Decorative Panels

USE WITH 1/2" SQUARE SHOES FOUND ON PAGE 58

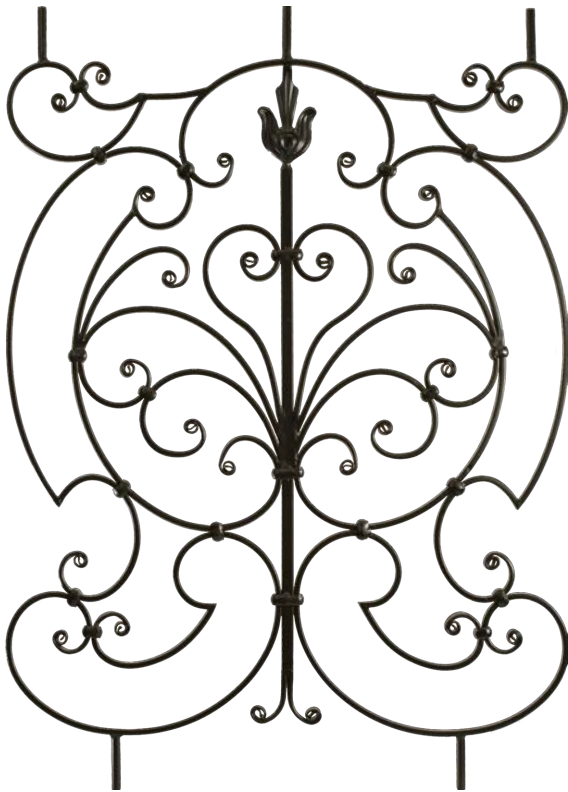

2490
REN-PANEL
1/2" x 42"

Lite Iron
ABZ, BLK, ORB, ORC,



2491
REN-PANEL
1/2" x 44"

Lite Iron
ABZ, BLK, ORB, ORC, SAT



2492
REN-PANEL
1/2" x 41"

Lite Iron
ABZ, BLK, ORB, ORC, SAT

Iron Newels

USE WITH 1-3/16" NEWEL KIT SHOES FOUND ON PAGE 59



2450
NEWL-BASK48
1-3/16" x 48"
Solid Iron
SAT



2452
NEWL-TW48
1-3/16" x 48"
Solid Iron
SAT



2940
NEWL-14048
1-3/16" x 48"
Solid Iron
SAT



2455
NEWL-PLA48
1-3/16" x 48"
Solid Iron
AG, SAT

Lite Iron
AG, SAT

SHOWN IN ASH GRAY

Modern Venetian Series

USE WITH 5/8" ROUND SHOES FOUND ON PAGE 59



2974
R54844
5/8" x 44"

Lite Iron
AG, BN



2973
R54544
5/8" x 44"

Lite Iron
AG, BN



2970
R54344
5/8" x 44"

Lite Iron
AG, BN



MODERN VENETIAN DETAIL

The look of
Stainless at an
affordable cost

Liberty Series

USE WITH 1/2" SQUARE SHOES FOUND ON PAGE 58

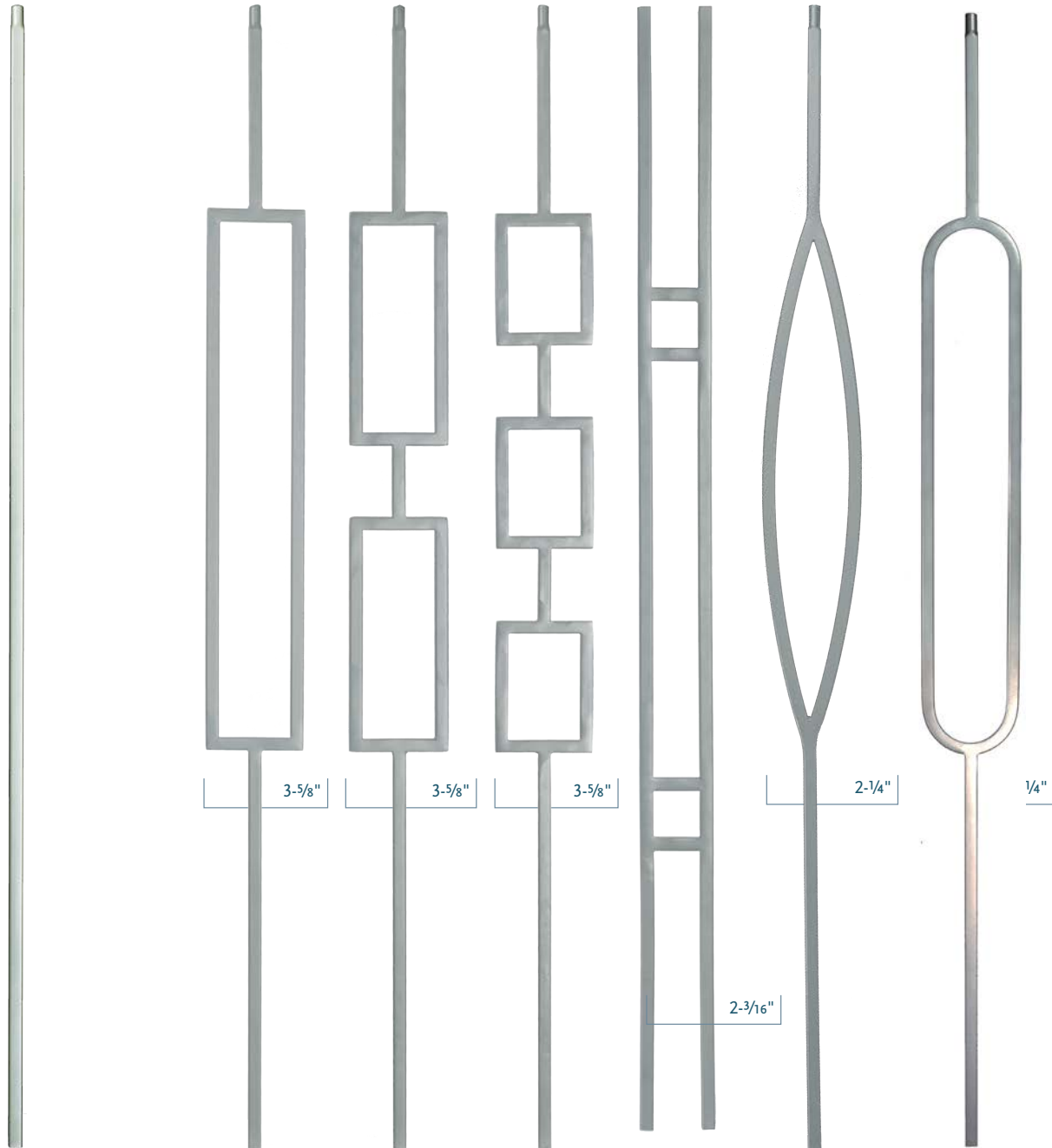

2555
PLA
1/2" x 44"

Solid Iron
ABZ, BLK, ORB, ORC, SAT

Lite Iron
ABZ, AG, BLK, ORB, PC,
ORC, SAT

2670
M435
1/2" x 44"

Lite Iron
AG, SAT

2671
M438
1/2" x 44"

Lite Iron
AG, SAT

2672
M439
1/2" x 44"

Lite Iron
AG, SAT

2673
M436
1/2" x 44"

Lite Iron
AG, SAT

2677
M432
1/2" x 44"

Lite Iron
AG, SAT

2674
M437
1/2" x 44"

Lite Iron
AG, BLK, SAT

Shoe & Knuckle Options

BE SURE TO SELECT SHOES THAT ARE THE SAME SIZE AND SHAPE AS YOUR IRON BALUSTERS.

1/2" Square Shoes and Knuckles

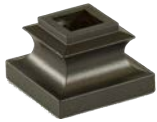

2340
FSH-01



2342
M-06



2345
AK-01



2350
PSH-02



2910
SCR-04

Solid Iron
ABZ, BLK, ORB, ORC, SAT

Lite Iron
ABZ, BLK, ORB, ORC, SAT

2342, 2345, 2350 available in PC
2342, 2350 available in AG



2911
M-020
Solid Iron
ABZ

Lite Iron
AG, SAT



2912
M-022
Lite Iron
BLK

9/16" Square Shoes



2341
H-03



2315
H-06



2351
H-05P

Solid Iron
ABZ, BLK, ORB, ORC, SAT

Lite Iron
ABZ, BLK, ORB, ORC, SAT

3/4" Square Shoes

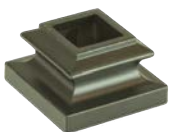

2391
M-FSH-08



2392
M-M-08



2390
M-PSH-08

Solid Iron
ABZ, BLK, ORB, ORC, SAT

Lite Iron
ABZ, BLK, ORB, ORC, SAT

1/2" Round Shoes



2370
R-08F



2371
R-09P

Solid Iron
ORB, SAT

5/8" Round Shoes and Knuckles



2375
R-10

Lite Iron
ABZ, AG, BLK, ORB, ORC,
SAT, BN



2352
RAK-01

Lite Iron
SAT

9/16" Round Shoes and Knuckles



2916
R-07F

Solid Iron
BLK

Lite Iron
BLK



2917
R-06P

Lite Iron
BLK



2918
RAK-03

BLK

Newel Kit



2360
NC-101

Solid Iron
AG, SAT

Universal (1/2" or 9/16") Shoes



2330
RM-301

Solid Iron
ORB, SAT

Lite Iron
ABZ, BLK, ORC



2331
RM-201

Lite Iron
SAT



2919
RD-201

Solid Iron
ABZ, BLK, ORB, ORC, SAT

Lite Iron
ABZ, BLK, ORB, ORC, SAT



2929
SQ-301

Solid Iron
ORB, SAT



Modern Collection

6700
4074
SS-TUBE-065



MODERN COLLECTION

Swageless Fittings



803973
Tensioning Level Fitting



803975
Tensioning Rake Fittings



803972
Non-Tensioning Level Fitting



803974
Non-Tensioning Rake Fittings

Modern Railings



C-6700 Non-Plowed
2-1/2" x 1-5/8"



C-6840 Non-Plowed
2-3/8" x 1-5/8"

Hollow Tubes

*ALSO AVAILABLE IN SATIN BLACK AND ASH GRAY



SS-Tube-065
Stainless Steel 304
5/8" x 96"



SS-Tube-050
Stainless Steel 304
1/2" x 96"

SL-Tools & Accessories



803982
Pre-Drilled



803983
UnDrilled



803978
SL-Cable Cutter



803980
SL-S.S. Post Protector



803979
SL-Cable Release



SS-573500
Stainless Steel Newel Mount Bracket



SS-573505
Stainless Steel Wall Mount Bracket



803981
SL-Mandrel / Cut-Off Wheels

Handrails & Details



Rail Series

Traditional Series

LENGTHS AVAILABLE: 8', 10', 12', 14', 16', 18', AND 20'



C-6010
Non-Plowed
2-1/4" x 2-3/8"

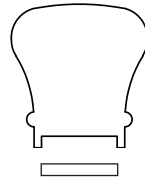

C-6010P
Plowed 1-1/4"
2-1/4" x 2-3/8"

Not available in 20'

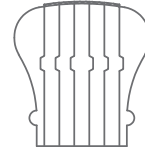

C-6016
Bending Rail
2-1/4" x 2-3/8"

Classic Series

LENGTHS AVAILABLE: 8', 10', 12', 14', AND 16'

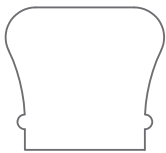

C-6210
Non-Plowed
2-5/8" x 2-3/8"

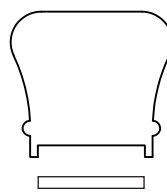

C-6210P1
Plowed 1-3/4"
2-5/8" x 2-3/8"

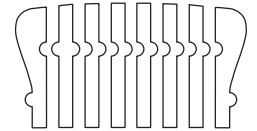

C-6216
Bending Rail
2-5/8" x 2-3/8"

Comes in 20'

Bristol Series

LENGTHS AVAILABLE: 8', 12', AND 16'



C-6110
Non-Plowed
2-3/4" x 2-3/4"



C-6110P1
Plowed 1-3/4"
2-3/4" x 2-3/4"



C-6116
Bending Rail
2-3/4" x 2-3/4"

Comes in 20'

Richmond Series

LENGTHS AVAILABLE: 8', 12', AND 16'



C-6410
Non-Plowed
2-5/8" x 2-3/8"

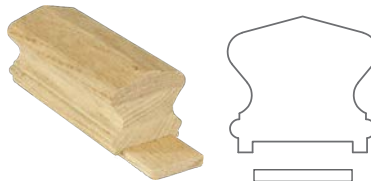

C-6410P1
Plowed 1-3/4"
2-5/8" x 2-3/8"



C-6416
Bending Rail
2-5/8" x 2-3/8"

Fillet



C-6050
1-1/4"

Comes in flat and crowned



C-6007
1-3/4"

Georgian Series

LENGTHS AVAILABLE: 8', 12', AND 16'



C-6310
Non-Plowed
2-5/8" x 2-1/4"

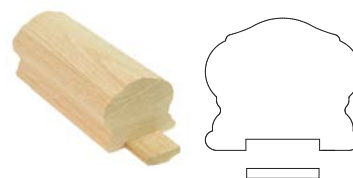

C-6310P1
Plowed 1-3/4"
2-5/8" x 2-1/4"

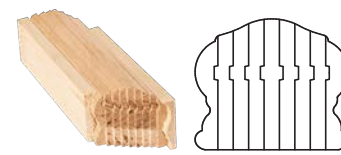

C-6316
Bending Rail
2-5/8" x 2-1/4"

Make sure that if you have chosen Square Top Balusters that you select the appropriate Plowed Handrail. Coffman handrails are available in Finger Joint, Solid Cap, and Engineered.

Please Note:

All Coffman Bending handrails come with bending moulding and all Coffman Plowed handrails and shoerails come with fillet installed. "1-1/4" fillet available flat and crowned

Rail Series

Craftsman Series

LENGTHS AVAILABLE: 16'



C-6700
Non-Plowed
2-1/2" x 1-5/8"

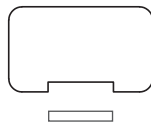

C-6700P
Plowed 1-1/4"
2-1/2" x 1-5/8"

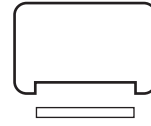

C-6700P1
Plowed 1-3/4"
2-1/2" x 1-5/8"



C-6840
Non-Plowed
2-5/8" x 1-5/8"

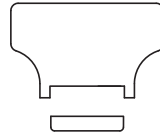

C-6840P
Plowed 1-1/4"
2-5/8" x 1-5/8"

Comes in 8' & 12'

Chatham Series

LENGTHS AVAILABLE: 16'

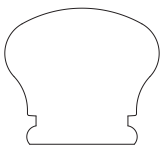

C-6009
Non-Plowed
2-5/8" x 2-5/16"

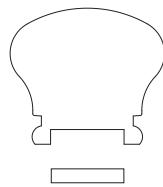

C-6009P
Plowed 1-1/4"
2-5/8" x 2-5/16"

Shoe Rail



C-6045
Plowed 1-3/4"
2-1/2" x 3/4"

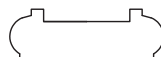

C-6006
Plowed 1-3/4"
2-5/8" x 2-1/4"

Wall Rail

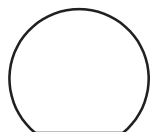

C-6040
1-11/16" x 1-1/2"



C-7023
Quarterturn
Use with C-6040



C-7024
Starting Easing
Use with C-6040



C-7025
Starting Easing
Use with C-6040



C-6042
2-1/4" x 1-9/32"



C-7005
Quarterturn
Use with C-6042

Rail Fittings

The 2nd digit of the Fitting part number identifies the profile and must match the 2nd digit of the Rail part number.
 (Example: C-70XX Fittings = C-6010 Rail / C-72XX Fittings = C-6210 Rail.)



TRADITIONAL C-6010	BRISTOL C-6110	CLASSIC C-6210	GEORGIAN C-6310	RICHMOND C-6410
-----------------------	-------------------	-------------------	--------------------	--------------------

Starting Fittings should be used with Pintop Newels at the base of the staircase.

	TRADITIONAL C-6010	BRISTOL C-6110	CLASSIC C-6210	GEORGIAN C-6310	RICHMOND C-6410
VERTICAL VOLUTE	C-7031				
LEFT HAND VOLUTE USE WITH PIN TOP NEWELS	C-7030	C-7130	C-7230	C-7330	C-7430
RIGHT HAND VOLUTE USE WITH PIN TOP NEWELS	C-7035	C-7135	C-7235	C-7335	C-7435
STARTING EASING WITH CAP	C-7010	C-7110	C-7210	C-7310	C-7410
LEFT HAND TURNOUT	C-7040	C-7140	C-7240	C-7340	C-7440
RIGHT HAND TURNOUT	C-7045	C-7145	C-7245	C-7345	C-7445

STARTING FITTINGS



Transition Fittings are used to create a continual railing with all applications.

	TRADITIONAL C-6010	BRISTOL C-6110	CLASSIC C-6210	GEORGIAN C-6310	RICHMOND C-6410
COPED END	C-7007		C-7207		
RETURNED END	C-7009	C-7109	C-7209		
LEVEL QUARTERTURN 90°	C-7011 C-7C11	C-7111	C-7211	C-7311	C-7411

TRANSITIONAL FITTINGS





TRADITIONAL C-6010	BRISTOL C-6110	CLASSIC C-6210	GEORGIAN C-6310	RICHMOND C-6410
-----------------------	-------------------	-------------------	--------------------	--------------------

Transition Fittings are used to create a continual railing with all applications.



	TRADITIONAL C-6010	BRISTOL C-6110	CLASSIC C-6210	GEORGIAN C-6310	RICHMOND C-6410
UP EASING	C-7012S C-7C12S	C-7112S	C-7212S	C-7312S	C-7412S
OVER EASING	C-7013 C-7C13	C-7113	C-7213	C-7313	C-7413
UP EASING 90°	C-7014S C-7C14S	C-7114S	C-7214S	C-7314S	C-7414S
OVER EASING RETURNED END	C-7016		C-7216		
OPENING CAP USE WITH PIN TOP NEWELS	C-7019	C-7119	C-7219	C-7319	C-7419
TANDEM CAP USE WITH PIN TOP NEWELS	C-7020	C-7120	C-7220	C-7320	C-7420
QUARTERTURN CAP 90° USE WITH PIN TOP NEWELS	C-7021	C-7121	C-7221	C-7321	C-7421
LEVEL CAP 135° USE WITH PIN TOP NEWELS	C-7022	C-7122	C-7222		C-7422
LEVEL TURN 135°	C-7026	C-7126	C-7226		
5" CENTER TO CENTER LEFT	C-7047LH	C-7147LH	C-7247LH		C-7447LH
5" CENTER TO CENTER RIGHT	C-7047RH	C-7147RH	C-7247RH		C-7447RH

TRANSITIONAL FITTINGS cont.

RAIL FITTINGS

HANDRAILS & DETAILS

Rail Fittings

The 2nd digit of the Fitting part number identifies the profile and must match the 2nd digit of the Rail part number.

(Example: C-70XX Fittings = C-6010 Rail / C-72XX Fittings = C-6210 Rail.)



	TRADITIONAL C-6010	BRISTOL C-6110	CLASSIC C-6210	GEORGIAN C-6310	RICHMOND C-6410
LEFT HAND 2 RISER NO CAP 90°	C-7071			C-7371	
RIGHT HAND 2 RISER NO CAP 90°	C-7076			C-7376	
2 RISER WITH TANDEM CAP USE WITH PIN TOP NEWELS	C-7089			C-7389	
2 RISER NO CAP	C-7099 C-7C99	C-7199	C-7299	C-7399	C-7499
LEFT HAND 2 RISER WITH CAP USE WITH PIN TOP NEWELS	C-7060		C-7260		
RIGHT HAND 2 RISER WITH CAP USE WITH PIN TOP NEWELS	C-7065		C-7265		

GOOSENECK FITTINGS



	TRADITIONAL C-6010	BRISTOL C-6110	CLASSIC C-6210	GEORGIAN C-6310	RICHMOND C-6410	
LEFT HAND 2 RISER WITH CAP 135° USE WITH PIN TOP NEWELS	C-7061		C-7261			GOOSENECK FITTINGS cont.
RIGHT HAND 2 RISER WITH CAP 135° USE WITH PIN TOP NEWELS	C-7066		C-7266			
LEFT HAND 2 RISER WITH CAP USE WITH PIN TOP NEWELS	C-7081		C-7281			
RIGHT HAND 2 RISER WITH CAP USE WITH PIN TOP NEWELS	C-7086		C-7286			
2 RISER WITH CAP USE WITH PIN TOP NEWELS	C-7097		C-7297			

Details

Rosettes



C-7217
 $5\text{-}\frac{3}{8}'' \times 5\text{-}\frac{3}{8}'' \times \frac{3}{4}''$
 Top panel width $4\text{-}\frac{1}{2}''$

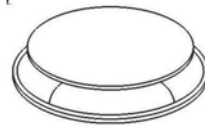

C-7317
 $4\text{-}\frac{5}{8}'' \times 4\text{-}\frac{5}{8}'' \times \frac{3}{4}''$
 Top panel width $3\text{-}\frac{3}{4}''$



C-7237
 $4\text{-}\frac{5}{16}'' \times 6\text{-}\frac{3}{16}'' \times \frac{3}{4}''$
 Top panel width $3\text{-}\frac{1}{2}''$

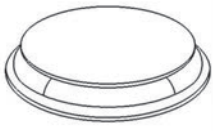

C-7337
 $4'' \times 5\text{-}\frac{1}{2}'' \times \frac{3}{4}''$
 Top panel width $3\text{-}\frac{1}{8}''$

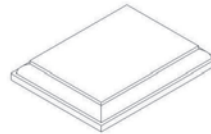

C-7318
 $4\text{-}\frac{3}{16}'' \times 5\text{-}\frac{3}{8}'' \times \frac{3}{4}''$
 Top panel width $3\text{-}\frac{5}{16}''$

Starting Steps

All Coffman Starting Steps are shipped with the necessary cove and shoe moulding. Single Bullnose Steps are Reversible and can be trimmed to length.



C-8010
 Usable with all Standard Turnouts and Volutes
 Available in 48", 54", 60", and 72"



C-8015
 Usable with all Standard Turnouts and Volutes
 Available in 48", 54", and 60"



C-8030
 Usable for Post-to-Post systems and works well with Box Newels.
 Available in 48" and 60"

C-8016
 Usable with all Standard Turnouts and Volutes as well as adjustable sizes for exact finishing fit.
 Available in 48" (trim from 43" to 48"), 53" (trim from 48" to 53"), and 58" (trim from 53" to 58")

Coffman treads are manufactured under highly controlled standards for beauty that will last a lifetime. We only carry solid, American-made treads. Coffman Tread & Riser Caps are used with applications where carpeting would be placed along the center. These components allow for the look of quality hardwood on either side.



C-8070
Tread – No Return
1-1/32" x 11-1/2"
1-1/32" x 13"



C-8070
Tread Blanks
Available in S4S and Nosed 2 Slides
Sizes Varies



C-8070 MR
Coped Reversible Return Tread
1-1/32" x 11-1/2"



C-8075
Riser
3/4" x 8"



C-8070 Hybrid
Reversible (Oak Reveal) Tread
1-1/32" x 11-1/2"



Landing Tread/Lineal Stock
C-8090 3-1/2" Wide
C-8390 3/8" x 5-1/4" Wide
C-8590 5-1/4" Wide
C-8690 6-1/2" Wide



C-6973 Skirtboard
1" x 8" (actual 11/16" x 7-1/4")
C-6975 Skirtboard
1" x 12" (actual 11/16" x 11-1/4")



C-8028 Tread Bracket
1/4" Thick
C-8028V Tread Bracket (Veneered)
1/4" Thick



C-8029 Tread Bracket
1/4" Thick
C-8029V Tread Bracket (Veneered)
1/4" Thick



C-8085
Shoe Mould
Lineal Stock
1/2" x 3/4"



C-8095
Cove Mould
Lineal Stock
13/16" x 5/8"



C-8080
Nosing
Lineal Stock
1-1/4" x 1-1/32"



C-8081
Nosing and Cove
Lineal Stock
1-1/4" x 1-27/32"



C-8080-13
13" Return
Nosing
1-1/4" x 1-1/32"



C-8080-13 MR
Coped Return
Nosing
1-1/4" x 1-1/32" x 13-3/4"

Details

Tread & Riser Caps



C-8070
Southern Yellow Pine Treads
(Clear and Carpet Grade)
1" x 11-1/4"



C-8071
Tread Cap with Mitered Return Nosing
and Cove (Left or Right)
5-5/8" x 12"



C-8072
Tread Cap with
Nosing and Cove
5-5/8" x 12"



C-8076
Riser Cap
5-1/4" x 8"



C-8011
Reversible Starting End Cap
Includes Cove & Shoe Mouldings



C-8010-2
Reversible Starting End Cap
(No Notch)
Moulding Not Included



C-8079
Reversible False Tread and Riser
5-1/4" x 8". Nosing and Cove is Loose and
Mitred for RH or LH

Job-Lot Epoxy Adhesive Systems



2302 Manual Dispenser
2303 Extra Mixing Nozzles – Packed 10 each
2401 Adhesive
Approximately 20 Balusters per Tube
25 Minute Open Working Time



2902 F-101 Injector Tool
2903 Extra Mixing Nozzle – 1 each
2901 F-300 8.5oz Epoxy
Approximately 50-70 Balusters per Tube
25 Minute Open Working Time



2905 5oz Adhesive Kit
Cartridge and Nozzle to be used in standard caulking gun
Approximately 50 Balusters per Tube
6 Minute Open Working Time

Wall Rail Brackets

Rail brackets are shipped with all installation hardware.



Standard Wall Rail Bracket
Wall-to-Center 2-3/4"
C-3631PB – 573002 Polished Brass
C-3631BN – 573039 Brushed Nickel
C-3631CHR – 573020 Chrome
C-3631FB – 573022 Flat Black
C-3631SB – 573023 Satin Black
C-3631ORB – 573105 Oil Rubbed Bronze



Long Arm Standard Wall Rail Bracket
Wall-to-Center 3-3/8"
C-3632PB – 573038 Polished Brass
C-3632BN – 573138 Brushed Nickel
C-3632ORB – 573135 Oil Rubbed Bronze



Premium Handrail Bracket
Wall-to-Center 2-3/4"
C-3621PB – 573003 Polished Brass
C-3621AB – 573009 Antique Brass
C-3621BN – 573007 Brushed Nickel
C-3621CHR – 573006 Chrome
C-3621BC – 573010 Brushed Chrome
C-3621B – 573008 Textured Black
C-3621SB – 573021 Satin Black
C-3621ORB – 573015 Oil Rubbed Bronze



Premium Handrail Bracket
Wall-to-Center 3-3/8"
C-3622PB – 573014 Polished Brass
C-3622BN – 573024 Brushed Nickel
C-3622ORB – 573025 Oil Rubbed Bronze



Iron Handrail Bracket
Wall-to-Center 3-1/4"
C-3611BLK – 573013 Flat Black
C-3611SAT – 573016 Satin Black
C-3611PC – 573012 Grey/Black
C-3611ABZ – 573011 Antique Bronze
C-3611ORB – 573019 Oil Rubbed Bronze
C-3611ORC – 573018 Oil Rubbed Copper
C-3611AN – 573017 Antique Nickel

Details

Hardware and Accessories



C-3301
Rail & Post Fastener
Includes Fastener, Washer, Nut, & Plugs



C-3302
Rail & Post Fastener
Includes Fastener, Washer, Nut, & Plugs
5/16"



C-3283
Key Lock
2" x 2-5/8" x 3/8"



EZ-Mount
for C-4091 Box Newels



C-3201
Baluster Fastener Drill Driver Kit
4 Fasteners
1/4"



C-3203 50 Pack
C-3203 B 100 Pack
Post Fastener
2-1/2" x 5/16"



C-3501
Newel Plate Fastener
Plate 4-5/8" x 4-5/8"
Fasteners 3"



C-3008
Sure Tite Newel
Fastening System
Lag Bolt, Washer, Nut, and
1-1/2" Plugs



L-Bracket Post Fastener
C-3505-30 3"
C-3505-35 3-1/2"



Post Mounting System
C-3520TRIM
C-3520-30 3"
C-3520-325 3-1/4"
C-3520-35 3-1/2"



C-3001
Rail Bolt
3-1/2"



C-3901
Rail Bolt Wrench



C-3032
Rail Bolt Driver
5/16"



RP-100
Removable Pin
Long Block Balusters



C-3009
Newel Anchoring
Hardware



C-3010
Flush Rail Plug
1/2" diameter



C-3015
Button Plug
1/2" diameter



C-3000
Flush Rail Plug
1" diameter



C-3020
Button Plug
1" diameter

Stair Anatomy

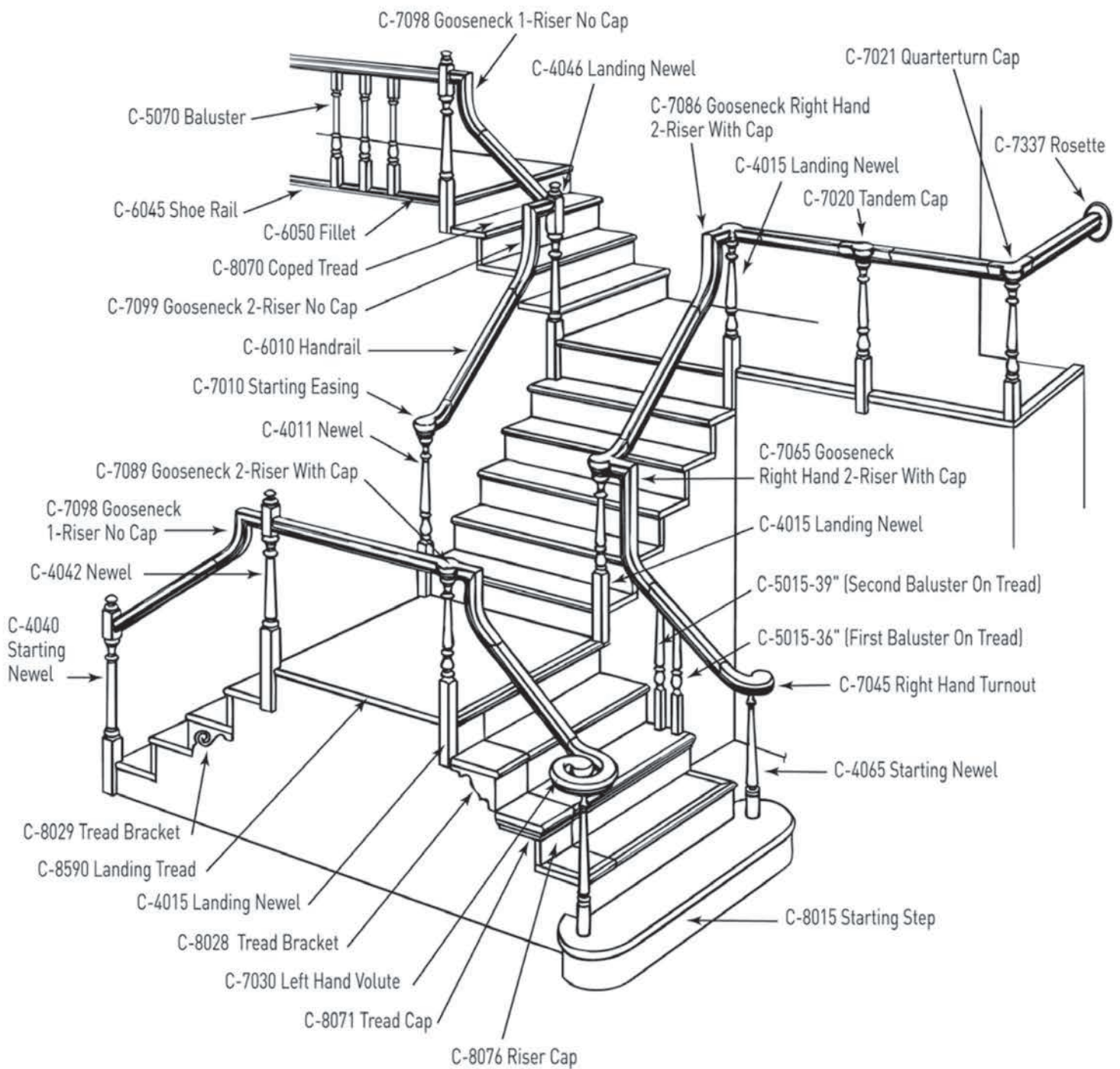

Ordering Specifications

Check local building codes for required height and baluster spacing.

NEWELS

Newels serve as the main structural support of the balustrade portion of the stair. Proper placement, coupled with proper installation techniques, is critical to a structurally sound and code compliant staircase. Newels should be placed at the top and bottom of every stair, at all directional changes, and at intervals of not more than 8' on level balcony runs.

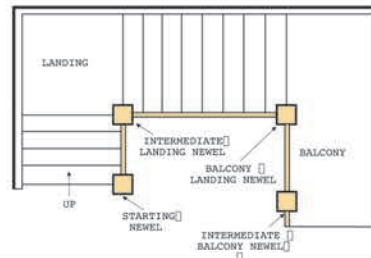

POST-TO-POST NEWELS

PTP newels are designed with upper (top) square blocks that will receive the handrail. Standard block sizes (5", 10" and 13") are provided for use at various locations of the stair.



STARTING NEWELS

A 5" top block will always work at the beginning of the stair. Larger top blocks are unnecessary and can appear top-heavy.

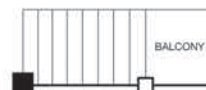

INTERMEDIATE LANDING NEWELS

Intermediate landing newels will have angled rail entering and exiting the upper square block from adjacent sides. Because the newel is basically making up for two rise dimensions in the stair (*the last rise before the intermediate landing as well as the first rise of the second straight run*), a longer square block is necessary to keep consistent rake rail heights from the first run to the second. A newel with a minimum 13" top block will be required.

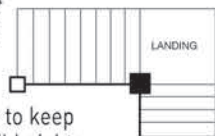

BALCONY LANDING NEWELS

Balcony newels will have angled rail entering from the lower side of the newel with level rail exiting from the top of the upper block. Because only one rise dimension is involved, a 10" top block will normally be required.



BALCONY INTERMEDIATE NEWELS

Balcony intermediate newels will have level rail entering and exiting the upper block of the newel. A 5" top block is recommended.



USE OF FITTINGS WITH PTP NEWELS

The use of easings and goosenecks in PTP systems make the need for longer square blocks unnecessary. Order a 5" top block newel at all locations.



Ordering Specifications

Check local building codes for required height and baluster spacing.









All Over-the-Post newels are manufactured with a 3/4" diameter pin turned into the top of the newel that will be installed into the underside of the fittings used in the rail system.

OVER-THE-POST NEWELS

Recommended heights for the following newel placements are based on a 34" rake rail height, a 7-1/2" rise, a 10" run, and a 1-1/4" tread overhang and are dependent on the location of the newel matching the standard location listed with the application. Variances of up to 3/4" can be expected in certain conditions and should be accounted for when trying to achieve minimum code heights.

OTP STARTING NEWEL HEIGHTS (For 34" Rake Rail Height)

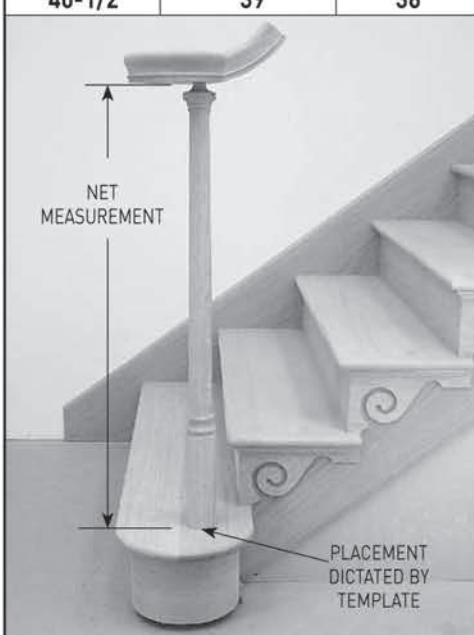
			
STARTING EASING	TURNOUT	VOLUTE	
Net Measurement 36-1/2"	Net Measurement 40-1/2"	Net Measurement 39"	36"

		
NET MEASUREMENT	NET MEASUREMENT	MEASUREMENT: TOP OF TREAD TO TOP OF NEWEL
NEWEL CENTERED ON RISER	PLACEMENT DICTATED BY TEMPLATE	NEWEL CENTERED ON RISER



OTP newels are manufactured in both doweled bottom and square bottom designs. Doweled bottom newels have a 1-1/2" diameter dowel designed into the bottom of the newel that is used to install the starting newel into a starting step. The height of these newels cannot be adjusted, making correct specification critical in achieving desired rake rail height.

ADJUSTABLE NEWELS

An option available in all WM Coffman families to the fixed length doweled newels is the adjustable newel. These newels have a 1-1/2" diameter by 10" deep hole bored into the bottom of the newel and are shipped with a loose 19" dowel in the carton. These newels allow the installer to trim the newel (up to 4") to achieve exact rake rail heights over a wide variety of applications.

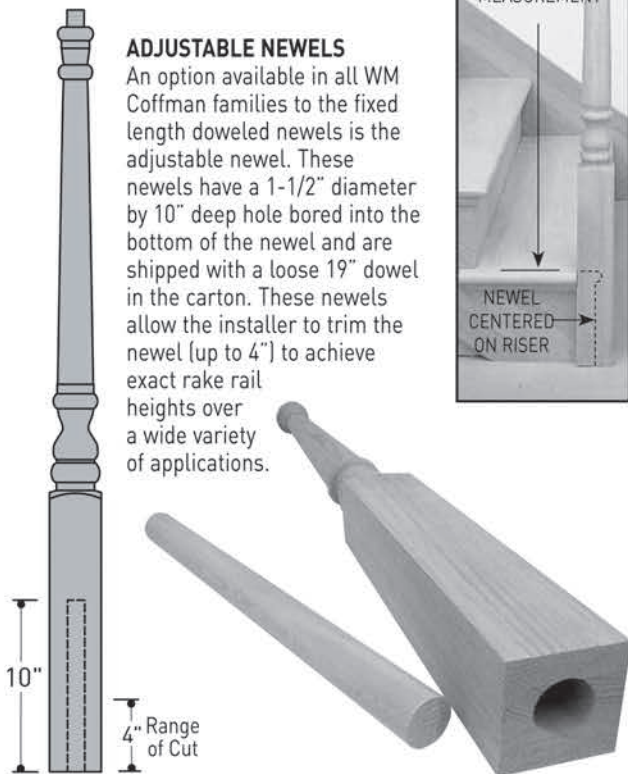

NOTE: Rake rail height requirements other than 34" can be adjusted on a 1:1 basis. Example: For a 36" rake rail height, add 2" to the base number. For a 30" rake rail height, subtract 4". Check local building codes.

NOTE: 1" movement in the newel from standard placement will change the rail height by approximately 3/4". Moving newel placement away from the second riser raises the rail height and moving it closer to the second riser will lower the rail height.

Check local building codes for required height and baluster spacing.

All balusters fall into one of the following categories:

PIN TOP - Pin top balusters have turned, round tops that will be inserted into holes drilled into unplowed handrail.

SQUARE TOP - Square top balusters have a turned portion, leaving a square upper and lower portion. Installation of square top balusters will require a plowed handrail.

FORGED IRON PIN TOP - Forged baluster pin tops are 1/2" diameter.

The stair's rake and balcony rail height, along with code considerations on baluster spacing, will determine the length and quantity of balusters required on any given job. **The tables below** list the quantity and length of the balusters necessary for each rake application for a 34" rake rail height.



All baluster pins are 3/4" long by 3/4" diameter and are turned with chamfered bottoms and a centered glue ring.
Exception: 5015H, 5610H pins are 5/8" long by 5/8" diameter.







Top diameter on the pin top balusters will vary according to baluster size.

- 1-1/4" Baluster - 5/8" diameter
- 1-5/8" Baluster - 5/8" diameter
- 1-3/4" Baluster - 3/4" diameter
(except C-5611 which is 5/8")
- 1-9/16" Baluster - 3/4" diameter
- Forged - 1/2" diameter

All pin top balusters have a guaranteed 3" minimum top straight portion for trimming and insertion.



BALUSTER QUANTITY AND LENGTH (For 34" Rake Rail Height)

			
STARTING EASING	TURNOUT	VOLUTE	VERTICAL VOLUTE
BALUSTERS UNDER STARTING FITTINGS			
QUANTITY - 1	QUANTITY - 2 C-7240, C-7245	QUANTITY - 6 1-1/4" SQUARE	QUANTITY - 1
	QUANTITY - 1 C-7241, C-7246	QUANTITY - 5 1-3/4" SQUARE	
LENGTH 39"	LENGTH 43"	LENGTH 41"	LENGTH 39"

BALUSTERS ON TREADS

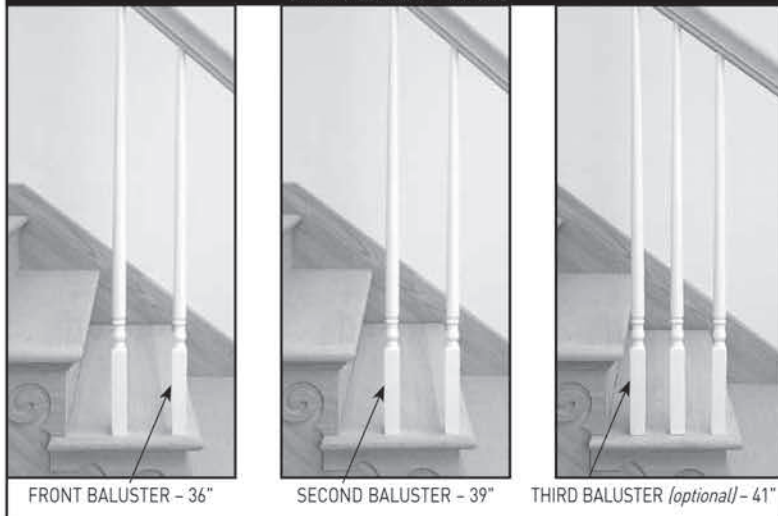

Adjustments to rake rail heights from 34" can be accommodated on a 1:1 basis. Examples: For a 36" rail height, simply add 2" to the given length and order the nearest baluster length (*rounding up if necessary*). For a 30" rake rail height, subtract 4" from the given length and order the nearest baluster length (*rounding up if necessary*).



NOTE: 44" balusters are available in all square bottom profiles.

BALCONY BALUSTER LENGTH

Baluster length requirements for the balcony will match the balcony rail height. If an exact baluster length is not available, simply round up to the next available length. *(Example: For a 38" balcony rail height, order a 39" baluster.)*



BALCONY BALUSTER QUANTITY

	
1-1/4" BALUSTER SQUARE	1-3/4" BALUSTER SQUARE
4-1/2"	4-5/8"
Exception: For 1-3/4" Pin Top Baluster with 5/8" diameter tops (i.e. C-5611) use:	
4-1/2"	

MAXIMUM CENTER-TO-CENTER SPACING (Under 4" Sphere Rule)

Spacing codes vary but generally fall under the 4" sphere rule. The dimensions listed are recommended center-to-center spacing measurements that will safely comply with this code.

To obtain the quantity of balusters for individual balcony runs, divide the length of the balcony run by the corresponding center-to-center spacing and round down.

Ordering Specifications

Check local building codes for required height and baluster spacing.

RAIL AND LINEAL BALUSTRADE COMPONENTS

Rail and lineal balustrade components, like other lineal products, are offered in even lengths from 4' to 16'. For rake portions of the stair, measure along the slope of the stair or use the lineal formula:

Number of Treads x 13" (rounded up to the nearest even length).



PLOWED RAIL is moulded with a recessed bottom for insertion of square top balusters.

UNPLOWED RAIL has a flat bottom that will be drilled for the insertion of pin top balusters.

LINEAL RAIL COMPONENTS consist of sub rail, shoe rail, and fillet. Shoe rail is a plowed moulding designed to accept the bottom of the baluster. Sub rail is used under unplowed handrail with square top balusters in Post-to-Post systems to provide a more substantial look to the balustrade. Fillet is a finished moulding that will be installed between the balusters in plowed rail, shoe rail and sub rail.

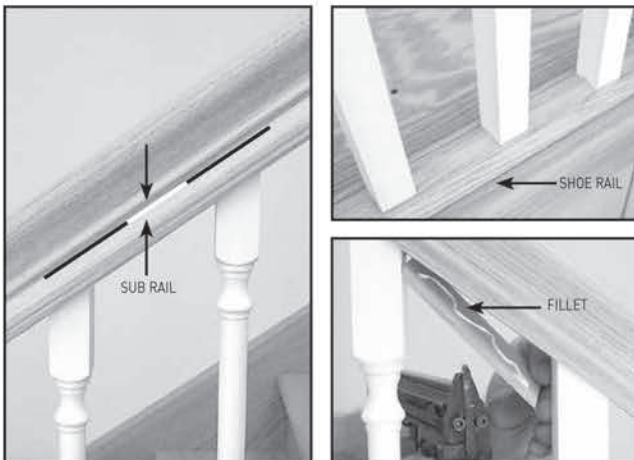
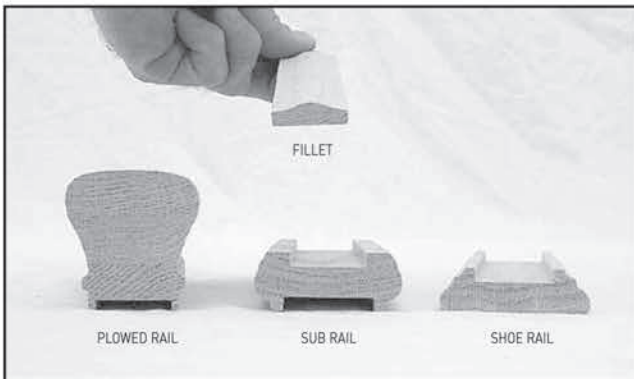

BENDING RAIL BALUSTRADE COMPONENTS

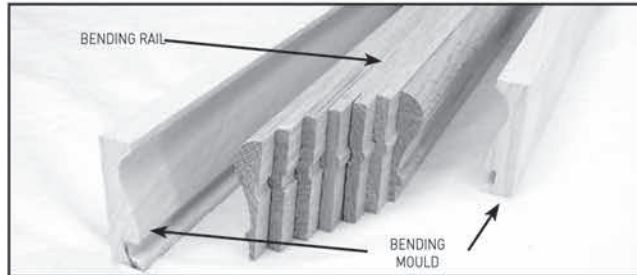

The key components of curved rail construction are bending rails and bending moulds. Bending rail is most easily understood when imagining a standard rail profile cut into thin, vertical strips. Bending mould is a form, moulded to the outside profile of the handrail, that is used to cradle the bending rail as it is being shaped to the stair.

Each ply comprising the bending rail is designed and manufactured with a tongue and groove bead to create an alignment of the plies. When assembled, WM Coffman bending rail results in a match of the standard rail profile.



The minimum radius achievable with each rail profile will depend on several factors. These factors include such variables as the thickness of each ply, the overall thickness of the handrail, the height of the handrail, the angle of the stair, and whether the rail is bent on the rake or on the level portion of the stair. The minimum recommended radius for use on both rake and level applications are listed in the chart for each Coffman bending rail profile.

RAIL ITEM	BENDING RAIL MINIMUM RADIUS	
	RAKE RAIL	BALCONY RAIL
TRADITIONAL C-6016	42"	48"
BRISTOL C-6116	48"	54"
CLASSIC C-6216	48"	54"
RICHMOND C-6416	48"	54"

Check local building codes for required height and baluster spacing.

FITTINGS

Fittings, components used within rail systems, can be incorporated into both PTP and OTP stairs. In OTP rail systems, fittings are required to start the rail system, to make directional and height transitions, to carry the rail over intermediate balcony newels, and to terminate the rail when using a half newel. A good check of any Over-the-Post parts list is to make certain that a fitting is ordered for each newel, including half newels, in the stair. **NOTE:** WM Coffman fittings are shipped with all necessary rail bolts, 1" tapered rail plugs, templates, and full instructions to provide a quick, accurate, and professional installation.



FITTING DEFINITIONS

FITTING ORIENTATION

Fitting orientation is determined from the bottom of the stair looking up. All fittings in the photo to the right are right-hand.



GOOSENECK FITTINGS

Gooseneck fittings are used to accommodate transitions in height and/or direction at intermediate and balcony landings.

NOTE: It is recommended that a minimum difference of 4" between rake rail height and balcony rail height be kept on all Over-the-Post systems.

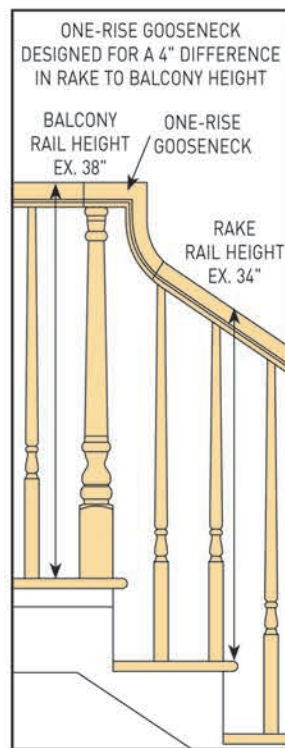
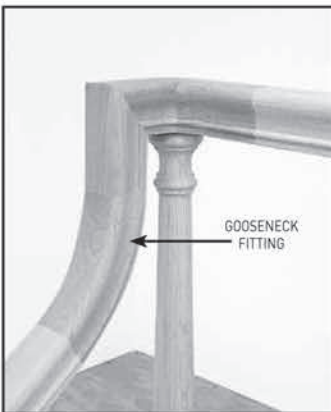

CAP VS. NO CAP

All fittings fall into two categories: (1) those designed and manufactured with a cap and (2) those manufactured without a cap.

All fittings with caps have a 3/4" diameter hole bored in the under side of the cap to receive the top pin of the Over-the-Post newel. Fittings without caps are designed to carry the baluster line through a transition without the use of a newel. Capped fittings are clearly identified in both the drawings and product descriptions.



ONE-RISE VS. TWO-RISE

Most goosenecks are offered in both one-rise and two-rise versions. The one-rise gooseneck is manufactured with the lower easing attached and is limited to use on stairs where the difference in rake rail height to balcony rail height is 4" (Example: 34" rake rail height to 38" balcony rail height). The corresponding two-rise gooseneck makes the same height and/or directional change as its one-rise counterpart but is shipped with the lower easing unattached. This versatile two-piece design allows the installer to trim or extend the straight section of the gooseneck to a height that will work in any situation. Two-rise goosenecks work in applications where the difference in rake rail height is less than 4" (Example: 34-1/2" to 38"), greater than 4" (Example: 34" to 42"), or unknown at the time of ordering.

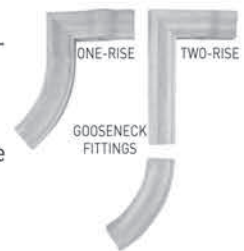

Ordering Specifications

Check local building codes for required height and baluster spacing.

SUGGESTED GOOSENECKS FOR SOME COMMON APPLICATIONS

See Page [10](#) for Guide to ordering Gooseneck Fittings

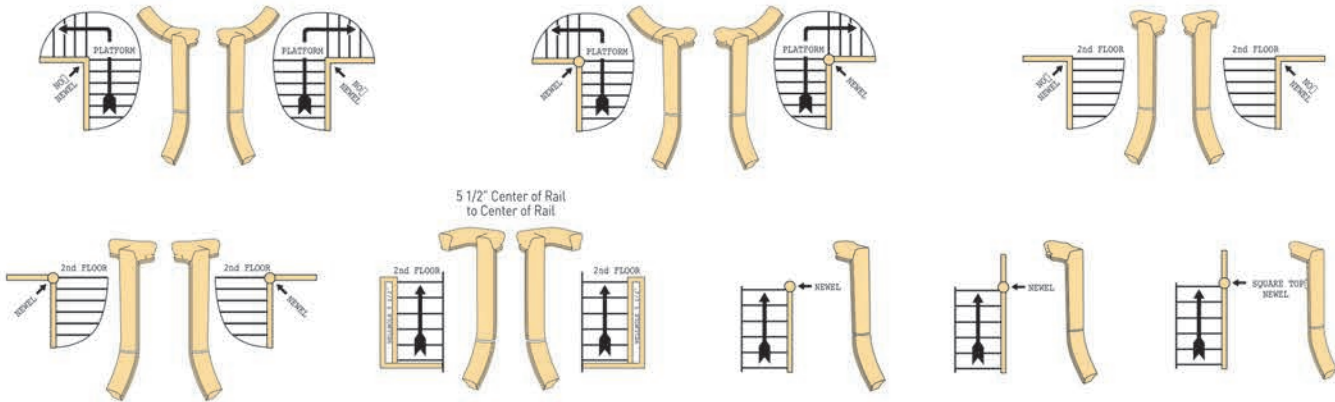

SPECIALTY FITTINGS

OVER EASING

An over easing is designed to carry the rail system from the rake (angled) portion of the stair to the level, balcony portion without the use of a gooseneck. This elegant, flowing look is achieved by combining the over easing with a transitional fitting such as a tandem cap.

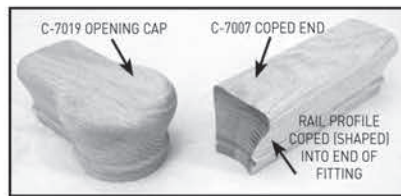

COPED ENDS

Some WM Coffman families contain a Coped End which is a fitting that has the profile of the rail shaped, or coped, into one end of a straight piece of rail. This fitting is used in conjunction with an opening cap (Example C-7019) or a gooseneck incorporating an opening cap (Example C-7097), to accommodate nonstandard angle changes.



90° UP EASING

90° up easings are used to make a horizontal to vertical 90° transition in a rail system.



COMBINING FITTINGS

Standard fittings will sometimes have to be site-assembled to complete a height and/or directional transition. Basically all stair applications can be satisfied using a combination of currently available WM Coffman fittings.

In the example shown of a 180° turn at balcony, you will need a two-rise gooseneck with cap that turns right 90° to sit on top of the newel along with a level quarterturn without a cap to complete the 180° turn.

S-SERIES FITTINGS

WM Coffman's S-Series fittings accommodate the continuous rail codes on partial-open stairs. Specify Right-Hand or Left-Hand (from the bottom of the stair looking up).



ASCENDING VOLUTES

WM Coffman's ascending volutes (C-7X33, C-7X38) are designed to begin their ascent much sooner than their standard counterparts, allowing for the use of a shorter newel and shorter balusters on top of the bullnose starting step. This lower, more proportional beginning of an Over-the-Post system, coupled with the graceful, flowing transition from the volute to the rail, makes the ascending volute an attractive addition to any stair.

Index

BOX NEWELS									
COLLECTION	SIZE	PAGE #	RED OAK	BEECH	POPLAR	PRIMED	HARD MAPLE	ALDER	WHITE OAK
C-4075	3/12" x 65"	14	✓	✓	✓	✓	✓		✓
C-4077	3-1/2" x 63-1/2"	16	✓	✓	✓	✓	✓		✓
C-4090	6-1/4" x 5-3/4"	18	✓						
C-4091	6-1/4" x 55"	14	✓	✓	✓	✓	✓	✓	✓
C-4091-F	6-1/4" x 55"	14	✓		✓	✓	✓		
C-4091-FP	6-1/4" x 55"	15	✓		✓	✓	✓		✓
C-4091-IP	6-1/4" x 55"	15	✓						
C-4091-RP	6-1/4" x 55"	15	✓		✓	✓	✓		✓
C-4095	7-1/2" x 56"	17	✓			✓	✓		
C-4095-F	7-1/2" x 56"	17	✓						
C-4095-RP	7-1/2" x 56"	17	✓		✓				
C-4291	5" x 55"	14	✓	✓	✓	✓	✓	✓	✓
C-4690	4-1/2" x 64"	19	✓		✓	✓	✓		
C-4691-FP	4-1/2" x 64"	16	✓		✓	✓	✓		
C-4691-RP	4-1/2" x 64"	16	✓		✓	✓	✓		
C-4695	4-1/2" x 64"	16	✓		✓	✓	✓		
C-4695-F	4-1/2" x 64"	16	✓						
C-4695-RP	4-1/2" x 64"	16	✓						
C-4890	7-1/2" x 56"	19	✓		✓	✓			
C-4891-FP	7-1/2" x 56"	18	✓		✓	✓			
C-4891-RP	7-1/2" x 56"	18	✓		✓	✓			

INTERCHANGEABLE BOX NEWELS								
COLLECTION	SIZE	PAGE #	RED OAK	POPLAR	PRIMED	HARD MAPLE	WHITE OAK	MAHAGONY
C-4378	3-1/2"	21	✓	✓	✓			
C-4378-S	3-1/2"	20	✓	✓	✓			
C-4378-TC	3-1/2"	20	✓	✓		✓	✓	✓
C-4078	4-1/2"	21	✓	✓	✓			
C-4078-S	4-1/2"	20	✓	✓	✓			
C-4078-TC	4-1/2"	20	✓	✓		✓	✓	✓
C-4578	5-1/2"	21	✓	✓	✓			
C-4578-S	5-1/2"	20	✓	✓	✓			
C-4578-TC	5-1/2"	20	✓	✓		✓	✓	✓
NC-101	2360	59						
R-08F	2370	59						
R-09P	2371	59						
312-CRAFT-TC	3-1/2"	21	✓	✓	✓	✓	✓	✓
412-CRAFT-TC	4-1/2"	21	✓	✓	✓	✓	✓	✓
512-CRAFT-TC	5-1/2"	21	✓	✓	✓	✓	✓	✓

OVER THE POST NEWELS							
WOOD COLLECTION	SIZE	PAGE #	RED OAK	BEECH	POPLAR	HARD MAPLE	WHITE OAK
C-4010	3" x 41"	24	✓	✓	✓	✓	✓
C-4011	3" x 48"	24	✓		✓	✓	✓
C-4014	3" x 44-1/2"	24	✓				✓
C-4015	3" x 60"	24	✓	✓	✓	✓	
C-4019	3" x 48"	24	✓				
C-4030	3" x 48"	24	✓				
C-4035	3" x 60"	24	✓				
C-4065	2-3/4" x 44"	24	✓				
C-4111	3-1/4" x 48"	28	✓				
C-4115	3-1/4" x 60"	28	✓				
C-4210	3-1/2" x 41"	26	✓				
C-4215	3-1/2" x 60"	26	✓			✓	
C-4270	3-1/2" x 41"	29	✓			✓	
C-4272	3-1/2" x 41"	30	✓			✓	
C-4275	3-1/2" x 60"	29	✓				
C-4277	3-1/2" x 60"	30	✓				
C-4410	3-1/4" x 42"	31	✓				
C-4415	3-1/4" x 48"	31	✓				
C-4419	3-1/4" x 48"	31	✓			✓	
C-4662	3-3/8" x 44"	26	✓				
C-4810	3-1/2" x 48"	27	✓				
C-4815	3-1/2" x 72"	27	✓				
C-4862	3-1/4" x 45-1/2"	27	✓				

Index

SQUARE TOP BALUSTERS

COLLECTION	SIZE	PAGE #	RED OAK	POPLAR	PRIMED	HARD MAPLE
C-5005	1-3/4"	26	✓	✓	✓	
C-5060	1-1/4"	31	✓	✓	✓	✓
C-5067	1-1/4"	25	✓		✓	
C-5070	1-1/4"	25	✓		✓	
C-5141	1-3/4"	28	✓		✓	
C-5201	1-3/4"	29			✓	
C-5241	1-3/4"	30	✓		✓	
C-5260	1-1/2"	31			✓	
C-5360	1-3/4"	31	✓	✓	✓	✓
C-5601	1-3/4"	26	✓		✓	

POST TO POST NEWELS

WOOD COLLECTION	SIZE	PAGE #	RED OAK	BEECH	POPLAR	HARD MAPLE	WHITE OAK
C-4001	3-1/2" x 47-1/2"	26	✓			✓	
C-4002	3-1/2" x 56"	26	✓			✓	
C-4003	3-1/2" x 59-1/2"	26	✓			✓	
C-4004	3-1/2" x 47-1/2"	27	✓		✓		
C-4005	3-1/2" x 56"	27	✓	✓	✓	✓	
C-4006	3-1/2" x 72"	27	✓				
C-4007	3-1/2" x 47-1/2"	26	✓				
C-4008	3-1/2" x 56"	26	✓		✓		
C-4009	3-1/2" x 56"	26	✓				
C-4040	3" x 47-1/2"	25	✓	✓	✓	✓	✓
C-4042	3" x 53-1/2"	25	✓	✓	✓	✓	✓
C-4045	3" x 59-1/2"	25	✓	✓	✓	✓	✓
C-4046	3" x 60"	25	✓		✓		
C-4046S	3" x 59-1/2"	25	✓				
C-4055	3" x 68"	25	✓				✓
C-4070	3" x 47"	27	✓				
C-4074	3" x 56"	31	✓		✓	✓	✓
C-4074EE	3" x 56"	31	✓				
C-4076	3-1/2" x 56"	31	✓		✓	✓	✓
C-4076EE	3-1/2" x 56"	31	✓				
C-4172	3-1/4" x 54"	28	✓				
C-4175	3-1/4" x 54"	28	✓				
C-4176	3-1/4" x 54"	28	✓			✓	
C-4179	6" x 60"	28	✓				
C-4240	3-1/2" x 47-1/2"	26	✓				
C-4242	3-1/2" x 56"	26	✓				
C-4245	3-1/2" x 59-1/2"	26	✓				
C-4280	3-1/2" x 48"	29	✓				
C-4280L	3-1/2" x 56"	29	✓				
C-4282	3-1/2" x 48"	30	✓				
C-4282L	3-1/2" x 56"	30	✓				
C-4285	3-1/2" x 60"	29	✓				
C-4287	3-1/2" x 60"	30	✓				
C-4440	3-1/4" x 48"	31	✓			✓	
C-4442	3-1/4" x 54"	31	✓			✓	
C-4445	3-1/4" x 54"	31	✓			✓	
C-4446	3-1/4" x 54"	31	✓			✓	
C-4540	3" x 48"	25	✓				
C-4542	3" x 54"	25	✓				
C-4545	3" x 54"	25	✓				
C-4546	3" x 54"	25	✓				
C-4547	3" x 60"	25	✓				
C-4550BT	3" x 48"	25	✓				
C-4555BT	3" x 54"	25	✓				
C-4556BT	3" x 54"	25	✓				
C-4840	3-1/2" x 56"	27	✓				
C-4845	3-1/2" x 72"	27	✓				

PIN TOP BALUSTERS						
COLLECTION	SIZE	PAGE #	RED OAK	POPLAR	PRIMED	HARD MAPLE
C-5015	1-1/4"	24	✓	✓	✓	✓
C-5040	1-1/8"	24			✓	
C-5151	1-3/4"	28	✓		✓	
C-5211	1-3/4"	29			✓	
C-5251	1-3/4"	30	✓		✓	
C-5611	1-3/4"	26	✓		✓	
C-5845	1-9/16"	27			✓	

HEMLOCK			
COLLECTION	SIZE	PAGE #	HEMLOCK
C-5060	1-1/4"	31	✓
C-4076	3-1/4"	31	✓
C-4076EE	3-1/4"	31	✓
C-6045	2-1/2" x 1-1/8" (1-1/4" PLOW)	69	✓

IRON BALUSTERS/NEWELS			ABZ		BLK		ORB		ORC		PC	SAT	
COLLECTION	SKU	PAGE #	LITE	SOLID	LITE	SOLID	LITE	SOLID	LITE	SOLID	LITE	LITE	SOLID
NEWL-BASK48	2450	55											✓
NEWL-TW48	2452	55											✓
REN-PANEL	2490	54	✓		✓		✓		✓			✓	
M-399	2491	54											✓
M-555	2492	54											✓
1TW44	2550	38	✓	✓	✓	✓	✓	✓	✓	✓	✓	✓	✓
2TW44	2551	38	✓	✓	✓	✓	✓	✓	✓	✓	✓	✓	✓
1BASK44	2552	38	✓	✓	✓	✓	✓	✓	✓	✓	✓	✓	✓
2BASK44	2553	38	✓	✓	✓	✓	✓	✓	✓	✓	✓	✓	✓
1TW22	2554	38	✓		✓		✓		✓			✓	
PLA44	2555	39	✓	✓	✓	✓	✓	✓	✓	✓	✓	✓	✓
1KNUC44	2556	39	✓	✓	✓	✓	✓	✓	✓	✓	✓	✓	✓
2KNUC44	2557	39	✓	✓	✓	✓	✓	✓	✓	✓	✓	✓	✓
2KNUCTBASK44	2558	39	✓		✓		✓		✓			✓	
1RIB44	2560	40	✓	✓	✓	✓	✓	✓	✓	✓		✓	✓
2RIB44	2561	40	✓	✓	✓	✓	✓	✓	✓	✓		✓	✓
M14044	2570	50	✓	✓	✓	✓	✓	✓	✓	✓		✓	✓
M15044	2571	50	✓	✓	✓	✓	✓	✓	✓	✓		✓	✓
M16044	2572	50	✓	✓	✓	✓	✓	✓	✓	✓		✓	✓
M14344	2575	50	✓	✓	✓	✓	✓	✓	✓	✓		✓	✓
M301	2580	42	✓		✓	✓	✓		✓		✓	✓	✓
M601	2581	42	✓	✓	✓	✓	✓	✓	✓	✓		✓	✓
M325	2582	42	✓		✓		✓		✓			✓	
M326	2583	43			✓		✓					✓	
M501	2585	42	✓		✓		✓		✓			✓	
M65144	2595	51			✓		✓		✓			✓	
M65244	2596	51			✓		✓		✓			✓	
M65344	2597	51			✓		✓		✓			✓	
M65044	2598	51			✓		✓		✓			✓	
KW-1TW44	2650	41					✓					✓	
KW-2TW44	2651	41					✓					✓	
KW-1BASK44	2652	41					✓					✓	
KW-2BASK44	2653	41					✓					✓	
KW-M501	2685	41					✓					✓	
M13344	2760	46					✓					✓	
M13444	2761	46					✓					✓	
M13144	2766	46					✓					✓	
M13244	2767	46					✓					✓	
R60144	2770	48					✓					✓	
R60244	2771	48					✓					✓	
R61144	2772	48					✓					✓	
R61244	2773	48					✓					✓	
R60044	2775	48					✓					✓	
M303	2797	46										✓	

Index

IRON BALUSTERS/NEWELS			ABZ		BLK		ORB		ORC		PC		SAT	
COLLECTION	SKU	PAGE #	LITE	SOLID	LITE	SOLID	LITE	SOLID	LITE	SOLID	LITE	SOLID	LITE	SOLID
MEGA-1TW	2850	52	✓		✓		✓		✓				✓	
MEGA-2TW	2851	52	✓		✓		✓		✓				✓	
MEGA-1BASK	2852	52	✓		✓		✓		✓				✓	
MEGA-2BASK	2853	52	✓		✓		✓		✓				✓	
MEGA-PLA	2855	53	✓		✓		✓		✓				✓	
MEGA-1KNUCK	2856	53	✓		✓		✓		✓				✓	
MEGA-2KNUCK	2857	53	✓		✓		✓		✓				✓	
MEGA-M601	2881	53	✓		✓		✓		✓				✓	
M40144	2930	44			✓	✓								
M40244	2931	44			✓	✓								
M41144	2933	44			✓	✓								
NEWL-14048	2940	55												✓
M8044	2962	40	✓		✓		✓		✓				✓	✓
M8544	2963	40	✓		✓		✓		✓				✓	✓
WAVE44	2968	39	✓		✓		✓		✓				✓	
R54344	2970	49			✓	✓								
R54044	2971	49			✓	✓								
R55044	2972	49			✓	✓								
M331	2982	43											✓	✓
PLA40-BLY	2986	45											✓	✓
TTW40-BLY	2987	45											✓	✓
1BASK40-BLY	2988	45											✓	✓
M30544	2990	47	✓	✓	✓	✓	✓	✓	✓	✓			✓	✓
M30844	2991	47	✓	✓	✓	✓	✓	✓	✓	✓			✓	✓
M9044	2995	46	✓	✓	✓	✓	✓	✓	✓	✓			✓	✓
M10044	2996	46				✓	✓	✓	✓	✓			✓	✓
MT1044	2997	46		✓		✓	✓	✓	✓	✓			✓	✓

IRON SHOES			ABZ		BLK		ORB		ORC		PC		SAT	
COLLECTION	SKU	PAGE #	LITE	SOLID	LITE	SOLID	LITE	SOLID	LITE	SOLID	LITE	SOLID	LITE	SOLID
RM-301	2330	59	✓		✓		✓	✓	✓				✓	✓
RM-201	2331	59												✓
FSH-01	2340	58	✓	✓	✓	✓	✓	✓	✓	✓	✓	✓	✓	✓
H-03	2341	58	✓	✓	✓	✓	✓	✓	✓	✓	✓	✓	✓	✓
M-06	2342	58	✓	✓	✓	✓	✓	✓	✓	✓	✓	✓	✓	✓
AK-01	2345	58	✓	✓	✓	✓	✓	✓	✓	✓	✓	✓	✓	✓
PSH-02	2350	58	✓	✓	✓	✓	✓	✓	✓	✓	✓	✓	✓	✓
H-05P	2351	58	✓	✓	✓	✓	✓	✓	✓	✓			✓	✓
RAK-01	2352	59												✓
NC-101	2360	59												✓
R-08F	2370	59						✓						✓
R-09P	2371	59						✓						✓
R-10	2375	59	✓		✓		✓		✓				✓	✓
MEGA-PSH-08	2390	58	✓	✓	✓	✓	✓	✓	✓	✓			✓	✓
MEGA-FSH-08	2391	58	✓		✓		✓		✓				✓	✓
MEGA-M-08	2392	58	✓	✓	✓	✓	✓	✓	✓	✓			✓	✓
SCR-01	2910	58	✓	✓	✓	✓	✓	✓	✓	✓			✓	✓
M-020	2911	58		✓										✓
M-022	2912	58			✓									
H-06	2915	58	✓	✓	✓	✓	✓	✓	✓	✓			✓	✓
R-07F	2916	59			✓	✓		✓						
R-06P	2917	59			✓									
RAK-03	2918	59			✓									
RD-201	2919	59		✓		✓	✓	✓		✓			✓	✓
SQ-301	2929	59					✓	✓					✓	✓

HANDRAIL BRACKETS	
IRON COLLECTION	PAGE #
C-3611	77
C-3621	77
C-3631	77
C3622	77
C-3632	77

BENDING RAIL					
COLLECTION	SIZE	PAGE #	RED OAK	HARD MAPLE	WHITE OAK
C-6016	7-PIECE	66	✓	✓	✓
C-6216	8-PIECE	66	✓	✓	
C-6116	9-PIECE	66	✓		
C-6416	9-PIECE	67	✓		

FILLET						
COLLECTION	SIZE	PAGE #	RED OAK	BEECH	POPLAR	HARD MAPLE
C-6050	1-1/4"	67	✓	✓	✓	✓
C-6007	1-3/4"	67	✓			✓

MODERN							
COLLECTION	SIZE	PAGE #	RED OAK	BEECH	POPLAR	HARD MAPLE	WHITE OAK
C-4074	3" x 56"	31	✓		✓	✓	✓
C-4076	3-1/2" x 56"	31	✓		✓	✓	✓
C-4071	3" x 48"	31					
M432	1/2" x 44"	57					
M-435	1/2" x 44"	57					
M-438	1/2" x 44"	57					
M-439	1/2" x 44"	57					
SS-TUBE	304-5/8" x 96"	62					
C-6700	2-1/2" x 1-5/8"	62					
C-6840	2-5/8" x 1-5/8"	62					

HANDRAIL							
COLLECTION	SIZE	PAGE #	RED OAK	BEECH	POPLAR	HARD MAPLE	WHITE OAK
C-6010	2-1/4" x 2-3/8"	66	✓		✓	✓	✓
C-6010P	2-1/4" x 2-3/8" (1-1/4" PLOW)	66	✓		✓		✓
C-6210	2-5/8" x 2-3/8"	66	✓		✓		✓
C-6210P1	2-5/8" x 2-3/8" (1-3/4" PLOW)	66	✓				✓
C-6410P1	2-5/8" x 2-3/8" (1-3/4" PLOW)	67	✓				
C-6700P		68	✓		✓		✓
C-6700P1		68	✓		✓		✓

TREAD ACCESSORIES						
ACCESSORIES	PAGE #	RED OAK	BEECH	POPLAR	HARD MAPLE	WHITE OAK
C-6973	75	✓	✓			✓
C-6975	75	✓	✓			
C-8028	75	✓		✓		✓
C-8028V	75	✓				
C-8029	75	✓				✓
C-8029V	75	✓				
C-8080	75	✓				
C-8080-13	75	✓				
C-8081	75	✓			✓	
C-8085	75	✓				✓

ACCESSORIES & HARDWARE							
ACCESSORIES	PAGE #	ACCESS.	RED OAK	BEECH	POPLAR	HARD MAPLE	WHITE OAK
C-3000	79		✓	✓	✓	✓	✓
C-3010	79		✓				
C-3015	79		✓				
C-3020	79		✓				
C-3505	78		✓		✓		
C-3520	78		✓		✓	✓	
C-3001	79	✓					
C-3008	78	✓					
C-3501	78	✓					
C-3009	79	✓					
C-3032	79	✓					
C-3201	78	✓					
C-3203	78	✓					
C-3283	78	✓					
C-3301	78	✓					
C-3302	78	✓					
C-3901	79	✓					
RP-100	79	✓					

Index

FITTINGS									
SERIES	COLLECTION	PART	PAGE #	RED OAK	BEECH	POPLAR	HARD MAPLE	WHITE OAK	
TRADITIONAL	C-7005	QUARTERTURN FOR C-6042	69	✓					
	C-7007	COPPED END	70	✓					
	C-7009	RETURNED END	70	✓	✓	✓	✓		
	C-7010	STARTING EASING W/ CAP	70	✓	✓	✓	✓		
	C-7011	LEVEL QUARTERTURN 90°	70	✓	✓	✓	✓	✓	
	C-7012S	UP EASING	71	✓	✓	✓	✓	✓	
	C-7013	OVER EASING	71	✓	✓	✓	✓		
	C-7014S	UP EASING 90°	71	✓	✓	✓	✓		
	C-7016	OVER EASING W/ RETURNED END	71	✓					
	C-7019	OPENING CAP	71	✓	✓	✓	✓		
	C-7020	TANDEM CAP	71	✓	✓	✓	✓	✓	
	C-7021	QUARTERTURN NEWEL CAP	71	✓	✓	✓	✓	✓	
	C-7022	LEVEL NEWEL CAP 45°	71	✓	✓	✓	✓		
	C-7023	QUARTERTURN FOR C-6040	69	✓		✓			
	C-7024	STARTING EASING FOR C-6040	69	✓		✓			
	C-7025	OVER EASING FOR C-6040	69	✓		✓			
	C-7026	LEVEL TURN 45°	71	✓	✓				
	C-7030	LH VOLUTE	70	✓	✓	✓	✓	✓	
	C-7035	RH VOLUTE	70	✓	✓	✓	✓	✓	
	C-7031	VERTICAL VOLUTE	70	✓					
	C-7040	LH TURNOUT 4-7/8" C/C	70	✓	✓	✓	✓		
	C-7045	RH TURNOUT 4-7/8" C/C	70	✓	✓	✓	✓		
	C-7047LH	LH "S" TURN	71	✓	✓	✓	✓	✓	
	C-7047RH	RH "S" TURN	71	✓	✓	✓	✓	✓	
	C-7071	LH 2-RISER NO CAP	72	✓					
	C-7076	RH 2-RISER NO CAP	72	✓					
	C-7089	2-RISER W/ TANDEM CAP	72	✓					
	C-7099	2-RISER NO CAP	72	✓	✓	✓	✓	✓	
	BRISTOL	C-7109	RETURNED END	70	✓			✓	
		C-7110	STARTING EASING W/ CAP	70	✓			✓	
C-7111		LEVEL QUARTERTURN 90°	70	✓			✓		
C-7112S		UP EASING	71	✓			✓		
C-7113		OVER EASING	71	✓			✓		
C-7114S		UP EASING 90°	71	✓			✓		
C-7119		OPENING CAP	71	✓			✓		
C-7120		TANDEM CAP	71	✓			✓		
C-7121		QUARTERTURN NEWEL CAP	71	✓			✓		
C-7122		LEVEL NEWEL CAP 45°	71	✓			✓		
C-7126		LEVEL TURN 45°	71	✓					
C-7130		LH VOLUTE	70	✓			✓		
C-7135		RH VOLUTE	70	✓			✓		
C-7140		LH TURNOUT 4-7/8" C/C	70	✓			✓		
C-7145		RH TURNOUT 4-7/8" C/C	70	✓			✓		
C-7147LH		LH "S" TURN	71	✓					
C-7147RH		RH "S" TURN	71	✓					
C-7199		2-RISER NO CAP	72	✓			✓		
CLASSIC		C-7207	COPED END	70	✓				
	C-7209	RETURNED END	70	✓			✓		
	C-7210	STARTING EASING W/ CAP	70	✓		✓	✓		
	C-7211	LEVEL QUARTERTURN 90°	70	✓		✓	✓		
	C-7212S	UP EASING	71	✓		✓	✓		
	C-7213	OVER EASING	71	✓			✓		
	C-7214S	UP EASING 90°	71	✓			✓		
	C-7216	OVER EASING W/ RETURNED END	71	✓					
	C-7219	OPENING CAP	71	✓		✓	✓		
	C-7220	TANDEM CAP	71	✓			✓		
	C-7221	QUARTERTURN NEWEL CAP	71	✓			✓		
	C-7222	LEVEL NEWEL CAP 45°	71	✓			✓		
	C-7226	LEVEL TURN 45°	71	✓					
	C-7230	LH VOLUTE	70	✓			✓		
	C-7235	RH VOLUTE	70	✓			✓		
	C-7240	LH TURNOUT 4-7/8" C/C	70	✓					
	C-7245	RH TURNOUT 4-7/8" C/C	70	✓					
	C-7247LH	LH "S" TURN	71	✓			✓		
	C-7247RH	RH "S" TURN	71	✓					
	C-7299	2-RISER NO CAP	72	✓		✓	✓		

FITTINGS CONTINUED

SERIES	COLLECTION	PART	PAGE #	RED OAK	BEECH	POPLAR	HARD MAPLE	WHITE OAK	
GEORGIAN	C-7310	STARTING EASING W/ CAP	70	✓					
	C-7311	LEVEL QUARTERTURN 90°	70	✓					
	C-7312S	UP EASING	71	✓					
	C-7313	OVER EASING	71	✓					
	C-7314S	UP EASING 90°	71	✓					
	C-7319	OPENING CAP	71	✓					
	C-7320	TANDEM CAP	71	✓					
	C-7321	QUARTERTURN NEWEL CAP	71	✓					
	C-7330	LH VOLUTE	70	✓					
	C-7335	RH VOLUTE	70	✓					
	C-7340	LH TURNOUT 4-7/8" C/C	70	✓					
	C-7345	RH TURNOUT 4-7/8" C/C	70	✓					
	C-7371	LH 2-RISER NO CAP	72	✓					
	C-7376	RH 2-RISER NO CAP	72	✓					
	C-7389	2-RISER W/ TANDEM CAP	72	✓					
	C-7399	2-RISER NO CAP	72	✓					
	RICHMOND	C-7410	STARTING EASING W/ CAP	70	✓				
		C-7411	LEVEL QUARTERTURN 90°	70	✓				
		C-7412S	UP EASING	71	✓				
		C-7413	OVER EASING	71	✓				
C-7414S		UP EASING 90°	71	✓					
C-7419		OPENING CAP	71	✓					
C-7420		TANDEM CAP	71	✓					
C-7421		QUARTERTURN NEWEL CAP	71	✓					
C-7422		LEVEL NEWEL CAP 45°	71	✓					
C-7430		LH VOLUTE	70	✓					
C-7435		RH VOLUTE	70	✓					
C-7440		LH TURNOUT 4-7/8" C/C	70	✓					
C-7445		RH TURNOUT 4-7/8" C/C	70	✓					
C-7447LH		LH "S" TURN	71	✓					
C-7447RH		RH "S" TURN	71	✓					
C-7499		2-RISER NO CAP	72	✓					

ROSETTES

COLLECTION	SIZE	PAGE #	RED OAK	BEECH	POPLAR	HARD MAPLE	WHITE OAK
C-7217	5-3/8"	74	✓				
C-7237	4-3/16" × 6-3/16"	74	✓	✓	✓	✓	✓
C-7317	4-5/8"	74	✓	✓	✓	✓	✓
C-7318	4-3/16" × 5-3/8"	74	✓				
C-7337	4" × 5-1/2"	74	✓	✓	✓	✓	✓

SHOE RAIL/WALL RAIL

COLLECTION	SIZE	PAGE #	RED OAK	BEECH	POPLAR	HARD MAPLE
C-6045	2-1/2" × 3/4" (1-1/4" PLOW)	69	✓		✓	✓
C-6006	3-1/8" × 1" (1-3/4" PLOW)	69	✓		✓	
C-6040	1-11/16" × 1-1/2"	69	✓	✓	✓	
C-6042	2-1/4" × 1-9/32"	69	✓		✓	

STARTING STEPS

COLLECTION	SIZE	PAGE #	RED OAK	HARD MAPLE	WHITE OAK
C-8010	AVAIL 48", 54", 60", & 72"	74	✓	✓	✓
C-8015	AVAIL 48", 54", 60"	74	✓	✓	✓
C-8016	AVAIL 48", 53", & 58"	74	✓		
C-8030	AVAIL 48" & 60"	74	✓		
C-8010-2	REV STARTING TREAD (NO NOTCH)	76	✓		
C-8011	REV STARTING TREAD (NOTCH)	76	✓		

TREADS/RISERS/TREAD ACCESSORIES

COLLECTION	SIZE	PAGE #	RED OAK	HARD MAPLE	WHITE OAK	PRIMED
C-8070	MULTIPLE VARIATIONS	75	✓	✓	✓	
C-8075	8" 36", 42", 48", 54", 60", 72"	75	✓		✓	✓
C-8072	5-1/4" 12"	76	✓	✓	✓	
C-8076	5-1/4" 8"	76	✓	✓	✓	
C-8079	REV FALSE TREAD/RISER	76	✓			





Coffman[®]
STAIR PARTS

Proudly Supplied By

p m d **PACIFIC MUTUAL**
DOOR AND WINDOW

816-531-0161 | www.pacificmutualdoor.com