



Ultra Series



We're for the visionaries.®

**We're for people
who take building
to new levels.**



We're for people who are passionate about design, who care about the big picture and the smallest detail. We're for people who aren't satisfied with mainstream choices... who push the limits of what's possible with the options and innovations that can only be found in Kolbe windows and doors.



We're for quality craftsmanship.

We're for a tradition of excellence that outlasts the latest design trend. The Kolbe story began with a family and a vision. More than 70 years after the Kolbe brothers began their commitment to producing premium quality windows and doors, products bearing their family name can be found in some of North America's most impressive homes and businesses.

We're for expertise.

We're for people who dream of a personalized design experience. That's why you can't find Kolbe windows and doors in the aisles of a home center. Our products are only available through a Kolbe dealer, because they are as passionate about windows and doors as you are about bringing your vision to life. And they will work with you to make your dream a concrete reality.

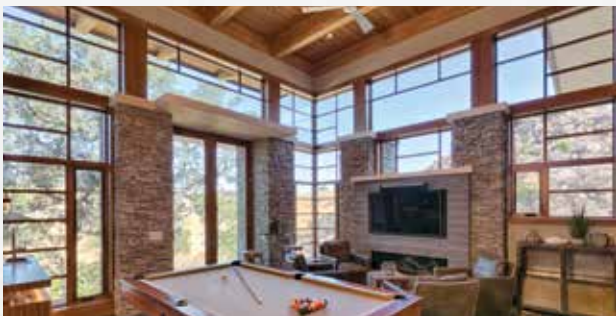

We're for possibilities.

We're for people who won't settle for "standard." We're for limitless options and custom solutions that can only be found in Kolbe's made-to-order products. Our team members are craftspeople who focus on building one window or door at a time, to create distinctive products that fulfill your unique vision.

We're for innovation.

We're for people who want to take building to new levels, with advancements in not only extraordinary sizes and shapes, but also ground-breaking products. We're for creative thinking that redefines what's possible, constantly reimagining our windows and doors to elevate style, performance and functionality.



**Let us bring
your vision
to life.**



Table of Contents

The Ultra Series	2-5	Patio & Entrance Doors	140-195
Casements	6-45	Options & Accessories	196-213
Awnings	46-67	Technical Data	214-233
Double Hungs	68-99	Clear Opening Dimensions	216-231
Folding, Sliding, & Tilt-Turn Windows	100-117	ENERGY STAR®	232-233
Specialty Windows	118-139		

Professional Tools

Kolbe offers a number of tools to help building professionals provide a client with a realistic visual of their project. Ultra Series 3D models offer great design flexibility for design professionals who prefer to work in three dimensions. These models provide the ability to view products from different perspectives, incorporate options, and customize models specific to projects.

To download Ultra Series Revit® and SketchUp™ Models, visit:

- ▶ www.kolbewindows.com/resources/architect-library
- ▶ www.3dwarehouse.com

Also available at www.kolbewindows.com:

- ▶ Cross section drawings
- ▶ Available sizes
- ▶ Installation instructions
- ▶ Performance data
- ▶ Thermal performance information
- ▶ Mulling limitations
- ▶ Product and installation videos





The Ultra Series

Kolbe's Ultra Series windows and doors can mimic the traditional style of wood windows and doors with a warm wood interior and intricate exterior trim details, or they can accommodate modern design needs. Choose from an extensive palette of exterior colors, interior wood species and finishes, divided lite profiles, and more.

The Ultra Series provides:

- Versatile styling, from traditional to modern architectural details
- Divided lite profiles & patterns; aesthetic & efficient glass choices
- Wood interior in familiar to exotic wood species
- Strong and durable extruded aluminum exterior
- A palette of 50+ exterior & 20 interior pre-finish choices

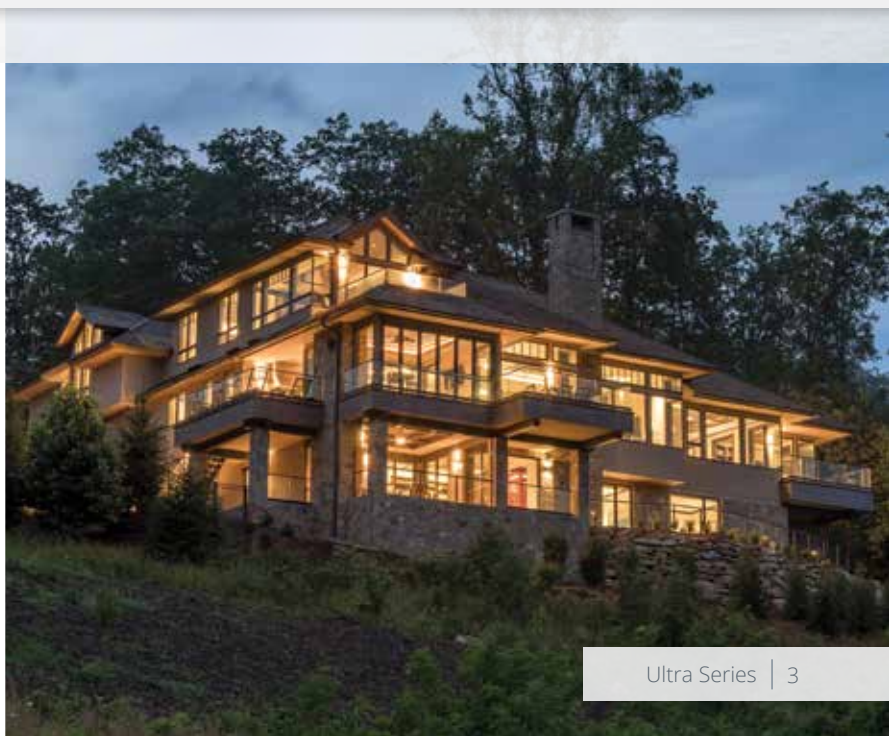

Residential Construction

Years of innovation at Kolbe have led to products with great design flexibility for residential construction. Whether it's renovation or new construction, we offer products that add your signature style into your home. Your design reflects not only an architectural style, but also your individualism – from colonial to contemporary, Kolbe has the products to help you express yourself.



Commercial Capabilities

Each of our windows and doors are built-to-order. Uniquely crafted to each project's specifications, Kolbe provides endless options and design solutions in configurations suitable for commercial projects. Our technical specialists can help provide support on various aspects of your commercial project.



Historical Renovation

Our reputation for producing custom-crafted windows and doors with attention to intricate details lends itself perfectly to historical renovation projects. Our products are designed to marry traditional design aesthetics with advanced technology and sustainability, and we offer many options to restore beauty to your project while maintaining historic character. In addition to providing aesthetics and efficiency, Kolbe can work with you to meet building codes and historical district requirements.



Energy Efficiency

Kolbe windows and doors are available with a wide variety of glass options to meet your energy needs in any climate. In fact, many Kolbe products meet or exceed ENERGY STAR® guidelines in most climate zones while reducing energy costs for home and business owners.



Sustainable Design

Due to our commitment to maintaining ecological sustainability, Kolbe sources most of the components used in our window and door products from within 500 miles of our factory. The wood species we use are renewable resources sourced from managed forests, while our standard glass contains 25-30% recycled content. In addition, we can provide The Forest Stewardship Council® (FSC®)-certified wood species for many of our window and door products (FSC® license code FSC-C019541).



Impact Certification

Impact modifications are available on a number of Kolbe windows and doors. Our products are specially designed with the strength and durability to withstand hurricane force winds and flying debris, and are independently tested to meet or exceed strict building codes in coastal regions. There are no unsightly rods or extra locks to fasten, so Kolbe's impact-certified products offer the same beautiful appearance as non-impact products.



Design Options

For over 70 years, Kolbe products have been all about customization. We offer many options for our windows and doors, including wood species, custom divided lite patterns, unique shapes, and many interior and exterior finishes to complement the design aesthetic of any project. We're known worldwide for our custom solutions and have worked closely with architects to build distinctive windows and doors that help bring your most innovative ideas to life.

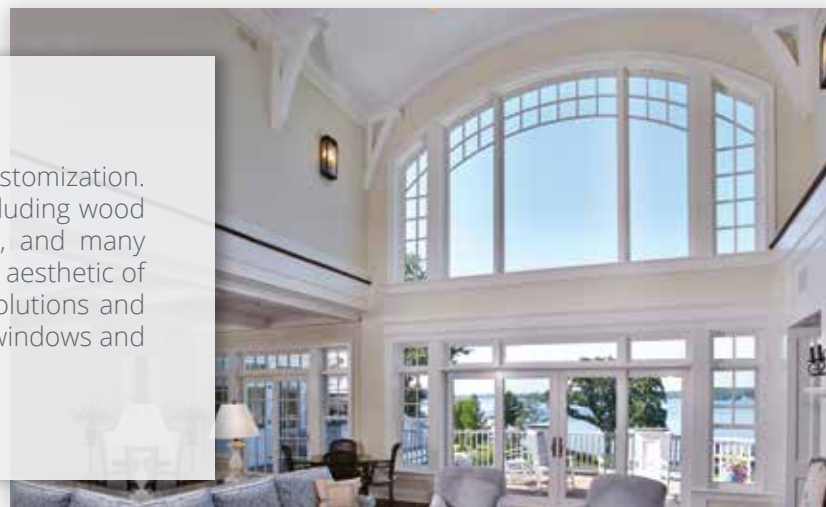

Universal Design

Universal design is the concept of creating spaces that are accessible and comfortable for individuals of diverse physical ability levels. Kolbe offers options for a variety of windows and doors that are not only designed to make independent living possible, but to do it with quality, style and flexibility. Kolbe's options, such as sill ramps, motorized operators, larger cranks and lever door handles, can help make independent living easier.







Casements

The design and performance of Ultra Series casements are the features that make these windows so popular. Most casements open from the side to a 90-degree angle, allowing for maximum ventilation. Multi-point locking levers offer a sleek, convenient way to tightly secure your windows from one locking location.

*Crank-Out Casements | Crank-Out XL Casements | Push-Out & Push-Out EP Casements | French Casements
Picture & Transom Units | Picture Combination Units | Bow & Bay Units | Segment Head & Half-Circle Top Units*



Crank-Out Casement

Kolbe's crank-out casements combine a simple cranking operation with many options for customization. By opening and closing easily and effectively, they provide excellent ventilation. Crank handles fold down when not in use to prevent interference with window treatments.



Crank-Out Casement Standard Features

- ▶ 1-3/4" thick sash
- ▶ Overall jamb width is 4-9/16" (*basic box width is 2-3/4" plus extensions*)
- ▶ Constructed of pine, with pine interior stops and wood mull casings on mullied units
- ▶ Exterior wood parts are treated
- ▶ Extruded aluminum exterior finished with a 70% PVDF fluoropolymer coating (*meets performance requirements of AAMA 2605*)
- ▶ Accessory grooves are integral to the extruded frames for the easy addition of accessories
- ▶ Energy efficient, insulating Solar Low-E glass
- ▶ Glazed to the interior with beveled wood glazing beads
- ▶ Interior insect screen with Clay-colored aluminum frame and BetterVue® fiberglass mesh
- ▶ Clay-colored nesting handle and locking lever with multi-point locking system
- ▶ Corrosion resistant, dual-arm operators with concealed, adjustable hinges (*On "W" series and wider. Dyad operators with concealed, adjustable hinges on units narrower than "W"; single-arm operators with Tri-Euro hinges for added support on segment head, half-circle top and impact units*)
- ▶ Heavy vinyl nailing fins with head drip caps*
- ▶ Pine-veneered head and seat boards; unique, narrow mullions and cable support system on bow and bay units

NOTE: All measurements are nominal.

* Standard only on units without brickmould.

Hardware

- ▶ Nesting handle and locking lever† provide a sleek look and are unobtrusive. Available in Clay, White, Beige, Bright Brass, Antique Brass, Satin Nickel, Antique Nickel, Rustic Umber, Oil-Rubbed** or Matte Black.
- ▶ Metal Ashlar handle with multi-point locking lever. Available in White, Rustic Umber, Satin Nickel or Matte Black.
- ▶ Nesting handle with custodial lock prohibits unauthorized operation. Available in White, Beige, Rustic Umber or Matte Black.
- ▶ Universal design casement handle and lock are larger and offer ease-of-use for people with physical limitations. Available in White or Clay.

†Locking lever is not available on French casements.

**The Oil-Rubbed finish is a living finish, which means that it will change appearance over time with use.

Nesting Handle
(shown in Satin Nickel)



Ashlar Handle
(shown in Rustic Umber)



Locking Lever†
(shown in Antique Brass)



Nesting Handle with Custodial Lock
(shown in Matte Black)





Crank-Out Casement Options

Glass (pg. 200)

- ▶ Solar Gain Low-E
- ▶ Solar Advanced Control Low-E
- ▶ Solar Control Low-E
- ▶ ThermaPlus™ Low-E
- ▶ Neat®
- ▶ Patterned-, bronze-, or gray-lite
- ▶ Tempered or laminated
- ▶ Other options standard to the industry

Divided Lites (pg. 201)

- ▶ Performance divided lites with 5/8", 7/8", 1-1/8", 1-3/8", 1-3/4", 2-1/4" or 4-1/2" bars
- ▶ Grilles-in-the-air space

Insect Screens

- ▶ Insect screen with aluminum or UltraVue® fiberglass mesh; frame available in White, Beige, Dark Bronze anodized, Clear anodized, or Coal Black
- ▶ Retractable insect screen kit with beveled or square cover (pg. 204)
- ▶ Wood wrapped insect screen frame (not available on radius top units)
- ▶ Brass insect screen with Brass frame (not available on radius top units)

NOTE: All measurements are nominal.

Other Options (not all options are available on all casement types; custom options are also available)

- ▶ French crank-out casements
- ▶ Other wood species and FSC®-certified wood (pg. 198)
- ▶ Interior prefinishing (pg. 198)
- ▶ Interior casing
- ▶ Ovolo or square profile glazing beads and interior divided lite bars (pg. 201)
- ▶ Prep for stool
- ▶ Extruded aluminum accessories applied to accessory grooves on the exterior frame (pgs. 206-212)
- ▶ Motorized operator
- ▶ Single-arm operators with Euro hinges (meet emergency escape and rescue requirements on some "L" Series casements)
- ▶ Stainless steel exterior operator parts
- ▶ Ashlar handle in Satin Nickel, White, Rustic Umber or Matte Black
- ▶ Extension jambs (up to 12" applied, over 12" shipped loose for field application)
- ▶ Galvanized steel installation clips
- ▶ Factory-installed Window Opening Control Device (WOCD) (pg. 203)
- ▶ Bow and bay options: insulated platforms, support brackets, and oak-veneered head and seat boards
- ▶ High performance or impact performance modifications (pg. 205)

Universal Design Handle (shown in Clay)

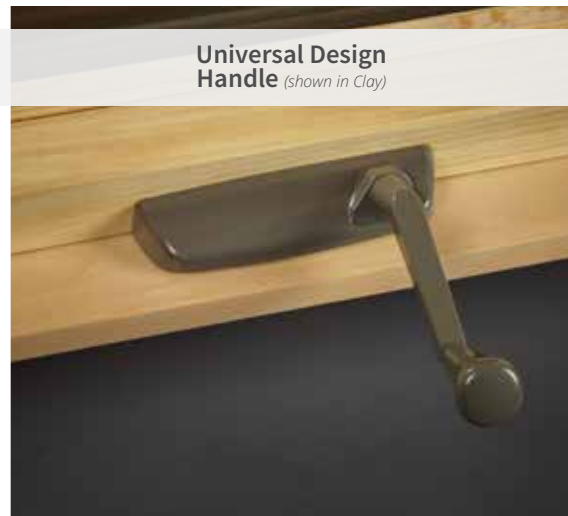

Crank-Out XL Casement

Kolbe's crank-out XL casements fill massive openings for generous views and ventilation. A simple cranking operation opens and closes the window easily, despite the large size, with a choice of handle styles that fold down to avoid interference with curtains or drapes.



Crank-Out XL Casement Standard Features

- ▶ 2-1/4" thick sash
- ▶ Overall jamb width is 4-9/16" (basic box width is 3-1/4" plus extensions)
- ▶ Constructed of pine, with pine interior stops and wood mull casings on mullied units
- ▶ Exterior wood parts are treated
- ▶ Extruded aluminum exterior finished with a 70% PVDF fluoropolymer coating (meets performance requirements of AAMA 2605)
- ▶ Accessory grooves are integral to the extruded frames for the easy addition of accessories
- ▶ Energy efficient, insulating Solar Low-E glass
- ▶ Glazed to the interior with beveled wood glazing beads
- ▶ Interior insect screen with Clay-colored aluminum frame and BetterVue® fiberglass mesh
- ▶ Clay-colored nesting handle and locking lever with multi-point locking system
- ▶ Corrosion resistant, dual-arm operators with concealed, adjustable hinges (On "W" series and wider. Dyad operators with concealed, adjustable hinges on units narrower than "W"; single-arm operators with Tri-Euro hinges for added support on segment head, half-circle top and impact units)
- ▶ Heavy vinyl nailing fins with head drip caps*

NOTE: All measurements are nominal.

* Standard only on units without brickmould.

Hardware

- ▶ Nesting handle and locking lever† provide a sleek look and are unobtrusive. Available in Clay, White, Beige, Bright Brass, Antique Brass, Satin Nickel, Antique Nickel, Rustic Umber, Oil-Rubbed** or Matte Black.
- ▶ Metal Ashlar handle with multi-point locking lever. Available in White, Rustic Umber, Satin Nickel or Matte Black.
- ▶ Nesting handle with custodial lock prohibits unauthorized operation. Available in White, Beige, Rustic Umber or Matte Black.
- ▶ Universal design casement handle and lock are larger and offer ease-of-use for people with physical limitations. Available in White or Clay.

†Locking lever is not available on French casements.

**The Oil-Rubbed finish is a living finish, which means that it will change appearance over time with use.

Nesting Handle
(shown in Satin Nickel)

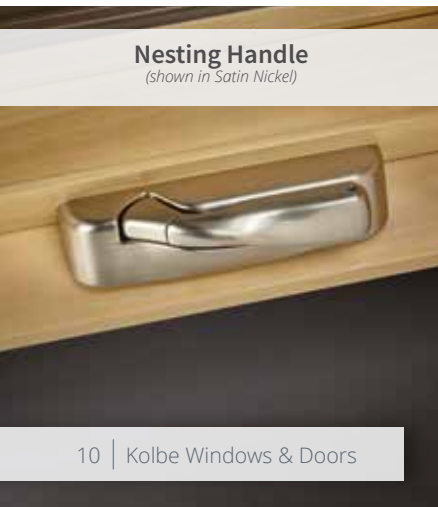

Ashlar Handle
(shown in Rustic Umber)

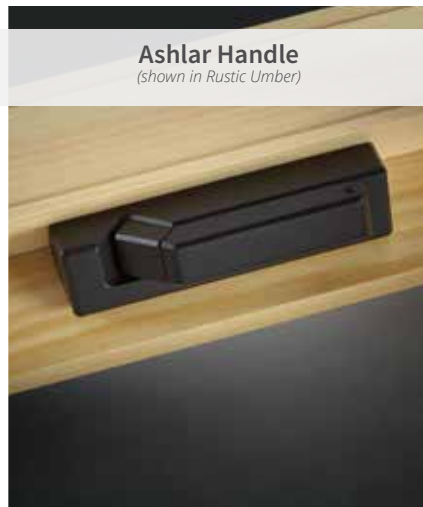

Locking Lever†
(shown in Antique Brass)

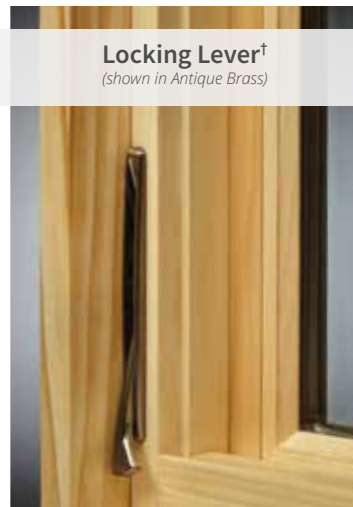

Nesting Handle with Custodial Lock
(shown in Matte Black)

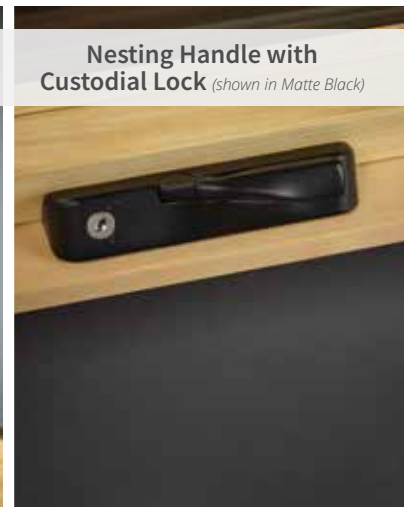



Crank-Out XL Casement Options

Glass (pg. 200)

- ▶ Solar Gain Low-E
- ▶ Solar Advanced Control Low-E
- ▶ Solar Control Low-E
- ▶ ThermaPlus™ Low-E
- ▶ Neat®
- ▶ Triple pane
- ▶ Patterned-, bronze-, or gray-lite
- ▶ Tempered or laminated
- ▶ Other options standard to the industry

Divided Lites (pg. 201)

- ▶ Performance divided lites with 5/8", 7/8", 1-1/8", 1-3/8", 1-3/4", 2-1/4" or 4-1/2" bars
- ▶ Grilles-in-the-airspace

Insect Screens

- ▶ Insect screen with aluminum or UltraVue® fiberglass mesh; frame available in White, Beige, Dark Bronze anodized, Clear anodized, or Coal Black
- ▶ Retractable insect screen kit with beveled or square cover (pg. 204)
- ▶ Wood wrapped insect screen frame (not available on radius top units)
- ▶ Brass insect screen with Brass frame (not available on radius top units)

NOTE: All measurements are nominal.

Other Options (not all options are available on all casement types; custom options are also available)

- ▶ French crank-out casements
- ▶ Other wood species and FSC®-certified wood (pg. 198)
- ▶ Interior prefinishing (pg. 198)
- ▶ Interior casing
- ▶ Ovolo or square profile glazing beads and interior divided lite bars (pg. 201)
- ▶ Prep for stool
- ▶ Extruded aluminum accessories applied to accessory grooves on the exterior frame (pgs. 206-212)
- ▶ Ashlar handle in Satin Nickel, White, Rustic Umber or Matte Black
- ▶ Single-arm operators with Euro hinges (meet emergency escape and rescue requirements on some "L" Series casements)
- ▶ Stainless steel exterior operator parts
- ▶ Extension jambs (up to 12" applied, over 12" shipped loose for field application)
- ▶ Galvanized steel installation clips
- ▶ Factory-installed Window Opening Control Device (WOCD) (pg. 203)
- ▶ High performance or impact performance modifications (pg. 205)

Universal Design Handle (shown in Clay)

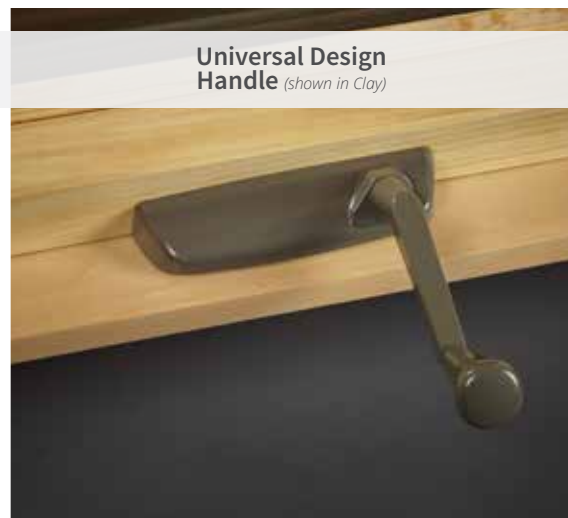



Push-Out Casement

Kolbe's push-out casements have a uniquely simple operation – just unlock a handle to push open or pull closed. Combining ease-of-operation with authentic style, push-out casements offer old-world aesthetics with enhanced energy efficiency.

Push-Out Casement Standard Features

- ▶ 1-3/4" thick sash
- ▶ Overall jamb width is 4-9/16" (*basic box width is 2-3/4" plus extensions*)
- ▶ Constructed of pine, with pine interior stops and wood mull casings on mullied units
- ▶ Exterior wood parts are treated
- ▶ Extruded aluminum exterior finished with a 70% PVDF fluoropolymer coating (*meets performance requirements of AAMA 2605*)
- ▶ Accessory grooves are integral to the extruded frames for the easy addition of accessories
- ▶ Energy efficient, insulating Solar Low-E glass
- ▶ Glazed to the interior with beveled wood glazing beads
- ▶ Single-point lever handle in an Oil-Rubbed* finish
- ▶ Concealed hinges (*segment head and half-circle top units use tri-Euro hinges for added support*)
- ▶ Heavy vinyl nailing fins with head drip caps**

NOTE: All measurements are nominal.

*The Oil-Rubbed finish is a living finish, which means that it will change appearance over time with use.

** Standard only on units without brickmould.

Hardware

- ▶ Easy-to-operate single-point or multi-point handles that pull the sash tightly to the frame when closed, with weather stripping to prevent air infiltration and further promote energy efficiency. Available in Oil-Rubbed*, Natural Brass or Satin Nickel.

*The Oil-Rubbed finish is a living finish, which means that it will change appearance over time with use.

Photo courtesy of Benjamin Benschneider Photography & Janof Hald Architecture

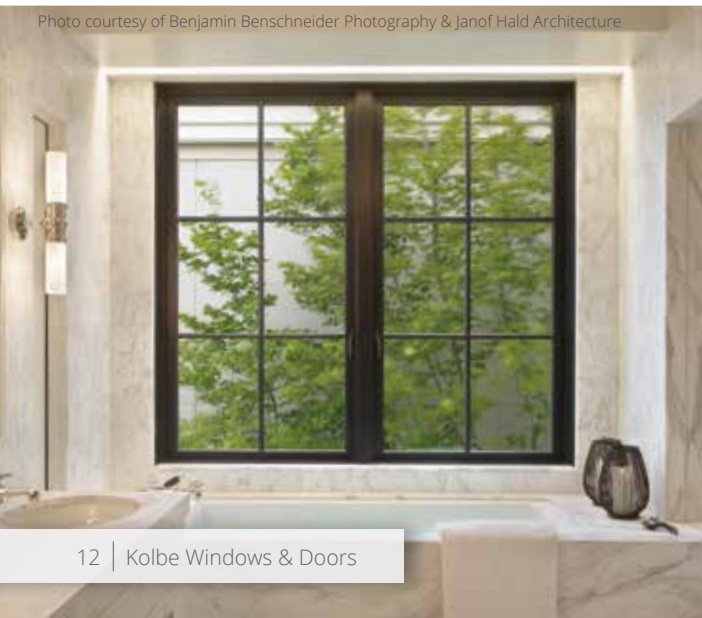

Single-Point Lock (*shown in Oil-Rubbed**)



Multi-Point Lock (*shown in Satin Nickel*)



Push-Out EP Casement

Push-out EP (Energy Performance) casement windows feature triple pane glass to provide better energy performance as well as meet ENERGY STAR® criteria for U.S. and Canadian climate zones.

Standard Features *(includes push-out casement standard features on pg. 14, with the exception of the following substitutions)*

- ▶ 2-1/4" thick sash
- ▶ Overall jamb width is 4-9/16" *(basic box width is 3-1/4" plus extensions)*
- ▶ 1-3/8" total thickness of triple pane glass with Solar Low-E and Solar Gain Low-E coatings

Push-Out and Push-Out EP Casement Options

Glass *(pg. 200)*

- ▶ Solar Gain Low-E
- ▶ Solar Advanced Control Low-E
- ▶ Solar Control Low-E
- ▶ ThermaPlus™ Low-E
- ▶ Neat®
- ▶ Triple pane
- ▶ Patterned-, bronze-, or gray-lite
- ▶ Tempered or laminated
- ▶ Other options standard to the industry

Divided Lites *(pg. 201)*

- ▶ Performance divided lites with 5/8", 7/8", 1-1/8", 1-3/8", 1-3/4", 2-1/4" or 4-1/2" bars
- ▶ Grilles-in-the-airspace

Insect Screens

- ▶ Retractable insect screen with BetterVue® or UltraVue® fiberglass mesh and a beveled or square wood cover *(pg. 204)*
(not available for segment head and half-circle top casements)
- ▶ Swinging insect screen with BetterVue® or UltraVue® fiberglass mesh and wood frame

Other Options *(not all options are available on all casement types; custom options are also available)*

- ▶ French push-out casements
- ▶ Other wood species and FSC®-certified wood *(pg. 198)*
- ▶ Interior prefinishing *(pg. 198)*
- ▶ Interior casing
- ▶ Ovolo or square profile glazing beads and interior divided lite bars *(pg. 201)*
- ▶ Prep for stool
- ▶ Extruded aluminum accessories applied to accessory grooves on the exterior frame *(pgs. 206-212)*
- ▶ Extension jambs *(up to 12" applied, over 12" shipped loose for field application)*
- ▶ Galvanized steel installation clips

NOTE: All measurements are nominal.

Casements | Elevation Charts

Casements | Single Units

F.S.	1'-4"	1'-8"	2'-0"	2'-4"	2'-6"	2'-8"	3'-0"
R.O.	1'-4 1/2"	1'-8 1/2"	2'-0 1/2"	2'-4 1/2"	2'-6 1/2"	2'-8 1/2"	3'-0 1/2"
G.S.	10 5/8"	14 5/8"	18 5/8"	22 5/8"	24 5/8"	26 5/8"	30 5/8"
G.S.**	9 7/8"	13 7/8"	17 7/8"	21 7/8"	23 7/8"	25 7/8"	29 7/8"
2'-0"							
2'-6"							
3'-0"							
3'-6"							
4'-0"							
4'-6"							
5'-0"							
5'-6"							
6'-0"							

* Units meet most national emergency escape and rescue requirements when modified with single-arm operators and Euro hinges.

** Glass size for push-out casements

† These push-out units are only available with single-point hardware

F.S. = Frame Size • R.O. = Rough Opening • G.S. = Glass Size

Dimension Calculations

	Width	Height
F.S. to Sash O.S.M.	-1 15/16"	1-15/16"
Sash O.S.M. to G.S.	-2 13/16"	2-13/16"
G.S. to D.L.O.	-1"	-1"
G.S. to Screen O.S.M.	+1-9/16"	+1/2"
U.D. to G.S. (for push-outs)	-8-11/16"	-8 3/16"

Note: Clear opening dimensions can be found on pgs. 216-218.

F.S. = Frame Size • G.S. = Glass Size • O.S.M. = Outside Measurement
D.L.O. = Daylight Opening • U.D. = Unit Dimension

NOTE: All measurements are nominal. Elevation charts are not to scale. Above sizes are available as crank-out and push-out casements. For push-out casements, have dealer specify push-out when placing order for unit. Divided lites are optional.

Specify stationary, left or right venting when ordering single units. Venting is viewed from the exterior.

Some installation procedures will require a larger rough opening than noted (i.e. installations utilizing our installation clips), therefore, you may need to increase the rough opening size accordingly. Rough opening gaps may be increased up to a maximum of 1/2" on all sides and still be within good practice guidelines. For rough opening recommendations, see pg. 216.

Additional and the most current drawings are available at www.kolbewindows.com.

Casements | "S" Series (1'4" wide)

F.S.	1'-4"	2'-8"	4'-0"	5'-4"	6'-8"
R.O.	1'-4 1/2"	2'-8 1/2"	4'-0 1/2"	5'-4 1/2"	6'-8 1/2"
G.S.	10 5/8"	10 5/8"	10 5/8"	10 5/8"	10 5/8"
G.S.*	9 7/8"	9 7/8"	9 7/8"	9 7/8"	9 7/8"

2'-0"					
2'-6"					
3'-0"					
3'-6"					
4'-0"					
4'-6"					
5'-0"					
5'-6"					
6'-0"					
6'-6"					
7'-0"					

Dimension Calculations

	Width	Height
F.S. to Sash O.S.M.	-1 15/16"	1-15/16"
Sash O.S.M. to G.S.	-2 13/16"	2-13/16"
G.S. to D.L.O.	-1"	-1"
G.S. to Screen O.S.M.	+1-9/16"	+1/2"
F.S. to G.S. (for push-outs)	-8-11/16"	-8 3/16"

Note: Clear opening dimensions can be found on pgs. 216-218.

F.S. = Frame Size • G.S. = Glass Size • O.S.M. = Outside Measurement
D.L.O. = Daylight Opening • U.D. = Unit Dimension

* Glass size for push-out casements

† These push-out units are only available with single-point hardware

†† Unit heights are only available for crank-out casements

F.S. = Frame Size • R.O. = Rough Opening • G.S. = Glass Size
(Glass sizes are shown per sash)

NOTE: All measurements are nominal. Elevation charts are not to scale. Above sizes are available as crank-out and push-out casements.

For push-out casements, have dealer specify push-out when placing order for unit. Divided lites are optional.

Specify stationary, left or right venting when ordering single units. Venting is viewed from the exterior.

Some installation procedures will require a larger rough opening than noted (i.e. installations utilizing our installation clips), therefore, you may need to increase the rough opening size accordingly. Rough opening gaps may be increased up to a maximum of 1/2" on all sides and still be within good practice guidelines.

For rough opening recommendations, see pg. 216.

Additional and the most current drawings are available at www.kolbwindows.com.

Casements | Elevation Charts

Casements | "N" Series (1'8" wide)

F.S.	1'-8"	3'-4"	5'-0"	6'-8"	8'-4"
R.O.	1'-8 1/2"	3'-4 1/2"	5'-0 1/2"	6'-8 1/2"	8'-4 1/2"
G.S.	14 5/8"	14 5/8"	14 5/8"	14 5/8"	14 5/8"
G.S.*	13 7/8"	13 7/8"	13 7/8"	13 7/8"	13 7/8"
2'-0"					
2'-6"					
3'-0"					
3'-6"					
4'-0"					
4'-6"					
5'-0"					
5'-6"					
6'-0"					
6'-6"					
7'-0"					

* Glass size for push-out casements
 † Push-out units are only available with single-point hardware
 †† Unit heights are only available for crank-out casements
 F.S. = Frame Size • R.O. = Rough Opening • G.S. = Glass Size
 (Glass sizes are shown per sash)

NOTE: All measurements are nominal. Elevation charts are not to scale. Above sizes are available as crank-out and push-out casements. For push-out casements, have dealer specify push-out when placing order for unit. Divided lites are optional.

Specify stationary, left or right venting when ordering single units. Venting is viewed from the exterior.

Some installation procedures will require a larger rough opening than noted (i.e. installations utilizing our installation clips), therefore, you may need to increase the rough opening size accordingly. Rough opening gaps may be increased up to a maximum of 1/2" on all sides and still be within good practice guidelines. For rough opening recommendations, see pg. 216.

Additional and the most current drawings are available at www.kolbewindows.com.

Casements | "W" Series (2'0" wide)

	2'-0"	4'-0"	6'-0"	8'-0"	10'-0"	12'-0"
F.S.	2'-0"	4'-0"	6'-0"	8'-0"	10'-0"	12'-0"
R.O.	2'-0 1/2"	4'-0 1/2"	6'-0 1/2"	8'-0 1/2"	10'-0 1/2"	12'-0 1/2"
G.S.	18 5/8"	18 5/8"	18 5/8"	18 5/8"	18 5/8"	18 5/8"
G.S.*	17 7/8"	17 7/8"	17 7/8"	17 7/8"	17 7/8"	17 7/8"
2'-0"						
2'-6"						
3'-0"						
3'-6"						
4'-0"						
4'-6"						
5'-0"						
5'-6"						
6'-0"						
6'-6"						
7'-0"						

* Glass size for push-out casements

† Push-out units are only available with single-point hardware

†† Unit heights are only available for crank-out casements

F.S. = Frame Size • R.O. = Rough Opening • G.S. = Glass Size (Glass sizes are shown per sash)

NOTE: All measurements are nominal. Elevation charts are not to scale. Above sizes are available as crank-out and push-out casements. For push-out casements, have dealer specify push-out when placing order for unit. Divided lites are optional.

Specify stationary, left or right venting when ordering single units. Venting is viewed from the exterior.

Some installation procedures will require a larger rough opening than noted (i.e. installations utilizing our installation clips), therefore, you may need to increase the rough opening size accordingly. Rough opening gaps may be increased up to a maximum of 1/2" on all sides and still be within good practice guidelines.

For rough opening recommendations, see pg. 216.

Additional and the most current drawings are available at www.kolbwindows.com.

Casements | Elevation Charts

Casements | "L" Series (2'4" wide)

	2'-4"	4'-8"	7'-0"	9'-4"	11'-8"	14'-0"
F.S.	2'-4 1/2"	4'-8 1/2"	7'-0 1/2"	9'-4 1/2"	11'-8 1/2"	14'-0 1/2"
R.O.	2'-4 5/8"	4'-8 5/8"	7'-0 5/8"	9'-4 5/8"	11'-8 5/8"	14'-0 5/8"
G.S.	2'-4 1/8"	4'-8 1/8"	7'-0 1/8"	9'-4 1/8"	11'-8 1/8"	14'-0 1/8"
G.S.**	21 7/8"	21 7/8"	21 7/8"	21 7/8"	21 7/8"	21 7/8"
2'-0"						
2'-0"	L12†	L22†	L32†	L42†	L52†	L62†
2'-6"						
2'-6"	L126†	L226†	L326†	L426†	L526†	L626†
3'-0"						
3'-0"	L13	L23	L33	L43	L53	L63
3'-6"						
3'-6"	L136	L236	L336	L436	L536	L636
4'-0"						
4'-0"	L14*	L24*	L34*	L44*	L54*	L64*
4'-6"						
4'-6"	L146*	L246*	L346*	L446*	L546*	L646*
5'-0"						
5'-0"	L15*	L25*	L35*	L45*	L55*	L65*
5'-6"						
5'-6"	L156*	L256*	L356*	L456*	L556*	L656*
6'-0"						
6'-0"	L16*	L26*	L36*	L46*	L56*	L66*
6'-6"						
6'-6"	L166††	L266††	L366††	L466††	L566††	L666††
7'-0"						
7'-0"	L17††	L27††	L37††	L47††	L57††	L67††

* Units meet most national emergency escape and rescue requirements when modified with single-arm operators and Euro hinges

** Glass size for push-out casements

† Push-out units are only available with single-point hardware

†† Unit heights are only available for crank-out casements

F.S. = Frame Size • R.O. = Rough Opening • G.S. = Glass Size (Glass sizes are shown per sash)

Casements | "X" Series (2'6" wide)

F.S.	2'-6"	5'-0"	7'-6"	10'-0"	12'-6"
R.O.	2'-6 1/2"	5'-0 1/2"	7'-6 1/2"	10'-0 1/2"	12'-6 1/2"
G.S.	24 5/8"	24 5/8"	24 5/8"	24 5/8"	24 5/8"
G.S.**	23 7/8"	23 7/8"	23 7/8"	23 7/8"	23 7/8"
2'-0"					
2'-6"					
3'-0"					
3'-6"					
4'-0"					
4'-6"					
5'-0"					
5'-6"					
6'-0"					
6'-6"					
7'-0"					

* Units meet most national emergency escape and rescue requirements when modified with single-arm operators and Euro hinges

** Glass size for push-out casements

† Push-out units are only available with single-point hardware

†† Unit heights are only available for crank-out casements

F.S. = Frame Size • R.O. = Rough Opening • G.S. = Glass Size
(Glass sizes are shown per sash)

NOTE: All measurements are nominal. Elevation charts are not to scale. Above sizes are available as crank-out and push-out casements. For push-out casements, have dealer specify push-out when placing order for unit. Divided lites are optional.

Specify stationary, left or right venting when ordering single units. Venting is viewed from the exterior.

Some installation procedures will require a larger rough opening than noted (i.e. installations utilizing our installation clips), therefore, you may need to increase the rough opening size accordingly. Rough opening gaps may be increased up to a maximum of 1/2" on all sides and still be within good practice guidelines. For rough opening recommendations, see pg. 216.

Additional and the most current drawings are available at www.kolbewindows.com.

Casements | Elevation Charts

Casements | "C" Series (2'8" wide)

	2'-8"	5'-4"	8'-0"	10'-8"	13'-4"
F.S.	2'-8 1/2"	5'-4 1/2"	8'-0 1/2"	10'-8 1/2"	13'-4 1/2"
R.O.	26 5/8"	26 5/8"	26 5/8"	26 5/8"	26 5/8"
G.S.**	25 7/8"	25 7/8"	25 7/8"	25 7/8"	25 7/8"

2'-0"					
2'-6"					
3'-0"					
3'-6"					
4'-0"					
4'-6"					
5'-0"					
5'-6"					
6'-0"					
6'-6"					
7'-0"					

** Glass size for push-out casements. F.S. = Frame Size • R.O. = Rough Opening • G.S. = Glass Size (Glass sizes are shown per sash)
 † Push-out units are only available with single-point hardware

Casements | "E" Series (3'0" wide)

F.S.	3'-0"	6'-0"	9'-0"
R.O.	3'-0 1/2"	6'-0 1/2"	9'-0 1/2"
G.S.	30 5/8"	30 5/8"	30 5/8"
G.S.**	29 7/8"	29 7/8"	29 7/8"

3'-0"			
E13	E23	E33	
3'-6"			
E136*	E236*	E336*	
4'-0"			
E14*	E24*	E34*	
4'-6"			
E146*	E246*	E346*	
5'-0"			
E15*	E25*	E35*	
5'-6"			
E156*	E256*	E356*	
6'-0"			
E16*	E26*	E36*	
6'-6"			
E166**	E266**	E366**	
7'-0"			
E17**	E27**	E37**	

* Units meet most national escape and rescue requirements
 ** Glass size for push-out casements
 † Unit heights are only available for crank-out casements
 F.S. = Frame Size • R.O. = Rough Opening • G.S. = Glass Size (Glass sizes are shown per sash)

NOTE: All measurements are nominal. Elevation charts are not to scale. Above sizes are available as crank-out and push-out casements. For push-out casements, have dealer specify push-out when placing order for unit. Divided lites are optional. Specify stationary, left or right venting when ordering single units. Venting is viewed from the exterior. Some installation procedures will require a larger rough opening than noted (i.e. installations utilizing our installation clips), therefore, you may need to increase the rough opening size accordingly. Rough opening gaps may be increased up to a maximum of 1/2" on all sides and still be within good practice guidelines. For rough opening recommendations, see pg. 216. Additional and the most current drawings are available at www.kolbewindows.com.

Casements | Elevation Charts

Casements | Rectangular Transoms & Picture Units

F.S.	1'-4"	1'-8"	2'-0"	2'-6"	2'-8"	3'-0"	3'-4"	4'-0"	4'-6"	5'-0"	6'-0"
R.O.	1'-4 1/2"	1'-8 1/2"	2'-0 1/2"	2'-6 1/2"	2'-8 1/2"	3'-0 1/2"	3'-4 1/2"	4'-0 1/2"	4'-6 1/2"	5'-0 1/2"	6'-0 1/2"
G.S.*	10 5/8"	14 5/8"	18 5/8"	24 5/8"	26 5/8"	30 5/8"	34 5/8"	42 5/8"	48 5/8"	54 5/8"	66 5/8"
G.S.*	9 7/8"	13 7/8"	17 7/8"	23 7/8"	25 7/8"	29 7/8"	33 7/8"	41 7/8"	47 7/8"	53 7/8"	65 7/8"
1'-4"											
1'-6"											
1'-8"											
1'-6 1/2"											
14 5/8"											
13 7/8"											
2'-0"											
2'-0 1/2"											
2'-6"											
2'-6 1/2"											
3'-0"											
3'-0 1/2"											
3'-6"											
3'-6 1/2"											
4'-0"											
4'-0 1/2"											
4'-6"											
4'-6 1/2"											
5'-0"											
5'-0 1/2"											
5'-6"											
5'-6 1/2"											
6'-0"											
6'-0 1/2"											
66 5/8"											
65 7/8"											

* Glass size for units to match operating push-out casements
 F.S. = Frame Size • R.O. = Rough Opening • G.S. = Glass Size

NOTE: All measurements are nominal. Elevation charts are not to scale. Above sizes are available as crank-out and push-out casements. Divided lites are optional.

















The units shown are stand-alone units. Adjustments may be required when stacking over other units; adjustments will be made in the factory.

Some installation procedures will require a larger rough opening than noted (i.e. installations utilizing our installation clips), therefore, you may need to increase the rough opening size accordingly. Rough opening gaps may be increased up to a maximum of 1/2" on all sides and still be within good practice guidelines. For rough opening recommendations, see pg. 216.

Additional and the most current drawings are available at www.kolbewindows.com.

French Casements

F.S.	3'-4"	4'-0"	5'-0"
R.O.	3'-4 1/2"	4'-0 1/2"	5'-0 1/2"
G.S.	15 15/32"	19 15/32"	25 15/32"
G.S.*	14 23/32"	18 23/32"	24 23/32"

3'-0"	3'-0 1/2"	30 5/8"	29 7/8"			
				FN23	FW23	FX23
3'-6"	3'-6 1/2"	36 5/8"	35 7/8"			
				FN236	FW236	FX236**
4'-0"	4'-0 1/2"	42 5/8"	41 7/8"			
				FN24	FW24	FX24**
4'-6"	4'-6 1/2"	48 5/8"	47 7/8"			
				FN246	FW246	FX246**
5'-0"	5'-0 1/2"	54 5/8"	53 7/8"			
				FN25	FW25	FX25**
5'-6"	5'-6 1/2"	60 5/8"	59 7/8"			
				FN256		
6'-0"	6'-0 1/2"	66 5/8"	65 7/8"			
				FN26		

* Glass size for push-out casements

** Units meet most national escape and rescue requirements

F.S. = Frame Size • R.O. = Rough Opening • G.S. = Glass Size (Glass sizes are shown per sash)

NOTE: All measurements are nominal. Elevation charts are not to scale. Divided lites are optional.

Some installation procedures will require a larger rough opening than noted (i.e. installations utilizing our installation clips), therefore, you may need to increase the rough opening size accordingly. Rough opening gaps may be increased up to a maximum of 1/2" on all sides and still be within good practice guidelines. For rough opening recommendations, see pg. 216.

Additional and the most current drawings are available at www.kolbewindows.com.

Casements | Elevation Charts

Casements | "N" Series Picture Unit Combinations

F.S.	5'-0"		5'-0"		6'-8"			6'-8"		6'-8"		8'-4"		
R.O.	5'-0 1/2"		5'-0 1/2"		6'-8 1/2"			6'-8 1/2"		6'-8 1/2"		8'-4 1/2"		
G.S.	14 5/8" 34 5/8"		34 5/8" 14 5/8"		14 5/8" 34 5/8" 14 5/8"			14 5/8" 54 5/8"		54 5/8" 14 5/8"		14 5/8" 54 5/8" 14 5/8"		
G.S.*	13 7/8" 33 7/8"		33 7/8" 13 7/8"		13 7/8" 33 7/8" 13 7/8"			13 7/8" 53 7/8"		53 7/8" 13 7/8"		13 7/8" 53 7/8" 13 7/8"		
3'-0"	3'-0 1/2" 29 7/8"		3'-0 1/2" 29 7/8"		3'-0 1/2" 29 7/8"			3'-0 1/2" 29 7/8"		3'-0 1/2" 29 7/8"		3'-0 1/2" 29 7/8"		
N33PL	N33PR		N43P			N43PL		N43PR		N53P				
3'-6"	3'-6 1/2" 35 7/8"		3'-6 1/2" 35 7/8"		3'-6 1/2" 35 7/8"			3'-6 1/2" 35 7/8"		3'-6 1/2" 35 7/8"		3'-6 1/2" 35 7/8"		
N336PL	N336PR		N436P			N436PL		N436PR		N536P				
4'-0"	4'-0 1/2" 41 7/8"		4'-0 1/2" 41 7/8"		4'-0 1/2" 41 7/8"			4'-0 1/2" 41 7/8"		4'-0 1/2" 41 7/8"		4'-0 1/2" 41 7/8"		
N34PL	N34PR		N44P			N44PL		N44PR		N54P				
4'-6"	4'-6 1/2" 47 7/8"		4'-6 1/2" 47 7/8"		4'-6 1/2" 47 7/8"			4'-6 1/2" 47 7/8"		4'-6 1/2" 47 7/8"		4'-6 1/2" 47 7/8"		
N346PL	N346PR		N446P			N446PL		N446PR		N546P				
5'-0"	5'-0 1/2" 53 7/8"		5'-0 1/2" 53 7/8"		5'-0 1/2" 53 7/8"			5'-0 1/2" 53 7/8"		5'-0 1/2" 53 7/8"		5'-0 1/2" 53 7/8"		
N35PL	N35PR		N45P			N45PL		N45PR		N55P				
5'-6"	5'-6 1/2" 59 7/8"		5'-6 1/2" 59 7/8"		5'-6 1/2" 59 7/8"			5'-6 1/2" 59 7/8"		5'-6 1/2" 59 7/8"		5'-6 1/2" 59 7/8"		
N356PL	N356PR		N456P			N456PL		N456PR		N556P				
6'-0"	6'-0 1/2" 65 7/8"		6'-0 1/2" 65 7/8"		6'-0 1/2" 65 7/8"			6'-0 1/2" 65 7/8"		6'-0 1/2" 65 7/8"		6'-0 1/2" 65 7/8"		
N36PL	N36PR		N46P			N46PL		N46PR		N56P				

* Glass size for push-out casements

F.S. = Frame Size • R.O. = Rough Opening • G.S. = Glass Size

NOTE: All measurements are nominal. Elevation charts are not to scale. Above sizes are available as crank-out and push-out casements. For push-out casements, have dealer specify push-out when placing order for unit. Divided lites are optional.

Some installation procedures will require a larger rough opening than noted (i.e. installations utilizing our installation clips), therefore, you may need to increase the rough opening size accordingly. Rough opening gaps may be increased up to a maximum of 1/2" on all sides and still be within good practice guidelines. For rough opening recommendations, see pg. 216.

Additional and the most current drawings are available at www.kolbewindows.com.

Casements | "W" Series Picture Unit Combinations

F.S.	6'-0"		6'-0"		8'-0"			8'-0"		8'-0"		10'-0"		
R.O.	6'-0 1/2"		6'-0 1/2"		8'-0 1/2"			8'-0 1/2"		8'-0 1/2"		10'-0 1/2"		
G.S.*	18 5/8"	42 5/8"	42 5/8"	18 5/8"	18 5/8"	42 5/8"	18 5/8"	18 5/8"	66 5/8"	18 5/8"	66 5/8"	18 5/8"	66 5/8"	18 5/8"
G.S.*	17 7/8"	41 7/8"	41 7/8"	17 7/8"	17 7/8"	41 7/8"	17 7/8"	17 7/8"	65 7/8"	17 7/8"	65 7/8"	17 7/8"	65 7/8"	17 7/8"
3'-0"														
3'-6"														
4'-0"														
4'-6"														
5'-0"														
5'-6"														
6'-0"														

* Glass size for push-out casements
 F.S. = Frame Size • R.O. = Rough Opening • G.S. = Glass Size

NOTE: All measurements are nominal. Elevation charts are not to scale. Above sizes are available as crank-out and push-out casements. For push-out casements, have dealer specify push-out when placing order for unit. Divided lites are optional.

Some installation procedures will require a larger rough opening than noted (i.e. installations utilizing our installation clips), therefore, you may need to increase the rough opening size accordingly. Rough opening gaps may be increased up to a maximum of 1/2" on all sides and still be within good practice guidelines. For rough opening recommendations, see pg. 216.

Additional and the most current drawings are available at www.kolbewindows.com.

Casements | Elevation Charts

Casements | "N" Series Bow Windows

UNIT PROJECTION: 5 3/32"		8 47/64"		12 19/64"		17 37/64"		22 23/32"	
U.D.	5'-0 49/64"	6'-8 17/64"	8'-3 11/16"	9'-10 5/64"	11'-3 37/64"				
R.O.	5'-0 3/4"	6'-8 13/64"	8'-2 63/64"	9'-8 63/64"	11'-2 1/64"				
G.S.	14 5/8"	14 5/8"	14 5/8"	14 5/8"	14 5/8"				
3'-0"									
3'-6"									
4'-0"									
4'-6"									
5'-0"									
5'-6"									
6'-0"									

U.D. = Unit Dimension • R.O. = Rough Opening • G.S. = Glass Size (Glass sizes are shown per sash)

NOTE: All measurements are nominal. Elevation charts are not to scale. Divided lites are optional.

If the cable support system and/or insulated platforms and support brackets are not being used, other means of proper support must be used.

Add 1-11/16" to the rough opening height if an insulated platform is being used. Rough openings for bow units without head and seat boards, typically used for walk-out applications, are different.

Some installation procedures will require a larger rough opening than noted (i.e. installations utilizing our installation clips), therefore, you may need to increase the rough opening size accordingly. Rough opening gaps may be increased up to a maximum of 1/2" on all sides and still be within good practice guidelines. For rough opening recommendations, see pg. 216.

Additional and the most current drawings are available at www.kolbewindows.com.

Casements | Elevation Charts

Casements | "S" Series 30° Bay Windows

UNIT PROJECTIONS: 10 13/32"

	3'-11 43/64"	5'-3 43/64"	6'-7 43/64"
U.D.	3'-11 43/64"	5'-3 43/64"	6'-7 43/64"
R.O.	3'-10 7/64"	5'-2 7/64"	6'-6 7/64"
G.S.	10 5/8"	10 5/8"	10 5/8"
3'-0"			
3'-6"			
4'-0"			
4'-6"			
5'-0"			
5'-6"			
6'-0"			
	30-S13-13-13	30-S13-23-13	30-S13-33-13
	30-S136-136-136	30-S136-236-136	30-S136-336-136
	30-S14-14-14	30-S14-24-14	30-S14-34-14
	30-S146-146-146	30-S146-246-146	30-S146-346-146
	30-S15-15-15	30-S15-25-15	30-S15-35-15
	30-S156-156-156	30-S156-256-156	30-S156-356-156
	30-S16-16-16	30-S16-26-16	30-S16-36-16

U.D. = Unit Dimension • R.O. = Rough Opening • G.S. = Glass Size (Glass sizes are shown per sash)

NOTE: All measurements are nominal. Elevation charts are not to scale. Divided lites are optional. If the cable support system and/or insulated platforms and support brackets are not being used, other means of proper support must be used. Add 1-11/16" to the rough opening height if an insulated platform is being used. Rough openings for bay units without head and seat boards, typically used for walk-out applications, are different. Some installation procedures will require a larger rough opening than noted (i.e. installations utilizing our installation clips), therefore, you may need to increase the rough opening size accordingly. Rough opening gaps may be increased up to a maximum of 1/2" on all sides and still be within good practice guidelines. For rough opening recommendations, see pg. 216. Additional and the most current drawings are available at www.kolbewindows.com.

Casements | "N" Series 30° Bay Windows

UNIT PROJECTION: 12 13/32"

	4'-10 39/64"	6'-6 39/64"	6'-6 39/64"	8'-2 39/64"	8'-2 39/64"
R.O.	4'-9 3/64"	6'-5 3/64"	6'-5 3/64"	8'-1 3/64"	8'-1 3/64"
G.S.	14 5/8"	14 5/8"	14 5/8" 36 5/8" 14 5/8"	14 5/8"	14 5/8" 54 5/8" 14 5/8"
3'-0" 3'-0 1/2" 30 5/8"					
3'-6" 3'-6 1/2" 36 5/8"					
4'-0" 4'-0 1/2" 42 5/8"					
4'-6" 4'-6 1/2" 48 5/8"					
5'-0" 5'-0 1/2" 54 5/8"					
5'-6" 5'-6 1/2" 60 5/8"					
6'-0" 6'-0 1/2" 66 5/8"					

U.D. = Unit Dimension • R.O. = Rough Opening • G.S. = Glass Size (Glass sizes are shown per sash)

NOTE: All measurements are nominal. Elevation charts are not to scale. Divided lites are optional.

If the cable support system and/or insulated platforms and support brackets are not being used, other means of proper support must be used.

Add 1-11/16" to the rough opening height if an insulated platform is being used. Rough openings for bay units without head and seat boards, typically used for walk-out applications, are different.

Some installation procedures will require a larger rough opening than noted (i.e. installations utilizing our installation clips), therefore, you may need to increase the rough opening size accordingly. Rough opening gaps may be increased up to a maximum of 1/2" on all sides and still be within good practice guidelines. For rough opening recommendations, see pg. 216.

Additional and the most current drawings are available at www.kolbewindows.com.

Casements | Elevation Charts

Casements | "W" Series 45° Bay Windows

UNIT PROJECTION: 14 13/32"

	5'-9 17/32" 5'-7 31/32" 18 5/8"	7'-9 17/32" 7'-7 31/32" 18 5/8"	7'-9 17/32" 7'-7 31/32" 18 5/8" 42 5/8" 18 5/8"	9'-9 17/32" 9'-7 31/32" 18 5/8"	9'-9 17/32" 9'-7 31/32" 18 5/8" 66 5/8" 18 5/8"
3'-0" 3'-0 1/2" 30 5/8"					
3'-6" 3'-6 1/2" 36 5/8"					
4'-0" 4'-0 1/2" 42 5/8"					
4'-6" 4'-6 1/2" 48 5/8"					
5'-0" 5'-0 1/2" 54 5/8"					
5'-6" 5'-6 1/2" 60 5/8"					
6'-0" 6'-0 1/2" 66 5/8"					

U.D. = Unit Dimension • R.O. = Rough Opening • G.S. = Glass Size (Glass sizes are shown per sash)

NOTE: All measurements are nominal. Elevation charts are not to scale. Divided lites are optional.

If the cable support system and/or insulated platforms and support brackets are not being used, other means of proper support must be used.









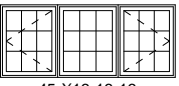
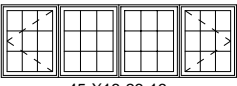

Add 1-11/16" to the rough opening height if an insulated platform is being used. Rough openings for bay units without head and seat boards, typically used for walk-out applications, are different.

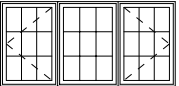
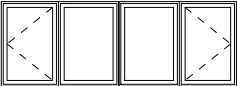
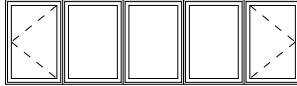
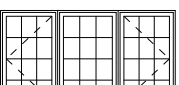
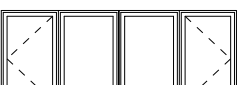
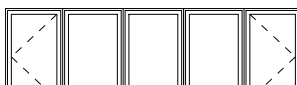
Some installation procedures will require a larger rough opening than noted (i.e. installations utilizing our installation clips), therefore, you may need to increase the rough opening size accordingly. Rough opening gaps may be increased up to a maximum of 1/2" on all sides and still be within good practice guidelines. For rough opening recommendations, see pg. 216.

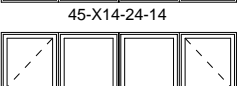
Additional and the most current drawings are available at www.kolbewindows.com.

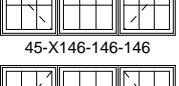
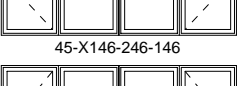
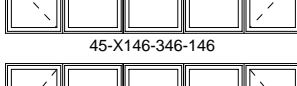
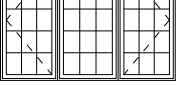
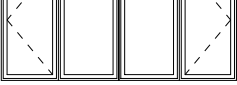
Casements | "X" Series 45° Bay Windows

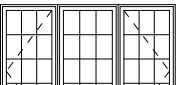
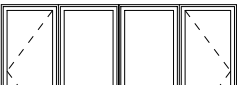
UNIT PROJECTION: 17 13/32"

	7'-1 59/64"	9'-7 59/64"	12'-1 59/64"
U.D.			
R.O.	7'-0 23/64"	9'-6 23/64"	12'-0 23/64"
G.S.	24 5/8"	24 5/8"	24 5/8"
3'-0" 3'-0 1/2" 30 5/8"	 45-X13-13-13	 45-X13-23-13	 45-X13-33-13
3'-6" 3'-5 1/2" 36 5/8"	 45-X136-136-136	 45-X136-236-136	 45-X136-336-136
4'-0" 4'-0 1/2" 42 5/8"	 45-X14-14-14	 45-X14-24-14	 45-X14-34-14
4'-6" 4'-5 1/2" 48 5/8"	 45-X146-146-146	 45-X146-246-146	 45-X146-346-146
5'-0" 5'-0 1/2" 54 5/8"	 45-X15-15-15	 45-X15-25-15	 45-X15-35-15
5'-6" 5'-5 1/2" 60 5/8"	 45-X156-156-156	 45-X156-256-156	 45-X156-356-156
6'-0" 6'-0 1/2" 66 5/8"	 45-X16-16-16	 45-X16-26-16	 45-X16-36-16

U.D. = Unit Dimension • R.O. = Rough Opening • G.S. = Glass Size (Glass sizes are shown per sash)

NOTE: All measurements are nominal. Elevation charts are not to scale. Divided lites are optional.

If the cable support system and/or insulated platforms and support brackets are not being used, other means of proper support must be used.

Add 1-11/16" to the rough opening height if an insulated platform is being used. Rough openings for bay units without head and seat boards, typically used for walk-out applications, are different.

Some installation procedures will require a larger rough opening than noted (i.e. installations utilizing our installation clips), therefore, you may need to increase the rough opening size accordingly. Rough opening gaps may be increased up to a maximum of 1/2" on all sides and still be within good practice guidelines. For rough opening recommendations, see pg. 216.

Additional and the most current drawings are available at www.kolbewindows.com.

Casements | Elevation Charts

Casements | 90° Bay Windows

UNIT PROJECTION: 22 51/64"

	UNIT PROJECTION: 22 51/64"			
U.D.	4'-8 7/64"	4'-8 7/64"	6'-8 7/64"	6'-8 7/64"
R.O.	4'-0 1/2"	4'-0 1/2"	6'-0 1/2"	6'-0 1/2"
G.S.	18 5/8"	42 5/8"	18 5/8"	66 5/8"
3'-0"				
3'-0 1/2"	S13-W23-S13	S13-W23P-S13	S13-W33-S13	S13-W33P-S13
3'-6"				
3'-6 1/2"	S136-W236-S136	S136-W236P-S136	S136-W336-S136	S136-W336P-S136
4'-0"				
4'-0 1/2"	S14-W24-S14	S14-W24P-S14	S14-W34-S14	S14-W34P-S14
4'-6"				
4'-6 1/2"	S146-W246-S146	S146-W246P-S146	S146-W346-S146	S146-W346P-S146
5'-0"				
5'-0 1/2"	S15-W25-S15	S15-W25P-S15	S15-W35-S15	S15-W35P-S15
5'-6"				
5'-6 1/2"	S156-W256-S156	S156-W256P-S156	S156-W356-S156	S156-W356P-S156
6'-0"				
6'-0 1/2"	S16-W26-S16	S16-W26P-S16	S16-W36-S16	S16-W36P-S16

U.D. = Unit Dimension • R.O. = Rough Opening • G.S. = Glass Size (Glass sizes are shown per sash)























































NOTE: All measurements are nominal. Elevation charts are not to scale. Only flanker sash vent on 90° bay windows. Divided lites are optional.

If the cable support system and/or insulated platforms and support brackets are not being used, other means of proper support must be used. Add 1-11/16" to the rough opening height if an insulated platform is being used. Rough openings for bay units without head and seat boards, typically used for walk-out applications, are different.

Some installation procedures will require a larger rough opening than noted (i.e. installations utilizing our installation clips), therefore, you may need to increase the rough opening size accordingly. Rough opening gaps may be increased up to a maximum of 1/2" on all sides and still be within good practice guidelines. For rough opening recommendations, see pg. 216.

Additional and the most current drawings are available at www.kolbewindows.com.

Segment Head Casements | Single Units

F.S.	1'-4"	1'-8"	2'-0"	2'-4"	2'-6"	2'-8"	3'-0"
R.O.	1'-4 1/2"	1'-8 1/2"	2'-0 1/2"	2'-4 1/2"	2'-6 1/2"	2'-8 1/2"	3'-0 1/2"
G.S.*	10 5/8"	14 5/8"	18 5/8"	22 5/8"	24 5/8"	26 5/8"	30 5/8"
G.S.**	9 7/8"	13 7/8"	17 7/8"	21 7/8"	23 7/8"	25 7/8"	29 7/8"
2'-6"							
3'-0"							
3'-6"							
4'-0"							
4'-6"							
5'-0"							
5'-6"							
6'-0"							
	S16-SEG	N16-SEG	W16-SEG	L16-SEG	X16-SEG***	C16-SEG***	E16-SEG***

* Approximate glass sizes per sash are given; true glass sizes vary depending on the radius involved.

** Glass size for push-out casements.

*** Units meet most national escape and rescue requirements.

† Push-out units only available with single-point hardware.

F.S. = Frame Size • R.O. = Rough Opening • G.S. = Glass Size

NOTE: All measurements are nominal. Elevation charts are not to scale. For push-out casements, have dealer specify push-out when placing order for unit. Divided lites are optional.

Specify stationary, left or right venting when ordering single units. Venting is viewed from the exterior.

Some installation procedures will require a larger rough opening than noted (i.e. installations utilizing our installation clips), therefore, you may need to increase the rough opening size accordingly. Rough opening gaps may be increased up to a maximum of 1/2" on all sides and still be within good practice guidelines. For rough opening recommendations, see pg. 216.

Additional and the most current drawings are available at www.kolbwindows.com.

Casements | Elevation Charts

Segment Head Casements "S" Series

F.S.	1'-4"	2'-8"	4'-0"
R.O.	1'-4 1/2"	2'-8 1/2"	4'-0 1/2"
G.S.*	10 5/8"	10 5/8"	10 5/8"
G.S.**	9 7/8"	9 7/8"	9 7/8"
2'-6"			
3'-0"			
3'-6"			
4'-0"			
4'-6"			
5'-0"			
5'-6"			
6'-0"			

Segment Head Casements "N" Series

F.S.	1'-8"	3'-4"	5'-0"
R.O.	1'-8 1/2"	3'-4 1/2"	5'-0 1/2"
G.S.*	14 5/8"	14 5/8"	14 5/8"
G.S.**	13 7/8"	13 7/8"	13 7/8"
2'-6"			
3'-0"			
3'-6"			
4'-0"			
4'-6"			
5'-0"			
5'-6"			
6'-0"			

* Approximate glass sizes per sash are given; true glass sizes vary depending on the radius involved

** Glass size for push-out casements

† Push-out units only available with single-point hardware

F.S. = Frame Size • R.O. = Rough Opening • G.S. = Glass Size (Glass sizes are shown per sash)

NOTE: All measurements are nominal. Elevation charts are not to scale. Only flanker sash vent on 90° bay windows. Divided lites are optional.

Some installation procedures will require a larger rough opening than noted (i.e. installations utilizing our installation clips), therefore, you may need to increase the rough opening size accordingly. Rough opening gaps may be increased up to a maximum of 1/2" on all sides and still be within good practice guidelines. For rough opening recommendations, see pg. 216.

Additional and the most current drawings are available at www.kolbewindows.com.

Segment Head Casements "W" Series

F.S.	2'-0"	4'-0"	6'-0"
R.O.	2'-0 1/2"	4'-0 1/2"	6'-0 1/2"
G.S.*	18 5/8"	18 5/8"	18 5/8"
G.S.**	17 7/8"	17 7/8"	17 7/8"
2'-6"			
3'-0"			
3'-6"			
4'-0"			
4'-6"			
5'-0"			
5'-6"			
6'-0"			

Segment Head Casements "L" Series

F.S.	2'-4"	4'-8"	7'-0"
R.O.	2'-4 1/2"	4'-8 1/2"	7'-0 1/2"
G.S.*	22 5/8"	22 5/8"	22 5/8"
G.S.**	21 7/8"	21 7/8"	21 7/8"
2'-6"			
3'-0"			
3'-6"			
4'-0"			
4'-6"			
5'-0"			
5'-6"			
6'-0"			

* Approximate glass sizes per sash are given; true glass sizes vary depending on the radius involved

** Glass size for push-out casements

† Push-out units only available with single-point hardware

F.S. = Frame Size • R.O. = Rough Opening • G.S. = Glass Size (Glass sizes are shown per sash)

NOTE: All measurements are nominal. Elevation charts are not to scale. For push-out casements, have dealer specify push-out when placing order for unit. Divided lites are optional.

Specify stationary, left or right venting when ordering single units. Venting is viewed from the exterior.

Some installation procedures will require a larger rough opening than noted (i.e. installations utilizing our installation clips), therefore, you may need to increase the rough opening size accordingly. Rough opening gaps may be increased up to a maximum of 1/2" on all sides and still be within good practice guidelines. For rough opening recommendations, see pg. 216.

Additional and the most current drawings are available at www.kolbwindows.com.

Casements | Elevation Charts

Segment Head Casements "X" Series

F.S.	2'-6"	5'-0"	7'-6"
R.O.	2'-6 1/2"	5'-0 1/2"	7'-6 1/2"
G.S.*	24 5/8"	24 5/8"	24 5/8"
G.S.**	23 7/8"	23 7/8"	23 7/8"
2'-6"			
3'-0"			
3'-6"			
4'-0"			
4'-6"			
5'-0"			
5'-6"			
6'-0"			

Segment Head Casements "C" Series

F.S.	2'-8"	5'-4"	8'-0"
R.O.	2'-8 1/2"	5'-4 1/2"	8'-0 1/2"
G.S.*	26 5/8"	26 5/8"	26 5/8"
G.S.**	25 7/8"	25 7/8"	25 7/8"
2'-6"			
3'-0"			
3'-6"			
4'-0"			
4'-6"			
5'-0"			
5'-6"			
6'-0"			

* Approximate glass sizes per sash are given; true glass sizes vary depending on the radius involved

** Glass size for push-out casements

† Push-out units only available with single-point hardware

F.S. = Frame Size • R.O. = Rough Opening • G.S. = Glass Size (Glass sizes are shown per sash)











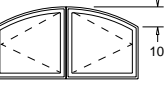
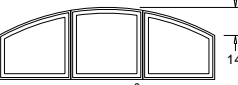

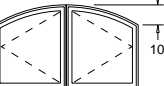
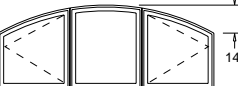

NOTE: All measurements are nominal. Elevation charts are not to scale. For push-out casements, have dealer specify push-out when placing order for unit. Divided lites are optional.

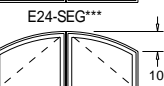
Specify stationary, left or right venting when ordering single units. Venting is viewed from the exterior.

Some installation procedures will require a larger rough opening than noted (i.e. installations utilizing our installation clips), therefore, you may need to increase the rough opening size accordingly. Rough opening gaps may be increased up to a maximum of 1/2" on all sides and still be within good practice guidelines. For rough opening recommendations, see pg. 216.

Additional and the most current drawings are available at www.kolbewindows.com.

Segment Head Casements “E” Series

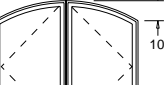
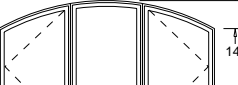
F.S.	3'-0"	6'-0"	9'-0"
R.O.	3'-0 1/2"	6'-0 1/2"	9'-0 1/2"
G.S.*	30 5/8"	30 5/8"	30 5/8"
G.S.**	29 7/8"	29 7/8"	29 7/8"
3'-0"			
3'-6"			
4'-0"			
4'-6"			
5'-0"			
5'-6"			
6'-0"			

* Approximate glass sizes per sash are given; true glass sizes vary depending on the radius involved

** Glass size for push-out casements

*** Units meet most national escape and rescue requirements

† Push-out units only available with single-point hardware

§ Only available as stationary units

F.S. = Frame Size • R.O. = Rough Opening • G.S. = Glass Size (Glass sizes are shown per sash)

NOTE: All measurements are nominal. Elevation charts are not to scale. For push-out casements, have dealer specify push-out when placing order for unit. Divided lites are optional.

Specify stationary, left or right venting when ordering single units. Venting is viewed from the exterior.

Some installation procedures will require a larger rough opening than noted (i.e. installations utilizing our installation clips), therefore, you may need to increase the rough opening size accordingly. Rough opening gaps may be increased up to a maximum of 1/2" on all sides and still be within good practice guidelines. For rough opening recommendations, see pg. 216.

Additional and the most current drawings are available at www.kolbwindows.com.

Casements | Elevation Charts

Segment Head Casements | Picture Units

F.S.	3'-4"	4'-0"	4'-6"	5'-0"	6'-0"
R.O.	3'-4 1/2"	4'-0 1/2"	4'-6 1/2"	5'-0 1/2"	6'-0 1/2"
G.S.*	34 5/8"	42 5/8"	50 5/8"	54 5/8"	66 5/8"
G.S.**	33 7/8"	41 7/8"	49 7/8"	53 7/8"	65 7/8"
1'-4"	N214P-SEG	W214P-SEG	4614P-SEG	N314P-SEG	W314P-SEG
1'-8"	N218P-SEG	W218P-SEG	4618P-SEG	N318P-SEG	W318P-SEG
2'-0"	N22P-SEG	W22P-SEG	4620P-SEG	N32P-SEG	W32P-SEG
2'-6"	N226P-SEG	W226P-SEG	4626P-SEG	N326P-SEG	W326P-SEG
3'-0"	N23P-SEG	W23P-SEG	4630P-SEG	N33P-SEG	W33P-SEG
3'-6 1/2"	N236P-SEG	W236P-SEG	4636P-SEG	N336P-SEG	W336P-SEG
4'-0"	N24P-SEG	W24P-SEG	4640P-SEG	N34P-SEG	W34P-SEG
4'-6 1/2"	N246P-SEG	W246P-SEG	4646P-SEG	N346P-SEG	W346P-SEG
5'-0"	N25P-SEG	W25P-SEG	4650P-SEG	N35P-SEG	W35P-SEG
5'-6 1/2"	N256P-SEG	W256P-SEG	4656P-SEG	N356P-SEG	W356P-SEG
6'-0"	N26P-SEG	W26P-SEG	4660P-SEG	N36P-SEG	W36P-SEG

* Approximate glass sizes are given; true glass sizes vary depending on the radius involved

** Glass size for units to match operating push-out casements

















































F.S. = Frame Size • R.O. = Rough Opening • G.S. = Glass Size

NOTE: All measurements are nominal. Elevation charts are not to scale. Divided lites are optional.

Some installation procedures will require a larger rough opening than noted (i.e. installations utilizing our installation clips), therefore, you may need to increase the rough opening size accordingly. Rough opening gaps may be increased up to a maximum of 1/2" on all sides and still be within good practice guidelines. For rough opening recommendations, see pg. 216.

Additional and the most current drawings are available at www.kolbewindows.com.

Half-Circle Top Casements

F.S.	1'-8"	2'-0"	2'-4"	2'-6"	2'-8"	3'-0"
R.O.	1'-8 1/2"	2'-0 1/2"	2'-4 1/2"	2'-6 1/2"	2'-8 1/2"	3'-0 1/2"
G.S.*	14 5/8"	18 5/8"	22 5/8"	24 5/8"	26 5/8"	30 5/8"
G.S.**	13 7/8"	17 7/8"	21 7/8"	23 7/8"	25 7/8"	29 7/8"
2'-6"						
	N126-HC†	W126-HC†	L126-HC†	X126-HC†	C126-HC†	E126-HC†
3'-0"						
	N13-HC	W13-HC	L13-HC	X13-HC	C13-HC	E13-HC
3'-6"						
	N136-HC	W136-HC	L136-HC	X136-HC	C136-HC	E136-HC
4'-0"						
	N14-HC	W14-HC	L14-HC	X14-HC***	C14-HC***	E14-HC***
4'-6"						
	N146-HC	W146-HC	L146-HC	X146-HC***	C146-HC***	E146-HC***
5'-0"						
	N15-HC	W15-HC	L15-HC	X15-HC***	C15-HC***	E15-HC***
5'-6"						
	N156-HC	W156-HC	L156-HC	X156-HC***	C156-HC***	E156-HC***
6'-0"						
	N16-HC	W16-HC	L16-HC	X16-HC***	C16-HC***	E16-HC***

* Approximate glass sizes are given; true glass sizes vary depending on the radius involved

** Glass size for push-out casements

*** Units meet most national escape and rescue requirements when ordered as venting units

† Push-out units only available with single-point hardware

F.S. = Frame Size • R.O. = Rough Opening • G.S. = Glass Size

NOTE: All measurements are nominal. Elevation charts are not to scale. Divided lites are optional.

Units are stationary as standard, however, some may be ordered as venting units. Contact your local dealer for details.

Some installation procedures will require a larger rough opening than noted (i.e. installations utilizing our installation clips), therefore, you may need to increase the rough opening size accordingly. Rough opening gaps may be increased up to a maximum of 1/2" on all sides and still be within good practice guidelines. For rough opening recommendations, see pg. 216.

Additional and the most current drawings are available at www.kolbwindows.com.

Casements | Cross Section Drawings

Crank-Out Casements

Horizontal Section

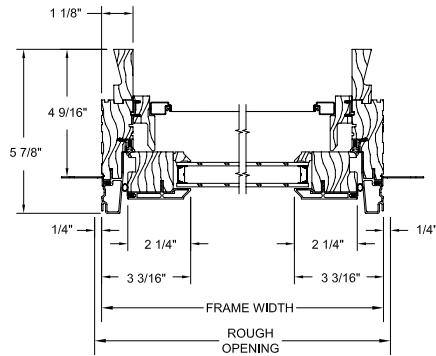

Vertical Section

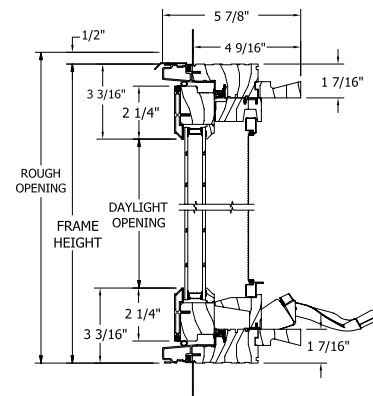

Crank-Out Casements with 1-15/16" Brickmould & 6-9/16" Jamb

Horizontal Section

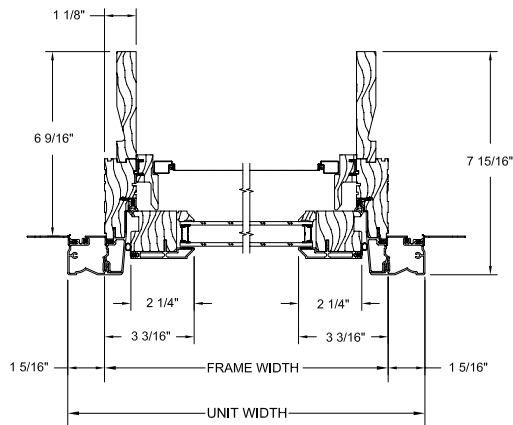

Vertical Section

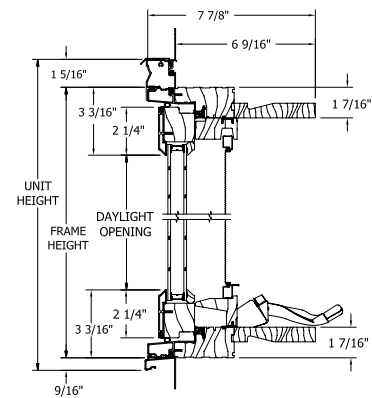

Crank-Out Casements

Standard Mullion

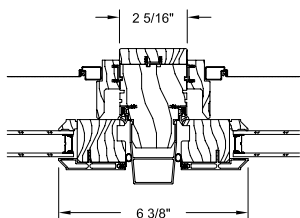

Narrow Mullion

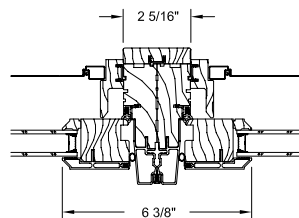

Transom Stacked Over Casement

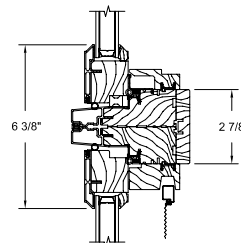

French Casement Meeting Stiles

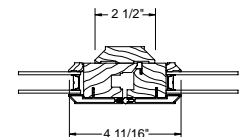

NOTE: Drawings are not to scale. Brickmould is shown factory-applied. Brickmould may be shipped loose for field application. Some units are shown with optional drip cap or nailing fin. For Ultra accessory or application drawings, see pgs. 206-212. Additional and the most current drawings are available at www.kolbewindows.com.

Crank-Out XL Casements | Double Pane

Horizontal Section

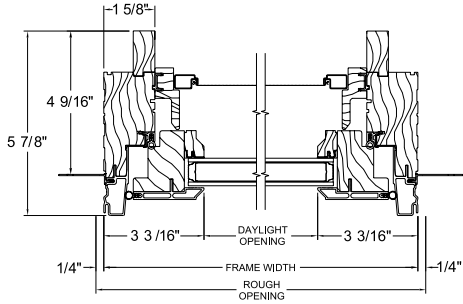

Vertical Section

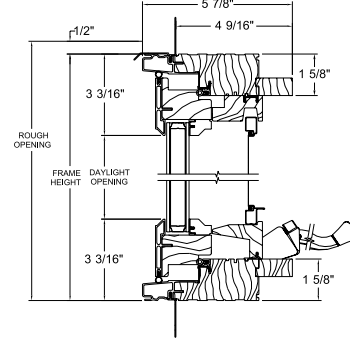

Crank-Out XL Casements with 4-9/16\" Jamb | Triple Pane

Horizontal Section

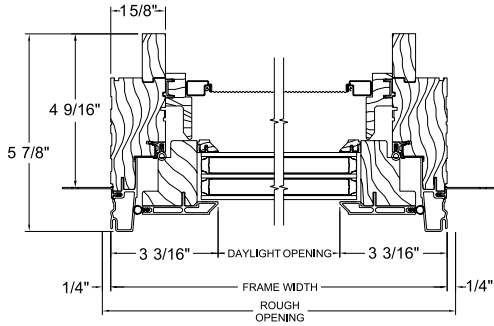

Vertical Section

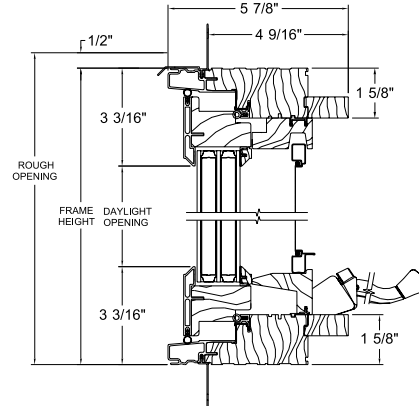

NOTE: Drawings are not to scale. Brickmould is shown factory-applied. Brickmould may be shipped loose for field application. Some units are shown with optional drip cap or nailing fin. For Ultra accessory or application drawings, see pgs. 206-212. Additional and the most current drawings are available at www.kolbewindows.com.

Casements | Cross Section Drawings

Push-Out Casements

Horizontal Section – single-point lock

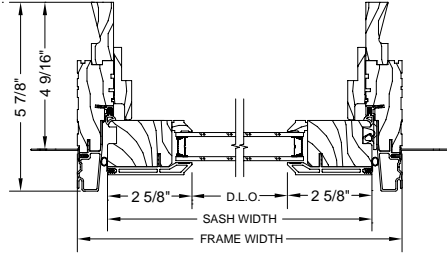

Horizontal Section – multi-point lock

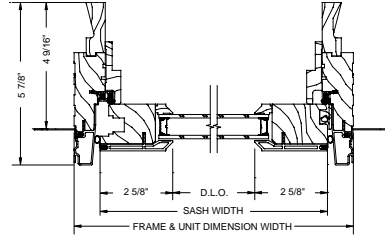

Vertical Section

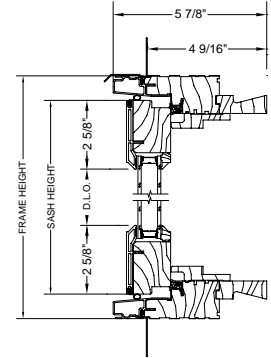

Push-Out Casements | Swinging Screen

Horizontal Section – single-point lock

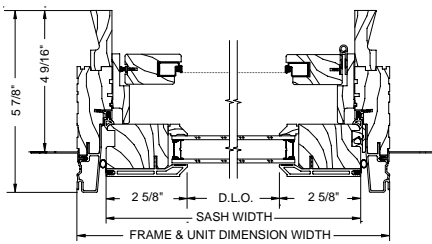

Horizontal Section – multi-point lock

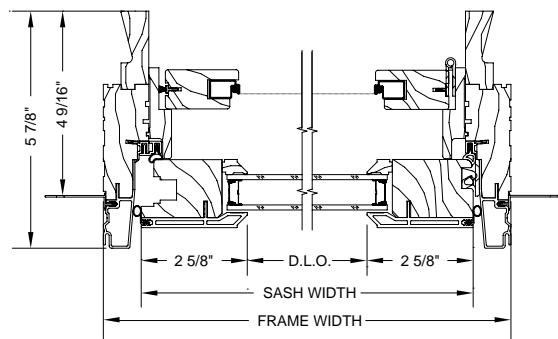

Vertical Section

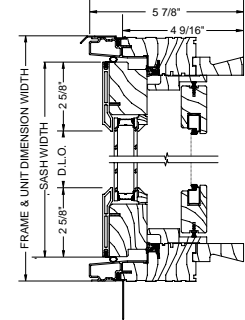

Push-Out Casements | Retractable Screen

Horizontal Section – single-point lock

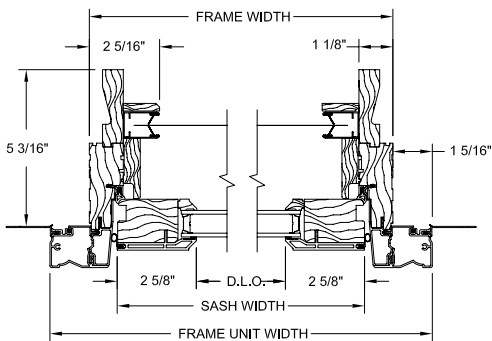

Horizontal Section – multi-point lock

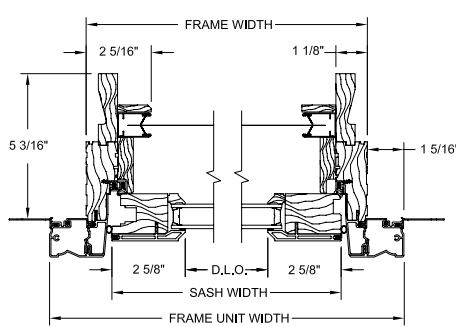

Vertical Section

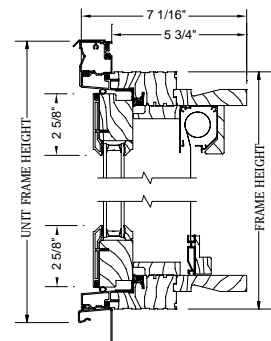

NOTE: Drawings are not to scale. Brickmould is shown factory-applied. Brickmould may be shipped loose for field application. Some units are shown with optional drip cap or nailing fin. For Ultra accessory or application drawings, see pgs. 206-212. Additional and the most current drawings are available at www.kolbewindows.com.

Push-Out Casements

Standard Mullion

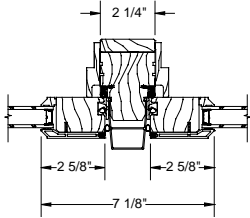

Narrow Mullion

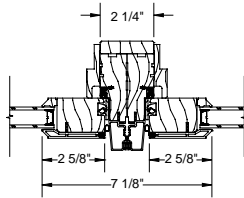

French Push-Out Casements

Horizontal Section

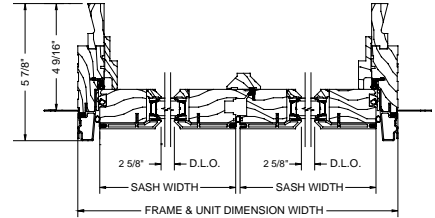

Transom Stacked Over Push-Out Casements

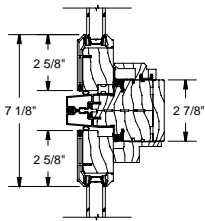

Push-Out EP Casements | Swinging Screen

Horizontal Section – multi-point lock

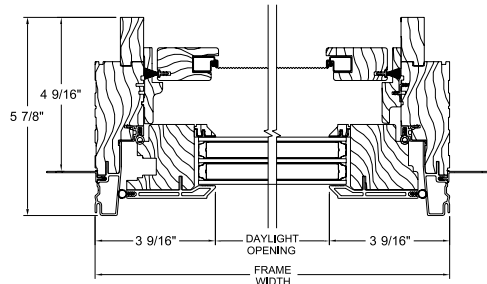

Vertical Section multi- or single-point lock

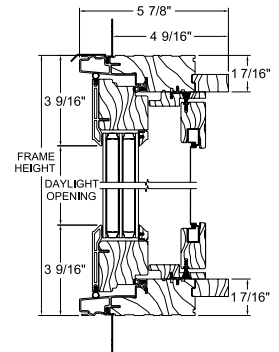

Push-Out EP Casements | Retractable Screen

Horizontal Section – multi-point lock

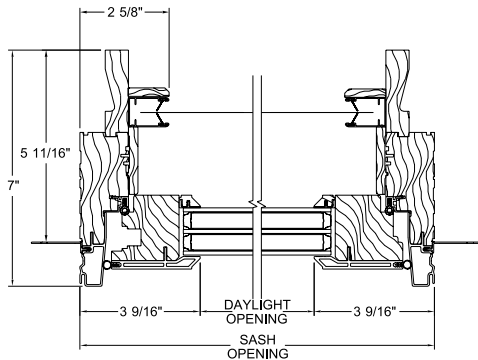

Vertical Section multi- or single-point lock

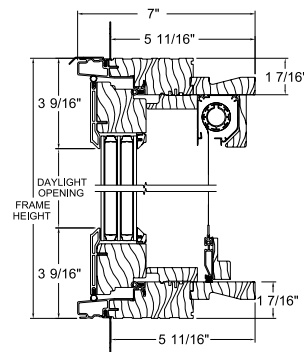

NOTE: Drawings are not to scale. Brickmould is shown factory-applied. Brickmould may be shipped loose for field application. Some units are shown with optional drip cap or nailing fin. For Ultra accessory or application drawings, see pgs. 206-212. Additional and the most current drawings are available at www.kolbewindows.com.

Casements | Cross Section Drawings

Casement Bows & Bays

Bow Horizontal Section

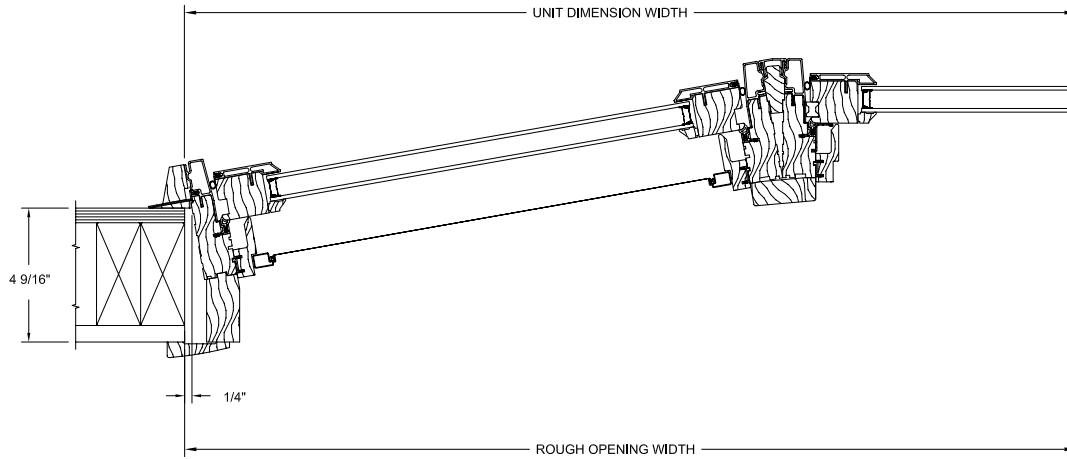

Bow & Bay Vertical Section

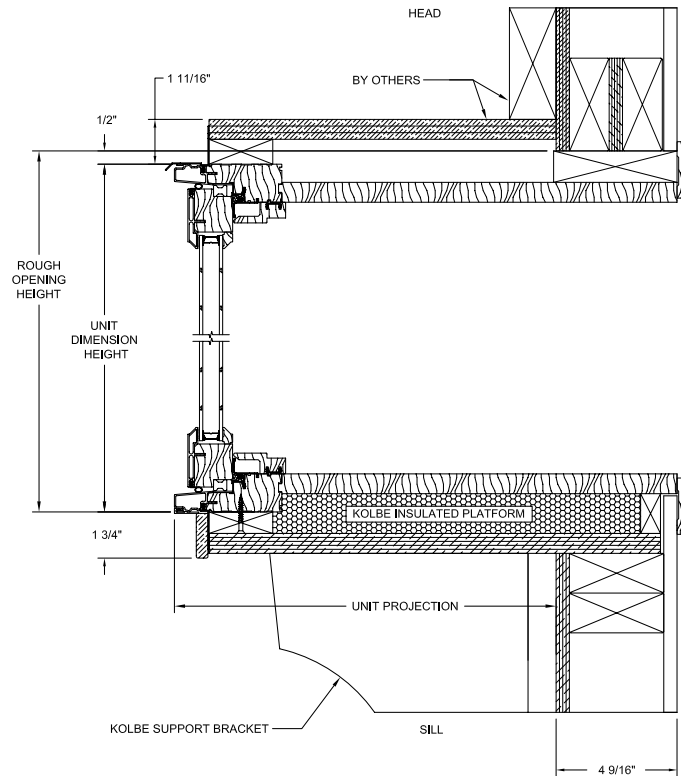

NOTE: Drawings are not to scale. Bows and bays are only available as crank-out casements, not push-out casements. Additional and the most current drawings are available at www.kolbewindows.com.

Casement Bows & Bays

30° Bay Horizontal Section

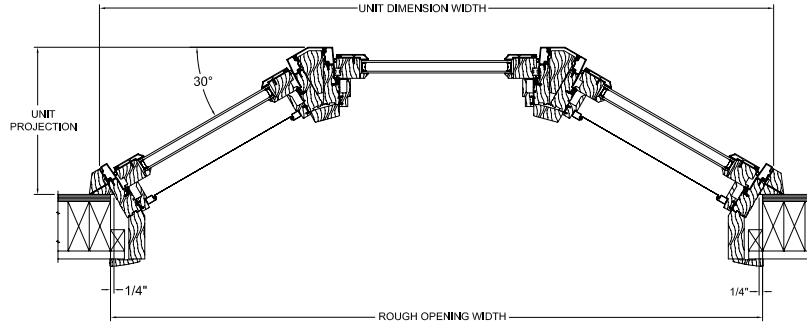

45° Bay Horizontal Section

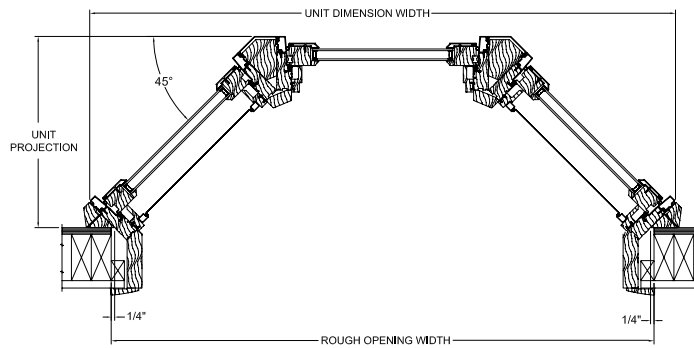

90° Bay Horizontal Section

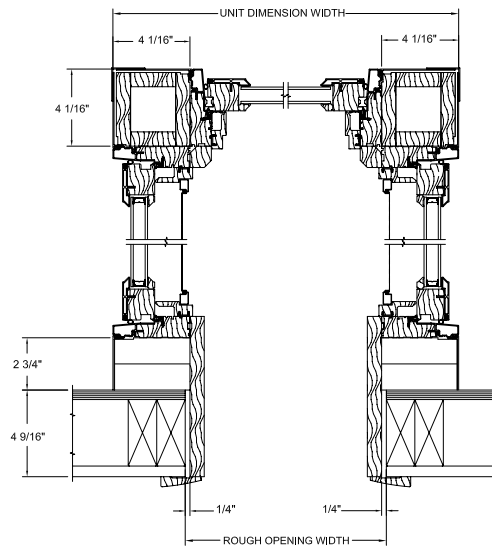

NOTE: Drawings are not to scale. Bows and bays are only available as crank-out casements, not push-out casements. Additional and the most current drawings are available at www.kolbwindows.com.





Awnings

Ultra Series awning windows open outward from the bottom, so they are fully functional even when there is a gentle rain outside. Awnings offer unique style to any room and are the perfect complement to other Kolbe windows and doors. Nesting handles and dual-arm operators make these windows easy to operate.

*Crank-Out Awnings | Crank-Out XL Awnings | Push-Out & Push-Out EP Awnings
Picture Units | Picture Combination Units | Muller Configurations*

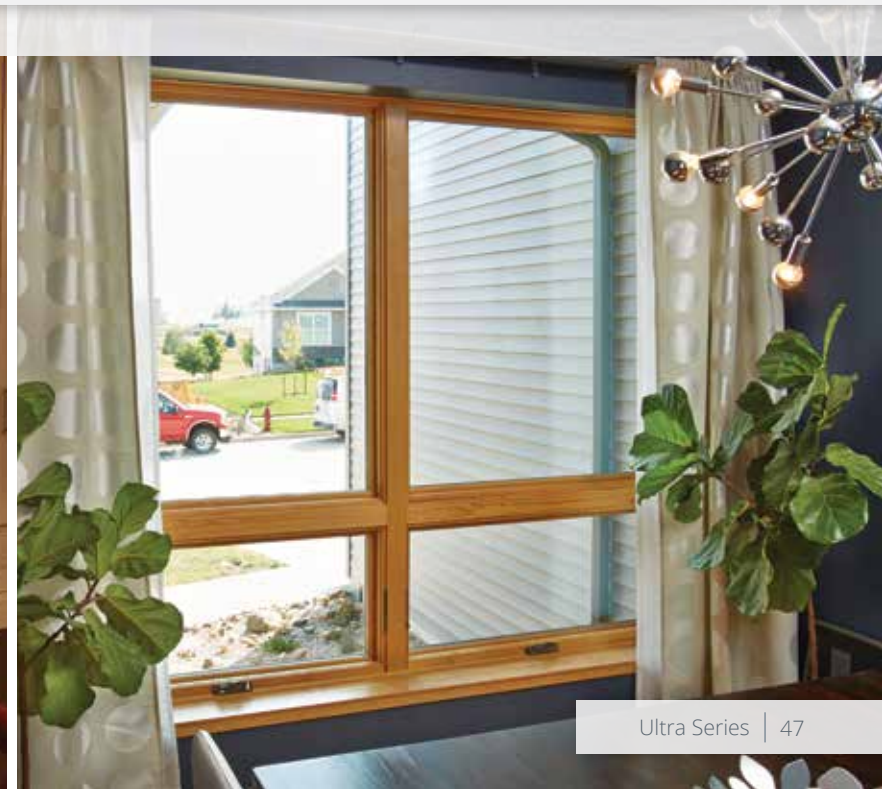

Crank-Out Awnings

Crank-out awnings open outward from the bottom with a crank handle that folds down when not in use. Choose motorized operators for an effortless way to open and close your window, especially when it's in a hard-to-reach place.



Crank-Out Awning Standard Features

- ▶ 1-3/4" thick sash
- ▶ Overall jamb width is 4-9/16" (*basic box width is 2-3/4"*)
- ▶ Constructed of pine, with pine interior stops and wood mull casings on mull units
- ▶ Exterior wood parts are treated
- ▶ Extruded aluminum exterior finished with a 70% PVDF fluoropolymer coating (*meets performance requirements of AAMA 2605*)
- ▶ Accessory grooves are integral to the extruded frames for the easy addition of accessories
- ▶ Energy efficient, insulating Solar Low-E glass
- ▶ Glazed to the interior with beveled wood glazing beads
- ▶ Interior insect screen with Clay-colored aluminum frame and BetterVue® fiberglass mesh
- ▶ Clay-colored nesting handle and locking lever† with multi-point locking system
- ▶ Corrosion resistant, dual-arm operators with concealed, adjustable hinges
- ▶ Heavy vinyl nailing fins with head drip caps*

NOTE: All measurements are nominal.

†Locking levers are not available on units with a box size smaller than 1' 4".

* Standard only on units without brickmould.

Hardware

- ▶ Nesting handle and locking lever† provide a sleek look and are unobtrusive. Available in Clay, White, Beige, Bright Brass, Antique Brass, Satin Nickel, Antique Nickel, Rustic Umber, Oil-Rubbed** or Matte Black.
- ▶ Metal Ashlar handle with multi-point locking lever. Available in White, Rustic Umber, Satin Nickel or Matte Black.
- ▶ Nesting handle with custodial lock prohibits unauthorized operation. Available in White, Beige, Rustic Umber or Matte Black.
- ▶ Universal design casement handle and lock are larger and offer ease-of-use for people with physical limitations. Available in White or Clay.

†Locking lever is not available on units with a box size smaller than 1' 4".

**The Oil-Rubbed finish is a living finish, which means that it will change appearance over time with use.

Nesting Handle
(shown in Antique Brass)



Ashlar Handle
(shown in Satin Nickel)



Locking Lever†
(shown in Antique Nickel)



Nesting Handle with Custodial Lock (shown in Matte Black)





Crank-Out Awning Options

Glass (pg. 200)

- ▶ Solar Gain Low-E
- ▶ Solar Advanced Control Low-E
- ▶ Solar Control Low-E
- ▶ ThermaPlus™ Low-E
- ▶ Neat®
- ▶ Patterned-, bronze-, or gray-lite
- ▶ Tempered or laminated
- ▶ Other options standard to the industry

Divided Lites (pg. 201)

- ▶ Performance divided lites with 5/8", 7/8", 1-1/8", 1-3/8", 1-3/4", 2-1/4" or 4-1/2" bars
- ▶ Grilles-in-the-air-space

Insect Screens

- ▶ Insect screen with aluminum or UltraVue® fiberglass mesh; frame available in White, Beige, Dark Bronze anodized, Clear anodized, or Coal Black
- ▶ Retractable insect screen kit with beveled or square cover (pg. 204)
- ▶ Wood wrapped insect screen frame
- ▶ Brass insect screen with Brass frame

NOTE: All measurements are nominal.

- ▶ **Other Options** (custom options are also available)
- ▶ Other wood species and FSC®-certified wood (pg. 198)
- ▶ Interior prefinishing (pg. 198)
- ▶ Interior casing
- ▶ Ovolo or square profile glazing beads and interior divided lite bars (pg. 201)
- ▶ Prep for stool
- ▶ Extruded aluminum accessories applied to accessory grooves on the exterior frame (pgs. 206-212)
- ▶ Ashlar handle in Satin Nickel, White, Rustic Umber or Matte Black
- ▶ Motorized operator
- ▶ Stainless steel exterior operator parts
- ▶ Extension jambs (up to 12" applied, over 12" shipped loose for field application)
- ▶ Galvanized steel installation clips
- ▶ High performance or impact performance modifications (pg. 205)

Universal Design Handle (shown in Clay)

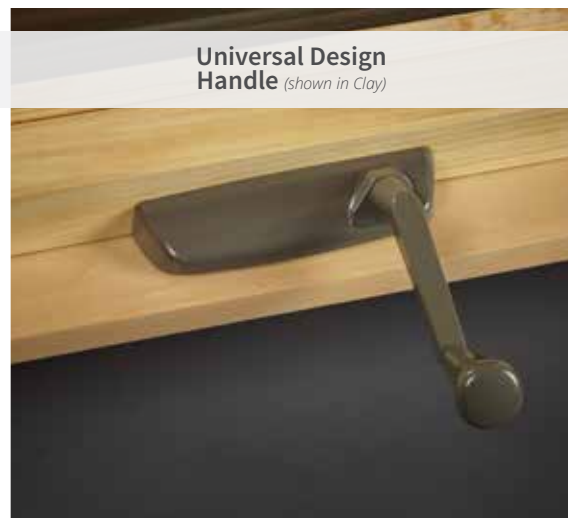

Crank-Out XL Awnings

Kolbe's Ultra Series crank-out XL awnings take operational windows to new heights. Available up to 5-feet-wide by 7-feet-tall, this product meets the demand for extremely large venting units. With their heavy-duty hardware, crank-out XL awnings operate smoothly despite their large size.

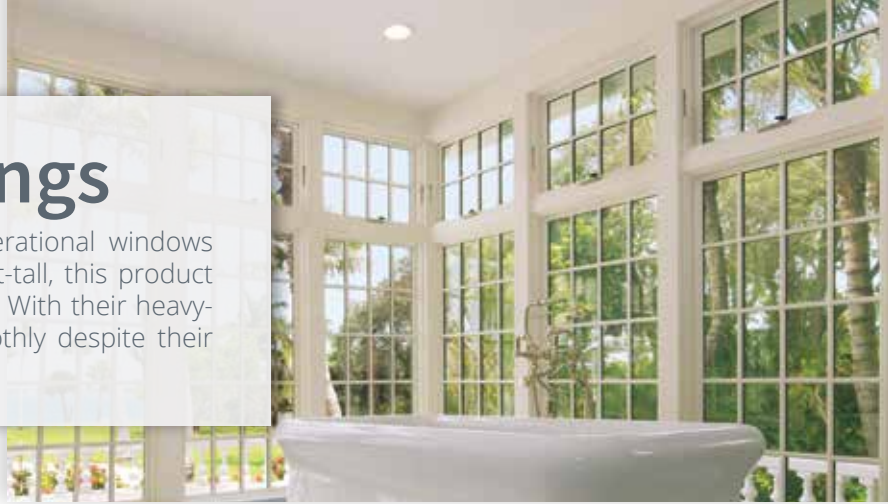

Crank-Out XL Awning Standard Features

- ▶ 2-1/4" thick sash
- ▶ Overall jamb width is 4-9/16" (*basic box width is 3-1/4"*)
- ▶ Constructed of pine, with pine interior stops and wood mull casings on mull units
- ▶ Exterior wood parts are treated
- ▶ Extruded aluminum exterior finished with a 70% PVDF fluoropolymer coating (*meets performance requirements of AAMA 2605*)
- ▶ Accessory grooves are integral to the extruded frames for the easy addition of accessories
- ▶ Energy efficient, insulating Solar Low-E glass
- ▶ Glazed to the interior with beveled wood glazing beads
- ▶ Interior insect screen with Clay-colored aluminum frame and BetterVue® fiberglass mesh
- ▶ Clay-colored nesting handle and locking levers with multi-point locking system
- ▶ Corrosion resistant, dual-arm operators with concealed adjustable hinges
- ▶ Specially-engineered hardware designed to accommodate the additional sash weight
- ▶ Heavy vinyl nailing fins with head drip caps*

NOTE: All measurements are nominal.

* Standard only on units without brickmould.

Hardware

- ▶ Nesting handle and locking lever† provide a sleek look and are unobtrusive. Available in Clay, White, Beige, Bright Brass, Antique Brass, Satin Nickel, Antique Nickel, Rustic Umber, Oil-Rubbed** or Matte Black.
- ▶ Metal Ashlar handle with multi-point locking lever. Available in White, Rustic Umber, Satin Nickel or Matte Black.
- ▶ Nesting handle with custodial lock prohibits unauthorized operation. Available in White, Beige, Rustic Umber or Matte Black.
- ▶ Universal design casement handle and lock are larger and offer ease-of-use for people with physical limitations. Available in White or Clay.

**The Oil-Rubbed finish is a living finish, which means that it will change appearance over time with use.

Nesting Handle
(shown in Antique Brass)

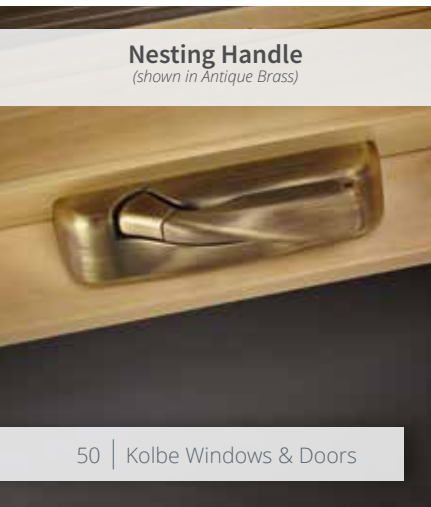

Ashlar Handle
(shown in Satin Nickel)

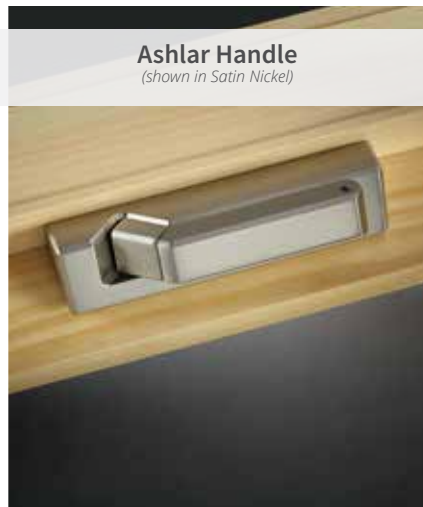

Locking Lever†
(shown in Antique Nickel)

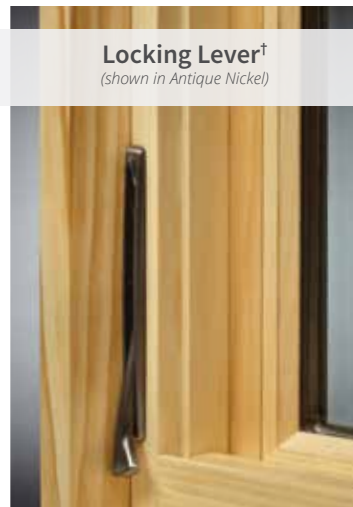

Nesting Handle with Custodial Lock
(shown in Matte Black)

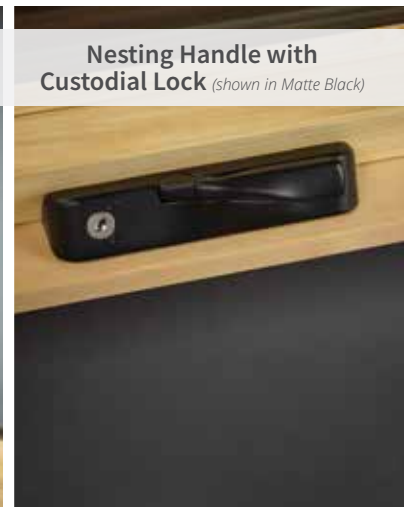



Crank-Out XL Awning Options

Glass *(pg. 200)*

- ▶ Solar Gain Low-E
- ▶ Solar Advanced Control Low-E
- ▶ Solar Control Low-E
- ▶ ThermaPlus™ Low-E
- ▶ Neat®
- ▶ Triple pane
- ▶ Patterned-, bronze-, or gray-lite
- ▶ Tempered or laminated
- ▶ Other options standard to the industry

Divided Lites *(pg. 201)*

- ▶ Performance divided lites with 5/8", 7/8", 1-1/8", 1-3/8", 1-3/4", 2-1/4" or 4-1/2" bars
- ▶ Grilles-in-the-airpace

Insect Screens

- ▶ Insect screen with aluminum or UltraVue® fiberglass mesh; frame available in White, Beige, Dark Bronze anodized, Clear anodized, or Coal Black
- ▶ Retractable insect screen kit with beveled or square cover *(pg. 204)*
- ▶ Wood wrapped insect screen frame
- ▶ Brass insect screen with Brass frame

NOTE: All measurements are nominal.

Other Options *(custom options are also available)*

- ▶ Other wood species and FSC®-certified wood *(pg. 198)*
- ▶ Interior prefinishing *(pg. 198)*
- ▶ Interior casing
- ▶ Ovolo or square profile glazing beads and interior divided lite bars *(pg. 201)*
- ▶ Prep for stool
- ▶ Extruded aluminum accessories applied to accessory grooves on the exterior frame *(pgs. 206-212)*
- ▶ Ashlar handle in Satin Nickel, White, Rustic Umber or Matte Black
- ▶ Motorized operator
- ▶ Extension jambs *(up to 12" applied, over 12" shipped loose for field application)*
- ▶ Galvanized steel installation clips
- ▶ High performance or impact performance modifications *(pg. 205)*

Universal Design Handle *(shown in Clay)*



Push-Out Awnings

The exceedingly simple operation of push-out awning windows makes them ideal for adding ventilation to any room. The sash pushes out and pulls in tightly to the frame. Weather-stripping prevents air infiltration, making them another great energy-efficient option.



Photo courtesy of G.D. Nielsen Homes Ltd.

Push-Out Awning Standard Features

- ▶ 1-3/4" thick sash
- ▶ Overall jamb width is 4-9/16" (*basic box width is 2-3/4" plus extensions*)
- ▶ Constructed of pine, with pine interior stops and wood mull casings on mullied units
- ▶ Exterior wood parts are treated
- ▶ Extruded aluminum exterior finished with a 70% PVDF fluoropolymer coating (*meets performance requirements of AAMA 2605*)
- ▶ Accessory grooves are integral to the extruded frames for the easy addition of accessories
- ▶ Energy efficient, insulating Solar Low-E glass
- ▶ Glazed to the interior with beveled wood glazing beads
- ▶ Single-point lever handle in an Oil-Rubbed* finish
- ▶ Concealed hinges
- ▶ Heavy vinyl nailing fins with head drip caps**

NOTE: All measurements are nominal.

*The Oil-Rubbed finish is a living finish, which means that it will change appearance over time with use.

** Standard only on units without brickmould.

Hardware

- ▶ Easy-to-operate single-point or multi-point handles pull the sash tightly to the frame when closed, with weather stripping to prevent air infiltration and further promote energy efficiency. Available in Oil-Rubbed*, Natural Brass or Satin Nickel.

*The Oil-Rubbed finish is a living finish, which means that it will change appearance over time with use.

Single-Point Lock (*shown in Oil-Rubbed**)

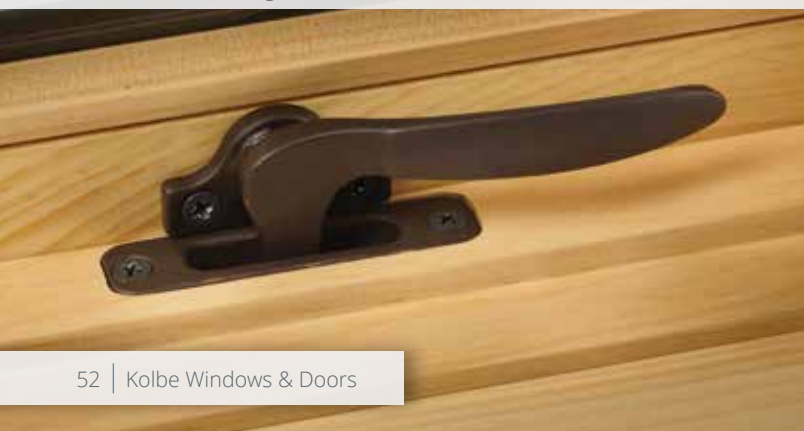

Multi-Point Lock (*shown in Satin Nickel*)





Push-Out EP Awning

Push-out EP (Energy Performance) awning windows feature triple pane glass to provide better energy performance as well as meet ENERGY STAR® criteria for U.S. and Canadian climate zones.

Standard Features *(includes push-out awning standard features on pg. 52, with the exception of the following substitutions)*

- ▶ 2-1/4" thick sash
- ▶ Overall jamb width is 4-9/16" *(basic box width is 3-1/4" plus extensions)*
- ▶ 1-3/8" total thickness of triple pane glass with Solar Low-E and Solar Gain Low-E coatings

Push-Out and Push-Out EP Awning Options

Glass *(pg. 200)*

- ▶ Solar Gain Low-E
- ▶ Solar Advanced Control Low-E
- ▶ Solar Control Low-E
- ▶ ThermaPlus™ Low-E
- ▶ Neat®
- ▶ Triple pane
- ▶ Patterned-, bronze-, or gray-lite
- ▶ Tempered or laminated
- ▶ Other options standard to the industry

Divided Lites *(pg. 201)*

- ▶ Performance divided lites with 5/8", 7/8", 1-1/8", 1-3/8", 1-3/4", 2-1/4" or 4-1/2" bars
- ▶ Grilles-in-the-air-space

Insect Screens

- ▶ Retractable insect screen with BetterVue® or UltraVue® fiberglass mesh and a beveled or square wood cover *(pg. 204)*
- ▶ Swinging insect screen with BetterVue® or UltraVue® fiberglass mesh and wood frame

NOTE: All measurements are nominal.

Other Options *(custom options are also available)*

- ▶ Other wood species and FSC®-certified wood *(pg. 198)*
- ▶ Interior prefinishing *(pg. 198)*
- ▶ Interior casing
- ▶ Ovolo or square profile glazing beads and interior divided lite bars *(pg. 201)*
- ▶ Prep for stool
- ▶ Extruded aluminum accessories applied to accessory grooves on the exterior frame *(pgs. 206-212)*
- ▶ Extension jambs *(up to 12" applied, over 12" shipped loose for field application)*
- ▶ Galvanized steel installation clips

Awnings | Elevation Charts

Awnings | Single Units

F.S.	1'-8"	2'-0"	2'-4"	2'-6"	2'-8"	3'-0"	3'-6"	4'-0"
R.O.	1'-8 1/2"	2'-0 1/2"	2'-4 1/2"	2'-6 1/2"	2'-8 1/2"	3'-0 1/2"	3'-6 1/2"	4'-0 1/2"
G.S.	14 5/8"	18 5/8"	22 5/8"	24 5/8"	26 5/8"	30 5/8"	36 5/8"	42 5/8"
G.S.*	13 7/8"	17 7/8"	21 7/8"	23 7/8"	25 7/8"	29 7/8"	35 7/8"	41 7/8"

1'-8"	1818	2018	2418	2618	2818	3018	3618	4018
2'-0"	1820	2020	2420	2620	2820	3020	3620	4020
2'-6"	1826	2026	2426	2626	2826	3026	3626	4026
3'-0"	1830	2030	2430	2630	2830	3030	3630	4030

Awnings | Single Picture Units

F.S.	2'-0"	2'-6"	2'-8"	3'-0"	3'-6"	4'-0"
R.O.	2'-0 1/2"	2'-6 1/2"	2'-8 1/2"	3'-0 1/2"	3'-6 1/2"	4'-0 1/2"
G.S.	18 5/8"	24 5/8"	26 5/8"	30 5/8"	36 5/8"	42 5/8"
G.S.*	17 7/8"	23 7/8"	25 7/8"	29 7/8"	35 7/8"	41 7/8"

4'-0"	2040	2640	2840	3040	3640	4040
5'-0"	2050	2650	2850	3050	3650	4050
6'-0"	2060	2660	2860	3060	3660	4060
6'-6"	2066	2666	2866	3066	3666	4066
7'-0"	2070	2670	2870	3070	3670	4070

* Glass size for push-out awnings

F.S. = Frame Size • R.O. = Rough Opening • G.S. = Glass Size

1'8" Widths

Awning Units & Mull Configurations

F.S.	1'-8"	3'-4"	5'-0"
R.O.	1'-8 1/2"	3'-4 1/2"	5'-0 1/2"
G.S.	14 5/8"	14 5/8"	14 5/8"
G.S.*	13 7/8"	13 7/8"	13 7/8"

1'-4"	18141	18142	18143
2'-8"	181412	181422	181432
4'-0"	181413	181423	181433

1'-6"	18161	18162	18163
3'-0"	181612	181622	181632
4'-6"	181613	181623	181633

1'-8"	18181	18182	18183
3'-4"	181812	181822	181832
5'-0"	181813	181823	181833

Dimension Calculations

	Width	Height
F.S. to Sash O.S.M.	-1 15/16"	-1 15/16"
Sash O.S.M. to G.S.	-2 13/16"	-2 13/16"
G.S. to D.L.O.	-1"	-1"
G.S. to Screen O.S.M.	+1-9/16"	+1/2"
U.D to G.S. (for push-outs)	-8 11/16"	-8 3/16"

F.S. = Frame Size • G.S. = Glass Size • O.S.M. = Outside Measurement
D.L.O. = Daylight Opening • U.D. = Unit Dimension

NOTE: All measurements are nominal. Elevation charts are not to scale. Divided lites are optional.

Some installation procedures will require a larger rough opening than noted (i.e. installations utilizing our installation clips), therefore, you may need to increase the rough opening size accordingly. Rough opening gaps may be increased up to a maximum of 1/2" on all sides and still be within good practice guidelines. For rough opening recommendations, see pg. 216.

Additional and the most current drawings are available at www.kolbewindows.com.

1'8" Widths cont.

Awning Units & Mull Configurations

F.S.	1'-8"	3'-4"	5'-0"
R.O.	1'-8 1/2"	3'-4 1/2"	5'-0 1/2"
G.S.	14 5/8"	14 5/8"	14 5/8"
G.S.*	13 7/8"	13 7/8"	13 7/8"

2'-0"	4'-0"	6'-0"	2'-6"	5'-0"	3'-0"	6'-0"	4'-0"	8'-0"
2'-0 1/2"	4'-0 1/2"	6'-0 1/2"	2'-6 1/2"	5'-0 1/2"	3'-0 1/2"	6'-0 1/2"	4'-0 1/2"	8'-0 1/2"
18 5/8"	18 5/8"	18 5/8"	24 5/8"	24 5/8"	30 5/8"	30 5/8"	42 5/8"	42 5/8"
17 7/8"	17 7/8"	17 7/8"	23 7/8"	23 7/8"	29 7/8"	29 7/8"	41 7/8"	41 7/8"

Basic Unit 1820	Basic Unit 1826	Basic Unit 1830	Basic Unit 1840
18201	18261	18301	18401
18202	18262	18302	18402
18203	18263	18303	18403
182012	182612	183012	184012
182022	182622	183022	184022
182032	182632	183032	184032
182013	182613	183013	184013
182023	182623	183023	184023
182033	182633	183033	184033

* Glass size for push-out awnings
 F.S. = Frame Size • R.O. = Rough Opening • G.S. = Glass Size

NOTE: All measurements are nominal. Elevation charts are not to scale. Divided lites are optional.
 Some installation procedures will require a larger rough opening than noted (i.e. installations utilizing our installation clips), therefore, you may need to increase the rough opening size accordingly. Rough opening gaps may be increased up to a maximum of 1/2" on all sides and still be within good practice guidelines. For rough opening recommendations, see pg. 216.
 Additional and the most current drawings are available at www.kolbewindows.com.

Awnings | Picture Units

F.S.	1'-8"	3'-4"	5'-0"
R.O.	1'-8 1/2"	3'-4 1/2"	5'-0 1/2"
G.S.	14 5/8"	14 5/8"	14 5/8"

4'-0"	5'-0"	6'-0"	6'-6"	7'-0"
4'-0 1/2"	5'-0 1/2"	6'-0 1/2"	6'-6 1/2"	7'-0 1/2"
42 5/8"	54 5/8"	66 5/8"	72 5/8"	78 5/8"

Basic Unit 1840	Basic Unit 1850	Basic Unit 1860	Basic Unit 1866	Basic Unit 1870
18401	18501	18601	18661	18701
18402	18502	18602	18662	18702
18403	18503	18603	18663	18703

Awning Unit Combinations

F.S.	1'-8"	3'-4"	5'-0"
R.O.	1'-8 1/2"	3'-4 1/2"	5'-0 1/2"
G.S.	14 5/8"	14 5/8"	14 5/8"

4'-4"	5'-0"	5'-8"	6'-0"	6'-8 1/2"
4'-4 1/2"	5'-0 1/2"	5'-8 1/2"	6'-0 1/2"	6'-8 1/2"
30 5/8"	30 5/8"	30 5/8"	42 5/8"	54 5/8"

Basic Unit 1830 over 1818	Basic Unit 1830 over 1820	Basic Unit 1840 over 1818	Basic Unit 1840 over 1820	Basic Unit 1850 over 1818
1830181	1830201	1840181	1840201	1850181
1830182	1830202	1840182	1840202	1850182
1830183	1830203	1840183	1840203	1850183

2'0" Widths

Awning Units & Mull Configurations

F.S.	2'-0"	4'-0"	6'-0"
R.O.	2'-0 1/2"	4'-0 1/2"	6'-0 1/2"
G.S.	18 5/8"	18 5/8"	18 5/8"
G.S.*	17 7/8"	17 7/8"	17 7/8"
1'-4"	20141	20142	20143
2'-8"	201412	201422	201432
4'-0"	201413	201423	201433
1'-6"	20161	20162	20163
3'-0"	201612	201622	201632
4'-6"	201613	201623	201633
1'-8"	20181	20182	20183
3'-4"	201812	201822	201832
5'-0"	201813	201823	201833
2'-0"	20201	20202	20203
4'-0"	202012	202022	202032
6'-0"	202013	202023	202033
2'-6"	20261	20262	20263
5'-0"	202612	202622	202632
3'-0"	20301	20302	20303
6'-0"	203012	203022	203032
4'-0"	20401	20402	20403
8'-0"	204012	204022	204032

* Glass size for push-out awnings

F.S. = Frame Size • R.O. = Rough Opening • G.S. = Glass Size

Awnings | Picture Units

F.S.	2'-0"	4'-0"	6'-0"
R.O.	2'-0 1/2"	4'-0 1/2"	6'-0 1/2"
G.S.	18 5/8"	18 5/8"	18 5/8"
G.S.*	17 7/8"	17 7/8"	17 7/8"
4'-0"	20401	20402	20403
5'-0"	20501	20502	20503
6'-0"	20601	20602	20603

* Glass size for push-out awnings

F.S. = Frame Size • R.O. = Rough Opening • G.S. = Glass Size

Awning Unit Combinations

F.S.	2'-0"	4'-0"	6'-0"
R.O.	2'-0 1/2"	4'-0 1/2"	6'-0 1/2"
G.S.	18 5/8"	18 5/8"	18 5/8"
G.S.*	17 7/8"	17 7/8"	17 7/8"
4'-8"	2030181	2030182	2030183
5'-0"	2030201	2030202	2030202
5'-8"	2040181	2040182	2040183
6'-0"	2040201	2040202	2040203
6'-8"	2050181	2050182	2050183

* Glass size for push-out awnings

F.S. = Frame Size • R.O. = Rough Opening • G.S. = Glass Size

NOTE: All measurements are nominal. Elevation charts are not to scale. Divided lites are optional.

Some installation procedures will require a larger rough opening than noted (i.e. installations utilizing our installation clips), therefore, you may need to increase the rough opening size accordingly. Rough opening gaps may be increased up to a maximum of 1/2" on all sides and still be within good practice guidelines. For rough opening recommendations, see pg. 216.

Additional and the most current drawings are available at www.kolbewindows.com.

2'4" Widths

Awning Units & Mull Configurations

F.S.	2'-4"	4'-8"	7'-0"
R.O.	2'-4 1/2"	4'-8 1/2"	7'-0 1/2"
G.S.	22 5/8"	22 5/8"	22 5/8"
G.S.*	21 7/8"	21 7/8"	21 7/8"
1'-4"			
2'-8 1/2"			
4'-0 1/2"			
1'-6"			
3'-0 1/2"			
4'-6 1/2"			
1'-8"			
3'-4 1/2"			
5'-0 1/2"			
2'-0"			
4'-0 1/2"			
6'-0"			
2'-6"			
5'-0 1/2"			
3'-0"			
6'-0 1/2"			
4'-0"			
8'-0 1/2"			

Awnings | Picture Units

F.S.	2'-4"	4'-8"	7'-0"
R.O.	2'-4 1/2"	4'-8 1/2"	7'-0 1/2"
G.S.	22 5/8"	22 5/8"	22 5/8"
4'-0"			
5'-0 1/2"			
6'-0"			
6'-6 1/2"			
7'-0"			

Awning Unit Combinations

F.S.	2'-4"	4'-8"	7'-0"
R.O.	2'-4 1/2"	4'-8 1/2"	7'-0 1/2"
G.S.	22 5/8"	22 5/8"	22 5/8"
4'-8 1/2"			
5'-0 1/2"			
5'-8 1/2"			
6'-0 1/2"			
6'-8 1/2"			

* Glass size for push-out awnings

F.S. = Frame Size • R.O. = Rough Opening • G.S. = Glass Size

NOTE: All measurements are nominal. Elevation charts are not to scale. Divided lites are optional.

Some installation procedures will require a larger rough opening than noted (i.e. installations utilizing our installation clips), therefore, you may need to increase the rough opening size accordingly. Rough opening gaps may be increased up to a maximum of 1/2" on all sides and still be within good practice guidelines. For rough opening recommendations, see pg. 216.

Additional and the most current drawings are available at www.kolbewindows.com.

2'6" Widths

Awning Units & Mull Configurations

F.S.	2'-6"	5'-0"	7'-6"
R.O.	2'-6 1/2"	5'-0 1/2"	7'-6 1/2"
G.S.	24 5/8"	24 5/8"	24 5/8"
G.S.*	23 7/8"	23 7/8"	23 7/8"
1'-4"	26141	26142	26143
1'-4 1/2"	261412	261422	261432
2'-8"	261413	261423	261433
4'-0"	261413	261423	261433
4'-0 1/2"	261413	261423	261433
10 5/8"	261413	261423	261433
9 7/8"	261413	261423	261433
1'-6"	26161	26162	26163
1'-6 1/2"	261612	261622	261632
3'-0"	261613	261623	261633
3'-0 1/2"	261613	261623	261633
12 5/8"	261613	261623	261633
12 5/8"	261613	261623	261633
11 7/8"	261613	261623	261633
11 7/8"	261613	261623	261633
1'-8"	26181	26182	26183
1'-8 1/2"	261812	261822	261832
3'-4"	261813	261823	261833
3'-4 1/2"	261813	261823	261833
14 5/8"	261813	261823	261833
13 7/8"	261813	261823	261833
13 7/8"	261813	261823	261833
2'-0"	26201	26202	26203
2'-0 1/2"	262012	262022	262032
4'-0"	262013	262023	262033
4'-0 1/2"	262013	262023	262033
18 5/8"	262013	262023	262033
18 5/8"	262013	262023	262033
17 7/8"	262013	262023	262033
2'-6"	26261	26262	26263
2'-6 1/2"	262612	262622	262632
5'-0"	262613	262623	262633
5'-0 1/2"	262613	262623	262633
24 5/8"	262613	262623	262633
23 7/8"	262613	262623	262633
3'-0"	26301	26302	26303
3'-0 1/2"	263012	263022	263032
6'-0"	263013	263023	263033
6'-0 1/2"	263013	263023	263033
30 5/8"	263013	263023	263033
29 7/8"	263013	263023	263033
4'-0"	26401	26402	26403
4'-0 1/2"	264012	264022	264032
8'-0"	264013	264023	264033
8'-0 1/2"	264013	264023	264033
42 5/8"	264013	264023	264033
41 7/8"	264013	264023	264033

Awnings | Picture Units

F.S.	2'-6"	5'-0"	7'-6"
R.O.	2'-6 1/2"	5'-0 1/2"	7'-6 1/2"
G.S.	24 5/8"	24 5/8"	24 5/8"
G.S.*	23 7/8"	23 7/8"	23 7/8"
4'-0"	26401	26402	26403
4'-0 1/2"	26401	26402	26403
42 5/8"	26401	26402	26403
41 7/8"	26401	26402	26403
5'-0"	26501	26502	26503
5'-0 1/2"	26501	26502	26503
54 5/8"	26501	26502	26503
53 7/8"	26501	26502	26503
6'-0"	26601	26602	26603
6'-0 1/2"	26601	26602	26603
66 5/8"	26601	26602	26603
65 7/8"	26601	26602	26603

* Glass size for push-out awnings

F.S. = Frame Size • R.O. = Rough Opening • G.S. = Glass Size (Glass sizes are shown per sash)

Awning Unit Combinations

F.S.	2'-6"	5'-0"	7'-6"
R.O.	2'-6 1/2"	5'-0 1/2"	7'-6 1/2"
G.S.	24 5/8"	24 5/8"	24 5/8"
G.S.*	23 7/8"	23 7/8"	23 7/8"
4'-8 1/2"	2630181	2630182	2630183
4'-8 1/2"	2630181	2630182	2630183
14 5/8" 30 5/8"	2630181	2630182	2630183
13 7/8" 29 7/8"	2630181	2630182	2630183
5'-0"	2630201	2630202	2630203
5'-0 1/2"	2630201	2630202	2630203
18 5/8" 30 5/8"	2630201	2630202	2630203
17 7/8" 29 7/8"	2630201	2630202	2630203
5'-8"	2640181	2640182	2640183
5'-8 1/2"	2640181	2640182	2640183
14 5/8" 42 5/8"	2640181	2640182	2640183
13 7/8" 41 7/8"	2640181	2640182	2640183
6'-0"	2640201	2640202	2640203
6'-0 1/2"	2640201	2640202	2640203
18 5/8" 42 5/8"	2640201	2640202	2640203
17 7/8" 41 7/8"	2640201	2640202	2640203
6'-8"	2650181	2650182	2650183
6'-8 1/2"	2650181	2650182	2650183
14 5/8" 54 5/8"	2650181	2650182	2650183
13 7/8" 53 7/8"	2650181	2650182	2650183

* Glass size for push-out awnings

F.S. = Frame Size • R.O. = Rough Opening • G.S. = Glass Size (Glass sizes are shown per sash)

* Glass size for push-out awnings

F.S. = Frame Size • R.O. = Rough Opening • G.S. = Glass Size (Glass sizes are shown per sash)

NOTE: All measurements are nominal. Elevation charts are not to scale. Divided lites are optional.

Some installation procedures will require a larger rough opening than noted (i.e. installations utilizing our installation clips), therefore, you may need to increase the rough opening size accordingly. Rough opening gaps may be increased up to a maximum of 1/2" on all sides and still be within good practice guidelines. For rough opening recommendations, see pg. 216.

Additional and the most current drawings are available at www.kolbewindows.com.

2'8" Widths

Awning Units & Mull Configurations

F.S.	2'-8"	5'-4"	8'-0"
R.O.	2'-8 1/2"	5'-4 1/2"	8'-0 1/2"
G.S.	26 5/8"	26 5/8"	26 5/8"
G.S.*	25 7/8"	25 7/8"	25 7/8"

Basic Unit 2814	Basic Unit 2816	Basic Unit 2818	Basic Unit 2820	Basic Unit 2826	Basic Unit 2830	Basic Unit 2840
28141, 28142, 28143, 281412, 281422, 281432, 281413, 281423, 281433	28161, 28162, 28163, 281612, 281622, 281632, 281613, 281623, 281633	28181, 28182, 28183, 281812, 281822, 281832, 281813, 281823, 281833	28201, 28202, 28203, 282012, 282022, 282032, 282013, 282023, 282033	28261, 28262, 28263, 282612, 282622, 282632	28301, 28302, 28303, 283012, 283022, 283032	28401, 28402, 28403, 284012, 284022, 284032

Awnings | Picture Units

F.S.	2'-8"	5'-4"	8'-0"
R.O.	2'-8 1/2"	5'-4 1/2"	8'-0 1/2"
G.S.	26 5/8"	26 5/8"	26 5/8"
G.S.*	25 7/8"	25 7/8"	25 7/8"

Basic Unit 2840	Basic Unit 2850	Basic Unit 2860
28401, 28402, 28403	28501, 28502, 28503	28601, 28602, 28603

* Glass size for push-out awnings

F.S. = Frame Size • R.O. = Rough Opening • G.S. = Glass Size (Glass sizes are shown per sash)

Awning Unit Combinations

F.S.	2'-8"	5'-4"	8'-0"
R.O.	2'-8 1/2"	5'-4 1/2"	8'-0 1/2"
G.S.	26 5/8"	26 5/8"	26 5/8"
G.S.*	25 7/8"	25 7/8"	25 7/8"

Basic Unit 2830 over 2818	Basic Unit 2830 over 2820	Basic Unit 2840 over 2818	Basic Unit 2840 over 2820	Basic Unit 2850 over 2818
2830181, 2830182, 2830183	2830201, 2830202, 2830203	2840181, 2840182, 2840183	2840201, 2840202, 2840203	2850181, 2850182, 2850183

* Glass size for push-out awnings

F.S. = Frame Size • R.O. = Rough Opening • G.S. = Glass Size (Glass sizes are shown per sash)

NOTE: All measurements are nominal. Elevation charts are not to scale. Divided lites are optional.

Some installation procedures will require a larger rough opening than noted (i.e. installations utilizing our installation clips), therefore, you may need to increase the rough opening size accordingly. Rough opening gaps may be increased up to a maximum of 1/2" on all sides and still be within good practice guidelines. For rough opening recommendations, see pg. 216.

Additional and the most current drawings are available at www.kolbewindows.com.

Awnings | Elevation Charts

3'0" Widths

Awning Units & Mull Configurations

F.S.	3'-0"	6'-0"	9'-0"
R.O.	3'-0 1/2"	6'-0 1/2"	9'-0 1/2"
G.S.	30 5/8"	30 5/8"	30 5/8"
G.S.*	29 7/8"	29 7/8"	29 7/8"
1'-4"			
2'-8"			
4'-0"			
4'-0 1/2"			
4'-0 1/2"			
10 5/8"			
10 5/8"			
10 5/8"			
10 5/8"			
1'-6"			
3'-0"			
4'-6"			
4'-6 1/2"			
4'-6 1/2"			
12 5/8"			
12 5/8"			
12 5/8"			
12 5/8"			
1'-8"			
3'-4"			
5'-0"			
5'-0 1/2"			
5'-0 1/2"			
14 5/8"			
14 5/8"			
13 7/8"			
13 7/8"			
2'-0"			
4'-0"			
6'-0"			
6'-0 1/2"			
6'-0 1/2"			
18 5/8"			
18 5/8"			
17 7/8"			
17 7/8"			
2'-6"			
5'-0"			
5'-0 1/2"			
5'-0 1/2"			
24 5/8"			
24 5/8"			
23 7/8"			
23 7/8"			
3'-0"			
6'-0"			
6'-0 1/2"			
6'-0 1/2"			
30 5/8"			
29 7/8"			
29 7/8"			
4'-0"			
8'-0"			
4'-0 1/2"			
4'-0 1/2"			
42 5/8"			
41 7/8"			
41 7/8"			

Awnings | Picture Units

F.S.	3'-0"	6'-0"	9'-0"
R.O.	3'-0 1/2"	6'-0 1/2"	9'-0 1/2"
G.S.	30 5/8"	30 5/8"	30 5/8"
G.S.*	29 7/8"	29 7/8"	29 7/8"
4'-0"			
4'-0 1/2"			
42 5/8"			
41 7/8"			
5'-0"			
5'-0 1/2"			
54 5/8"			
53 7/8"			
6'-0"			
6'-0 1/2"			
66 5/8"			
65 7/8"			

* Glass size for push-out awnings

F.S. = Frame Size • R.O. = Rough Opening • G.S. = Glass Size (Glass sizes are shown per sash)

Awning Unit Combinations

F.S.	3'-0"	6'-0"	9'-0"
R.O.	3'-0 1/2"	6'-0 1/2"	9'-0 1/2"
G.S.	30 5/8"	30 5/8"	30 5/8"
G.S.*	29 7/8"	29 7/8"	29 7/8"
4'-8"			
4'-8 1/2"			
14 5/8" 30 5/8"			
13 7/8" 29 7/8"			
5'-0"			
5'-0 1/2"			
18 5/8" 30 5/8"			
17 7/8" 29 7/8"			
5'-8"			
5'-8 1/2"			
14 5/8" 42 5/8"			
13 7/8" 41 7/8"			
6'-0"			
6'-0 1/2"			
18 5/8" 42 5/8"			
17 7/8" 41 7/8"			
6'-8"			
6'-8 1/2"			
14 5/8" 54 5/8"			
13 7/8" 53 7/8"			

* Glass size for push-out awnings

F.S. = Frame Size • R.O. = Rough Opening • G.S. = Glass Size (Glass sizes are shown per sash)

NOTE: All measurements are nominal. Elevation charts are not to scale. Divided lites are optional.

Some installation procedures will require a larger rough opening than noted (i.e. installations utilizing our installation clips), therefore, you may need to increase the rough opening size accordingly. Rough opening gaps may be increased up to a maximum of 1/2" on all sides and still be within good practice guidelines. For rough opening recommendations, see pg. 216.

Additional and the most current drawings are available at www.kolbewindows.com.

3'6" Widths

Awning Units & Mull Configurations

F.S.	3'-6"	7'-0"	10'-6"
R.O.	3'-6 1/2"	7'-0 1/2"	10'-6 1/2"
G.S.	36 5/8"	36 5/8"	36 5/8"
G.S.*	35 7/8"	35 7/8"	35 7/8"
4'-0"	36141	36142	36143
4'-0 1/2"	361412	361422	361432
4'-0 1/2"	361413	361423	361433
4'-6"	36161	36162	36163
4'-6 1/2"	361612	361622	361632
4'-6 1/2"	361613	361623	361633
5'-0"	36181	36182	36183
5'-0 1/2"	361812	361822	361832
5'-0 1/2"	361813	361823	361833
6'-0"	36201	36202	36203
6'-0 1/2"	362012	362022	362032
6'-0 1/2"	362013	362023	362033
6'-0 1/2"	36261	36262	36263
6'-0 1/2"	362612	362622	362632
6'-0 1/2"	36301	36302	36303
6'-0 1/2"	363012	363022	363032
8'-0"	36401	36402	36403
8'-0 1/2"	364012	36402	364032

Awnings | Picture Units

F.S.	3'-6"	7'-0"	10'-6"
R.O.	3'-6 1/2"	7'-0 1/2"	10'-6 1/2"
G.S.	36 5/8"	36 5/8"	36 5/8"
G.S.*	35 7/8"	35 7/8"	35 7/8"
4'-0"	36401	36402	36403
5'-0"	36501	36502	36503
6'-0"	36601	36602	36603

* Glass size for push-out awnings

F.S. = Frame Size • R.O. = Rough Opening • G.S. = Glass Size (Glass sizes are shown per sash)

Awning Unit Combinations

F.S.	3'-6"	7'-0"	10'-6"
R.O.	3'-6 1/2"	7'-0 1/2"	10'-6 1/2"
G.S.	36 5/8"	36 5/8"	36 5/8"
G.S.*	35 7/8"	35 7/8"	35 7/8"
4'-8"	3630181	3630182	3630183
5'-0"	3630201	3630202	3630203
5'-8"	3640181	3640182	3640183
6'-0"	3640201	3640202	3640203
6'-8"	3650181	3650182	3650183

* Glass size for push-out awnings

F.S. = Frame Size • R.O. = Rough Opening • G.S. = Glass Size (Glass sizes are shown per sash)

NOTE: All measurements are nominal. Elevation charts are not to scale. Divided lites are optional.

Some installation procedures will require a larger rough opening than noted (i.e. installations utilizing our installation clips), therefore, you may need to increase the rough opening size accordingly. Rough opening gaps may be increased up to a maximum of 1/2" on all sides and still be within good practice guidelines. For rough opening recommendations, see pg. 216.

Additional and the most current drawings are available at www.kolbwindows.com.

Awnings | Elevation Charts

4'0" Widths

Awning Units & Mull Configurations

F.S.	4'-0"	8'-0"	12'-0"
R.O.	4'-0 1/2"	8'-0 1/2"	12'-0 1/2"
G.S.	42 5/8"	42 5/8"	42 5/8"
G.S.*	41 7/8"	41 7/8"	41 7/8"
1'-4"			
1'-4 1/2"			
2'-9"			
4'-0"			
4'-0 1/2"			
4'-0 1/2"			
4'-0 1/2"			
4'-0 1/2"			
1'-6"			
1'-6 1/2"			
3'-0"			
3'-0 1/2"			
4'-6"			
4'-6 1/2"			
4'-6 1/2"			
4'-6 1/2"			
1'-8"			
1'-8 1/2"			
3'-4"			
3'-4 1/2"			
5'-0"			
5'-0 1/2"			
5'-0 1/2"			
5'-0 1/2"			
2'-0"			
2'-0 1/2"			
4'-0"			
4'-0 1/2"			
6'-0"			
6'-0 1/2"			
6'-0 1/2"			
6'-0 1/2"			
2'-6"			
2'-6 1/2"			
5'-0"			
5'-0 1/2"			
5'-0 1/2"			
5'-0 1/2"			
3'-0"			
3'-0 1/2"			
6'-0"			
6'-0 1/2"			
6'-0 1/2"			
6'-0 1/2"			
4'-0"			
4'-0 1/2"			
8'-0"			
8'-0 1/2"			
8'-0 1/2"			
8'-0 1/2"			

* Glass size for push-out awnings
F.S. = Frame Size • R.O. = Rough Opening • G.S. = Glass Size (Glass sizes are shown per sash)

Awnings | Picture Units

F.S.	4'-0"	8'-0"	12'-0"
R.O.	4'-0 1/2"	8'-0 1/2"	12'-0 1/2"
G.S.	42 5/8"	42 5/8"	42 5/8"
G.S.*	41 7/8"	41 7/8"	41 7/8"
4'-0"			
4'-0 1/2"			
5'-0"			
5'-0 1/2"			
6'-0 1/2"			
6'-0 1/2"			
6'-0 1/2"			

* Glass size for push-out awnings
F.S. = Frame Size • R.O. = Rough Opening • G.S. = Glass Size (Glass sizes are shown per sash)

Awning Unit Combinations

F.S.	4'-0"	8'-0"	12'-0"
R.O.	4'-0 1/2"	8'-0 1/2"	12'-0 1/2"
G.S.	42 5/8"	42 5/8"	42 5/8"
G.S.*	41 7/8"	41 7/8"	41 7/8"
4'-8"			
4'-8 1/2"			
5'-0"			
5'-0 1/2"			
5'-8"			
5'-8 1/2"			
6'-0"			
6'-0 1/2"			
6'-8"			
6'-8 1/2"			

* Glass size for push-out awnings
F.S. = Frame Size • R.O. = Rough Opening • G.S. = Glass Size (Glass sizes are shown per sash)

NOTE: All measurements are nominal. Elevation charts are not to scale. Divided lites are optional.

Some installation procedures will require a larger rough opening than noted (i.e. installations utilizing our installation clips), therefore, you may need to increase the rough opening size accordingly. Rough opening gaps may be increased up to a maximum of 1/2" on all sides and still be within good practice guidelines. For rough opening recommendations, see pg. 216.

Additional and the most current drawings are available at www.kolbwindows.com.

Awnings | Cross Section Drawings

Crank-Out Awnings

Horizontal Section

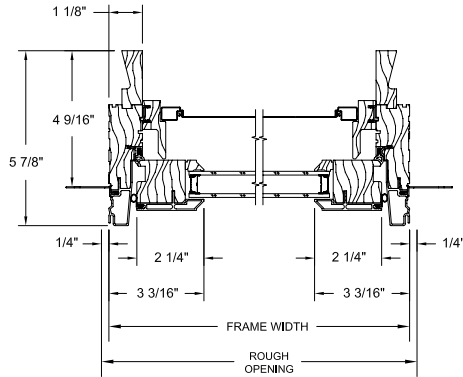

Vertical Section

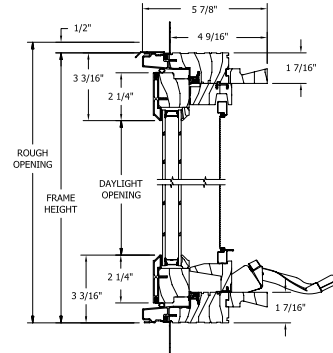

Crank-Out Awnings with 1-15/16" Brickmould & 6-9/16" Jamb

Horizontal Section

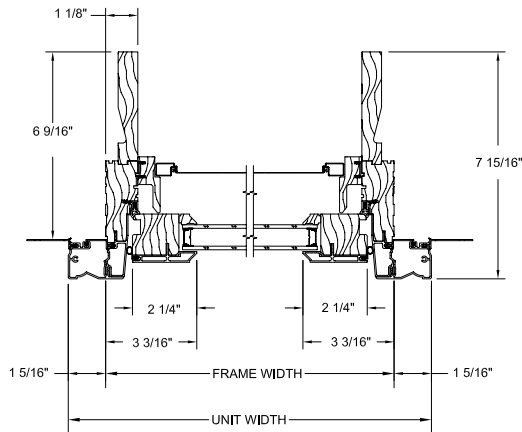

Vertical Section

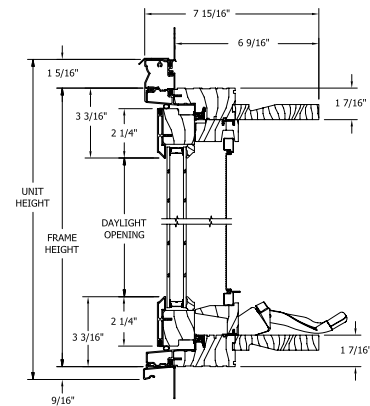

Crank-Out Awnings

Standard Mullion

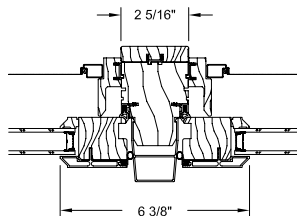

Narrow Mullion

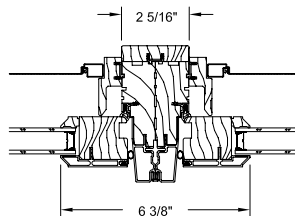

Transom Stacked Over Awning

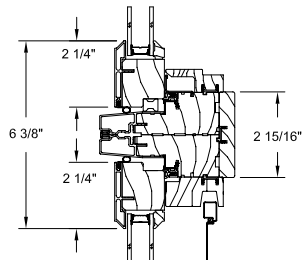

NOTE: Drawings are not to scale. Brickmould is shown factory-applied. Brickmould may be shipped loose for field application. Some units are shown with optional drip cap or nailing fin. For Ultra accessory or application drawings, see pgs. 206-212. Additional and the most current drawings are available at www.kolbewindows.com.

Awnings | Cross Section Drawings

Push-Out Awnings

Horizontal Section

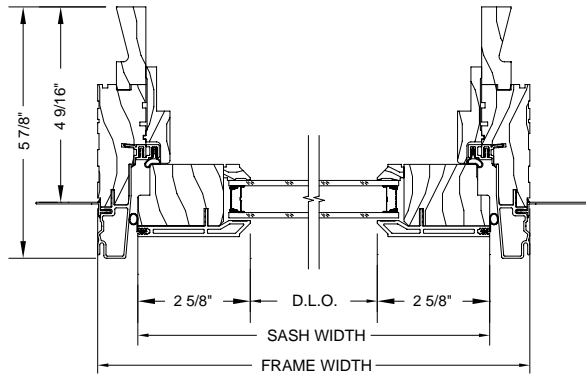

Vertical Section

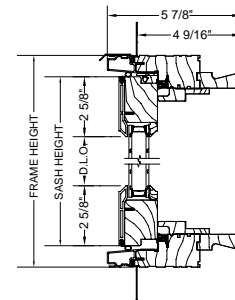

Push-Out Awnings

Standard Mullion

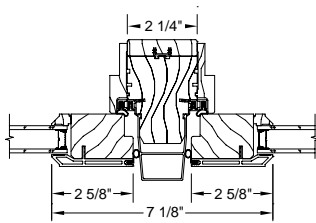

Narrow Mullion

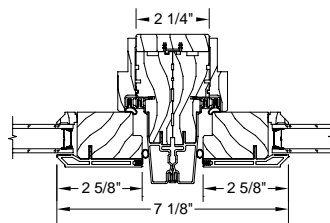

Picture Unit Stacked Over Push-Out Awning

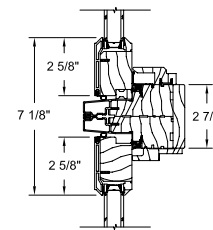

NOTE: Drawings are not to scale. Brickmould is shown factory-applied. Brickmould may be shipped loose for field application. Some units are shown with optional drip cap or nailing fin. For Ultra accessory or application drawings, see pgs. 206-212. Additional and the most current drawings are available at www.kolbewindows.com.

Push-Out EP Awnings | Swinging Screen

Horizontal Section
multi-point lock

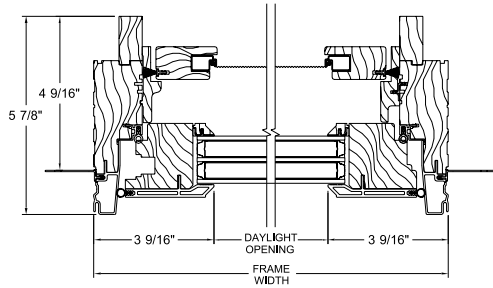

Vertical Section
multi- or single-point lock

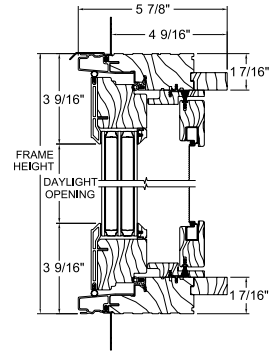

Push-Out EP Awnings | Retractable Screen

Horizontal Section
multi-point lock

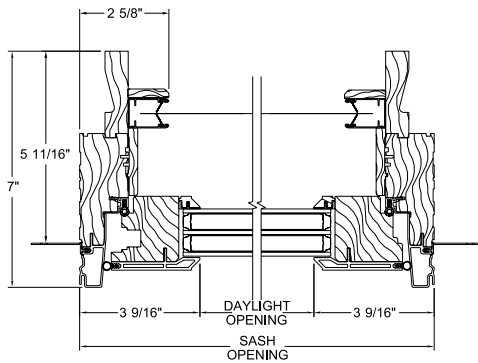

Vertical Section
multi- or single-point lock

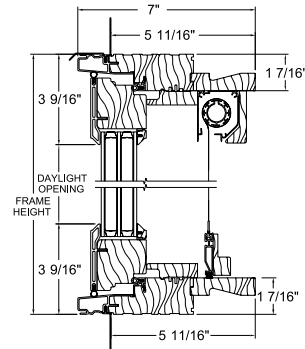

NOTE: Drawings are not to scale. Brickmould is shown factory-applied. Brickmould may be shipped loose for field application. Some units are shown with optional drip cap or nailing fin. For Ultra accessory or application drawings, see pgs. 206-212. Additional and the most current drawings are available at www.kolbewindows.com.

Awnings | Cross Section Drawings

Crank-Out XL Awnings

Horizontal Section

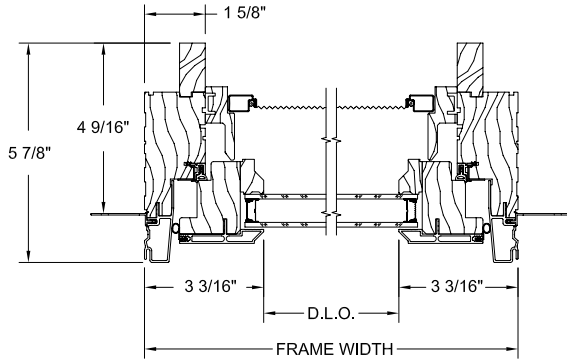

Vertical Section

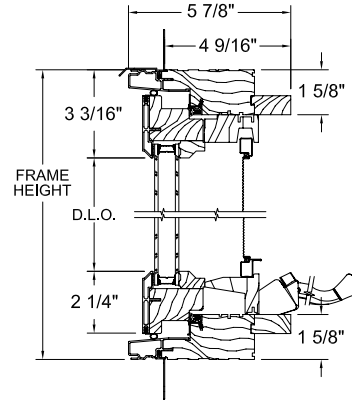

Crank-Out XL Awnings | Retractable Screen

Horizontal Section

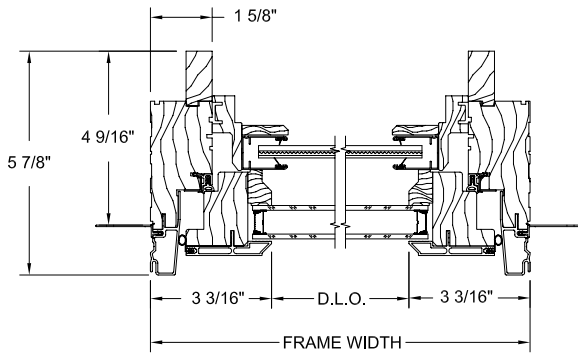

Vertical Section

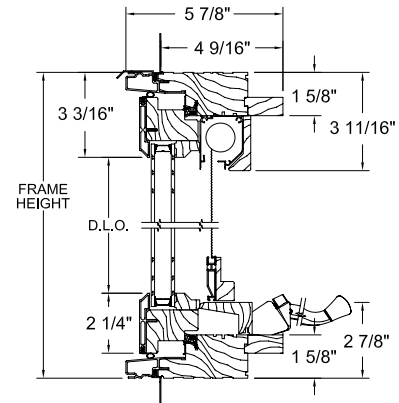

NOTE: Drawings are not to scale. Brickmould is shown factory-applied. Brickmould may be shipped loose for field application. Some units are shown with optional drip cap or nailing fin. For Ultra accessory or application drawings, see pgs. 206-212. Additional and the most current drawings are available at www.kolbewindows.com.







Double Hungs

Quality details adorn the classic design of Ultra Series double hungs. Both Traditional and Sterling double hung sash can be removed from the inside of the home for easy cleaning. Choose options such as divided lites or triple pane glass to enhance style or performance. Or, replace older windows with an easy-to-install, energy-efficient pocket double hung.

*Sterling Double Hungs | XL Sterling Double Hungs | Majesta® Double Hungs | Traditional Double Hungs
Pocket Double Hungs | Cottage Style & Reverse Cottage Style Units | Studio & Transom Units | Picture Combination Units
Bay Units | Segment Head & Half-Circle Top Units | Single Units*

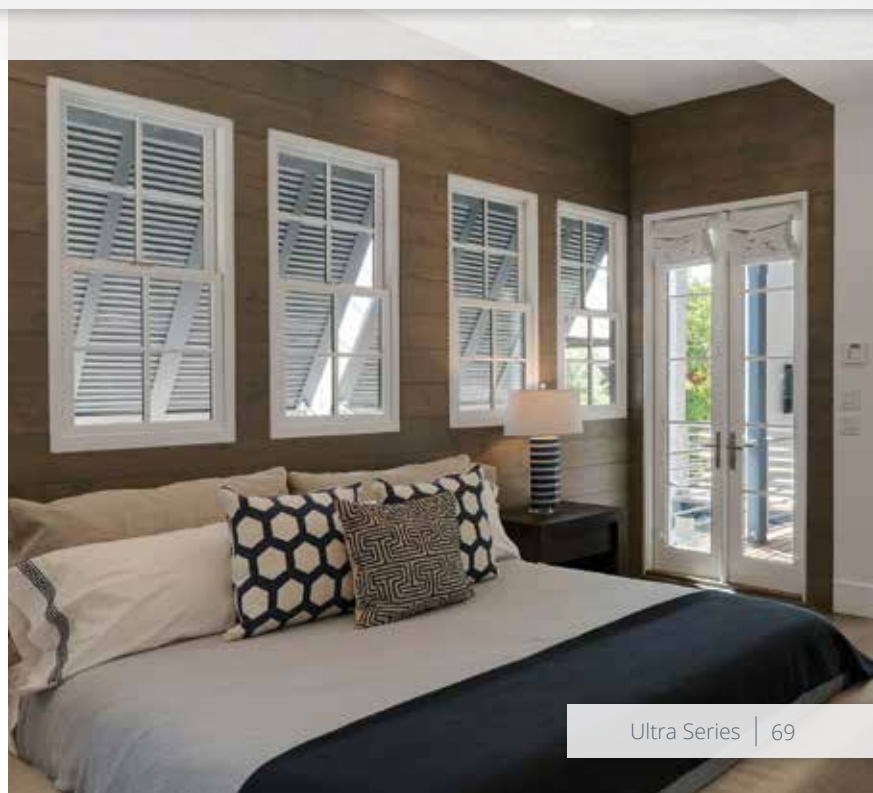

Sterling Double Hungs

Sterling double hungs are made to blend seamlessly with the grandest décor. A patented interior wood cover conceals the jambliner, giving the windows a rich, all-wood appearance.

Patents: 7,296,381 | 7,448,164 | 8,196,355 | 8,429,856



Sterling Double Hung Standard Features

- ▶ 1-3/4" thick sash
- ▶ Overall jamb width is 4-9/16" (*basic box width is 4-9/16"*)
- ▶ Frame thickness is 3/4" at side jambs and head
- ▶ Sill thickness is 1-3/16"; slope is 14°
- ▶ Constructed of pine, with pine interior stops and wood mull casings on mull units
- ▶ Exterior wood parts are treated
- ▶ Extruded aluminum exterior finished with a 70% PVDF fluoropolymer coating (*meets performance requirements of AAMA 2605*)
- ▶ Accessory grooves are integral to the extruded frames for the easy addition of accessories
- ▶ Energy efficient, insulating Solar Low-E glass
- ▶ Glazed to the interior with beveled wood glazing beads
- ▶ Wood interior head parting stop
- ▶ Clay-colored heavy duty Signature sash lock
- ▶ Spring-loaded block-and-tackle mechanical balances to carry the sash weight
- ▶ Concealed balance system
- ▶ Patented wood wrapped jambliner closure on the interior (*unless interior is prefinished white or primed, then jambliner will be white*) and extruded aluminum jambliner closure on the exterior hide balance system
- ▶ Heavy vinyl nailing fins with head drip caps*
- ▶ Pine-veneered head and seat boards; unique narrow mullions and cable support system on bay units

NOTE: All measurements are nominal.

* Standard only on units without brickmould.

Hardware

- ▶ Pick-resistant Signature or Spoon sash lock with a concealed locking system and tilt latches. Available in Clay, White, Beige, Brass, Antique Brass, Satin Nickel, Chrome[†], Brushed Chrome[†], Antique Nickel, Rustic Umber or Matte Black.
- ▶ Curved, square, or traditional style sash lift handles for ease of use. Available in Clay, White, Beige, Brass, Antique Brass, Satin Nickel, Chrome[†], Brushed Chrome[†], Antique Nickel, Rustic Umber or Matte Black.
- ▶ Custodial lock to prohibit unauthorized operation (*not pictured*).
- ▶ Universal design crank handle hardware kit offers ease-of-use for people with physical limitations. Available in White (*not pictured*).

[†] Chrome and Brushed Chrome finishes are only available on Signature sash locks and curved sash lift handles.

Signature Sash Lock

(shown in Antique Nickel)



Spoon Sash Lock

(shown in Antique Brass)



Curved Sash Lift Handle

(shown in Chrome)





Sterling Double Hung Options

Glass (pg. 200)

- ▶ Solar Gain Low-E
- ▶ Solar Advanced Control Low-E
- ▶ Solar Control Low-E
- ▶ ThermaPlus™ Low-E
- ▶ Neat®
- ▶ Triple pane
- ▶ Patterned-, bronze-, or gray-lite
- ▶ Tempered or laminated
- ▶ Other options standard to the industry

Divided Lites (pg. 201)

- ▶ Performance divided lites with 5/8", 7/8", 1-1/8", 1-3/8", 1-3/4", 2-1/4" or 4-1/2" bars
- ▶ Grilles-in-the-airpace

Insect Screens

- ▶ Full or half insect screen with aluminum frame and options for BetterVue® or UltraVue® fiberglass mesh or aluminum mesh; frame will match the exterior color of the unit
- ▶ Retractable insect screen kit with beveled or square cover (pg. 204)

NOTE: All measurements are nominal.

Other Options (custom options are also available)

- ▶ Other wood species and FSC®-certified wood (pg. 198)
- ▶ Interior prefinishing (pg. 198)
- ▶ Interior casing
- ▶ Ovolo or square profile glazing beads and interior divided lite bars (pg. 201)
- ▶ Prep for stool
- ▶ Class 5 balances available for commercial specifications or larger units
- ▶ Extruded aluminum accessories applied to accessory grooves on the exterior frame (pgs. 206-212)
- ▶ Extension jambs (up to 12" applied, over 12" shipped loose for field application)
- ▶ Segment head, cottage style segment head, half-circle top, and cottage style half-circle top units
- ▶ Factory-installed Window Opening Control Device (WOCD) (pg. 203)
- ▶ Sash limiters for safety
- ▶ Galvanized steel installation clips
- ▶ High performance or impact performance modifications (pg. 205)



A wood wrapped jamb liner closure on the interior (shown) and an extruded aluminum jamb liner closure on the exterior hide the PVC jamb liners.

Traditional Style Sash Lift Handle

(shown in Rustic Umber)



Square Style Sash Lift Handle

(shown in Satin Nickel)



XL Sterling Double Hungs

The award-winning XL Sterling double hung expands the architecturally-correct design and high performance of a Sterling double hung. Quality components combined with thoughtful product design allow the XL Sterling double hung to be the perfect fit for any oversized commercial or residential opening.

Patents: 7,296,381 | 7,448,164 | 8,196,355 | 8,429,856



XL Sterling Double Hung Standard Features

- ▶ 1-3/4" thick sash
- ▶ Overall jamb width is 5" (*basic box width is 5"*)
- ▶ Frame thickness is 3/4" at side jambs and head
- ▶ Sill thickness is 1-3/16"; slope is 14°
- ▶ Constructed of pine, with pine interior stops and wood mull casings on mullied units
- ▶ Exterior wood parts are treated
- ▶ Extruded aluminum exterior finished with a 70% PVDF fluoropolymer coating (*meets performance requirements of AAMA 2605*)
- ▶ Accessory grooves are integral to the extruded frames for the easy addition of accessories
- ▶ Energy efficient, insulating Solar Low-E glass
- ▶ Glazed to the interior with beveled wood glazing beads
- ▶ Wood interior head parting stop
- ▶ Clay-colored heavy duty Signature sash lock
- ▶ Class 5 balances capable of carrying sash up to 200 lbs.
- ▶ Concealed balance system
- ▶ Patented wood wrapped jambliner closure on the interior (*unless interior is prefinished white or primed, then jambliner will be white*) and extruded aluminum jambliner closure on the exterior hide balance system
- ▶ Heavy vinyl nailing fins with head drip caps*

NOTE: All measurements are nominal.

* Standard only on units without brickmould.

Hardware

- ▶ Pick-resistant Signature or Spoon sash lock with a concealed locking system and tilt latches. Available in Clay, White, Beige, Brass, Antique Brass, Satin Nickel, Chrome[†], Brushed Chrome[†], Antique Nickel, Rustic Umber or Matte Black.
- ▶ Curved, square, or traditional style sash lift handles for ease of use. Available in Clay, White, Beige, Brass, Antique Brass, Satin Nickel, Chrome[†], Brushed Chrome[†], Antique Nickel, Rustic Umber or Matte Black.
- ▶ Custodial lock to prohibit unauthorized operation (*not pictured*).
- ▶ Universal design crank handle hardware kit offers ease-of-use for people with physical limitations. Available in White (*not pictured*).

† Chrome and Brushed Chrome finishes are only available on Signature sash locks and curved sash lift handles.

Signature Sash Lock

(shown in Matte Black)



Spoon Sash Lock

(shown in Satin Nickel)



Curved Sash Lift Handle

(shown in Clay)





Photo © Gallop Studios Inc.

Photo courtesy of Kenneth M. Wyner Photography, Inc.



XL Sterling Double Hung Options

Glass (pg. 200)

- ▶ Solar Gain Low-E
- ▶ Solar Advanced Control Low-E
- ▶ Solar Control Low-E
- ▶ ThermaPlus™ Low-E
- ▶ Neat®
- ▶ Triple pane
- ▶ Patterned-, bronze-, or gray-lite
- ▶ Tempered or laminated
- ▶ Other options standard to the industry

Divided Lites (pg. 201)

- ▶ Performance divided lites with 5/8", 7/8", 1-1/8", 1-3/8", 1-3/4", 2-1/4" or 4-1/2" bars
- ▶ Grilles-in-the-airspace

Insect Screens

- ▶ Full or half insect screen with aluminum frame and options for BetterVue® or UltraVue® fiberglass mesh or aluminum mesh; frame will match the exterior color of the unit
- ▶ Retractable insect screen kit with beveled or square cover (pg. 204)

NOTE: All measurements are nominal.

Other Options (custom options are also available)

- ▶ Other wood species and FSC®-certified wood (pg. 198)
- ▶ Interior prefinishing (pg. 198)
- ▶ Interior casing
- ▶ Ovolo or square profile glazing beads and interior divided lite bars (pg. 201)
- ▶ Prep for stool
- ▶ Extruded aluminum accessories applied to accessory grooves on the exterior frame (pgs. 206-212)
- ▶ Extension jambs (up to 12" applied, over 12" shipped loose for field application)
- ▶ Segment head, cottage style segment head, half-circle top, and cottage style half-circle top units
- ▶ Factory-installed Window Opening Control Device (WOCD) (pg. 203)
- ▶ Sash limiters for safety
- ▶ Galvanized steel installation clips
- ▶ High performance or impact performance modifications (pg. 205)

XL Sterling double hungs have the same full-wood appearance as Sterling double hungs; the jambs are concealed by wood jambliner covers.



Traditional Style Sash Lift Handle

(shown in Antique Brass)



Square Style Sash Lift Handle

(shown in Matte Black)



Majesta Double Hungs

Majesta® double hungs are made-to-order in sizes as large as 6 feet wide by 12 feet tall, for the most expansive of openings. The balances are specially made to match the extra large size of the window so it operates easily. The innovative design secures the sash in place.



Majesta Double Hung Standard Features

- ▶ 2-1/4" thick sash
- ▶ Overall jamb width is 6-9/16" (*basic box width is 6-9/16"*)
- ▶ Frame thickness is 3/4" at side jambs and head
- ▶ Sill thickness is 1-3/16"; slope is 14°
- ▶ Top rail is 3", stiles are 2-1/8" and bottom rail is 4-1/8"
- ▶ Constructed of pine, with pine interior head parting stops and side stops
- ▶ Exterior wood parts are treated
- ▶ Horizontal sash parts are constructed with LVL core for added strength
- ▶ Extruded aluminum exterior finished with a 70% PVDF fluoropolymer coating (*meets performance requirements of AAMA 2605*)
- ▶ Accessory grooves are integral to the extruded frames for the easy addition of accessories
- ▶ Energy efficient, insulating Solar Low-E glass
- ▶ Glazed to the interior with beveled wood glazing beads
- ▶ Bright Brass heavy-duty sash locks; top lock eliminates sash drop and is located at the center of the top rail on the top sash; bottom lock is located at the center of the bottom rail on the bottom sash for operating convenience
- ▶ Class 5 balance system capable of carrying sash up to 200 lbs.
- ▶ Concealed jamb liners and balance system, which use a wood-wrapped jamb liner closure on the interior and an aluminum closure on the exterior
- ▶ Heavy vinyl nailing fins with head drip caps*

NOTE: All measurements are nominal.

* Standard only on units without brickmould.

Hardware

- ▶ Standard heavy-duty sash locks are placed on the top rail and the bottom rail. Available in Bright Brass (*standard*), Satin Nickel or Rustic Umber.
- ▶ Keyed custodial lock prohibits unauthorized operation (*not pictured*).
- ▶ Traditional style or curved sash lift handles (*two per sash*). Available in Bright Brass, Satin Nickel or Rustic Umber.
- ▶ Hook and pole device to help unlock and lower the top sash. Available in Bright Brass (*standard*), Rustic Umber and Satin Nickel finishes.

Bottom Rail Turn Knob Lock

(shown in Rustic Umber)

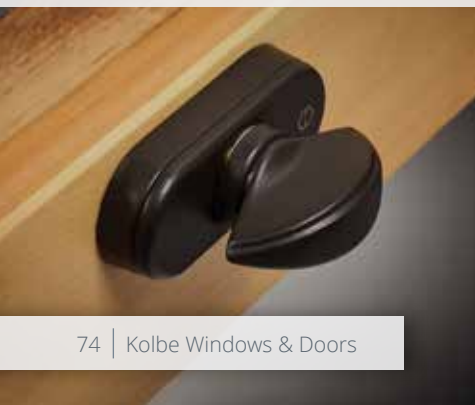

Top Rail Lock

(shown in Rustic Umber)



Traditional Style Sash Lift Handle

(shown in Bright Brass)





Majesta Double Hung Options

Glass (pg. 200)

- ▶ Solar Gain Low-E
- ▶ Solar Advanced Control Low-E
- ▶ Solar Control Low-E
- ▶ ThermaPlus™ Low-E
- ▶ Neat®
- ▶ Triple pane
- ▶ Patterned-, bronze-, or gray-lite
- ▶ Tempered or laminated
- ▶ Other options standard to the industry

Divided Lites (pg. 201)

- ▶ Performance divided lites with 5/8", 7/8", 1-1/8", 1-3/8", 1-3/4", 2-1/4" or 4-1/2" bars
- ▶ Grilles-in-the-airspace

Insect Screens

- ▶ Full or half insect screen with aluminum frame and options for BetterVue® or UltraVue® fiberglass mesh or aluminum mesh; frame will match the exterior color of the unit

NOTE: All measurements are nominal.

Other Options (custom options are also available)

- ▶ Other wood species and FSC®-certified wood (pg. 198)
- ▶ Interior prefinishing (pg. 198)
- ▶ Interior casing
- ▶ Ovolo or square profile glazing beads and interior divided lite bars (pg. 201)
- ▶ Prep for stool
- ▶ Extruded aluminum accessories applied to accessory grooves on the exterior frame (pgs. 206-212)
- ▶ Sash limiters for safety
- ▶ Extension jamb (up to 12" applied, over 12" shipped loose for field application)
- ▶ Segment head, cottage style segment head, half-circle top, and cottage style half-circle top units
- ▶ Galvanized steel installation clips
- ▶ Hook pole device to help unlock and lower the top sash

Concealed wood jamb liners provide a clean look



Curved Sash Lift Handle

(shown in Satin Nickel)

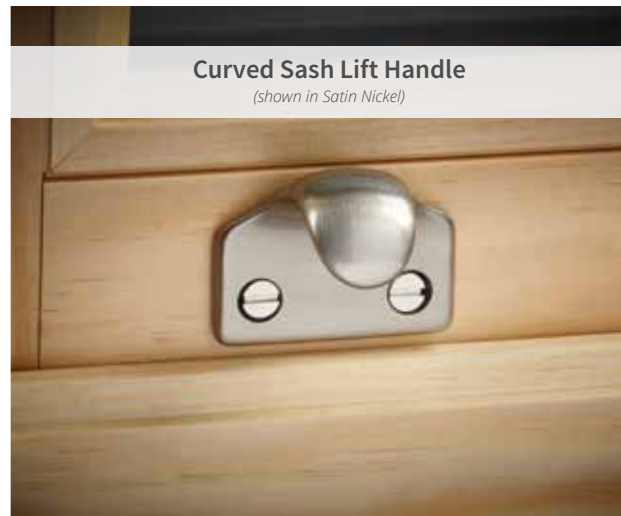

Traditional Double Hungs

Kolbe's Traditional double hungs are an updated version of a classic style. The sloped sill creates a traditional appearance and helps guard against water damage. Traditional double hungs open and close smoothly, and the sash can be tilted in or removed for easy cleaning.



Traditional Double Hung Standard Features

- ▶ 1-3/8" thick sash
- ▶ Overall jamb width is 4-9/16" (*basic box width is 4-9/16"*)
- ▶ Frame thickness is 3/4" at side jambs and head
- ▶ Sill thickness is 1-3/16"; slope is 14°
- ▶ Constructed of pine, with pine interior stops and wood mull casings on mull units
- ▶ Exterior wood parts are treated
- ▶ Extruded aluminum on frame exterior and roll formed aluminum on sash exterior
- ▶ Exterior finished with a 70% PVDF fluoropolymer coating (*meets performance requirements of AAMA 2605*)
- ▶ Accessory grooves are integral to the extruded frames for the easy addition of accessories
- ▶ Energy efficient, insulating Solar Low-E glass
- ▶ Glazed to the interior with beveled wood glazing beads
- ▶ Rigid PVC head parting stop with flexible fins and waterseal at the sill
- ▶ Clay-colored sash lock
- ▶ Machined finger grooves on the top rail of the upper sash and bottom rail of the lower sash
- ▶ Spring-loaded block-and-tackle mechanical balances to carry the sash weight
- ▶ Beige PVC jamb liners with compression foam backing
- ▶ Heavy vinyl nailing fins with head drip caps*
- ▶ Pine-veneered head and seat boards; unique narrow mullions and cable support system on bay units

NOTE: All measurements are nominal.

* Standard only on units without brickmould.

Hardware

- ▶ Sash lock in Clay, White, Beige, Brass, Antique Brass, Satin Nickel, Antique Nickel, Rustic Umber, Oil-Rubbed** or Matte Black.
- ▶ Curved, square, or traditional style sash lift handle for ease of use. Available in Clay, White, Beige, Brass, Antique Brass, Satin Nickel, Antique Nickel, Rustic Umber, Oil-Rubbed** or Matte Black.
- ▶ Universal design crank handle hardware kit offers ease-of-use for people with physical limitations. Available in White (*not pictured*).

**The Oil-Rubbed finish is a living finish, which means that it will change appearance over time with use. The Oil-Rubbed finish is not available on curved sash lift handles.

Sash Lock

(shown in Satin Nickel)

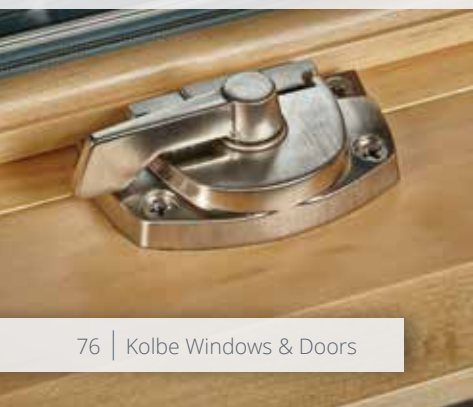

Curved Sash Lift Handle

(shown in Clay)



Traditional Style Sash Lift Handle

(shown in Antique Nickel)





Traditional Double Hung Options

Glass (pg. 200)

- ▶ Solar Gain Low-E
- ▶ Solar Advanced Control Low-E
- ▶ Solar Control Low-E
- ▶ ThermaPlus™ Low-E
- ▶ Neat®
- ▶ Triple pane
- ▶ Patterned-, bronze-, or gray-lite
- ▶ Tempered or laminated
- ▶ Other options standard to the industry

Divided Lites (pg. 201)

- ▶ Performance divided lites with 5/8", 7/8", 1-1/8", 1-3/8", 1-3/4", 2-1/4" or 4-1/2" bars
- ▶ Grilles-in-the-airspace

Insect Screens

- ▶ Full or half insect screen with aluminum frame and options for BetterVue® or UltraVue® fiberglass mesh or aluminum mesh; frame will match the exterior color of the unit

NOTE: All measurements are nominal.

Other Options (custom options are also available)

- ▶ Available as a replacement sash kit
- ▶ Other wood species and FSC®-certified wood (pg. 198)
- ▶ Interior prefinishing (pg. 198)
- ▶ Interior casing
- ▶ Ovolo and square profile glazing beads and interior divided lite bars (pg. 201)
- ▶ Prep for stool
- ▶ Extruded aluminum accessories applied to accessory grooves on the exterior frame (pgs. 206-212)
- ▶ No finger grooves in top, bottom or both sash
- ▶ White jamb liners
- ▶ Extension jambs (up to 12" applied, over 12" shipped loose for field application)
- ▶ Segment head, cottage style segment head, half-circle top, and cottage style half-circle top units
- ▶ Factory-installed Window Opening Control Device (WOCD) (pg. 203)
- ▶ Sash limiters for safety
- ▶ Galvanized steel installation clips
- ▶ Insulated platforms, support brackets and oak-veneered head and seat boards for bay units

Square Style Sash Lift Handle

(shown in Bright Brass)



Pocket Double Hungs

Pocket double hungs are all-in-one replacement window units. Existing trim and framework do not have to be removed before installation, helping to eliminate excess work and potential damage. Not only is installation simplified, but replacing old windows with energy efficient ones saves on heating and cooling costs throughout the year.



Pocket Double Hung Standard Features

- ▶ 1-3/4" thick sash
- ▶ 3-1/4" pocket jamb depth
- ▶ Frame thickness is 3/4" at side jambs and head
- ▶ Sill slope is 7°
- ▶ Constructed of pine, with pine interior stops and wood mull casings on muller units
- ▶ Exterior wood parts are treated
- ▶ Extruded aluminum exterior finished with a 70% PVDF fluoropolymer coating (*meets performance requirements of AAMA 2605*)
- ▶ Accessory grooves are integral to the extruded frames for the easy addition of accessories
- ▶ Energy efficient, insulating Solar Low-E glass
- ▶ Glazed to the interior with beveled wood glazing beads
- ▶ Wood interior head parting stop
- ▶ Clay-colored sash lock
- ▶ Spring-loaded block-and-tackle mechanical balances to carry the sash weight
- ▶ Concealed PVC jamb liners with kerf mount
- ▶ Wood wrapped jamb liner closure on the interior (*unless interior is prefinished white or primed, then jamb liner will be white*) and extruded aluminum jamb liner closure on the exterior hides PVC jamb liners

NOTE: All measurements are nominal.

Hardware

- ▶ Sash lock in Clay, White, Beige, Brass, Antique Brass, Satin Nickel, Antique Nickel, Rustic Umber, Oil-Rubbed* or Matte Black
- ▶ Curved, square, or traditional style sash lift handle for ease of use. Available in Clay, White, Beige, Brass, Antique Brass, Satin Nickel, Antique Nickel, Rustic Umber, Oil-Rubbed* or Matte Black.
- ▶ Universal design crank handle hardware kit offers ease-of-use for people with physical limitations. Available in White (*not pictured*).

*The Oil-Rubbed finish is a living finish, which means that it will change appearance over time with use. The Oil-Rubbed finish is not available on curved sash lift handles.

Sash Lock

(shown in Beige)

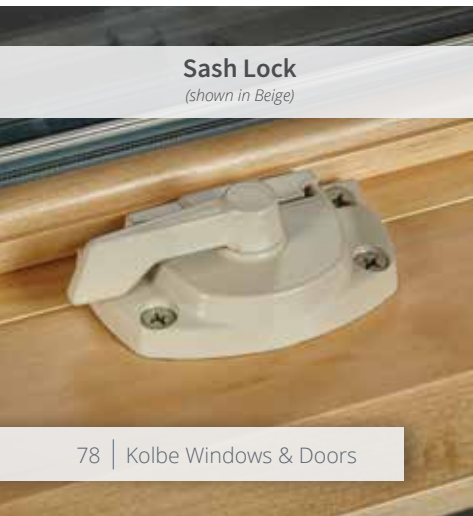

Curved Sash Lift Handle

(shown in Antique Brass)

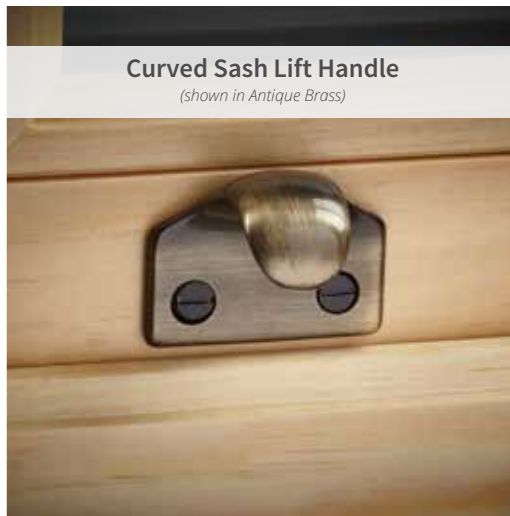

Traditional Style Sash Lift Handle

(shown in Oil-Rubbed*)

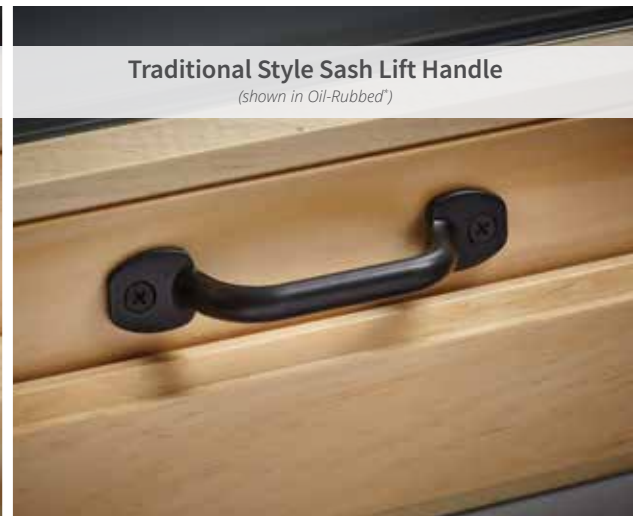



Pocket Double Hung Options

Glass (pg. 200)

- ▶ Solar Gain Low-E
- ▶ Solar Advanced Control Low-E
- ▶ Solar Control Low-E
- ▶ ThermaPlus™ Low-E
- ▶ Neat®
- ▶ Triple pane
- ▶ Patterned-, bronze-, or gray-lite
- ▶ Tempered or laminated
- ▶ Other options standard to the industry

Divided Lites (pg. 201)

- ▶ Performance divided lites with 5/8", 7/8", 1-1/8", 1-3/8", 1-3/4", 2-1/4" or 4-1/2" bars
- ▶ Grilles-in-the-airspace

Insect Screens

- ▶ Full or half insect screen with aluminum frame and options for BetterVue® or UltraVue® fiberglass mesh or aluminum mesh; frame will match the exterior color of the unit

NOTE: All measurements are nominal.

Other Options (custom options are also available)

- ▶ Other wood species and FSC®-certified wood (pg. 198)
- ▶ Interior prefinishing (pg. 198)
- ▶ Interior casing
- ▶ Ovolo and square profile glazing beads and interior divided lite bars (pg. 201)
- ▶ Prep for stool
- ▶ Extruded aluminum accessories applied to accessory grooves on the exterior frame (pgs. 206-212)
- ▶ Extension jambs (up to 12" applied, over 12" shipped loose for field application)
- ▶ Transom and studio units
- ▶ Segment head, cottage style segment head, half-circle top, and cottage style half-circle top units
- ▶ Sash limiters for safety
- ▶ Galvanized steel installation clips

Square Style Sash Lift Handle

(shown in Satin Nickel)



Double Hungs | Elevation Charts

Sterling & Traditional Double Hungs | Single Units

F.S.	1'-9 1/2"	2'-1 1/2"	2'-5 1/2"	2'-7 1/2"	2'-9 1/2"	2'-11 1/2"	3'-1 1/2"	3'-5 1/2"	3'-9 1/2"
R.O.	1'-10"	2'-2"	2'-6"	2'-8"	2'-10"	3'-0"	3'-2"	3'-6"	3'-10"
S.O.	1'-8"	2'-0"	2'-4"	2'-6"	2'-8"	2'-10"	3'-0"	3'-4"	3'-8"
G.S.	16"	20"	24"	26"	28"	30"	32"	36"	40"
3'-0 7/16"									
3'-4 7/16"									
4'-0 7/16"									
4'-4 7/16"									
4'-8 7/16"									
5'-0 7/16"									
5'-4 7/16"									
5'-8 7/16"									
6'-0 7/16"									
6'-4 7/16"									
6'-8 7/16"									

NOTE: All measurements are nominal. Elevation charts are not to scale. Divided lites are optional.

Single units shown are also available as single hung units and replacement sash kits with Traditional sash only.

Some installation procedures will require a larger rough opening than noted (i.e. installations utilizing our installation clips), therefore, you may need to increase the rough opening size accordingly. Rough opening gaps may be increased up to a maximum of 1/2" on all sides and still be within good practice guidelines. For rough opening recommendations, see pg. 216.

The side jambs of double hung units extend above the head jamb; additional space for the rough opening height may be necessary.

Additional and the most current drawings are available at www.kolbewindows.com.

F.S.=Frame Size • R.O. = Rough Opening • S.O. = Sash Opening • G.S. = Glass Size

* Units meet most national emergency escape and rescue requirements

** Only Traditional sash units meet most national emergency escape and rescue requirements

Width Dimensions for Twin Mulled Units



Glass (per-sash)	16"	20"	24"	26"	28"	30"	32"	36"	40"
R.O.	3'-7 1/2"	4'-3 1/2"	4'-11 1/2"	5'-3 1/2"	5'-7 1/2"	5'-11 1/2"	6'-3 1/2"	6'-11 1/2"	7'-7 1/2"
F.S.	3'-7"	4'-3"	4'-11"	5'-3"	5'-7"	5'-11"	6'-3"	6'-11"	7'-7"

Width Dimensions for Triple Mulled Units

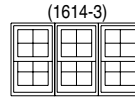

Glass (per-sash)	16"	20"	24"	26"	28"	30"	32"	36"	40"
R.O.	5'-5"	6'-5"	7'-5"	7'-11"	8'-5"	8'-11"	9'-5"	10'-5"	11'-5"
F.S.	5'-4 1/2"	6'-4 1/2"	7'-4 1/2"	7'-10 1/2"	8'-4 1/2"	8'-10 1/2"	9'-4 1/2"	10'-4 1/2"	11'-4 1/2"

Sterling & Traditional Double Hungs | Cottage Style

F.S.	1'-9 1/2"	2'-1 1/2"	2'-5 1/2"	2'-7 1/2"	2'-9 1/2"	2'-11 1/2"	3'-1 1/2"	3'-5 1/2"	3'-9 1/2"
R.O.	1'-10"	2'-2"	2'-6"	2'-8"	2'-10"	3'-0"	3'-2"	3'-6"	3'-10"
S.O.	1'-8"	2'-0"	2'-4"	2'-6"	2'-8"	2'-10"	3'-0"	3'-4"	3'-8"
G.S.	16"	20"	24"	26"	28"	30"	32"	36"	40"
	1624/36	2024/36	2424/36	2624/36	2824/36	3024/36	3224/36	3624/36	4024/36

F.S.=Frame Size • R.O. = Rough Opening • S.O. = Sash Opening • G.S. = Glass Size

Dimension Calculations

	Width	Height
F.S. to S.O.	-1 1/2"	-2 7/16"
S.O. to G.S.	-4"	-6"÷2
G.S. to D.L.O.	-1"	-1"

Notes: Clear opening dimensions can be found on pgs. 219-222.
Cottage style dimension calculations are different; consult your dealer.

F.S. = Frame Size • G.S. = Glass Size • O.S.M. = Outside Measurement
D.L.O. = Daylight Opening • U.D. = Unit Dimension

NOTE: All measurements are nominal. Elevation charts are not to scale. Divided lites are optional.

Some installation procedures will require a larger rough opening than noted (i.e. installations utilizing our installation clips), therefore, you may need to increase the rough opening size accordingly. Rough opening gaps may be increased up to a maximum of 1/2" on all sides and still be within good practice guidelines.

The side jambs of double hung units extend above the head jamb; additional space for the rough opening height may be necessary. For rough opening recommendations, see pg. 216.

Additional and the most current drawings are available at www.kolbewindows.com.

Double Hungs | Elevation Charts

Double Hungs | Rectangular Transoms

	1'-9 1/2"	2'-1 1/2"	2'-5 1/2"	2'-9 1/2"	3'-1 1/2"	3'-5 1/2"	3'-9 1/2"
F.S.	1'-10"	2'-2"	2'-6"	2'-10"	3'-2"	3'-6"	3'-10"
R.O.	1'-8"	2'-0"	2'-4"	2'-8"	3'-0"	3'-4"	3'-8"
S.O.	16"	20"	24"	28"	32"	36"	40"
G.S.							
11 1/2"							
1'-0"							
10"							
1'-3 1/2"							
1'-4"							
10"							
1'-5 1/2"							
1'-6"							
16"							
12"							
1'-7 1/2"							
1'-8"							
18"							
14"							
1'-11 1/2"							
2'-0"							
22"							
18"							
2'-5 1/2"							
2'-6"							
28"							
24"							

F.S. = Frame Size • R.O. = Rough Opening • S.O. = Sash Opening • G.S. = Glass Size

NOTE: All measurements are nominal. These dimensions apply only for transoms with flat sills. Contact your supplier for dimensions of units with beveled sills. Elevation charts are not to scale. Divided lites are optional.

The units shown are stand-alone units. Adjustments may be required when stacking over other units; adjustments will be made in the factory.

Transom units are only available with a 1-3/4" sash. Specify roll-formed or extruded aluminum sash when ordering.































































Some installation procedures will require a larger rough opening than noted (i.e. installations utilizing our installation clips), therefore, you may need to increase the rough opening size accordingly. Rough opening gaps may be increased up to a maximum of 1/2" on all sides and still be within good practice guidelines. For rough opening recommendations, see pg. 216.

The side jambs of double hung units extend above the head jamb; additional space for the rough opening height may be necessary.

For pocket double hung transoms, talk to your local Kolbe dealer.

Additional and the most current drawings are available at www.kolbewindows.com.

Double Hungs | Studio Units

	4'-1 1/2"	4'-5 1/2"	5'-1 1/2"	5'-9 1/2"	6'-5 1/2"	7'-1 1/2"	8'-5 1/2"
F.S.	4'-1 1/2"	4'-5 1/2"	5'-1 1/2"	5'-9 1/2"	6'-5 1/2"	7'-1 1/2"	8'-5 1/2"
R.O.	4'-2"	4'-6"	5'-2"	5'-10"	6'-6"	7'-2"	8'-6"
S.O.	4'-0"	4'-4"	5'-0"	5'-8"	6'-4"	7'-0"	8'-4"
G.S.	44 1/2"	48 1/2"	56 1/2"	64 1/2"	72 1/2"	80 1/2"	96 1/2"
4'-0 7/16"							
	S40310	S44310	S50310	S58310	S64310	S70310	S84310
4'-4 7/16"							
	S4042	S4442	S5042	S5842	S6442	S7042	S8442
4'-8 7/16"							
	S4046	S4446	S5046	S5846	S6446	S7046	S8446
5'-0 7/16"							
	S40410	S44410	S50410	S58410	S64410	S70410	S84410
5'-4 7/16"							
	S4052	S4452	S5052	S5852	S6452	S7052	S8452
5'-8 7/16"							
	S4056	S4456	S5056	S5856	S6456	S7056	S8456
6'-0 7/16"							
	S40510	S44510	S50510	S58510	S64510	S70510	S84510
6'-4 7/16"							
	S4062	S4462	S5062	S5862	S6462	S7062	S8462
6'-8 7/16"							
	S4066	S4466	S5066	S5866	S6466	S7066	S8466

* To match cottage style double hungs with divided lites, 5'-6" high (S.O.) units must be ordered 5 lites high
 F.S. = Frame Size • R.O. = Rough Opening • S.O. = Sash Opening • G.S. = Glass Size

NOTE: All measurements are nominal. Elevation charts are not to scale. Divided lites are optional.

Studio units are only available with a 1-3/4" sash. Specify roll-formed or extruded aluminum sash when ordering.

Some installation procedures will require a larger rough opening than noted (i.e. installations utilizing our installation clips), therefore, you may need to increase the rough opening size accordingly. Rough opening gaps may be increased up to a maximum of 1/2" on all sides and still be within good practice guidelines.

For rough opening recommendations, see pg. 216.

The side jambs of double hung units extend above the head jamb; additional space for the rough opening height may be necessary.

For pocket double hung studio units, talk to your local Kolbe dealer.







Additional and the most current drawings are available at www.kolbewindows.com.

Double Hungs | Elevation Charts

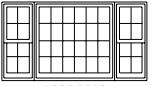
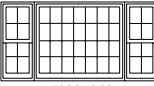
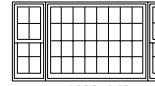
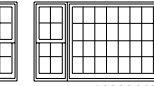
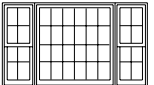
Sterling & Traditional Double Hungs | Picture Units

16" flankers

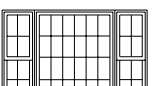
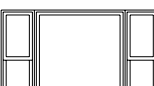

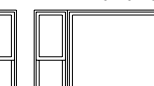



F.S.	8'-0 1/2"	8'-8 1/2"	9'-4 1/2"	10'-0 1/2"
R.O.	8'-1"	8'-9"	9'-5"	10'-1"
S.O.	1'-8" 4'-4" 1'-8"	1'-8" 5'-0" 1'-8"	1'-8" 5'-8" 1'-8"	1'-8" 6'-4" 1'-8"
G.S.	16" 48 1/2" 16"	16" 56 1/2" 16"	16" 64 1/2" 16"	16" 72 1/2" 16"

4'-4 7/16"	4'-5"	4'-2"	22" 45 1/4"				
16224442	16225042	16225842	16226442				
4'-8 7/16"	4'-9"	4'-6"	24" 49 1/4"				
16244446	16245046	16245846	16246446				
5'-5 7/16"	5'-5"	5'-2"	28" 57 1/4"				
16284452	16285052	16285852	16286452				

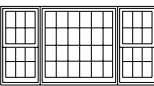
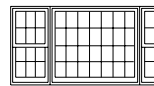
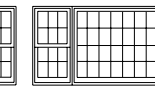
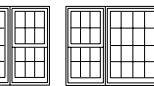
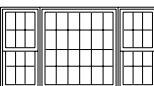
Sterling & Traditional Double Hungs | Picture Units

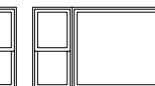
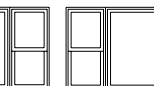
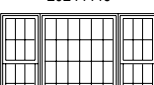
20" flankers

F.S.	8'-8 1/2"	9'-4 1/2"	10'-0 1/2"	10'-8 1/2"
R.O.	8'-9"	9'-5"	10'-1"	10'-9"
S.O.	2'-0" 4'-4" 2'-0"	2'-0" 5'-0" 2'-0"	2'-0" 5'-8" 2'-0"	2'-0" 6'-4" 2'-0"
G.S.	20" 48 1/2" 20"	20" 56 1/2" 20"	20" 64 1/2" 20"	20" 72 1/2" 20"

4'-4 7/16"	4'-5"	4'-2"	22" 45 1/4"				
20224442	20225042	20225842	20226442				
4'-8 7/16"	4'-9"	4'-6"	24" 49 1/4"				
20244446	20245046	20245846	20246446				
5'-5 7/16"	5'-5"	5'-2"	28" 57 1/4"				
20284452	20285052	20285852	20286452				

* The first number of the glass size height is the height (per sash) for each flanker sash. The second number is the glass height for the center picture unit.
 F.S. = Frame Size • R.O. = Rough Opening • S.O. = Sash Opening • G.S. = Glass Size

NOTE: All measurements are nominal. Elevation charts are not to scale. Divided lites are optional.

Center picture units are only available with a 1-3/4" sash. Flanker sash must be specified as either Traditional or Sterling sash when ordering.

Some installation procedures will require a larger rough opening than noted (i.e. installations utilizing our installation clips), therefore, you may need to increase the rough opening size accordingly. Rough opening gaps may be increased up to a maximum of 1/2" on all sides and still be within good practice guidelines. For rough opening recommendations, see pg. 216.

The side jambs of double hung units extend above the head jamb; additional space for the rough opening height may be necessary.

Additional and the most current drawings are available at www.kolbewindows.com.

Sterling & Traditional Double Hungs | Picture Units

24" flankers

F.S.	9'-4 1/2"	10'-0 1/2"	10'-8 1/2"	11'-4 1/2"
R.O.	9'-5"	10'-1"	10'-9"	11'-5"
S.O.	2'-4" 4'-4" 2'-4"	2'-4" 5'-0" 2'-4"	2'-4" 5'-8" 2'-4"	2'-4" 6'-4" 2'-4"
G.S.*	24" 48 1/2" 24"	24" 56 1/2" 24"	24" 64 1/2" 24"	24" 72 1/2" 24"

4'-4 7/16"	4'-5"	4'-2"	22" 45 1/4"				
24224442	24225042	24225842	24226442				
4'-8 7/16"	4'-9"	4'-6"	24" 49 1/4"				
24244446	24245046	24245846	24246446				
5'-5 7/16"	5'-5"	5'-2"	28" 57 1/4"				
24284452	24285052	24285852	24286452				

* The first number of the glass size height is the height (per sash) for each flanker sash. The second number is the glass height for the center picture unit.
 F.S. = Frame Size • R.O. = Rough Opening • S.O. = Sash Opening • G.S. = Glass Size

NOTE: All measurements are nominal. Elevation charts are not to scale. Divided lites are optional.

Center picture units are only available with a 1-3/4" sash. Flanker sash must be specified as either Traditional or Sterling sash when ordering.

Some installation procedures will require a larger rough opening than noted (i.e. installations utilizing our installation clips), therefore, you may need to increase the rough opening size accordingly. Rough opening gaps may be increased up to a maximum of 1/2" on all sides and still be within good practice guidelines. For rough opening recommendations, see pg. 216.

The side jambs of double hung units extend above the head jamb; additional space for the rough opening height may be necessary.

Additional and the most current drawings are available at www.kolbewindows.com.

Double Hungs | Elevation Charts

Sterling & Traditional Double Hungs | 30° Bay Windows

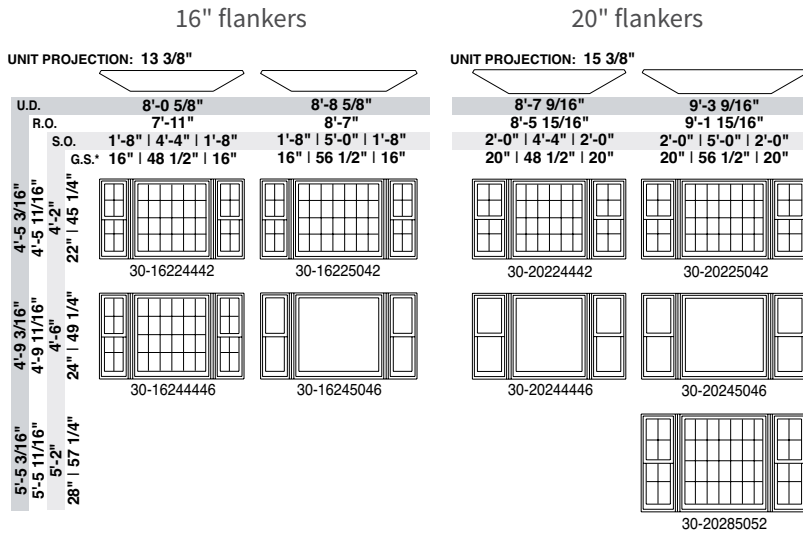

Sterling & Traditional Double Hungs | 45° Bay Windows

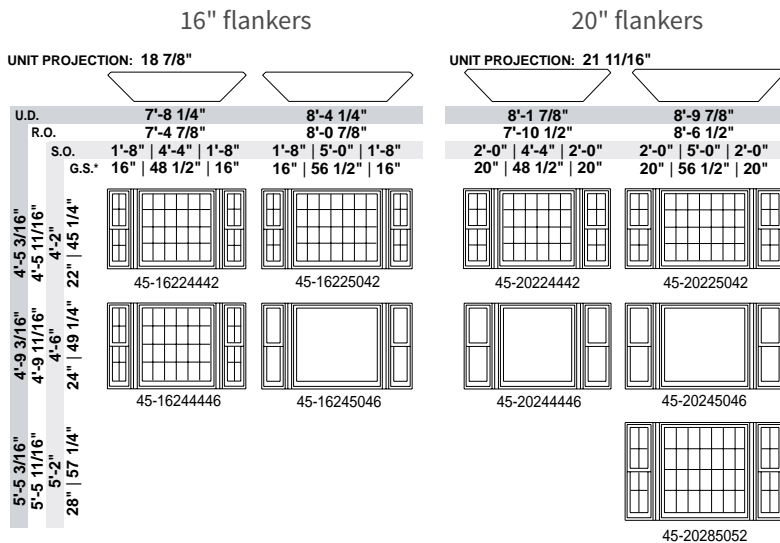

* The first number of the glass size height is the height (per sash) for each flanker sash. The second number is the glass height for the center picture unit.
 U.D. = Unit Dimension • R.O. = Rough Opening • S.O. = Sash Opening • G.S. = Glass Size

NOTE: All measurements are nominal. Elevation charts are not to scale. Divided lites are optional.
 Center picture units are only available with a 1-3/4" sash. Flanker sash must be specified as either Traditional or Sterling sash when ordering.
 If the cable support system and/or insulated platforms and support brackets are not being used, other means of proper support must be used. Add 1-13/16" to the R.O. height if an insulated platform is being used. R.O.'s for bay units without head and seat boards, typically used for walk-out applications, are different.
 Some installation procedures will require a larger rough opening than noted (i.e. installations utilizing our installation clips), therefore, you may need to increase the rough opening size accordingly. Rough opening gaps may be increased up to a maximum of 1/2" on all sides and still be within good practice guidelines.
 For rough opening recommendations, see pg. 216.
 The side jambs of double hung units extend above the head jamb; additional space for the rough opening height may be necessary.
 Additional and the most current drawings are available at www.kolbewindows.com.

Segment Head Sterling Double Hungs

F.S.	1'-9 1/2"	2'-1 1/2"	2'-5 1/2"	2'-7 1/2"	2'-9 1/2"	2'-11 1/2"	3'-1 1/2"	3'-5 1/2"	3'-9 1/2"
R.O.	1'-10"	2'-2"	2'-6"	2'-8"	2'-10"	3'-0"	3'-2"	3'-6"	3'-10"
S.O.	1'-8"	2'-0"	2'-4"	2'-6"	2'-8"	2'-10"	3'-0"	3'-4"	3'-8"
G.S.	16"	20"	24"	26"	28"	30"	32"	36"	40"
3'-0 7/16"	3'-1"	3'-1"	3'-1"	3'-1"	3'-1"	3'-1"	3'-1"	3'-1"	3'-1"
3'-4 7/16"	3'-5"	3'-5"	3'-5"	3'-5"	3'-5"	3'-5"	3'-5"	3'-5"	3'-5"
4'-0 7/16"	4'-1"	4'-1"	4'-1"	4'-1"	4'-1"	4'-1"	4'-1"	4'-1"	4'-1"
4'-4 7/16"	4'-5"	4'-5"	4'-5"	4'-5"	4'-5"	4'-5"	4'-5"	4'-5"	4'-5"
4'-8 7/16"	4'-9"	4'-9"	4'-9"	4'-9"	4'-9"	4'-9"	4'-9"	4'-9"	4'-9"
5'-0 7/16"	5'-1"	5'-1"	5'-1"	5'-1"	5'-1"	5'-1"	5'-1"	5'-1"	5'-1"
5'-4 7/16"	5'-5"	5'-5"	5'-5"	5'-5"	5'-5"	5'-5"	5'-5"	5'-5"	5'-5"
5'-8 7/16"	5'-9"	5'-9"	5'-9"	5'-9"	5'-9"	5'-9"	5'-9"	5'-9"	5'-9"
6'-0 7/16"	6'-1"	6'-1"	6'-1"	6'-1"	6'-1"	6'-1"	6'-1"	6'-1"	6'-1"
6'-4 7/16"	6'-5"	6'-5"	6'-5"	6'-5"	6'-5"	6'-5"	6'-5"	6'-5"	6'-5"
6'-8 7/16"	6'-9"	6'-9"	6'-9"	6'-9"	6'-9"	6'-9"	6'-9"	6'-9"	6'-9"
	1614-SEG	2014-SEG	2414-SEG	2614-SEG	2814-SEG	3014-SEG	3214-SEG	3614-SEG	4014-SEG
	1616-SEG	2016-SEG	2416-SEG	2616-SEG	2816-SEG	3016-SEG	3216-SEG	3616-SEG	4016-SEG
	1620-SEG	2020-SEG	2420-SEG	2620-SEG	2820-SEG	3020-SEG	3220-SEG	3620-SEG	4020-SEG
	1622-SEG	2022-SEG	2422-SEG	2622-SEG	2822-SEG	3022-SEG	3222-SEG	3622-SEG	4022-SEG
	1624-SEG	2024-SEG	2424-SEG	2624-SEG	2824-SEG	3024-SEG	3224-SEG	3624-SEG	4024-SEG
	1626-SEG	2026-SEG	2426-SEG	2626-SEG	2826-SEG	3026-SEG	3226-SEG	3626-SEG	4026-SEG
	1628-SEG	2028-SEG	2428-SEG	2628-SEG	2828-SEG	3028-SEG	3228-SEG	3628-SEG	4028-SEG
	1630-SEG	2030-SEG	2430-SEG	2630-SEG	2830-SEG	3030-SEG	3230-SEG	3630-SEG	4030-SEG
	1632-SEG	2032-SEG	2432-SEG	2632-SEG	2832-SEG	3032-SEG	3232-SEG	3632-SEG	4032-SEG
	1634-SEG	2034-SEG	2434-SEG	2634-SEG	2834-SEG	3034-SEG	3234-SEG	3634-SEG	4034-SEG
	1636-SEG	2036-SEG	2436-SEG	2636-SEG	2836-SEG	3036-SEG	3236-SEG	3636-SEG	4036-SEG

F.S. = Frame Size • R.O. = Rough Opening
S.O. = Sash Opening • G.S. = Glass Size

NOTE: All measurements are nominal. Elevation charts are not to scale. Divided lites are optional.



























































































Venting is viewed from the exterior. Single units shown are also available as single hung units and replacement sash kits with Traditional sash only.

The side jambs of double hung units extend above the head jamb; additional space for the rough opening height may be necessary.

Additional and the most current drawings are available at www.kolbwindows.com.

Double Hungs | Elevation Charts

Half-Circle Top Sterling Double Hungs

F.S.	1'-9 1/2"	2'-1 1/2"	2'-5 1/2"	2'-7 1/2"	2'-9 1/2"	2'-11 1/2"	3'-1 1/2"	3'-5 1/2"	3'-9 1/2"
R.O.	1'-10"	2'-2"	2'-6"	2'-8"	2'-10"	3'-0"	3'-2"	3'-6"	3'-10"
S.O.	1'-8"	2'-0"	2'-4"	2'-6"	2'-8"	2'-10"	3'-0"	3'-4"	3'-8"
G.S.	16"	20"	24"	26"	28"	30"	32"	36"	40"
3'-0 1/2" 3'-1 1/16" 2'-10" 14"	 1614-HC	 2014-HC	 2414-HC	 2614-HC					
3'-4 1/2" 3'-5 1/16" 3'-2" 16"	 1616-HC	 2016-HC	 2416-HC	 2616-HC	 2816-HC	 3016-HC			
4'-0 1/2" 4'-1 1/16" 3'-10" 20"	 1620-HC	 2020-HC	 2420-HC	 2620-HC	 2820-HC	 3020-HC	 3220-HC	 3620-HC	
4'-4 1/2" 4'-5 1/16" 4'-2" 22"	 1622-HC	 2022-HC	 2422-HC	 2622-HC	 2822-HC	 3022-HC	 3222-HC	 3622-HC	 4022-HC
4'-8 1/2" 4'-9 1/16" 4'-6" 24"	 1624-HC	 2024-HC	 2424-HC	 2624-HC	 2824-HC	 3024-HC	 3224-HC	 3624-HC	 4024-HC
5'-0 1/2" 5'-1 1/16" 4'-10" 26"	 1626-HC	 2026-HC	 2426-HC	 2626-HC	 2826-HC	 3026-HC	 3226-HC	 3626-HC	 4026-HC
5'-4 1/2" 5'-5 1/16" 5'-2" 28"	 1628-HC	 2028-HC	 2428-HC	 2628-HC	 2828-HC	 3028-HC	 3228-HC	 3628-HC	 4028-HC
5'-8 1/2" 5'-9 1/16" 5'-6" 30"	 1630-HC	 2030-HC	 2430-HC	 2630-HC	 2830-HC	 3030-HC	 3230-HC	 3630-HC	 4030-HC
6'-0 1/2" 6'-1 1/16" 5'-10" 32"	 1632-HC	 2032-HC	 2432-HC	 2632-HC	 2832-HC	 3032-HC	 3232-HC	 3632-HC	 4032-HC
6'-4 1/2" 6'-5 1/16" 6'-2" 34"	 1634-HC	 2034-HC	 2434-HC	 2634-HC	 2834-HC	 3034-HC	 3234-HC	 3634-HC	 4034-HC
6'-8 1/2" 6'-9 1/16" 6'-6" 36"	 1636-HC	 2036-HC	 2436-HC	 2636-HC	 2836-HC	 3036-HC	 3236-HC	 3636-HC	 4036-HC

NOTE: All measurements are nominal. Elevation charts are not to scale. Divided lites are optional.

The venting of the bottom sash of half-circle top units is limited due to the radius of the top sash.

Approximate glass sizes per sash are given; true glass sizes vary depending on the radius involved.







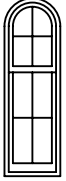

The side jambs of double hung units extend above the head jamb; additional space for the rough opening height may be necessary.

Additional and the most current drawings are available at www.kolbewindows.com.

F.S. = Frame Size • R.O. = Rough Opening • S.O. = Sash Opening • G.S. = Glass Size



Half-Circle Top Sterling Single Hungs | Cottage Style

F.S.	1'-9 1/2"	2'-1 1/2"	2'-5 1/2"	2'-7 1/2"	2'-9 1/2"	2'-11 1/2"	3'-1 1/2"	3'-5 1/2"	3'-9 1/2"
R.O.	1'-10"	2'-2"	2'-6"	2'-8"	2'-10"	3'-0"	3'-2"	3'-6"	3'-10"
S.O.	1'-8"	2'-0"	2'-4"	2'-6"	2'-8"	2'-10"	3'-0"	3'-4"	3'-8"
G.S.	16"	20"	24"	26"	28"	30"	32"	36"	40"

<div style="display: flex; flex-direction: column; align-items: center;"> <div style="margin-bottom: 5px;">5'-8 7/16"</div> <div style="margin-bottom: 5px;">5'-9 1/16"</div> <div style="margin-bottom: 5px;">5'-6"</div> <div>36" / 24"</div> </div>	 1624/36-HC	 2024/36-HC	 2424/36-HC	 2624/36-HC	 2824/36-HC	 3024/36-HC	 3224/36-HC	 3624/36-HC	 4024/36-HC
--	---	---	---	---	---	---	---	---	---

Segment Head Sterling Single Hungs | Cottage Style

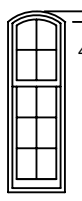
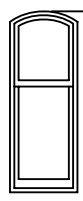
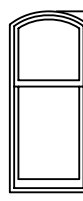
F.S.	1'-9 1/2"	2'-1 1/2"	2'-5 1/2"	2'-7 1/2"	2'-9 1/2"	2'-11 1/2"	3'-1 1/2"	3'-5 1/2"	3'-9 1/2"
R.O.	1'-10"	2'-2"	2'-6"	2'-8"	2'-10"	3'-0"	3'-2"	3'-6"	3'-10"
S.O.	1'-8"	2'-0"	2'-4"	2'-6"	2'-8"	2'-10"	3'-0"	3'-4"	3'-8"
G.S.*	16"	20"	24"	26"	28"	30"	32"	36"	40"

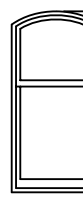
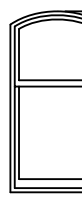
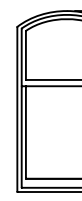
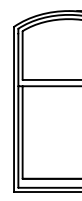
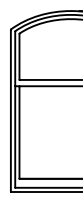
<div style="display: flex; flex-direction: column; align-items: center;"> <div style="margin-bottom: 5px;">5'-8 7/16"</div> <div style="margin-bottom: 5px;">5'-9"</div> <div style="margin-bottom: 5px;">5'-6"</div> <div>36" / 24"</div> </div>	 1624/36 SEG	 2024/36 SEG	 2424/36 SEG	 2624/36 SEG	 2824/36 SEG	 3024/36-SEG	 3224/36-SEG	 3624/36-SEG	 4024/36-SEG
---	--	--	--	--	--	---	---	---	---

F.S. = Frame Size • R.O. = Rough Opening • S.O. = Sash Opening • G.S. = Glass Size

* Approximate glass sizes per sash are given; true glass sizes vary depending on the radius involved

NOTE: All measurements are nominal. Elevation charts are not to scale. Divided lites are optional.

The venting of the bottom sash of half-circle top units is limited due to the radius on the top sash.

Some installation procedures will require a larger rough opening than noted (i.e. installations utilizing our installation clips), therefore, you may need to increase the rough opening size accordingly. Rough opening gaps may be increased up to a maximum of 1/2" on all sides and still be within good practice guidelines.

For rough opening recommendations, see pg. 216.

The side jambs of double hung units extend above the head jamb; additional space for the rough opening height may be necessary.

Additional and the most current drawings are available at www.kolbewindows.com.

Double Hungs | Elevation Charts

Segment Head Sterling Double Hungs | Studio Units

	4'-1 1/2"	4'-5 1/2"	5'-1 1/2"	5'-9 1/2"	6'-5 1/2"	7'-1 1/2"	8'-5 1/2"
F.S.	4'-2"	4'-6"	5'-2"	5'-10"	6'-6"	7'-2"	8'-6"
R.O.	4'-0"	4'-4"	5'-0"	5'-8"	6'-4"	7'-0"	8'-4"
S.O.	44 1/2"	48 1/2"	56 1/2"	64 1/2"	72 1/2"	80 1/2"	96 1/2"
G.S.							
4'-0 7/16"							
4'-4 7/16"							
4'-8 7/16"							
5'-0 7/16"							
5'-4 7/16"							
5'-8 7/16"							
6'-0 7/16"							
6'-4 7/16"							
6'-8 7/16"							

F.S. = Frame Size • R.O. = Rough Opening • S.O. = Sash Opening • G.S. = Glass Size

NOTE: All measurements are nominal. Elevation charts are not to scale. Divided lites are optional. The side jambs of double hung units extend above the head jamb; additional space for the rough opening height may be necessary. Approximate glass sizes per sash are given; true glass sizes vary depending on the radius involved. Additional and the most current drawings are available at www.kolbewindows.com.

Double Hungs | Cross Section Drawings

Sterling Double Hungs

Horizontal Section

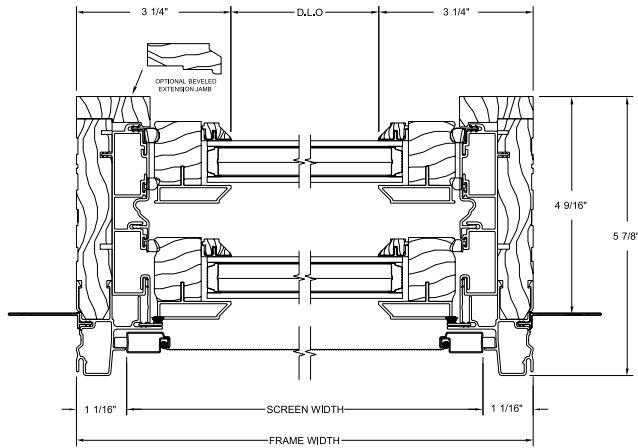

Vertical Section

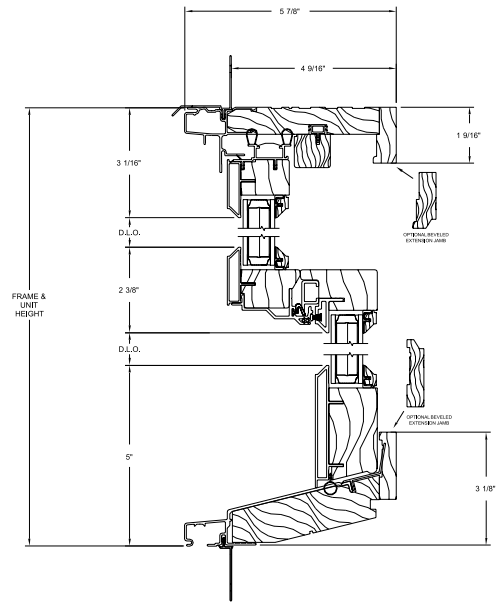

Sterling Double Hungs with 1-15/16" Brickmould & 6-9/16" Jamb

Horizontal Section

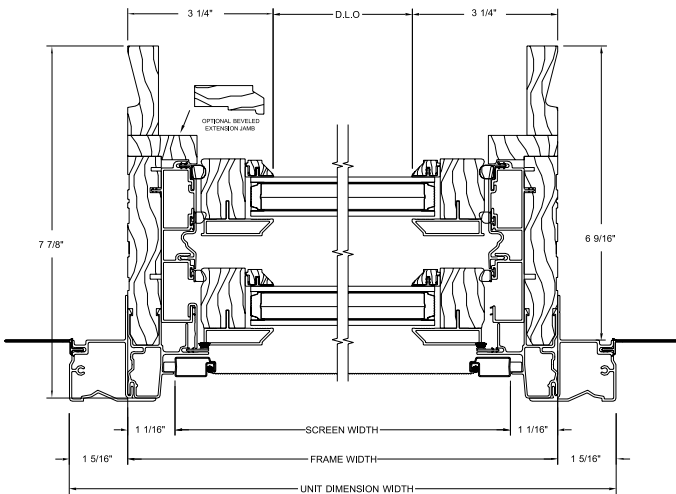

Vertical Section

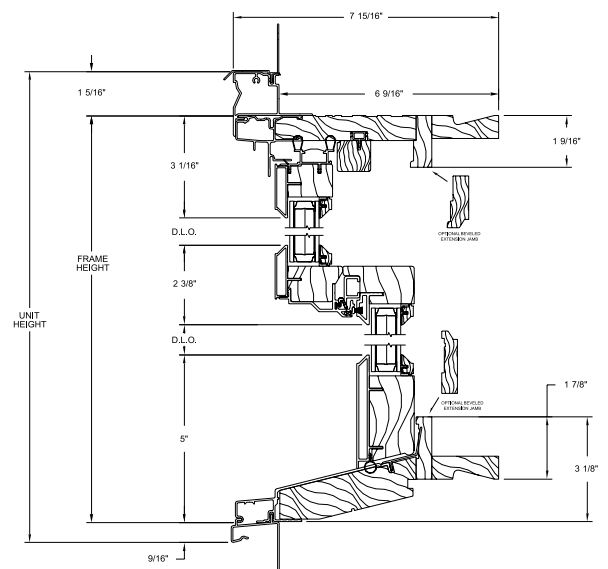

NOTE: Drawings are not to scale. Brickmould is shown factory-applied. Brickmould may be shipped loose for field application. Some units are shown with optional drip cap or nailing fin. For Ultra accessory or application drawings, see pgs. 206-212. Additional and the most current drawings are available at www.kolbewindows.com.

Double Hungs | Cross Section Drawings

Sterling Double Hungs | Operating

2" Spread Mullion

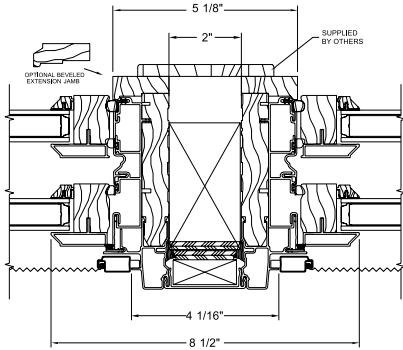

Mullion Details

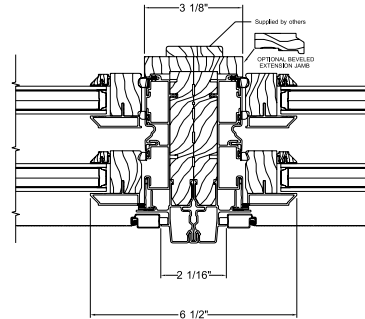

Transom Stacked Above Fixed/Operating

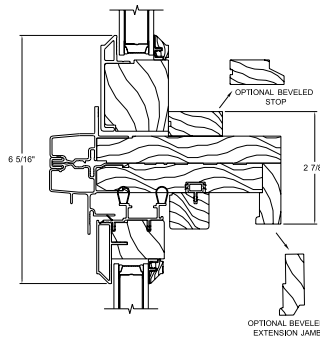

Sterling Studio Units

Horizontal Section

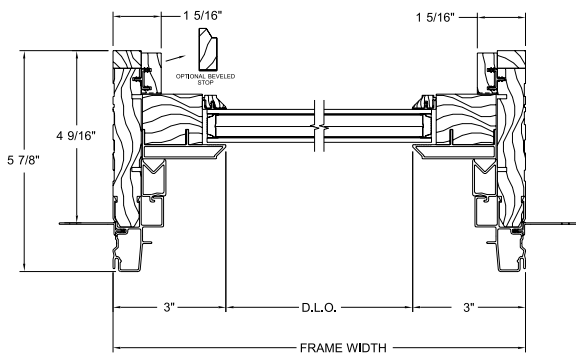

Vertical Section

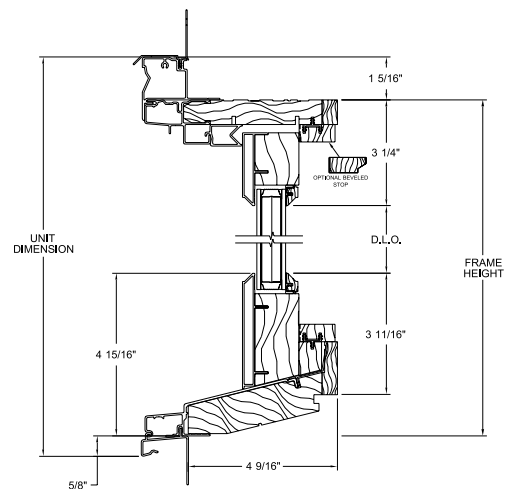

NOTE: Drawings are not to scale. Brickmould is shown factory-applied. Brickmould may be shipped loose for field application. Some units are shown with optional drip cap or nailing fin. For Ultra accessory or application drawings, see pgs. 206-212. Additional and the most current drawings are available at www.kolbewindows.com.

XL Sterling Double Hungs | Operating

Horizontal Section

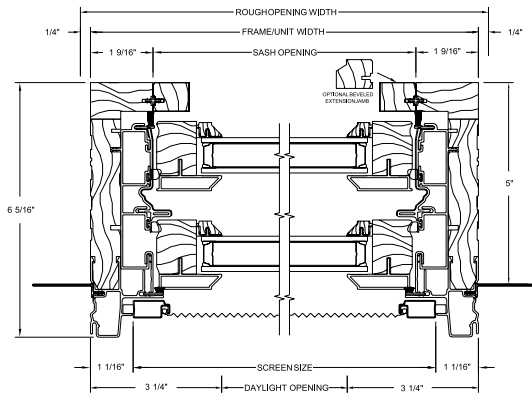

Vertical Section

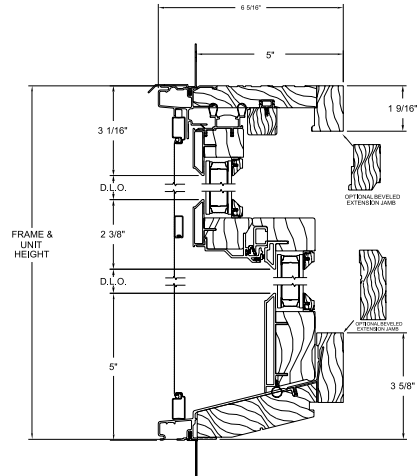

Transom Stacked Above

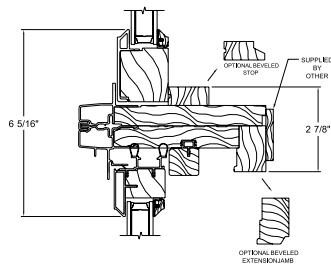

XL Sterling Studio Units

Horizontal Section

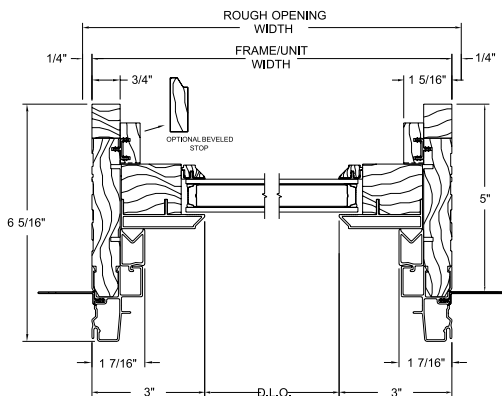

Vertical Section

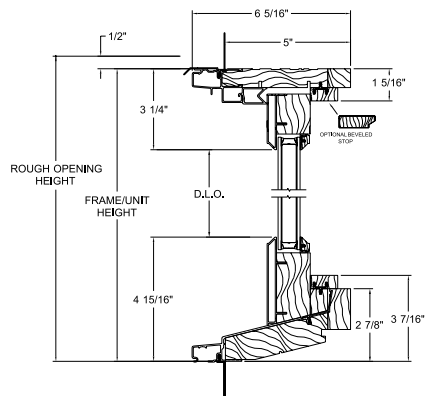

NOTE: Drawings are not to scale. Brickmould is shown factory-applied. Brickmould may be shipped loose for field application. Some units are shown with optional drip cap or nailing fin. For Ultra accessory or application drawings, see pgs. 206-212. Additional and the most current drawings are available at www.kolbewindows.com.

Double Hungs | Cross Section Drawings

Majesta® Double Hungs

Horizontal Section

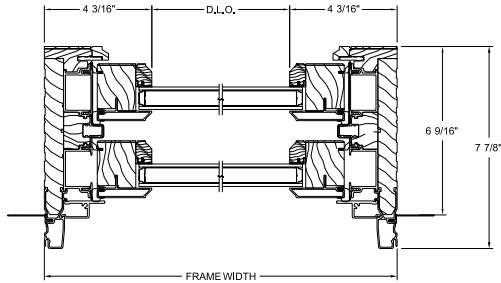

Vertical Section

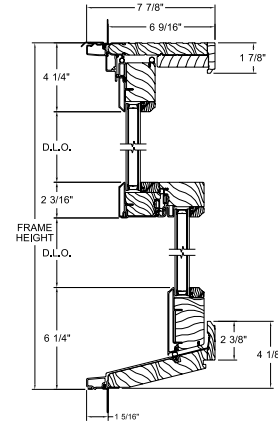

Transom Stacked Above

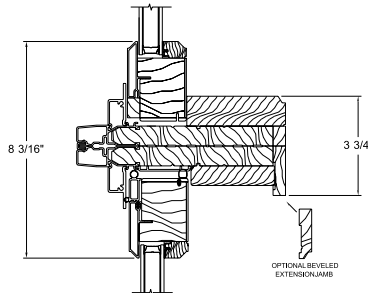

Majesta® Double Hungs | Triple Pane Glass

Horizontal Section

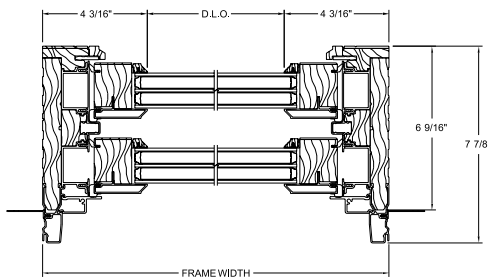

Vertical Section

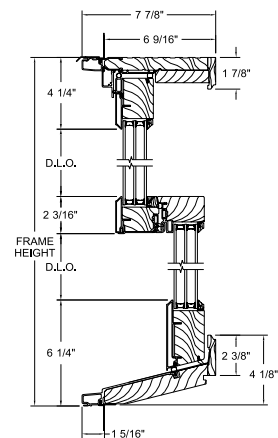

NOTE: Drawings are not to scale. Additional and the most current drawings are available at www.kolbewindows.com.

Traditional Double Hungs | Operating

Horizontal Section

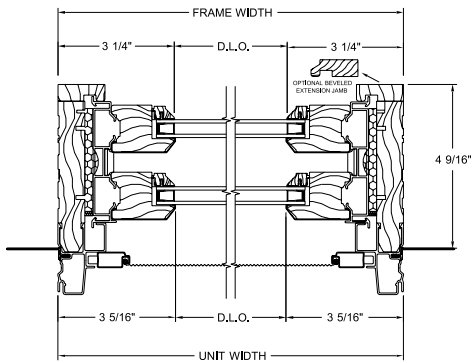

Vertical Section

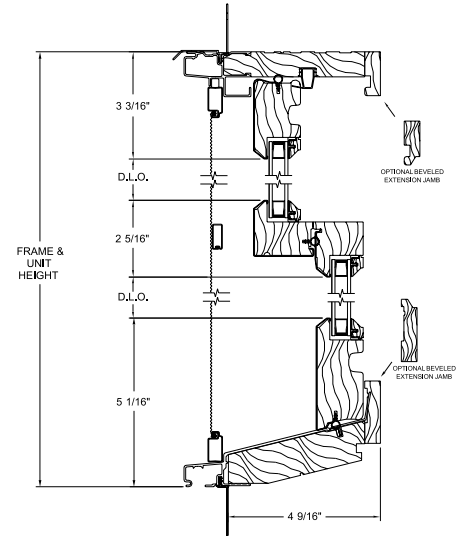

Transom Stacked Above

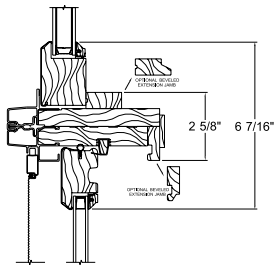

2" Spread Mull

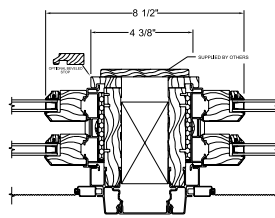

Mullion Details

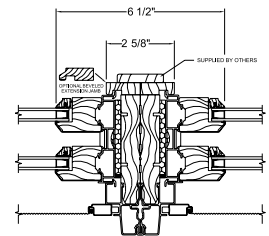

Traditional Double Hung | Studio Units

Horizontal Section

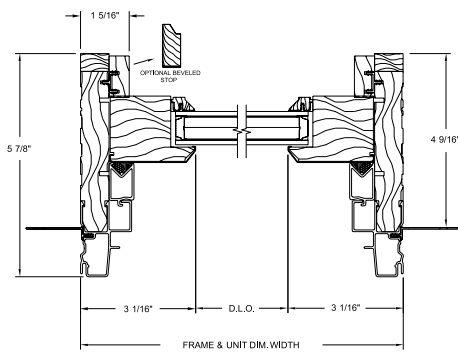

Vertical Section

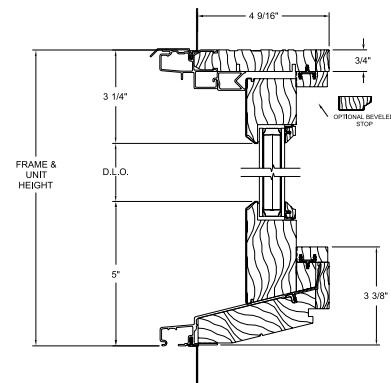

NOTE: Drawings are not to scale. Brickmould may be shipped loose for field application. Additional and the most current drawings are available at www.kolbewindows.com.

Double Hungs | Cross Section Drawings

Double Hung Bays

Sterling

30° Bay Horizontal Section

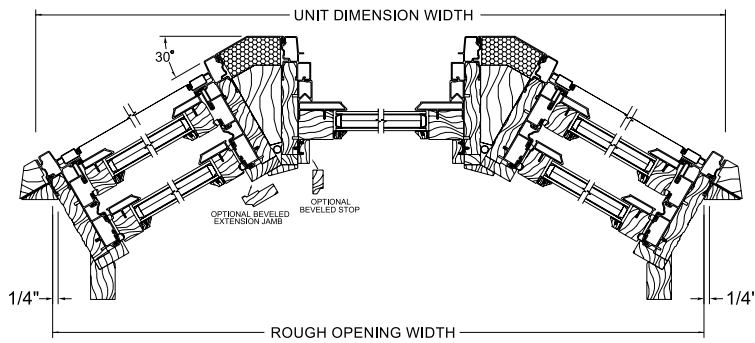

90° Bay Horizontal Section

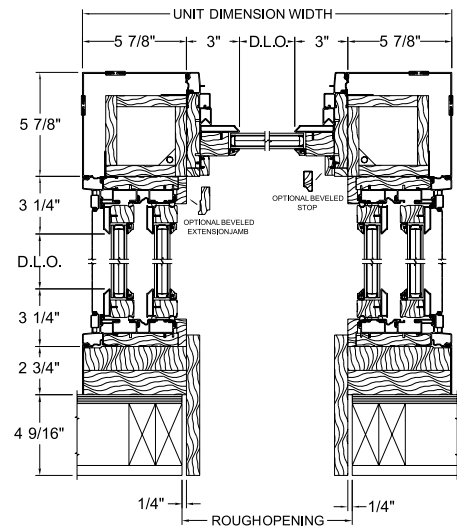

45° Bay Horizontal Section

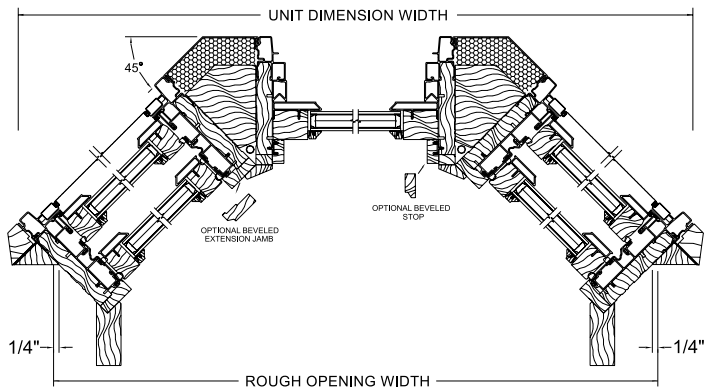

30°, 45° & 90° Bay Vertical Section

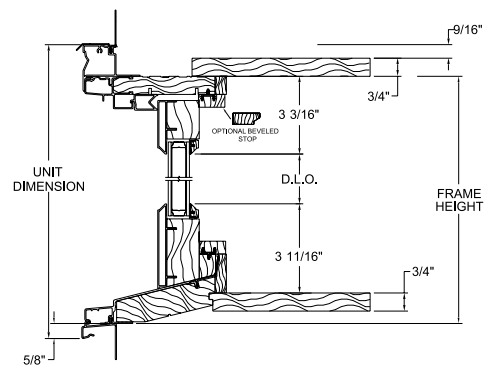

Double Hung Bays

Traditional

30° Bay Horizontal Section

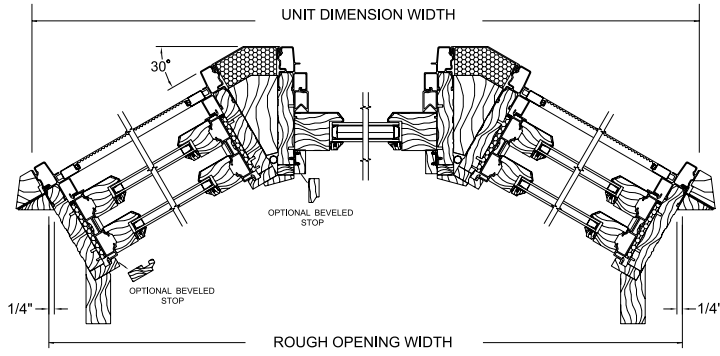

30° & 45° Bay Vertical Section

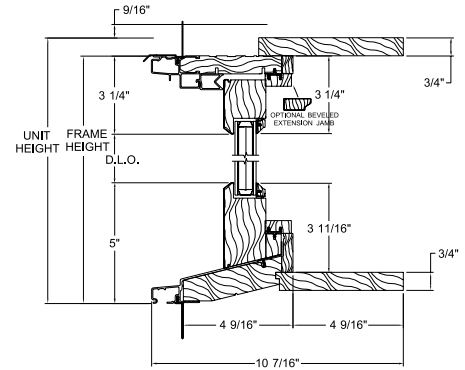

45° Bay Horizontal Section

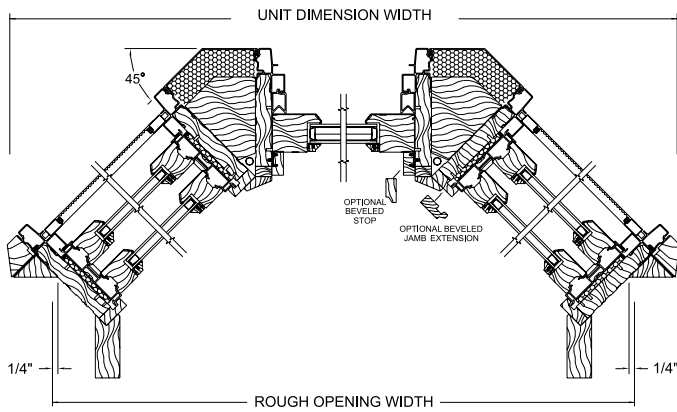

NOTE: Drawings are not to scale. Additional and the most current drawings are available at www.kolbewindows.com.

Double Hungs | Cross Section Drawings

Pocket Double Hungs | Operating

Horizontal Section

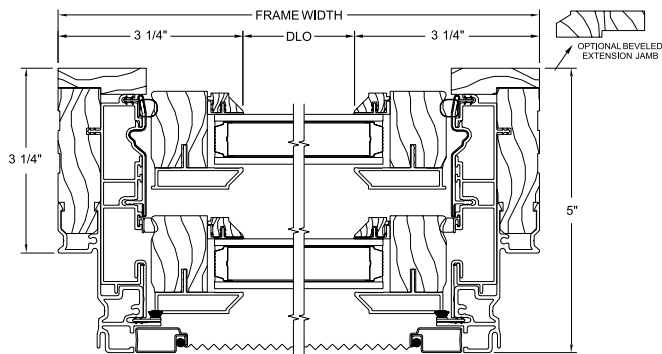

Vertical Section

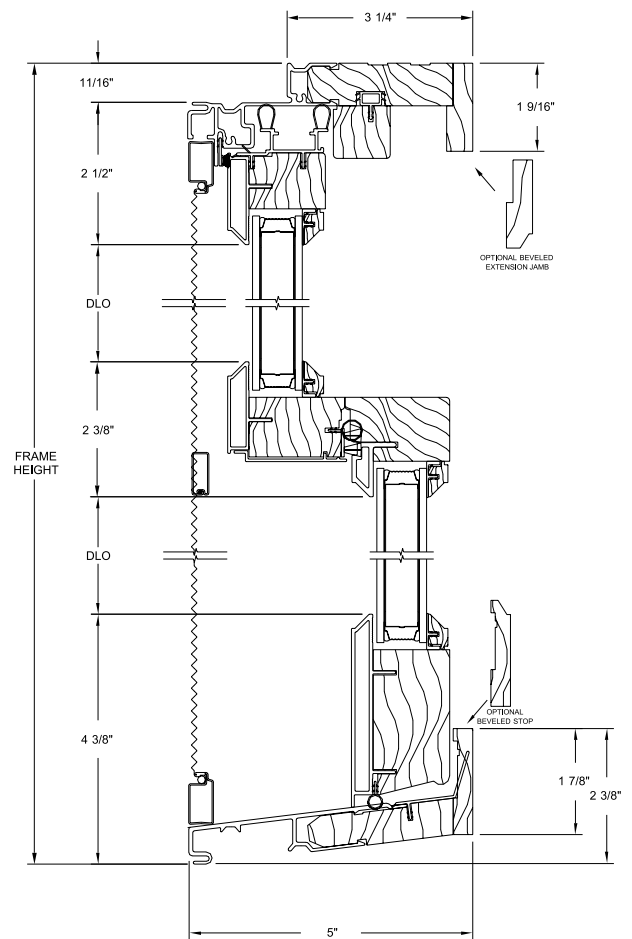

Pocket Double Hung to Active Pocket Double Hung Mullion

Mullion Detail

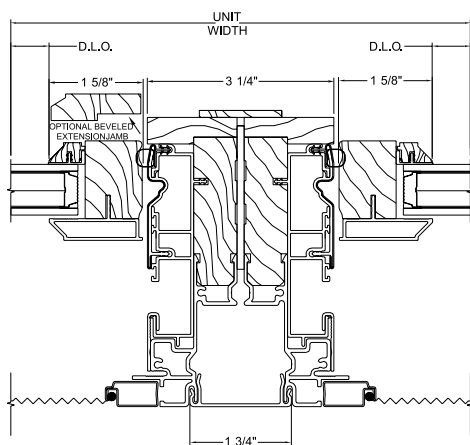

Transom Stacked Over Pocket Double Hung

Vertical Section

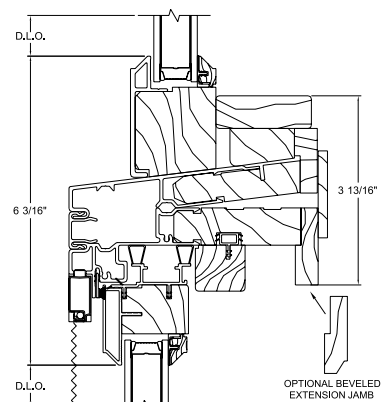

NOTE: Drawings are not to scale. Additional and the most current drawings are available at www.kolbewindows.com.

Pocket Double Hung | Transom Units

Vertical Section

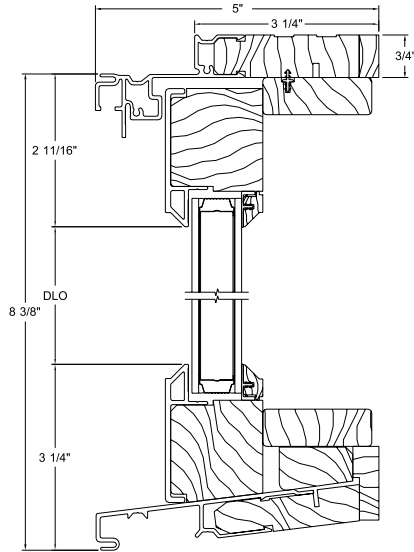

Pocket Double Hung | Studio Units

Vertical Section

Studio Pocket Double Hung to Active Pocket Double Hung Mullion

Mullion Detail

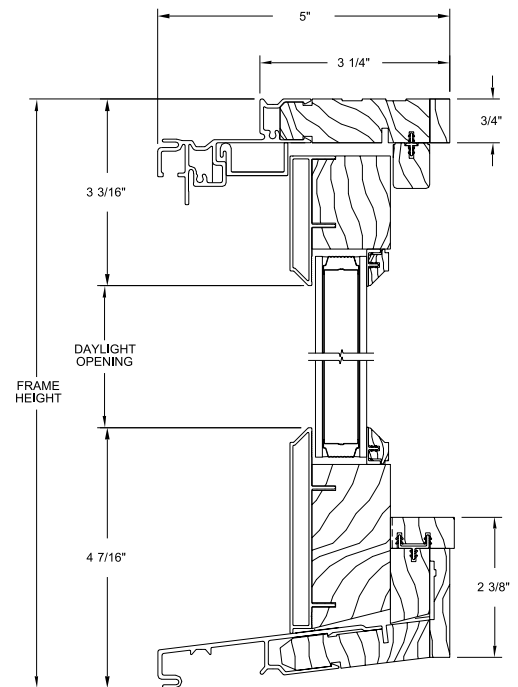
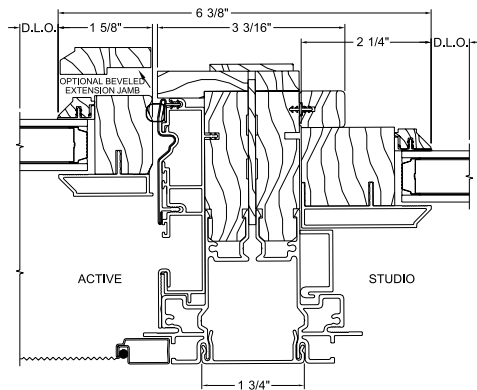

NOTE: Drawings are not to scale. Additional and the most current drawings are available at www.kolbewindows.com.





Folding, Sliding, & Tilt-Turn Windows

Kolbe is well known in the window and door industry for innovative products. Our two pass-through window options – folding windows and quad sliding windows – are the perfect way to blend indoor and outdoor living spaces. Double and triple sliding windows are also available for situations when space is at a premium. Tilt-turns lend a modern twist to a classic European window, with special hardware that allows them to open as a top-venting hopper window or an inswing casement.

Folding Windows | Single, Double, Triple, & Quad Sliding Windows | Tilt-Turns

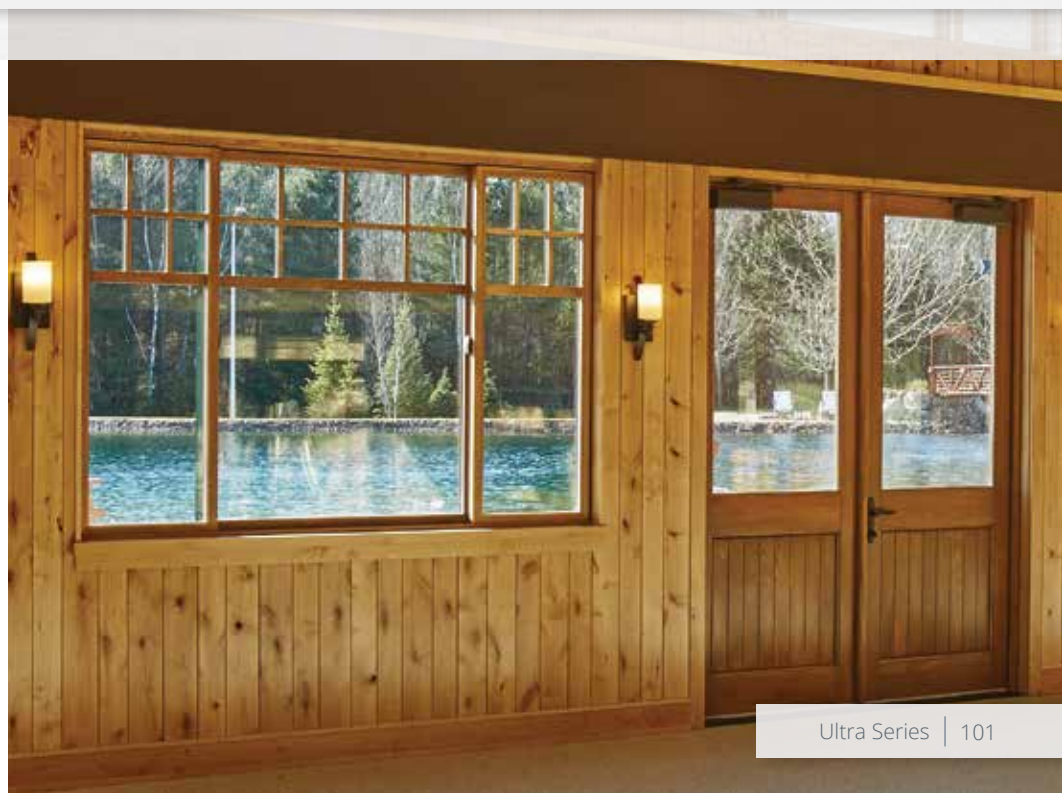

Folding Windows

Folding windows can infuse a room with a remarkable amount of fresh air by offering openings up to 52 feet. With up to eight panels per side, folding windows are highly customizable with a number of different configurations available. These made-to-order windows open up rooms dramatically by extending the living space to the outdoors.



Folding Window Standard Features

- ▶ 1-3/4" thick sash
- ▶ 6-9/16" minimum jamb width
- ▶ Stiles and rails are a nominal 3" wide
- ▶ Frame set up for units 177" wide x 77-1/8" tall; all others knocked down
- ▶ Constructed of pine, with pine interior stops
- ▶ Exterior wood parts are treated
- ▶ Extruded aluminum exterior finished with a 70% PVDF fluoropolymer coating (*meets performance requirements of AAMA 2605*)
- ▶ Accessory grooves are integral to the extruded frames for the easy addition of accessories
- ▶ Energy efficient, insulating Solar Low-E glass
- ▶ Glazed to the interior with beveled wood glazing beads
- ▶ Multi-point mortise latch with Toronto handle set in Bright Brass finish on configurations with an access panel
- ▶ Hinge handles standard on most panels
- ▶ Face-mounted flush bolt locking hardware on folding panels
- ▶ Bronze weep sill
- ▶ Grooved guide rollers with adjustable, ball-bearing wheels carry the folding panels
- ▶ Thick oak interior threshold
- ▶ Heavy vinyl nailing fins with head drip caps*

NOTE: All measurements are nominal.

Minimum panel height is 36", minimum panel width is 16", maximum panel height is 72" and maximum panel width is 39-3/8".

* Standard only on units without brickmould.

Hardware

- ▶ Face-mounted flush bolt locking hardware on folding panels if a handle is not desired. Available in Matte Black, Bright Brass, Chrome or Satin Nickel.
- ▶ Uno[†] or Aria handle set for folding panels with concealed shootbolt locking hardware. Available in Matte Black, Brushed Chrome, Bright Brass or Chrome.
- ▶ Hinges with handles in Bright Brass, Chrome, Satin Nickel or Matte Black.
- ▶ Finger pulls for panels without hinge handles in Bright Brass, Chrome, Satin Nickel or Matte Black.
- ▶ For units with a swinging panel, choose a Toronto, München, Verona or Dallas^{††} handle set. Available in Bright Brass PVD, Antique Brass, Satin Nickel PVD, Antique Nickel PVD, Oil-Rubbed^{**}, Rustic Umber, Matte Black or Smoky Gray PVD (*pgs. 154-155*).
- ▶ For units with a swinging panel, choose a handle set from Baldwin[®] Hardware (*pg. 156*) in a variety of finishes.
- ▶ Magnetic latches or panel stays are available to assist in keeping windows stationary while open.

† Uno handle set is only available in Brushed Chrome and Matte Black.

†† Dallas handle set is only available in Bright Brass PVD, Satin Nickel PVD, Rustic Umber, Matte Black, and Smoky Gray PVD.

**The Oil-Rubbed finish is a living finish, which means that it will change appearance over time with use.

Flush Bolt (shown in Satin Nickel)

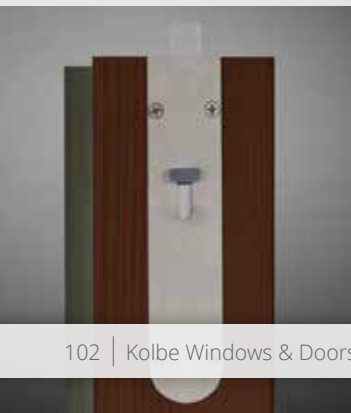

Concealed Shoot Bolt



Uno[†] Handle

(shown in Matte Black)



Aria Handle

(shown in Chrome)





Folding Window Options

Glass (pg. 200)

- ▶ Solar Gain Low-E
- ▶ Solar Advanced Control Low-E
- ▶ Solar Control Low-E
- ▶ ThermaPlus™ Low-E
- ▶ Neat®
- ▶ Triple pane^v
- ▶ Patterned-, bronze-, or gray-lite
- ▶ Tempered or laminated
- ▶ Other options standard to the industry

Divided Lites (pg. 201)

- ▶ Performance divided lites with 5/8", 7/8", 1-1/8", 1-3/8", 1-3/4", 2-1/4" or 4-1/2" bars
- ▶ Grilles-in-the-airspace

Insect Screens

- ▶ Black pleated retractable insect screen

Sills

- ▶ Recessed floor track sill (*interior*), weep or non-weep in a Bronze anodized finish
- ▶ Weep sill in a Clear anodized finish

NOTE: All measurements are nominal.

¥ 2-1/4" panels only; size limitations apply. Contact your Kolbe dealer for more information.

Other Options (*custom options are also available*)

- ▶ Stile and top rail options: 4-5/8" or 6"
- ▶ Bottom rail options: 4-5/8", 6", 7-9/16" or 12-5/8"
- ▶ 2-1/4" thick panel
- ▶ Other wood species and FSC®-certified wood (pg. 198)
- ▶ Interior prefinishing (pg. 198)
- ▶ Interior casing
- ▶ Ovolo and square profile glazing beads and interior divided lite bars (pg. 201)
- ▶ Extruded aluminum accessories applied to accessory grooves on the exterior frame (pgs. 206-212)
- ▶ Extension jambs in a wide variety of sizes (*shipped loose for field application if over 12"*)
- ▶ Galvanized steel installation clips

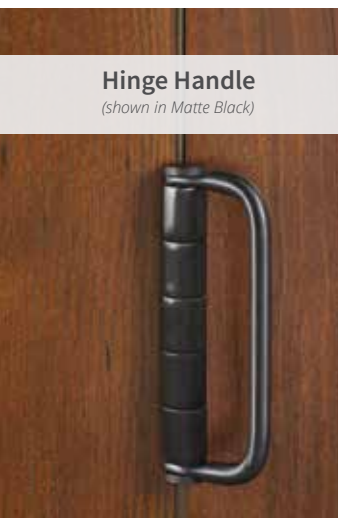

Hinge Handle
(shown in Matte Black)



Finger Pull
(shown in Satin Nickel)



Magnetic Latch

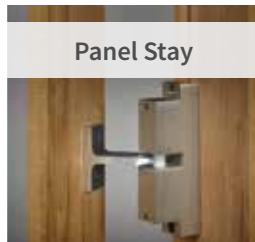

Panel Stay

Sliding Windows

Sliding windows provide solutions for larger expansive openings while offering solid performance ratings. The design incorporates a sleek, extruded aluminum exterior that eliminates the use of vinyl tracks, a refined wood interior, needle-bearing rollers for ease of operation, and easy-to-clean tilt-in sash.



Sliding Window Standard Features

- ▶ 1-15/16" thick sash
- ▶ Overall jamb width is 4-9/16" (*basic box width is 4-9/16"*)
- ▶ Constructed of pine, with pine interior stops
- ▶ Exterior wood parts are treated
- ▶ Extruded aluminum exterior finished with a 70% PVDF fluoropolymer coating (*meets performance requirements of AAMA 2605*)
- ▶ Accessory grooves are integral to the extruded frames for the easy addition of accessories
- ▶ Energy efficient, insulating Solar Low-E glass
- ▶ Glazed to the interior with beveled wood glazing beads with no visible fasteners
- ▶ Clay-colored, positive action lock automatically secures window when unit is closed
- ▶ Needle bearing sash rollers for ease of operation
- ▶ Tilt-in sash for easy cleaning (*not available on units with sash wider than 2'6" and taller than 4'0"*)
- ▶ Center interlock and stiles have matching sightlines
- ▶ Heavy vinyl nailing fins with head drip caps

NOTE: All measurements are nominal.

* Standard only on units without brickmould.

Hardware

- ▶ Positive action sash lock automatically locks when the window is closed, providing convenient security. Available in Clay, White, Beige, Brass, Antique Brass, Satin Nickel, Rustic Umber or Matte Black.
- ▶ Finger pulls placed on the active sash assist in side-to-side, sliding operation. Available in Clay, White, Beige, Brass, Antique Brass, Satin Nickel, Rustic Umber or Matte Black.



Sash Lock (*shown in Antique Brass*)



Finger Pulls (*shown in Satin Nickel*)



Sliding Window Options

Glass (pg. 200)

- ▶ Solar Gain Low-E
- ▶ Solar Advanced Control Low-E
- ▶ Solar Control Low-E
- ▶ ThermaPlus™ Low-E
- ▶ Neat®
- ▶ Triple pane
- ▶ Patterned, bronze- or gray-lite
- ▶ Tempered or laminated
- ▶ Other options standard to the industry

Divided Lites (pg. 201)

- ▶ Performance divided lites with 5/8", 7/8", 1-1/8", 1-3/8", 1-3/4", 2-1/4" or 4-1/2" bars
- ▶ Grilles-in-the-airspace

Insect Screens

- ▶ Full or half insect screen with aluminum frame and options for BetterVue® or UltraVue® fiberglass mesh or aluminum mesh; frame will match the exterior color of the unit
- ▶ Exterior retractable insect screen kit (available only on single, triple, and quad units)

NOTE: All measurements are nominal.

Other Options: (custom options are also available)

- ▶ Other wood species and FSC®-certified wood (pg. 198)
- ▶ Interior prefinishing (pg. 198)
- ▶ Interior casing
- ▶ Ovolo or square profile glazing beads and interior divided lite bars (pg. 201)
- ▶ Prep for stool
- ▶ Extruded aluminum accessories applied to accessory grooves on the exterior frame (pgs. 206-212)
- ▶ Extension jambs (up to 12" applied, over 12" shipped loose for field application)
- ▶ Galvanized steel installation clips

Sliding Window Operational Configurations

Single Sliding Window

- ▶ Active sash (interior sash) can be either left or right
- ▶ Stationary sash placed on the outside track

Double Sliding Window

- ▶ Primary active sash (interior sash) can be either left or right

Triple Sliding Window

- ▶ Operation = Active-Fixed-Active (AFA)
- ▶ Stationary sash placed on the outside track

Quad Sliding Window

- ▶ Operation = Active-Fixed-Fixed-Active or Fixed-Active-Active-Fixed (AFFA or FAAF)
- ▶ Stationary sash placed on the outside track

Tilt-Turns

Tilt-turns put a modern twist on a classic European window. These units have special hardware that allows them to operate as a top-venting hopper window or an inswing casement. Tilt-turns combine versatility, classic style, and excellent energy performance.



Tilt-Turn Standard Features

- ▶ 2-11/16" nominal sash thickness
- ▶ Basic jamb width is 4-9/16" (*basic box width is 4-9/16"*)
- ▶ Constructed of pine, with pine interior stops and wood mull casings on mull units
- ▶ Exterior wood parts are treated
- ▶ Extruded aluminum exterior finished with a 70% PVDF fluoropolymer coating (*meets performance requirements of AAMA 2605*)
- ▶ Accessory grooves are integral to the extruded frames for the easy addition of accessories
- ▶ Energy efficient, insulating Solar Low-E glass
- ▶ Glazed to the interior with beveled wood glazing beads
- ▶ Rustic Umber operating handle
- ▶ Concealed hinges
- ▶ Heavy vinyl nailing fins with head drip caps*

NOTE: All measurements are nominal.

* Standard only on units without brickmould.

Tilt-Turn Operational Options

- ▶ Tilt before turn (*standard*)
- ▶ Turn before tilt
- ▶ Tilt only (*hopper*)
- ▶ Turn only (*inswing*)

Hardware

- ▶ Hardware allows the sash to tilt in at the top as a top-venting hopper window as well as swing in at the side. Available in White, Rustic Umber or Black.
- ▶ Keyed handles are available to prohibit unauthorized operation. Available in White, Rustic Umber or Black.



Handle (shown in White)



Keyed Handle (shown in Black)



Tilt-Turn Options

Glass (pg. 200)

- ▶ Solar Gain Low-E
- ▶ Solar Advanced Control Low-E
- ▶ Solar Control Low-E
- ▶ ThermaPlus™ Low-E
- ▶ Neat®
- ▶ Triple pane
- ▶ Patterned-, bronze-, or gray-lite
- ▶ Tempered or laminated
- ▶ Other options standard to the industry

Divided Lites (pg. 201)

- ▶ Performance divided lites with 5/8", 7/8", 1-1/8", 1-3/8", 1-3/4", 2-1/4" or 4-1/2" bars
- ▶ Grilles-in-the-airspace

Insect Screens

- ▶ Exterior aluminum or retractable insect screen with BetterVue® or UltraVue® mesh; frame will match the exterior color of the unit

NOTE: All measurements are nominal.

Other Options (custom options are also available)

- ▶ Other wood species and FSC®-certified wood (pg. 198)
- ▶ Interior prefinishing (pg. 198)
- ▶ Interior casing
- ▶ Ovolo or square profile glazing beads and interior divided lite bars (pg. 201)
- ▶ 6-9/16" extruded aluminum exterior extension jamb with groove for accessory application
- ▶ Extruded aluminum accessories applied to accessory grooves on the exterior frame (pgs. 206-212)
- ▶ Interior extension jambs in a wide variety of sizes (shipped loose for field application if over 12")
- ▶ Galvanized steel installation clips
- ▶ High performance and impact performance modifications (pg. 205)



Tilt operation



Turn operation

Folding Windows | Panel Configurations

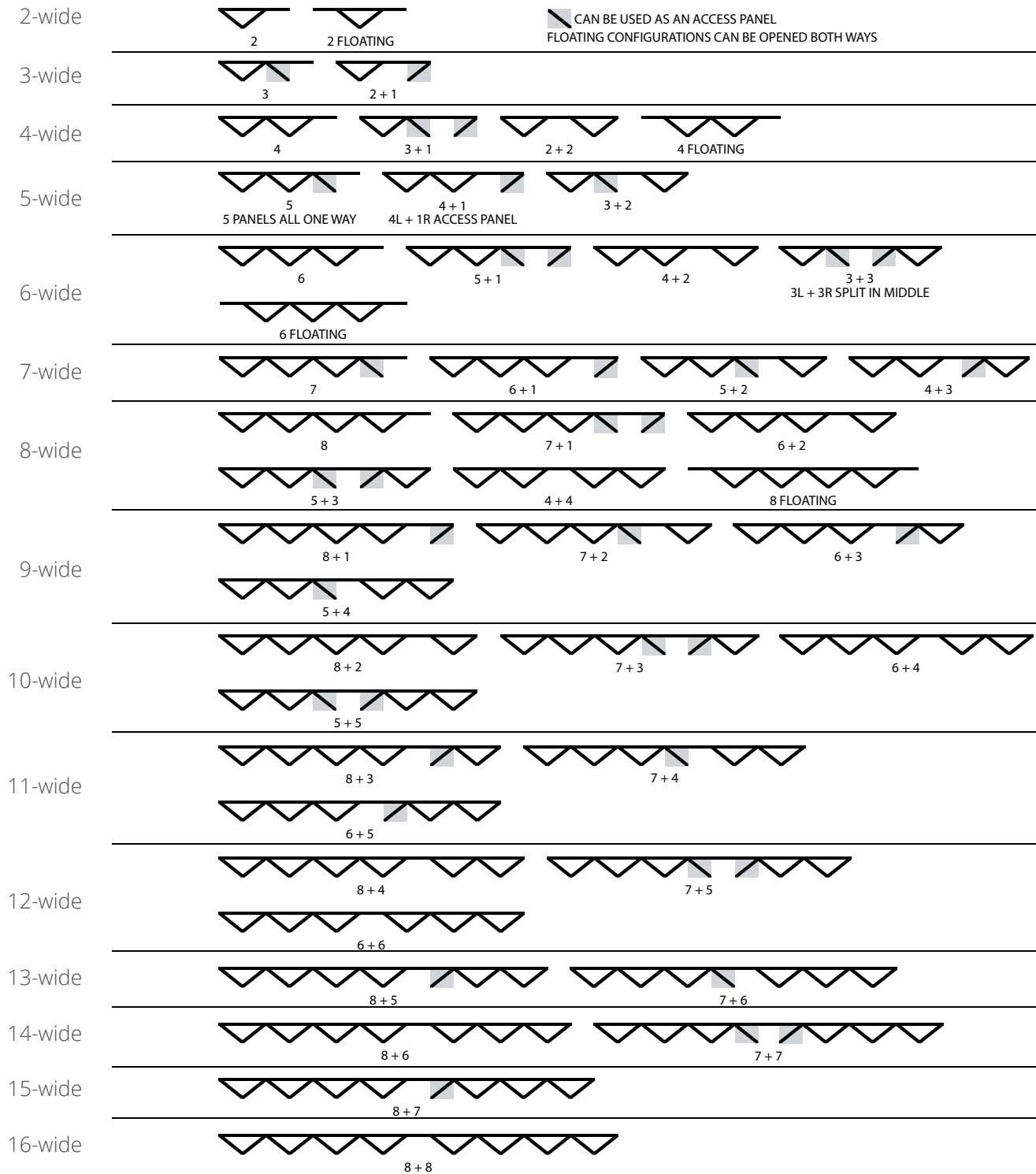

NOTE: Folding windows are shown as outswing operation. There is a maximum of 8 panels per side. Access panel configuration will have a swinging panel hinged off of one of the sides of the frame or off of another panel, depending on the configuration chosen. Configurations can be reversed. The configurations shown above are an overview of what is available. Contact your Kolbe dealer for more information.

Folding Windows | Cross Section Drawings

4-Wide: Folding 1-Way

Horizontal Section

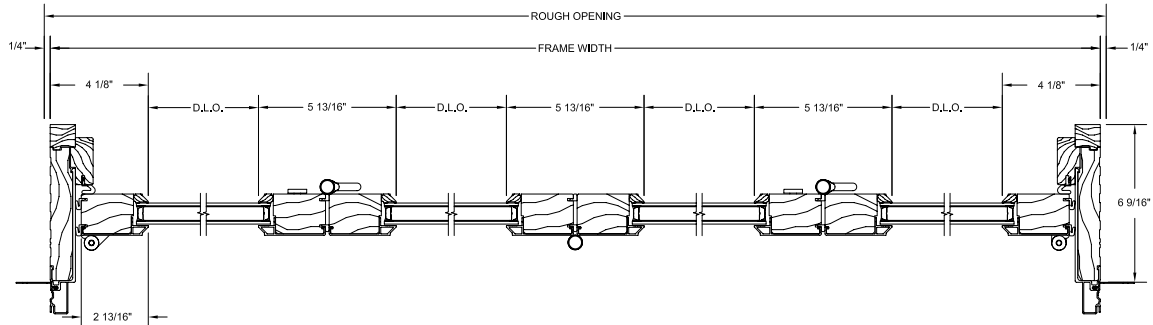

4-Wide: Three Left & One Right

Horizontal Section

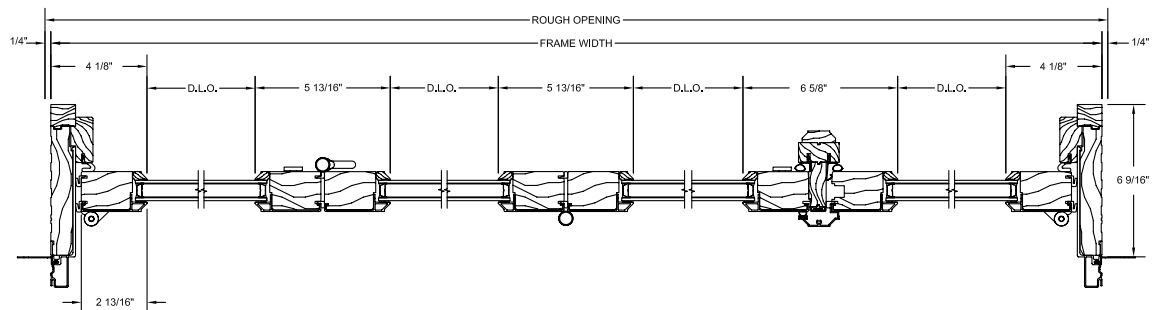

4-Wide: Two Left & Two Right

Horizontal Section

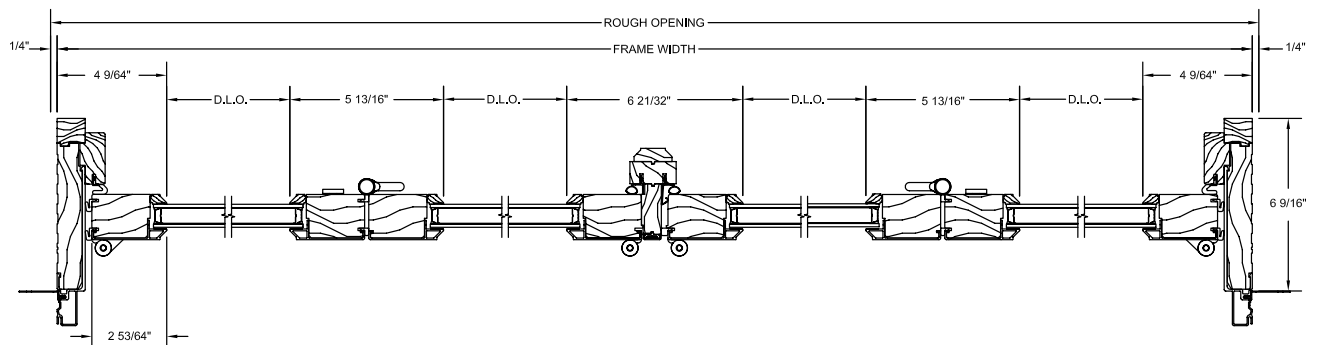

Operation is viewed from the exterior.

NOTE: Drawings are not to scale. Additional and the most current drawings are available at www.kolbewindows.com.

Folding Windows | Cross Section Drawings

Corner Unit

Horizontal Section

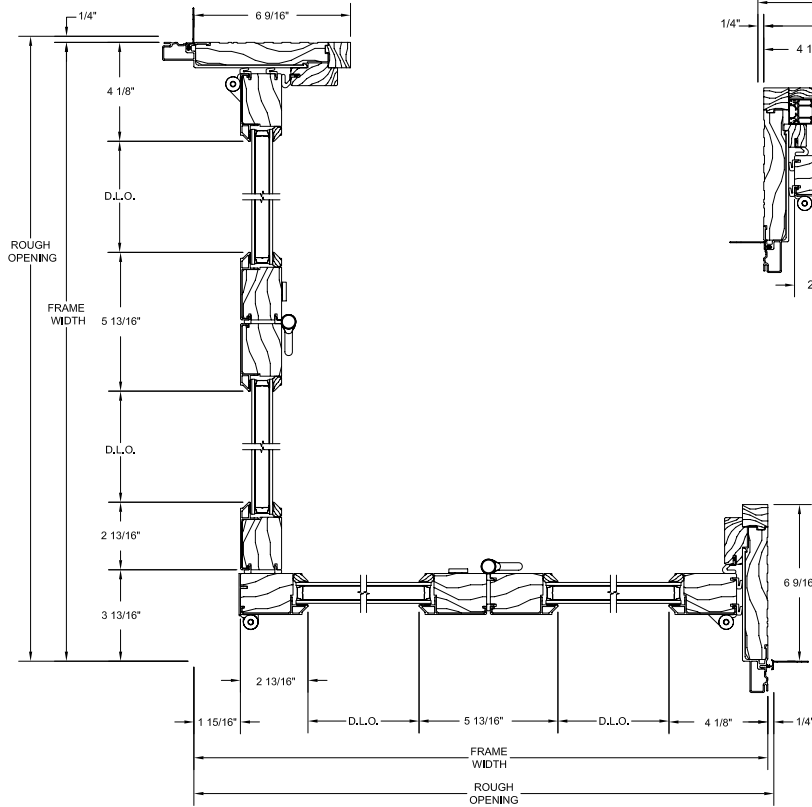

2-Wide with Screen

Horizontal Section

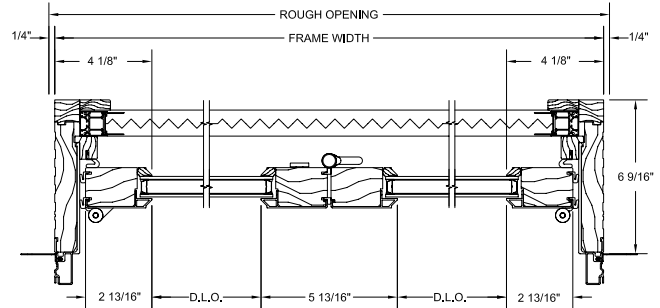

1.75" Panel with Recessed Sill

Vertical Section

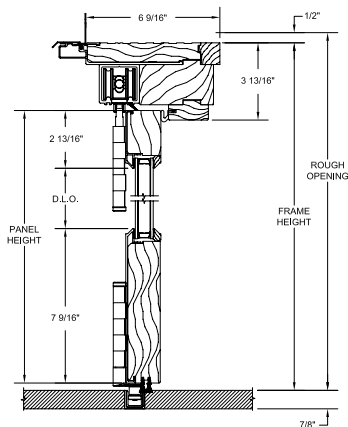

1.75" Panel with Weep Sill

Vertical Section

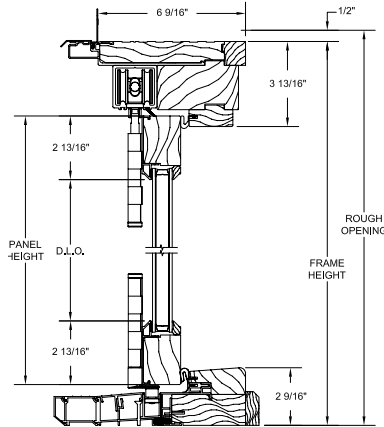

1.75" Panel with Weep Sill & Screen



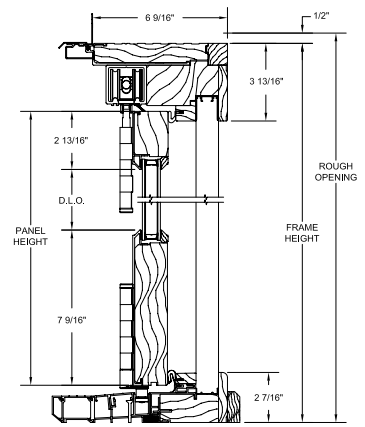



























































Vertical Section



NOTE: Drawings are not to scale. Additional and the most current drawings are available at www.kolbewindows.com.

Sliding Windows | Elevation Charts

Single & Double Sliding Windows

F.S.	1'-11 1/2"	2'-11 1/2"	3'-11 1/2"	4'-11 1/2"	5'-11 1/2"	6'-11 1/2"	7'-11 1/2"
R.O.	2'-0"	3'-0"	4'-0"	5'-0"	6'-0"	7'-0"	8'-0"
G.S.	8 13/16"	14 13/16"	20 13/16"	26 13/16"	32 13/16"	38 13/16"	44 13/16"
1'-11 7/16" 2'-0" 16 3/4"	 SL2020	 SL3020	 SL4020	 SL5020	 SL6020	 SL7020	 SL8020
2'-5 7/16" 2'-6" 22 3/4"	 SL2026	 SL3026	 SL4026	 SL5026	 SL6026	 SL7026	 SL8026
2'-11 7/16" 3'-0" 28 3/4"	 SL2030	 SL3030	 SL4030	 SL5030	 SL6030	 SL7030	 SL8030
3'-5 7/16" 3'-6" 34 3/4"	 SL2036	 SL3036	 SL4036	 SL5036	 SL6036	 SL7036	 SL8036
3'-11 7/16" 4'-0" 40 3/4"	 SL2040	 SL3040	 SL4040	 SL5040	 SL6040	 SL7040	 SL8040
4'-5 7/16" 5'-0" 52 3/4"	 SL2046	 SL3046	 SL4046	 SL5046	 SL6046	 SL7046	 SL8046
4'-11 7/16" 5'-0" 52 3/4"	 SL2050	 SL3050	 SL4050	 SL5050	 SL6050	 SL7050	 SL8050
5'-5 7/16" 5'-6" 58 3/4"	 SL2056	 SL3056	 SL4056	 SL5056	 SL6056	 SL7056	 SL8056
5'-11 7/16" 6'-0" 64 3/4"	 SL2060	 SL3060	 SL4060	 SL5060	 SL6060	 SL7060	 SL8060

F.S. = Frame Size • R.O. = Rough Opening • S.O. = Sash Opening • G.S. = Glass Size

Dimension Calculations

	Width	Height
F.S. to Sash O.S.M. (interior sash)	+ 2 - 11/32"	-4 5/64"
(exterior sash)	+ 2 + 3/64"	-4 5/64"
Sash O.S.M. to G.S. (interior sash)	-2 19/32"	-2 39/64"
(exterior sash)	-2 63/64"	-2 39/64"
G.S. to D.L.O.	-1"	-1"
F.S. to Screen O.S.M. (Single)	+ 2 - 2 9/16"	-3 15/16"
(Double)	-2 1/8"	-2 3/16"

F.S. = Frame Size • G.S. = Glass Size • O.S.M. = Outside Measurement
D.L.O. = Daylight Opening • U.D. = Unit Dimension

NOTE: All measurements are nominal. Elevation charts are not to scale. Divided lites are optional.

Some installation procedures will require a larger rough opening than noted (i.e. installations utilizing our installation clips), therefore, you may need to increase the rough opening size accordingly. Rough opening gaps may be increased up to a maximum of 1/2" on all sides and still be within good practice guidelines. For rough opening recommendations, see pg. 216.

The side jambs of sliding windows extend above the head jamb; additional space for the rough opening height may be necessary.

Additional and the most current drawings are available at www.kolbewindows.com.

Sliding Windows | Elevation Charts

Triple Sliding Windows

F.S.	3'-11 1/2"	4'-11 1/2"	5'-11 1/2"	6'-11 1/2"	7'-11 1/2"	8'-11 1/2"	9'-11 1/2"
R.O.	4'-0"	5'-0"	6'-0"	7'-0"	8'-0"	9'-0"	10'-0"
G.S.*	8 13/16"	11 13/16"	14 13/16"	17 13/16"	20 13/16"	23 13/16"	26 13/16"
G.S.**	22 9/16"	28 9/16"	34 9/16"	40 9/16"	46 9/16"	52 9/16"	58 9/16"
1'-11 7/16"							
2'-5 7/16"							
2'-11 7/16"							
3'-5 7/16"							
3'-11 7/16"							
4'-5 7/16"							
4'-11 7/16"							
5'-5 7/16"							
5'-11 7/16"							

* Glass size for active panels

**Glass size for inactive panels

F.S. = Frame Size • R.O. = Rough Opening • S.O. = Sash Opening • G.S. = Glass Size

Dimension Calculations

	Width	Height
F.S. to Sash O.S.M. (flanker sash)	÷ 4 - 15/32"	-4 5/64"
(center sash)	÷ 2 + 2 7/32"	-4 5/64"
Sash O.S.M. to G.S. (flanker sash)	-2 19/32"	-2 39/64"
(center sash)	-3 13/32"	-2 39/64"
G.S. to D.L.O.	-1"	-1"
F.S. to Screen O.S.M.	÷ 4 - 2 11/16"	-3 15/16"

F.S. = Frame Size • G.S. = Glass Size • O.S.M. = Outside Measurement
D.L.O. = Daylight Opening • U.D. = Unit Dimension

NOTE: All measurements are nominal. Elevation charts are not to scale. Divided lites are optional.

Some installation procedures will require a larger rough opening than noted (i.e. installations utilizing our installation clips), therefore, you may need to increase the rough opening size accordingly. Rough opening gaps may be increased up to a maximum of 1/2" on all sides and still be within good practice guidelines. For rough opening recommendations, see pg. 216.

The side jambs of sliding windows extend above the head jamb; additional space for the rough opening height may be necessary.

Additional and the most current drawings are available at www.kolbewindows.com.

Quad Sliding Windows (FAAF or AFFA)

F.S.	5'-11 1/2"	6'-11 1/2"	7'-11 1/2"	8'-11 1/2"	9'-11 1/2"	10'-11 1/2"	11'-11 1/2"	12'-11 1/2"	13'-11 1/2"
R.O.	6'-0"	7'-0"	8'-0"	9'-0"	10'-0"	11'-0"	12'-0"	13'-0"	14'-0"
G.S.*	15 13/16"	18 13/16"	21 13/16"	24 13/16"	27 13/16"	30 13/16"	33 13/16"	36 13/16"	39 13/16"
G.S.**	14 13/16"	17 13/16"	20 13/16"	23 13/16"	26 13/16"	29 13/16"	32 13/16"	35 13/16"	38 13/16"

1'-11 7/16"	QSL6020	QSL7020	QSL8020	QSL9020	QSL10020	QSL11020	QSL12020	QSL13020	QSL14020
2'-5 7/16"	QSL6026	QSL7026	QSL8026	QSL9026	QSL10026	QSL11026	QSL12026	QSL13026	QSL14026
2'-11 7/16"	QSL6030	QSL7030	QSL8030	QSL9030	QSL10030	QSL11030	QSL12030	QSL13030	QSL14030
3'-5 7/16"	QSL6036	QSL7036	QSL8036	QSL9036	QSL10036	QSL11036	QSL12036	QSL13036	QSL14036
3'-11 7/16"	QSL6040	QSL7040	QSL8040	QSL9040	QSL10040	QSL11040	QSL12040	QSL13040	QSL14040
4'-5 7/16"	QSL6046	QSL7046	QSL8046	QSL9046	QSL10046	QSL11046	QSL12046	QSL13046	QSL14046
4'-11 7/16"	QSL6050	QSL7050	QSL8050	QSL9050	QSL10050	QSL11050	QSL12050	QSL13050	QSL14050
5'-5 7/16"	QSL6056	QSL7056	QSL8056	QSL9056	QSL10056	QSL11056	QSL12056	QSL13056	QSL14056
5'-11 7/16"	QSL6060	QSL7060	QSL8060	QSL9060	QSL10060	QSL11060	QSL12060	QSL13060	QSL14060

* Glass size for inactive panels

**Glass size for active panels

F.S. = Frame Size • R.O. = Rough Opening • S.O. = Sash Opening • G.S. = Glass Size

Dimension Calculations

(Fixed-Active-Active-Fixed)

	Width	Height
F.S. to Sash O.S.M. (flanker sash)	÷ 4 + 59/64" -4 5/64"	
(center sash)	÷ 4 - 19/64" -4 5/64"	
Sash O.S.M. to G.S. (flanker sash)	-2 63/64"	-2 39/64"
(center sash)	-2 49/64"	-2 39/64"
G.S. to D.L.O.	-1"	-1"
F.S. to Screen O.S.M.	÷ 2 - 4 1/2"	-3 15/16"

F.S. = Frame Size • G.S. = Glass Size • O.S.M. = Outside Measurement
D.L.O. = Daylight Opening • U.D. = Unit Dimension

Dimension Calculations

(Active-Fixed-Fixed-Active)

	Width	Height
F.S. to Sash O.S.M. (flanker sash)	÷ 4 - 15/32" -4 5/64"	
(center sash)	÷ 4 + 1 3/32" -4 5/64"	
Sash O.S.M. to G.S. (flanker sash)	-2 19/32"	-2 39/64"
(center sash)	-3 5/32"	-2 39/64"
G.S. to D.L.O.	-1"	-1"
F.S. to Screen O.S.M.	÷ 4 - 2 11/16"	-3 15/16"

F.S. = Frame Size • G.S. = Glass Size • O.S.M. = Outside Measurement
D.L.O. = Daylight Opening • U.D. = Unit Dimension

NOTE: All measurements are nominal. Elevation charts are not to scale. Divided lites are optional.

Some installation procedures will require a larger rough opening than noted (i.e. installations utilizing our installation clips), therefore, you may need to increase the rough opening size accordingly. Rough opening gaps may be increased up to a maximum of 1/2" on all sides and still be within good practice guidelines. For rough opening recommendations, see pg. 216.

The side jambs of sliding windows extend above the head jamb; additional space for the rough opening height may be necessary.

Sizes are available in both active-fixed-fixed-active and fixed-active-active-fixed configurations.

Additional and the most current drawings are available at www.kolbewindows.com.

Sliding Windows | Cross Section Drawings

All Sliding Windows

Vertical Section

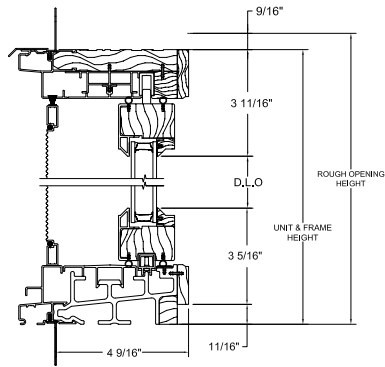

Outer Vertical Section

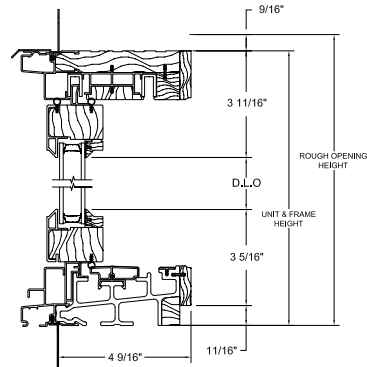

Single Sliding Window

Horizontal Section

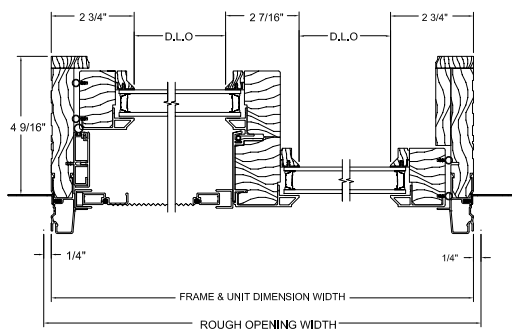

Double Sliding Window

Horizontal Section

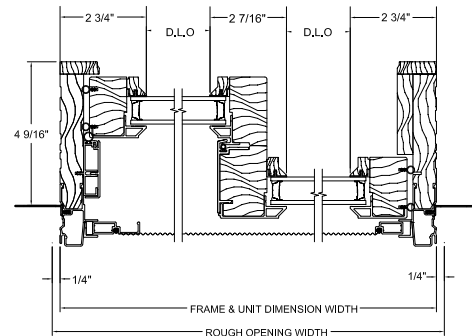

Triple Sliding Window

Horizontal Section

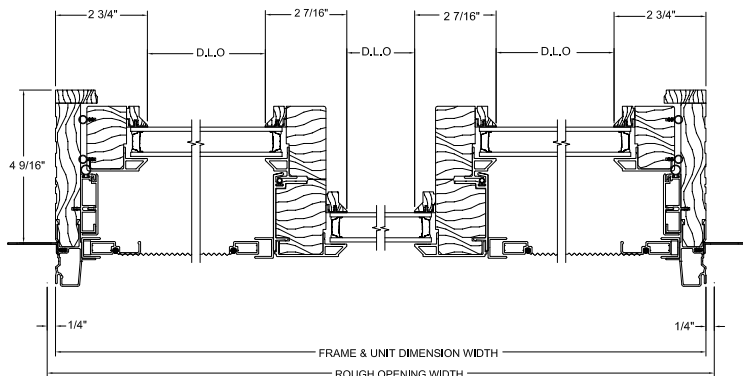

NOTE: Drawings are not to scale. Additional and the most current drawings are available at www.kolbewindows.com.

Quad Sliding Window Fixed-Active-Active-Fixed

Horizontal Section

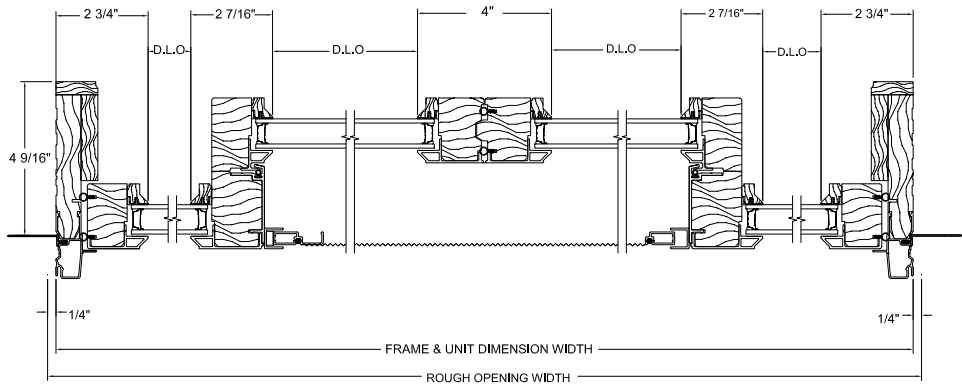

Quad Sliding Window Active-Fixed-Fixed-Active

Horizontal Section

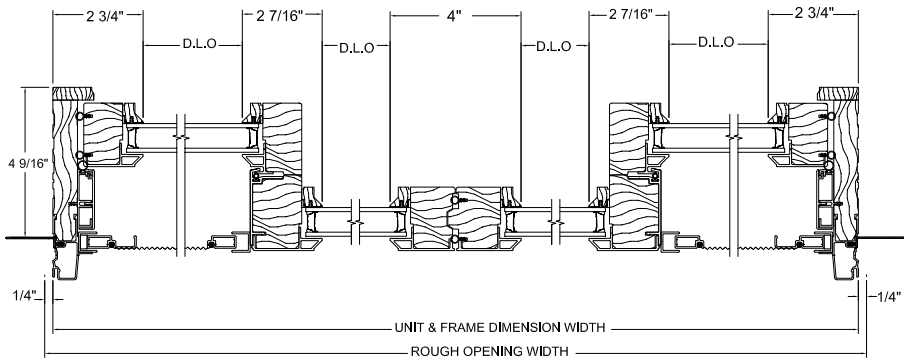

NOTE: Drawings are not to scale. Additional and the most current drawings are available at www.kolbewindows.com.







Specialty Windows

Ultra Series specialty windows are available in a variety of sizes and styles. Add radius or geometric units to other windows and doors to make a dramatic statement. Half-circle or elliptical units stacked above other Kolbe windows and doors create gracious curves and allow more light to enter your room. Comprise a window wall with a variety of triangles, trapezoids, parallelograms, octagons, pentagons, diamonds, hexagons, or any shape you can imagine to create a unique space.

If you don't need an operating window, direct set windows provide an ideal solution.

Radius Windows | Geometric Windows | Ogee Direct Sets | Beveled & Beveled XL Direct Sets | Corner Direct Sets

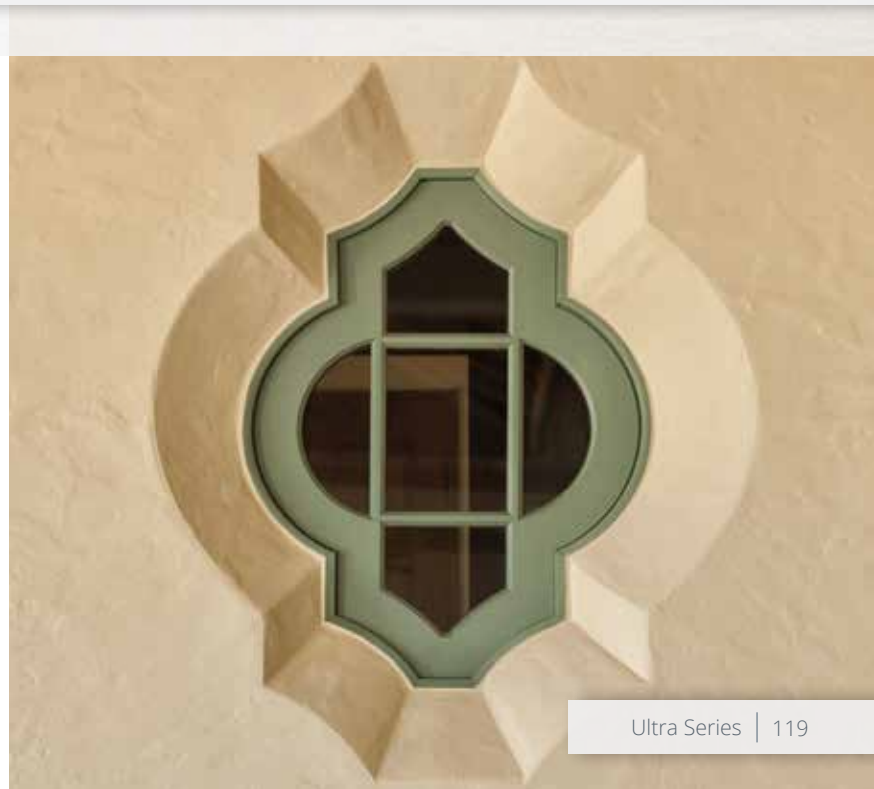

Radius Windows

Kolbe makes radius windows in stand-alone full circles, half-circles, quarter-circles, ellipticals, ovals and custom shapes. Half-circle or elliptical windows can be stacked over other Kolbe windows and doors to create larger window walls. We build our radius windows to order so that their profiles match those of the windows and doors they complement.



Radius Standard Features

- ▶ 1-3/4" thick sash
- ▶ Overall jamb width is 4-9/16"
- ▶ 3" straight legs on half-circles
- ▶ Constructed of pine, with pine interior stops and wood mull casings on mull units
- ▶ Exterior wood parts are treated
- ▶ Extruded aluminum exterior finished with a 70% PVDF fluoropolymer coating (*meets performance requirements of AAMA 2605*)
- ▶ Accessory grooves are integral to the extruded frames for the easy addition of accessories
- ▶ Energy efficient, insulating Solar Low-E glass
- ▶ Glazing is sash set to the interior with beveled wood glazing beads
- ▶ Standard radius shapes include quarter-circles, half-circles, full-circles, ovals and ellipticals
- ▶ Heavy vinyl nailing fins*

NOTE: All measurements are nominal.

* Standard only on units without brickmould.

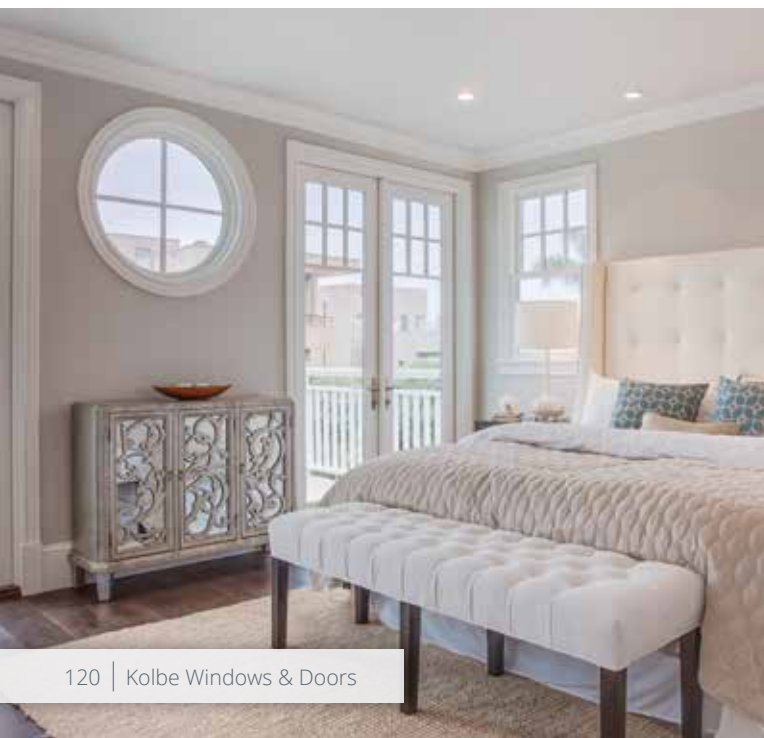



Radius Options

Glass (pg. 200)

- ▶ Solar Gain Low-E
- ▶ Solar Advanced Control Low-E
- ▶ Solar Control Low-E
- ▶ ThermaPlus™ Low-E
- ▶ Neat®
- ▶ Triple pane
- ▶ Patterned-, bronze-, or gray-lite
- ▶ Tempered or laminated
- ▶ Other options standard to the industry

Divided Lites (pg. 201)

- ▶ Performance divided lites with 5/8", 7/8", 1-1/8", 1-3/8", 1-3/4", 2-1/4" or 4-1/2" bars
- ▶ Grilles-in-the-airpace

NOTE: All measurements are nominal.

Other Options (custom options are also available)

- ▶ Other wood species and FSC®-certified wood (pg. 198)
- ▶ Interior prefinishing (pg. 198)
- ▶ Interior casing
- ▶ Ovolo or square profile glazing beads and interior divided lite bars (pg. 201)
- ▶ Extruded aluminum accessories applied to accessory grooves on the exterior frame (pgs. 206-212)
- ▶ Glazing may be direct set
- ▶ Extended legs or no legs on half-circles
- ▶ Extension jambs (up to 12" applied, over 12" shipped loose for field application)
- ▶ Galvanized steel installation clips
- ▶ Extruded aluminum nailing fin with drip cap on the radius portion of the frame (shipped for field application)
- ▶ High performance or impact performance modifications (pg. 205)

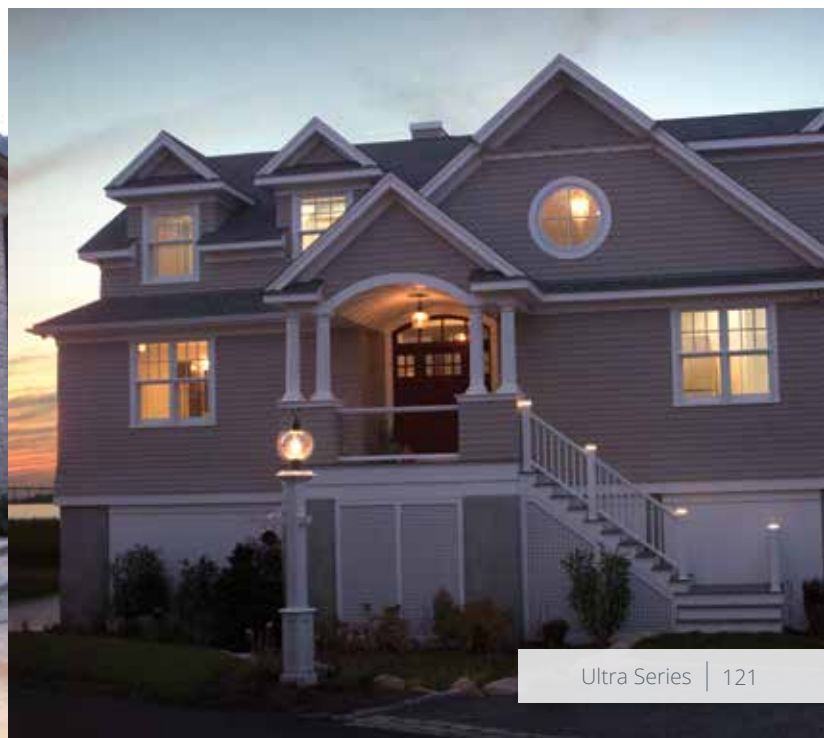

Geometric Windows

Make your design truly distinctive with Kolbe's geometric windows. Any combination will provide a light-filled room and a terrific view. Angled for interest, geometric windows are attention-grabbers. Kolbe can produce a nearly infinite variety of window shapes and sizes, with various glazing options to choose from.



Geometric Standard Features

- ▶ 1-3/4" thick sash
- ▶ Overall jamb width is 4-9/16"
- ▶ Constructed of pine, with pine interior stops and wood mull casings on mull units
- ▶ Exterior wood parts are treated
- ▶ Extruded aluminum exterior finished with a 70% PVDF fluoropolymer coating (*meets performance requirements of AAMA 2605*)
- ▶ Accessory grooves are integral to the extruded frames for the easy addition of accessories
- ▶ Energy efficient, insulating Solar Low-E glass
- ▶ Glazing is sash set to the interior with beveled wood glazing beads
- ▶ Standard geometric shapes include triangles, octagons, hexagons, pentagons, trapezoids, and diamonds
- ▶ Heavy vinyl nailing fins*

NOTE: All measurements are nominal.

* Standard only on units without brickmould.

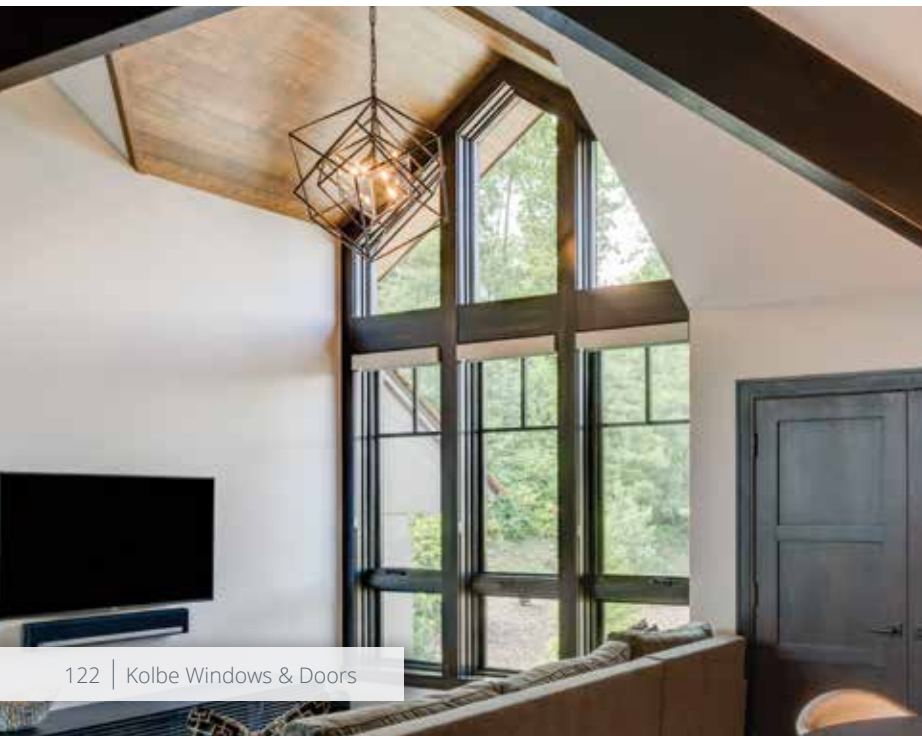

Brad Feinknopf/OTTO



Geometric Options

Glass (pg. 200)

- ▶ Solar Gain Low-E
- ▶ Solar Advanced Control Low-E
- ▶ Solar Control Low-E
- ▶ ThermaPlus™ Low-E
- ▶ Neat®
- ▶ Triple pane
- ▶ Patterned-, bronze-, or gray-lite
- ▶ Tempered or laminated
- ▶ Other options standard to the industry

Divided Lites (pg. 201)

- ▶ Performance divided lites with 5/8", 7/8", 1-1/8", 1-3/8", 1-3/4", 2-1/4" or 4-1/2" bars
- ▶ Grilles-in-the-airspace

NOTE: All measurements are nominal.

Other Options (custom options are also available)

- ▶ Other wood species and FSC®-certified wood (pg. 198)
- ▶ Interior prefinishing (pg. 198)
- ▶ Interior casing
- ▶ Ovolo or square profile glazing beads and interior divided lite bars (pg. 201)
- ▶ Extruded aluminum accessories applied to accessory grooves on the exterior frame (pgs. 206-212)
- ▶ Glazing may be direct set
- ▶ Extension jambs (up to 12" applied, over 12" shipped loose for field application)
- ▶ Galvanized steel installation clips
- ▶ High performance or impact performance modifications (pg. 205)



Direct Sets

If venting is not a requirement, direct set windows are ideal for maximizing daylight. The glass is set directly into the frame, which offers more glass area for passive lighting or enjoyment of scenery.



Ogee Direct Set

The Ultra Series Ogee direct set combines historical charm with modern day innovation.

Standard Features

- ▶ 2-7/16" overall jamb width
- ▶ Constructed of pine, with pine interior stops and wood mull casings on mull units
- ▶ Extruded aluminum exterior finished with a 70% PVDF fluoropolymer coating (*meets performance requirements of AAMA 2605*)
- ▶ Energy efficient, insulating Solar Low-E glass
- ▶ Glazing is direct set to the interior
- ▶ Exterior wood parts are treated
- ▶ Accessory grooves are integral to the extruded frames for the easy addition of accessories
- ▶ Heavy vinyl nailing fins with head drip caps*

NOTE: All measurements are nominal.

* Standard only on units without brickmould.

Ogee Direct Set Options

Glass (*pg. 200*)

- ▶ Solar Gain Low-E
- ▶ Solar Advanced Control Low-E
- ▶ Solar Control Low-E
- ▶ ThermaPlus™ Low-E
- ▶ Neat®
- ▶ Patterned-, bronze-, or gray-lite
- ▶ Tempered or laminated
- ▶ Other options standard to the industry

Divided Lites (*pg. 201*)

- ▶ Performance divided lites with 5/8", 7/8", 1-1/8", 1-3/8", 1-3/4", 2-1/4" or 4-1/2" bars
- ▶ Grilles-in-the-air-space

Other Options (*custom options are also available*)

- ▶ Other wood species and FSC®-certified wood (*pg. 198*)
- ▶ Square profile stops and square or ovolo interior divided lite bars (*pg. 201*)
- ▶ Interior prefinishing (*pg. 198*)
- ▶ Interior casing
- ▶ Extruded aluminum accessories applied to accessory grooves on the exterior frame (*pgs. 206-212*)
- ▶ Extension jambs (*up to 12" applied, over 12" shipped loose for field application*)
- ▶ Galvanized steel installation clips
- ▶ Extruded aluminum drip cap (*radius units; shipped for field*)
- ▶ High performance and impact performance modifications (*pg. 205*)

NOTE: All measurements are nominal.



Beveled Direct Set

The Ultra Series Beveled direct set provides design flexibility while maximizing the views.

Standard Features

- ▶ 2-3/4" overall jamb width
- ▶ Constructed of pine, with pine interior stops and wood mull casings on mull units
- ▶ Extruded aluminum exterior finished with a 70% PVDF fluoropolymer coating *(meets performance requirements of AAMA 2605)*
- ▶ Energy efficient, insulating Solar Low-E glass
- ▶ Glazing is direct set to the interior
- ▶ Exterior wood parts are treated
- ▶ Accessory grooves are integral to the extruded frames for the easy addition of accessories
- ▶ Heavy vinyl nailing fins with head drip caps*

NOTE: All measurements are nominal.

* Standard only on units without brickmould.

Beveled XL Direct Set

Beveled XL direct set windows feature triple pane glass to provide higher energy performance as well as meet ENERGY STAR® criteria in U.S. and Canadian climate zones.

Standard Features *(Includes standard features above, with the exception of the following substitutions)*

- ▶ Basic jamb width of 3-1/4"; matches the same basic jamb as the EP Casement
- ▶ 1-3/8" total thickness of triple pane glass with Solar Low-E and Solar Gain Low-E; also available with 7/8" dual pane glass

Beveled and Beveled XL Direct Set Options

Glass *(pg. 200)*

- ▶ Solar Gain Low-E
- ▶ Solar Advanced Control Low-E
- ▶ Solar Control Low-E
- ▶ ThermaPlus™ Low-E
- ▶ Neat®
- ▶ Triple pane
- ▶ Patterned-, bronze-, or gray-lite
- ▶ Tempered or laminated
- ▶ Other options standard to the industry

Divided Lites *(pg. 201)*

- ▶ Performance divided lites with 5/8", 7/8", 1-1/8", 1-3/8", 1-3/4", 2-1/4" or 4-1/2" bars
- ▶ Grilles-in-the-airspace

NOTE: All measurements are nominal.

Other Options *(custom options are also available)*

- ▶ Other wood species and FSC®-certified wood *(pg. 198)*
- ▶ Square profile stops and square or ovolo interior divided lite bars *(pg. 201)*
- ▶ Interior prefinishing *(pg. 198)*
- ▶ Interior casing
- ▶ Extruded aluminum accessories applied to accessory grooves on the exterior frame *(pgs. 206-212)*
- ▶ Extension jambs *(up to 12" applied, over 12" shipped loose for field application)*
- ▶ Galvanized steel installation clips
- ▶ Extruded aluminum drip cap *(radius units; shipped for field)*
- ▶ High performance and impact performance modifications *(pg. 205)*

Radius Windows | Elevation Charts

Radius Divided Lite Patterns

Quarter-circles

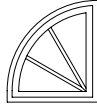

Starburst



Sunburst

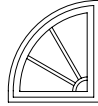

Open Hub Sunburst*

Half-circles

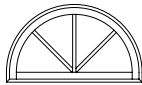

Starburst

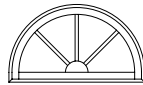

Sunburst

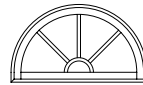

Open Hub Sunburst*

Ellipticals

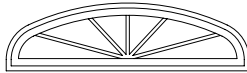

Starburst

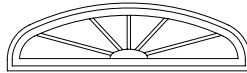

Sunburst

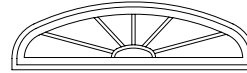

Open Hub Sunburst*

*Open Hub Sunburst is available with grilles-in-the-airspace with limitations; however, 2-1/4" PDL bars are not available. Consult your dealer for details.

Dimension Calculations

Dimension calculation formulas for radius units vary depending on the unit and application. Please contact your Kolbe dealer if formulas are needed.

Patterns and hub sizes remain the same between wood removable grilles, grilles-in-the-airspace or PDL. Consult your dealer about divided lite patterns for full-circle and oval windows.

Half-Circle Units | Casement Profile

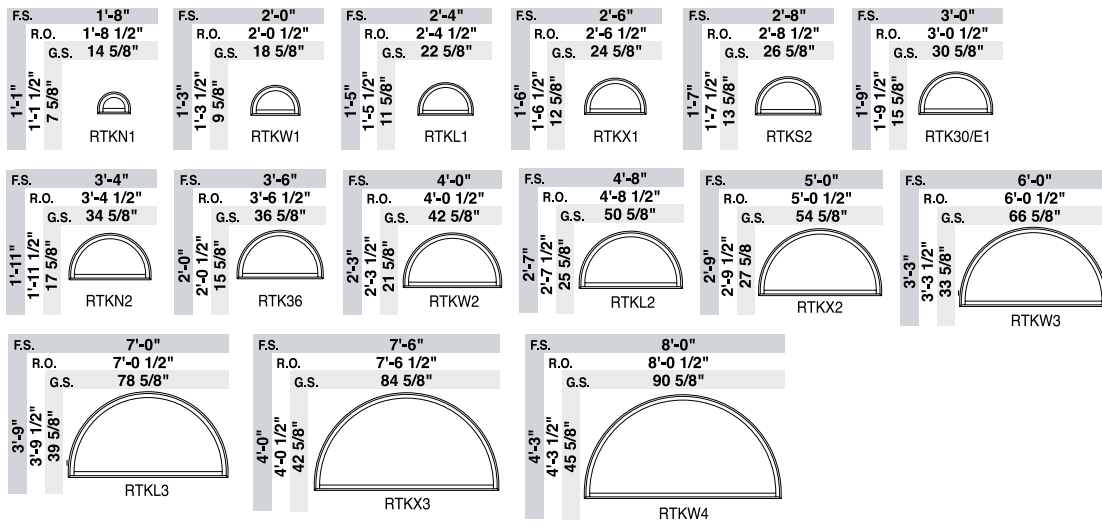

Half-Circle Units | Double Hung Profile

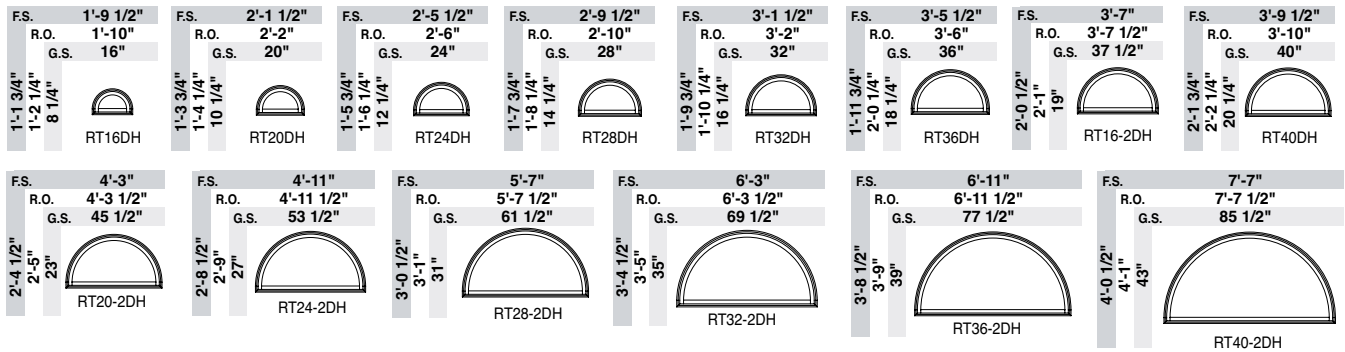

F.S. = Frame Size • R.O. = Rough Opening • G.S. = Glass Size

NOTE: All measurements are nominal. Elevation charts are not to scale.

Radius units are sash set as standard. Direct set units are available but glass sizes differ from chart shown. Contact your dealer for details.

The units shown are stand-alone units. Adjustments may be required when stacking over other units; adjustments will be made in the factory.

Divided lites are optional. Divide lite pattern options are shown on pg. 126.

Some installation procedures will require a larger rough opening than noted (i.e. installations utilizing our installation clips), therefore, you may need to increase the rough opening size accordingly. Rough opening gaps may be increased up to a maximum of 1/2" on all sides and still be within good practice guidelines. For rough opening recommendations, see pg. 216.

Additional and the most current drawings are available at www.kolbwindows.com.

Radius Windows | Elevation Charts

Half-Circle Units | Garden-Aire Sliding Patio Doors

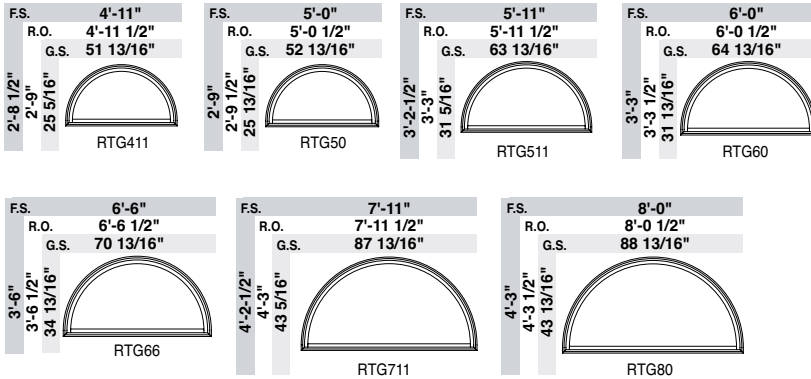

Half-Circle Units | Inswing Patio Doors

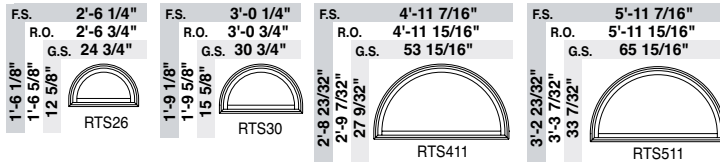

Half-Circle Units | Inswing Entrance Doors

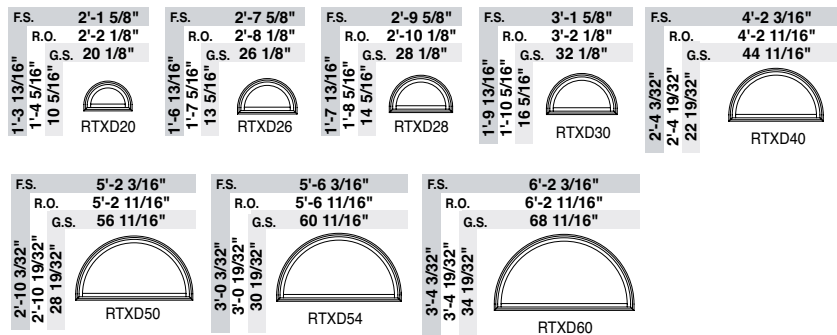

F.S. = Frame Size • R.O. = Rough Opening • G.S. = Glass Size

NOTE: All measurements are nominal. Elevation charts are not to scale.

Radius units are sash set as standard. Direct set units are available but glass sizes differ from chart shown. Contact your supplier for details.

The units shown are stand-alone units. Adjustments may be required when stacking over other units; adjustments will be made in the factory.

Divided lites are optional. Divide lite pattern options are shown on pg. 126.

Some installation procedures will require a larger rough opening than noted (i.e. installations utilizing our installation clips), therefore, you may need to increase the rough opening size accordingly. Rough opening gaps may be increased up to a maximum of 1/2" on all sides and still be within good practice guidelines. For rough opening recommendations, see pg. 216.

Additional and the most current drawings are available at www.kolbewindows.com.

Half-Circle Units | 1-Wide Outswing Entrance Doors

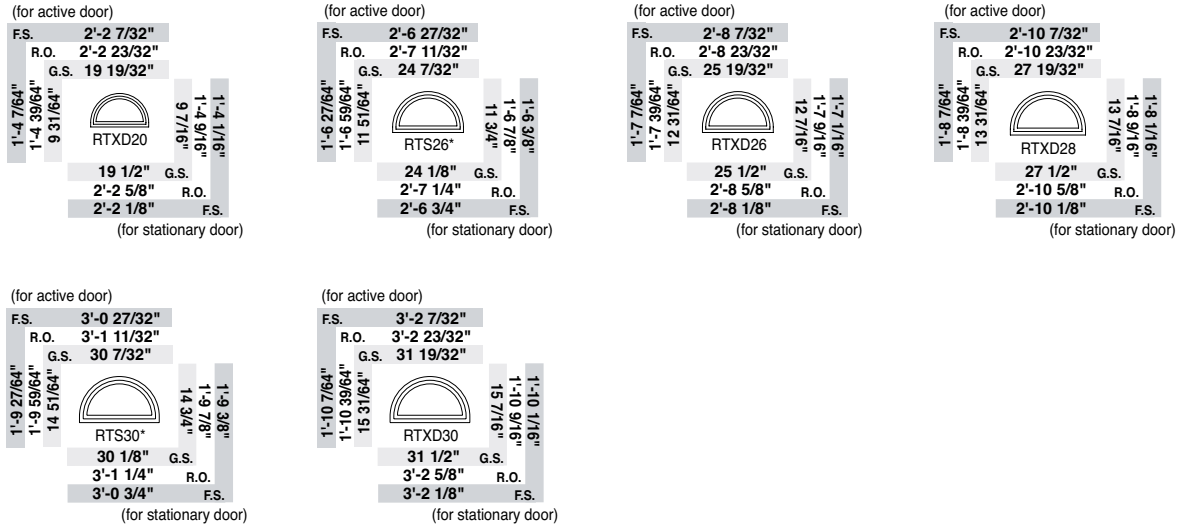

Half-Circle Units | 2-Wide Outswing Entrance Doors

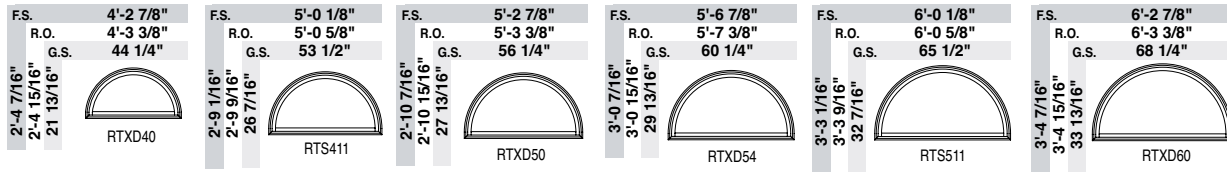

F.S. = Frame Size • R.O. = Rough Opening • G.S. = Glass Size

NOTE: All measurements are nominal. Elevation charts are not to scale.

Radius units are sash set as standard. Direct set units are available but glass sizes differ from chart shown. Contact your supplier for details.

The units shown are stand-alone units. Adjustments may be required when stacking over other units; adjustments will be made in the factory.

Divided lites are optional. Divide lite pattern options are shown on pg. 126.





Some installation procedures will require a larger rough opening than noted (i.e. installations utilizing our installation clips), therefore, you may need to increase the rough opening size accordingly. Rough opening gaps may be increased up to a maximum of 1/2" on all sides and still be within good practice guidelines. For rough opening recommendations, see pg. 216.

Additional and the most current drawings are available at www.kolbwindows.com.

Radius Windows | Elevation Charts









Elliptical Units | Casements

F.S.	4'-0"	5'-0"	6'-0"	7'-6"	8'-0"
R.O.	4'-0 1/2"	5'-0 1/2"	6'-0 1/2"	7'-6 1/2"	8'-0 1/2"
G.S.	42 5/8"	54 5/8"	66 5/8"	84 5/8"	90 5/8"





1'-6"					
1'-6 1/2"	EHKW2	EHKX2	EHKW3	EHKX3	EHKW4
12 5/8"					

Elliptical Units | Double Hungs

F.S.	3'-7"	4'-3"	4'-11"	5'-4 1/2"	5'-7"	6'-3"	6'-4 1/2"	6'-11"
R.O.	3'-7 1/2"	4'-3 1/2"	4'-11 1/2"	5'-5"	5'-7 1/2"	6'-3 1/2"	6'-5"	6'-11 1/2"
G.S.	37 1/2"	45 1/2"	53 1/2"	59"	61 1/2"	69 1/2"	71"	77 1/2"





1'-6"								
1'-6 1/2"	EH16-2DH	EH20-2DH	EH24-2DH	EH16-3DH	EH28-2DH	EH32-2DH	EH20-3DH	EH36-2DH
12 1/2"								

F.S.	7'-4 1/2"	7'-7"	8'-4 1/2"	9'-4 1/2"	10'-4 1/2"
R.O.	7'-5"	7'-7 1/2"	8'-5"	9'-5"	10'-5"
G.S.	83"	85 1/2"	95"	107"	119"



1'-6"					
1'-6 1/2"	EH24-3DH	EH40-2DH	EH28-3DH	EH32-3DH	EH36-3DH
12 1/2"					

Elliptical Units | Garden-Aire Sliding Patio Doors

F.S.	4'-11"	5'-0"	5'-11"	6'-0"
R.O.	4'-11 1/2"	5'-0 1/2"	5'-11 1/2"	6'-0 1/2"
G.S.	51 13/16"	52 13/16"	63 13/16"	64 13/16"

1'-6"				
1'-6 1/2"	EHG411	EHG50	EHG511	EHG60
10 13/16"				

F.S.	6'-6"	7'-11"	8'-0"
R.O.	6'-6 1/2"	7'-11 1/2"	8'-0 1/2"
G.S.	70 13/16"	87 13/16"	88 13/16"

1'-6"			
1'-6 1/2"	EHG66	EHG711	EHG80
10 13/16"			

F.S. = Frame Size • R.O. = Rough Opening • G.S. = Glass Size

NOTE: All measurements are nominal. Elevation charts are not to scale.

Radius units are sash set as standard. Direct set units are available but glass sizes differ from chart shown. Contact your supplier for details.

The units shown are stand-alone units. Adjustments may be required when stacking over other units; adjustments will be made in the factory.

Divided lites are optional. Divide lite pattern options are shown on pg. 126.

Some installation procedures will require a larger rough opening than noted (i.e. installations utilizing our installation clips), therefore, you may need to increase the rough opening size accordingly. Rough opening gaps may be increased up to a maximum of 1/2" on all sides and still be within good practice guidelines. For rough opening recommendations, see pg. 216.

Additional and the most current drawings are available at www.kolbewindows.com.

Elliptical Units | Inswing Patio Doors

F.S.	4'-11 7/16"	5'-11 7/16"
R.O.	4'-11 15/16"	5'-11 15/16"
G.S.	53 15/16"	65 15/16"

1'-6"
1'-6 1/2"
12 1/2"

EHS411 EHS511

Elliptical Units | Inswing Entrance Doors

F.S.	4'-2 3/16"	5'-2 3/16"	5'-6 3/16"	6'-2 3/16"
R.O.	4'-2 11/16"	5'-2 11/16"	5'-6 11/16"	6'-2 11/16"
G.S.	44 11/16"	56 11/16"	60 11/16"	68 11/16"

1'-6"
1'-6 1/2"
12 1/2"

EHXD40 EHXD50 EHXD54 EHXD60

Elliptical Units | Outswing Entrance Doors

F.S.	4'-2 7/8"	5'-2 7/8"	5'-6 7/8"	6'-2 7/8"
R.O.	4'-3 3/8"	5'-3 3/8"	5'-7 3/8"	6'-3 3/8"
G.S.	44 1/4"	56 1/4"	60 1/4"	68 1/4"

1'-6"
1'-6 1/2"
11 3/8"

EHXD40-MAN EHXD50-MAN EHXD54-MAN EHXD60-MAN

Elliptical Units | Outswing Patio Doors

F.S.	5'-0 1/8"	6'-0 1/8"
R.O.	5'-0 5/8"	6'-0 5/8"
G.S.	53 1/2"	65 1/2"

1'-6"
1'-6 1/2"
11 3/8"

EHS411 EHS511

F.S. = Frame Size • R.O. = Rough Opening • G.S. = Glass Size

NOTE: All measurements are nominal. Elevation charts are not to scale.

Radius units are sash set as standard. Direct set units are available but glass sizes differ from chart shown. Contact your supplier for details.

The units shown are stand-alone units. Adjustments may be required when stacking over other units; adjustments will be made in the factory.

Divided lites are optional. Divide lite pattern options are shown on pg. 126.

Some installation procedures will require a larger rough opening than noted (i.e. installations utilizing our installation clips), therefore, you may need to increase the rough opening size accordingly. Rough opening gaps may be increased up to a maximum of 1/2" on all sides and still be within good practice guidelines. For rough opening recommendations, see pg. 216.

Additional and the most current drawings are available at www.kolbewindows.com.

Radius Windows | Elevation Charts

Quarter Circle Units | Casements

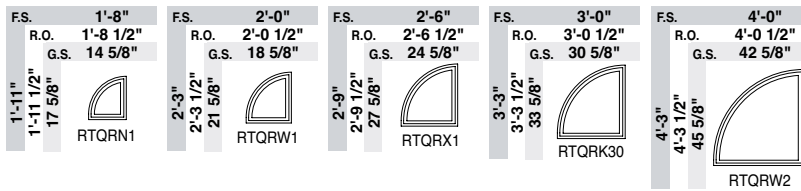

Quarter Circle Units | Double Hungs

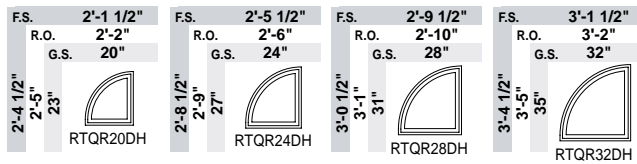

Full Circle Units

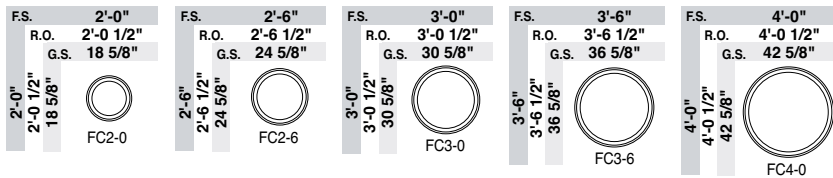

Oval Units

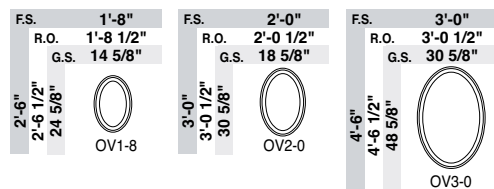

F.S. = Frame Size • R.O. = Rough Opening • G.S. = Glass Size

NOTE: All measurements are nominal. Elevation charts are not to scale.

Radius units are sash set as standard. Direct set units are available but glass sizes differ from chart shown. Contact your supplier for details.

The units shown are stand-alone units. Adjustments may be required when stacking over other units; adjustments will be made in the factory.

Divided lites are optional. Divide lite pattern options are shown on pg. 126.

Some installation procedures will require a larger rough opening than noted (i.e. installations utilizing our installation clips), therefore, you may need to increase the rough opening size accordingly. Rough opening gaps may be increased up to a maximum of 1/2" on all sides and still be within good practice guidelines. For rough opening recommendations, see pg. 216.

Additional and the most current drawings are available at www.kolbewindows.com.

Radius Windows | Cross Section Drawings

Standard Sash Set Radius Units

Horizontal

Vertical

To Match Casements

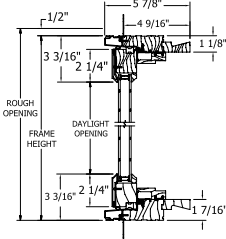
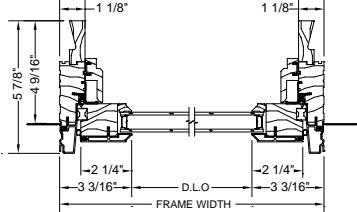

To Match Double Hungs

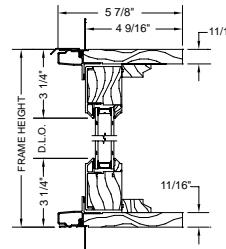
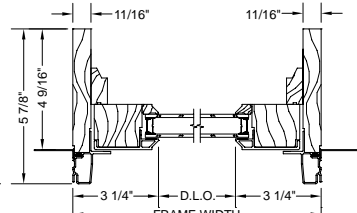

To Match Inswing Doors

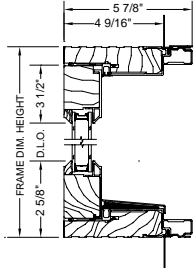
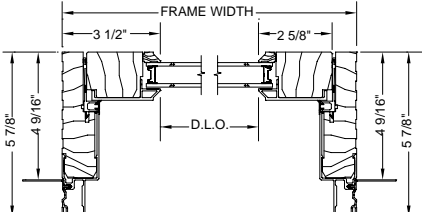

To Match Outswing Doors

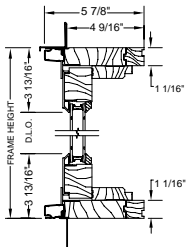
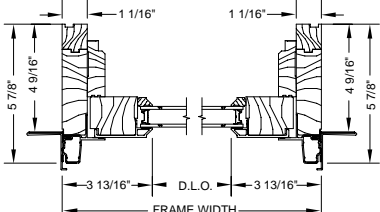

To Match Garden-Aire Sliding Patio Doors

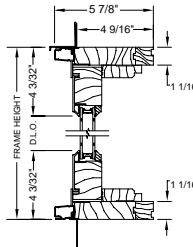
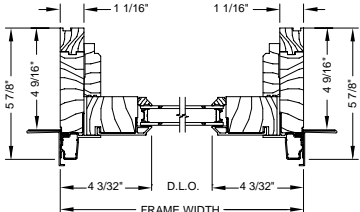

NOTE: Drawings are not to scale. Some units are shown with optional drip cap or nailing fin. Additional and the most current drawings are available at www.kolbwindows.com.

Radius Windows | Cross Section Drawings

Sash Set Radius Units with 1-15/16" Brickmould

Horizontal

Vertical

To Match
Casements

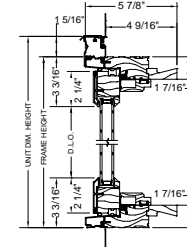
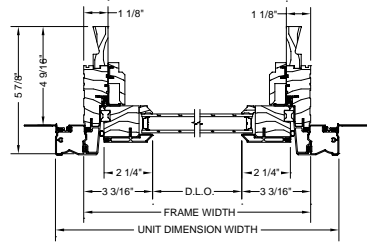

To Match
Double Hungs

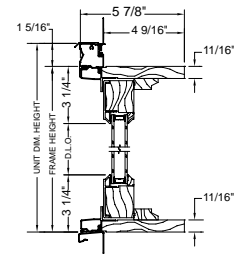
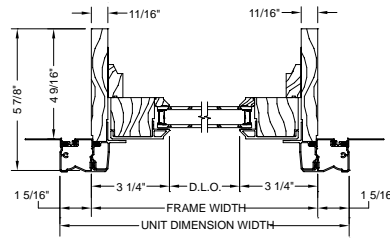

To Match
Inswing Doors

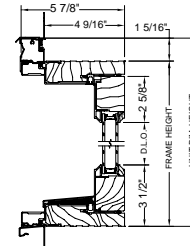
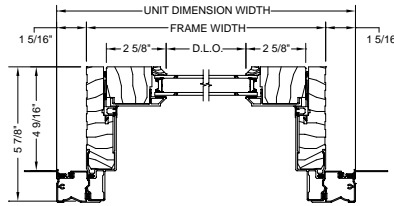

To Match
Outswing Doors

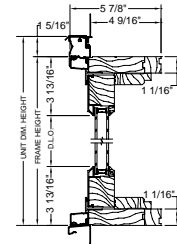
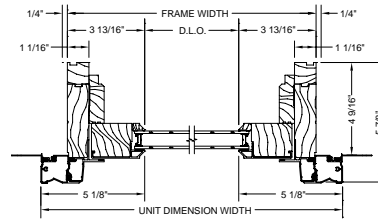

To Match
Garden-Aire Sliding
Patio Doors

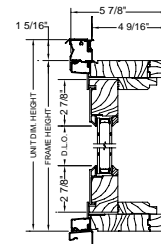
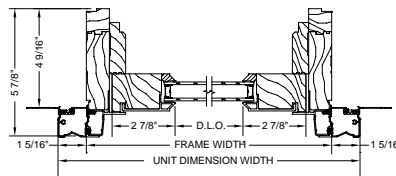

NOTE: Drawings are not to scale. Brickmould is shown factory-applied. Brickmould may be shipped loose for field application. Some units are shown with optional drip cap or nailing fin. For Ultra accessory or application drawings, see pgs. 206-212. Additional and the most current drawings are available at www.kolbewindows.com.

Direct Set Radius Units

Horizontal

Vertical

To Match
Casements

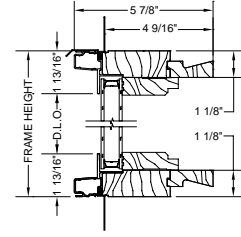
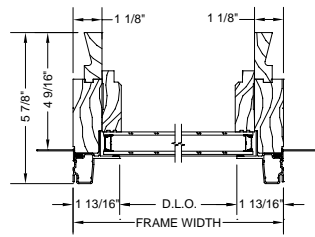

To Match
Double Hungs

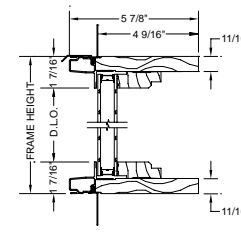
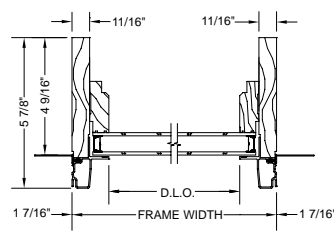

To Match
Inswing Doors

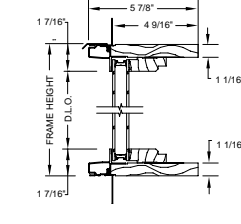
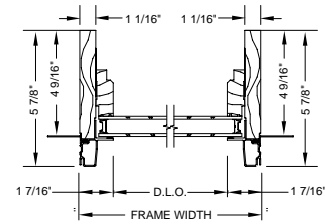

To Match
Outswing Doors

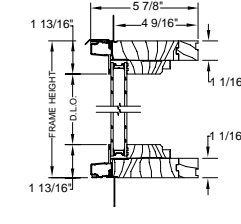
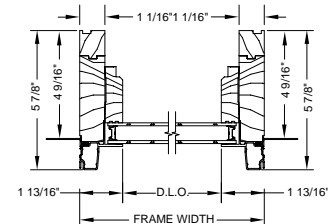

To Match
Garden-Aire Sliding
Patio Doors

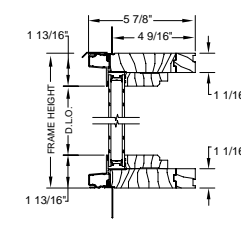
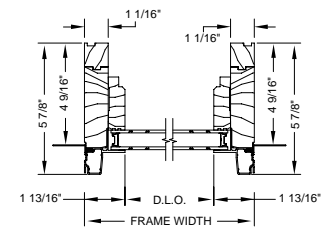

NOTE: Drawings are not to scale. Some units are shown with optional drip cap or nailing fin. Window profile also available for other non-radius shapes. For Ultra accessory or application drawings, see pgs. 206-212. Additional and the most current drawings are available at www.kolbwindows.com.

Radius Windows | Cross Section Drawings

Direct Set Radius Units with 1-15/16" Brickmould

Horizontal

Vertical

To Match
Casements

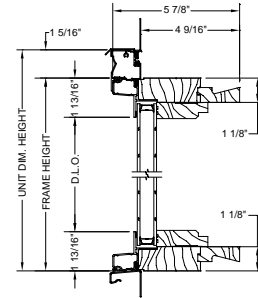
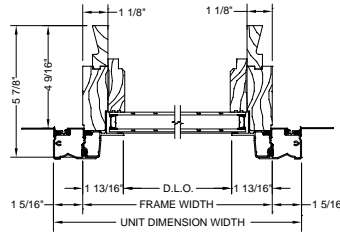

To Match
Double Hungs

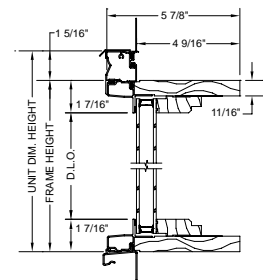
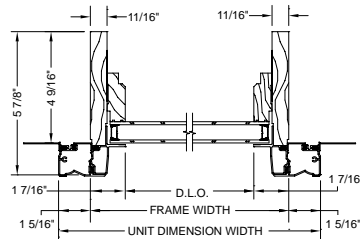

To Match
Inswing Doors

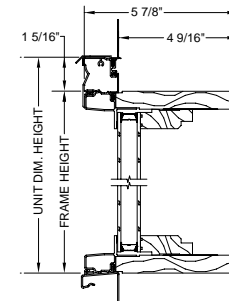
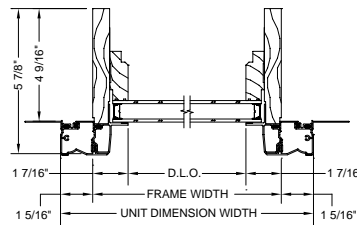

To Match
Outswing Doors

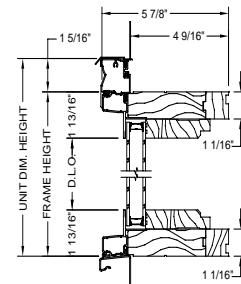
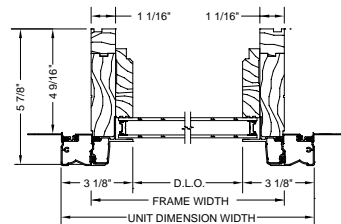

To Match
Garden-Aire Sliding
Patio Doors

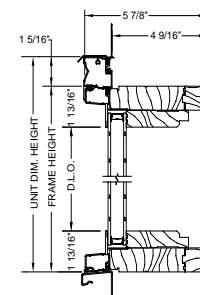
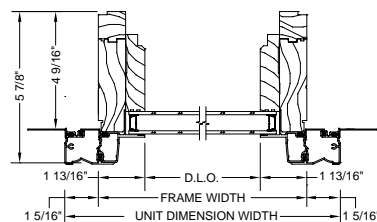

NOTE: Drawings are not to scale. Brickmould is shown factory-applied. Brickmould may be shipped loose for field application. Some units are shown with optional drip cap or nailing fin. Window profile also available for other non-radius shapes. For Ultra accessory or application drawings, see pgs. 206-212. Additional and the most current drawings are available at www.kolbewindows.com.

Stacking Detail Drawings

Sash Set

Direct Set

Radius stacked
over Crank-Out
Casement

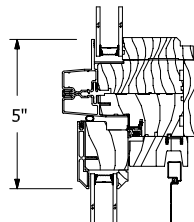
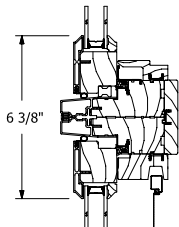

Radius stacked
over Traditional
Double Hung

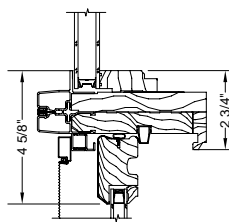
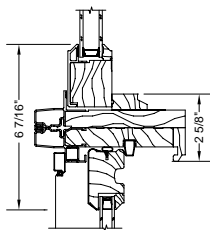

Radius stacked
over Garden-Aire
Sliding Patio Door

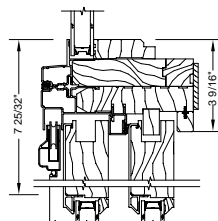
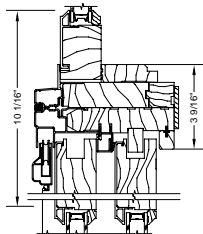

Radius stacked
over Inswing
Patio or Inswing
Entrance Door

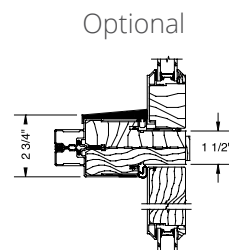
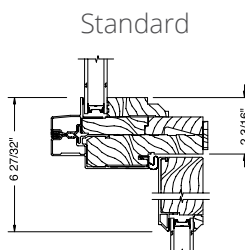
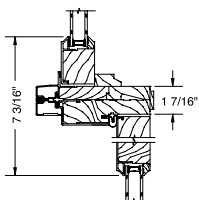

Radius stacked
over Outswing
Entrance Door

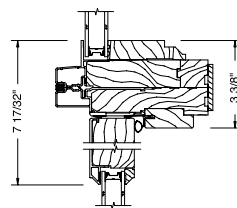
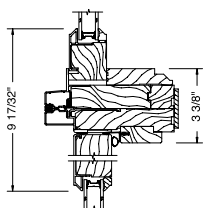

NOTE: Drawings are not to scale. More stacking details are available at www.kolbwindows.com.

Direct Sets | Cross Section Drawings

Ogee Direct Sets

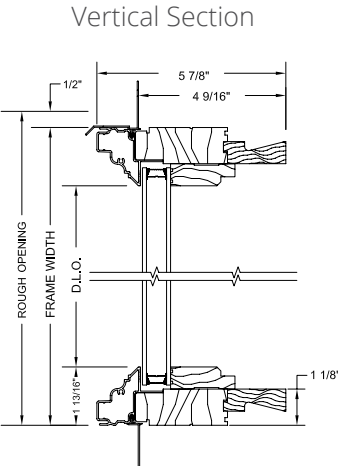
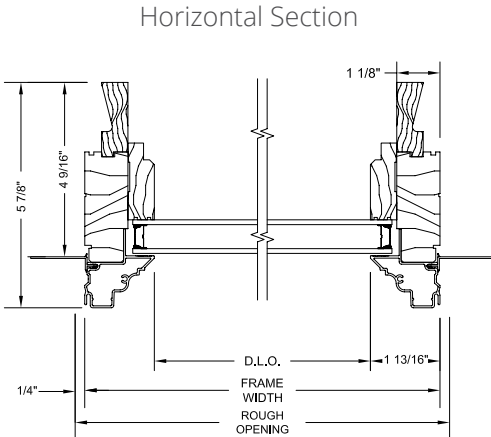

NOTE: Drawings are not to scale. Additional and the most current drawings are available at www.kolbewindows.com.

Beveled Direct Sets

Horizontal Section

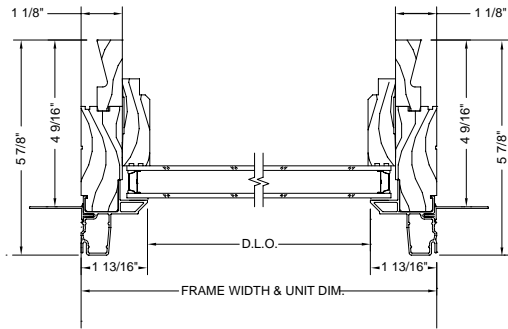

Vertical Section

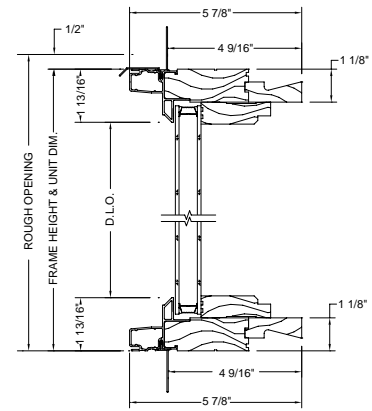

Beveled XL Direct Sets

Horizontal Section

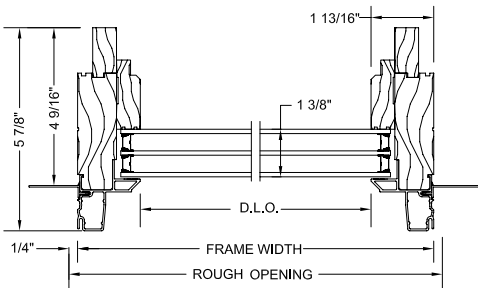

Vertical Section

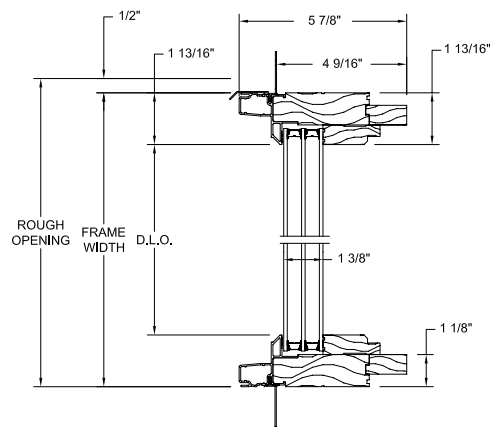

NOTE: Drawings are not to scale. Additional and the most current drawings are available at www.kolbwindows.com.





Patio & Entrance Doors

Whether it's a stunning entryway or a passageway to an outdoor living area, Ultra Series doors bring beauty and elegance to any project. Customize an entry to exemplify your personal aesthetic. Use folding doors, multi-slide doors, or TerraSpan® lift & slide doors to create expansive openings and take outdoor living space to a whole new level. Add interest to your inswing or outswing doors with matching transoms, sidelites, or radius units. The ability to coordinate with any décor is simple, with Kolbe's numerous options, finishes, and custom solutions to choose from.

*TerraSpan Lift & Slide Doors | Multi-Slide Doors | Garden-Aire Sliding Patio Doors | Folding Doors
Inswing Doors | Outswing Doors | Swinging Door Transoms | Sliding Door Transoms*

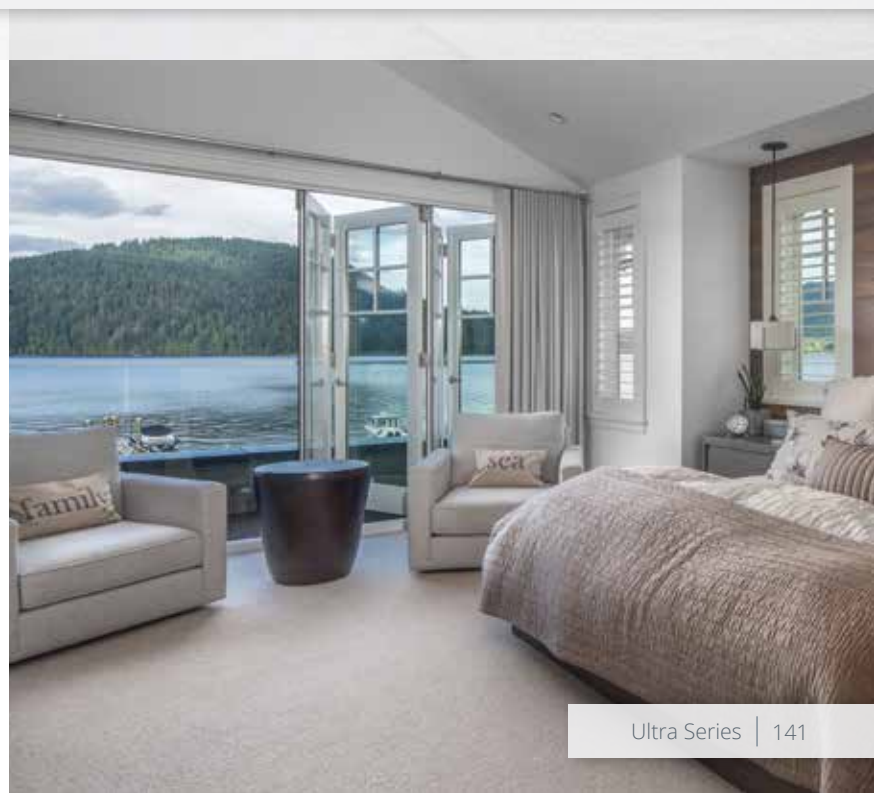

TerraSpan Lift & Slide Doors

TerraSpan lift & slide doors stack or pocket up to ten door panels for extremely expansive openings. They successfully merge outdoor areas with indoor living spaces for up to 60 feet of panoramic views. Over 900 operational configurations provide endless possibilities, with glass, finishes and hardware options for a customized opening to meet your needs.



© Gibeon Photography

TerraSpan Lift & Slide Door Standard Features

- ▶ 2-1/4" thick panels with end caps to match color or wood species
- ▶ Panels can pocket into a wall or stack together; 90° corner units are also available*
- ▶ 4-5/8" stiles and rails provide a large glass area
- ▶ Extruded aluminum exterior finished with a 70% PVDF fluoropolymer coating (*meets performance requirements of AAMA 2605*)
- ▶ Energy efficient, tempered Solar Low-E glass
- ▶ Glazed to the interior with a beveled wood cover
- ▶ Traditional coped stile and rail joints on both the interior and exterior
- ▶ Thermally broken fiberglass core frame and panels, finished on the interior with a solid wood cover
- ▶ Stainless steel multi-point locking hardware channels provide corrosion resistance and increased security
- ▶ Wheel sets are constructed of 300 series stainless steel to provide superior corrosion resistance (*drive bars, wheels, hubs and shafts, rivets, drive pins and link rods*)
- ▶ Panels available 30"-72" in width and 36"-144" in height
- ▶ LS100 removable handle set in Rustic Umber
- ▶ Black anodized flush mount weep sill is thermally broken with 1/2" roller cap height
- ▶ Pocket cover for all pocket doors
- ▶ No visible fasteners; glazing bracket is inter-locked and screwed from the interior side of the core and hidden by the interior wood panel cover
- ▶ Up to ten panels in a system

NOTE: All measurements are nominal.

* Curved units are also available; contact your Kolbe dealer for further information and to ask about the availability of other options not shown in this catalog

Hardware

- ▶ LS100 removable handle set in Rustic Umber, Bright Brass, Satin Nickel or Oil-Rubbed**
- ▶ LS300 removable handle set in Rustic Umber, Bright Brass, Satin Nickel or Oil-Rubbed**
- ▶ Fixed handle sets, double fixed handle sets and handle sets with or without keyed cylinders
- ▶ Finger pull in Bright Brass, Satin Nickel, Rustic Umber or Oil-Rubbed**
- ▶ Edge pull in Rustic Umber, Bright Brass, Satin Nickel, Oil-Rubbed** or Black (*not pictured*)
- ▶ Wall holding plate for removable handle in Rustic Umber, Bright Brass, Satin Nickel or Oil-Rubbed** (*not pictured*)

180° Inset Handle

This unique pivoting handle has clean lines that complement contemporary design, and is required for each panel in a door system. With optional exterior pulls and interior lock covers, it is available in Matte Black, Rustic Umber or Silver.

** The Oil-Rubbed finish is a living finish, which means that it will change appearance over time with use.

LS100 Handle

(shown in Rustic Umber)



LS300 Handle

(shown in Satin Nickel)



LS300 Finger Pull

(shown in Rustic Umber)



180° Inset Handle (shown in Rustic Umber)

Recessed

Operational





TerraSpan Lift & Slide Door Options

Glass (pg. 200)

- ▶ Solar Gain Low-E
- ▶ Solar Advanced Control Low-E
- ▶ Solar Control Low-E
- ▶ ThermaPlus™ Low-E
- ▶ Neat®
- ▶ Triple pane
- ▶ Patterned-, bronze-, or gray-lite
- ▶ Laminated
- ▶ Other options standard to the industry

Divided Lites (pg. 201)

- ▶ Performance divided lites with 5/8", 7/8", 1-1/8", 1-3/8", 1-3/4", 2-1/4" or 4-1/2" bars

Insect Screens

- ▶ Phantom® motorized executive insect screen
- ▶ Genius® insect screen
- ▶ Centor® insect screen
- ▶ Black pleated accordion insect screen

NOTE: All measurements are nominal.

Units with panel sizes wider than 72" and/or taller than 144" are available on a project-by-project basis, subject to review.

Sills

- ▶ Black anodized recessed sill (weep or non-weep) with 1/2" roller cap height
- ▶ Flush mount non-weep sill

Other Options (custom options are also available)

- ▶ Other wood species and FSC®-certified wood (pg. 198)
- ▶ Ovolo or square profile interior wood cover and interior divided lite bars (pg. 201)
- ▶ Interior prefinishing (pg. 198)
- ▶ Interior casing
- ▶ Automated options for ease of use
- ▶ 180° Inset Handle
- ▶ Pre-installed jamb jacks with color matched screw covers
- ▶ Interior flush sill nosing extensions
- ▶ 8-11/16" bottom rail height to match other Kolbe products
- ▶ 12" bottom rail height for meeting ADA compliance
- ▶ High performance or impact performance modifications (pg. 205)

Multi-Slide Doors

Multi-slide doors upgrade standard patio door openings by expanding rooms to merge the outdoors with the indoors. Doors can open up to 24 feet wide and 10 feet high, with various stile and rail options and panel thicknesses available. Multiple configurations – including stacking and pocketing units — offer exceptional flexibility.



Multi-Slide Door Standard Features

- ▶ 1-3/4" thick panel
- ▶ Jamb depth is dependent on the number of panels used; interior extension jamb wood species to match interior of panels
- ▶ Stiles and top rails are a nominal 4-5/8" wide; bottom rail is a nominal 7-9/16" high
- ▶ Frame shipped knocked down, prepped for assembly
- ▶ Frame is constructed of Dark Bronze anodized aluminum with pine interior stops
- ▶ Exterior wood parts are treated
- ▶ Extruded aluminum exterior finished with a 70% PVDF fluoropolymer coating (*meets performance requirements of AAMA 2605*)
- ▶ Energy efficient, tempered Solar Low-E glass
- ▶ Glazed to the interior with beveled wood glazing beads
- ▶ Panel interlock is attached to and is a part of the frame for pocketing systems
- ▶ Narrow flush pull handle is standard on lead panel
- ▶ Dual-point lock
- ▶ Dark Bronze anodized continuous full-width weep sill with stainless steel roller caps (*sill is prepped for water drainage and requires the use of a sill pan; can be set into the floor system for low profile use*)
- ▶ Thermally broken sill and frame
- ▶ Bottom rolling system with precision bearing wheels
- ▶ Folding aluminum nailing fin applied
- ▶ Extruded aluminum filler to cover head track and side jambs
- ▶ Black weather stripping and interlocks

NOTE: All measurements are nominal.

* Standard only on units without brickmould.

Hardware

- ▶ Narrow flush pull handle in Satin Nickel, Brushed Chrome, White, Bright Brass PVD[†], Rustic Umber or Matte Black
- ▶ Madison handle set with dual-point locks available in Satin Nickel PVD[†], Brushed Chrome PVD[†], White, Bright Brass PVD[†], Antique Brass, Rustic Umber or Matte Black.
- ▶ Dallas handle set with multi-point locks available in Silver, Rustic Umber, Matte Black or Brushed Gold.
- ▶ Multi-point hardware in Bell or Arch escutcheon. Available in Bright Brass PVD[†], Satin Nickel PVD[†], Antique Brass, Antique Nickel PVD[†], Smoky Gray PVD[†], Rustic Umber, Oil-Rubbed** or Matte Black.
- ▶ Keyed lock
- ▶ Edge pull on innermost panel of pocketing systems for ease of operation (*not pictured*).

[†]PVD (Physical Vapor Deposition) finish is an application over the color which helps protect the finish from tarnishing, peeling, and cracking.

** The Oil-Rubbed finish is a living finish, which means that it will change appearance over time with use.

Narrow Flush Pull Handle

(shown in Matte Black)
Interior

(shown in Satin Nickel
with keyed cylinder)
Exterior

Madison Handle

(shown in Matte Black)
Interior

(shown in Antique Brass)
Exterior

Dallas Handle

(shown in Rustic Umber)
Interior

(shown in Brushed Gold
with keyed cylinder)
Exterior





Photo courtesy of GD Nielsen Homes

Multi-Slide Door Options

Glass (pg. 200)

- ▶ Solar Gain Low-E
- ▶ Solar Advanced Control Low-E
- ▶ Solar Control Low-E
- ▶ ThermaPlus™ Low-E
- ▶ Neat®
- ▶ Triple pane^y
- ▶ Patterned-, bronze-, or gray-lite
- ▶ Laminated
- ▶ Other options standard to the industry

Divided Lites (pg. 201)

- ▶ Performance divided lites with 5/8", 7/8", 1-1/8", 1-3/8", 1-3/4", 2-1/4" or 4-1/2" bars
- ▶ Grilles-in-the-airspace

NOTE: All measurements are nominal.

Both stacking and pocketing frames are available up to a maximum of 24 feet in length. Maximum panel width is 48"; maximum panel height is 120"; maximum number of panels is 10; panels over 96" in height are required to be 2-1/4" thick. 4-5/8" minimum bottom rail is required with 3" stiles. Radius systems are not available.

¥ 2-1/4" panels only; size limitations apply. Contact your Kolbe dealer for more information.

Insect Screens

- ▶ Black pleated retractable insect screen

Other Options (custom options are also available)

- ▶ Stile and top rail options: 3", 4-5/8" or 6"
- ▶ Bottom rail options: 4-5/8", 6", 7-9/16" or 12-5/8"
- ▶ 2-1/4" thick panel
- ▶ Other wood species and FSC®-certified wood
- ▶ Ovolo or square profile glazing beads and interior divided lite bars (pg. 201)
- ▶ Interior prefinishing (pg. 198)
- ▶ Interior casing
- ▶ Automated options for ease of use
- ▶ Extension jambs in a wide variety of sizes (shipped loose for field application)

Operational Options

- ▶ Stacking: one way or bi-parting (French)
- ▶ Pocketing: one way or bi-parting (French)
- ▶ 90 degree corner (custom)
- ▶ Custom degree corners



Jamb Covers

Multi-slide doors feature an extruded aluminum filler, color matched to the exterior, to cover the head track and side jambs.

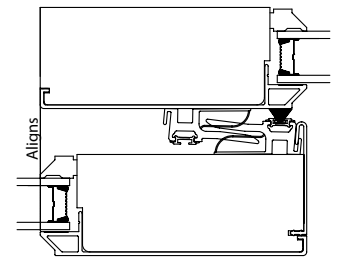

Aligned Stiles

The stiles of multi-slide door panels align perfectly when panels are closed, offering the maximum view.

Multi-point Hardware Arch Escutcheon

(shown in Antique Nickel PVD[†])



Multi-point Hardware Bell Escutcheon

(shown in Smoky Gray PVD[†])



Garden-Aire Sliding Patio Doors

Sliding patio doors are a space-saving way to connect your indoor and outdoor living spaces. Slide the doors from side-to-side to operate and create access to the outdoors. Sliding patio doors are available in various sizes to accommodate new construction or remodeling projects.



Garden-Aire Sliding Patio Door Standard Features

- ▶ 1-3/4" thick panel
- ▶ Overall jamb width is 4-9/16"
- ▶ Stiles and top rails are a nominal 4-5/8" wide; bottom rail is a nominal 7-9/16" high
- ▶ Frame set up
- ▶ Constructed of pine, with pine interior stops and wood mull casings on mullied units
- ▶ Exterior wood parts are treated
- ▶ Extruded aluminum exterior finished with a 70% PVDF fluoropolymer coating (*meets performance requirements of AAMA 2605*)
- ▶ Energy efficient, tempered Solar Low-E glass
- ▶ Glazed to the interior with beveled wood glazing beads
- ▶ Accessory grooves are integral to the extruded frames for the easy addition of accessories
- ▶ Tandem rollers with adjustable ball-bearing wheels carry the sliding panel
- ▶ Single-point mortise latch with handle set in Bright Brass
- ▶ Insect screen with BetterVue® fiberglass mesh and extruded aluminum frame
- ▶ One-piece, pultruded fiberglass sill with continuous aluminum sill nosing and fiberglass sill filler
- ▶ Thick oak interior threshold
- ▶ Black weather stripping and interlocks
- ▶ Heavy vinyl nailing fins with head drip caps*

NOTE: All measurements are nominal.

* Standard only on units without brickmould.

Hardware

- ▶ Single-point mortise latch with handle set available in Bright Brass, Antique Brass, Satin Nickel, Antique Nickel, Rustic Umber, Matte Black, Oil-Rubbed** or Smoky Gray.
- ▶ Narrow flush pull handle available in Satin Nickel PVD†, Brushed Chrome PVD†, White, Bright Brass PVD†, Rustic Umber or Matte Black.
- ▶ Madison handle set with dual-point locks available in Satin Nickel PVD†, Brushed Chrome PVD†, White, Bright Brass PVD†, Antique Brass, Rustic Umber or Matte Black.
- ▶ Dallas handle set with multi-point locks available in Silver, Rustic Umber, Matte Black or Brushed Gold.
- ▶ Corrosion-resistant, multi-point hardware in Bell or Arch escutcheon. Available in Bright Brass PVD†, Satin Nickel PVD†, Antique Brass, Antique Nickel PVD†, Smoky Gray PVD†, Rustic Umber, Oil-Rubbed** or Matte Black.
- ▶ Keyed lock
- ▶ Secondary security lock (*not pictured*)

†PVD (Physical Vapor Deposition) finish is an application over the color which helps protect the finish from tarnishing, peeling, and cracking.

** The Oil-Rubbed finish is a living finish, which means that it will change appearance over time with use.

Single-point Hardware

(shown in Antique Nickel)



Narrow Flush Pull Handle

(shown in Matte Black)
Interior



(shown in Satin Nickel PVD†
with keyed cylinder)
Exterior



Madison Handle

(shown in Matte Black)
Interior



(shown in Antique Brass)
Exterior



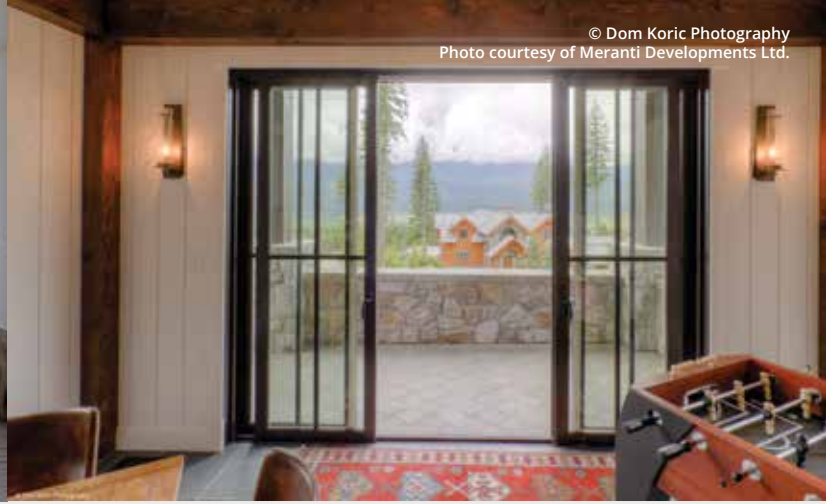

Garden-Aire Sliding Patio Door Options

Glass (pg. 200)

- ▶ Solar Gain Low-E
- ▶ Solar Advanced Control Low-E
- ▶ Solar Control Low-E
- ▶ ThermaPlus™ Low-E
- ▶ Neat®
- ▶ Triple pane
- ▶ Patterned-, bronze-, or gray-lite
- ▶ Laminated
- ▶ Other options standard to the industry

Divided Lites (pg. 201)

- ▶ Performance divided lites with 5/8", 7/8", 1-1/8", 1-3/8", 1-3/4", 2-1/4" or 4-1/2" bars
- ▶ Grilles-in-the-airspace

Insect Screens

- ▶ "Ultra" sliding insect screen with extruded aluminum frame and fiberglass mesh
- ▶ Insect screen with UltraVue® fiberglass mesh or aluminum mesh

NOTE: All measurements are nominal.

Other Options (custom options are also available)

- ▶ 3" stiles and top rail
- ▶ 4-5/8" bottom rail
- ▶ Other wood species and FSC®-certified wood (pg. 198)
- ▶ Available as a 3-wide unit in an Active-Fixed-Active configuration
- ▶ Available as a 4-wide unit in a Fixed-Active-Active-Fixed configuration
- ▶ Ovolo or square profile glazing beads and interior divided lite bars (pg. 201)
- ▶ Interior prefinishing (pg. 198)
- ▶ Interior casing
- ▶ Extruded aluminum accessories applied to accessory grooves on the exterior frame (pgs. 206-212)
- ▶ Extension jambs in a wide variety of sizes (shipped loose for field application)
- ▶ Automated options for ease of use
- ▶ Galvanized steel installation clips
- ▶ Universal design aluminum sill ramp kits
- ▶ High performance or impact performance modifications (pg. 205)

Dallas Handle

(shown in Rustic Umber)
Interior

(shown in Brushed Gold
with keyed cylinder)
Exterior

Multi-point Hardware Arch Escutcheon

(shown in Antique Nickel PVD*)

Multi-point Hardware Bell Escutcheon

(shown in Oil-Rubbed**)



Folding Doors

Breathe in the fresh air, add architectural interest, and merge outdoor and indoor spaces with folding doors. A variety of operating styles include doors that swing out, fold to one side, or split and fold to either side to allow massive views.



Copyright © Marco Zecchin/Image Center

Folding Door Standard Features

- ▶ 1-3/4" thick panels
- ▶ 6-9/16" minimum jamb width
- ▶ Stiles and top rails are a nominal 4-5/8" wide; bottom rail is a nominal 7-9/16" high
- ▶ Frame set up for units up to 177" wide x 106" tall; all others knocked down
- ▶ Constructed of pine, with pine interior stops
- ▶ Exterior wood parts are treated
- ▶ Extruded aluminum exterior finished with a 70% PVDF fluoropolymer coating (*meets performance requirements of AAMA 2605*)
- ▶ Accessory grooves are integral to the extruded frames for the easy addition of accessories
- ▶ Energy efficient, tempered Solar Low-E glass
- ▶ Glazed to the interior with beveled wood glazing beads
- ▶ Multi-point mortise latch with Toronto handle set in a Bright Brass PVD* finish on configurations with an access panel
- ▶ Hinge handles standard on most panels
- ▶ Face mounted flush bolt locking hardware on folding panels
- ▶ Bronze anodized aluminum weep sill
- ▶ Grooved guide rollers with adjustable, ball-bearing wheels carry the folding panels
- ▶ Thick oak interior threshold
- ▶ Heavy vinyl nailing fins with head drip caps*

NOTE: All measurements are nominal.

* Standard only on units without brickmould.

Hardware

- ▶ Face-mounted flush bolt locking hardware on folding panels if a handle is not desired. Available in Matte Black, Bright Brass, Chrome or Satin Nickel.
- ▶ Uno[†] or Aria handle set for folding panels with concealed shootbolt locking hardware. Available in Matte Black, Brushed Chrome, Bright Brass or Chrome.
- ▶ Hinges with handles in Bright Brass, Chrome, Satin Nickel or Matte Black.
- ▶ Finger pulls for panels without hinge handles in Bright Brass, Chrome, Satin Nickel or Matte Black.
- ▶ For units with a swinging panel, choose a Toronto, München, Verona or Dallas^{††} handle set. Available in Bright Brass PVD*, Antique Brass, Satin Nickel PVD*, Antique Nickel PVD*, Oil-Rubbed**, Rustic Umber, Matte Black or Smoky Gray PVD* (*pgs. 154-155*).
- ▶ For units with a swinging panel, choose a handle set from Baldwin® Hardware (*pg. 156*) in a variety of finishes.
- ▶ Magnetic latches or panel stays are available to assist in keeping windows stationary while open.

† Uno handle set is only available in Brushed Chrome and Matte Black.

†† Dallas handle set is only available in Bright Brass PVD, Satin Nickel PVD, Rustic Umber, Matte Black, Smoky Gray PVD and Matte Black/Brushed Gold.

*PVD (Physical Vapor Deposition) finish is an application over the color which helps protect the finish from tarnishing, peeling, and cracking.

**The Oil-Rubbed finish is a living finish, which means that it will change appearance over time with use.

Flush Bolt (shown in Satin Nickel)

Concealed Shoot Bolt

Uno[†] Handle

(shown in Matte Black)

Aria Handle

(shown in Chrome)



Photo courtesy The Alexis Agency



Photo courtesy The Alexis Agency

Folding Door Options

Glass (pg. 200)

- ▶ Solar Gain Low-E
- ▶ Solar Advanced Control Low-E
- ▶ Solar Control Low-E
- ▶ ThermaPlus™ Low-E
- ▶ Neat®
- ▶ Triple pane^v
- ▶ Patterned-, bronze-, or gray-lite
- ▶ Laminated
- ▶ Other options standard to the industry

Divided Lites (pg. 201)

- ▶ Performance divided lites with 5/8", 7/8", 1-1/8", 1-3/8", 1-3/4", 2-1/4" or 4-1/2" bars
- ▶ Grilles-in-the-air-space

Insect Screens

- ▶ Black pleated retractable insect screen

Sills

- ▶ Recessed floor track sill (*interior*), weep or non-weep in a Bronze anodized finish
- ▶ Weep sill in a Clear anodized finish

NOTE: All measurements are nominal.

When folding doors are ordered with 3" stiles and panel size is larger than 8', panel thickness must be 2-1/4"

¥ 2-1/4" panels only; size limitations apply. Contact your Kolbe dealer for more information.

Other Options: (custom options are also available)

- ▶ Stile and top rail options: 3" or 6"
- ▶ Bottom rail options: 4-5/8", 6", 7-9/16" or 12-5/8"
- ▶ 2-1/4" thick panel
- ▶ Other wood species and FSC®-certified wood (pg. 198)
- ▶ Ovolo or square profile glazing beads and interior divided lite bars (pg. 201)
- ▶ Interior prefinishing (pg. 198)
- ▶ Interior casing
- ▶ Extruded aluminum accessories applied to accessory grooves on the exterior frame (pgs. 206-212)
- ▶ Extension jambs in a wide variety of sizes (*shipped loose for field application if over 12"*)
- ▶ Galvanized steel installation clips
- ▶ High performance or impact performance modifications (pg. 205)



Hinge Handle

(shown in Matte Black)



Finger Pull

(shown in Satin Nickel)

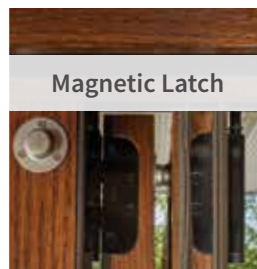

Magnetic Latch

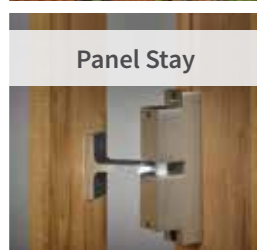

Panel Stay

Inswing Doors

Whether it's an entrance door or a patio door, inswing doors provide convenient access between spaces. A corresponding radius, transom or sidelite unit can allow even more illumination, while additional options and custom solutions provide ample opportunity for personalization.



Inswing Door Standard Features

- ▶ 1-3/4" thick panel, prehung in a 1-5/16" frame
- ▶ Overall jamb width is 4-9/16"
- ▶ Stiles and top rails are a nominal 4-5/8" wide; bottom rail is a nominal 7-9/16" high
- ▶ Constructed of pine, with pine interior stops and wood mull casings on mullied units
- ▶ Exterior wood parts are treated
- ▶ Extruded aluminum exterior finished with a 70% PVDF fluoropolymer coating (*meets performance requirements of AAMA 2605*)
- ▶ Accessory grooves are integral to the extruded frames for the easy addition of accessories
- ▶ Energy efficient, tempered Solar Low-E glass
- ▶ Glazed to the interior with beveled wood glazing beads
- ▶ Toronto handle set in a Bright Brass PVD[†] finish
- ▶ Stainless steel multi-point locking hardware on single door panels; French doors have a 3-point lock on the active panel and a 2-point lock on the less active panel
- ▶ Adjustable, 4" x 3-5/8" hinges with 5/8" radius corners in a Gold-painted finish
- ▶ "Ultra" sliding insect screen with BetterVue[®] fiberglass mesh and extruded aluminum frame
- ▶ Bronze anodized aluminum, weep sill with an oak interior threshold
- ▶ Heavy vinyl nailing fins with head drip caps*
- ▶ Raised panels and/or glass lites

NOTE: All measurements are nominal.

* Standard only on units without brickmould.

†PVD (Physical Vapor Deposition) finish is an application over the color which helps protect the finish from tarnishing, peeling, and cracking.

Hardware

See entire swinging door hardware selection on pgs. 154-157.



Toronto Handle (shown in Satin Nickel PVD[†])



München Handle (shown in Bright Brass PVD[†])



Verona Handle (shown in Antique Nickel PVD[†])



Dallas Handle (shown in Smoky Gray PVD[†])



Inswing Door Options

Hardware (pgs. 154-156)

- ▶ Toronto, München or Verona handle set in Bright Brass PVD[†], Antique Brass, Satin Nickel PVD[†], Antique Nickel PVD[†], Oil-Rubbed^{**}, Rustic Umber, Matte Black or Smoky Gray PVD[†] (pgs. 154-155)
- ▶ Dallas handle set in Bright Brass PVD[†], Satin Nickel PVD[†], Rustic Umber, Matte Black, Smoky Gray PVD[†], or Matte Black/Brushed Gold
- ▶ Baldwin handle sets in various styles; available in Bright Brass PVD[†], Satin Brass PVD[†], Antique Brass, Satin Nickel PVD[†], Brushed Chrome, Antique Nickel, Oil-Rubbed^{**}, Rustic Umber, Matte Black or Distressed Smoky Gray (pg. 156)
- ▶ Keyed lock
- ▶ 2-point flush bolt lock on less active panel of French doors
- ▶ Single-point locking system
- ▶ Electronic multi-point lock (available for select single-panel doors up to 8 feet high and with stiles wider than 3"; not available on double or French door configurations. Not recommended for coastal applications.)

Hinges (pg. 157)

- ▶ Adjustable 4" x 3-5/8" hinges with 5/8" radius corners in Bright Brass PVD[†], Antique Brass, Brushed Chrome PVD[†], Satin Nickel PVD[†], Silver, Antique Nickel, Smoky Gray PVD[†], Oil-Rubbed^{**}, Rustic Umber or Matte Black
- ▶ Non-adjustable, residential 4" x 4" ball-bearing hinges with 1/4" radius corners in Bright Brass, Antique Brass, Satin Nickel, Antique Nickel, Stainless Steel, Oil-Rubbed^{**} or Matte Black
- ▶ Non-adjustable, commercial-grade 4" x 4" ball-bearing hinges with square corners in Bright Brass, Antique Brass, Stainless Steel, Oil-Rubbed^{**}, Matte Black or Satin Nickel
- ▶ Non-adjustable, commercial-grade 4-1/2" x 4-1/2" hinges in Bright Brass, Oil-Rubbed^{**} or Stainless Steel

Glass (pg. 200)

- ▶ Solar Gain Low-E
- ▶ Solar Advanced Control Low-E
- ▶ Solar Control Low-E
- ▶ ThermaPlus™ Low-E
- ▶ Neat®
- ▶ Triple pane[‡]
- ▶ Patterned-, bronze-, or gray-lite
- ▶ Laminated
- ▶ Other options standard to the industry

Divided Lites (pg. 201)

- ▶ Performance divided lites with 5/8", 7/8", 1-1/8", 1-3/8", 1-3/4", 2-1/4" or 4-1/2" bars
- ▶ Grilles-in-the-air-space

Insect Screens

- ▶ Self-closing, swinging insect screen includes a spring-loaded lock, aluminum frame to match exterior color of the unit and choice of BetterVue® or UltraVue® fiberglass mesh or aluminum mesh

Sills

- ▶ Clear anodized weep sill
- ▶ Adjustable sill in Bronze or Clear anodized
- ▶ Thermal or non-thermal ADA-compliant sill

Other Options (custom options are also available)

- ▶ 2-1/4" thick panel
- ▶ 3" or 6" stiles
- ▶ 12-5/8" bottom rail
- ▶ Flat panel
- ▶ Other wood species and FSC®-certified wood (pg. 198)
- ▶ Ovolo or square profile glazing beads and interior divided lite bars (pg. 201)
- ▶ Interior prefinishing (pg. 198)
- ▶ Interior casing
- ▶ Extruded aluminum accessories applied to accessory grooves on the exterior frame (pgs. 206-212)
- ▶ Factory-applied extension jambs in a variety of sizes
- ▶ Galvanized steel installation clips

NOTE: All measurements are nominal.

[†]PVD (Physical Vapor Deposition) finish is an application over the color which helps protect the finish from tarnishing, peeling, and cracking.

^{**}The Oil-Rubbed finish is a living finish, which means that it will change appearance over time with use.

[‡] 2-1/4" panels only; size limitations apply. Contact your Kolbe dealer for more information.

Outswing Doors

Outswing doors are available with the same multitude of options as inswing doors, but swing outward for areas that have indoor space constraints. Outswing entrance and patio doors are available in single, double and French units, and can be customized with sidelites or transoms to create a distinctive opening.



Outswing Door Standard Features

- ▶ 1-3/4" thick panel prehung in a 1-1/16" frame
- ▶ Overall jamb width is 4-9/16"
- ▶ Stiles and top rails are a nominal 4-5/8" wide; bottom rail is a nominal 7-9/16" high
- ▶ Constructed of pine, with pine interior stops and wood mull casings on mullied units
- ▶ Exterior wood parts are treated
- ▶ Extruded aluminum exterior finished with a 70% PVDF fluoropolymer coating (*meets performance requirements of AAMA 2605*)
- ▶ Accessory grooves are integral to the extruded frames for the easy addition of accessories
- ▶ Energy efficient, tempered Solar Low-E glass
- ▶ Glazed to the interior with beveled wood glazing beads
- ▶ Toronto handle set in Bright Brass PVD[†] finish
- ▶ Stainless steel multi-point locking hardware on single door panels; French doors have a 3-point lock on the active panel and a 2-point lock on the less active panel
- ▶ Non-adjustable, residential, 4" x 4" ball-bearing hinges with 1/4" radius corners in a Bright Brass finish
- ▶ Bronze anodized aluminum bumper sill with oak interior threshold
- ▶ Heavy vinyl nailing fins with head drip caps*
- ▶ Raised panels and/or glass lites

NOTE: All measurements are nominal.

* Standard only on units without brickmould.

[†]PVD (Physical Vapor Deposition) finish is an application over the color which helps protect the finish from tarnishing, peeling, and cracking.

Hardware

See entire swinging door hardware selection on pgs. 154-157.

Toronto Handle (shown in Antique Brass)



München Handle (shown in Antique Nickel PVD[†])



Verona Handle (shown in Rustic Umber)



Dallas Handle (shown in Satin Nickel PVD[†])





Outswing Door Options

Hardware (pgs. 154-156)

- ▶ Toronto, München or Verona handle set in Bright Brass PVD†, Antique Brass, Satin Nickel PVD†, Antique Nickel PVD†, Oil-Rubbed**, Rustic Umber, Matte Black or Smoky Gray PVD† (pgs. 154-155)
- ▶ Dallas handle set in Bright Brass PVD†, Satin Nickel PVD†, Rustic Umber, Matte Black, Smoky Gray PVD†, or Matte Black/Brushed Gold
- ▶ Baldwin handle sets in various styles; available in Bright Brass PVD†, Satin Brass PVD†, Antique Brass, Satin Nickel PVD†, Brushed Chrome, Antique Nickel, Oil-Rubbed**, Rustic Umber, Matte Black or Distressed Smoky Gray (pg. 156)
- ▶ Keyed lock
- ▶ 2-point flush bolt lock on less active panel of French doors
- ▶ Single-point locking system
- ▶ Electronic multi-point lock (available for select single-panel doors up to 8 feet high and with stiles wider than 3"; not available on double or French door configurations. Not recommended for coastal applications.)

Hinges (pg. 157)

- ▶ Adjustable 4" x 3-5/8" hinges with 5/8" radius corners in Bright Brass PVD†, Antique Brass, Brushed Chrome PVD†, Satin Nickel PVD†, Silver, Antique Nickel, Smoky Gray PVD†, Oil-Rubbed**, Rustic Umber or Matte Black
- ▶ Non-adjustable, residential 4" x 4" ball-bearing hinges with 1/4" radius corners in Bright Brass, Antique Brass, Satin Nickel, Antique Nickel, Stainless Steel, Oil-Rubbed** or Matte Black
- ▶ Non-adjustable, commercial-grade 4" x 4" ball-bearing hinges with square corners in Bright Brass, Antique Brass, Stainless Steel, Oil-Rubbed**, Matte Black or Satin Nickel
- ▶ Non-adjustable, commercial-grade 4-1/2" x 4-1/2" hinges in Bright Brass, Oil-Rubbed** or Stainless Steel

Glass (pg. 200)

- ▶ Solar Gain Low-E
- ▶ Solar Advanced Control Low-E
- ▶ Solar Control Low-E
- ▶ ThermaPlus™ Low-E
- ▶ Neat®
- ▶ Triple pane‡
- ▶ Patterned-, bronze-, or gray-lite
- ▶ Laminated
- ▶ Other options standard to the industry

Divided Lites (pg. 201)

- ▶ Performance divided lites with 5/8", 7/8", 1-1/8", 1-3/8", 1-3/4", 2-1/4" or 4-1/2" bars
- ▶ Grilles-in-the-airspace

Sills

- ▶ Clear anodized bumper sill
- ▶ Oak or Mahogany sill
- ▶ Thermal or non-thermal ADA-compliant sill

Other Options (custom options are also available)

- ▶ 2-1/4" thick panel
- ▶ 3" or 6" stiles
- ▶ 12-5/8" bottom rail
- ▶ Other wood species and FSC®-certified wood (pg. 198)
- ▶ Flat panel
- ▶ Ovolo or square profile glazing beads and interior divided lite bars (pg. 201)
- ▶ Interior prefinishing (pg. 198)
- ▶ Interior casing
- ▶ Extruded aluminum accessories applied to accessory grooves on the exterior frame (pgs. 206-212)
- ▶ Extension jambs (up to 12" applied, over 12" shipped loose for field application)
- ▶ Galvanized steel installation clips
- ▶ High performance or impact performance modifications (pg. 205)

NOTE: All measurements are nominal.

†PVD (Physical Vapor Deposition) finish is an application over the color which helps protect the finish from tarnishing, peeling, and cracking.

**The Oil-Rubbed finish is a living finish, which means that it will change appearance over time with use.

‡ 2-1/4" panels only; size limitations apply. Contact your Kolbe dealer for more information.

Swinging Door Hardware

Kolbe's handle sets are designed to complement the style of your home and coordinate with your doors. To truly customize your entrance, patio, or access door on a folding door unit, numerous hardware styles and finishes are available.



Toronto Handle Set



Bright Brass PVD[†]



Satin Nickel PVD[†]



Rustic Umber



Matte Black
(shown with keyed cylinder)



Smoky Gray PVD[†]



Antique Brass



Antique Nickel PVD[†]



Oil-Rubbed^{*}

München Handle Set



Bright Brass PVD[†]



Satin Nickel PVD[†]



Rustic Umber



Matte Black
(shown with keyed cylinder)



Smoky Gray PVD[†]



Antique Brass



Antique Nickel PVD[†]



Oil-Rubbed^{*}



Verona Handle Set



Bright Brass PVD†



Satin Nickel PVD†



Rustic Umber



Matte Black
(shown with keyed cylinder)



Smoky Gray PVD†



Antique Brass



Antique Nickel PVD†



Oil-Rubbed*

Dallas Handle Set



Bright Brass PVD†



Satin Nickel PVD†



Rustic Umber



Matte Black
(shown with keyed cylinder)



Smoky Gray PVD†



Matte Black/Brushed Gold††
(shown with keyed cylinder)

*The Oil-Rubbed finish is a living finish, which means that it will change appearance over time with use.

†PVD (Physical Vapor Deposition) finish is an application over the color which helps protect the hardware against tarnishing, peeling and cracking.

††This two-tone finish is only available in the combination shown.



Baldwin® Hardware Handle Sets

Baldwin handle sets, in the styles shown below, are available in Bright Brass PVD†, Satin Brass PVD†, Antique Brass, Satin Nickel PVD†, Brushed Chrome, Antique Nickel, Oil-Rubbed*, Rustic Umber, Matte Black or Distressed Smoky Gray.



Boulder
(shown in Rustic Umber)



Bristol
(shown in Satin Brass PVD†)



Cody
(shown in Oil-Rubbed)*



Concord
(shown in Antique Brass)



Kensington
(shown in Bright Brass PVD†)



Lakeshore
(shown in Satin Nickel PVD†)



Richland
(shown in Antique Nickel)



Santa Monica
(shown in Brushed Chrome)

*The Oil-Rubbed finish is a living finish, which means that it will change appearance over time with use.

†PVD (Physical Vapor Deposition) finish is an application over the color which helps protect the hardware against tarnishing, peeling and cracking.



Kenneth M. Wyner Photography, Inc.

Non-Adjustable Hinges

Residential-grade
4" x 4" ball-bearing with
1/4" radius corners



Bright
Brass



Antique
Brass



Satin
Nickel



Antique
Nickel



Stainless
Steel



Oil-
Rubbed*



Matte
Black

Commercial-grade
4" x 4" ball-bearing
with square corners



Bright
Brass



Antique
Brass



Satin
Nickel



Stainless
Steel



Oil-
Rubbed*



Matte
Black

Commercial-grade
4-1/2" x 4-1/2"
with square corners



Bright
Brass



Oil-
Rubbed*



Stainless
Steel

Adjustable Hinges

Residential-grade
4 x 3-5/8" with
5/8" radius corners



Gold-
Painted



Bright
Brass
PVD†



Antique
Brass



Brushed
Chrome
PVD†



Satin
Nickel
PVD†



Silver



Antique
Nickel



Smoky
Gray
PVD†



Oil-
Rubbed*



Rustic
Umber



Matte
Black

*The Oil-Rubbed finish is a living finish, which means that it will change appearance over time with use.

†PVD (Physical Vapor Deposition) finish is an application over the color which helps protect the hardware against tarnishing, peeling and cracking.

TerraSpan Lift & Slide Doors Panel Configurations

There are over 900 different operational configurations available for the TerraSpan lift & slide. Only a few are illustrated below. There is a maximum of 10 panels per unit. Panel width is a minimum of 30" with a maximum of 72", while panel height is a minimum of 78" with a maximum of 144". Pocketing lift and slides will not have a stationary panel on the end(s) of the operating unit. Talk with your local Kolbe dealer to learn about the different possibilities.

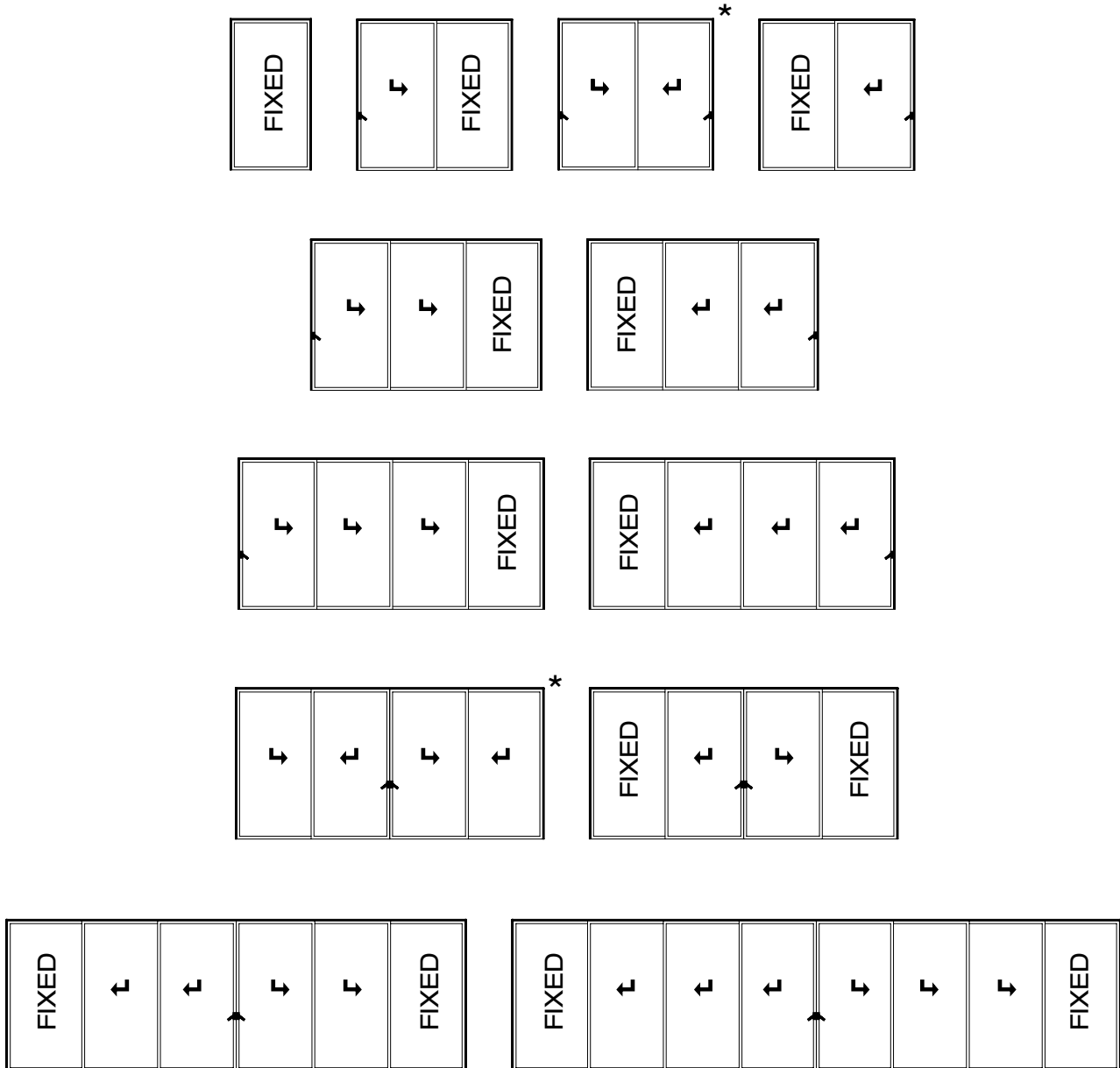

*Panel design is not available in a pocketing lift and slide.
NOTE: Drawings are not to scale.

TerraSpan Lift & Slide Doors Cross Section Drawings

2-Wide Stacking

Horizontal Section
door exterior

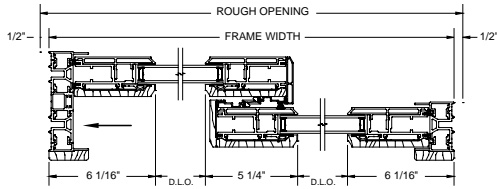

door interior

2-Wide Pocketing

Horizontal Section
door exterior

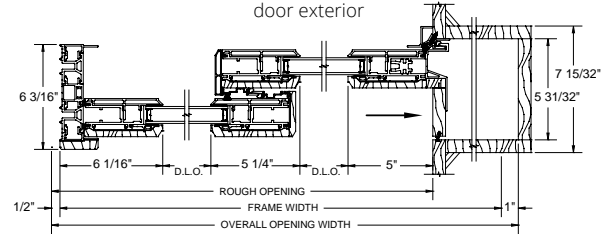

door interior

3-Wide Stacking

Horizontal Section
door exterior

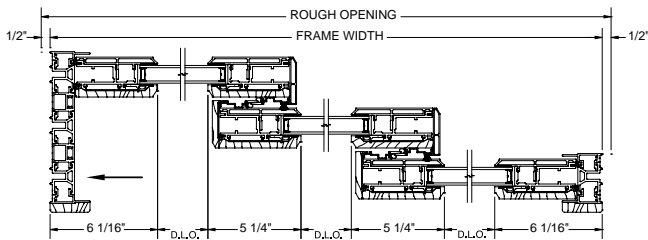

door interior

3-Wide Pocketing

Horizontal Section
door exterior

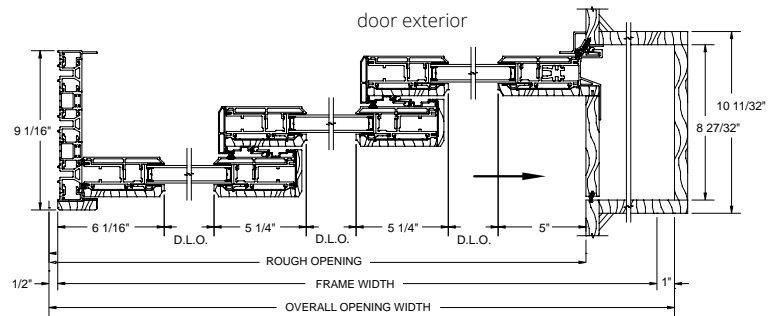

door interior

4-Wide Stacking – Center-Opening*

Horizontal Section
door exterior

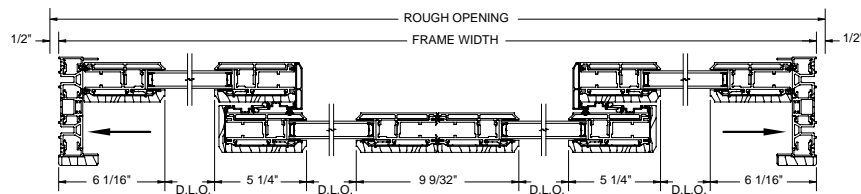

door interior

4-Wide Pocketing – Center-Opening*

Horizontal Section
door exterior

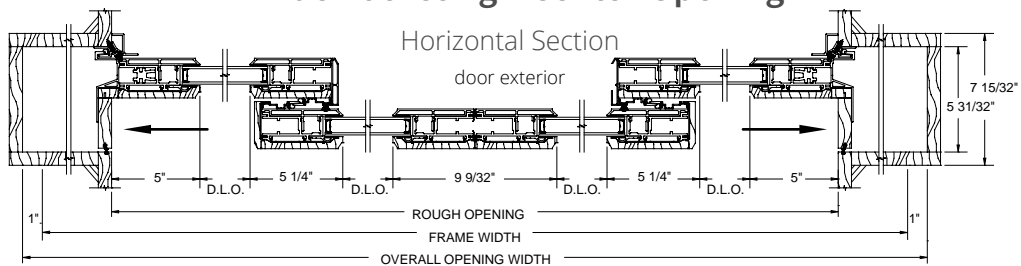

door interior

* There is no difference in the horizontal section details between a flush sill and a recessed sill for center-operating units.
NOTE: Drawings are not to scale. Additional and the most current drawings are available at www.kolbewindows.com.

TerraSpan Lift & Slide Doors Cross Section Drawings

90° Stacking (Recessed Sill Only)

Horizontal Section

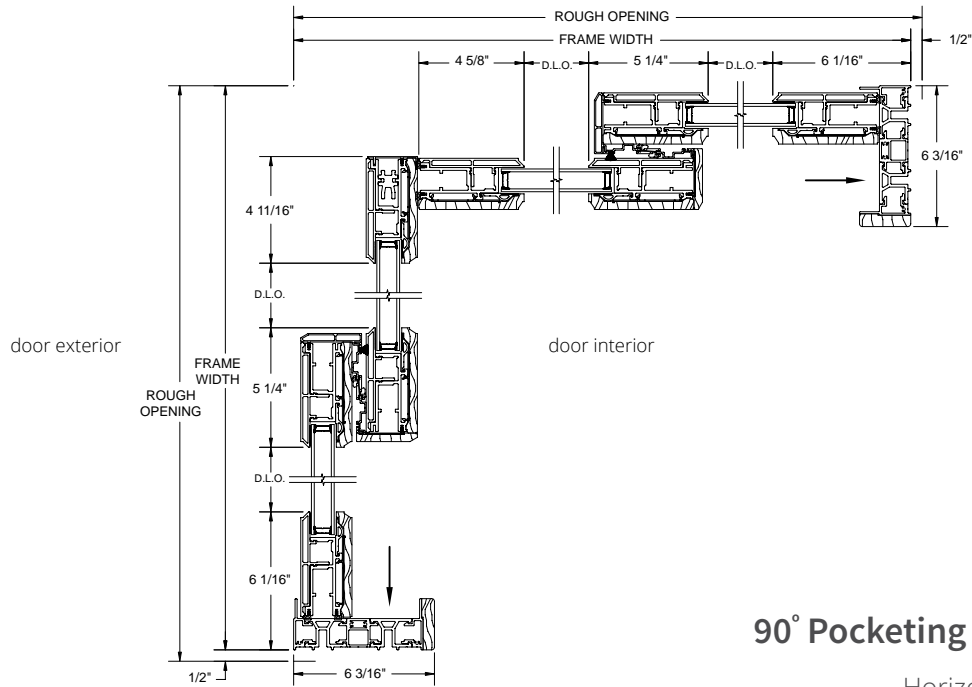

90° Pocketing (Recessed Sill Only)

Horizontal Section

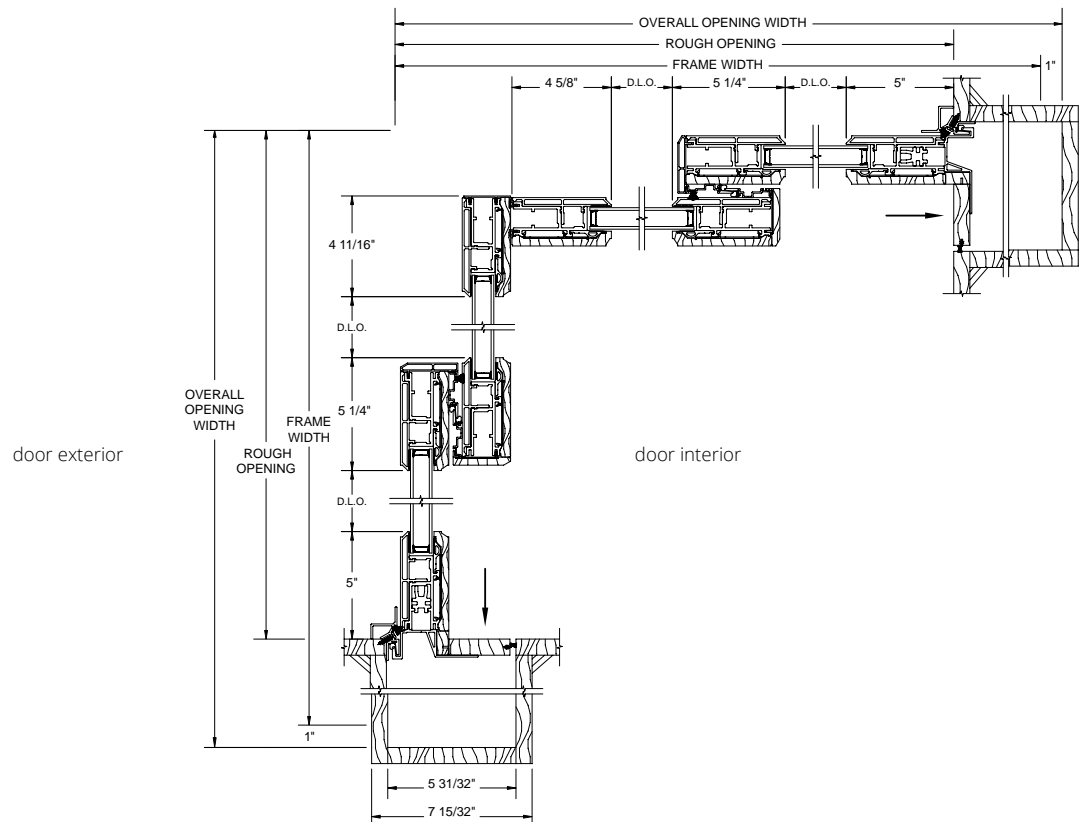

NOTE: Drawings are not to scale. Additional and the most current drawings are available at www.kolbewindows.com.

1.75" Panel with Recessed Sill

Vertical Section

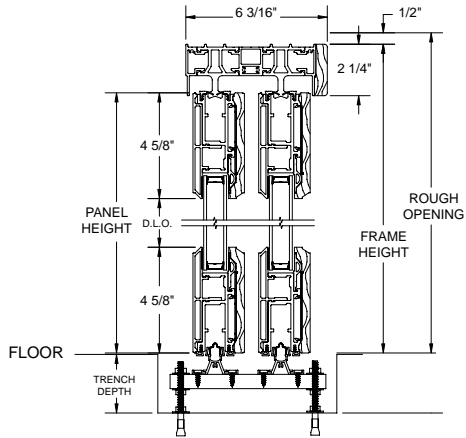

1.75" Panel with Weep Sill

Vertical Section

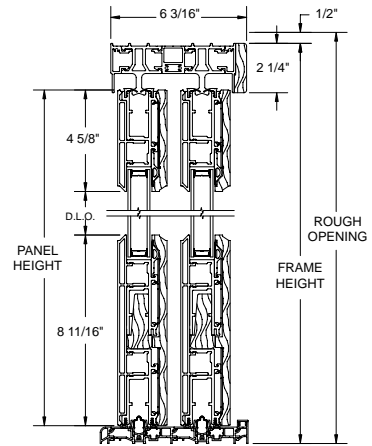

NOTE: Drawings are not to scale. Additional and the most current drawings are available at www.kolbewindows.com.

Multi-Slide Doors Panel Configurations

Pocketing – 1-Way (Right)

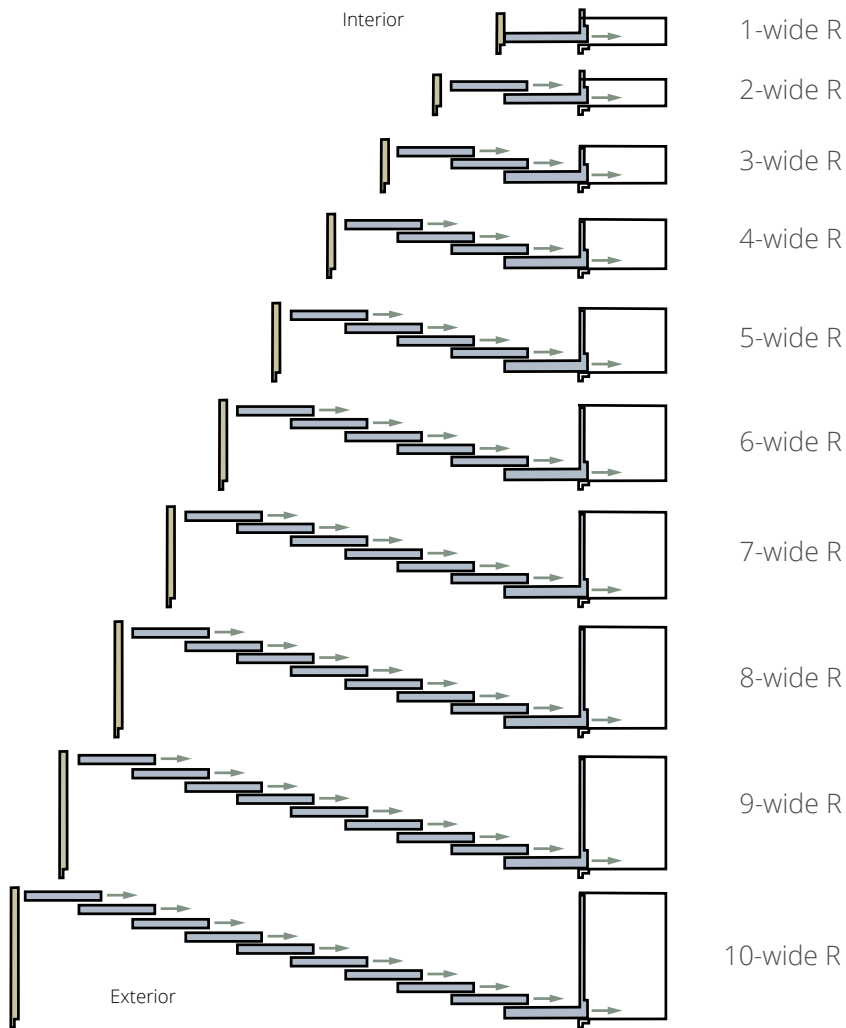

Operation is viewed from the exterior.

NOTE: Drawings are not to scale.
Panels can either recess into a wall pocket or stack within the opening.
These are examples of common configurations; others are available, including units with corners in a 90° or custom angle.
Additional and the most current drawings are available at www.kolbewindows.com.

Stacking - 1-Way (Left)

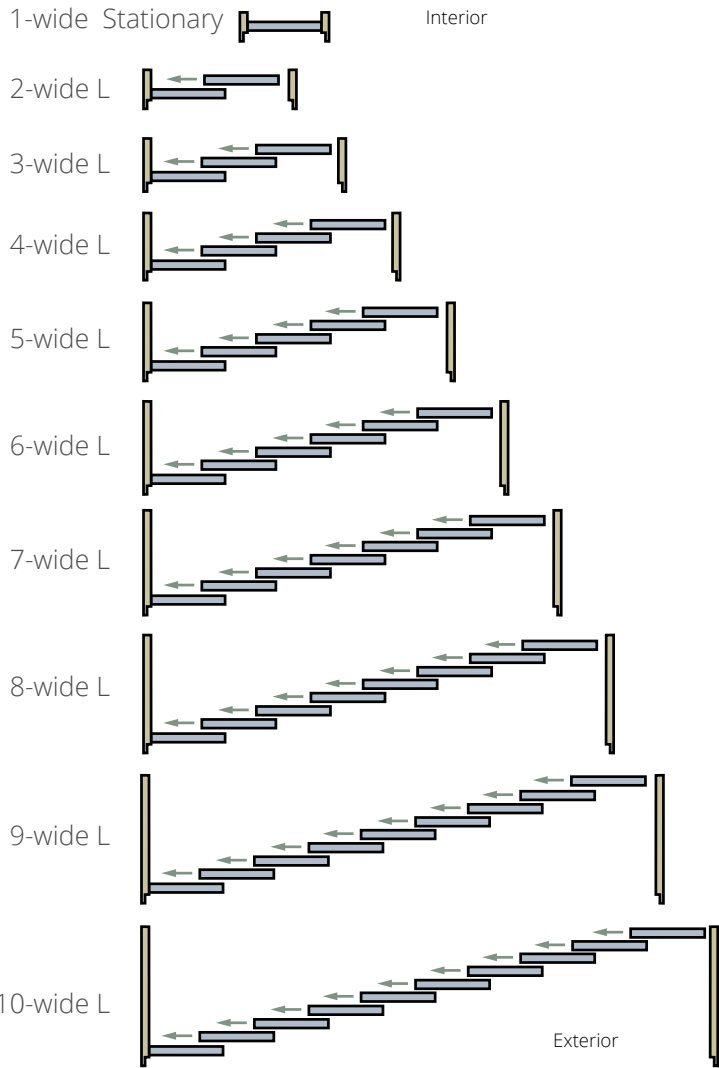

Operation is viewed from the exterior.

NOTE: Drawings are not to scale. Additional and the most current drawings are available at www.kolbewindows.com.

Multi-Slide Doors Panel Configurations

Stacking – Bi-Parting

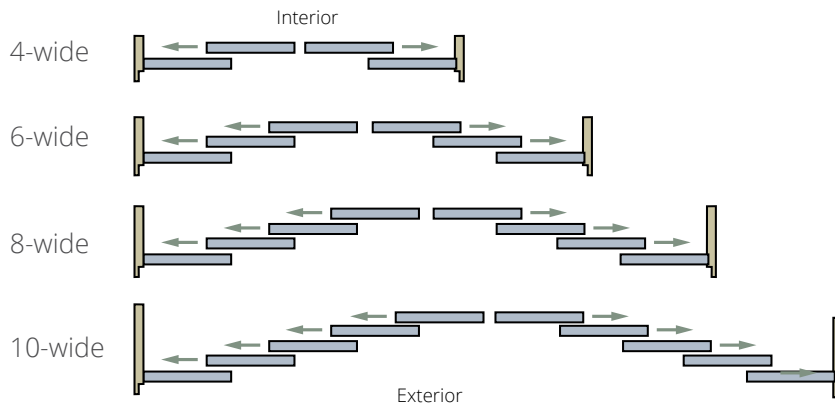

Pocketing – Bi-Parting

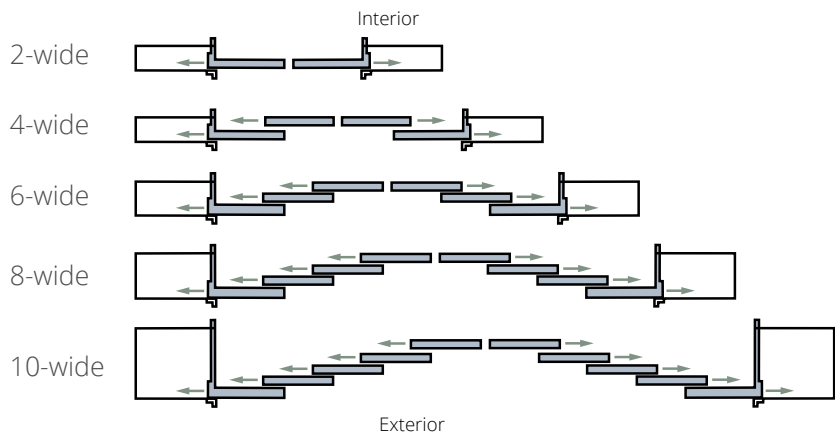

Operation is viewed from the exterior.

NOTE: Drawings are not to scale. Additional and the most current drawings are available at www.kolbewindows.com.

Multi-Slide Doors Cross Section Drawings

Pocketing - 1-Way

Horizontal Section

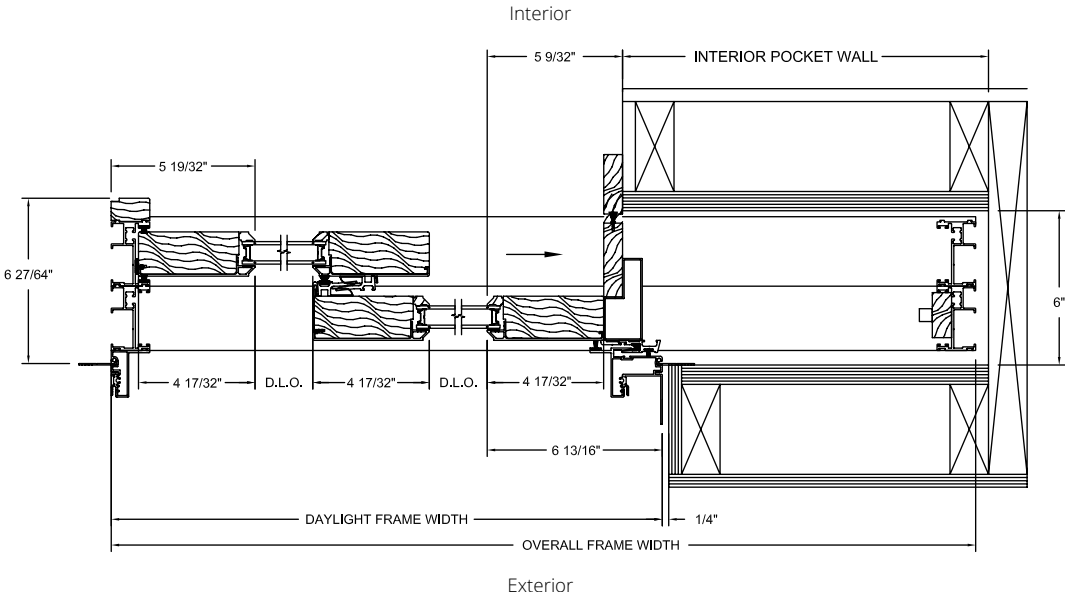

Pocketing - Bi-Parting

Horizontal Section

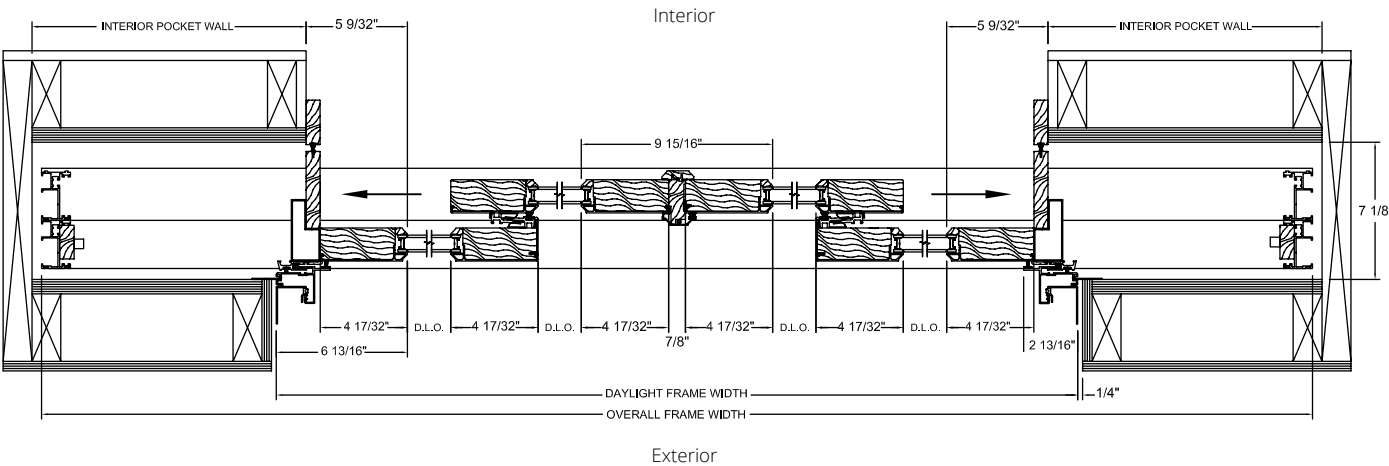

NOTE: Drawings are not to scale. Additional and the most current drawings are available at www.kolbewindows.com.

Multi-Slide Doors Cross Section Drawings

Stacking - 1-Way

Horizontal Section

Interior

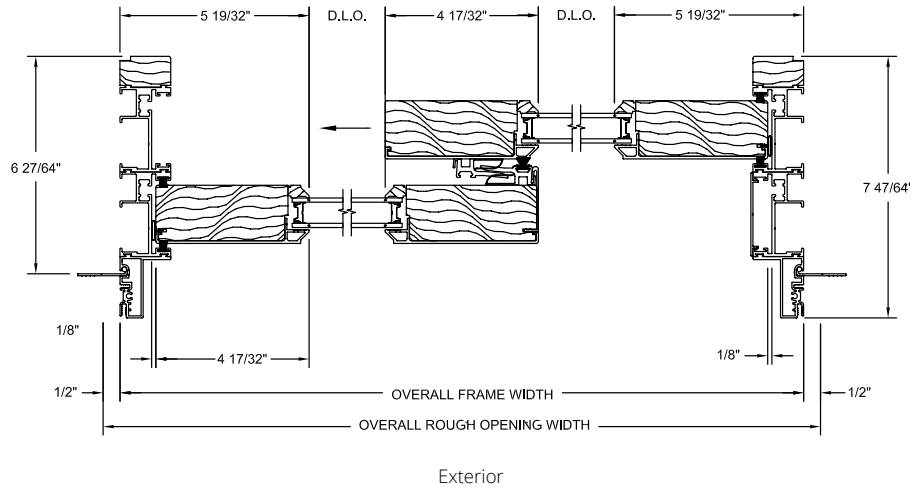

Stacking - Bi-Parting

Horizontal Section

Interior

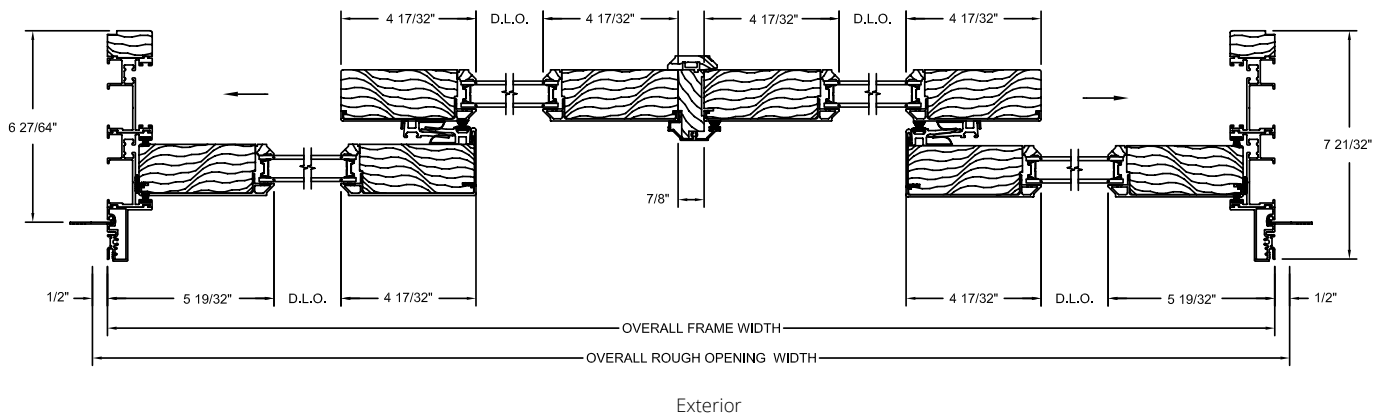

NOTE: Drawings are not to scale. Additional and the most current drawings are available at www.kolbewindows.com.

Garden-Aire Sliding Patio Doors Elevation Charts

Garden-Aire Sliding Patio Doors

	F.S.	2'-8 1/2"	3'-2 1/2"	4'-2 1/2"	4'-8 1/2"	5'-2 1/2"	5'-0"	6'-0"	8'-0"	9'-0"	10'-0"
	R.O.	2'-9"	3'-3"	4'-3"	4'-9"	5'-3"	5'-0 1/2"	6'-0 1/2"	8'-0 1/2"	9'-0 1/2"	10'-0 1/2"
	G.S.	25 1/4"	31 1/4"	43 1/4"	49 1/4"	55 1/4"	25 1/4"	31 1/4"	43 1/4"	49 1/4"	55-1/4"
	G.S.*	22"	28"	40"	46"	52"	22"	28"	40"	46"	52"
6'-10 7/16"	6'-10 7/16"										
		2968	3368	4368	4968	5368	5068	6068	8068	9068	10068
7'-2 7/16"	7'-2 7/16"										
		2970	3370	4370	4970	5370	5070	6070	8070	9070	10070
8'-2 7/16"	8'-2 7/16"										
		2980	3380	4380	4980	5380	5080	6080	8080	9080	10080
9'-2 7/16"	9'-2 7/16"										
		2990	3390	4390	4990	5390	5090	6090	8090	9090	10090
10'-2 7/16"	10'-2 7/16"										
		29100	33100	43100	49100	53100	50100	60100	80100	90100	100100

Operation is viewed from the exterior.

* Glass size for wide-stile Garden-Aire

F.S. = Frame Size • R.O. = Rough Opening • G.S. = Glass Size

Dimension Calculations

	Width	Height
F.S. to Panel O.S.M.	+1/2"÷2	-2 3/4"
Panel O.S.M. to G.S. (standard stiles & rails)	-5"	-4-11/16"
G.S. to D.L.O.	-1"	-1"

Note: Clear opening dimensions can be found on pgs. 229-231. Contact supplier for 4-wide Garden-Aire dimension calculations.

F.S. = Frame Size • G.S. = Glass Size • O.S.M. = Outside Measurement
D.L.O. = Daylight Opening • U.D. = Unit Dimension

NOTE: All measurements are nominal. Elevation charts are not to scale.

Divided lites are optional. The configuration shown for a single panel is typical for each panel.

Some installation procedures will require a larger rough opening than noted (i.e. installations utilizing our installation clips), therefore, you may need to increase the rough opening size accordingly. Rough opening gaps may be increased up to a maximum of 1/2" on all sides and still be within good practice guidelines. For rough opening recommendations, see pg. 216.

Additional and the most current drawings are available at www.kolbewindows.com.

Garden-Aire Sliding Patio Doors Elevation Charts

3-Wide Garden-Aire Sliding Patio Doors

	F.S.	7'-8 1/2"	9'-2 1/2"	12'-2 1/2"	13'-8 1/2"	15'-2 1/2"
	R.O.	7' 9"	9' 3"	12' 3"	13' 0"	15' 3"
	G.S.	25 1/4"	31 1/4"	43 1/4"	49 1/4"	55 1/4"
	G.S.*	22"	28"	40"	46"	52"
6'-10 7/16"	6'-10 15/16"	68 7/16"				
	75"					
		7968	9368	12368	13968	15368
7'-2 7/16"	7'-2 15/16"	72 7/16"				
	79"					
		7970	9370	12370	13970	15370
8'-2 7/16"	8'-2 15/16"	84 7/16"				
	91"					
		7980	9380	12380	13980	15380
9'-2 7/16"	9'-2 15/16"	96 7/16"				
	103"					
		7990	9390	12390	13990	15390
10'-2 7/16"	10'-2 15/16"	108 7/16"				
	115"					
		79100	93100	123100	139100	153100

Operation is viewed from the exterior.

* Glass size for wide-stile Garden-Aire

F.S. = Frame Size • R.O. = Rough Opening • G.S. = Glass Size (Glass sizes are shown per panel)



NOTE: All measurements are nominal. Elevation charts are not to scale.

Divided lites are optional. The configuration shown for a single panel is typical for each panel.

Some installation procedures will require a larger rough opening than noted (i.e. installations utilizing our installation clips), therefore, you may need to increase the rough opening size accordingly. Rough opening gaps may be increased up to a maximum of 1/2" on all sides and still be within good practice guidelines. For rough opening recommendations, see pg. 216.

Additional and the most current drawings are available at www.kolbewindows.com.

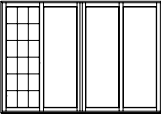
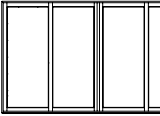
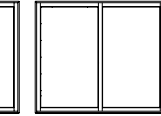
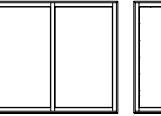
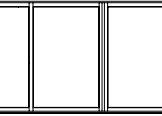
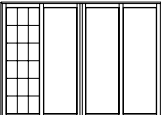
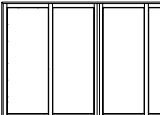
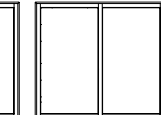
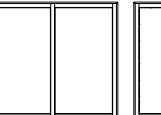
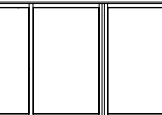
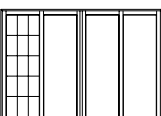
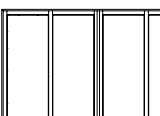
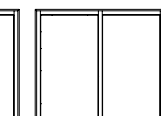
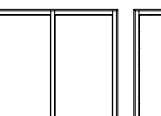
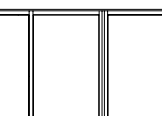
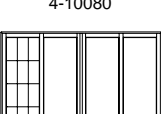
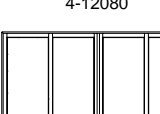
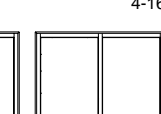
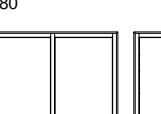
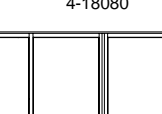
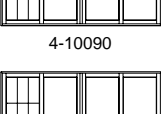
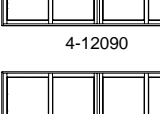
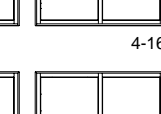
4-Wide Garden-Aire Sliding Patio Doors

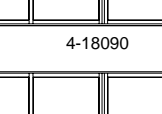
F.S.	9'-10 9/16"	11'-10 9/16"	15'-10 9/16"	17'-10 9/16"	19'-10 9/16"
R.O.	9'-11 1/16"	11'-11 1/16"	15'-11 1/16"	17'-11 1/16"	19'-11 1/16"
G.S.	25 1/4"	31 1/4"	43 1/4"	49 1/4"	55 1/4"
G.S.*	22"	28"	40"	46"	52"
6'-10 7/16" 6'-10 15/16" 75" 68 7/16"					
	4-10068	4-12068	4-16068	4-18068	4-20068
7'-2 7/16" 7'-2 15/16" 79" 72 7/16"					
	4-10070	4-12070	4-16070	4-18070	4-20070
8'-2 7/16" 8'-2 15/16" 91" 84 7/16"					
	4-10080	4-12080	4-16080	4-18080	4-20080
9'-2 7/16" 9'-2 15/16" 103" 96 7/16"					
	4-10090	4-12090	4-16090	4-18090	4-20090
10'-2 7/16" 10'-2 15/16" 115" 108 7/16"					
	4-100100	4-120100	4-160100	4-180100	4-200100

Operation is viewed from the exterior.

* Glass size for wide-stile Garden-Aire

F.S. = Frame Size • R.O. = Rough Opening • G.S. = Glass Size

NOTE: All measurements are nominal. Elevation charts are not to scale.

Divided lites are optional. The configuration shown for a single panel is typical for each panel.

Some installation procedures will require a larger rough opening than noted (i.e. installations utilizing our installation clips), therefore, you may need to increase the rough opening size accordingly. Rough opening gaps may be increased up to a maximum of 1/2" on all sides and still be within good practice guidelines. For rough opening recommendations, see pg. 216.

Additional and the most current drawings are available at www.kolbewindows.com.

Garden-Aire Sliding Patio Doors Elevation Charts

Garden-Aire Sliding Patio Doors | Modular Sizes

		2' 8"	3' 2"	3'-5 1/4"	4' 2"	4' 11"	5' 11"	6'-5 1/2"	7' 11"
F.S.									
	R.O.	2'-8 1/2"	3'-2 1/2"	3'-5 3/4"	4'-2 1/2"	4'-11 1/2"	5'-11 1/2"	6' 6"	7'-11 1/2"
	G.S.	24 3/4"	30 3/4"	34"	42 3/4"	24 3/4"	30 3/4"	34"	42 3/4"
	G.S.*	21 1/2"	27 1/2"	30 3/4"	39 1/2"	21 1/2"	27 1/2"	30 3/4"	39 1/2"
6'-7 1/2"	6' 8"								
	72 1/16"	2866	3266	3666	4266	41166	51166	6666	71166
7'-11 1/2"	8' 0"								
	86 1/16"	2880	3280	3680	4280	41180	51180	6680	71180
	84 17/32"								

		7' 7"	9' 1"	9'-11 3/4"	12' 1"
F.S.					
	R.O.	7'-7 1/2"	9'-1 1/2"	9'-10 1/2"	12'-1 1/2"
	G.S.	24 3/4"	30 3/4"	34"	42 3/4"
	G.S.*	21 1/2"	27 1/2"	30 3/4"	39 1/2"
6'-7 1/2"	6' 8"				
	72 1/16"	7766	9166	91166	12166
7'-11 1/2"	8' 0"				
	86 1/16"	7780	9180	91180	12180
	84 17/32"				

* Glass size for wide-stile Garden-Aire

F.S. = Frame Size • R.O. = Rough Opening • G.S. = Glass Size

















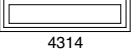
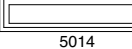
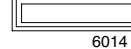

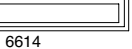



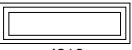
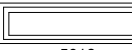
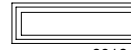
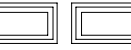
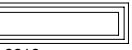









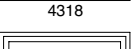
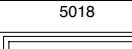
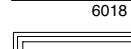

NOTE: All measurements are nominal. Elevation charts are not to scale.

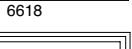
Divided lites are optional. The configuration shown for a single panel is typical for each panel.

Some installation procedures will require a larger rough opening than noted (i.e. installations utilizing our installation clips), therefore, you may need to increase the rough opening size accordingly. Rough opening gaps may be increased up to a maximum of 1/2" on all sides and still be within good practice guidelines. For rough opening recommendations, see pg. 216.

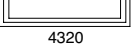
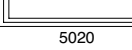
Additional and the most current drawings are available at www.kolbewindows.com.

Garden-Aire Sliding Patio Doors | Rectangular Transoms

F.S.	2'-8 1/2"	3'-2 1/2"	3'-5 1/2"	4'-2 1/2"	5'-0"	6'-0"	6'-6"	8'-0"
R.O.	2'-9"	3'-3"	3'-6"	4'-3"	5'-0 1/2"	6'-0 1/2"	6'-6 1/2"	8'-0 1/2"
G.S.	25 7/8"	31 7/8"	34 7/8"	43 7/8"	53 3/8"	65 3/8"	71 3/8"	89 3/8"
11 1/2"								
1'-0"	2910	3310	3610					
1'-3 1/2"								
1'-4"	2914	3314	3614	4314	5014	6014	6614	8014
1'-5 1/2"								
1'-6"	2916	3316	3616	4316	5016	6016	6616	8016
1'-7 1/2"								
1'-8"	2918	3318	3618	4318	5018	6018	6618	8018
1'-11 1/2"								
2'-0"	2920	3320	3620	4320	5020	6020	6620	8020
2'-5 1/2"								
2'-6"	2926	3326	3626	4326	5026	6026	6626	8026
22 7/8"								

Operation is viewed from the exterior.

* Glass size for wide-stile Garden-Aire

F.S. = Frame Size • R.O. = Rough Opening • G.S. = Glass Size (Glass sizes are shown per panel)

NOTE: All measurements are nominal. Elevation charts are not to scale.

Divided lites are optional. The configuration shown for a single panel is typical for each panel.

Some installation procedures will require a larger rough opening than noted (i.e. installations utilizing our installation clips), therefore, you may need to increase the rough opening size accordingly. Rough opening gaps may be increased up to a maximum of 1/2" on all sides and still be within good practice guidelines. For rough opening recommendations, see pg. 216.

Additional and the most current drawings are available at www.kolbewindows.com.

Garden-Aire Sliding Patio Doors Cross Section Drawings

2-Wide Garden-Aire | Active-Fixed

Horizontal Section

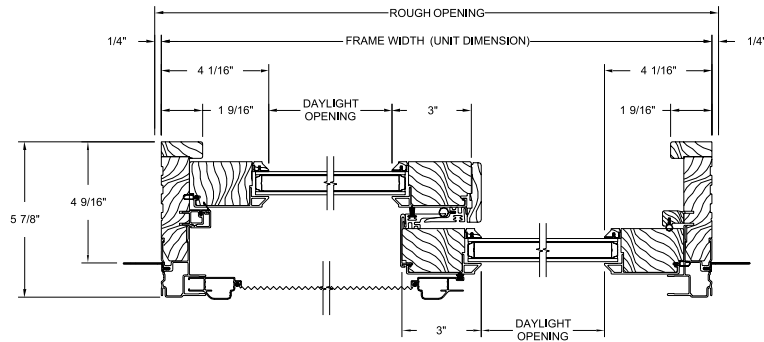

3-Wide Garden-Aire | Active-Fixed-Active

Horizontal Section

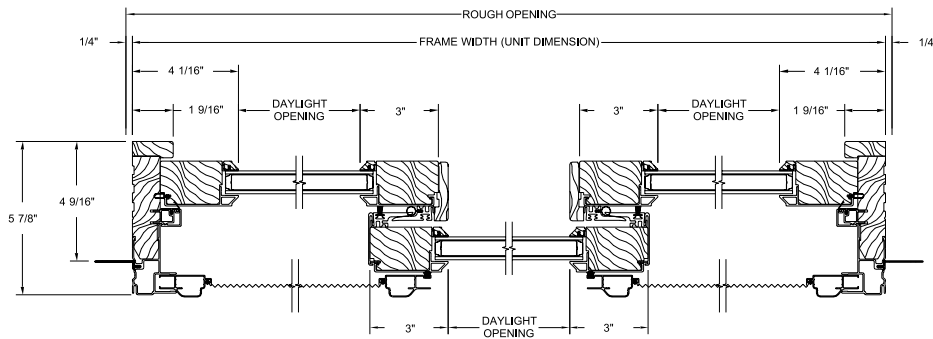

4-Wide Garden-Aire | Fixed-Active-Active-Fixed

Horizontal Section

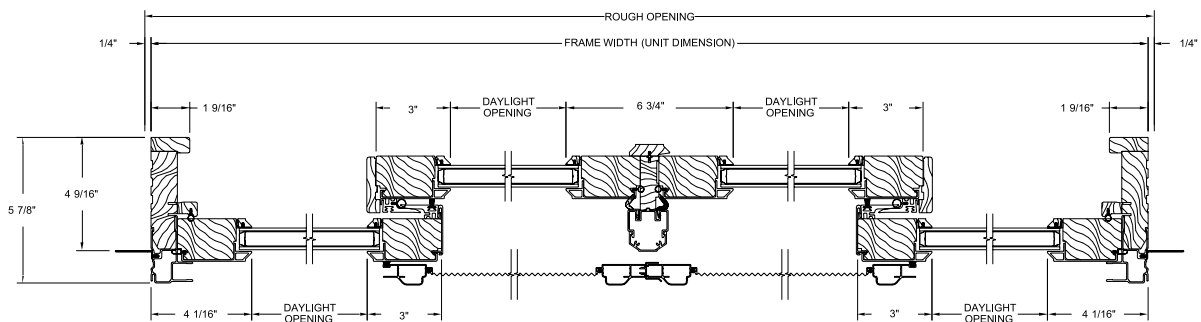

NOTE: Drawings are not to scale. Brickmould may be shipped loose for field application. Some units are shown with optional drip cap or nailing fin. For Ultra accessory or application drawings, see pgs. 206-212. Additional and the most current drawings at www.kolbewindows.com.

Garden-Aire Sliding Patio Doors

Sliding Screen
Vertical Section

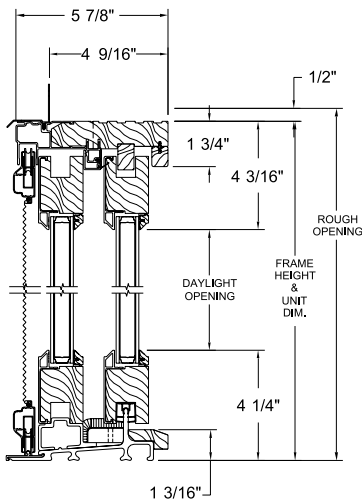

Automated Operation
Vertical Section

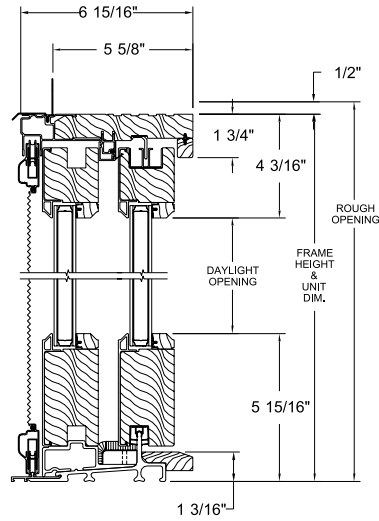

Transom Stacked Over Garden-Aire

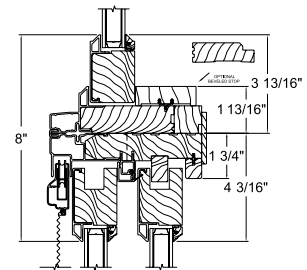

4-Wide Garden-Aire | Automated Operation

Horizontal Section

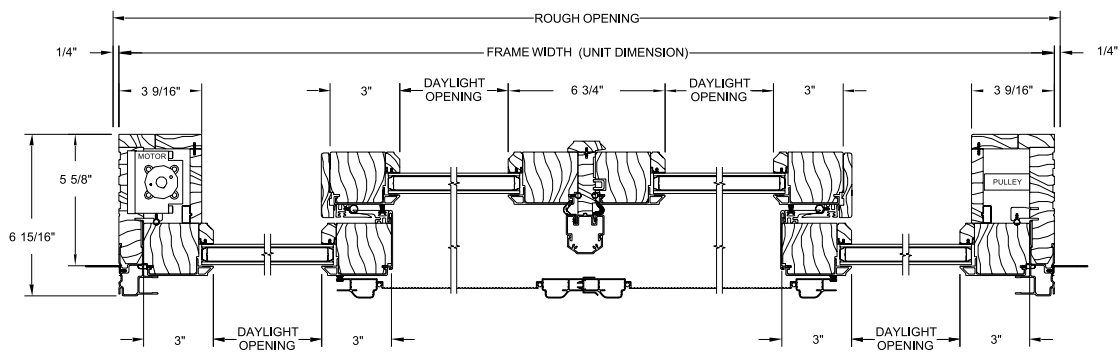

NOTE: Drawings are not to scale. Additional and the most current drawings are available at www.kolbewindows.com.

Garden-Aire Sliding Patio Doors Cross Section Drawings

2-Wide Garden-Aire | Active-Fixed

Horizontal Section

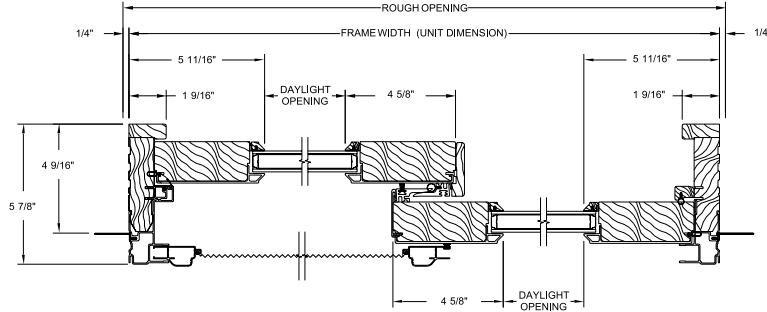

3-Wide Garden-Aire | Active-Fixed-Active

Horizontal Section

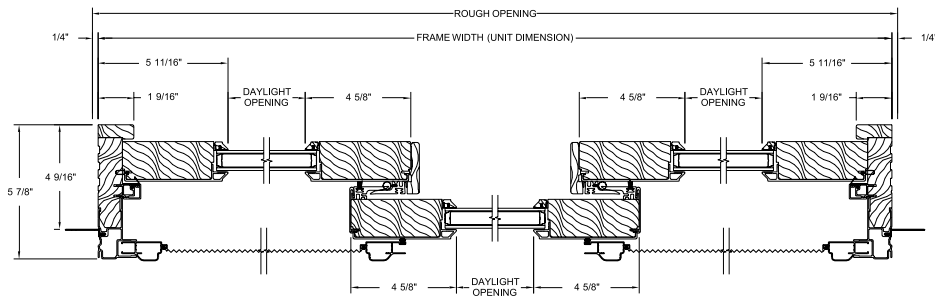

4-Wide Garden-Aire | Fixed-Active-Active-Fixed

Horizontal Section

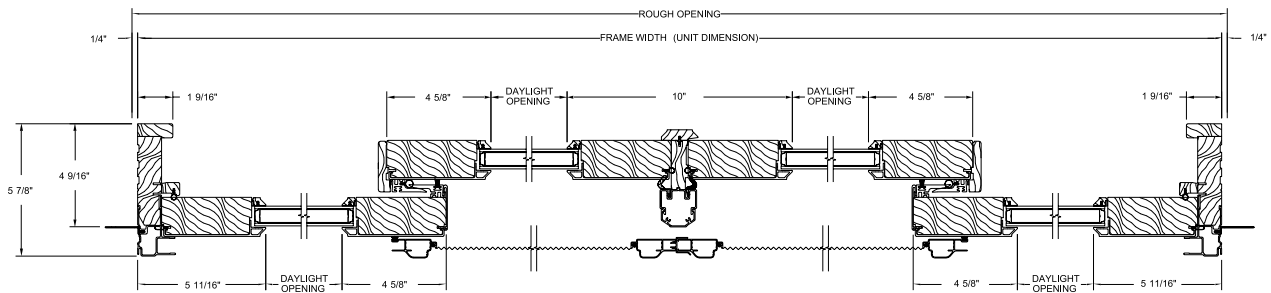

NOTE: Drawings are not to scale. Brickmould may be shipped loose for field application. Some units are shown with optional drip cap or nailing fin. For Ultra accessory or application drawings, see pgs. 206-212. Additional and the most current drawings are available at www.kolbewindows.com.

Garden-Aire Sliding Patio Doors

Horizontal Section

Sliding Screen

Vertical Section

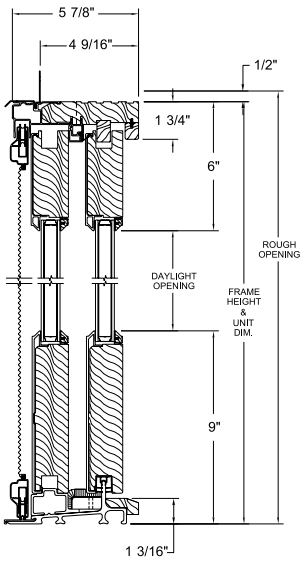

Automated Operation

Vertical Section

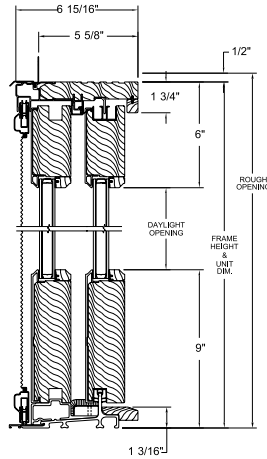

Transom Stacked Over Garden-Aire

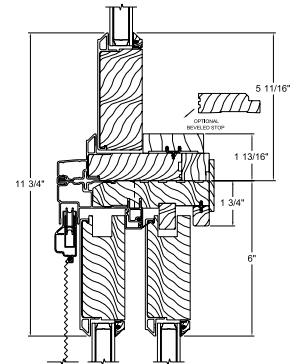

4-Wide Garden-Aire | Fixed-Active-Active-Fixed with Automated Operation

Horizontal Section

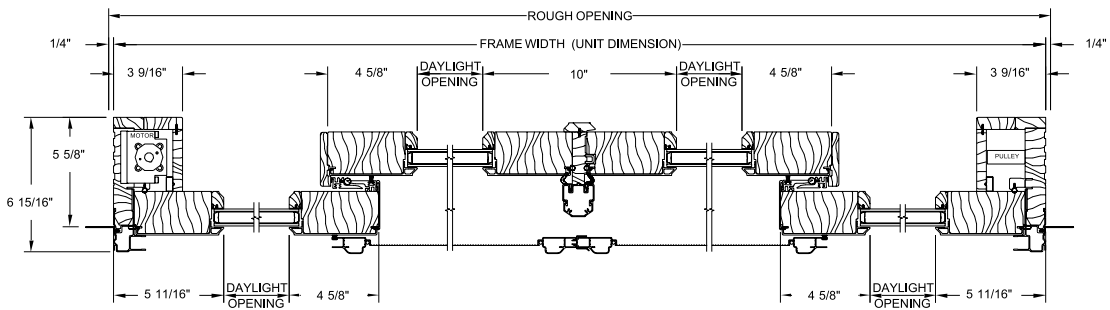

NOTE: Drawings are not to scale. Additional and the most current drawings are available at www.kolbewindows.com.

Folding Doors | Panel Configurations

2-wide

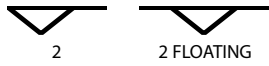

CAN BE USED AS AN ACCESS DOOR
FLOATING CONFIGURATIONS CAN BE OPENED BOTH WAYS

3-wide



4-wide



5-wide



6-wide



7-wide



8-wide



9-wide



10-wide

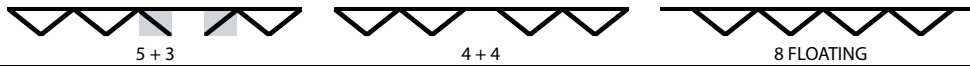

11-wide

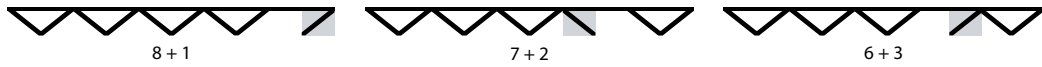

12-wide



13-wide



14-wide



15-wide



16-wide

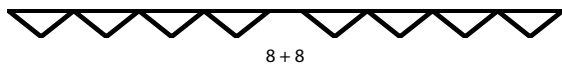
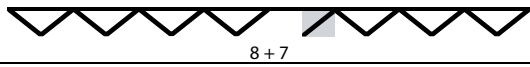
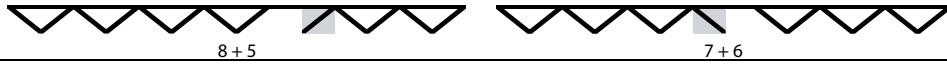
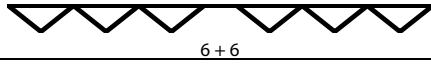
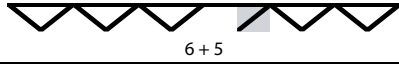

NOTE: Folding doors are shown as outswing operation. There is a maximum of 8 panels per side. Access door configuration will have a swing door hinged off of one of the sides of the frame or off of another panel, depending on the configuration chosen. Configurations can be reversed. The configurations shown above are an overview of what is available. Contact your Kolbe dealer for more information.

Folding Doors | Cross Section Drawings

4-Wide: Folding 1-Way

Horizontal Section

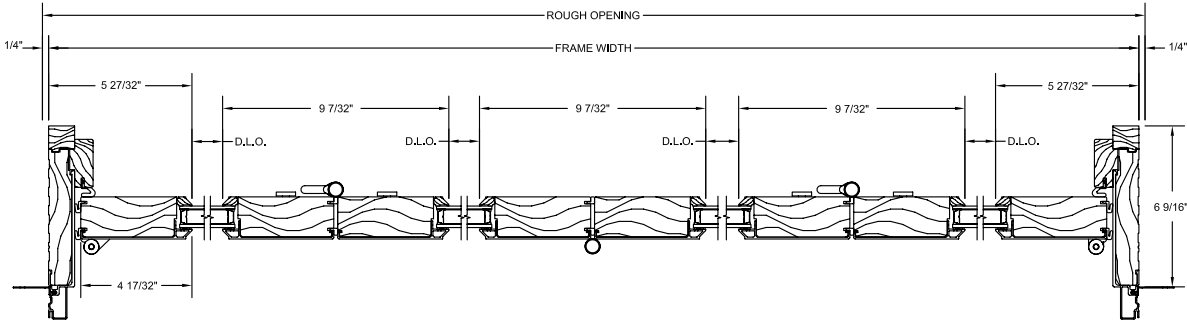

4-Wide: Three Left & One Right

Horizontal Section

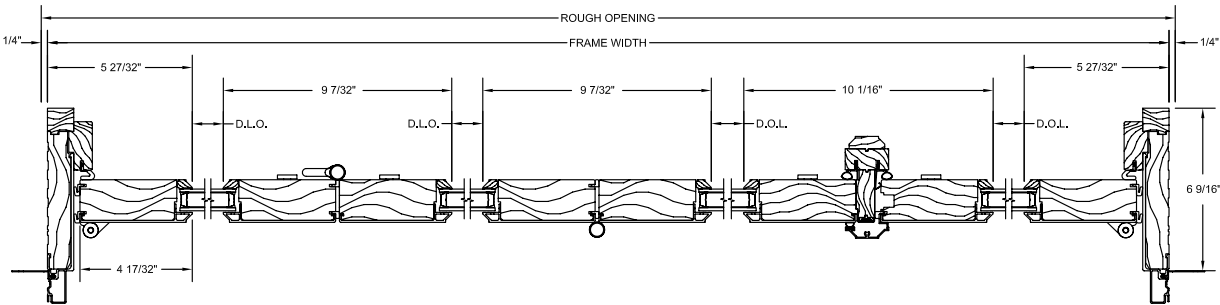

4-Wide: Two Left & Two Right

Horizontal Section

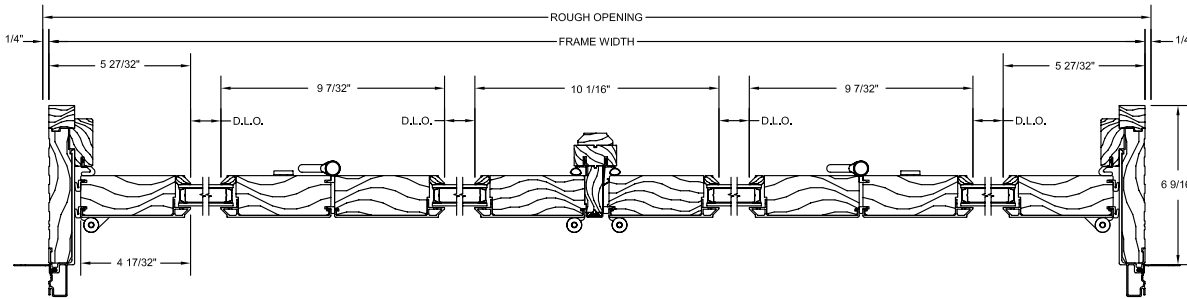

Operation is viewed from the exterior.

NOTE: Drawings are not to scale. Additional and the most current drawings are available at www.kolbewindows.com.

Folding Doors | Cross Section Drawings

Corner Unit

Horizontal Section

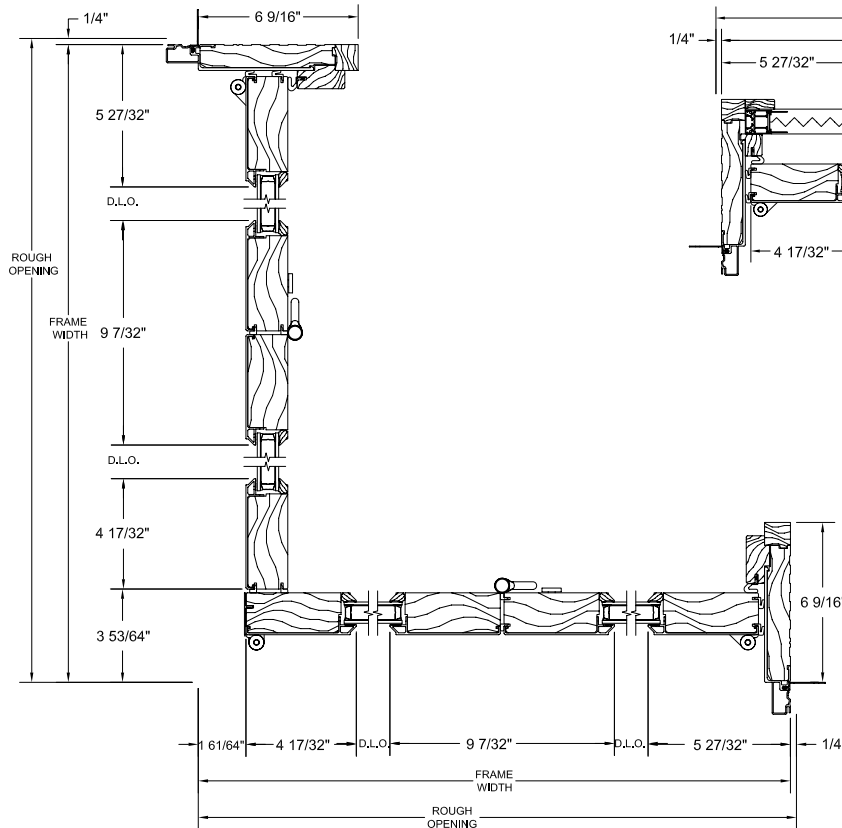

2-Wide with Screen

Horizontal Section

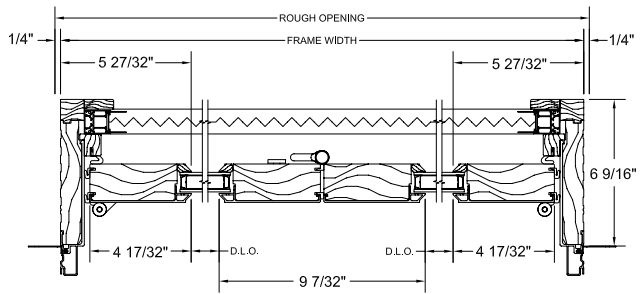

1.75" Panel with Recessed Sill

Vertical Section

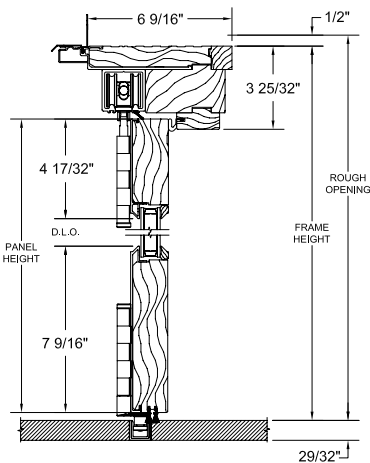

1.75" Panel with Weep Sill

Vertical Section

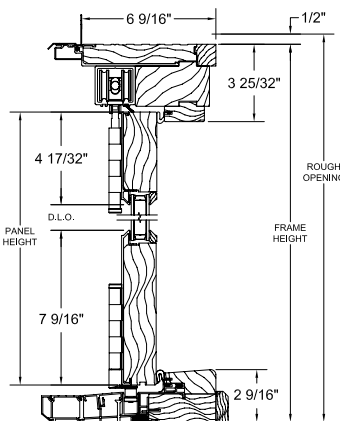

1.75" Panel with Weep Sill & Screen



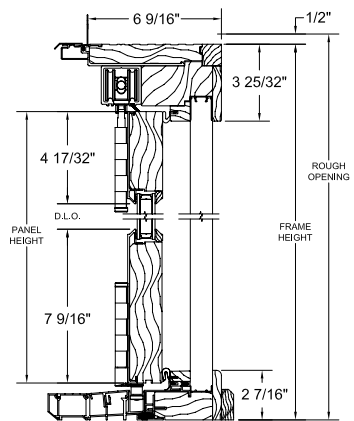

Vertical Section

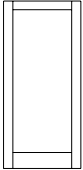
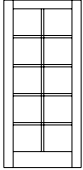
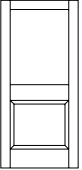
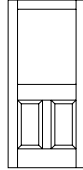
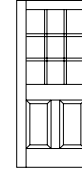

NOTE: Drawings are not to scale. Additional and the most current drawings are available at www.kolbewindows.com.

Inswing Entrance Doors | Panel Designs

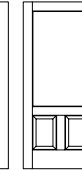
Panel Designs

									
Sash Design#:	UP810 Full Lite	UP825 2W5H Pattern	UP8110 1 Lite over 1 Panel, 8" Cross Rail at 40"	UP8210 1 Lite over 2 Panels, 8" Cross Rail at 40"	UP8233 1 Lite over 2 Panels, 8" Cross Rail at 40" with 3W3H Pattern	UP8110-30 1 Lite over 1 Panel, 4-5/8" Cross Rail at 30"	UP8210-30 1 Lite over 2 Panels, 4-5/8" Cross Rail at 30"	UP8110-24 1 Lite over 1 Panel, 4-5/8" Cross Rail at 24"	UP8210-24 1 Lite over 2 Panels, 4-5/8" Cross Rail at 24"

Dimension Calculations

	Width	Height
F.S. to Panel O.S.M. (1-wide, active)	-1 13/16"	-2 23/32"
(1-wide, stationary)	-1 3/4"	-2 23/32"
(2-wide)	-2 9/16" ÷ 2	-2 23/32"
(3-wide)	-3 15/16" ÷ 3	-2 23/32"
Panel O.S.M. to G.S. (wood 6-8 ht.)	-8 1/8"	-11 3/32"
G.S. to D.L.O.	-1"	-1"

Note: Dimension calculations for sidelites and transoms may be obtained from your Kolbe dealer. Clear opening dimensions can be found on pg. 226.

F.S. = Frame Size • G.S. = Glass Size • O.S.M. = Outside Measurement
D.L.O. = Daylight Opening • U.D. = Unit Dimension

NOTE: Not all panel designs are available in all sizes; not all panel designs are shown. 3" cross rails are also available. See your local Kolbe dealer for assistance.

Inswing Entrance Doors | Elevation Charts

Inswing Entrance Doors

	2'-1 5/8"		4'-2 3/16"		2'-7 5/8"		5'-2 3/16"		2'-9 5/8"		5'-6 3/16"		3'-1 5/8"		6'-2 3/16"	
	R.O. 2'-2 1/8"		4'-2 11/16"		2'-8 1/8"		5'-2 11/16"		2'-10 1/8"		5'-6 11/16"		3'-2 1/8"		6'-2 11/16"	
	G.S. 15 11/16"		15 11/16"		21 11/16"		21 11/16"		23 11/16"		23 11/16"		27 11/16"		27 11/16"	
6'-10 23/32" 6'-11 7/32" 68 7/8"																
7'-2 23/32" 7'-3 7/32" 72 7/8"																
8'-2 23/32" 8'-3 7/32" 84 7/8"																

Segment Head Inswing Entrance Doors

	2'-1 5/8"		4'-2 3/16"		2'-7 5/8"		5'-2 3/16"		2'-9 5/8"		5'-6 3/16"		3'-1 5/8"		6'-2 3/16"	
	R.O. 2'-2 1/8"		4'-2 11/16"		2'-8 1/8"		5'-2 11/16"		2'-10 1/8"		5'-6 11/16"		3'-2 1/8"		6'-2 11/16"	
	G.S. 15 11/16"		15 11/16"		21 11/16"		21 11/16"		23 11/16"		23 11/16"		27 11/16"		27 11/16"	
6'-10 23/32" 6'-11 7/32" 68 7/8"																
7'-2 23/32" 7'-3 7/32" 72 7/8"																
8'-2 23/32" 8'-3 7/32" 84 7/8"																

* Approximate glass sizes per panel are given; true glass sizes vary depending on the radius involved

F.S. = Frame Size • R.O. = Rough Opening • G.S. = Glass Size

Operation is viewed from the interior.

NOTE: All measurements are nominal. Elevation charts are not to scale. When ordering, specify inswing. If you are ordering a single unit, specify stationary, hinged left or hinged right. Double-wide doors are also available as French units, with no fixed astragal between the door panels. Specify French when ordering. Some installation procedures will require a larger rough opening than noted (i.e. installations utilizing our installation clips), therefore, you may need to increase the rough opening size accordingly. Rough opening gaps may be increased up to a maximum of 1/2" on all sides and still be within good practice guidelines. For rough opening recommendations, see pg. 216.

Additional and the most current drawings are available at www.kolbwindows.com.

Inswing Entrance Door Sidelites

	1'-1 3/4"	1'-3 3/4"	1'-5 3/4"	1'-7 3/4"
F.S.	1'-1 3/4"	1'-3 3/4"	1'-5 3/4"	1'-7 3/4"
R.O.	1'-2 1/4"	1'-4 1/4"	1'-6 1/4"	1'-8 1/4"
G.S.	7 3/4"	9 3/4"	11 3/4"	13 3/4"

6'-10 23/32"				
6'-11 7/32"	1068S	1268S	1468S	1668S
7'-2 23/32"				
7'-3 7/32"	1070S	1270S	1470S	1670S
8'-2 23/32"				
8'-3 7/32"	1080S	1280S	1480S	1680S

Inswing Entrance Door Sidelite Panel Designs

Sash Design#:	UP710	UP715	UP7110	UP7110-30	UP7110-24
	Full Lite	1W5H Pattern	1 Lite over 1 Panel, 8" Cross Rail at 40"	1 Lite over 1 Panel, 4-5/8" Cross Rail at 30"	1 Lite over 1 Panel, 4-5/8" Cross Rail at 24"

Inswing Entrance Doors | Rectangular Transoms

	2'-1 5/8"	2'-7 5/8"	2'-9 5/8"	3'-1 5/8"	4'-2 3/16"	5'-2 3/16"	5'-6 3/16"	6'-2 3/16"
F.S.	2'-1 5/8"	2'-7 5/8"	2'-9 5/8"	3'-1 5/8"	4'-2 3/16"	5'-2 3/16"	5'-6 3/16"	6'-2 3/16"
R.O.	2'-2 1/8"	2'-8 1/8"	2'-10 1/8"	3'-2 1/8"	4'-2 11/16"	5'-2 11/16"	5'-6 11/16"	6'-2 11/16"
G.S.	20 1/8"	26 1/8"	28 1/8"	32 1/8"	44 11/16"	56 11/16"	60 11/16"	68 11/16"

11 1/2"								
11 1/2"	2010	2610	2810	3010	4010	5010	5410	6010
10"								
10"	2014	2614	2814	3014	4014	5014	5414	6014
12"								
12"	2016	2616	2816	3016	4016	5016	5416	6016
14"								
14"	2018	2618	2818	3018	4018	5018	5418	6018
18"								
18"	2020	2620	2820	3020	4020	5020	5420	6020
24"								
24"	2026	2626	2826	3026	4026	5026	5426	6026

F.S. = Frame Size • R.O. = Rough Opening • G.S. = Glass Size

NOTE: All measurements are nominal. Elevation charts are not to scale.

Rectangular transom units are sash set as standard.

Adjustments may be required when stacking over other units; adjustments will be made in the factory.

Some installation procedures will require a larger rough opening than noted (i.e. installations utilizing our installation clips), therefore, you may need to increase the rough opening size accordingly. Rough opening gaps may be increased up to a maximum of 1/2" on all sides and still be within good practice guidelines. For rough opening recommendations, see pg. 216.

Additional and the most current drawings are available at www.kolbwindows.com.

Inswing Patio Doors | Elevation Charts

Inswing Patio Doors

F.S.	2'-6 1/4"	4'-11 7/16"	4'-11 7/16"	7'-4 5/8"	7'-4 5/8"	3'-0 1/4"	5'-11 7/16"	5'-11 7/16"	8'-10 5/8"	8'-10 5/8"
R.O.	2'-6 3/4"	4'-11 15/16"	4'-11 15/16"	7'-5 1/8"	7'-5 1/8"	3'-0 3/4"	5'-11 15/16"	5'-11 15/16"	8'-11 1/8"	8'-11 1/8"
G.S.	20 5/16"	20 5/16"	20 5/16"	20 5/16"	20 5/16"	26 5/16"	26 5/16"	26 5/16"	26 5/16"	26 5/16"
6'-7 1/2" 6'-8" 65 11/16"										
	2666	41166	41166	7566	7566	3066	51166	51166	81166	81166
7'-11 5/8" 8'-0 1/8" 81 3/4"										
	2680	41180	41180	7580	7580	3080	51180	51180	81180	81180

Operation is viewed from the interior.

F.S. = Frame Size • R.O. = Rough Opening • G.S. = Glass Size (Glass sizes are shown per panel)

Dimension Calculations

	Width	Height
F.S. to Panel O.S.M. (1-wide, active)	-1 13/16"	-2 23/32"
(1-wide, stationary)	-1 3/4"	-2 23/32"
(2-wide)	-2 9/16"÷2	-2 23/32"
(3-wide)	-3 5/16"÷3	-2 23/32"
Panel O.S.M. to G.S.	-8 1/8"	-11 3/32"
G.S. to D.L.O.	-1"	-1"

Note: Clear opening dimensions can be found on pg. 227.

F.S. = Frame Size • G.S. = Glass Size • O.S.M. = Outside Measurement
D.L.O. = Daylight Opening • U.D. = Unit Dimension

NOTE: All measurements are nominal. Elevation charts are not to scale.

When ordering single units, specify stationary, hinged left or hinged right.

Divided lites are optional. The divided lite configuration shown for a single panel is typical for each panel in the unit.

Additional swinging door sizes are available in the Entrance Door section.

Some installation procedures will require a larger rough opening than noted (i.e. installations utilizing our installation clips), therefore, you may need to increase the rough opening size accordingly. Rough opening gaps may be increased up to a maximum of 1/2" on all sides and still be within good practice guidelines. For rough opening recommendations, see pg. 216.

Additional and the most current drawings are available at www.kolbewindows.com.

Inswing Patio Doors | French Doors

F.S.	4'-11 7/16"	4'-11 7/16"	5'-11 7/16"	5'-11 7/16"
R.O.	4'-11 15/16"	4'-11 15/16"	5'-11 15/16"	5'-11 15/16"
G.S.	20 5/16"	20 5/16"	26 5/16"	26 5/16"
6'-7 1/2"				
6'-8"				
65 11/16"				
7'-11 5/8"				
8'-0 1/8"				
81 3/4"				

Operation is viewed from the interior.

Inswing Patio Doors | Rectangular Transoms

F.S.	2'-6 1/4"	3'-0 1/4"	4'-11 7/16"	5'-11 7/16"
R.O.	2'-6 3/4"	3'-0 3/4"	4'-11 15/16"	5'-11 15/16"
G.S.	24 3/4"	30 3/4"	53 15/16"	65 15/16"
11 1/2"				
1'-0"				
6"				
1'-3 1/2"				
1'-4"				
10"				
1'-5 1/2"				
1'-6"				
12"				
1'-7 1/2"				
1'-8"				
14"				
1'-11 1/2"				
2'-0"				
18"				
2'-5 1/2"				
2'-6"				
24"				

F.S. = Frame Size • R.O. = Rough Opening • G.S. = Glass Size (Glass sizes are shown per panel)

NOTE: All measurements are nominal. Elevation charts are not to scale. Divided lites are optional. The divided lite configuration shown for a single panel is typical for each panel in the unit.

Additional swinging door sizes are available in the Entrance Door section.

Rectangular transom units are sash set as standard. The units shown are stand-alone units. Adjustments may be required when stacking over other units; adjustments will be made in the factory.

Some installation procedures will require a larger rough opening than noted (i.e. installations utilizing our installation clips), therefore, you may need to increase the rough opening size accordingly. Rough opening gaps may be increased up to a maximum of 1/2" on all sides and still be within good practice guidelines. For rough opening recommendations, see pg. 216.

Additional and the most current drawings are available at www.kolbwindows.com.

Inswing Doors | Hinging Options

Hinging for Inswing Doors

HL (Hinged Left)

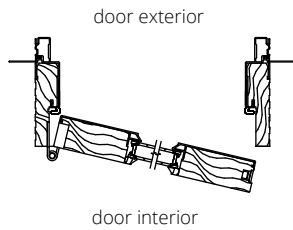

HR (Hinged Right)

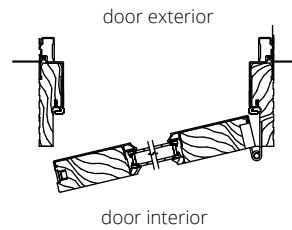

SAL (Stationary, Active, Hinged Left)

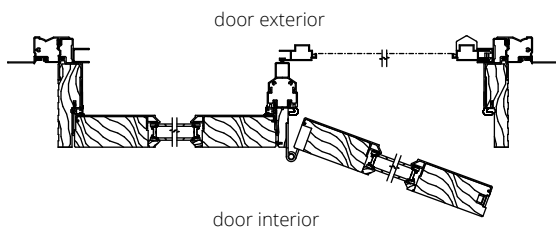

ASR (Active, Hinged Right, Stationary)

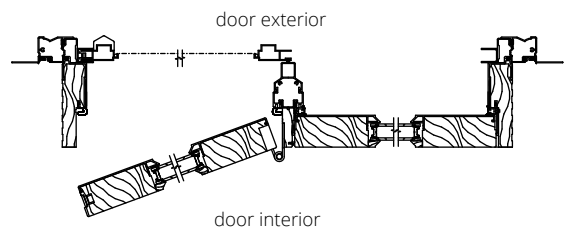

AL (French, Hinged Left, Active)

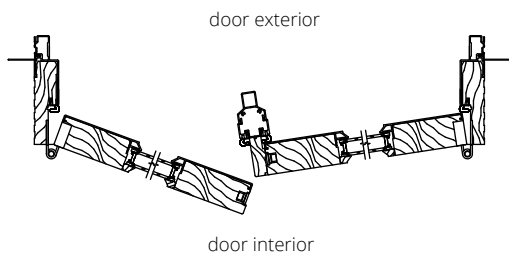

AR (French, Hinged Right, Active)

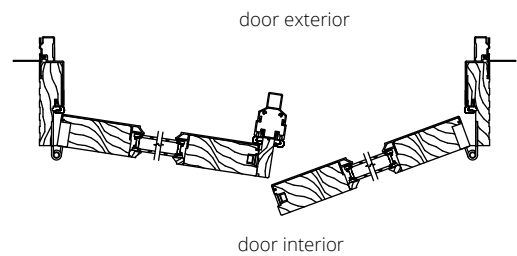

Operation is viewed from the interior.

NOTE: Drawings are not to scale. Additional and the most current drawings are available at www.kolbewindows.com.

Inswing Doors | Cross Section Drawings

1-Wide Operating Inswing Door

Horizontal Section

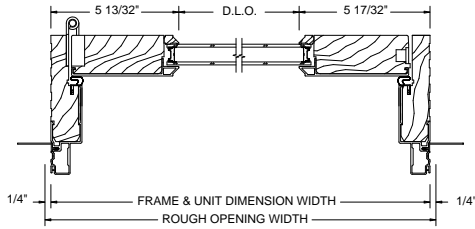

Active Inswing Door

Vertical Section

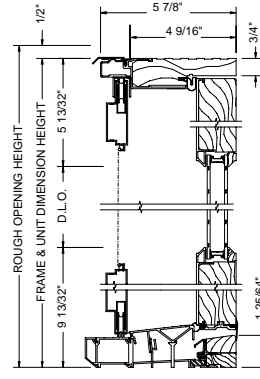

Inswing Door with 1-15/16\" Brickmould

Horizontal Section

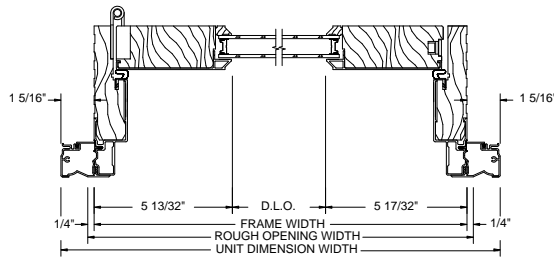

Vertical Section

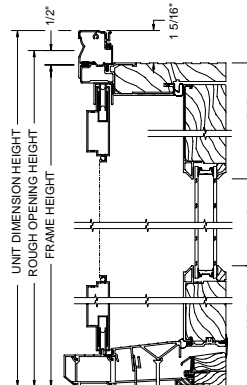

Transom Stacked Over Inswing Door

Standard

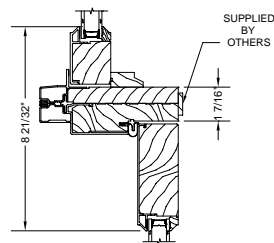

Optional

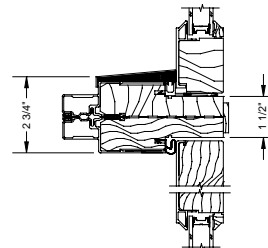

NOTE: Drawings are not to scale.

Brickmould is shown factory-applied. Brickmould may be shipped loose for field application.

Some units are shown with optional drip cap or nailing fin. For Ultra accessory or application drawings, see pgs. 206-212. Additional and the most current drawings are available at www.kolbewindows.com.

Inswing Doors | Cross Section Drawings

2-Wide Inswing French Doors

Horizontal Section

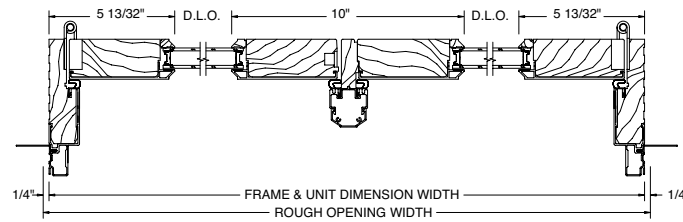

2-Wide Inswing Doors – Active/Stationary

Horizontal Section

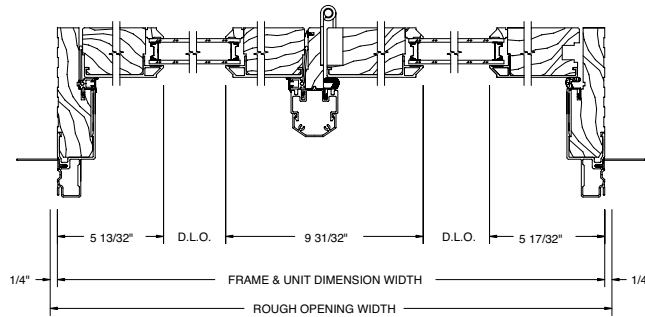

2-Wide Inswing Doors with Sidelite

Horizontal Section

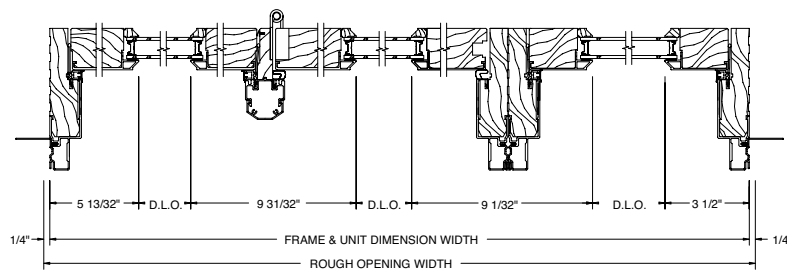

3-Wide Inswing Doors



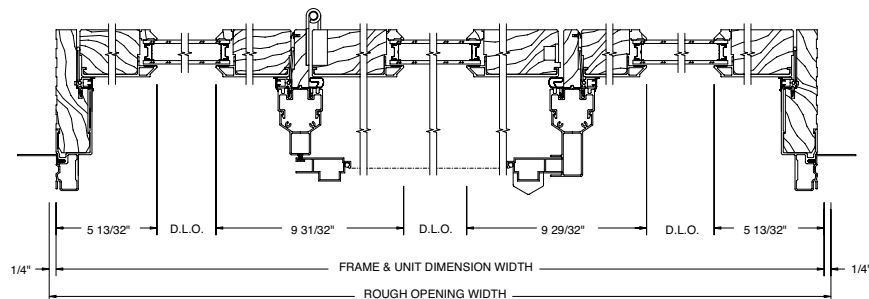

Horizontal Section

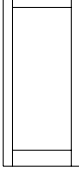
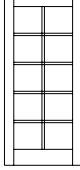
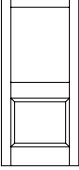
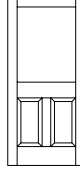
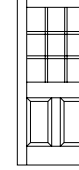

NOTE: Drawings are not to scale. Additional and the most current drawings are available at www.kolbewindows.com.

Outswing Entrance Doors | Panel Designs

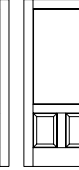
Panel Designs

									
Sash Design#:	UP810	UP825	UP8110	UP8210	UP8233	UP8110-30	UP8210-30	UP8110-24	UP8210-24
	Full Lite	2W5H Pattern	1 Lite over 1 Panel, 8\"	1 Lite over 2 Panels, 8\"	1 Lite over 2 Panels, 8\"	1 Lite over 1 Panel, 4-5/8\"	1 Lite over 2 Panels, 4-5/8\"	1 Lite over 1 Panel, 4-5/8\"	1 Lite over 2 Panels, 4-5/8\"
			Cross Rail at 40\"	Cross Rail at 40\"	Cross Rail at 40\" with 3W3H Pattern	Cross Rail at 30\"	Cross Rail at 30\"	Cross Rail at 24\"	Cross Rail at 24\"

Dimension Calculations

	Width	Height
F.S. to Panel O.S.M. (1-wide, wood)	-2 13/32"	-2 19/32"
Panel O.S.M. to G.S. (1-wide, wood)	-8 1/8"	-11 3/32"
Panel Opening Width to G.S. (2-wide)	-17 3/8"÷2	
(3-wide)	-26 5/16"÷3	
F.S. to Panel Opening Width	-2 1/8"	
G.S. to D.L.O.	-1"	-1"

Note: Dimension calculations for sidelites and transoms may be obtained from your Kolbe dealer. Clear opening dimensions can be found on pgs. 227-228.

F.S. = Frame Size • G.S. = Glass Size • O.S.M. = Outside Measurement
D.L.O. = Daylight Opening • U.D. = Unit Dimension

NOTE: Not all panel designs are available in all sizes; not all panel designs are shown. 3" cross rails are also available. See your local Kolbe dealer for assistance.

Outswing Entrance Doors | Elevation Charts

Outswing Entrance Doors

	2'-2 7/32"		4'-2 7/8"		2'-8 7/32"		5'-2 7/8"		2'-10 7/32"		5'-6 7/8"		3'-2 7/32"		6'-2 7/8"	
	R.O. 2'-2 23/32"		4'-3 3/8"		2'-8 23/32"		5'-3 3/8"		2'-10 23/32"		5'-7 3/8"		3'-2 23/32"		6'-3 3/8"	
	G.S. 15 11/16"		15 11/16"		21 11/16"		21 11/16"		23 11/16"		23 11/16"		27 11/16"		27 11/16"	
6'-10 19/32"	6'-11 3/32"	68 7/8"														
			2068	4068	2668	5068	2868	5468	3068	6068						
7'-2 19/32"	7'-3 3/32"	72 7/8"														
			2070	4070	2670	5070	2870	5470	3070	6070						
8'-2 19/32"	8'-3 3/32"	84 7/8"														
			2080	4080	2680	5080	2880	5480	3080	6080						

Segment Head Outswing Entrance Doors

	2'-2 7/32"		4'-2 7/8"		2'-8 7/32"		5'-2 7/8"		2'-10 7/32"		5'-6 7/32"		3'-2 7/32"		6'-2 7/8"	
	R.O. 2'-2 23/32"		4'-3 3/8"		2'-8 23/32"		5'-3 3/8"		2'-10 23/32"		5'-7 23/32"		3'-2 23/32"		6'-3 3/8"	
	G.S. 15 11/16"		15 11/16"		21 11/16"		21 11/16"		23 11/16"		23 11/16"		27 11/16"		27 11/16"	
6'-10 19/32"	6'-11 3/32"	68 7/8"														
			2068-SEG	4068-SEG	2668-SEG	5068-SEG	2868-SEG	5468-SEG	3068-SEG	6068-SEG						
7'-2 19/32"	7'-3 3/32"	72 7/8"														
			2070-SEG	4070-SEG	2670-SEG	5070-SEG	2870-SEG	5470-SEG	3070-SEG	6070-SEG						
8'-2 19/32"	8'-3 3/32"	84 7/8"														
			2080-SEG	4080-SEG	2680-SEG	5080-SEG	2880-SEG	5480-SEG	3080-SEG	6080-SEG						

F.S. = Frame Size • R.O. = Rough Opening • G.S. = Glass Size

Operation is viewed from the exterior.

NOTE: All measurements are nominal. Elevation charts are not to scale.

Dimensions are given for active units; dimensions for stationary units may vary.











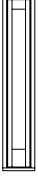

Specify outswing when ordering. When ordering single units, specify stationary, hinged left or hinged right. Double-wide doors are available as French units, with no fixed astragal between the door panels. Specify French when ordering.

Some installation procedures will require a larger rough opening than noted (i.e. installations utilizing our installation clips), therefore, you may need to increase the rough opening size accordingly. Rough opening gaps may be increased up to a maximum of 1/2" on all sides and still be within good practice guidelines. For rough opening recommendations, see pg. 216.

Additional and the most current drawings are available at www.kolbewindows.com.

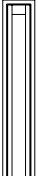



Outswing Entrance Door Sidelites

F.S.	1'-2 1/4"	1'-4 1/4"	1'-6 1/4"	1'-8 1/4"
R.O.	1'-2 3/4"	1'-4 3/4"	1'-6 3/4"	1'-8 3/4"
G.S.	7 5/8"	9 5/8"	11 5/8"	13 5/8"

6'-10 19/32" 6'-11 3/32" 68 7/8"				
7'-2 19/32" 7'-3 3/32" 72 7/8"				
8'-2 19/32" 8'-3 3/32" 84 7/8"				

F.S. = Frame Size • R.O. = Rough Opening • G.S. = Glass Size

Outswing Entrance Door Sidelite Panel Designs

				
Sash Design#: UP710	UP715	UP7110	UP7110-30	UP7110-24
Full Lite	1W5H Pattern	1 Lite over 1 Panel, 8" Cross Rail at 40°	1 Lite over 1 Panel, 4-5/8" Cross Rail at 30°	1 Lite over 1 Panel, 4-5/8" Cross Rail at 24°

NOTE: All measurements are nominal. Elevation charts are not to scale.

Some installation procedures will require a larger rough opening than noted (i.e. installations utilizing our installation clips), therefore, you may need to increase the rough opening size accordingly. Rough opening gaps may be increased up to a maximum of 1/2" on all sides and still be within good practice guidelines. For rough opening recommendations, see pg. 216.

* Glass size widths are shown for one-lite glass.

Not all panel designs are available in all sizes. Not all panel designs are shown; see your local Kolbe distributor for further assistance.

Additional and the most current drawings are available at www.kolbewindows.com.

Outswing Entrance Doors | Elevation Charts

Outswing Entrance Doors | Rectangular Transoms

F.S.	2'-2 7/32"	2'-8 7/32"	2'-10 7/32"	3'-2 7/32"	4'-2 7/8"	5'-2 7/8"	5'-6 7/8"	6'-2 7/8"
R.O.	2'-2 23/32"	2'-8 23/32"	2'-10 23/32"	3'-2 23/32"	4'-3 3/8"	5'-3 3/8"	5'-7 3/8"	6'-3 3/8"
G.S.	19 19/32"	25 19/32"	27 19/32"	31 19/32"	44 1/4"	56 1/4"	60 1/4"	68 1/4"
11 1/2"								
1'-0" 4 7/8"	2010	2610	2810	3010	4010	5010	5410	6010
1'-0" 1'-4"								
1'-3 1/2"	2014	2614	2814	3014	4014	5014	5414	6014
1'-4" 8 7/8"								
1'-5 1/2"	2016	2616	2816	3016	4016	5016	5416	6016
1'-6" 10 7/8"								
1'-8"	2018	2618	2818	3018	4018	5018	5418	6018
1'-8" 12 7/8"								
1'-11 1/2"	2020	2620	2820	3020	4020	5020	5420	6020
2'-0" 16 7/8"								
2'-5 1/2"	2026	2626	2826	3026	4026	5026	5426	6026
2'-6" 22 7/8"								

F.S. = Frame Size • R.O. = Rough Opening • G.S. = Glass Size

NOTE: All measurements are nominal. Elevation charts are not to scale.

Dimensions are given for active units; dimensions for stationary units may vary.

When ordering, specify outswing. If you are ordering a single unit, specify stationary, hinged left or hinged right.

Double-wide doors are available as French units, with no fixed astragal between the door panels. Specify French when ordering.

Some installation procedures will require a larger rough opening than noted (i.e. installations utilizing our installation clips), therefore, you may need to increase the rough opening size accordingly. Rough opening gaps may be increased up to a maximum of 1/2" on all sides and still be within good practice guidelines. For rough opening recommendations, see pg. 216.

Additional and the most current drawings are available at www.kolbewindows.com.





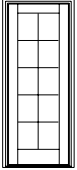
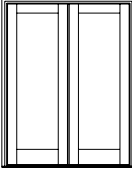
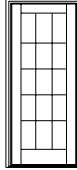
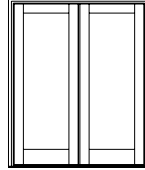
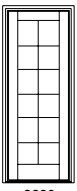
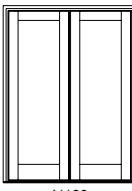
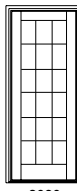
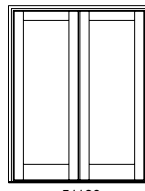



















Outswing Patio Doors | Elevation Charts

Outswing Patio Doors

	F.S.	2'-6 27/32"	5'-0 1/8"	3'-0 27/32"	6'-0 1/8"
	R.O.	2'-7 11/32"	5'-0 5/8"	3'-1 11/32"	6'-0 5/8"
	G.S.	20 5/16"	20 5/16"	26 5/16"	26 5/16"
6'-7 3/8"					
6'-7 7/8"					
65 11/16"					
7'-11 15/32"					
7'-11 31/32"					
81 3/4"					

Operation is viewed from the exterior.

Outswing Patio Doors | Rectangular Transoms

	F.S.	2'-6 27/32"	3'-0 27/32"	5'-0 1/8"	6'-0 1/8"
	R.O.	2'-7 11/32"	3'-1 11/32"	5'-0 5/8"	6'-0 5/8"
	G.S.	24 7/32"	30 7/32"	53 1/2"	65 1/2"
1'-0"					
1'-4"					
1'-6"					
1'-8"					
2'-0"					
2'-5 1/2"					

F.S. = Frame Size • R.O. = Rough Opening • G.S. = Glass Size

NOTE: All measurements are nominal. Elevation charts are not to scale.

Rectangular transom units are sash set as standard. The units shown are stand-alone units. Adjustments may be required when stacking over other units; adjustments will be made in the factory.

Some installation procedures will require a larger rough opening than noted (i.e. installations utilizing our installation clips), therefore, you may need to increase the rough opening size accordingly. Rough opening gaps may be increased up to a maximum of 1/2" on all sides and still be within good practice guidelines. For rough opening recommendations, see pg. 216.

Additional and the most current drawings are available at www.kolbewindows.com.

Outswing Doors | Hinging Options

Hinging for Outswing Doors

HR (Hinged Right)

door interior

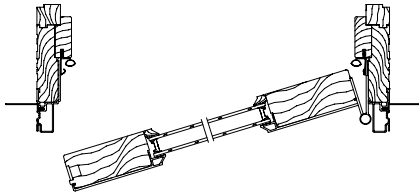

door exterior

HL (Hinged Left)

door interior

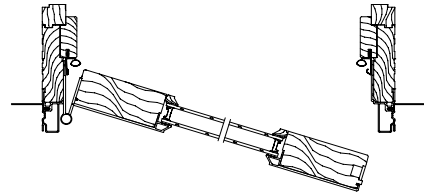

door exterior

AR (French, Hinged Left, Active)

door interior

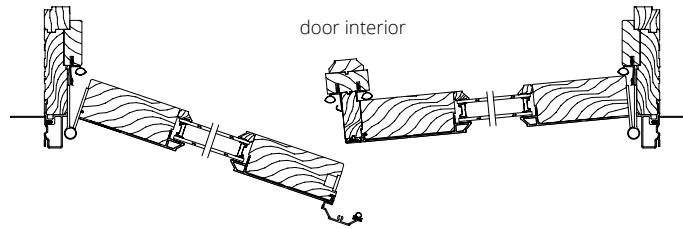

door exterior

AL (French, Hinged Right, Active)

door interior

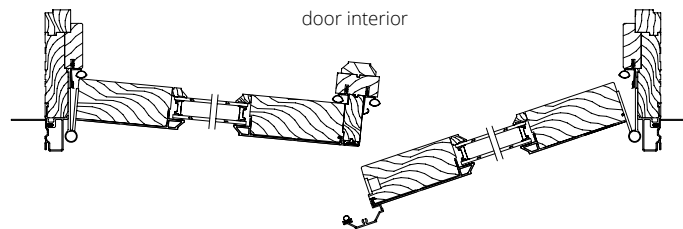

door exterior

Operation is viewed from the exterior.

NOTE: Drawings are not to scale. Additional and the most current drawings are available at www.kolbewindows.com.

Outswing Doors | Cross Section Drawings

1-Wide Operating Outswing Door

Horizontal Section

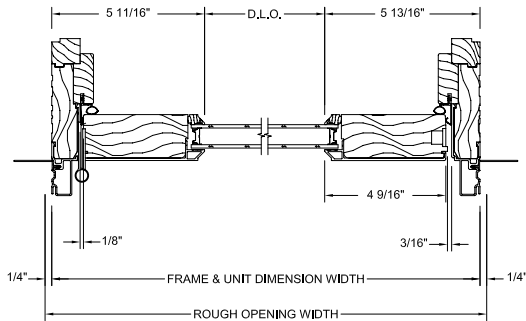

Active Outswing Door

Vertical Section

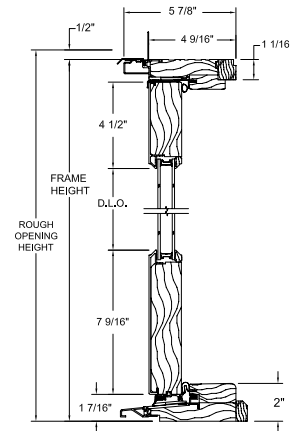

Outswing Door with 1-15/16\" Brickmould

Horizontal Section

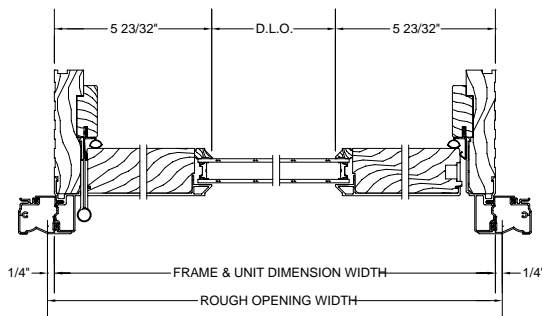

Vertical Section

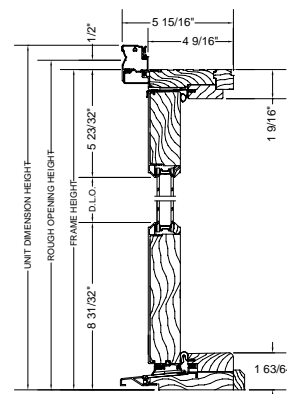

Transom Stacked Over Outswing Door

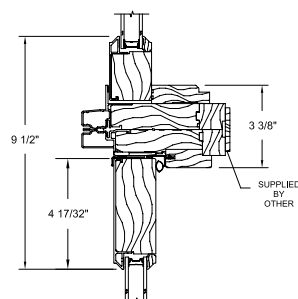

NOTE: Drawings are not to scale. Brickmould is shown factory-applied. Brickmould may be shipped loose for field application. Some units are shown with optional drip cap or nailing fin. For Ultra accessory or application drawings, see pgs. 206-212. Additional and the most current drawings are available at www.kolbwindows.com.

Outswing Doors | Cross Section Drawings

2-Wide Outswing French Doors

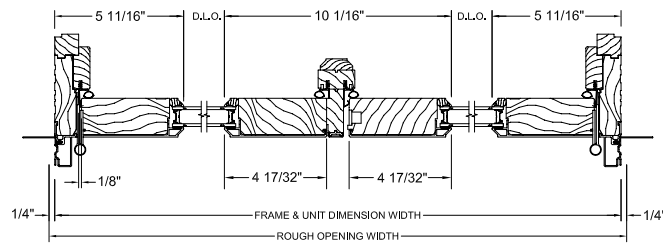

2-Wide Outswing Doors – Stationary/Active

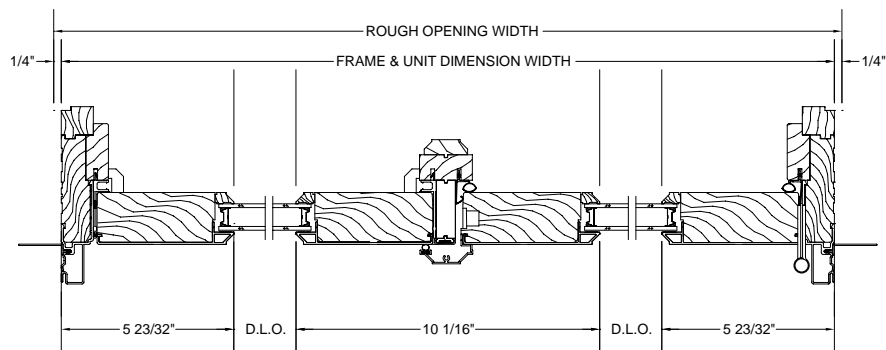

2-Wide Outswing Doors with Sidelite

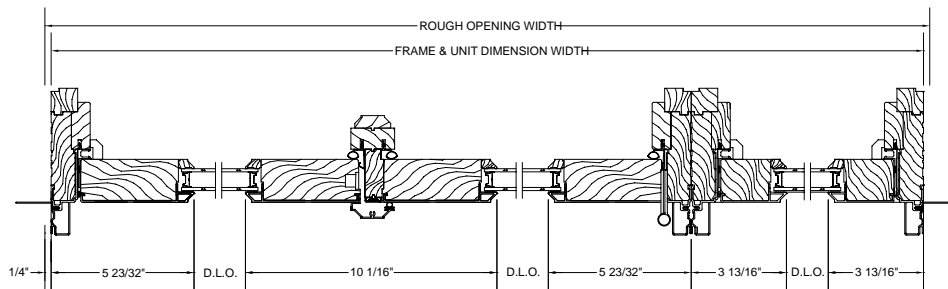

3-Wide Outswing Doors

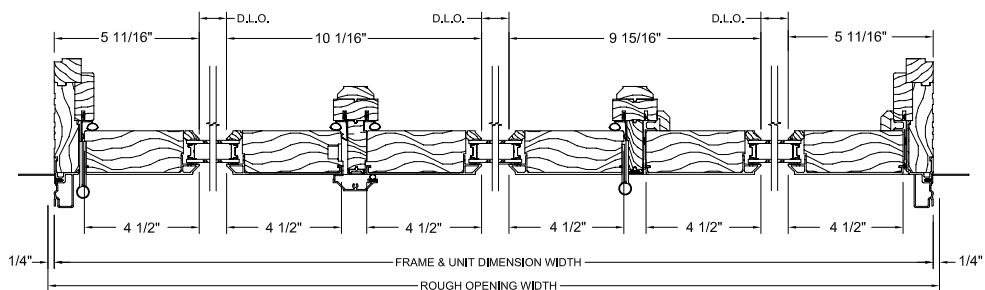

NOTE: Drawings are not to scale. Additional and the most current drawings are available at www.kolbewindows.com.







Options & Accessories

Craftsmanship and artistry are hallmarks of Kolbe products. We build innovative windows and doors with a wide array of options. But don't let the standard options limit your imagination.

At Kolbe, we love a good challenge. We welcome projects that require special wood species, custom divided lite patterns, unique shapes, custom finish colors, unusual mulling configurations – you dream it, we'll build it. Our windows and doors are built to order, which allows you to choose the options that best fit with the design and vision of your project. We offer many customizable options that blend beautifully with your home's décor.



Architects: Greg Presley and Peter Block
Interior designer: Beth Webb
Photographer: Emily Jenkins Followill
Photo courtesy of Traditional Home

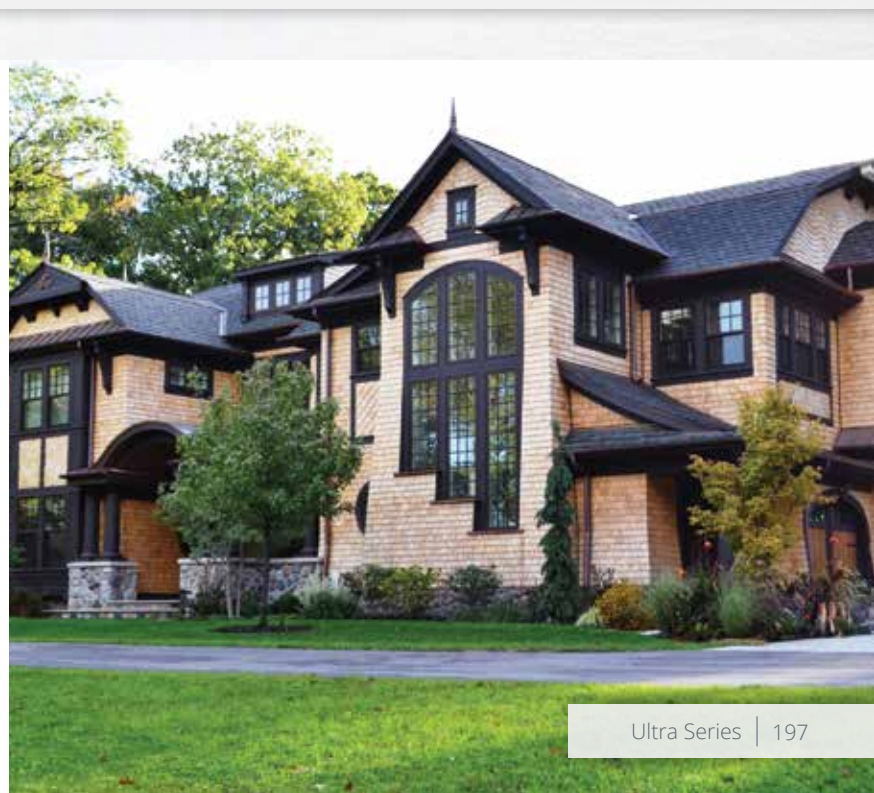

Finish Options

Interior Wood Species

In addition to the standard pine, Ultra Series windows and doors can be constructed of other optional wood species that enhance their look. Pine and other wood species are sourced from managed forests. The Forest Stewardship Council® (FSC®)-certified wood species are also available for green building projects (FSC® license code FSC-C019541). Ask about the availability of additional wood species.

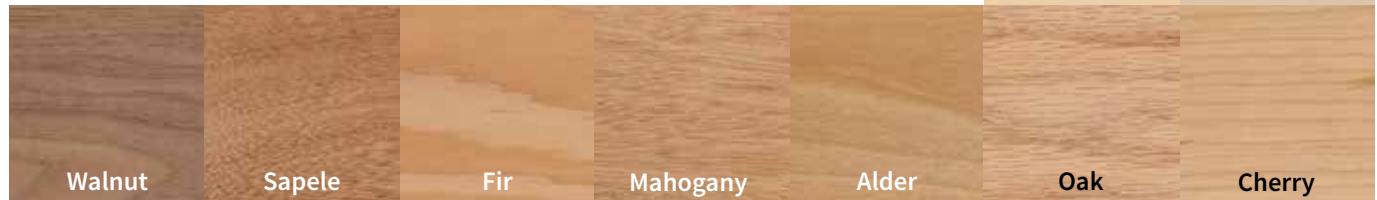

Interior Finish Options

For units that are ready to install upon delivery, Ultra Series windows and doors can be prefinished on the interior with one of the water-based stains or paints shown. Stained units are given two coats of satin finish clear sealer, with light sanding between coats. Custom stain and paint colors are also available. Factory applied interior finishes save you the hassle of clean up and disposal while helping reduce VOCs on the jobsite.

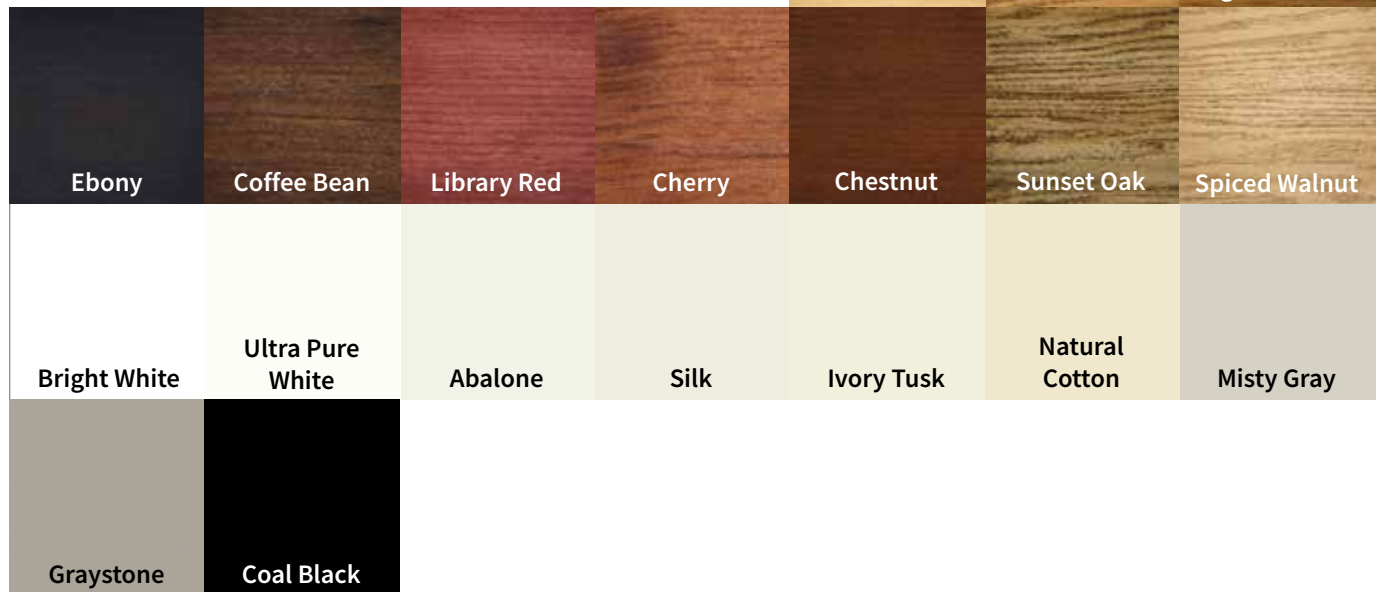

Printed images of wood species and stain options will vary from actual product colors. Selections should be made based on color samples available from your Kolbe dealer. Stain colors are shown on pine. A double coat clear finish is also offered. Since no two trees are identical, wood can be expected to differ both in color and graining. These factors will influence the stain's final color.

Color-matched interior paint is available through any Sherwin-Williams retail store in the United States and Canada.

Exterior Color Options

Ultra Series products are finished with a 70% PVDF fluoropolymer coating, which is the best choice for durability and resistance to chemicals, abrasion, corrosion, and weathering. It carries up to a 30-year warranty, which proves Kolbe's commitment to providing the very best. In addition to the standard colors, custom colors can be specified, as can 4 anodized aluminum finishes and 4 mica fluoropolymer finishes.

					White	Cloud	Ultra Pure White
					Abalone	Alabaster	Camel
Mudpie	Nutmeg	Khaki	Sahara	Beige	Natural Cotton	Spiced Vinegar	
Gingersnap	Truffle	Bronze	Rustic	Shadow	Shale	Smokestack	
Onyx	Coal Black	Midnight	Steel Gray	Slate	Castlerock	Timberwolf	
Corbeau	Sapphire	Coastal Storm	Anchor Gray	Lunar	Emerald Isle	Mediterranean	
Cider	Copper Canyon	Maize	Green Tea Leaf	Basil	Hartford Green	Mystic Ivy	
Papaya	Roma	Chutney	Create Your Color				
Galaxy Silver	Silverstorm	Cosmic Gray	Night Sky	Mica	Anodized	Clear	Champagne
						Black	Dark Bronze

Some options for our products may have limited color offerings or may incur a nominal charge. Check with your Kolbe dealer for further details on pricing and availability. Printed images of exterior finishes may vary slightly from actual colors. Selections should be made based on actual color samples available from your Kolbe dealer. There is a "color range" with anodized colors. That is, there is an acceptable "light" to "dark" color range that can be experienced on any job. According to AAMA 611-98 specifications, Section 8.3, the range may be up to 5 Delta E's. We can provide from our anodized vendor color samples of this color range if requested. The color range is due to numerous variables which include (but are not limited to) the shape of the parts, alloy variations and time in the anodizing process. This could mean that a sash part may appear slightly different in color than a frame part. This is/will be acceptable. Even the samples that may be provided may vary from the final product due to the variables. You must be aware of this as this will be considered acceptable.

Glass Options

Glass

Kolbe offers glazing options to provide optimum energy efficiency for the geographic region in which you live. Low-E is a “smart” coating that reduces energy transfer through the insulating glass unit. The result is reduced heating and cooling costs throughout the year. Low-E coatings also reduce the potential for condensation, as well as provide protection against fading of furniture, fabrics and carpeting.

Kolbe offers the following Low-E glass options, as well as many specialized options.

Solar Low-E

Suitable for most climates and meets most energy zone requirements. Solar Low-E glass is designed to reflect room-side heat back into the room during winter months. In summer, visible sunlight is allowed in while blocking most of the sun’s infrared heat energy. Kolbe’s standard.

Solar Gain Low-E

When the weather turns frigid, Solar Gain Low-E glass is the perfect cold remedy. It keeps homes warmer and more comfortable by blocking heat loss to the outside and letting the sun’s heat stream in to increase solar heat gain.

Solar Advanced Control Low-E

A tinted glass recommended for warm climates that achieves solar control over a wide range of the spectrum, while also helping to reduce glare.

Solar Control Low-E

Offers an ideal balance of solar control and high visibility by blocking 95% of UV rays while maintaining the interior temperature.

ThermaPlus™ Low-E

An additional Low-E coating which helps to meet the strictest energy requirements by providing protection against heat loss and UV damage. Available with dual pane versions of Solar Low-E, Solar Control Low-E or Solar Advanced Control Low-E glass.

Triple Pane

Provides a greater energy performing window that keeps indoor air warm and comfortable, prevents heat loss and lowers your heating bills. It is constructed with three panes of glass, thermal spacer bars and is available in Solar Low-E, Solar Gain Low-E, Solar Control Low-E and Solar Advanced Control Low-E glass.

Preserve® Film

A protective film that protects the glass surfaces from scratches during transit and construction, as well as reducing the time involved in job site clean-up.

Tinted, Colored or Patterned

Provides shading, privacy or visual interest.

Tempered

Standard in Kolbe doors to address safety concerns. Also available in window units to meet specific building codes.

Laminated

Benefits include safety, security, sound control and provides the ultimate in UV blockage.

Impact

Glazing utilized to withstand harsh environmental conditions, especially in coastal regions. Combined with an impact rated product, this glazing offers the highest level of security.

Neat®

Harnesses the sun’s UV rays to loosen dirt so water can rinse it away, leaving windows virtually spotless. A special sputter-coating process makes the glass ultra smooth, so the water “sheets off” more readily than it would on uncoated glass, allowing you to spend less time cleaning.

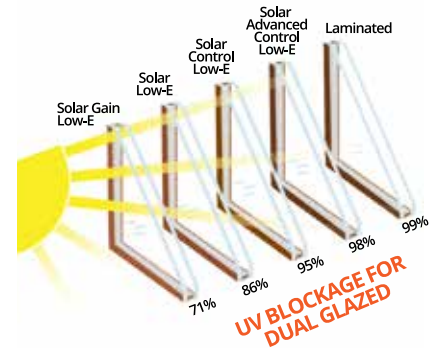

NOTE: Tested units include argon. The laminate has 1/4" inner pane. Based on Lawrence Berkeley Lab (LBL) Window 5.2 © 2003 analysis for classical UV transmission data.



Not all glass is available on all products. Please contact your Kolbe dealer for product specifics. Neat and Preserve are trademarks of Cardinal IG.

Low-E insulating glass with a stainless steel spacer bar carries a 20-year warranty. Not all glass options listed have the same glass warranty. Please contact your dealer for details.

Divided Lite Options

Expand the character of your home or project by adding one of our divided lite options to your windows and doors. Choose anything from a traditional, colonial-style pattern to a unique, custom design to accentuate the overall appearance of your project. Kolbe offers two types of divided lites for Ultra Series products: performance divided lites and grilles-in-the-airspace. As standard, wood bars have a beveled profile, however, an ovolo profile or a square profile is also available. Divided lite cross section drawings can be found on pg. 213.

Performance Divided Lites

Kolbe's performance divided lite (PDL) glazing system gives the appearance of true divided lites without sacrificing energy efficiency. Extruded aluminum bars are adhered to the exterior and pine bars are adhered to the interior of the single lite of insulating glass. Aesthetically pleasing spacer bars are installed within the insulating glass unit. Together, these bars create the illusion of true divided lites. PDL bars are available in 5/8", 7/8", 1-1/8", 1-3/8", 1-3/4", 2-1/4" or 4-1/2" bar widths. The exterior finish of the aluminum bars will match the exterior finish on the unit. Variations on the PDL option may include custom grille patterns, custom bar widths or no spacer bars. Some designs may have a composite material for the exterior PDL bar.



Beveled



Ovolo



Square

Grilles-in-the-Airspace

Grilles-in-the-airspace are constructed with aluminum bars sealed between two panes of insulating glass, offering the look of divided panes while reducing cleaning time. For units with 7/8" insulating glass, contoured, 3/4" wide bars are standard in White, Beige, Sand, Rustic, Hartford Green and Chutney. Optional colors are light wood and dark wood faux finishes. Two-tone contour or flat grilles are available with either light or dark wood faux finishes to the interior and White to the exterior. Also available for 7/8" insulating glass are 5/16" wide Brass and Pewter pencil bars.

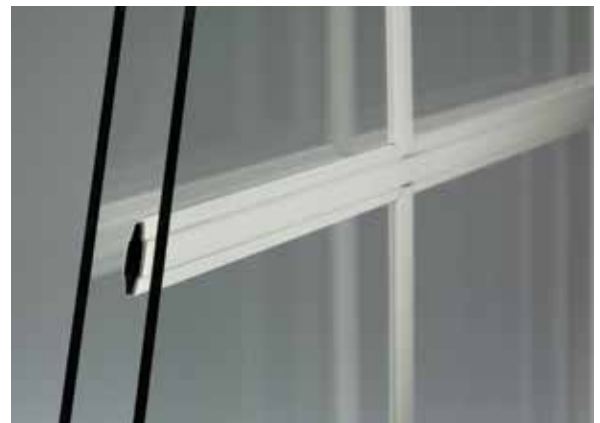

Glazing Beads & Muntin Bars

As standard, glazing beads have a beveled profile, but may also be ordered with an ovolo or square profile. Matching muntin bars are available on units with performance divided lites (PDL). Units will have beveled muntin bars on the exterior, regardless of which profile is chosen for the interior (See divided lite cross section drawings on pg. 213).



Beveled



Ovolo



Square

Options & Accessories

Exterior Trim Options

Ultra Series windows and doors are standard without brickmould. For a more distinctive look, numerous different extruded aluminum trim profiles are available. Various sill nosings can also be applied with brickmould to enhance the overall appearance and to create the perfect look. Custom brickmoulds and casings are available as well; talk to your local Kolbe dealer for more information.



1-15/16" brickmould



1-5/8" brickmould



2" flat casing



2" flat casing with backband



3-1/2" profiled brickmould



3-1/2" flat casing



3-1/2" flat casing with backband



Ogee casing



Bull nose casing



Historic brickmould



Pavilion brickmould



Stucco casing



Beaded casing



Beaded casing with backband



Chicago brickmould
(field applied only)

NOTE: Additional trim details are shown on pgs. 206-212.

Universal Design

To meet the needs of homeowners with physical limitations, Kolbe offers a variety of windows and doors that are designed to make independent living possible. From door sills that create a flush surface for easier passage between the interior and exterior, to window and door hardware that provides ease of operation, we have numerous options that will help make living at home far easier. Whether your project is new construction or you are adapting an existing residence for a special need, Kolbe's windows and doors with universal design options will give you the freedom and style you are seeking.

Casements



Longer crank handles with large knobs for casement windows make operating easier. Available in white or clay.



Larger levers for multi-point casement locks make locking of a casement window easy. Available in white or clay.



Motorized operators make opening and closing casement windows simple and effortless. Available in white or clay.

Double Hungs



A crank handle hardware kit for double hungs allows the bottom sash to be operated with minimal effort. Available in white.

Swinging Doors



Wider door sizes help provide additional space for those who use mobility aids.



ADA-compliant sills (thermal break and non-thermal break) for swinging doors create a flush surface for easy access to pass through.



Lever handles for swinging doors are available in a variety of styles and finishes and make operation easier than doors with knobs.

Sliding Doors



Aluminum sill ramp kits for Garden-Aire sliding patio doors allow smooth transitioning between the interior and exterior of the home.

Many of these options meet standards of the Americans with Disabilities Act. Other options, such as taller bottom rails on doors, are also available to meet these standards. Certain product limitations and modifications may apply. Please contact your local Kolbe dealer for more information.

Window Opening Control Devices (WOCDs)

Kolbe offers Window Opening Control Devices (WOCDs) that restrict the size of the open window area to less than 4 inches, and feature a limit release mechanism to allow for emergency escape. These devices allow the window to latch into place at a predetermined position and automatically re-latch when closed. The WOCDs meet the ASTM F2090-13 requirements.

WOCDs can be factory applied to Ultra Series Sterling double hungs, XL Sterling double hungs, and Traditional double hungs, and are available in a Satin Nickel finish. WOCDs may also be field-applied to crank-out and push-out casements.



Double Hung with WOCD



Crank-out Casement with WOCD

NOTE: This device meets the stringent safety requirement of ASTM F2090-13 if applied per recommendations. Not all windows are available with Window Opening Control Devices. Please ask your local Kolbe dealer about availability.

Options & Accessories

Retractable Insect Screen Kit

For those who prefer an unobstructed view at times, a retractable insect screen kit is offered for Kolbe's Ultra Series Sterling and XL Sterling double hungs, crank-out casements and awnings, and push-out casements and awnings. Wood components that match the interior wood species and finish disguise the screen hardware, revealing only the beauty of the window. When you want to open your window and use the screen, operation is practically effortless. Simply press the pull bar down to the sill to engage the screen; a gentle push toward the exterior allows the screen to retract. BetterVue® fiberglass screen mesh is used as standard for a clearer view; UltraVue® fiberglass screen mesh is also available.

Kit includes all components necessary for field installation.



Kit Components:

- a – Side rails
- b – Cassette
(housing and pull bar)



- c – Wood trim for side rails
- d – Wood trim for housing
- e – Screws
- f – Wood trim for pull bar



Insect Screen Mesh

Kolbe windows feature various screen mesh options to keep insects out. BetterVue® fiberglass mesh is less visible than many screens in the industry, and has a tighter weave to keep smaller bugs out. It is also flame retardant, and doesn't stain, crease or dent. UltraVue® mesh offers the ultimate in visibility. Both of these options meet strict chemical emissions limits for healthier interiors. Or, choose durable Aluminum screen mesh to help guard against damage from fiberglass screen-eating insects found in certain regions.



BetterVue® Mesh



UltraVue® Mesh



Aluminum Mesh

Water Shed Technology™

Water Shed Technology is an advanced water repellent coating that allows screens to repel water and debris. BetterVue and UltraVue mesh feature this durable coating that increases the life expectancy of the screens, by keeping them cleaner longer. Water beads up and rolls off, to preserve viewing clarity, rain or shine.



Water Shed Technology™ is a trademark of PHIFER INCORPORATED.
BetterVue® and UltraVue® are registered trademarks of PHIFER INCORPORATED.

Automation Options

For ease of use, you can operate windows and doors with a touch of a button or a flip of a switch. Kolbe integrates the latest technology advancements into select window and door products.

TerraSpan® Lift & Slide, Multi-Slide and Sliding Patio Doors

- ▶ User-friendly system with adjustable opening/closing speeds
- ▶ Capable of working with heavy door panels and multiple units

Entrance Doors

- ▶ Electronic multi-point lock system
- ▶ Allows for multiple control integration devices

Casements & Awnings

- ▶ Provides ventilation for hard-to-reach applications
- ▶ Can be integrated with multiple operating systems (*push button, toggle switch, etc.*)



Impact Performance Modifications

Most Kolbe products can be modified to meet even the most strict building code requirements. Depending on the criteria, Kolbe offers high performance impact performance products to improve air, water and structural ratings or sound transmittance ratings. With each level of modification, window and door strength is enhanced. This could be by using additional sash locks, alternate glazing methods or impact laminated glass. Contact your dealer for further details.



For specific information on the products that meet Automation or Impact Performance requirements, please contact your local distributor.



Accessories

Application Details

Expander Trim Receiver

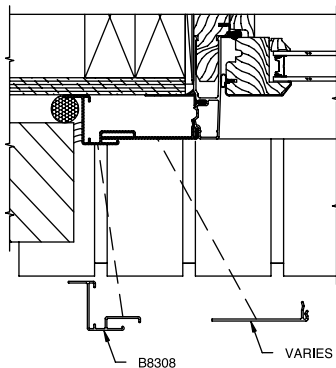

Profile B8308 used in combination with any of the frame expanders achieves various casing widths. Field-applied only. Colored to match the unit.

Frame Expanders

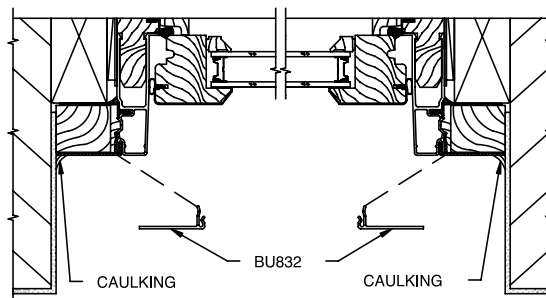

Profile BU836 is used to expand frame width to 1", Profile BU837 is used to expand frame width to 2", Profile BU832 is used to expand frame width from 3/4" to 4", Profile BU831 is used to expand frame width up to 6" and Profile BU833 is used to expand frame width up to 7". Field-applied only. Colored to match the unit.

Adjustable Mull Covers

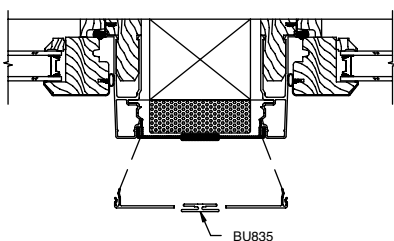

Profiles BU831, BU832, or BU833 in conjunction with Profile BU835 are used for custom units over 4" wide to 14" wide. Field-applied only. Colored to match the unit.

1 Piece Mull Cover

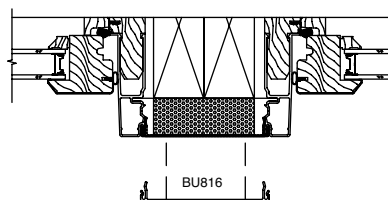

Profile

- BU817 - 1/4" Mull Cover
- BU813 - 1/2" Mull Cover
- BU818 - 1" Mull Cover
- BU814 - 1-1/2" Mull Cover
- BU815 - 2" Mull Cover
- BU875 - 2-1/2" Mull Cover
- BU819 - 3" Mull Cover
- BU829 - 3-1/2" Mull Cover
- BU816 - 4" Mull Cover (shown)
- BU861 - 5-1/2" Mull Cover
- BU852 - 6" Mull Cover

Used for standard spread mull widths from 1/4" to 6" wide. Colored to match the unit.

Mull "U" Splice

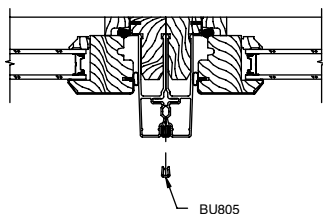

Profile BU805 is used to seal when two units are mulled directly to one another. Colored to match the unit.

NOTE: Drawings are not to scale. Additional and the most current drawings are available at www.kolbewindows.com.

Application Details

Traditional Sill Nosing *(standard)*

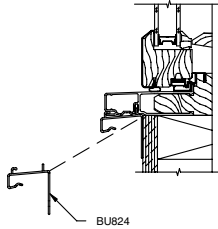

Profile BU824 may be applied to units with 1-15/16" brickmould, 3-1/2" brickmould or 3-1/2" flat casing. Colored to match the unit.

Sill Drip

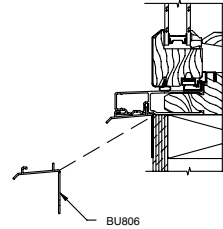

Optional Profile BU806 may be applied to units with 1-15/16" brickmould, 3-1/2" brickmould or 3-1/2" flat casing. Colored to match the unit.

1-5/8" Sill Nosing

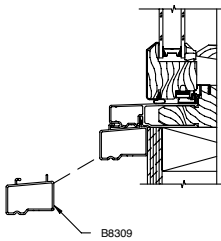

Optional Profile B8309 may be applied to units with 1-15/16" brickmould, 3-1/2" brickmould and 3-1/2" flat casing. Colored to match the unit.

2-1/8" Sill Nosing

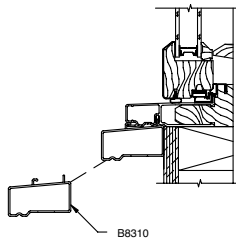

Profile B8310 is a standard application to units with backband, ogee casing and bullnose brickmould. Colored to match the unit.

2-1/8" Historic Nosing

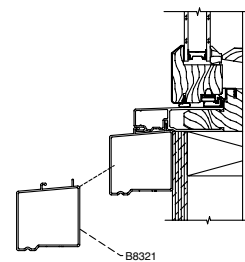

Profile B8321 is a standard application to units with historic brickmould. Colored to match the unit.

Stucco Sill Nosing

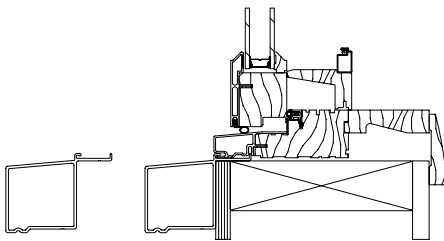

Profile B8330 is factory applied as standard and used for Stucco finish applications. Colored to match the unit.

Head & Sill Trim

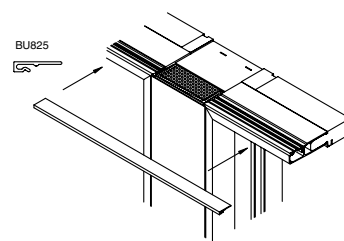

Profile BU825 may be used on spread mulls and stacked units without brickmould. Colored to match the unit.

NOTE: Drawings are not to scale. Additional and the most current drawings are available at www.kolbewindows.com.

Accessories

Application Details

1-15/16" Brickmould

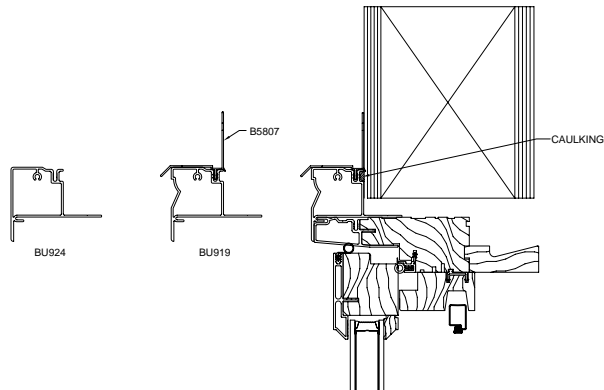

Optional Profile BU924 or standard Profile BU919 coupled with profile B5807, make up the factory-applied 1-15/16" brickmould or flat casing. Colored to match the unit. Nailing fin is applied.

3-1/2" Brickmould or Flat Casing

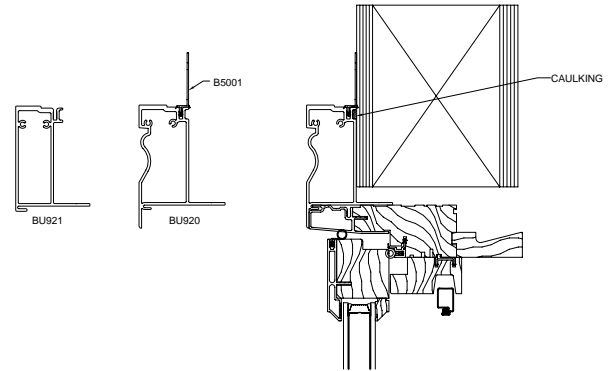

Optional flat Profile BU921 or BU920, couple with Profiles B5001, make up the factory-applied 3-1/2" brickmould or flat casing. Colored to match the unit. Nailing fin is applied.

Ogee Casing

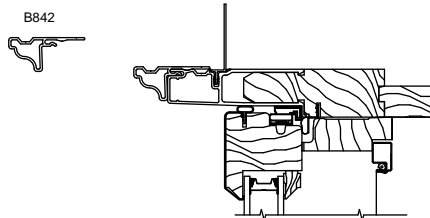

Profile B842, Ogee casing, can be used on any Ultra unit as trim. Colored to match the unit. Nailing fin applied.

Bull Nose Brickmould

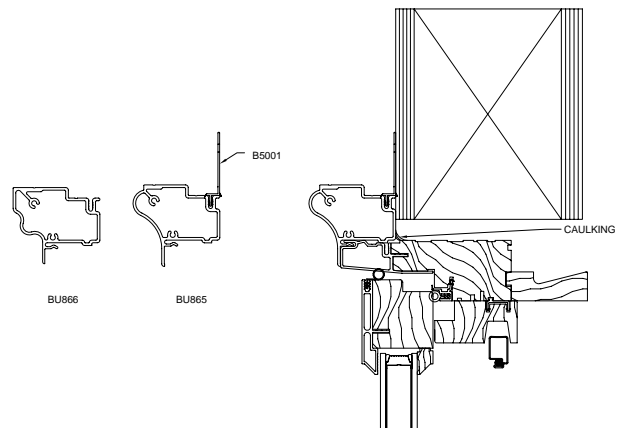

Profile BU865 or BU866, used in conjunction with Profile B5001, make up the factory-applied bull nose casing or historic trim. Colored to match the unit. Nailing fin is applied.

Stucco Casing

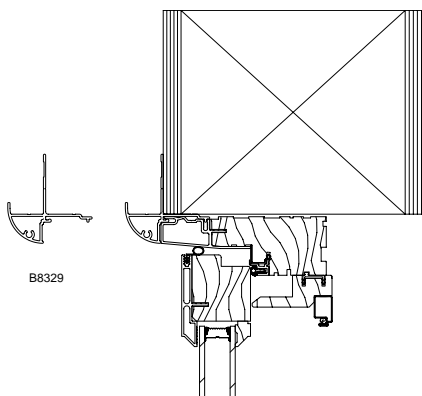

Profile B8329 is factory applied as standard and used for Stucco finish applications. Colored to match the unit.

NOTE: Drawings are not to scale. Additional and the most current drawings are available at www.kolbewindows.com.

Application Details

Backband Receiver

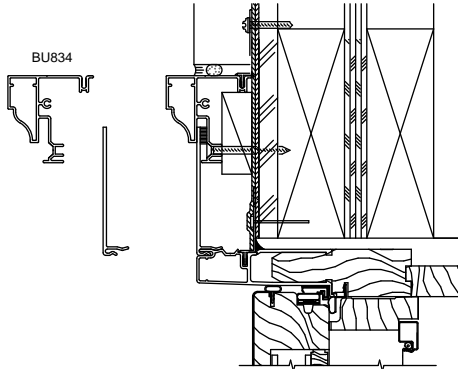

Profile BU834 used in conjunction with any of the frame expanders achieves various casing widths. Field-applied only. Colored to match the unit.

Backband Trim

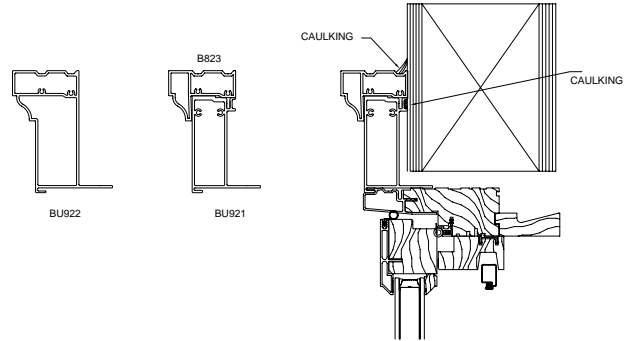

Profile BU922 (1 piece, for rectangular units only) or Profile BU921 with Profile B823 (2 piece, for radius units only), make up the factory-applied backband trim. Colored to match the unit. No nailing fin is applied to the backband trim.

Historic Brickmould

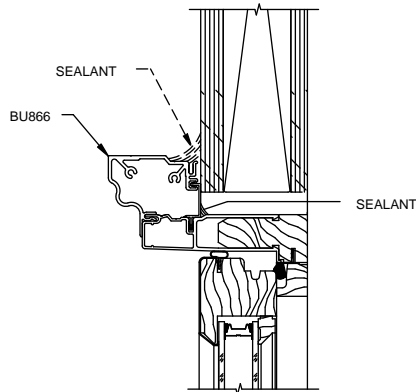

Profile BU866 is used in conjunction with trim receivers. Field-applied only. Colored to match the unit.

Field-applied Casing

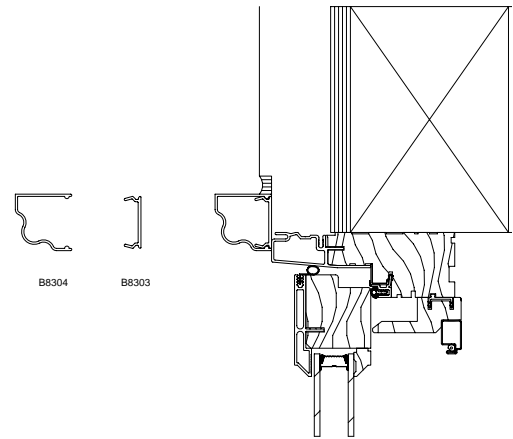

Profile B8304, coupled with Profile B8303, make up the field-applied casing. Colored to match the unit. No nailing fin is applied.

Accessories

Casing

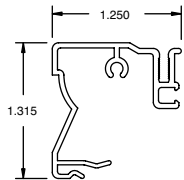

B802

2" brickmould
without leg

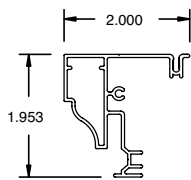

BU834

Receiver trim
backband profile

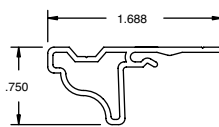

B842

Ogee trim

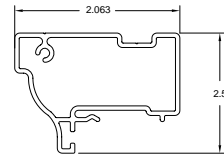

BU864

Pavilion casing

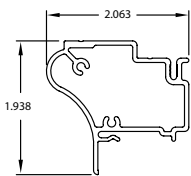

BU865

Bull nose casing

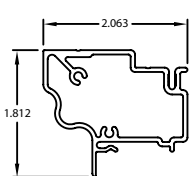

BU866

Historic trim

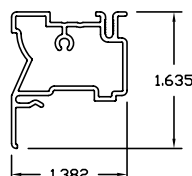

BU900

1-5/8" brickmould

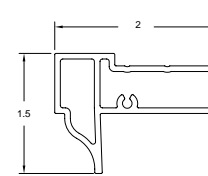

BU905

Backband

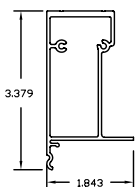

BU917

3-1/2" beaded casing

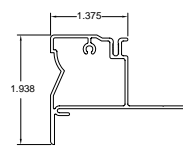

BU919

1-15/16" brickmould
with leg

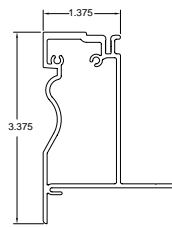

BU920

3-1/2" Brickmould
with leg

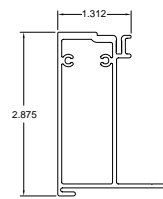

BU921

3-1/2" flat casing

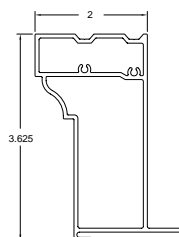

BU922

3-1/2" flat casing
with backband

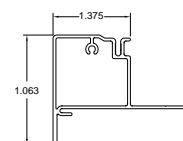

BU924

2" flat casing

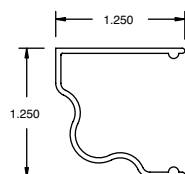

B8304

Chicago brickmould

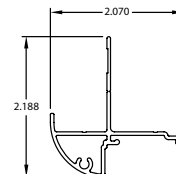

B8329

Stucco casing

NOTE: Drawings are not to scale. Additional and the most current drawings are available at www.kolbewindows.com.

Sill Nosing/Sill Extenders

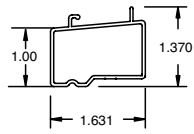

B8309

1-5/8" projected
sill nosing

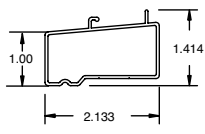

B8310

2-1/8" projected
sill nosing

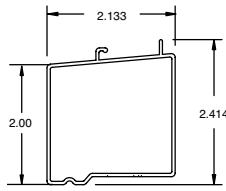

B8321

2-1/8" historic
sill nosing

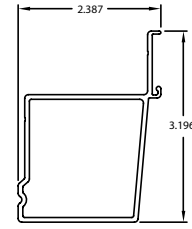

B8330

Stucco trim
sill nosing

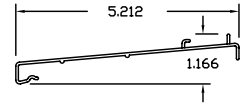

B8332

5-3/16" extended
sill nosing

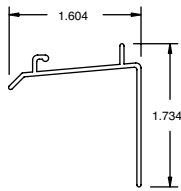

BU806

Sill drip

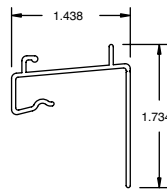

BU824

Traditional sill nosing

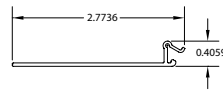

BU839

2-1/2" sill extender

Mull Covers

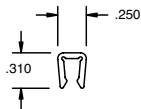

BU805

Mullion & transom
splice

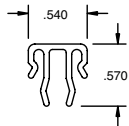

BU817

1/4" mull cover

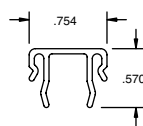

BU813

1/2" mull cover

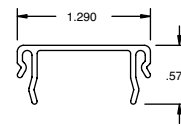

BU818

1" mull cover

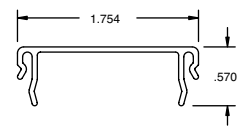

BU814

1-1/2" mull cover

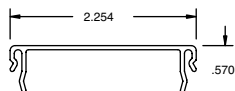

BU815

2" mull cover

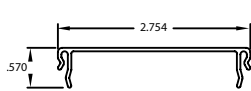

BU875

2 1/2" mull cover

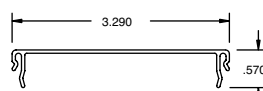

BU819

3" mull cover

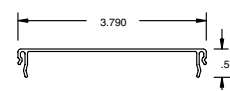

BU829

3-1/2" mull cover

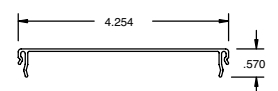

BU816

4" mull cover

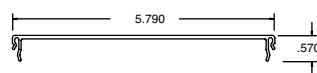

BU861

5-1/2" mull cover

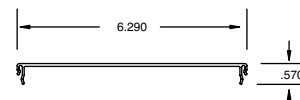

BU852

6" mull cover

NOTE: Drawings are not to scale. Additional and the most current drawings are available at www.kolbewindows.com.

Accessories

Frame Expanders

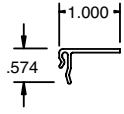

BU836

1" frame expander

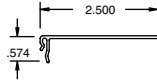

BU837

2-1/2" frame expander

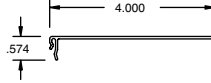

BU832

4" frame expander

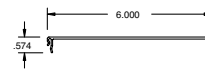

BU831

6" frame expander

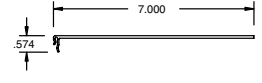

BU833

7" frame expander

Miscellaneous Accessories

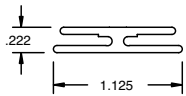

BU835

1-1/8" stepped mull
"H" splice

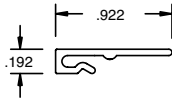

BU825

Head & sill trim
(Ultra bow & bay units)

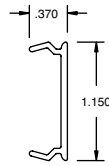

B8303

Chicago brickmould
head & side clip

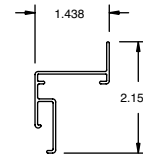

B8308

Wide flat receiver
perimeter expander trim

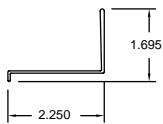

BU901

Extruded aluminum
drip cap for units
with backband

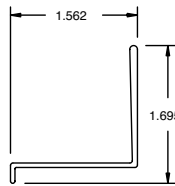

BU827

Radius nailing fin with
drip cap *(Ultra half-circle
radius units)*

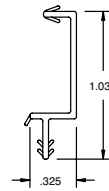

BU804

PVC trim holder

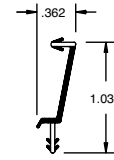

BU844

PVC trim holder
*(Ultra half-circle
radius units)*

NOTE: Drawings are not to scale. Additional and the most current drawings are available at www.kolbewindows.com.

Divided Lite | Cross Section Drawings

Beveled Performance Divided Lites

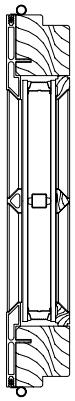

5/8"

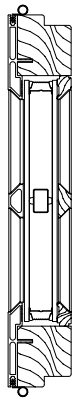

7/8"

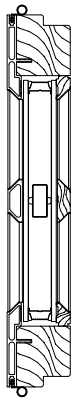

1-1/8"

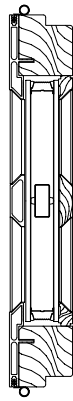

1-3/8"



1-3/4"



2-1/4"

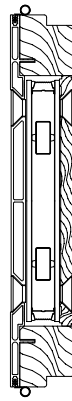

4-1/2"

Ovolo Performance Divided Lites

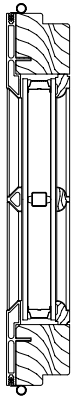

5/8"

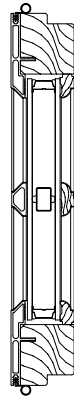

7/8"

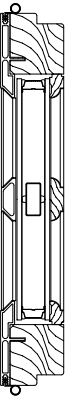

1-1/8"

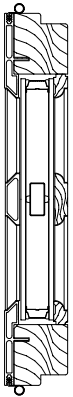

1-3/8"



1-3/4"



2-1/4"

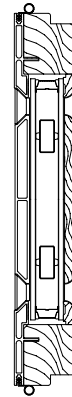

4-1/2"

Square Performance Divided Lites

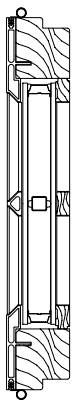

5/8"

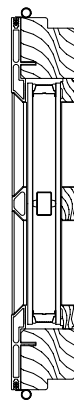

7/8"



1-1/8"

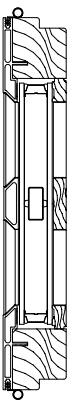

1-3/8"

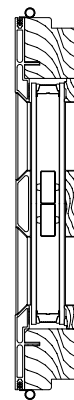

1-3/4"



2-1/4"

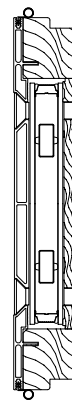

4-1/2"

NOTE: Drawings are not to scale. Additional and the most current drawings are available at www.kolbewindows.com.





Technical Data

In addition to superior craftsmanship, Kolbe windows and doors offer superior performance. Our products undergo independent testing to ensure the highest quality available. Our participation in programs such as the ENERGY STAR® and WDMA Hallmark Certification programs ensures that our products are tested to industry standards, allowing them to meet and exceed today's stricter building codes and standards for energy efficiency.

Clear Opening Dimensions | Energy Performance



Clear Opening Dimensions

Rough Opening Recommendations:

The Kolbe standard rough opening dimensions published in our product literature are provided as a guideline to maintain a minimum 1/4" space between the window or patio door and the building structure. There are certain situations where Kolbe recommends a gap larger than our published 1/4" standard:

- ▶ When installation clips are used, the gap should be increased to 1/2" on the sides, top and bottom of the unit.
- ▶ When mulls are installed in the opening, the gap all around should be increased to 1/2". For installation consistency, the same gap should be used on all units in the project.
- ▶ Kolbe recommends using a sill pan drainage system, and increasing the gap to 1/2" on the top and bottom of the unit.

Because every installation is different, Kolbe strongly recommends consultation with the local supplier or a qualified contractor, architect or structural engineer prior to the installation of any Kolbe product. Installation of Kolbe products, including sizing of rough opening, method of attachment, fastener selection, and code compliance is the sole responsibility of the architect, building owner, contractor and/or consumer.

Unless otherwise specified, if units are ordered by rough opening, Kolbe will size the units using our standard minimum 1/4" gap – regardless of the options or construction of the product ordered.

Definitions of Acceptable Emergency Escape & Rescue Openings:

"Egress" has long been the term used to describe the clear opening dimensions of a window or door necessary to enter or exit a building in case of an emergency. With the release of the International Building Code (IBC) and International Residential Code (IRC), "egress" is no longer the appropriate term.

IBC and IRC have set the following as basic requirements for Emergency Escape & Rescue Openings.

- ▶ Minimum Opening Width: 20 inches (508 mm)
- ▶ Minimum Opening Height: 24 inches (610 mm)
- ▶ Minimum Opening Area: 5.7 sq. ft. (0.53 m²)

NOTE:

Please check your local codes to confirm that these Emergency Escape & Rescue Opening requirements are applicable. Other requirements may also apply.

Notes For Casement Windows:

- ▶ Clear opening widths shown are for standard casements with multi-point locks and concealed hinges.
- ▶ Exposed Hinges (a.k.a. Euro Hinges) - The Euro hinge is the default hinge used when standard concealed casement hinges can not be utilized (*radius head units, high performance units and impact performance units*), or if this type of hinge is requested. In most cases single-arm operators are used with Euro hinges, which changes the clear opening widths. For units with this type of hinge, add 3-7/16" to widths shown for one sash open. For French casements add 6-7/8" to widths shown for two sash open. Two sash open may or may not be considered as an acceptable emergency escape and rescue opening per the local building inspector.
- ▶ All dimensions are taken with sash open to 90°, except for an "E" Series unit with dual-arm operator and concealed hinges, which opens to 75°.

NOTE: For the most up-to-date data, please visit www.kolbewindows.com. Shaded units meet most national building codes for emergency escape and rescue requirements..

Product #	Sq. Ft. Clear Opg.	Clear Opening		Sq. Ft. D.L.O.	Sq. Ft. Vent	Sq. Ft. of Unit Frame Dim.
		Width	Height			
Crank-Out Casements						
S12	1.03	7-3/4"	19-1/8"	1.18	1.62	2.67
S126	1.35	7-3/4"	25-1/8"	1.58	2.13	3.33
S13	1.68	7-3/4"	31-1/8"	1.98	2.63	4.00
S136	2.00	7-3/4"	37-1/8"	2.38	3.14	4.67
S14	2.32	7-3/4"	43-1/8"	2.78	3.65	5.33
S146	2.64	7-3/4"	49-1/8"	3.18	4.16	6.00
S15	2.97	7-3/4"	55-1/8"	3.58	4.67	6.67
S156	3.29	7-3/4"	61-1/8"	3.99	5.17	7.33
S16	3.61	7-3/4"	67-1/8"	4.39	5.68	8.00
N12	1.56	11-3/4"	19-1/8"	1.67	2.15	3.33
N126	2.05	11-3/4"	25-1/8"	2.24	2.82	4.17
N13	2.54	11-3/4"	31-1/8"	2.80	3.50	5.00
N136	3.03	11-3/4"	37-1/8"	3.37	4.17	5.83
N14	3.52	11-3/4"	43-1/8"	3.94	4.85	6.67
N146	4.01	11-3/4"	49-1/8"	4.51	5.52	7.50
N15	4.50	11-3/4"	55-1/8"	5.07	6.20	8.33
N156	4.99	11-3/4"	61-1/8"	5.64	6.87	9.17
N16	5.48	11-3/4"	67-1/8"	6.21	7.55	10.00
W12	2.09	15-3/4"	19-1/8"	2.16	2.68	4.00
W126	2.75	15-3/4"	25-1/8"	2.89	3.52	5.00
W13	3.40	15-3/4"	31-1/8"	3.63	4.36	6.00
W136	4.06	15-3/4"	37-1/8"	4.36	5.20	7.00
W14	4.72	15-3/4"	43-1/8"	5.09	6.05	8.00
W146	5.37	15-3/4"	49-1/8"	5.83	6.89	9.00
W15	6.03	15-3/4"	55-1/8"	6.56	7.73	10.00
W156	6.69	15-3/4"	61-1/8"	7.30	8.57	11.00
W16	7.34	15-3/4"	67-1/8"	8.03	9.41	12.00
L12	2.62	19-3/4"	19-1/8"	2.65	3.21	4.67
L126	3.45	19-3/4"	25-1/8"	3.55	4.22	5.83
L13	4.27	19-3/4"	31-1/8"	4.45	5.23	7.00
L136	5.09	19-3/4"	37-1/8"	5.35	6.24	8.17
L14	5.91	19-3/4"	43-1/8"	6.25	7.24	9.33
L146	6.74	19-3/4"	49-1/8"	7.15	8.25	10.50
L15	7.56	19-3/4"	55-1/8"	8.05	9.26	11.67
L156	8.38	19-3/4"	61-1/8"	8.95	10.27	12.83
L16	9.21	19-3/4"	67-1/8"	9.86	11.27	14.00
X12	2.89	21-3/4"	19-1/8"	2.89	3.48	5.00
X126	3.79	21-3/4"	25-1/8"	3.88	4.57	6.25
X13	4.70	21-3/4"	31-1/8"	4.86	5.66	7.50
X136	5.61	21-3/4"	37-1/8"	5.84	6.75	8.75
X14	6.51	21-3/4"	43-1/8"	6.83	7.84	10.00
X146	7.42	21-3/4"	49-1/8"	7.81	8.93	11.25
X15	8.33	21-3/4"	55-1/8"	8.80	10.02	12.50
X156	9.23	21-3/4"	61-1/8"	9.78	11.12	13.75
X16	10.14	21-3/4"	67-1/8"	10.77	12.21	15.00
E13	5.57	25-3/4"	31-1/8"	6.09	6.96	9.00

Product #	Sq. Ft. Clear Opg.	Clear Opening		Sq. Ft. D.L.O.	Sq. Ft. Vent	Sq. Ft. of Unit Frame Dim.
		Width	Height			
Crank-Out Casements (continued)						
E136	6.64	25-3/4"	37-1/8"	7.33	8.30	10.50
E14	7.71	25-3/4"	43-1/8"	8.56	9.64	12.00
E146	8.78	25-3/4"	49-1/8"	9.80	10.98	13.50
E15	9.86	25-3/4"	55-1/8"	11.03	12.32	15.00
E156	10.93	25-3/4"	61-1/8"	12.27	13.66	16.50
E16	12.00	25-3/4"	67-1/8"	13.50	15.00	18.00

Product #	Sq. Ft. Clear Opg.		Clear Opg. Width		Clear Opg. Ht.	Sq. Ft. D.L.O.	Sq. Ft. Vent	Sq. Ft. of Unit Frame Dim.
	1 Open	2 Open	1 Open	2 Open				
French Crank-Out Casements								
N23	2.68	5.90	12-13/32"	27-5/16"	31-1/8"	5.95	7.82	10.00
N236	3.20	7.04	12-13/32"	27-5/16"	37-1/8"	7.16	9.33	11.67
N24	3.72	8.18	12-13/32"	27-5/16"	43-1/8"	8.36	10.84	13.33
N246	4.23	9.32	12-13/32"	27-5/16"	49-1/8"	9.57	12.35	15.00
N25	4.75	10.46	12-13/32"	27-5/16"	55-1/8"	10.78	13.85	16.67
N256	5.27	11.59	12-13/32"	27-5/16"	61-1/8"	11.98	15.36	18.33
N26	5.78	12.73	12-13/32"	27-5/16"	67-1/8"	13.19	16.87	20.00
W23	3.55	7.45	16-13/32"	35-5/16"	31-1/8"	7.60	9.55	12.00
W236	4.23	9.10	16-13/32"	35-5/16"	37-1/8"	9.14	11.39	14.00
W24	4.91	10.58	16-13/32"	35-5/16"	43-1/8"	10.68	13.23	16.00
W246	5.60	12.05	16-13/32"	35-5/16"	49-1/8"	12.22	15.07	18.00
W25	6.28	13.52	16-13/32"	35-5/16"	55-1/8"	13.76	16.92	20.00
X23	4.84	10.23	22-13/32"	47-5/16"	31-1/8"	10.07	12.14	15.00
X236	5.78	12.20	22-13/32"	47-5/16"	37-1/8"	12.11	14.49	17.50
X24	6.71	14.17	22-13/32"	47-5/16"	43-1/8"	14.15	16.83	20.00
X246	7.64	16.14	22-13/32"	47-5/16"	49-1/8"	16.19	19.17	22.50
X25	8.58	18.11	22-13/32"	47-5/16"	55-1/8"	18.22	21.51	25.00

Notes For Push-Out Casement Windows:

- ▶ Clear opening widths shown are for units with friction hinges and no screen. If the following screen options are used, the clear opening widths will need to be adjusted as noted:
 - Swinging screen:
 - Vent area decreases by 7%
 - Retractable screen:
 - Vent area decreases by 23%
 - Subtract 21/32" for clear opening width
 - Subtract 2-13/16" for clear opening height
 - Friction Adjuster with no screen or with swinging screen:
 - Add 4-15/32" (or 5-31/32" for "E" Series) for clear opening width
 - Friction Adjuster with retractable screen:
 - Add 3-13/16" (or 5-5/16" for "E" Series) for clear opening width
- ▶ Two sash open may or may not be considered as an acceptable emergency escape and rescue opening per the local building inspector

Product #	Sq. Ft. Clear Opg.	Clear Opening		Sq. Ft. D.L.O.	Sq. Ft. Vent	Sq. Ft. of Unit Frame Dim.
		Width	Height			
Push-Out Casements						
S12	1.01	7-1/4"	20"	1.04	1.75	2.67
S126	1.31	7-1/4"	26"	1.41	2.28	3.33
S13	1.61	7-1/4"	32"	1.78	2.81	4.00
S136	1.91	7-1/4"	38"	2.15	3.33	4.67
S14	2.22	7-1/4"	44"	2.52	3.86	5.33
S146	2.52	7-1/4"	50"	2.89	4.38	6.00
S15	2.82	7-1/4"	56"	3.26	4.91	6.67
S156	3.12	7-1/4"	62"	3.63	5.44	7.33
S16	3.42	7-1/4"	68"	4.00	5.96	8.00
N12	1.56	11-1/4"	20"	1.51	2.31	3.33
N126	2.03	11-1/4"	26"	2.05	3.00	4.17
N13	2.50	11-1/4"	32"	2.58	3.69	5.00
N136	2.97	11-1/4"	38"	3.12	4.39	5.83
N14	3.44	11-1/4"	44"	3.65	5.08	6.67
N146	3.91	11-1/4"	50"	4.19	5.77	7.50
N15	4.38	11-1/4"	56"	4.73	6.47	8.33
N156	4.84	11-1/4"	62"	5.26	7.16	9.17
N16	5.31	11-1/4"	68"	5.80	7.85	10.00
W12	2.12	15-1/4"	20"	1.98	2.86	4.00
W126	2.75	15-1/4"	26"	2.68	3.72	5.00
W13	3.39	15-1/4"	32"	3.38	4.58	6.00
W136	4.02	15-1/4"	38"	4.09	5.44	7.00
W14	4.66	15-1/4"	44"	4.79	6.30	8.00
W146	5.30	15-1/4"	50"	5.49	7.16	9.00
W15	5.93	15-1/4"	56"	6.20	8.02	10.00
W156	6.57	15-1/4"	62"	6.90	8.88	11.00
W16	7.20	15-1/4"	68"	7.60	9.74	12.00
L12	2.67	19-1/4"	20"	2.45	3.42	4.67
L126	3.48	19-1/4"	26"	3.32	4.45	5.83
L13	4.28	19-1/4"	32"	4.19	5.47	7.00
L136	5.08	19-1/4"	38"	5.06	6.50	8.17
L14	5.88	19-1/4"	44"	5.93	7.52	9.33
L146	6.68	19-1/4"	50"	6.80	8.55	10.50
L15	7.49	19-1/4"	56"	7.67	9.58	11.67
L156	8.29	19-1/4"	62"	8.53	10.60	12.83
L16	9.09	19-1/4"	68"	9.40	11.63	14.00
X12	2.95	21-1/4"	20"	2.68	3.70	5.00
X126	3.84	21-1/4"	26"	3.63	4.81	6.25
X13	4.72	21-1/4"	32"	4.59	5.92	7.50
X136	5.61	21-1/4"	38"	5.54	7.03	8.75
X14	6.49	21-1/4"	44"	6.49	8.14	10.00
X146	7.38	21-1/4"	50"	7.45	9.24	11.25
X15	8.26	21-1/4"	56"	8.40	10.35	12.50
X156	9.15	21-1/4"	62"	9.35	11.46	13.75
X16	10.03	21-1/4"	68"	10.31	12.57	15.00
E13	5.72	25-3/4"	32"	5.79	7.25	9.00

NOTE: For the most up-to-date data, please visit www.kolbewindows.com.

Shaded units meet most national building codes for emergency escape and rescue requirements.

Clear Opening Dimensions

Product #	Sq. Ft. Clear Opg.	Clear Opening		Sq. Ft. D.L.O.	Sq. Ft. Vent	Sq. Ft. of Unit Frame Dim.
		Width	Height			
Push-Out Casements (continued)						
E136	6.80	25-3/4"	38"	6.99	8.61	10.50
E14	7.87	25-3/4"	44"	8.20	9.97	12.00
E146	8.94	25-3/4"	50"	9.40	11.33	13.50
E15	10.01	25-3/4"	56"	10.60	12.69	15.00
E156	11.09	25-3/4"	62"	11.81	14.05	16.50
E16	12.16	25-3/4"	68"	13.01	15.41	18.00

Notes for Crank-Out Awning Windows:

- ▶ Awning windows may not be considered emergency escape and rescue windows.
- ▶ Clear opening dimensions determined after unhooking and retracting operator arms and pushing sash open to 90°
- ▶ Clear opening widths shown are for units with friction hinges and no screen.

Product #	Sq. Ft. Clear Opg.	Clear Opg.		Sq. Ft. D.L.O.	Sq. Ft. Vent	Sq. Ft. of Frame Dim.
		Width	Height			
Crank-Out Awnings						
2618	1.94	26-3/16"	10-11/16"	2.24	2.75	4.17
2620	2.67	26-3/16"	14-11/16"	2.89	3.48	5.00
2626	3.76	26-3/16"	20-11/16"	3.88	4.57	6.25
2630	4.85	26-3/16"	26-11/16"	4.86	5.66	7.50
3018	2.39	32-3/16"	10-11/16"	2.80	3.38	5.00
3020	3.28	32-3/16"	14-11/16"	3.63	4.27	6.00
3026	4.62	32-3/16"	20-11/16"	4.86	5.62	7.50
3030	5.97	32-3/16"	26-11/16"	6.09	6.96	9.00
3618	2.83	38-3/16"	10-11/16"	3.37	4.01	5.83
3620	3.89	38-3/16"	14-11/16"	4.36	5.07	7.00
3626	5.49	38-3/16"	20-11/16"	5.84	6.66	8.75
3630	7.08	38-3/16"	26-11/16"	7.33	8.25	10.50
4018	3.28	44-3/16"	10-11/16"	3.94	4.64	6.67
4020	4.51	44-3/16"	14-11/16"	5.09	5.87	8.00
4026	6.35	44-3/16"	20-11/16"	6.83	7.71	10.00
4030	8.19	44-3/16"	26-11/16"	8.56	9.55	12.00
1814	1.15	16-3/16"	10-3/16"	0.91	1.20	2.22
2014	1.43	20-3/16"	10-3/16"	1.18	1.49	2.67
2414	1.71	24-3/16"	10-3/16"	1.45	1.79	3.11
2614	1.85	26-3/16"	10-3/16"	1.58	1.94	3.33
2814	1.99	28-3/16"	10-3/16"	1.71	2.09	3.56
3014	2.28	32-3/16"	10-3/16"	1.98	2.38	4.00
3614	2.70	38-3/16"	10-3/16"	2.38	2.83	4.67
4014	3.13	44-3/16"	10-3/16"	2.78	3.27	5.33
1816	1.37	16-3/16"	12-3/16"	1.10	1.42	2.50
2016	1.71	20-3/16"	12-3/16"	1.42	1.77	3.00
2416	2.05	24-3/16"	12-3/16"	1.75	2.13	3.50
2616	2.22	26-3/16"	12-3/16"	1.91	2.30	3.75

Product #	Sq. Ft. Clear Opg.	Clear Opg.		Sq. Ft. D.L.O.	Sq. Ft. Vent	Sq. Ft. of Frame Dim.
		Width	Height			
Crank-Out Awnings (continued)						
2816	2.39	28-3/16"	12-3/16"	2.07	2.48	4.00
3016	2.72	32-3/16"	12-3/16"	2.39	2.83	4.50
3616	3.23	38-3/16"	12-3/16"	2.88	3.36	5.25
4016	3.74	44-3/16"	12-3/16"	3.36	3.88	6.00
1818	1.59	16-3/16"	14-3/16"	1.29	1.65	2.78
2018	1.99	20-3/16"	14-3/16"	1.67	2.05	3.33
2418	2.38	24-3/16"	14-3/16"	2.05	2.46	3.89
2618	2.58	26-3/16"	14-3/16"	2.24	2.67	4.17
2818	2.78	28-3/16"	14-3/16"	2.42	2.87	4.44
3018	3.17	32-3/16"	14-3/16"	2.80	3.28	5.00
3618	3.76	38-3/16"	14-3/16"	3.37	3.89	5.83
4018	4.35	44-3/16"	14-3/16"	3.94	4.50	6.67
1820	2.04	16-3/16"	18-3/16"	1.67	2.10	3.33
2020	2.55	20-3/16"	18-3/16"	2.16	2.62	4.00
2420	3.05	24-3/16"	18-3/16"	2.65	3.13	4.67
2620	3.31	26-3/16"	18-3/16"	2.89	3.39	5.00
2820	3.56	28-3/16"	18-3/16"	3.14	3.65	5.33
3020	4.07	32-3/16"	18-3/16"	3.63	4.17	6.00
3620	4.82	38-3/16"	18-3/16"	4.36	4.95	7.00
4020	5.58	44-3/16"	18-3/16"	5.09	5.72	8.00
1826	2.72	16-3/16"	24-3/16"	2.24	2.77	4.17
2026	3.39	20-3/16"	24-3/16"	2.89	3.46	5.00
2426	4.06	24-3/16"	24-3/16"	3.55	4.14	5.83
2626	4.40	26-3/16"	24-3/16"	3.88	4.48	6.25
2826	4.73	28-3/16"	24-3/16"	4.20	4.83	6.67
3026	5.41	32-3/16"	24-3/16"	4.86	5.51	7.50
3626	6.41	38-3/16"	24-3/16"	5.84	6.54	8.75
4026	7.42	44-3/16"	24-3/16"	6.83	7.57	10.00
1830	3.39	16-3/16"	30-3/16"	2.80	3.45	5.00
2030	4.23	20-3/16"	30-3/16"	3.63	4.30	6.00
2430	5.07	24-3/16"	30-3/16"	4.45	5.15	7.00
2630	5.49	26-3/16"	30-3/16"	4.86	5.58	7.50
2830	5.91	28-3/16"	30-3/16"	5.27	6.00	8.00
3030	6.75	32-3/16"	30-3/16"	6.09	6.85	9.00
3630	8.01	38-3/16"	30-3/16"	7.33	8.13	10.50
4030	9.26	44-3/16"	30-3/16"	8.56	9.41	12.00
1836	4.07	16-3/16"	36-3/16"	3.37	4.12	5.83
2036	5.07	20-3/16"	36-3/16"	4.36	5.14	7.00
2436	6.08	24-3/16"	36-3/16"	5.35	6.16	8.17
2636	6.58	26-3/16"	36-3/16"	5.84	6.67	8.75
2836	7.08	28-3/16"	36-3/16"	6.34	7.18	9.33
3036	8.09	32-3/16"	36-3/16"	7.33	8.19	10.50
3636	9.60	38-3/16"	36-3/16"	8.81	9.72	12.25
4036	11.10	44-3/16"	36-3/16"	10.30	11.25	14.00
1840	4.74	16-3/16"	42-3/16"	3.94	4.80	6.67
2040	5.91	20-3/16"	42-3/16"	5.09	5.98	8.00

NOTE: For the most up-to-date data, please visit www.kolbewindows.com.

Shaded units meet most national building codes for emergency escape and rescue requirements.

Product #	Sq. Ft. Clear Opg.	Clear Opg.		Sq. Ft. D.L.O.	Sq. Ft. Vent	Sq. Ft. of Frame Dim.
		Width	Height			
Crank-Out Awnings (continued)						
2440	7.09	24-3/16"	42-3/16"	6.25	7.16	9.33
2640	7.67	26-3/16"	42-3/16"	6.83	7.76	10.00
2840	8.26	28-3/16"	42-3/16"	7.41	8.35	10.67
3040	9.43	32-3/16"	42-3/16"	8.56	9.53	12.00
3640	11.19	38-3/16"	42-3/16"	10.30	11.31	14.00
4040	12.95	44-3/16"	42-3/16"	12.03	13.09	16.00

Product #	Sq. Ft. Clear Opg.	Clear Opg.		Sq. Ft. D.L.O.	Sq. Ft. Vent	Sq. Ft. of Frame Dim.
		Width	Height			
Crank-Out XL Awnings						
1836	0.78	15-9/16"	7-1/4"	3.37	3.96	5.83
2036	0.98	19-9/16"	7-1/4"	4.36	4.98	7.00
2436	1.19	23-9/16"	7-1/4"	5.35	6.00	8.17
2636	1.29	25-9/16"	7-1/4"	5.84	6.51	8.75
2836	1.39	27-9/16"	7-1/4"	6.34	7.02	9.33
3036	1.59	31-9/16"	7-1/4"	7.33	8.03	10.50
3636	1.89	37-9/16"	7-1/4"	8.81	9.56	12.25
4036	2.19	43-9/16"	7-1/4"	10.30	11.09	14.00
1840	0.78	15-9/16"	7-1/4"	3.94	4.61	6.67
2040	0.98	19-9/16"	7-1/4"	5.09	5.79	8.00
2440	1.19	23-9/16"	7-1/4"	6.25	6.98	9.33
2640	1.29	25-9/16"	7-1/4"	6.83	7.57	10.00
2840	1.39	27-9/16"	7-1/4"	7.41	8.16	10.67
3040	1.59	31-9/16"	7-1/4"	8.56	9.35	12.00
3640	1.89	37-9/16"	7-1/4"	10.30	11.13	14.00
4040	2.19	43-9/16"	7-1/4"	12.03	12.90	16.00

Notes For Push-Out Awning Windows:

- ▶ Awnings may not be considered emergency escape and rescue windows.
- ▶ Clear opening dimensions determined after unhooking and retracting operator arms and pushing sash open to 90°
- ▶ Clear opening widths shown are for units with friction hinges and no screen.

Product #	Sq. Ft. Clear Opg.	Clear Opg.		Sq. Ft. D.L.O.	Sq. Ft. Vent	Sq. Ft. of Frame Dim.
		Width	Height			
Push-Out Awnings						
2018	1.59	20-5/8"	11-1/8"	1.51	2.29	3.33
2618	2.06	26-5/8"	11-1/8"	2.05	2.96	4.17
2818	2.21	28-5/8"	11-1/8"	2.22	3.18	4.44
3018	2.51	32-5/8"	11-1/8"	2.58	3.63	5.00
3618	2.98	38-5/8"	11-1/8"	3.12	4.29	5.83
4018	3.45	44-5/8"	11-1/8"	3.65	4.96	6.67
2020	2.17	20-5/8"	15-1/8"	1.98	2.86	4.00
2620	2.80	26-5/8"	15-1/8"	2.68	3.70	5.00

Product #	Sq. Ft. Clear Opg.	Clear Opg.		Sq. Ft. D.L.O.	Sq. Ft. Vent	Sq. Ft. of Frame Dim.
		Width	Height			
Push-Out Awnings (continued)						
2820	3.01	28-5/8"	15-1/8"	2.92	3.98	5.33
3020	3.43	32-5/8"	15-1/8"	3.38	4.53	6.00
3620	4.06	38-5/8"	15-1/8"	4.09	5.36	7.00
4020	4.69	44-5/8"	15-1/8"	4.79	6.20	8.00
2026	3.03	20-5/8"	21-1/8"	2.68	3.72	5.00
2626	3.91	26-5/8"	21-1/8"	3.63	4.81	6.25
2826	4.20	28-5/8"	21-1/8"	3.95	5.17	6.67
3026	4.79	32-5/8"	21-1/8"	4.59	5.89	7.50
3626	5.67	38-5/8"	21-1/8"	5.54	6.97	8.75
4026	6.55	44-5/8"	21-1/8"	6.349	8.06	10.00
2030	3.89	20-5/8"	27-1/8"	3.38	4.58	6.00
2630	5.02	26-5/8"	27-1/8"	4.59	5.92	7.25
2830	5.39	28-5/8"	27-1/8"	4.99	6.36	8.00
3030	6.15	32-5/8"	27-1/8"	5.79	7.25	9.00
3630	7.28	38-5/8"	27-1/8"	6.99	8.58	10.50
4030	8.41	44-5/8"	27-1/8"	8.20	9.92	12.00

Notes for Sterling Double Hung Windows:

- ▶ For Sterling high performance units, deduct 2-1/8" from the clear opening heights.
- ▶ There are no standard sizes for XL Sterling double hungs. Contact Kolbe or your dealer for clear opening information.

Product #	Sq. Ft. Clear Opg.	Clear Opg.		Sq. Ft. D.L.O.	Sq. Ft. Vent	Sq. Ft. of Frame Dim.
		Width	Height			
Sterling Double Hungs						
1614	1.54	17-31/32"	12-3/8"	2.71	1.54	5.44
1616	1.79	17-31/32"	14-3/8"	3.13	1.79	6.04
1620	2.29	17-31/32"	18-3/8"	3.96	2.29	7.23
1622	2.54	17-31/32"	20-3/8"	4.38	2.54	7.83
1624	2.79	17-31/32"	22-3/8"	4.79	2.79	8.43
1626	3.04	17-31/32"	24-3/8"	5.21	3.04	9.02
1628	3.29	17-31/32"	26-3/8"	5.63	3.29	9.62
1630	3.54	17-31/32"	28-3/8"	6.04	3.54	10.22
1632	3.79	17-31/32"	30-3/8"	6.46	3.79	10.82
1634	4.04	17-31/32"	32-3/8"	6.88	4.04	11.41
1636	4.29	17-31/32"	34-3/8"	7.29	4.29	12.01
2014	1.89	21-31/32"	12-3/8"	3.43	1.89	6.45
2016	2.19	21-31/32"	14-3/8"	3.96	2.19	7.16
2020	2.80	21-31/32"	18-3/8"	5.01	2.80	8.58
2022	3.11	21-31/32"	20-3/8"	5.54	3.11	9.29
2024	3.41	21-31/32"	22-3/8"	6.07	3.41	9.99
2026	3.72	21-31/32"	24-3/8"	6.60	3.72	10.70
2028	4.02	21-31/32"	26-3/8"	7.13	4.02	11.41
2030	4.33	21-31/32"	28-3/8"	7.65	4.33	12.12
2032	4.63	21-31/32"	30-3/8"	8.18	4.63	12.83
2034	4.94	21-31/32"	32-3/8"	8.71	4.94	13.54

NOTE: For the most up-to-date data, please visit www.kolbewindows.com.

Shaded units meet most national building codes for emergency escape and rescue requirements.

Clear Opening Dimensions

Product #	Sq. Ft. Clear Opg.	Clear Opg.		Sq. Ft. D.L.O.	Sq. Ft. Vent	Sq. Ft. of Frame Dim.
		Width	Height			
Sterling Double Hungs (continued)						
2036	5.24	21-31/32"	34-3/8"	9.24	5.24	14.24
2414	2.23	25-31/32"	12-3/8"	4.15	2.23	2.23
2416	2.59	25-31/32"	14-3/8"	4.79	2.59	8.28
2420	3.31	25-31/32"	18-3/8"	6.07	3.31	9.92
2422	3.67	25-31/32"	20-3/8"	6.71	3.67	10.74
2424	4.04	25-31/32"	22-3/8"	7.35	4.04	11.56
2426	4.40	25-31/32"	24-3/8"	7.99	4.40	12.38
2428	4.76	25-31/32"	26-3/8"	8.63	4.76	13.20
2430	5.12	25-31/32"	28-3/8"	9.26	5.12	14.02
2432	5.48	25-31/32"	30-3/8"	9.90	5.48	14.84
2434	5.84	25-31/32"	32-3/8"	10.54	5.84	15.66
2436	6.20	25-31/32"	34-3/8"	11.18	6.20	16.48
2614	2.40	27-31/32"	12-3/8"	4.51	2.40	7.97
2616	2.79	27-31/32"	14-3/8"	5.21	2.79	8.85
2620	3.57	27-31/32"	18-3/8"	6.60	3.57	10.60
2622	3.96	27-31/32"	20-3/8"	7.29	3.96	11.47
2624	4.35	27-31/32"	22-3/8"	7.99	4.35	12.35
2626	4.73	27-31/32"	24-3/8"	8.68	4.73	13.22
2628	5.12	27-31/32"	26-3/8"	9.38	5.12	14.10
2630	5.51	27-31/32"	28-3/8"	10.07	5.51	14.97
2632	5.90	27-31/32"	30-3/8"	10.76	5.90	15.85
2634	6.29	27-31/32"	32-3/8"	11.46	6.29	16.72
2636	6.68	27-31/32"	34-3/8"	12.15	6.68	17.60
2814	2.58	29-31/32"	12-3/8"	4.88	2.58	8.48
2816	2.99	29-31/32"	14-3/8"	5.63	2.99	9.41
2820	3.82	29-31/32"	18-3/8"	7.13	3.82	11.27
2822	4.24	29-31/32"	20-3/8"	7.88	4.24	12.20
2824	4.66	29-31/32"	22-3/8"	8.63	4.66	13.13
2826	5.07	29-31/32"	24-3/8"	9.38	5.07	14.06
2828	5.49	29-31/32"	26-3/8"	10.13	5.49	14.99
2830	5.91	29-31/32"	28-3/8"	10.88	5.91	15.92
2832	6.32	29-31/32"	30-3/8"	11.63	6.32	16.85
2834	6.74	29-31/32"	32-3/8"	12.38	6.74	17.78
2836	7.15	29-31/32"	34-3/8"	13.13	7.15	18.71
3014	2.75	31-31/32"	12-3/8"	5.24	2.75	8.98
3016	3.19	31-31/32"	14-3/8"	6.04	3.19	9.97
3020	4.08	31-31/32"	18-3/8"	7.65	4.08	11.94
3022	4.52	31-31/32"	20-3/8"	8.46	4.52	12.93
3024	4.97	31-31/32"	22-3/8"	9.26	4.97	13.91
3026	5.41	31-31/32"	24-3/8"	10.07	5.41	14.90
3028	5.86	31-31/32"	26-3/8"	10.88	5.86	15.89
3030	6.30	31-31/32"	28-3/8"	11.68	6.30	16.87
3032	6.74	31-31/32"	30-3/8"	12.49	6.74	17.86
3034	7.19	31-31/32"	32-3/8"	13.29	7.19	18.84
3036	7.63	31-31/32"	34-3/8"	14.10	7.63	19.83

Product #	Sq. Ft. Clear Opg.	Clear Opg.		Sq. Ft. D.L.O.	Sq. Ft. Vent	Sq. Ft. of Frame Dim.
		Width	Height			
Sterling Double Hungs (continued)						
3214	2.92	33-31/32"	12-3/8"	5.60	2.92	9.49
3216	3.39	33-31/32"	14-3/8"	6.46	3.39	10.53
3220	4.33	33-31/32"	18-3/8"	8.18	4.33	12.61
3222	4.81	33-31/32"	20-3/8"	9.04	4.81	13.66
3224	5.28	33-31/32"	22-3/8"	9.90	5.28	14.70
3226	5.75	33-31/32"	24-3/8"	10.76	5.75	15.74
3228	6.22	33-31/32"	26-3/8"	11.63	6.22	16.78
3230	6.69	33-31/32"	28-3/8"	12.49	6.69	17.82
3232	7.17	33-31/32"	30-3/8"	13.35	7.17	18.86
3234	7.64	33-31/32"	32-3/8"	14.21	7.64	19.91
3236	8.11	33-31/32"	34-3/8"	15.07	8.11	20.95
3614	3.26	37-31/32"	12-3/8"	6.32	3.26	10.50
3616	3.79	37-31/32"	14-3/8"	7.29	3.79	11.65
3620	4.84	37-31/32"	18-3/8"	9.24	4.84	13.96
3622	5.37	37-31/32"	20-3/8"	10.21	5.37	15.11
3624	5.90	37-31/32"	22-3/8"	11.18	5.90	16.26
3626	6.43	37-31/32"	24-3/8"	12.15	6.43	17.42
3628	6.95	37-31/32"	26-3/8"	13.13	6.95	18.57
3630	7.48	37-31/32"	28-3/8"	14.10	7.48	19.72
3632	8.01	37-31/32"	30-3/8"	15.07	8.01	20.88
3634	8.54	37-31/32"	32-3/8"	16.04	8.54	22.03
3636	9.06	37-31/32"	34-3/8"	17.01	9.06	23.18
4014	3.61	41-31/32"	12-3/8"	7.04	3.61	11.51
4016	4.19	41-31/32"	14-3/8"	8.13	4.19	12.78
4020	5.36	41-31/32"	18-3/8"	10.29	5.36	15.30
4022	5.94	41-31/32"	20-3/8"	11.38	5.94	16.57
4024	6.52	41-31/32"	22-3/8"	12.46	6.52	17.83
4026	7.10	41-31/32"	24-3/8"	13.54	7.10	19.10
4028	7.69	41-31/32"	26-3/8"	14.63	7.69	20.36
4030	8.27	41-31/32"	28-3/8"	15.71	8.27	21.62
4032	8.85	41-31/32"	30-3/8"	16.79	8.85	22.89
4034	9.44	41-31/32"	32-3/8"	17.88	9.44	24.15
4036	10.02	41-31/32"	34-3/8"	18.96	10.02	25.42
1624/36	2.79	17-31/32"	22-3/8"	6.04	2.79	10.22
2024/36	3.41	21-31/32"	22-3/8"	7.65	3.41	12.12
2424/36	4.04	25-31/32"	22-3/8"	9.26	4.04	14.02
2624/36	4.35	27-31/32"	22-3/8"	10.01	4.35	14.97
2824/36	4.66	29-31/32"	22-3/8"	10.88	4.66	15.92
3024/36	4.97	31-31/32"	22-3/8"	11.68	4.97	16.87
3224/36	5.28	33-31/32"	22-3/8"	12.49	5.28	17.82
3624/36	5.90	37-31/32"	22-3/8"	14.10	5.90	19.72
4024/36	6.52	41-31/32"	22-3/8"	15.71	6.52	21.62

NOTE: For the most up-to-date data, please visit www.kolbewindows.com.
Shaded units meet most national building codes for emergency escape and rescue requirements.

Notes for Majesta Double Hung Windows:

► There are no standard sizes.

to Clear Opg. Width (in.)		to Clear Opg. Height (in.)	
Majesta Double Hungs			
G.S. +	2.3750	G.S. +	-4.4375
F.S. +	-5.0000	F.S. +	-19.5/2

Notes for Traditional Double Hung Windows:

► For Traditional single hungs, deduct 1/4" from the clear opening widths.

Product #	Sq. Ft. Clear Opg.	Clear Opg.		Sq. Ft. D.L.O.	Sq. Ft. Vent	Sq. Ft. of Frame Dim.
		Width	Height			
Traditional Double Hungs						
1614	1.70	18-1/4"	13-7/16"	2.71	1.70	5.44
1616	1.96	18-1/4"	15-7/16"	3.13	1.96	6.04
1620	2.46	18-1/4"	19-7/16"	3.96	2.46	7.23
1622	2.72	18-1/4"	21-7/16"	4.38	2.72	7.83
1624	2.97	18-1/4"	23-7/16"	4.79	2.97	8.43
1626	3.22	18-1/4"	25-7/16"	5.21	3.22	9.02
1628	3.48	18-1/4"	27-7/16"	5.63	3.48	9.62
1630	3.73	18-1/4"	29-7/16"	6.04	3.73	10.22
1632	3.98	18-1/4"	31-7/16"	6.46	3.98	10.82
1634	4.24	18-1/4"	33-7/16"	6.88	4.24	11.41
1636	4.49	18-1/4"	35-7/16"	7.29	4.49	12.01
2014	2.08	22-1/4"	13-7/16"	3.43	2.08	6.45
2016	2.39	22-1/4"	15-7/16"	3.96	2.39	7.16
2020	3.00	22-1/4"	19-7/16"	5.01	3.00	8.58
2022	3.31	22-1/4"	21-7/16"	5.54	3.31	9.29
2024	3.62	22-1/4"	23-7/16"	6.07	3.62	9.99
2026	3.93	22-1/4"	25-7/16"	6.60	3.93	10.70
2028	4.24	22-1/4"	27-7/16"	7.13	4.24	11.41
2030	4.55	22-1/4"	29-7/16"	7.65	4.55	12.12
2032	4.86	22-1/4"	31-7/16"	8.18	4.86	12.83
2034	5.17	22-1/4"	33-7/16"	8.71	5.17	13.54
2036	5.48	22-1/4"	35-7/16"	9.24	5.48	14.24
2414	2.45	26-1/4"	13-7/16"	4.15	2.45	7.46
2416	2.81	26-1/4"	15-7/16"	4.79	2.81	8.28
2420	3.54	26-1/4"	19-7/16"	6.07	3.54	9.92
2422	3.91	26-1/4"	21-7/16"	6.71	3.91	10.74
2424	4.27	26-1/4"	23-7/16"	7.35	4.27	11.56
2426	4.64	26-1/4"	25-7/16"	7.99	4.64	12.38
2428	5.00	26-1/4"	27-7/16"	8.63	5.00	13.20
2430	5.37	26-1/4"	29-7/16"	9.26	5.37	14.02
2432	5.73	26-1/4"	31-7/16"	9.90	5.73	14.84
2434	6.10	26-1/4"	33-7/16"	10.54	6.10	15.66
2436	6.46	26-1/4"	35-7/16"	11.18	6.46	16.48

Product #	Sq. Ft. Clear Opg.	Clear Opg.		Sq. Ft. D.L.O.	Sq. Ft. Vent	Sq. Ft. of Frame Dim.
		Width	Height			
Traditional Double Hungs (continued)						
2614	2.64	28-1/4"	13-7/16"	4.51	2.64	7.97
2616	3.03	28-1/4"	15-7/16"	5.21	3.03	8.85
2620	3.81	28-1/4"	19-7/16"	6.60	3.81	10.60
2622	4.21	28-1/4"	21-7/16"	7.29	4.21	11.47
2624	4.60	28-1/4"	23-7/16"	7.99	4.60	12.35
2626	4.99	28-1/4"	25-7/16"	8.68	4.99	13.22
2628	5.38	28-1/4"	27-7/16"	9.38	5.38	14.10
2630	5.78	28-1/4"	29-7/16"	10.07	5.78	14.97
2632	6.17	28-1/4"	31-7/16"	10.76	6.17	15.85
2634	6.56	28-1/4"	33-7/16"	11.46	6.56	16.72
2816	3.24	30-1/4"	15-7/16"	5.63	3.24	9.41
2820	4.08	30-1/4"	19-7/16"	7.13	4.08	11.27
2822	4.50	30-1/4"	21-7/16"	7.88	4.50	12.20
2824	4.92	30-1/4"	23-7/16"	8.63	4.92	13.13
2826	5.34	30-1/4"	25-7/16"	9.38	5.34	14.06
2828	5.76	30-1/4"	27-7/16"	10.13	5.76	14.99
2830	6.18	30-1/4"	29-7/16"	10.88	6.18	15.92
2832	6.60	30-1/4"	31-7/16"	11.63	6.60	16.85
2834	7.02	30-1/4"	33-7/16"	12.38	7.02	17.78
2836	7.44	30-1/4"	35-7/16"	13.13	7.44	18.71
3014	3.01	32-1/4"	13-7/16"	5.24	3.01	8.98
3016	3.46	32-1/4"	15-7/16"	6.04	3.46	9.97
3020	4.35	32-1/4"	19-7/16"	7.65	4.35	11.94
3022	4.80	32-1/4"	21-7/16"	8.46	4.80	12.93
3024	5.25	32-1/4"	23-7/16"	9.26	5.25	13.91
3026	5.70	32-1/4"	25-7/16"	10.07	5.70	14.90
3028	6.14	32-1/4"	27-7/16"	10.88	6.14	15.89
3030	6.59	32-1/4"	29-7/16"	11.68	6.59	16.87
3032	7.04	32-1/4"	31-7/16"	12.49	7.04	17.86
3034	7.49	32-1/4"	33-7/16"	13.29	7.49	18.84
3036	7.94	32-1/4"	35-7/16"	14.10	7.94	19.83
3214	3.20	34-1/4"	13-7/16"	5.60	3.20	9.49
3216	3.67	34-1/4"	15-7/16"	6.46	3.67	10.53
3220	4.62	34-1/4"	19-7/16"	8.18	4.62	12.61
3222	5.10	34-1/4"	21-7/16"	9.04	5.10	13.66
3224	5.57	34-1/4"	23-7/16"	9.90	5.57	14.70
3226	6.05	34-1/4"	25-7/16"	10.76	6.05	15.74
3228	6.53	34-1/4"	27-7/16"	11.63	6.53	16.78
3230	7.00	34-1/4"	29-7/16"	12.49	7.00	17.82
3232	7.48	34-1/4"	31-7/16"	13.35	7.48	18.86
3234	7.95	34-1/4"	33-7/16"	14.21	7.95	19.91
3236	8.43	34-1/4"	35-7/16"	15.07	8.43	20.95
3614	3.57	38-1/4"	13-7/16"	6.32	3.57	10.50
3616	4.10	38-1/4"	15-7/16"	7.29	4.10	11.65
3620	5.16	38-1/4"	19-7/16"	9.24	5.16	13.96

NOTE: For the most up-to-date data, please visit www.kolbewindows.com.
Shaded units meet most national building codes for emergency escape and rescue requirements.

Clear Opening Dimensions

Product #	Sq. Ft. Clear Opg.	Clear Opg.		Sq. Ft. D.L.O.	Sq. Ft. Vent	Sq. Ft. of Frame Dim.
		Width	Height			
Traditional Double Hungs (continued)						
3622	5.69	38-1/4"	21-7/16"	10.21	5.69	15.11
3624	6.23	38-1/4"	23-7/16"	11.18	6.23	16.26
3626	6.76	38-1/4"	25-7/16"	12.15	6.76	17.42
3628	7.29	38-1/4"	27-7/16"	13.13	7.29	18.57
3630	7.82	38-1/4"	29-7/16"	14.10	7.82	19.72
3632	8.35	38-1/4"	31-7/16"	15.07	8.35	20.88
3634	8.88	38-1/4"	33-7/16"	16.04	8.88	22.03
3636	9.41	38-1/4"	35-7/16"	17.01	9.41	23.18
4014	3.94	42-1/4"	13-7/16"	7.04	3.94	11.51
4016	4.53	42-1/4"	15-7/16"	8.13	4.53	12.78
4020	5.70	42-1/4"	19-7/16"	10.29	5.70	15.30
4022	6.29	42-1/4"	21-7/16"	11.38	6.29	16.57
4024	6.88	42-1/4"	23-7/16"	12.46	6.88	17.83
4026	7.46	42-1/4"	25-7/16"	13.54	7.46	19.10
4028	8.05	42-1/4"	27-7/16"	14.63	8.05	20.36
4030	8.64	42-1/4"	29-7/16"	15.71	8.64	21.62
4032	9.22	42-1/4"	31-7/16"	16.79	9.22	22.89
4034	9.81	42-1/4"	33-7/16"	17.88	9.81	24.15
4036	10.40	42-1/4"	35-7/16"	18.96	10.40	25.42
1624/36	2.97	18-1/4"	23-7/16"	6.04	2.97	10.22
2024/36	3.62	22-1/4"	23-7/16"	7.65	3.62	12.12
2424/36	4.27	26-1/4"	23-7/16"	9.26	4.27	14.02
2624/36	4.60	28-1/4"	23-7/16"	10.07	4.60	14.97
2824/36	4.92	30-1/4"	23-7/16"	10.88	4.92	15.92
3024/36	5.25	32-1/4"	23-7/16"	11.68	5.25	16.87
3224/36	5.57	34-1/4"	23-7/16"	12.49	5.57	17.82
3624/36	6.23	38-1/4"	23-7/16"	14.10	6.23	19.72
4024/36	6.88	42-1/4"	23-7/16"	15.71	6.88	21.62

Notes for Folding Windows:

- ▶ There are no standard sizes. Contact Kolbe or your dealer for clear opening information.

Product #	Sq. Ft. Clear Opg.	Clear Opg.		Sq. Ft. D.L.O.	Sq. Ft. Vent	Sq. Ft. of Frame Dim.
		Width	Height			
Single & Double Sliding Windows						
2020	1.21	8-53/64"	19-11/16"	1.71	1.21	3.82
2026	1.57	8-53/64"	25-11/16"	2.36	1.57	4.80
2030	1.94	8-53/64"	31-11/16"	3.01	1.94	5.78
2036	2.31	8-53/64"	37-11/16"	3.66	2.31	6.76
2040	2.68	8-53/64"	43-11/16"	4.31	2.68	7.74
2046	3.05	8-53/64"	49-11/16"	4.96	3.05	8.72
2050	3.41	8-53/64"	55-11/16"	5.62	3.41	9.70

Product #	Sq. Ft. Clear Opg.	Clear Opg.		Sq. Ft. D.L.O.	Sq. Ft. Vent	Sq. Ft. of Frame Dim.
		Width	Height			
Single & Double Sliding Windows (continued)						
2056	3.78	8-53/64"	61-11/16"	6.27	3.78	10.68
2060	4.15	8-53/64"	67-11/16"	6.92	4.15	11.66
3020	2.03	14-53/64"	19-11/16"	3.02	2.03	5.78
3026	2.65	14-53/64"	25-11/16"	4.17	2.65	7.26
3030	3.26	14-53/64"	31-11/16"	5.32	3.26	8.74
3036	3.88	14-53/64"	37-11/16"	6.47	3.88	10.22
3040	4.50	14-53/64"	43-11/16"	7.63	4.50	11.69
3046	5.12	14-53/64"	49-11/16"	8.78	5.12	13.17
3050	5.73	14-53/64"	55-11/16"	9.93	5.73	14.65
3056	6.35	14-53/64"	61-11/16"	11.08	6.35	16.13
3060	6.97	14-53/64"	67-11/16"	12.23	6.97	17.61
4020	2.85	20-53/64"	19-11/16"	4.33	2.85	7.73
4026	3.72	20-53/64"	25-11/16"	5.99	3.72	9.71
4030	4.58	20-53/64"	31-11/16"	7.64	4.58	11.69
4036	5.45	20-53/64"	37-11/16"	9.29	5.45	13.67
4040	6.32	20-53/64"	43-11/16"	10.94	6.32	15.65
4046	7.19	20-53/64"	49-11/16"	12.59	7.19	17.63
4050	8.05	20-53/64"	55-11/16"	14.24	8.05	19.61
4056	8.92	20-53/64"	61-11/16"	15.89	8.92	21.59
4060	9.79	20-53/64"	67-11/16"	17.54	9.79	23.56
5020	3.67	26-53/64"	19-11/16"	5.65	3.67	9.68
5026	4.79	26-53/64"	25-11/16"	7.80	4.79	12.16
5030	5.90	26-53/64"	31-11/16"	9.95	5.90	14.64
5036	7.02	26-53/64"	37-11/16"	12.10	7.02	17.12
5040	8.14	26-53/64"	43-11/16"	14.25	8.14	19.60
5046	9.26	26-53/64"	49-11/16"	16.40	9.26	22.08
5050	10.37	26-53/64"	55-11/16"	18.55	10.37	24.56
5056	11.49	26-53/64"	61-11/16"	20.70	11.49	27.04
5060	12.61	26-53/64"	67-11/16"	22.85	12.61	29.52
6020	4.49	32-53/64"	19-11/16"	6.96	4.49	11.64
6026	5.86	32-53/64"	25-11/16"	9.61	5.86	14.62
6030	7.22	32-53/64"	31-11/16"	12.26	7.22	17.60
6036	8.59	32-53/64"	37-11/16"	14.91	8.59	20.57
6040	9.96	32-53/64"	43-11/16"	17.56	9.96	23.55
6046	11.33	32-53/64"	49-11/16"	20.21	11.33	26.53
6050	12.70	32-53/64"	55-11/16"	22.87	12.70	29.51
6056	14.06	32-53/64"	61-11/16"	25.52	14.06	32.49
6060	15.43	32-53/64"	67-11/16"	28.17	15.43	35.47
7020	5.31	38-53/64"	19-11/16"	8.27	5.31	13.59
7026	6.93	38-53/64"	25-11/16"	11.42	6.93	17.07
7030	8.54	38-53/64"	31-11/16"	14.57	8.54	20.55
7036	10.16	38-53/64"	37-11/16"	17.72	10.16	24.03
7040	11.78	38-53/64"	43-11/16"	20.88	11.78	27.51
7046	13.40	38-53/64"	49-11/16"	24.03	13.40	30.99
7050	15.02	38-53/64"	55-11/16"	27.18	15.02	34.47

NOTE: For the most up-to-date data, please visit www.kolbewindows.com.

Shaded units meet most national building codes for emergency escape and rescue requirements.

Product #	Sq. Ft. Clear Opg.	Clear Opg.		Sq. Ft. D.L.O.	Sq. Ft. Vent	Sq. Ft. of Frame Dim.
		Width	Height			
Single & Double Sliding Windows (continued)						
7056	16.63	38-53/64"	61-11/16"	30.33	16.63	37.94
7060	18.25	38-53/64"	67-11/16"	33.48	18.25	41.42
8020	6.13	44-53/64"	19-11/16"	9.58	6.13	15.54
8026	8.00	44-53/64"	25-11/16"	13.24	8.00	19.52
8030	9.86	44-53/64"	31-11/16"	16.89	9.86	23.50
8036	11.73	44-53/64"	37-11/16"	20.54	11.73	27.48
8040	13.60	44-53/64"	43-11/16"	24.19	13.60	31.46
8046	15.47	44-53/64"	49-11/16"	27.84	15.47	35.44
8050	17.34	44-53/64"	55-11/16"	31.49	17.34	39.42
8056	19.20	44-53/64"	61-11/16"	35.14	19.20	43.40
8060	21.07	44-53/64"	67-11/16"	38.79	21.07	47.38

Product #	Sq. Ft. Clear Opg.	Clear Opg.		Sq. Ft. D.L.O.	Sq. Ft. Vent 1	Sq. Ft. Vent 2	Sq. Ft. of Frame Dim.
		Width	Height				
Triple Sliding Windows							
4020	1.30	9-31/64"	19-11/16"	4.07	1.30	2.59	7.73
4026	1.69	9-31/64"	25-11/16"	5.62	1.69	3.38	9.71
4030	2.09	9-31/64"	31-11/16"	7.17	2.09	4.17	11.69
4036	2.48	9-31/64"	37-11/16"	8.72	2.48	4.96	13.67
4040	2.88	9-31/64"	43-11/16"	10.27	2.88	5.75	15.65
4046	3.27	9-31/64"	49-11/16"	11.81	3.27	6.55	17.63
4050	3.67	9-31/64"	55-11/16"	13.36	3.67	7.34	19.61
4056	4.06	9-31/64"	61-11/16"	14.91	4.06	8.13	21.59
4060	4.46	9-31/64"	67-11/16"	16.46	4.46	8.92	23.56
5020	1.71	12-31/64"	19-11/16"	5.38	1.71	3.41	9.68
5026	2.23	12-31/64"	25-11/16"	7.43	2.23	4.45	12.16
5030	2.75	12-31/64"	31-11/16"	9.48	2.75	5.49	14.64
5036	3.27	12-31/64"	37-11/16"	11.53	3.27	6.53	17.12
5040	3.79	12-31/64"	43-11/16"	13.58	3.79	7.58	19.60
5046	4.31	12-31/64"	49-11/16"	15.63	4.31	8.62	22.08
5050	4.83	12-31/64"	55-11/16"	17.68	4.83	9.66	24.56
5056	5.35	12-31/64"	61-11/16"	19.73	5.35	10.70	27.04
5060	5.87	12-31/64"	67-11/16"	21.78	5.87	11.74	29.52
6020	2.12	15-31/64"	19-11/16"	6.69	2.12	4.23	11.64
6026	2.76	15-31/64"	25-11/16"	9.24	2.76	5.52	14.62
6030	3.41	15-31/64"	31-11/16"	11.79	3.41	6.81	17.60
6036	4.05	15-31/64"	37-11/16"	14.34	4.05	8.11	20.57
6040	4.70	15-31/64"	43-11/16"	16.89	4.70	9.40	23.55
6046	5.34	15-31/64"	49-11/16"	19.44	5.34	10.69	26.53
6050	5.99	15-31/64"	55-11/16"	21.99	5.99	11.98	29.51
6056	6.63	15-31/64"	61-11/16"	24.54	6.63	13.27	32.49
6060	7.28	15-31/64"	67-11/16"	27.09	7.28	14.56	35.47
7020	2.53	18-31/64"	19-11/16"	8.00	2.53	5.05	13.59
7026	3.30	18-31/64"	25-11/16"	11.05	3.30	6.59	17.07

Product #	Sq. Ft. Clear Opg.	Clear Opg.		Sq. Ft. D.L.O.	Sq. Ft. Vent 1	Sq. Ft. Vent 2	Sq. Ft. of Frame Dim.
		Width	Height				
Triple Sliding Windows (continued)							
7030	4.07	18-31/64"	31-11/16"	14.10	4.07	8.14	20.55
7036	4.84	18-31/64"	37-11/16"	17.15	4.84	9.68	24.03
7040	5.61	18-31/64"	43-11/16"	20.20	5.61	11.22	27.51
7046	6.38	18-31/64"	49-11/16"	23.25	6.38	12.76	30.99
7050	7.15	18-31/64"	55-11/16"	26.30	7.15	14.30	34.47
7056	7.92	18-31/64"	61-11/16"	29.35	7.92	15.84	37.94
7060	8.69	18-31/64"	67-11/16"	32.40	8.69	17.38	41.42
8020	2.94	21-31/64"	19-11/16"	9.32	2.94	5.87	15.54
8026	3.83	21-31/64"	25-11/16"	12.87	3.83	7.66	19.52
8030	4.73	21-31/64"	31-11/16"	16.42	4.73	9.46	23.50
8036	5.62	21-31/64"	37-11/16"	19.97	5.62	11.25	27.48
8040	6.52	21-31/64"	43-11/16"	23.52	6.52	13.04	31.46
8046	7.41	21-31/64"	49-11/16"	27.06	7.41	14.83	35.44
8050	8.31	21-31/64"	55-11/16"	30.61	8.31	16.62	39.42
8056	9.20	21-31/64"	61-11/16"	34.16	9.20	18.41	43.40
8060	10.10	21-31/64"	67-11/16"	37.71	10.10	20.20	47.38
9020	3.35	24-31/64"	19-11/16"	10.63	3.35	6.69	17.50
9026	4.37	24-31/64"	25-11/16"	14.68	4.37	8.74	21.98
9030	5.39	24-31/64"	31-11/16"	18.73	5.39	10.78	26.46
9036	6.41	24-31/64"	37-11/16"	22.78	6.41	12.82	30.93
9040	7.43	24-31/64"	43-11/16"	26.83	7.43	14.86	35.41
9046	8.45	24-31/64"	49-11/16"	30.88	8.45	16.90	39.89
9050	9.47	24-31/64"	55-11/16"	34.93	9.47	18.94	44.37
9056	10.49	24-31/64"	61-11/16"	38.98	10.49	20.98	48.85
9060	11.51	24-31/64"	67-11/16"	43.03	11.51	23.02	53.33
10020	3.76	27-31/64"	19-11/16"	11.94	3.76	7.52	19.45
10026	4.90	27-31/64"	25-11/16"	16.49	4.90	9.81	24.43
10030	6.05	27-31/64"	31-11/16"	21.04	6.05	12.10	29.41
10036	7.19	27-31/64"	37-11/16"	25.59	7.19	14.39	34.39
10040	8.34	27-31/64"	43-11/16"	30.14	8.34	16.68	39.37
10046	9.48	27-31/64"	49-11/16"	34.69	9.48	18.97	44.35
10050	10.63	27-31/64"	55-11/16"	39.24	10.63	21.26	49.32
10056	11.77	27-31/64"	61-11/16"	43.79	11.77	23.55	54.30
10060	12.92	27-31/64"	67-11/16"	48.34	12.92	25.84	59.28

NOTE: For the most up-to-date data, please visit www.kolbewindows.com.
 Shaded units meet most national building codes for emergency escape and rescue requirements.

Clear Opening Dimensions

Product #	Sq. Ft. Clear Opg.	Clear Opg.		Sq. Ft. D.L.O.	Sq. Ft. Vent 1	Sq. Ft. Vent 2	Sq. Ft. of Frame Dim.
		Width	Height				
Quad Sliding Windows: Active-Fixed-Fixed-Active							
6020	2.12	15-31/64"	19-11/16"	6.26	2.12	4.23	11.64
6026	2.76	15-31/64"	25-11/16"	8.65	2.76	5.52	14.62
6030	3.41	15-31/64"	31-11/16"	11.03	3.41	6.81	17.60
6036	4.05	15-31/64"	37-11/16"	13.42	4.05	8.11	20.57
6040	4.70	15-31/64"	43-11/16"	15.80	4.70	9.40	23.55
6046	5.34	15-31/64"	49-11/16"	18.19	5.34	10.69	26.53
6050	5.99	15-31/64"	55-11/16"	20.57	5.99	11.98	29.51
6056	6.63	15-31/64"	61-11/16"	22.96	6.63	13.27	32.49
6060	7.28	15-31/64"	67-11/16"	25.35	7.28	14.56	35.47
7020	2.53	18-31/64"	19-11/16"	7.57	2.53	5.05	13.59
7026	3.30	18-31/64"	25-11/16"	10.46	3.30	6.59	17.07
7030	4.07	18-31/64"	31-11/16"	13.35	4.07	8.14	20.55
7036	4.84	18-31/64"	37-11/16"	16.23	4.84	9.68	24.03
7040	5.61	18-31/64"	43-11/16"	19.12	5.61	11.22	27.51
7046	6.38	18-31/64"	49-11/16"	22.00	6.38	12.76	30.99
7050	7.15	18-31/64"	55-11/16"	24.89	7.15	14.30	34.47
7056	7.92	18-31/64"	61-11/16"	27.77	7.92	15.84	37.94
7060	8.69	18-31/64"	67-11/16"	30.66	8.69	17.38	41.42
8020	2.94	21-31/64"	19-11/16"	8.89	2.94	5.87	15.54
8026	3.83	21-31/64"	25-11/16"	12.27	3.83	7.66	19.52
8030	4.73	21-31/64"	31-11/16"	15.66	4.73	9.46	23.50
8036	5.62	21-31/64"	37-11/16"	19.04	5.62	11.25	27.48
8040	6.52	21-31/64"	43-11/16"	22.43	6.52	13.04	31.46
8046	7.41	21-31/64"	49-11/16"	25.81	7.41	14.83	35.44
8050	8.31	21-31/64"	55-11/16"	29.20	8.31	16.62	39.42
8056	9.20	21-31/64"	61-11/16"	32.58	9.20	18.41	43.40
8060	10.10	21-31/64"	67-11/16"	35.97	10.10	20.20	47.38
9020	3.35	24-31/64"	19-11/16"	10.20	3.35	6.69	17.50
9026	4.37	24-31/64"	25-11/16"	14.08	4.37	8.74	21.98
9030	5.39	24-31/64"	31-11/16"	17.97	5.39	10.78	26.46
9036	6.41	24-31/64"	37-11/16"	21.86	6.41	12.82	30.93
9040	7.43	24-31/64"	43-11/16"	25.74	7.43	14.86	35.41
9046	8.45	24-31/64"	49-11/16"	29.63	8.45	16.90	39.89
9050	9.47	24-31/64"	55-11/16"	33.51	9.47	18.94	44.37
9056	10.49	24-31/64"	61-11/16"	37.40	10.49	20.98	48.85
9060	11.51	24-31/64"	67-11/16"	41.28	11.51	23.02	53.33
10020	3.76	27-31/64"	19-11/16"	11.51	3.76	7.52	19.45
10026	4.90	27-31/64"	25-11/16"	15.90	4.90	9.81	24.43
10030	6.05	27-31/64"	31-11/16"	20.28	6.05	12.10	29.41
10036	7.19	27-31/64"	37-11/16"	24.67	7.19	14.39	34.39
10040	8.34	27-31/64"	43-11/16"	29.05	8.34	16.68	39.37
10046	9.48	27-31/64"	49-11/16"	33.44	9.48	18.97	44.35
10050	10.63	27-31/64"	55-11/16"	37.82	10.63	21.26	49.32
10056	11.77	27-31/64"	61-11/16"	42.21	11.77	23.55	54.30
10060	12.92	27-31/64"	67-11/16"	46.60	12.92	25.84	59.28

Product #	Sq. Ft. Clear Opg.	Clear Opg.		Sq. Ft. D.L.O.	Sq. Ft. Vent 1	Sq. Ft. Vent 2	Sq. Ft. of Frame Dim.
		Width	Height				
Quad Sliding Windows: Active-Fixed-Fixed-Active (continued)							
11020	4.17	30-31/64"	19-11/16"	12.82	4.17	8.34	21.40
11026	5.44	30-31/64"	25-11/16"	17.71	5.44	10.88	26.88
11030	6.71	30-31/64"	31-11/16"	22.60	6.71	13.42	32.36
11036	7.98	30-31/64"	37-11/16"	27.48	7.98	15.96	37.84
11040	9.25	30-31/64"	43-11/16"	32.37	9.25	18.50	43.32
11046	10.52	30-31/64"	49-11/16"	37.25	10.52	21.04	48.80
11050	11.79	30-31/64"	55-11/16"	42.14	11.79	23.58	54.28
11056	13.06	30-31/64"	61-11/16"	47.02	13.06	26.12	59.76
11060	14.33	30-31/64"	67-11/16"	51.91	14.33	28.66	65.24
12020	4.58	33-31/64"	19-11/16"	14.14	4.58	9.16	23.36
12026	5.97	33-31/64"	25-11/16"	19.52	5.97	11.95	29.34
12030	7.37	33-31/64"	31-11/16"	24.91	7.37	14.74	35.31
12036	8.76	33-31/64"	37-11/16"	30.29	8.76	17.53	41.29
12040	10.16	33-31/64"	43-11/16"	35.68	10.16	20.32	47.27
12046	11.55	33-31/64"	49-11/16"	41.06	11.55	23.11	53.25
12050	12.95	33-31/64"	55-11/16"	46.45	12.95	25.90	59.23
12056	14.34	33-31/64"	61-11/16"	51.83	14.34	28.69	65.21
12060	15.74	33-31/64"	67-11/16"	57.22	15.74	31.48	71.19
13020	4.99	36-31/64"	19-11/16"	15.45	4.99	9.98	25.31
13026	6.51	36-31/64"	25-11/16"	21.33	6.51	13.02	31.79
13030	8.03	36-31/64"	31-11/16"	27.22	8.03	16.06	38.27
13036	9.55	36-31/64"	37-11/16"	33.11	9.55	19.10	44.75
13040	11.07	36-31/64"	43-11/16"	38.99	11.07	22.14	51.23
13046	12.59	36-31/64"	49-11/16"	44.88	12.59	25.18	57.71
13050	14.11	36-31/64"	55-11/16"	50.76	14.11	28.22	64.18
13056	15.63	36-31/64"	61-11/16"	56.65	15.63	31.26	70.66
13060	17.15	36-31/64"	67-11/16"	62.53	17.15	34.30	77.14
14020	5.40	39-31/64"	19-11/16"	16.76	5.40	10.80	27.26
14026	7.04	39-31/64"	25-11/16"	23.15	7.04	14.09	34.24
14030	8.69	39-31/64"	31-11/16"	29.53	8.69	17.38	41.22
14036	10.33	39-31/64"	37-11/16"	35.92	10.33	20.67	48.20
14040	11.98	39-31/64"	43-11/16"	42.30	11.98	23.96	55.18
14046	13.62	39-31/64"	49-11/16"	48.69	13.62	27.25	62.16
14050	15.27	39-31/64"	55-11/16"	55.07	15.27	30.54	69.14
14056	16.91	39-31/64"	61-11/16"	61.46	16.91	33.83	76.12
14060	18.56	39-31/64"	67-11/16"	67.85	18.56	37.12	83.10

NOTE: For the most up-to-date data, please visit www.kolbewindows.com.
 Shaded units meet most national building codes for emergency escape and rescue requirements.

Product #	Sq. Ft. Clear Opg.	Clear Opg.		Sq. Ft. D.L.O.	Sq. Ft. Vent 1	Sq. Ft. Vent 2	Sq. Ft. of Frame Dim.
		Width	Height				
Quad Sliding Windows: Fixed-Active-Active-Fixed							
6020	2.16	15-25/32"	19-11/16"	6.26	2.16	4.32	11.64
6026	2.82	15-25/32"	25-11/16"	8.65	2.82	5.63	14.62
6030	3.47	15-25/32"	31-11/16"	11.03	3.47	6.95	17.60
6036	4.13	15-25/32"	37-11/16"	13.42	4.13	8.26	20.57
6040	4.79	15-25/32"	43-11/16"	15.80	4.79	9.58	23.55
6046	5.45	15-25/32"	49-11/16"	18.19	5.45	10.89	26.53
6050	6.10	15-25/32"	55-11/16"	20.57	6.10	12.21	29.51
6056	6.76	15-25/32"	61-11/16"	22.96	6.76	13.52	32.49
6060	7.42	15-25/32"	67-11/16"	25.35	7.42	14.84	35.47
7020	2.57	18-25/32"	19-11/16"	7.57	2.57	5.14	13.59
7026	3.35	18-25/32"	25-11/16"	10.46	3.35	6.70	17.07
7030	4.13	18-25/32"	31-11/16"	13.35	4.13	8.27	20.55
7036	4.92	18-25/32"	37-11/16"	16.23	4.92	9.83	24.03
7040	5.70	18-25/32"	43-11/16"	19.12	5.70	11.40	27.51
7046	6.48	18-25/32"	49-11/16"	22.00	6.48	12.96	30.99
7050	7.26	18-25/32"	55-11/16"	24.89	7.26	14.53	34.47
7056	8.05	18-25/32"	61-11/16"	27.77	8.05	16.09	37.94
7060	8.83	18-25/32"	67-11/16"	30.66	8.83	17.66	41.42
8020	2.98	21-25/32"	19-11/16"	8.89	2.98	5.96	15.54
8026	3.89	21-25/32"	25-11/16"	12.27	3.89	7.77	19.52
8030	4.79	21-25/32"	31-11/16"	15.66	4.79	9.59	23.50
8036	5.70	21-25/32"	37-11/16"	19.04	5.70	11.40	27.48
8040	6.61	21-25/32"	43-11/16"	22.43	6.61	13.22	31.46
8046	7.52	21-25/32"	49-11/16"	25.81	7.52	15.03	35.44
8050	8.42	21-25/32"	55-11/16"	29.20	8.42	16.85	39.42
8056	9.33	21-25/32"	61-11/16"	32.58	9.33	18.66	43.40
8060	10.24	21-25/32"	67-11/16"	35.97	10.24	20.48	47.38
9020	3.39	24-25/32"	19-11/16"	10.20	3.39	6.78	17.50
9026	4.42	24-25/32"	25-11/16"	14.08	4.42	8.84	21.98
9030	5.45	24-25/32"	31-11/16"	17.97	5.45	10.91	26.46
9036	6.49	24-25/32"	37-11/16"	21.86	6.49	12.97	30.93
9040	7.52	24-25/32"	43-11/16"	25.74	7.52	15.04	35.41
9046	8.55	24-25/32"	49-11/16"	29.63	8.55	17.10	39.89
9050	9.58	24-25/32"	55-11/16"	33.51	9.58	19.17	44.37
9056	10.62	24-25/32"	61-11/16"	37.40	10.62	21.23	48.85
9060	11.65	24-25/32"	67-11/16"	41.28	11.65	23.30	53.33
10020	3.80	27-25/32"	19-11/16"	11.51	3.80	7.60	19.45
10026	4.96	27-25/32"	25-11/16"	15.90	4.96	9.91	24.43
10030	6.11	27-25/32"	31-11/16"	20.28	6.11	12.23	29.41
10036	7.27	27-25/32"	37-11/16"	24.67	7.27	14.54	34.39
10040	8.43	27-25/32"	43-11/16"	29.05	8.43	16.86	39.37
10046	9.59	27-25/32"	49-11/16"	33.44	9.59	19.17	44.35
10050	10.74	27-25/32"	55-11/16"	37.82	10.74	21.49	49.32
10056	11.90	27-25/32"	61-11/16"	42.21	11.90	23.80	54.30
10060	13.06	27-25/32"	67-11/16"	46.60	13.06	26.12	59.28

Product #	Sq. Ft. Clear Opg.	Clear Opg.		Sq. Ft. D.L.O.	Sq. Ft. Vent 1	Sq. Ft. Vent 2	Sq. Ft. of Frame Dim.
		Width	Height				
Quad Sliding Windows: Fixed-Active-Active-Fixed (continued)							
11020	4.21	30-25/32"	19-11/16"	12.82	4.21	8.42	21.40
11026	5.49	30-25/32"	25-11/16"	17.71	5.49	10.98	26.88
11030	6.77	30-25/32"	31-11/16"	22.60	6.77	13.55	32.36
11036	8.06	30-25/32"	37-11/16"	27.48	8.06	16.11	37.84
11040	9.34	30-25/32"	43-11/16"	32.37	9.34	18.68	43.32
11046	10.62	30-25/32"	49-11/16"	37.25	10.62	21.24	48.80
11050	11.90	30-25/32"	55-11/16"	42.14	11.90	23.81	54.28
11056	13.19	30-25/32"	61-11/16"	47.02	13.19	26.37	59.76
11060	14.47	30-25/32"	67-11/16"	51.91	14.47	28.94	65.24
12020	4.62	33-25/32"	19-11/16"	14.14	4.62	9.24	23.36
12026	6.03	33-25/32"	25-11/16"	19.52	6.03	12.05	29.34
12030	7.43	33-25/32"	31-11/16"	24.91	7.43	14.87	35.31
12036	8.84	33-25/32"	37-11/16"	30.29	8.84	17.68	41.29
12040	10.25	33-25/32"	43-11/16"	35.68	10.25	20.50	47.27
12046	11.66	33-25/32"	49-11/16"	41.06	11.66	23.31	53.25
12050	13.06	33-25/32"	55-11/16"	46.45	13.06	26.13	59.23
12056	14.47	33-25/32"	61-11/16"	51.83	14.47	28.94	65.21
12060	15.88	33-25/32"	67-11/16"	57.22	15.88	31.76	71.19
13020	5.03	36-25/32"	19-11/16"	15.45	5.03	10.06	25.31
13026	6.56	36-25/32"	25-11/16"	21.33	6.56	13.12	31.79
13030	8.09	36-25/32"	31-11/16"	27.22	8.09	16.19	38.27
13036	9.63	36-25/32"	37-11/16"	33.11	9.63	19.25	44.75
13040	11.16	36-25/32"	43-11/16"	38.99	11.16	22.32	51.23
13046	12.69	36-25/32"	49-11/16"	44.88	12.69	25.38	57.71
13050	14.22	36-25/32"	55-11/16"	50.76	14.22	28.45	64.18
13056	15.76	36-25/32"	61-11/16"	56.65	15.76	31.51	70.66
13060	17.29	36-25/32"	67-11/16"	62.53	17.29	34.58	77.14
14020	5.44	39-25/32"	19-11/16"	16.76	5.44	10.88	27.26
14026	7.10	39-25/32"	25-11/16"	23.15	7.10	14.19	34.24
14030	8.75	39-25/32"	31-11/16"	29.53	8.75	17.51	41.22
14036	10.41	39-25/32"	37-11/16"	35.92	10.41	20.82	48.20
14040	12.07	39-25/32"	43-11/16"	42.30	12.07	24.14	55.18
14046	13.73	39-25/32"	49-11/16"	48.69	13.73	27.45	62.16
14050	15.38	39-25/32"	55-11/16"	55.07	15.38	30.77	69.14
14056	17.04	39-25/32"	61-11/16"	61.46	17.04	34.08	76.12
14060	18.70	39-25/32"	67-11/16"	67.85	18.70	37.40	83.10

NOTE: For the most up-to-date data, please visit www.kolbewindows.com.
Shaded units meet most national building codes for emergency escape and rescue requirements.

Clear Opening Dimensions

Notes for Inswing Entrance Doors:

- ▶ For units with ADA-compliant sills, add 5/8" to the clear opening heights.
- ▶ One or both panels open to 90°

Product #	Sq. Ft. Clear Opg.		Clear Opg. Width		Clear Opg. Ht.	Sq. Ft. D.L.O.	Sq. Ft. Vent	Sq. Ft. of Unit Frame Dim.
	1 Open	2 Open	1 Open	2 Open				
Inswing Entrance Doors, 1-Wide								
2068	11.67	-	21-1/8"	-	79-9/16"	6.93	12.71	14.72
2668	14.99	-	27-1/8"	-	79-9/16"	9.76	16.02	18.17
2868	16.09	-	29-1/8"	-	79-9/16"	10.70	17.13	19.32
3068	18.30	-	33-1/8"	-	79-9/16"	12.59	19.34	21.61
2070	12.26	-	21-1/8"	-	83-9/16"	7.33	13.35	15.43
2670	15.74	-	27-1/8"	-	83-9/16"	10.33	16.83	19.05
2870	16.90	-	29-1/8"	-	83-9/16"	11.33	17.99	20.25
3070	19.22	-	33-1/8"	-	83-9/16"	13.33	20.31	22.66
2080	14.02	-	21-1/8"	-	95-9/16"	8.56	15.26	17.57
2880	19.33	-	29-1/8"	-	95-9/16"	13.22	20.57	23.05
3080	21.98	-	33-1/8"	-	95-9/16"	15.55	23.23	25.79
Inswing Entrance Doors, 2-Wide (stationary/active)								
4068	11.67	-	21-1/8"	-	79-9/16"	13.85	12.71	28.83
5068	14.99	-	27-1/8"	-	79-9/16"	19.51	16.02	35.72
5468	16.09	-	29-1/8"	-	79-9/16"	21.40	17.13	38.02
6068	18.30	-	33-1/8"	-	79-9/16"	25.17	19.34	42.62
4070	12.26	-	21-1/8"	-	83-9/16"	14.67	13.35	30.22
5070	15.74	-	27-1/8"	-	83-9/16"	20.66	16.83	37.45
5470	16.90	-	29-1/8"	-	83-9/16"	22.66	17.99	39.86
6070	19.22	-	33-1/8"	-	83-9/16"	26.65	20.31	44.68
4080	14.02	-	21-1/8"	-	95-9/16"	17.12	15.26	34.41
5080	18.00	-	27-1/8"	-	95-9/16"	24.11	19.25	42.63
5480	19.33	-	29-1/8"	-	95-9/16"	26.44	20.57	45.37
6080	21.98	-	33-1/8"	-	95-9/16"	31.10	23.23	50.86
Inswing Entrance Doors, French								
4068	11.67	23.10	21-1/8"	41-13/16"	79-9/16"	13.85	26.28	28.83
5068	14.99	29.73	27-1/8"	53-13/16"	79-9/16"	19.51	32.91	35.72
5468	16.09	31.94	29-1/8"	57-13/16"	79-9/16"	21.40	35.12	38.02
6068	18.30	36.36	33-1/8"	65-13/16"	79-9/16"	25.17	39.54	42.62
4070	12.26	24.26	21-1/8"	41-13/16"	83-9/16"	14.67	27.60	30.22
5070	15.74	31.23	27-1/8"	53-13/16"	83-9/16"	20.66	34.56	37.45
5470	16.90	33.55	29-1/8"	57-13/16"	83-9/16"	22.66	36.89	39.86
6070	19.22	38.19	33-1/8"	65-13/16"	83-9/16"	26.65	41.53	44.68
4080	14.02	27.75	21-1/8"	41-13/16"	95-9/16"	17.12	31.56	34.41
5080	18.00	35.71	27-1/8"	53-13/16"	95-9/16"	24.11	39.53	42.63
5480	19.33	38.37	29-1/8"	57-13/16"	95-9/16"	26.44	42.18	45.37
6080	21.98	43.68	33-1/8"	65-13/16"	95-9/16"	31.10	47.49	50.86

Product #	Sq. Ft. Clear Opg.		Clear Opg. Width		Clear Opg. Ht.	Sq. Ft. D.L.O.	Sq. Ft. Vent	Sq. Ft. of Unit Frame Dim.
	1 Open	2 Open	1 Open	2 Open				
Inswing Entrance Doors, 1-3/4" Thick Panels, 1-Wide								
3668	21.62	-	39-1/8"	-	79-9/16"	15.41	22.65	25.06
3670	22.70	-	39-1/8"	-	83-9/16"	16.32	23.79	26.27
3680	25.96	-	39-1/8"	-	95-9/16"	19.05	27.21	29.91
2090	15.78	-	21-1/8"	-	107-9/16"	9.78	17.18	19.70
2690	20.26	-	27-1/8"	-	107-9/16"	13.78	21.66	24.32
2890	21.76	-	29-1/8"	-	107-9/16"	15.11	23.16	25.85
3090	24.74	-	33-1/8"	-	107-9/16"	17.77	26.14	28.93
3690	29.22	-	39-1/8"	-	107-9/16"	21.77	30.63	33.54
20100	17.54	-	21-1/8"	-	119-9/16"	11.01	19.10	21.84
26100	22.52	-	27-1/8"	-	119-9/16"	15.50	24.08	26.95
28100	24.18	-	29-1/8"	-	119-9/16"	17.00	25.74	28.66
30100	27.50	-	33-1/8"	-	119-9/16"	20.00	29.06	32.06
36100	32.49	-	39-1/8"	-	119-9/16"	24.49	34.04	37.18
Inswing Entrance Doors, 1-3/4" Thick Panels, 2-Wide								
7068	21.62	-	39-1/8"	-	79-9/16"	30.83	22.65	49.51
7070	22.70	-	39-1/8"	-	83-9/16"	32.64	23.79	51.90
7080	25.96	-	39-1/8"	-	95-9/16"	38.09	27.21	59.09
4090	15.78	-	21-1/8"	-	107-9/16"	19.56	17.18	38.59
5090	20.26	-	27-1/8"	-	107-9/16"	27.56	21.66	47.81
5490	21.76	-	29-1/8"	-	107-9/16"	30.22	23.16	50.89
6090	24.74	-	33-1/8"	-	107-9/16"	35.55	26.14	57.04
7090	29.22	-	39-1/8"	-	107-9/16"	43.54	30.63	66.27
40100	17.54	-	21-1/8"	-	119-9/16"	22.01	19.10	42.77
50100	22.52	-	27-1/8"	-	119-9/16"	31.00	24.08	53.00
54100	24.18	-	29-1/8"	-	119-9/16"	34.00	25.74	56.41
60100	27.50	-	33-1/8"	-	119-9/16"	40.00	29.06	63.22
70100	32.49	-	39-1/8"	-	119-9/16"	48.99	34.04	73.45
Inswing Entrance Doors, 1-3/4" Thick Panels, 2-Wide French								
7068	21.62	42.99	39-1/8"	77-13/16"	79-9/16"	30.83	22.65	49.51
7070	22.70	45.15	39-1/8"	77-13/16"	83-9/16"	32.64	23.79	51.90
7080	25.96	51.64	39-1/8"	77-13/16"	95-9/16"	38.09	27.21	59.09
4090	15.78	31.23	21-1/8"	41-13/16"	107-9/16"	19.56	17.18	38.59
5090	20.26	40.20	27-1/8"	53-13/16"	107-9/16"	27.56	21.66	47.81
5490	21.76	43.18	29-1/8"	57-13/16"	107-9/16"	30.22	23.16	50.89
6090	24.74	49.16	33-1/8"	65-13/16"	107-9/16"	35.55	26.14	57.04
7090	29.22	58.12	39-1/8"	77-13/16"	107-9/16"	43.54	30.63	66.27
40100	17.54	34.72	21-1/8"	41-13/16"	119-9/16"	22.01	19.10	42.77
50100	22.52	44.68	27-1/8"	53-13/16"	119-9/16"	31.00	24.08	53.00
54100	24.18	48.00	29-1/8"	57-13/16"	119-9/16"	34.00	25.74	56.41
60100	27.50	54.64	33-1/8"	65-13/16"	119-9/16"	40.00	29.06	63.22
70100	32.49	64.61	39-1/8"	77-13/16"	119-9/16"	48.99	34.04	73.45

NOTE: For the most up-to-date data, please visit www.kolbewindows.com.

Notes for Inswing Patio Doors:

- ▶ For units with ADA-compliant sills, add 5/8" to the clear opening heights.
- ▶ One or both panels open to 90°

	Product #	Sq. Ft. Clear Opg.		Clear Opg. Width		Clear Opg. Ht.	Sq. Ft. D.L.O.	Sq. Ft. Vent	Sq. Ft. of Unit Frame Dim.
		1 Open	2 Open	1 Open	2 Open				
Inswing Patio Doors – 1-Wide									
Modular Sizes	2666	13.65	-	25-3/4"	-	76-11/32"	8.68	14.65	16.70
	3066	16.83	-	31-3/4"	-	76-11/32"	11.37	17.83	20.01
	2680	16.53	-	25-3/4"	-	92-7/16"	10.83	17.73	20.08
	3080	20.38	-	31-3/4"	-	92-7/16"	14.20	21.58	24.06
Inswing Patio Doors – 2-Wide (stationary/active)									
Modular Sizes	41166	13.65	-	25-3/4"	-	76-11/32"	17.35	14.65	32.81
	51166	16.83	-	31-3/4"	-	76-11/32"	22.74	17.83	39.44
	41180	16.53	-	25-3/4"	-	92-7/16"	21.67	17.73	39.46
Inswing Patio Doors – French									
Modular Sizes	41166	13.65	27.07	25-3/4"	51-1/16"	76-11/32"	17.35	30.12	32.81
	51166	16.83	33.43	31-3/4"	63-1/16"	76-11/32"	22.74	36.48	39.44
	41180	16.53	32.78	25-3/4"	51-1/16"	92-7/16"	21.67	36.47	39.46
	51180	20.38	40.48	31-3/4"	63-1/16"	92-7/16"	28.40	44.17	47.42
Inswing Patio Doors – 3-Wide (stationary/active)									
Modular Sizes	7566	13.65	-	25-3/4"	-	76-11/32"	26.03	14.65	48.93
	81166	16.83	-	31-3/4"	-	76-11/32"	34.11	17.83	58.87
	7580	16.53	-	25-3/4"	-	92-7/16"	32.50	17.73	58.83
	81180	20.38	-	31-3/4"	-	92-7/16"	42.60	21.58	70.78

Notes for Outswing Entrance Doors:

- ▶ For units with ADA-compliant sills, add 5/8" to the clear opening heights.
- ▶ One or both panels open to 90°

Product #	Sq. Ft. Clear Opg.		Clear Opg. Width		Clear Opg. Ht.	Sq. Ft. D.L.O.	Sq. Ft. Vent	Sq. Ft. of Unit Frame Dim.
	1 Open	2 Open	1 Open	2 Open				
Outswing Entrance Doors – 1-Wide								
2068	11.57	-	21-3/32"	-	79"	6.93	12.67	15.04
2668	14.86	-	27-3/32"	-	79"	9.76	15.96	18.48
2868	15.96	-	29-3/32"	-	79"	10.70	17.06	19.63
3068	18.16	-	33-3/32"	-	79"	12.59	19.25	21.92
2070	12.16	-	21-3/32"	-	83"	7.33	13.31	15.77
2670	15.62	-	27-3/32"	-	83"	10.33	16.77	19.37
2870	16.77	-	29-3/32"	-	83"	11.33	17.92	20.58
3070	19.07	-	33-3/32"	-	83"	13.33	20.23	22.98
2080	13.92	-	21-3/32"	-	95"	8.56	15.24	17.95
2680	17.87	-	27-3/32"	-	95"	12.05	19.19	22.06
2880	19.19	-	29-3/32"	-	95"	13.22	20.51	23.43
3080	21.83	-	33-3/32"	-	95"	15.55	23.15	26.17

Product #	Sq. Ft. Clear Opg.		Clear Opg. Width		Clear Opg. Ht.	Sq. Ft. D.L.O.	Sq. Ft. Vent	Sq. Ft. of Unit Frame Dim.
	1 Open	2 Open	1 Open	2 Open				
Outswing Entrance Doors – 2-Wide								
4068	11.57	-	21-3/32"	-	79"	13.85	12.67	29.18
5068	14.86	-	27-3/32"	-	79"	19.51	15.96	36.06
5468	15.96	-	29-3/32"	-	79"	21.40	17.06	38.36
6068	18.16	-	33-3/32"	-	79"	25.17	19.25	42.95
4070	12.16	-	21-3/32"	-	83"	14.67	13.31	30.59
5070	15.62	-	27-3/32"	-	83"	20.66	16.77	37.81
5470	16.77	-	29-3/32"	-	83"	22.66	17.92	40.21
6070	19.07	-	33-3/32"	-	83"	26.65	20.23	45.03
4080	13.92	-	21-3/32"	-	95"	17.12	15.24	34.83
5080	17.87	-	27-3/32"	-	95"	24.11	19.19	43.05
5480	19.19	-	29-3/32"	-	95"	26.44	20.51	45.79
Outswing Entrance Doors – French								
4068	11.57	23.04	21-3/32"	42"	79"	13.85	26.20	29.18
5068	14.86	29.63	27-3/32"	54"	79"	19.51	32.78	36.06
5468	15.96	31.82	29-3/32"	58"	79"	21.40	34.97	38.36
6068	18.16	36.21	33-3/32"	66"	79"	25.17	39.36	42.95
4070	12.16	24.21	21-3/32"	42"	83"	14.67	27.52	30.59
5070	15.62	31.13	27-3/32"	54"	83"	20.66	34.44	37.81
5470	16.77	33.43	29-3/32"	58"	83"	22.66	36.74	40.21
6070	19.07	38.04	33-3/32"	66"	83"	26.65	41.36	45.03
4080	13.92	27.71	21-3/32"	42"	95"	17.12	31.50	34.83
5080	17.87	35.63	27-3/32"	54"	95"	24.11	39.42	43.05
5480	19.19	38.26	29-3/32"	58"	95"	26.44	42.06	45.79
6080	21.83	43.54	33-3/32"	66"	95"	31.10	47.34	51.27

Product #	Sq. Ft. Clear Opg.		Clear Opg. Width		Clear Opg. Ht.	Sq. Ft. D.L.O.	Sq. Ft. Vent	Sq. Ft. of Unit Frame Dim.
	1 Open	2 Open	1 Open	2 Open				
Outswing Entrance Doors – 1-3/4" thick panels, 1-Wide								
3668	21.45	-	39-3/32"	-	79"	15.41	22.54	25.36
3670	22.53	-	39-3/32"	-	83"	16.32	23.69	26.59
3680	25.79	-	39-3/32"	-	95"	19.05	27.11	30.28
2090	15.67	-	21-3/32"	-	107"	9.78	17.16	20.14
2690	20.13	-	27-3/32"	-	107"	13.78	21.62	24.74
2890	21.62	-	29-3/32"	-	107"	15.11	23.10	26.28
3090	24.59	-	33-3/32"	-	107"	17.77	26.08	29.35
3690	29.05	-	39-3/32"	-	107"	21.77	30.53	33.96
20100	17.43	-	21-3/32"	-	119"	11.01	19.08	22.32
26100	22.39	-	27-3/32"	-	119"	15.50	24.04	27.43
28100	24.04	-	29-3/32"	-	119"	17.00	25.70	29.13
30100	27.35	-	33-3/32"	-	119"	20.00	29.00	32.54
36100	32.31	-	39-3/32"	-	119"	24.49	33.96	37.65

NOTE: For the most up-to-date data, please visit www.kolbewindows.com.

Clear Opening Dimensions

Product #	Sq. Ft. Clear Opg.		Clear Opg. Width		Clear Opg. Ht.	Sq. Ft. D.L.O.	Sq. Ft. Vent	Sq. Ft. of Unit Frame Dim.
	1 Open	2 Open	1 Open	2 Open				
Outswing Entrance Doors - 1-3/4" thick panels, 2-Wide								
7068	21.45	-	39-3/32"	-	79"	30.83	22.54	49.83
7070	22.53	-	39-3/32"	-	83"	32.64	23.69	52.24
7080	25.79	-	39-3/32"	-	95"	38.09	27.11	59.48
4090	15.67	-	21-3/32"	-	107"	19.56	17.16	39.07
5090	20.13	-	27-3/32"	-	107"	27.56	21.62	48.29
5490	21.62	-	29-3/32"	-	107"	30.22	23.10	51.36
6090	24.59	-	33-3/32"	-	107"	35.55	26.08	57.50
7090	29.05	-	39-3/32"	-	107"	43.54	30.53	66.72
40100	17.43	-	21-3/32"	-	119"	22.01	19.08	43.31
50100	22.39	-	27-3/32"	-	119"	31.00	24.04	53.53
54100	24.04	-	29-3/32"	-	119"	34.00	25.70	56.93
60100	27.35	-	33-3/32"	-	119"	40.00	29.00	63.74
70100	32.31	-	39-3/32"	-	119"	48.99	33.96	73.96
Outswing Entrance Doors - 1-3/4", 2-Wide French								
7068	21.45	42.79	39-3/32"	78	79"	30.83	22.54	49.83
7070	22.53	44.96	39-3/32"	78	83"	32.64	23.69	52.24
7080	25.79	51.46	39-3/32"	78	95"	38.09	27.11	59.48
4090	15.67	31.21	21-3/32"	42	107"	19.56	17.16	39.07
5090	20.13	40.13	27-3/32"	54	107"	27.56	21.62	48.29
5490	21.62	43.10	29-3/32"	58	107"	30.22	23.10	51.36
6090	24.59	49.04	33-3/32"	66	107"	35.55	26.08	57.50
7090	29.05	57.96	39-3/32"	78	107"	43.54	30.53	66.72
40100	17.43	34.71	21-3/32"	42	119"	22.01	19.08	43.31
50100	22.39	44.63	27-3/32"	54	119"	31.00	24.04	53.53
54100	24.04	47.93	29-3/32"	58	119"	34.00	25.70	56.93
60100	27.35	54.54	33-3/32"	66	119"	40.00	29.00	63.74
70100	32.31	64.46	39-3/32"	78	119"	48.99	33.96	73.96

Notes for Outswing Patio Doors:

- ▶ For units with ADA-compliant sills, add 5/8" to the clear opening heights.
- ▶ One or both panels open to 90°

Product #	Sq. Ft. Clear Opg.		Clear Opg. Width		Clear Opg. Ht.	Sq. Ft. D.L.O.	Sq. Ft. Vent	Sq. Ft. of Unit Frame Dim.
	1 Open	2 Open	1 Open	2 Open				
Outswing Patio Doors								
2666	13.53	-	25-23/32"	-	75-25/32"	8.68	14.59	17.00
3066	16.69	-	31-23/32"	-	75-25/32"	11.37	17.74	20.31
41166	13.53	-	25-23/32"	-	75-25/32"	17.35	14.59	33.14
51166	16.69	-	31-23/32"	-	75-25/32"	22.74	17.74	39.76
7566	13.53	-	25-23/32"	-	75-25/32"	26.03	14.59	49.26
81166	16.69	-	31-23/32"	-	75-25/32"	34.11	17.73	59.19
2680	16.41	-	25-23/32"	-	91-7/8"	10.83	17.69	20.45
3080	20.24	-	31-23/32"	-	91-7/8"	14.20	21.51	24.43
41180	16.41	-	25-23/32"	-	91-7/8"	21.67	17.69	39.86
51180	20.24	-	31-23/32"	-	91-7/8"	28.40	21.51	47.82
7580	16.41	-	25-23/32"	-	91-7/8"	32.50	17.69	59.25
81180	20.24	-	31-23/32"	-	91-7/8"	42.60	21.51	71.19
Outswing Patio Doors - French								
41166	13.53	26.97	25-23/32"	51-1/4"	75-25/32"	17.35	30.00	33.14
51166	16.69	33.29	31-23/32"	63-1/4"	75-25/32"	22.74	36.31	39.76
41180	16.41	32.70	25-23/32"	51-1/4"	91-7/8"	21.67	36.37	39.86
51180	20.24	40.35	31-23/32"	63-1/4"	91-7/8"	28.40	44.02	47.82

Notes for TerraSpan® Lift & Slide Doors, Multi-Slide Doors, and Folding Doors:

- ▶ There are no standard sizes. Contact your dealer for clear opening information.

Product #	Sq. Ft. Clear Opg.	Clear Opg.		Sq. Ft. D.L.O.	Sq. Ft. Vent	Sq. Ft. of Frame Dim.	
		Width	Height				
Garden-Aire Sliding Patio Doors, Narrow Stile – 1-Wide							
2968	-	-	-	12.46	-	18.61	
3368	-	-	-	15.55	-	22.04	
4368	-	-	-	21.71	-	28.91	
4968	-	-	-	24.80	-	32.35	
5368	-	-	-	27.88	-	35.78	
2970	-	-	-	13.14	-	19.51	
3370	-	-	-	16.39	-	23.11	
4370	-	-	-	22.89	-	30.31	
4970	-	-	-	26.14	-	33.91	
5370	-	-	-	29.39	-	37.52	
2980	-	-	-	15.16	-	22.22	
3380	-	-	-	18.91	-	26.32	
4380	-	-	-	26.41	-	34.52	
4980	-	-	-	30.16	-	38.62	
5380	-	-	-	33.91	-	42.72	
2990	-	-	-	17.18	-	24.93	
3390	-	-	-	21.43	-	29.53	
4390	-	-	-	29.93	-	38.73	
4990	-	-	-	34.18	-	43.33	
5390	-	-	-	38.43	-	47.93	
29100	-	-	-	19.20	-	27.63	
33100	-	-	-	23.95	-	32.74	
43100	-	-	-	33.45	-	42.94	
49100	-	-	-	38.20	-	48.04	
53100	-	-	-	42.95	-	53.14	
Modular Sizes	2866	-	-	11.72	-	17.67	
	3266	-	-	14.68	-	20.98	
	3666	-	-	16.29	-	22.77	
	4266	-	-	20.60	-	27.60	
	2880	-	-	14.36	-	21.22	
	3280	-	-	17.99	-	25.20	
	3680	-	-	19.95	-	27.36	
	4280	-	-	25.24	-	33.16	
	Garden-Aire Sliding Patio Doors, Narrow Stile – 2-wide						
	5068	12.01	22"	78-5/8"	24.92	12.01	34.35
6068	15.29	28"	78-5/8"	31.09	15.29	41.22	
8068	21.84	40"	78-5/8"	43.42	21.84	54.96	
9068	25.12	46"	78-5/8"	49.59	25.12	61.83	
10068	28.39	52"	78-5/8"	55.76	28.39	68.70	
5070	12.62	22"	82-5/8"	26.27	12.62	36.02	
6070	16.07	28"	82-5/8"	32.77	16.07	43.22	
8070	22.95	40"	82-5/8"	45.77	22.95	57.63	
9070	26.39	46"	82-5/8"	52.27	26.39	64.83	
10070	29.84	52"	82-5/8"	58.77	29.84	72.03	
5080	14.46	22"	94-5/8"	30.31	14.46	41.02	
6080	18.40	28"	94-5/8"	37.81	18.40	49.22	
8080	26.28	40"	94-5/8"	52.81	26.28	65.63	

Product #	Sq. Ft. Clear Opg.	Clear Opg.		Sq. Ft. D.L.O.	Sq. Ft. Vent	Sq. Ft. of Frame Dim.	
		Width	Height				
Garden-Aire Sliding Patio Doors, Narrow Stile 2-Wide (continued)							
9080	30.23	46"	94-5/8"	60.31	30.23	73.83	
10080	34.17	52"	94-5/8"	67.81	34.17	82.03	
5090	16.29	22"	106-5/8"	34.35	16.29	46.02	
6090	20.73	28"	106-5/8"	42.85	20.73	55.22	
8090	29.62	40"	106-5/8"	59.85	29.62	73.63	
9090	34.06	46"	106-5/8"	68.35	34.06	82.83	
10090	38.50	52"	106-5/8"	76.85	38.50	92.03	
50100	18.12	22"	118-5/8"	38.40	18.12	51.02	
60100	23.07	28"	118-5/8"	47.90	23.07	61.22	
80100	32.95	40"	118-5/8"	66.90	32.95	81.63	
90100	37.89	46"	118-5/8"	76.40	37.89	91.83	
100100	42.84	52"	118-5/8"	85.90	42.84	102.03	
Modular Sizes	41166	11.30	21-1/2"	75-11/16"	23.44	11.30	32.57
	51166	14.45	27-1/2"	75-11/16"	29.36	14.45	39.20
	6666	16.16	30-3/4"	75-11/16"	32.57	16.16	42.79
	71166	20.76	39-1/2"	75-11/16"	41.21	20.76	52.45
	41180	13.69	21-1/2"	91-11/16"	28.72	13.69	39.13
	51180	17.51	27-1/2"	91-11/16"	35.97	17.51	47.09
	6680	19.58	30-3/4"	91-11/16"	39.90	19.58	51.40
	71180	25.15	39-1/2"	91-11/16"	50.48	25.15	63.00
	Garden-Aire Sliding Patio Doors, Narrow Stile – 3-Wide with Sidelite						
	7968	12.01	22"	78-5/8"	37.39	12.01	52.95
9368	15.29	28"	78-5/8"	46.64	15.29	63.26	
12368	21.84	40"	78-5/8"	65.14	21.84	83.87	
13968	25.12	46"	78-5/8"	74.39	25.12	94.17	
15368	28.39	52"	78-5/8"	83.64	28.39	104.48	
7970	12.62	22"	82-5/8"	39.41	12.62	55.52	
9370	16.07	28"	82-5/8"	49.16	16.07	66.33	
12370	22.95	40"	82-5/8"	68.66	22.95	87.94	
13970	26.39	46"	82-5/8"	78.41	26.39	98.74	
15370	29.84	52"	82-5/8"	88.16	29.84	109.55	
7980	14.46	22"	94-5/8"	45.47	14.46	63.23	
9380	18.40	28"	94-5/8"	56.72	18.40	75.54	
12380	26.28	40"	94-5/8"	79.22	26.28	100.15	
13980	30.23	46"	94-5/8"	90.47	30.23	112.45	
15380	34.17	52"	94-5/8"	101.72	34.17	124.76	
7990	16.29	22"	106-5/8"	51.53	16.29	70.94	
9390	20.73	28"	106-5/8"	64.28	20.73	84.75	
12390	29.62	40"	106-5/8"	89.78	29.62	112.35	
13990	34.06	46"	106-5/8"	102.53	34.06	126.16	
15390	38.50	52"	106-5/8"	115.28	38.50	139.96	
79100	18.12	22"	118-5/8"	57.59	18.12	78.65	
93100	23.07	28"	118-5/8"	71.84	23.07	93.95	
123100	32.95	40"	118-5/8"	100.34	32.95	124.56	
139100	37.89	46"	118-5/8"	114.59	37.89	139.87	
153100	42.84	52"	118-5/8"	128.84	42.84	155.17	

NOTE: For the most up-to-date data, please visit www.kolbewindows.com.

Clear Opening Dimensions

Product #	Sq. Ft. Clear Opg.	Clear Opg.		Sq. Ft. D.L.O.	Sq. Ft. Vent	Sq. Ft. of Frame Dim.
		Width	Height			
Garden-Aire Sliding Patio Doors, Narrow Stile – 3-Wide with Sidelite (continued)						
7766	11.30	21-1/2"	75-11/16"	35.16	11.30	50.24
9166	14.45	27-1/2"	75-11/16"	44.04	14.45	60.18
91166	16.34	31-1/12"	75-11/16"	49.35	16.34	66.11
12166	20.76	39-1/2"	75-11/16"	61.81	20.76	80.05
7780	13.69	21-1/2"	91-11/16"	43.08	13.69	60.35
9180	17.51	27-1/2"	91-11/16"	53.96	17.51	72.29
91180	19.79	31-1/12"	91-11/16"	60.46	19.79	79.42
12180	25.15	39-1/2"	91-11/16"	75.73	25.15	96.16
Garden-Aire Sliding Patio Doors, Narrow Stile 3-Wide: Active-Fixed-Active						
9668	12.01	22"	78-5/8"	50.88	12.01	65.19
11668	15.29	28"	78-5/8"	63.21	15.29	78.93
15668	21.84	40"	78-5/8"	87.88	21.84	106.41
9670	12.62	22"	82-5/8"	53.63	12.62	68.35
11670	16.07	28"	82-5/8"	66.63	16.07	82.76
15670	22.95	40"	82-5/8"	92.63	22.95	111.57
9680	14.46	22"	94-5/8"	61.88	14.46	77.84
11680	18.40	28"	94-5/8"	76.88	18.40	94.25
9690	16.29	22"	106-5/8"	70.13	16.29	87.33
11690	20.73	28"	106-5/8"	87.13	20.73	105.74
96100	18.12	22"	118-5/8"	78.38	18.12	96.82
116100	23.07	28"	118-5/8"	97.38	23.07	117.23

Product #	Sq. Ft. Clear Opg.		Clear Opg. Width		Clear Opg. Ht.	Sq. Ft. D.L.O.	Sq. Ft. Vent	Sq. Ft. of Unit Frame Dim.
	1 Open	2 Open	1 Open	2 Open				
Garden-Aire Sliding Patio Doors, Narrow Stile – 4-Wide								
4-10068	13.45	24.38	24-5/8"	44-21/32"	78-5/8"	49.85	24.38	67.87
4-12068	16.72	30.93	30-5/8"	56-21/32"	78-5/8"	62.18	30.93	81.61
4-16068	23.27	44.04	42-5/8"	80-21/32"	78-5/8"	86.85	44.04	109.09
4-18068	26.55	50.59	48-5/8"	92-21/32"	78-5/8"	99.18	50.59	122.83
4-20068	29.83	57.14	54-5/8"	104-21/32"	78-5/8"	111.51	57.14	136.57
4-10070	14.13	25.62	24-5/8"	44-21/32"	82-5/8"	52.54	25.62	71.17
4-12070	17.57	32.51	30-5/8"	56-21/32"	82-5/8"	65.54	32.51	85.57
4-16070	24.46	46.28	42-5/8"	80-21/32"	82-5/8"	91.54	46.28	114.39
4-18070	27.90	53.16	48-5/8"	92-21/32"	82-5/8"	104.54	53.16	128.79
4-20070	31.34	60.05	54-5/8"	104-21/32"	82-5/8"	117.54	60.05	143.20
4-10080	16.18	29.34	24-5/8"	44-21/32"	94-5/8"	60.63	29.34	81.05
4-12080	20.12	37.23	30-5/8"	56-21/32"	94-5/8"	75.63	37.23	97.45
4-16080	28.01	53.00	42-5/8"	80-21/32"	94-5/8"	105.63	53.00	130.27
4-18080	31.95	60.89	48-5/8"	92-21/32"	94-5/8"	120.63	60.89	146.67
4-20080	35.90	68.77	54-5/8"	104-21/32"	94-5/8"	135.63	68.77	163.08
4-10090	18.23	33.07	24-5/8"	44-21/32"	106-5/8"	68.71	33.07	90.93
4-12090	22.68	41.95	30-5/8"	56-21/32"	106-5/8"	85.71	41.95	109.34
4-16090	31.56	59.72	42-5/8"	80-21/32"	106-5/8"	119.71	59.72	146.15
4-18090	36.00	68.61	48-5/8"	92-21/32"	106-5/8"	136.71	68.61	164.55
4-20090	40.45	77.49	54-5/8"	104-21/32"	106-5/8"	153.71	77.49	182.96
4-100100	20.29	36.79	24-5/8"	44-21/32"	118-5/8"	76.79	36.79	100.81
4-120100	25.23	46.67	30-5/8"	56-21/32"	118-5/8"	95.79	46.67	121.22
4-160100	35.11	66.44	42-5/8"	80-21/32"	118-5/8"	133.79	66.44	162.03
4-180100	40.06	76.33	48-5/8"	92-21/32"	118-5/8"	152.79	76.33	182.43
4-200100	45.00	86.21	54-5/8"	104-21/32"	118-5/8"	171.79	86.21	202.84

Product #	Sq. Ft. Clear Opg.	Clear Opg.		Sq. Ft. D.L.O.	Sq. Ft. Vent	Sq. Ft. of Frame Dim.
		Width	Height			
Garden-Aire Sliding Patio Doors, Wide Stile – 1-Wide						
2968	-	-	-	9.83	-	18.61
3368	-	-	-	12.64	-	22.04
4368	-	-	-	18.26	-	28.91
4968	-	-	-	21.07	-	32.35
5368	-	-	-	23.88	-	35.78
2970	-	-	-	10.42	-	19.51
3370	-	-	-	13.39	-	23.11
4370	-	-	-	19.35	-	30.31
4970	-	-	-	22.32	-	33.91
5370	-	-	-	25.30	-	37.52
2980	-	-	-	12.17	-	22.22
3380	-	-	-	15.64	-	26.32
4380	-	-	-	22.60	-	34.52
4980	-	-	-	26.07	-	38.62
5380	-	-	-	29.55	-	42.72
2990	-	-	-	13.92	-	24.93
3390	-	-	-	17.89	-	29.53
4390	-	-	-	25.85	-	38.73
4990	-	-	-	29.82	-	43.33
5390	-	-	-	33.80	-	47.93
29100	-	-	-	15.67	-	27.63
33100	-	-	-	20.14	-	32.74
43100	-	-	-	29.10	-	42.94
49100	-	-	-	33.57	-	48.04
53100	-	-	-	38.05	-	53.14
Garden-Aire Sliding Patio Doors, Wide Stile – 2-Wide						
2866	-	-	-	9.18	-	17.67
3266	-	-	-	11.87	-	20.98
3666	-	-	-	13.33	-	22.77
4266	-	-	-	17.24	-	27.60
2880	-	-	-	11.46	-	21.22
3280	-	-	-	14.81	-	25.20
3680	-	-	-	16.63	-	27.36
4280	-	-	-	21.52	-	33.16
5068	12.01	22	78-5/8"	19.67	12.01	34.35
6068	15.29	28	78-5/8"	25.29	15.29	41.22
8068	21.84	40	78-5/8"	36.53	21.84	54.96
9068	25.12	46	78-5/8"	42.15	25.12	61.83
10068	28.39	52	78-5/8"	47.77	28.39	68.70
5070	12.62	22	82-5/8"	20.84	12.62	36.02
6070	16.07	28	82-5/8"	26.79	16.07	43.22
8070	22.95	40	82-5/8"	38.70	22.95	57.63
9070	26.39	46	82-5/8"	44.65	26.39	64.83
10070	29.84	52	82-5/8"	50.60	29.84	72.03
5080	14.46	22	94-5/8"	24.34	14.46	41.02
6080	18.40	28	94-5/8"	31.29	18.40	49.22
8080	26.28	40	94-5/8"	45.20	26.28	65.63

NOTE: For the most up-to-date data, please visit www.kolbewindows.com.

Product #	Sq. Ft. Clear Opg.	Clear Opg.		Sq. Ft. D.L.O.	Sq. Ft. Vent	Sq. Ft. of Frame Dim.	
		Width	Height				
Garden-Aire Sliding Patio Doors, Wide Stile – 2-Wide (continued)							
9080	30.23	46"	94 5/8	52.15	30.23	73.83	
10080	34.17	52"	94 5/8	59.10	34.17	82.03	
5090	16.29	22"	106 5/8	27.84	16.29	46.02	
6090	20.73	28"	106 5/8	35.79	20.73	55.22	
8090	29.62	40"	106 5/8	51.70	29.62	73.63	
9090	34.06	46"	106 5/8	59.65	34.06	82.83	
10090	38.50	52"	106 5/8	67.60	38.50	92.03	
50100	18.12	22"	118 5/8	31.34	18.12	51.02	
60100	23.07	28"	118 5/8	40.29	23.07	61.22	
80100	32.95	40"	118 5/8	58.20	32.95	81.63	
90100	37.89	46"	118 5/8	67.15	37.89	91.83	
100100	42.84	52"	118 5/8	76.10	42.84	102.03	
Modular Sizes	41166	11.30	21-1/2"	75 11/16	18.36	11.30	32.57
	51166	14.45	27-1/2"	75 11/16	23.74	14.45	39.20
	6666	16.16	30-3/4"	75 11/16	26.65	16.16	42.79
	71166	20.76	39-1/2"	75 11/16	34.49	20.76	52.45
	41180	13.69	21-1/2"	91 11/16	22.92	13.69	39.13
	51180	17.51	27-1/2"	91 11/16	29.63	17.51	47.09
	6680	19.58	30-3/4"	91 11/16	33.26	19.58	51.40
	71180	25.15	39-1/2"	91 11/16	43.05	25.15	63.00
	Garden-Aire Sliding Patio Doors, Wide Stile – 3-Wide with Sidelite						
7968	12.01	22"	78-5/8"	29.50	12.01	52.95	
9368	15.29	28"	78-5/8"	37.93	15.29	63.26	
12368	21.84	40"	78-5/8"	54.79	21.84	83.87	
19368	25.12	46"	78-5/8"	63.22	25.12	94.17	
15368	28.39	52"	78-5/8"	71.65	28.39	104.48	
7970	12.62	22"	82-5/8"	31.25	12.62	55.52	
9370	16.07	28"	82-5/8"	40.18	16.07	66.33	
12370	22.95	40"	82-5/8"	58.04	22.95	87.94	
19370	26.39	46"	82-5/8"	66.97	26.39	98.74	
15370	29.84	52"	82-5/8"	75.90	29.84	109.55	
7980	14.46	22"	94-5/8"	36.50	14.46	63.23	
9380	18.40	28"	94-5/8"	46.93	18.40	75.54	
12380	26.28	40"	94-5/8"	67.79	26.28	100.15	
19380	30.23	46"	94-5/8"	78.22	30.23	112.45	
15380	34.17	52"	94-5/8"	88.65	34.17	124.76	
7990	16.29	22"	106-5/8"	41.75	16.29	70.94	
9390	20.73	28"	106-5/8"	53.68	20.73	84.75	
12390	29.62	40"	106-5/8"	77.54	29.62	112.35	
13990	34.06	46"	106-5/8"	89.47	34.06	126.16	
15390	38.50	52"	106-5/8"	101.40	38.50	139.96	
79100	18.12	22"	118-5/8"	47.00	18.12	78.65	
93100	23.07	28"	118-5/8"	60.43	23.07	93.95	
123100	32.95	40"	118-5/8"	87.29	32.95	124.56	
139100	37.89	46"	118-5/8"	100.72	37.89	139.87	
153100	42.84	52"	118-5/8"	114.15	42.84	155.17	

Product #	Sq. Ft. Clear Opg.	Clear Opg.		Sq. Ft. D.L.O.	Sq. Ft. Vent	Sq. Ft. of Frame Dim.	
		Width	Height				
Garden-Aire Sliding Patio Doors, Wide Stile – 3-Wide with Sidelite (continued)							
Modular Sizes	7766	11.30	21-1/2"	75-11/16"	27.55	11.30	50.24
	9166	14.45	27-1/2"	75-11/16"	35.61	14.45	60.18
	91166	16.16	30-3/4"	75-11/16"	39.98	16.16	65.56
	12166	20.76	39-1/2"	75-11/16"	51.73	20.76	80.05
	7780	13.69	21-1/2"	91-11/16"	34.38	13.69	60.35
	9180	17.51	27-1/2"	91-11/16"	44.44	17.51	72.29
	91180	19.58	30-3/4"	91-11/16"	49.89	19.58	78.75
	12180	25.15	39-1/2"	91-11/16"	64.57	25.15	96.16
	Garden-Aire Sliding Patio Doors, Wide Stile – 3-Wide Active-Fixed-Active						
9668	12.01	22"	78-5/8"	41.80	24.02	65.19	
11668	15.29	28"	78-5/8"	53.04	30.58	78.93	
15668	21.84	40"	78-5/8"	75.52	43.68	106.41	
9670	12.62	22"	82-5/8"	44.28	25.25	68.35	
11670	16.07	28"	82-5/8"	56.18	32.13	82.76	
15670	22.95	40"	82-5/8"	80.00	45.90	111.57	
9680	14.46	22"	94-5/8"	51.71	28.91	77.84	
11680	18.40	28"	94-5/8"	65.62	36.80	94.25	
9690	16.29	22"	106-5/8"	59.15	32.58	87.33	
11690	20.73	28"	106-5/8"	75.06	41.47	105.74	
96100	18.12	22"	118-5/8"	66.59	36.25	96.82	
116100	23.07	28"	118-5/8"	84.50	46.13	117.23	

Product #	Sq. Ft. Clear Opg.		Clear Opg. Width		Clear Opg. Ht.	Sq. Ft. D.L.O.	Sq. Ft. Vent	Sq. Ft. of Unit Frame Dim.
	1 Open	2 Open	1 Open	2 Open				
Garden-Aire Sliding Patio Doors, Wide Stile – 4-Wide								
4-10068	13.48	24.44	24-17/25"	44-49/64"	78-5/8"	39.44	24.44	67.87
4-12068	16.75	30.99	30-17/25"	56-49/64"	78-5/8"	50.68	30.99	81.61
4-16068	23.30	44.10	42-17/25"	80-49/64"	78-5/8"	73.16	44.10	109.09
4-18068	26.58	50.65	48-17/25"	92-49/64"	78-5/8"	84.40	50.65	122.83
4-20068	29.86	57.20	54-17/25"	104-49/64"	78-5/8"	95.64	57.20	136.57
4-10070	14.16	25.69	24-17/25"	44-49/64"	82-5/8"	41.78	25.69	71.17
4-12070	17.60	32.57	30-17/25"	56-49/64"	82-5/8"	53.69	32.57	85.57
4-16070	24.49	46.34	42-17/25"	80-49/64"	82-5/8"	77.50	46.34	114.39
4-18070	27.93	53.23	48-17/25"	92-49/64"	82-5/8"	89.41	53.23	128.79
4-20070	31.37	60.11	54-17/25"	104-49/64"	82-5/8"	101.31	60.11	143.20
4-10080	16.22	29.42	24-17/25"	44-49/64"	94-5/8"	48.80	29.42	81.05
4-12080	20.16	37.30	30-17/25"	56-49/64"	94-5/8"	62.70	37.30	97.45
4-16080	28.05	53.07	42-17/25"	80-49/64"	94-5/8"	90.52	53.07	130.27
4-18080	31.99	60.96	48-17/25"	92-49/64"	94-5/8"	104.42	60.96	146.67
4-20080	35.93	68.84	54-17/25"	104-49/64"	94-5/8"	118.33	68.84	163.08
4-10090	18.27	33.15	24-17/25"	44-49/64"	106-5/8"	55.82	33.15	90.93
4-12090	22.72	42.03	30-17/25"	56-49/64"	106-5/8"	71.72	42.03	109.34
4-16090	31.60	59.80	42-17/25"	80-49/64"	106-5/8"	103.54	59.80	146.15
4-18090	36.04	68.69	48-17/25"	92-49/64"	106-5/8"	119.44	68.69	164.55
4-20090	40.49	77.57	54-17/25"	104-49/64"	106-5/8"	135.35	77.57	182.96
4-100100	20.33	36.88	24-17/25"	44-49/64"	118-5/8"	62.84	36.88	100.81
4-120100	25.27	46.76	30-17/25"	56-49/64"	118-5/8"	80.74	46.76	121.22
4-160100	35.16	66.53	42-17/25"	80-49/64"	118-5/8"	116.55	66.53	162.03
4-180100	40.10	76.42	48-17/25"	92-49/64"	118-5/8"	134.46	76.42	182.43
4-200100	45.04	86.30	54-17/25"	104-49/64"	118-5/8"	152.37	86.30	202.84

NOTE: For the most up-to-date data, please visit www.kolbwindows.com.

Energy Performance Data

ENERGY STAR® – United States



Energy Star is a government-regulated program that was created by the Environmental Protection Agency (EPA), and the U.S. Department of Energy (DOE), to help consumers quickly and easily identify energy saving products.

The Energy Star program uses energy values obtained by window and door manufacturers through the National Fenestration Rating Council (NFRC) program. NFRC ratings are based on the energy performance of the total window or door – both glass and frame.

The Energy Star program for the United States divides the nation into four separate climate zones – Northern, North-Central, South-Central, and Southern.

The performance criteria that needs to be met in order to be Energy Star compliant in a specific climate zone (effective January 1, 2015) is shown in the charts provided.

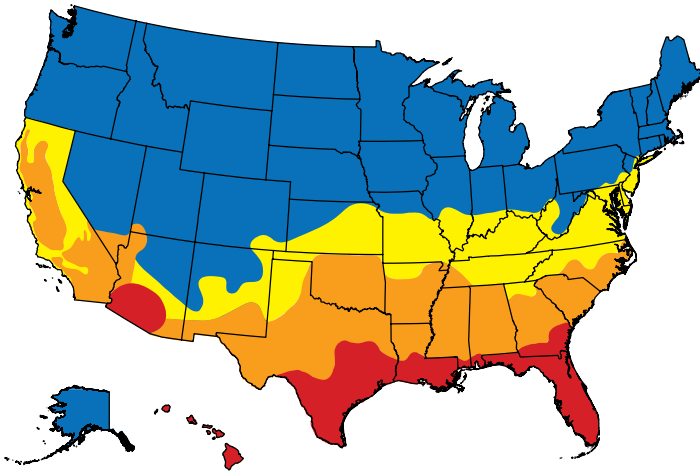

- Northern
Mostly Heating
- North-Central
Heating & Cooling
- South-Central
Heating & Cooling
- Southern
Mostly Cooling

2015 ENERGY STAR Qualification Criteria for Windows

Climate Zones - U.S.		U-Factor	SHGC
	North-Central	≤ 0.30	≤ 0.40
	South-Central	≤ 0.30	≤ 0.25
	Southern	≤ 0.40	≤ 0.25

**Northern zone windows can meet prescriptive (1st row) or alternative energy performance (2nd & 3rd row) criteria to qualify for ENERGY STAR.

2016 ENERGY STAR Qualification Criteria for Windows

The effective date for the Northern Zone prescriptive and equivalent energy performance criteria for windows is January 1, 2016. North-Central, South-Central, and Southern criteria will continue to follow 2015 guidelines.

Climate Zones - U.S.		U-Factor	SHGC
	Northern**	≤ 0.27	Any
	Northern**	= 0.28	≥ 0.32
	Northern**	= 0.29	≥ 0.37
	Northern**	= 0.30	≥ 0.42

**Northern zone windows can meet prescriptive (1st row) or alternative energy performance (2nd, 3rd, and 4th rows) criteria to qualify for ENERGY STAR.

2015 ENERGY STAR Qualification Criteria for Doors

Glazing	U-Factor	SHGC	
Opaque	≤ 0.17	No rating	
≤ 1/2-Lite	≤ 0.25	≤ 0.25	
> 1/2-Lite	≤ 0.30	Northern North-Central	≤ 0.40
		Southern South-Central	≤ 0.25

California's Title 24

Kolbe's Ultra Series windows and doors can meet the strict California Title 24 Building Energy Efficiency Standards. Talk to your dealer about Ultra Series products with glass options that help meet these stringent energy efficiency requirements, yet have a variety of options for customization.

For energy performance data, visit:

▶ www.kolbewindows.com/energy

Kolbe demonstrates a commitment to providing accurate energy data by having products independently simulated, tested, inspected and listed in the NFRC certification program, and making that data available at kolbewindows.com and on window labels.

Energy performance data and air, water, structural data is updated on a continuous basis. For the most current information, contact your local Kolbe dealer.

Energy Performance Data

ENERGY STAR® – Canada

Products may comply for Canada's Energy Star program based on these compliance paths: their total U-factor, their Energy Rating (ER), or both. The Energy Rating is based on a product's overall performance based on three criteria: (1) solar heat gain, (2) U-factor, and (3) average air tightness. The higher the ER number, the better the product's thermal performance.



The U-factor and ER criteria for Canada's three climate zones is shown in the charts provided. For more detailed information about their Energy Rating system and Kolbe products that qualify for Canada's Energy Star Program, visit their website at www.oee.nrcan.gc.ca/energystar.

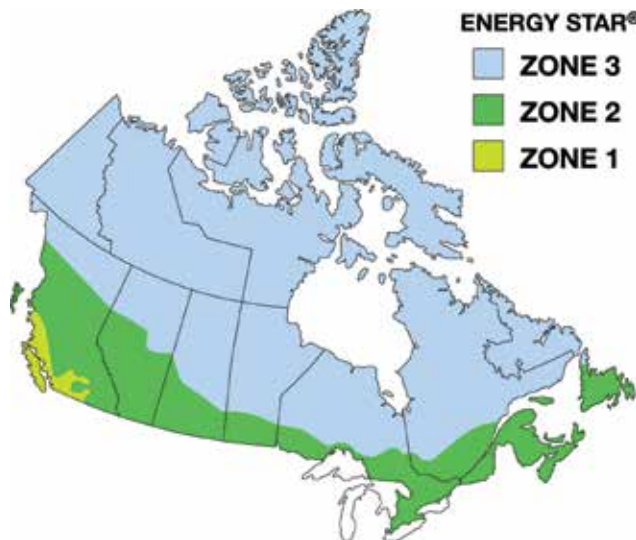

2015 ENERGY STAR – Canada Qualification Criteria for Windows and Sliding Doors†

Zone	COMPLIANCE PATHS		
	Minimum Energy Rating (ER)	or	Maximum U-Factor
1	25	or	≤ 0.28 (Min. ER = 16)
2	29	or	≤ 0.25 (Min. ER = 20)
3	34	or	≤ 0.21 (Min. ER = 24)

2015 ENERGY STAR – Canada Qualification Criteria for Doors†

Zone	COMPLIANCE PATHS		
	Minimum Energy Rating (ER)	or	Maximum U-Factor
1	25	or	≤ 0.28
2	29	or	≤ 0.28
3	34	or	≤ 0.21

†Criteria shown applies to both sliding and hinged doors and in all four climate zones. Doors following the "Maximum U-factor" compliance path do not have a minimum ER requirement.

U-FACTOR CONVERSION	
Imperial	Metric
0.35	2.00
0.32	1.80
0.28	1.60
0.25	1.40
0.21	1.20

Energy Performance Terminology

- ▶ U-Factor refers to a measure of heat transfer through the window or door unit. A lower U-factor means less heat escapes during winter weather, thus reducing heating costs in cold climates.
- ▶ R-Value refers to resistance to heat flow. A high R-value indicates that a window or door has good heat insulating properties.
- ▶ Solar Heat Gain Coefficient (SHGC) is a measure of how much solar energy is passing through the unit's glass. The lower a window or door unit's SHGC, the less solar heat is transmitted into a room, thus allowing for lower cooling bills in hot climates.
- ▶ Visible Transmittance (VT) is a measure of the portion of visible light that passes through a window or door. The higher a window or door unit's VT Total, the more visible light is transmitted into a room. This value is influenced by both the glass selection and by the ratio of glazing and frame area.



Proudly Supplied By

 **ALBUQUERQUE**
WINDOW DOOR AND TRIM

1- 505-823-2505 | www.albuquerquewindowdoortrim.com

KOLBE

WINDOWS & DOORS
We're for the visionaries.®

1323 S. 11th Avenue | Wausau, WI 54401-5998
715.842.5666

www.kolbewindows.com

© 2019 Kolbe & Kolbe Millwork Co., Inc. Kolbe & Kolbe Millwork Co., Inc. reserves the right to change specifications without notice. The photography featured herein does not necessarily imply an endorsement of Kolbe products by the property owners. Photography used may not represent current Kolbe product features and options. Back cover photo provided by Ema Peter Photography. Front cover photo © David Welch Photography.