

EXTERIOR

STEEL & FIBERGLASS DOOR SELECTION GUIDE



RIVERCITYMILLWORK.COM

**RIVER CITY
MILLWORK**

TABLE OF CONTENTS

4	//	Distinct Glass Collections
6	//	Ordering Doors
7	//	Exterior Door Collections
8	//	Entry Systems
10	//	FrameSaver
11	//	Endura Z-Series Sills
12	//	Z-Articulating Cap Sill
13	//	Endura Ultimate Flip Lever Astragal
14	//	Panolock Multi-point Lock
15	//	Exterior Door Prefinish Program
16	//	Masonite® Codes Defined
17	//	VistaGrande® Series
21	//	Heritage Series™
26	//	Modern Door Collection
28	//	Masonite Panels®
30	//	Door Styles Defined
32	//	Masonite Decorative Glass
62	//	Masonite Textured Glass
64	//	Simulated Divided Lites
67	//	Internal & External Grids
73	//	Masonite Clear Glass
76	//	Mini Blinds & Vents
79	//	M-Pwr Smart Doors
80	//	Smooth Steel Doors
82	//	Fast-Frame
86	//	Exterior Millwork
88	//	Door Handing and Swing
89	//	Rough Openings
90	//	Fiberglass Availability
94		Steel Availability
96		Fire-Rated / ADA



COVER DOOR:
Door: Heritage
Double Door with
Marco Glass

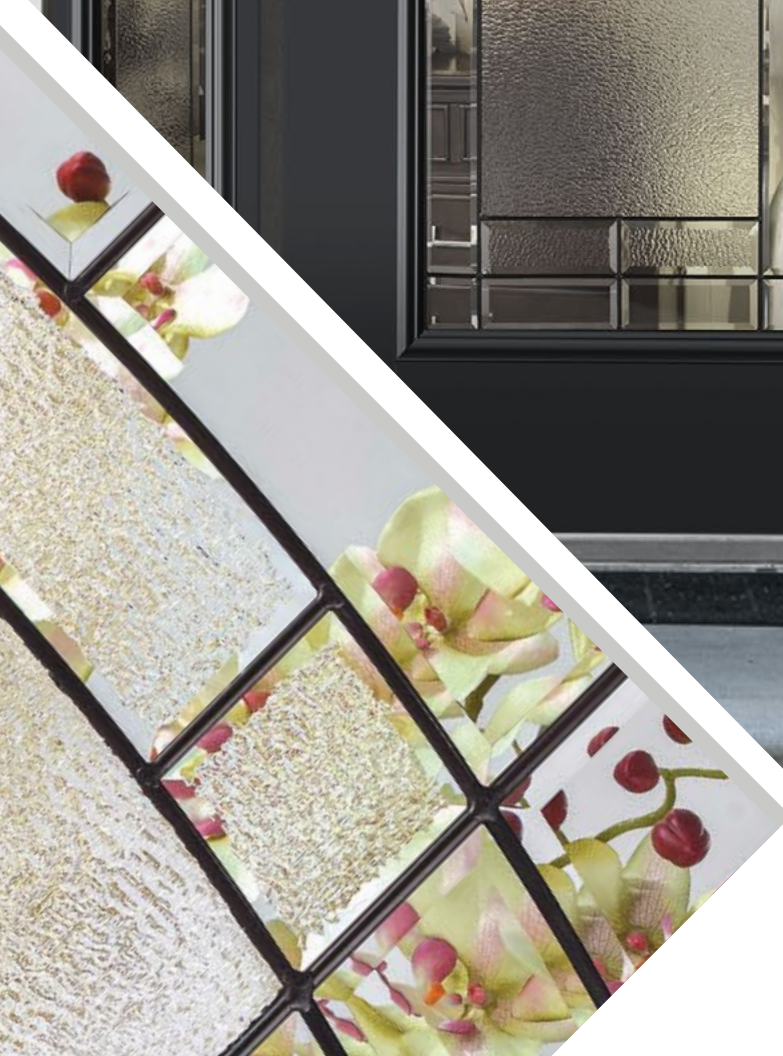

PICTURED DOOR:
Door: HD Steel
with Element Glass

BACK COVER DOOR:
Door: VistaGrande
with Clear Glass
and SDLs



Distinct Glass Collections

FOR EVERY DOOR STYLE

From the authentic charm of the Masonite Winslow to the sleek artistry of the Masonite Expo® series, it has never been easier to find the door to complement your design vision. Choose from hundreds of panel and glass combinations or opt for one of our panel door options.

Not all glass is available in all shapes and sizes. Please consult your sales rep.

DECORATIVE



NEW FOR MID-SUMMER 2022

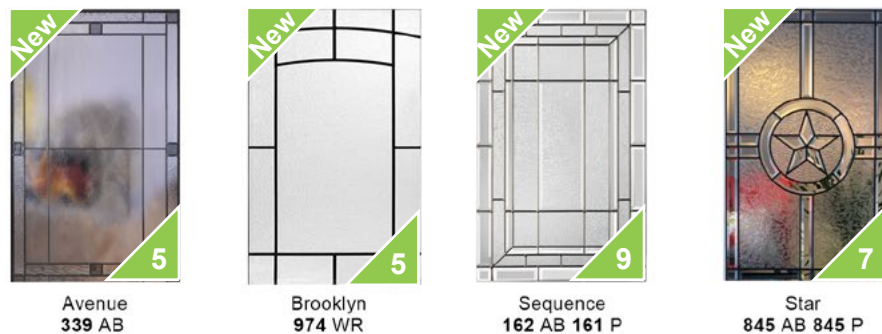

TEXTURED

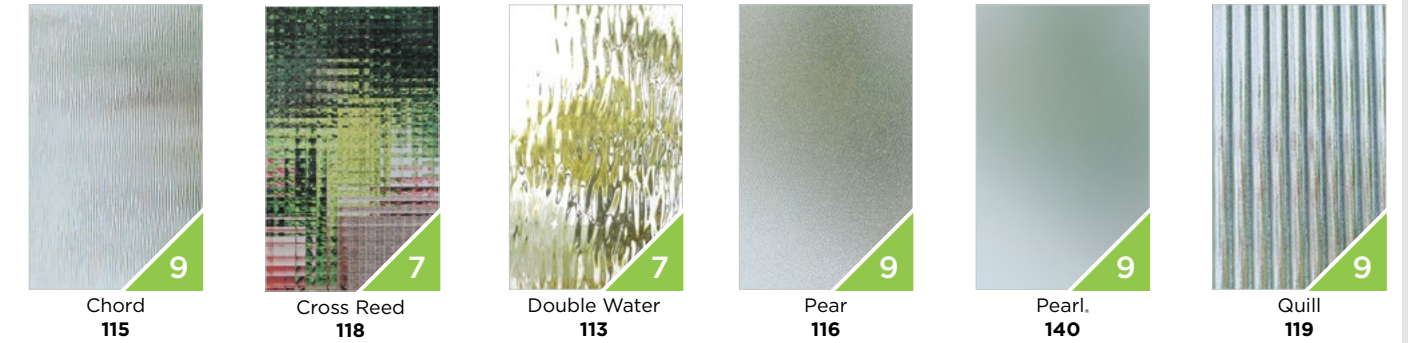

GRIDS



STANDARD



GLASS DESIGN AND CAMING, AND PRIVACY RATING

AB - Antique Black
 BZ - Antique Bronze
 P - Platinum
 B - Brass
 WR - Wrought Iron

Privacy Rating
 1 Least Obscure
 3
 10 Most Obscure

Ordering Doors

1 CHOOSE YOUR DESIGN



2 CHOOSE YOUR MATERIAL



We offer a broad range of Textured Fiberglass, Smooth Fiberglass and Steel.

4 CUSTOMIZE YOUR FRAME SYSTEM



From solid wood frames and components, to our builder-trusted, rot-proof FrameSaver® door frame solutions, we have a frame for every application, including jambs, mulls, and brickmould.

3 CHOOSE YOUR GLASS

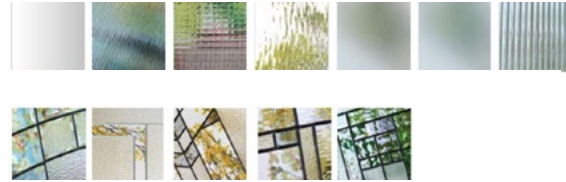

5 CHOOSE YOUR HINGES



Exterior Door Collections

AT A GLANCE

Our dedication to superior craftsmanship allows us to deliver unsurpassed quality and value in both fiberglass and steel entry doors. We offer a comprehensive selection of door styles, finishes and decorative glass options—all crafted with exacting attention to detail.

Vistagrande®
Brighten Your Home
from Front to Back

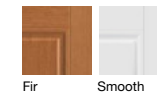

VistaGrande doors offer a wider viewing area and cleaner appearance over traditional glass inserts. Stile and rail features provide an authentic wood door look.

Heritage Series®
Authentic,
Well-Crafted Details

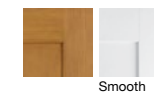

The Heritage Series door collection features authentic Craftsman and historically inspired designs to complement a variety of homes.

Belleville®
The Original Fiberglass

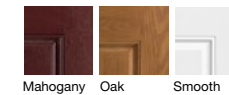

Belleville doors feature distinct architectural details, a reinforced lock area and thousands of customizable glass and panel combinations.

HD Steel
Ready to Paint



Masonite® HD Steel doors come primed and ready to paint. These doors feature high-definition decorative panel profiles that closely replicate the appearance of a high-end wood door with the ultimate in security.

CREATE YOUR DOOR WITH OUR DOOR CONFIGURATOR

Try our configurator at

www.rivercitymillwork.com



- Easy to use
- Customize your door project
- Project summary display
- View, print and email quote
- Save and submit your project

Built With Industry-Leading Components

Entry Systems

MASONITE. DOORS & GLASS



1 TRUE SQUARE COMPOSITE EDGE

Fiberglass doors designed with the square edge details of a real wood door.*

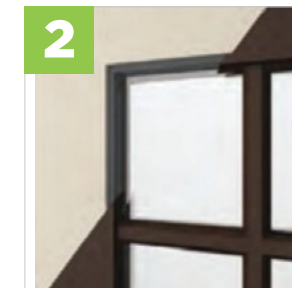

2 POLYURETHANE CORE

Insulates 5x better than real wood for exceptional heat and cold resistance.



3 INSULATED GLASS & LONG-LASTING WARM-EDGE SPACERS

Reduces energy costs and prevents condensation.



4 FIBERGLASS SKIN

Resists warping, rotting, rusting and denting. The composite edge creates a complete barrier surrounding the wood within the door system.



FRAME & COMPONENTS



5 PE650® WEATHERSTRIPPING & SIMPLE SOLUTION® CORNER PAD PATENTED DESIGNS

Seals out air and water.



6 ADJUSTABLE INSWING SILL

All-synthetic components that protect against discoloration, warping and dents.

AVAILABLE UPGRADES



7 FRAMESAVER® DOOR FRAME

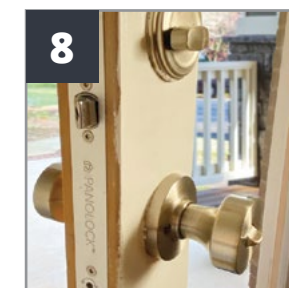

8 PANOLOCK®



9 Z-ARTICULATING CAP SILL™ (Z-AC)

* Note: The image shown is of a door cutout, no wood is exposed on the final product.

It's More Than Just Choosing A Door...

So much happens here beyond just opening and closing, Cleary is combining state of the art Endura technology with the trusted dependability and beauty of Masonite doors for a quality door system you can count on.

FrameSaver

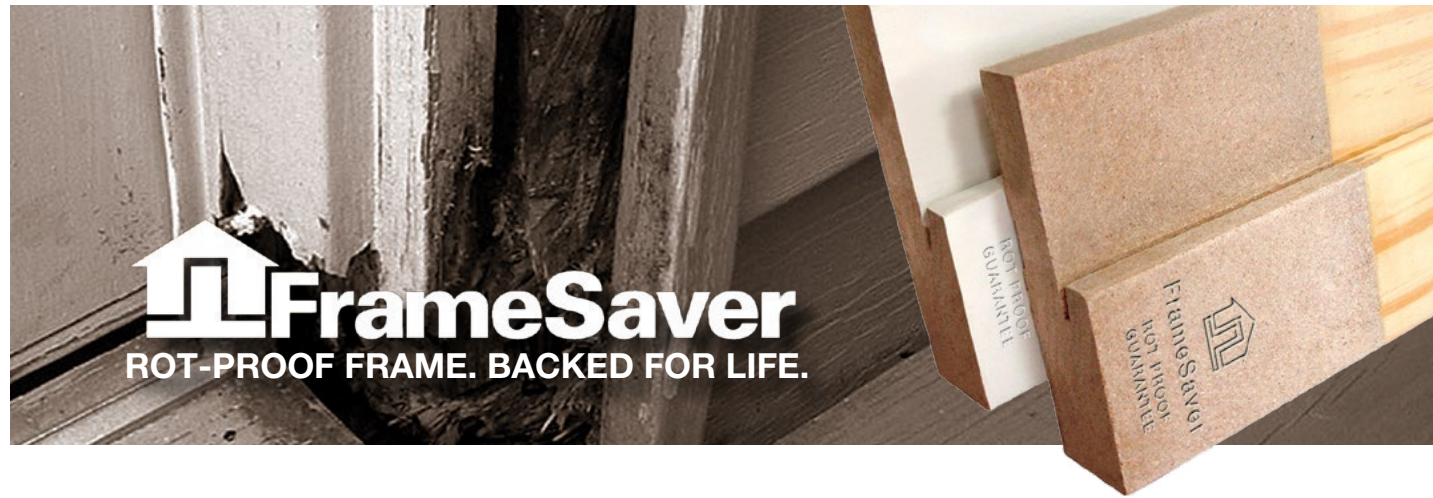

ROOT PROOF FOR LIFE



UNMATCHED WARRANTY



LIKE WOOD. ONLY BETTER



PROVEN STRENGTH

FrameSaver vs. the Competition

FrameSaver vs. Wood:

Wood frames wick water, swell, mold and rot. FrameSaver never rots or molds, and the composite bottom won't wick water or swell.

FrameSaver vs. Treated "Rot-Resistant" Wood:

Rot-resistant wood frames delay rot and mold, but fail to prevent it completely. FrameSaver never wicks water, swells, molds or rots. Ever.

FrameSaver vs. PVC Full-Composite:

Composite frames can't be finished exactly like wood and are flimsy, affected by heat and cold. FrameSaver machines and finishes just like wood, and because FrameSaver is made of real finger-jointed wood, it's durable and unaffected by heat or cold.



Z-Series Sills



Outswing Bumper Sills

Ultimate protection in high exposure areas and severe weather conditions. The seal produced by the Bumper Outswing increases with pressure against the door, creating a tough seal against air and water infiltration.



Adjustable Inswing Sill

All-synthetic components that protect against discoloration, warping and dents. Integrated seals and standard cap plugs help to further enhance performance while eliminating unsightly screws and maintaining adjustability over time.



Continuous Sills

By providing a continuous seal across the door unit, you receive a better fit that prevents leaks. Reposition the active and sidelite caps to create a wide variety of door unit configurations. This allows you to hold your inventory count down.

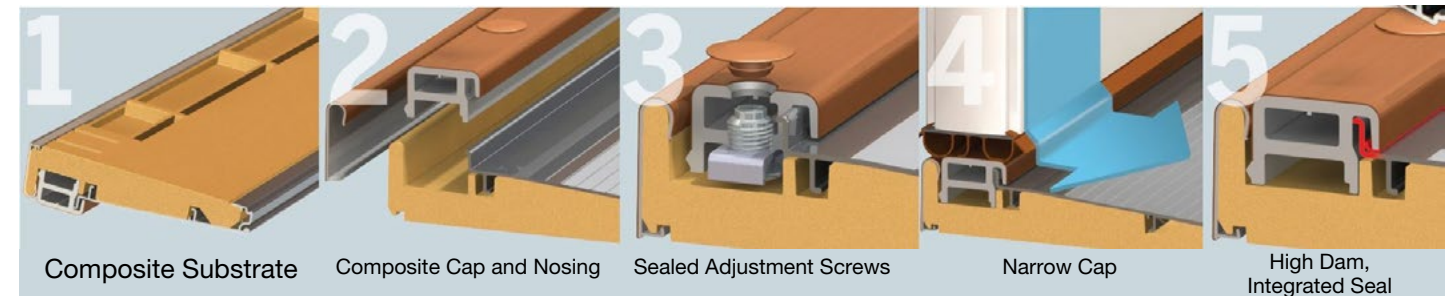

ADA Sill Solutions

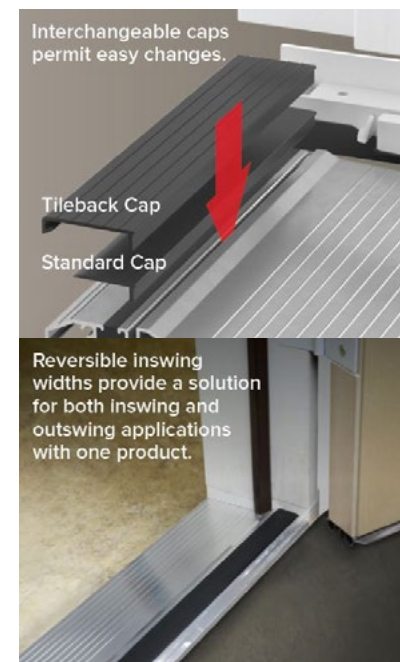

Adaptive Sill System

The ADAptive Sill System protects against door unit failure and resulting service calls with a patent-pending design that achieves unprecedented water-rated performance.

An end to leaks and repairs.

Innovative jamb boot: Features pre-drilled screw locations and, once fasteners are installed, supports a more robust corner assembly.

Pre-applied sealing gasket: Behaves as a sealant between the jamb and sill.

Sealing beak: Positioned beneath the weatherstrip, blocks upward water pressure and resulting water infiltration.

Full-length caulking strip: Provides a full-length barrier against water infiltration beneath the sill.

Upgrade Your Entry Systems



Z-Articulating Cap Sill™ works in the real world.

▶ No Adjustments.

Z-AC never needs adjustment, automatically adjusting for a lasting seal against leaks. No maintenance required.

▶ No Leaks.

Imperfect opening? Missing corner pads? Changing conditions over time? Z-AC still seals, saving you time and money.

▶ No Service Calls.

Z-AC has been tested and proven to outperform all others, even when the real world strikes.



Z-AC eliminates extra installation steps

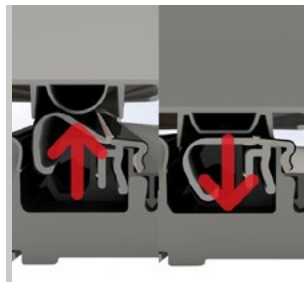

WHO HAS TIME TO ADJUST?

No adjustment needed. Ever. Z-AC's unique articulating cap (2), compensates independently, up or down, +/- 1/8" along the width of the opening to form a consistent seal with the Z-AC Door Bottom (1) and overcome variations in vertical margins.



TROUBLE IN THE STRIKE ZONE?

"Perfect" strike margins of 1/8" rarely exist on installed door units. The Z-AC Z-End Base™ (gasket stiffener) forms a high-performance seal on strike margins of up to 5/32" and continues to work even if margins reach 3/16" (when corner pad is present).

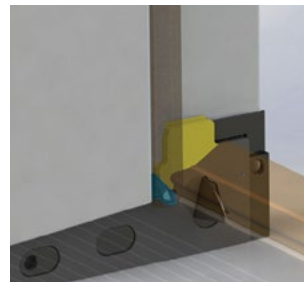

NO CORNER PAD? NO PROBLEM.

The Z-AC Z-End Base (3) provides basic protection from water infiltration by (a) blocking the path of the weatherstrip and (b) providing basic sealing of up to 1/2" above the cap. Rest assured that a door unit with Z-AC will retain a basic seal without corner pads.



OUTPERFORMS ALL OTHER SILLS

Z-AC has been extensively tested and proven to outperform every other sill on the market. Even in real-world conditions where margins are wide and corner pads are missing, Z-AC delivers higher performance in protecting against air and water infiltration.



Ultimate Flip Lever™ Astragal

Effortless Operation. Ultimate Performance.

Endura's Ultimate Flip Lever Astragal delivers superior sealing power and security combined with effortless operation. One flip is all you need to secure your inactive door and keep leaks at bay.

- ▶ **Effortless One-Flip Operation. Enhanced Accessibility:** A single flip of the built-in lever activates both bolts and secures the door. No reaching or bending necessary.
- ▶ **Ultimate Security:** When each of the astragal's bolts are engaged, the inactive door is secured in place. No extra locking steps necessary.
- ▶ **Extended Sealing Power:** Spring-loaded Floating Boot, Simple Solution™ Corner Pad and weatherstrip get an added boost with a full-length Sealing Fin for an extra layer of protection against air and water infiltration.
- ▶ **4-Way Adjustable Strike Retainer**



ALUMINUM & WOOD VENEER FINISHES



*Also available in Compatible Options

Flip Lever: How Does It Work?



FLIP LEVER DOWN.

A single flip of the lever activates both the bolts in one effortless motion. The Spring-loaded Floating Boot securely seals, independently of the bolt, against the sill fighting air and water infiltration, even



FLIP LEVER UP.

Raising the Flip Lever retracts both the bolts. The Spring-loaded Floating Boot lifts clear of the sill preventing wear and damage for problem-free use of the inactive door.

Performance Meets Style

PanoLock works with off-the-shelf handsets.

Whether knob, lever or thumbpress, it works with PanoLock.

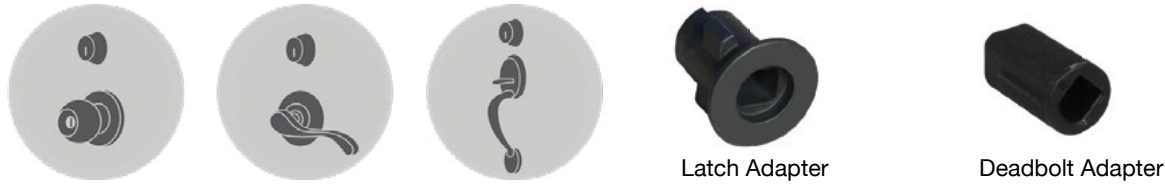

Single Operation System

With no extra deadbolt or latch to operate, PanoLock's three locking points activate with a simple turn of the key. The innovative plug-n-play latch and deadbolt adapters that mate with multiple brands and styles.

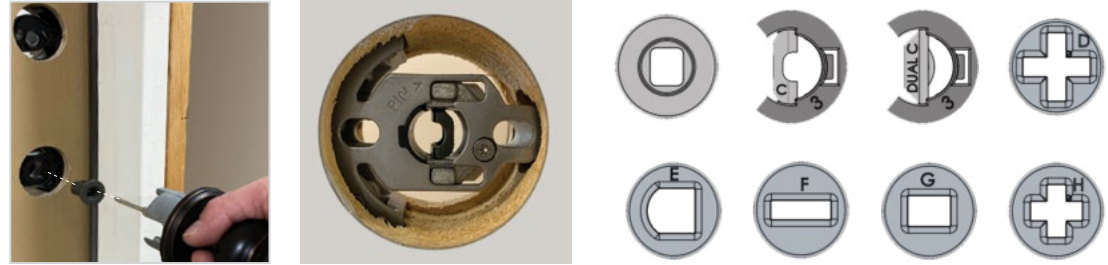

The strength and security of a multi-point lock

Experience enhanced performance and security with three locking points.

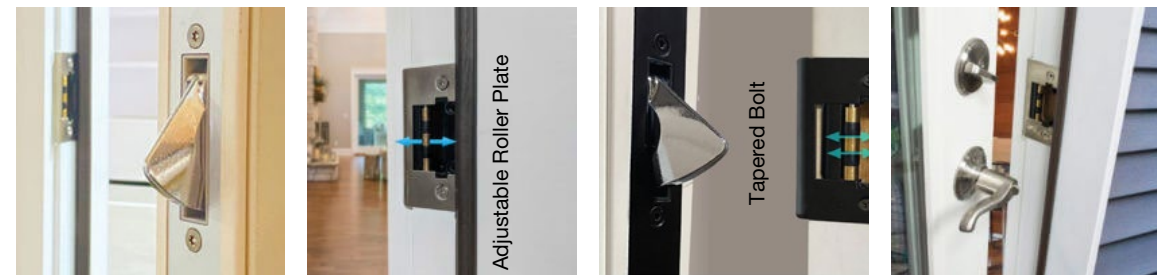

A multi-point for every budget

Available at a more approachable price point.



Exterior Door Stain Pre-Finish Program

Stains For Fiberglass

*Shown on Fir Skin



► All stains can be used on oak, fir, knotty alder, and mahogany skins unless otherwise specified as cherry. The stains listed as "on Cherry" are the only stains available for cherry doors.

Paint Colors

CUSTOM COLORS ARE ALSO AVAILABLE.



► These colors are approximate representations. For a true color representation see color chips at your dealer's counter or through your dealer sales rep.

► Use any **Sherwin Williams** corresponding number or a sample.

► Interior Pre-Finish is available.

10 YEAR LIMITED WARRANTY

Our Pre-Finish Program offers a superior finish over site finished doors and come with a 10-year warranty.

Door Codes Defined

HOW TO CONFIGURE DOOR CODE

Use the formula below to configure a door code.

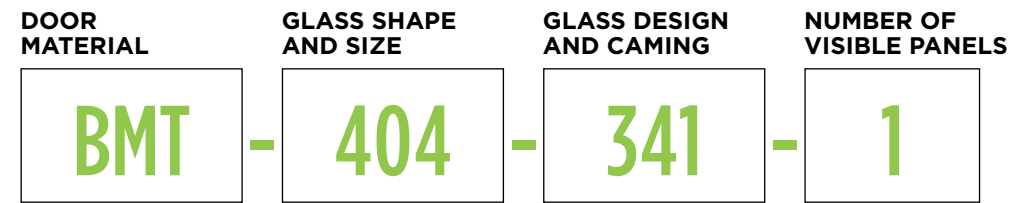

DOOR SPECIES

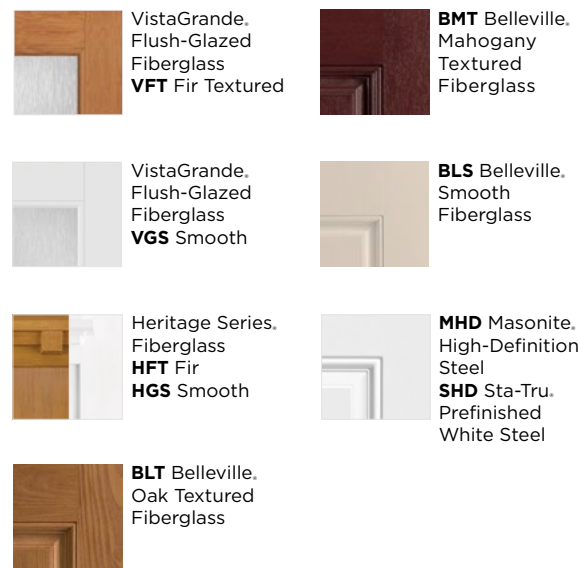

GLASS SHAPE AND SIZE

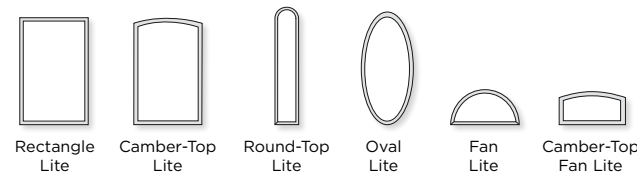

106	22" x 36"	Rectangle	228	22" x 10"	Rectangle
107	22" x 37½"	Camber-Top	300	19" x 56½"	Oval
108	20" x 20"	Rectangle	304	16" x 40¾"	3/4 Oval
114	14" x 64"	Rectangle	404	22" x 48"	Rectangle
120	20" x 64"	Rectangle	426	26" x 48"	Rectangle
122	22" x 64"	Rectangle	450	8" x 48"	Rectangle
129	8" x 36"	Rectangle	617	8" x 17"	Rectangle
135	22" x 10"	Fan	680	8" x 6"	Rectangle
137	22" x 10"	Camber-Top Fan	682	8" x 8"	Rectangle
151	8" x 64"	Rectangle	810	22" x 80"	Rectangle
152	7" x 64"	Rectangle	814	14" x 80"	Rectangle
155	6" x 64"	Rectangle	820	20" x 80"	Rectangle
160	20" x 36"	Rectangle	826	26" x 80"	Rectangle
203	8" x 42"	Round-Top	852	8" x 80"	Rectangle
217	22" x 17"	Rectangle	926	26" x 64"	Rectangle

Note: To be discontinued Jan 2023

GLASS DESIGN & CAMING

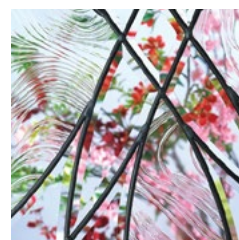

See page 4 for full selection of glass designs and codes

NUMBER OF VISIBLE PANELS

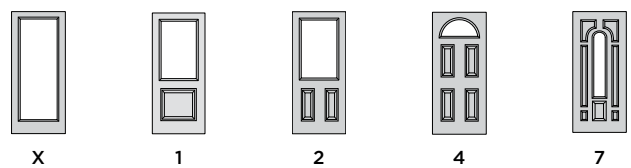

Sample selection of door panels shown

VISTAGRANDE

BRIGHTEN YOUR HOME FROM FRONT TO BACK



VistaGrande® Fir Textured Flush-Glazed Doors with Pearl® Glass and Applied 3-1/2" SDL Bars Door VFT-926-140-S04W-X / Sidelite VFTSL-151-140-T

Masonite VistaGrande. exterior doors create a better living environment by bringing more natural light into any home. Available in a number of glass, SDL and internal grid options, VistaGrande. doors offer a wider viewing area and cleaner appearance over traditional glass inserts.

GLASS OPTIONS:



OPTIONS:



INTERNAL GRID OPTIONS:

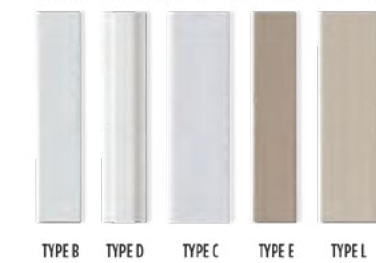

- ▶ 5/8" WHITE TYPE B
- ▶ 5/8" WHITE GEORGIA TYPE D
- ▶ 7/8" WHITE TYPE C
- ▶ 5/8" SANDALWOOD TYPE E
- ▶ 7/8" ALMOND TYPE L

VISTAGRANDE, FIR TEXTURED FLUSH-GLAZED DOORS / CLEAR GLASS / LOW-E



VISTAGRANDE, SMOOTH FLUSH-GLAZED DOORS / CLEAR GLASS / LOW-E



VISTAGRANDE CLEAR GLASS

6'8"							
VFT	•	•	•	•	•	•	•
VSG	•	•	•	•	•	•	•

8'0"						
VFT	•	•	•	•	•	•
VSG	•	•	•	•	•	•

VISTAGRANDE TEXTURED GLASS

6'8"						
Chord	120-115-X	122-115-X	426-115-1	926-115-X	152-115-X	450-115-1
Cross Reed	120-118-X	122-118-X	426-118-1	926-118-X	152-118-X	450-118-1
Double Water	120-113-X	122-113-X	426-113-1	926-113-X	152-113-X	450-113-1
Pearl	120-116-X	122-116-X	426-116-1	926-116-X	152-116-X	450-116-1
Pearl.	120-140-X	122-140-X	426-140-1	926-140-X	152-140-X	450-140-1
Quill.	120-119-X	122-119-X	426-119-1	926-119-X	152-119-X	450-119-1
VFT	•	•	•	•	•	•
VSG	•	•	•	•	•	•

8'0"						
Chord	926-115-1	810-115-X	820-115-X	826-115-X	151-115-1	852-115-X
Cross Reed	926-118-1	810-118-X	820-118-X	826-118-X	151-118-1	852-118-X
Double Water	926-113-1	810-113-X	820-113-X	826-113-X	151-113-1	852-113-X
Pearl	926-116-1	810-116-X	820-116-X	826-116-X	151-116-1	852-116-X
Pearl.	926-140-1	810-140-X	820-140-X	826-140-X	151-140-1	852-140-X
Quill.	926-119-1	810-119-X	820-119-X	826-119-X	151-119-1	852-119-X
VFT	•	•	•	•	•	•
VSG	•	•	•	•	•	•

VISTAGRANDE SDLS

6'8"														
VFT	•	•	•	•	•	•	•	•	•	•	•	•	•	
VSG	•	•	•	•	•	•	•	•	•	•	•	•	•	

8'0"																	
VFT	•	•	•	•	•	•	•	•	•	•	•	•	•	•	•	•	
VSG	•	•	•	•	•	•	•	•	•	•	•	•	•	•	•	•	

8'0"																							
VFT	•	•	•	•	•	•	•	•	•	•	•	•	•	•	•	•	•	•	•	•	•	•	•
VSG	•	•	•	•	•	•	•	•	•	•	•	•	•	•	•	•	•	•	•	•	•	•	•

VISTAGRANDE PRAIRIE

6'8"								8'0"						
VFT	•	•	•	•	•	•	•	•	•	•	•	•	•	•
VSG	•	•	•	•	•	•	•	•	•	•	•	•	•	•

3-1/2" BARS

6'8"							8'0"										
VFT	•	•	•	•	•	•	•	•	•	•	•	•	•	•	•	•	
VSG	•	•	•	•	•	•	•	•	•	•	•	•	•	•	•	•	

CRAFTSMAN GRIDS

6'8"									8'0"										
VFT	•	•	•	•	•	•	•	•	•	•	•	•	•	•	•	•	•	•	•
VSG	•	•	•	•	•	•	•	•	•	•	•	•	•	•	•	•	•	•	•

VISTAGRANDE Mini Blinds

HERITAGE SERIES

AUTHENTIC CRAFTSMAN DETAIL

VISTAGRANDE. FLUSH-GLAZED DOORS / RAISE, LOWER & TILT MINI BLINDS



VFT
Textured
Fiberglass

	6'8"					8'0"				
	120-X	122-X	926-X	152-X	450-1	810-X	820-X	826-X	926-1	852-X
	B120-01RL-X	B122-01RL-X	B926-01RL-X	B152-01RL-X	B450-01RL-1	B810-01RL-X	B820-01RL-X	B826-01RL-X	B926-01RL-1	B852-01RL-X
VFT	•	•	•	•	•	•	•	•	•	•
VSG	•	•	•	•	•	•	•	•	•	•

- ▶ All sizes feature raise, lower and tilt functionality
- ▶ Security channels provide full privacy preventing light gaps when closed (no side or bottom gaps)
- ▶ Frame fits tight to glass—no large gaps
- ▶ Spacer bars not visible in sightline of frame
- ▶ Smoother, easier and more versatile dual-mechanism operation
- ▶ 80" and 96" sidelites available
- ▶ Soft coat LE standard for ENERGY STAR. compliance



▶ VistaGrande® Smooth Fiberglass with Mini Blinds / Doors VSG-B926-01RL-X

Please specify door height and mini blind color when ordering / Mini blinds are available in white (VSG) and tan (VFT) slat colors



Heritage Series™ Smooth Fiberglass with NEW Cross Reed Glass / Door HGS-217-118-2C

▶ Heritage Series™ Fir Fiberglass Doors with Element Glass Door HFT-217-328-2

Masonite's recessed 3 Panel exterior door combines crisp, clean lines inspired by classic craftsman architecture with the proven durability of fiberglass. Select an opaque application for added privacy, or choose from our Element decorative glass collection to fill your entryway with natural light.

GLASS OPTIONS:

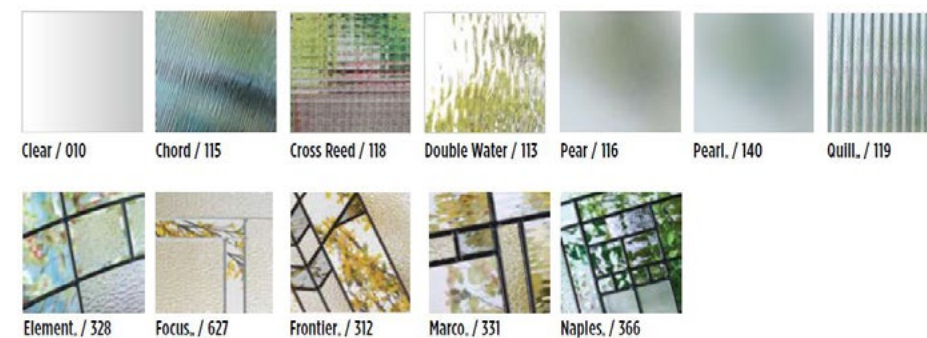

OPTIONS:



HERITAGE SERIES Glass

HERITAGE SERIES™ FIR TEXTURED FIBERGLASS

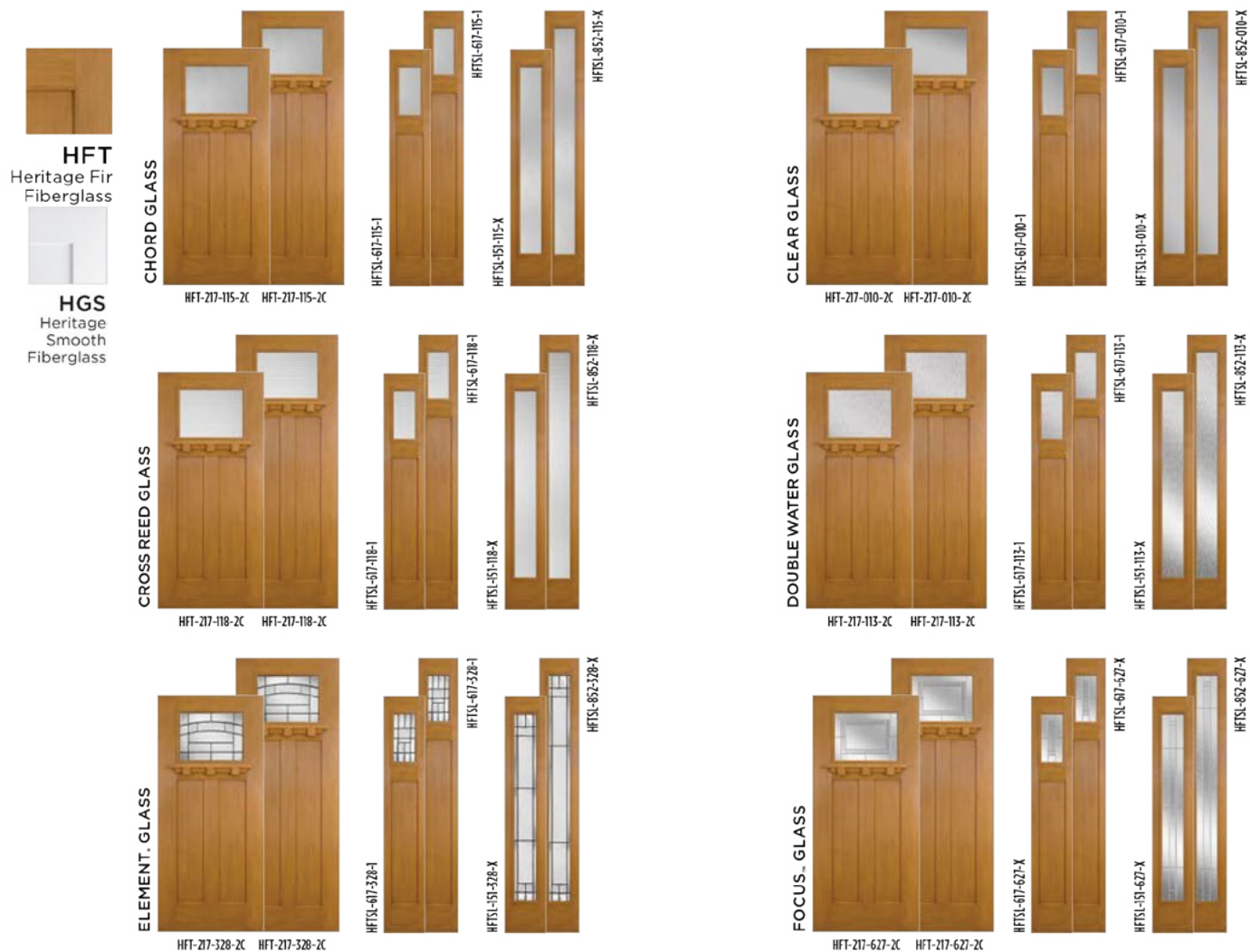

	6'8"				8'0"			
	3C	217-2C	151-X	617-1	3C	217-2C	852-X	617-1
OPAQUE	•				•			
CHORD 115		•	•	•			•	•
CLEAR 010		•	•	•			•	•
CROSS REED 118		•	•	•			•	•
DOUBLE WATER 113		•	•	•			•	•
ELEMENT. 328		•	•	•			•	•
FOCUS. 627		•	•	•			•	•
FRONTIER. 312		•	•	•			•	•
MARCO. 331		•	•	•			•	•
NAPLES. 366		•	•	•			•	•
PEAR 116		•	•	•			•	•
PEARL. 140		•	•	•			•	•
QUILL. 119		•	•	•			•	•

HERITAGE SERIES Glass



HERITAGE SERIES Grids

HERITAGE SERIES™ FIR TEXTURED FIBERGLASS / SIMULATED DIVIDED LITES



HERITAGE SERIES™ FIR TEXTURED FIBERGLASS / INTERNAL GRIDS



HERITAGE SERIES™ FIR TEXTURED FIBERGLASS / EXTERNAL GRIDS



SIMULATED DIVIDED LITES / SDLs

6'8"									8'0"								
	217-502-2C	217-503-2C	217-504-2C	217-506-2C	151-502C-X	151-503C-X	617-502-1	617-504-1		217-502-2C	217-503-2C	217-504-2C	217-506-2C	617-502-1	617-504-1	852-502C-X	852-503C-X
HGS	•	•	•	•	•	•	•	•	•	•	•	•	•	•	•	•	•
HFT	•	•	•	•	•	•	•	•	•	•	•	•	•	•	•	•	•

Please specify door height when ordering. / Doors shown with optional dentil shelf.

Availability is subject to change. Please consult your River City Millwork Rep. for details.

HERITAGE SERIES Grids

HERITAGE SERIES™ SMOOTH FIBERGLASS / SIMULATED DIVIDED LITES

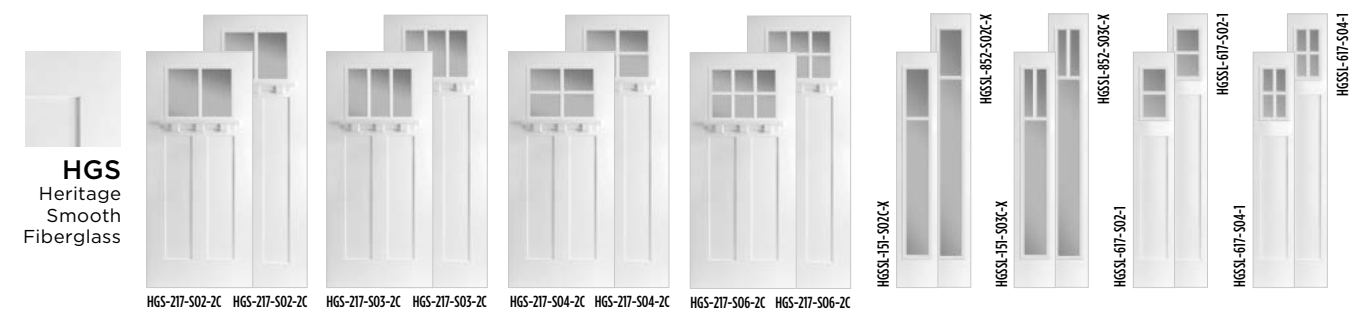

HERITAGE SERIES™ SMOOTH FIBERGLASS / INTERNAL GRIDS



HERITAGE SERIES™ SMOOTH FIBERGLASS / EXTERNAL GRIDS



INTERNAL GRIDS

6'8"						8'0"					
	217-021-2C	217-031-2C	217-041-2C	217-061-2C	617-021-1		217-021-2C	217-031-2C	217-041-2C	217-061-2C	617-021-1C
HGS	•	•	•	•	•	•	•	•	•	•	•
HFT	•	•	•	•	•	•	•	•	•	•	•

EXTERNAL GRIDS

6'8"			8'0"		
	217-03E-2C	217-06E-2C		217-03E-2C	217-06E-2C
HGS	•	•	•	•	
HFT	•	•	•	•	

Be sure to include the 3 letter prefix to your door code based on the type of door skin you want.

MODERN DOOR

BELLEVILLE. OAK TEXTURED FIBERGLASS / SHOWN WITH CLEAR GLASS

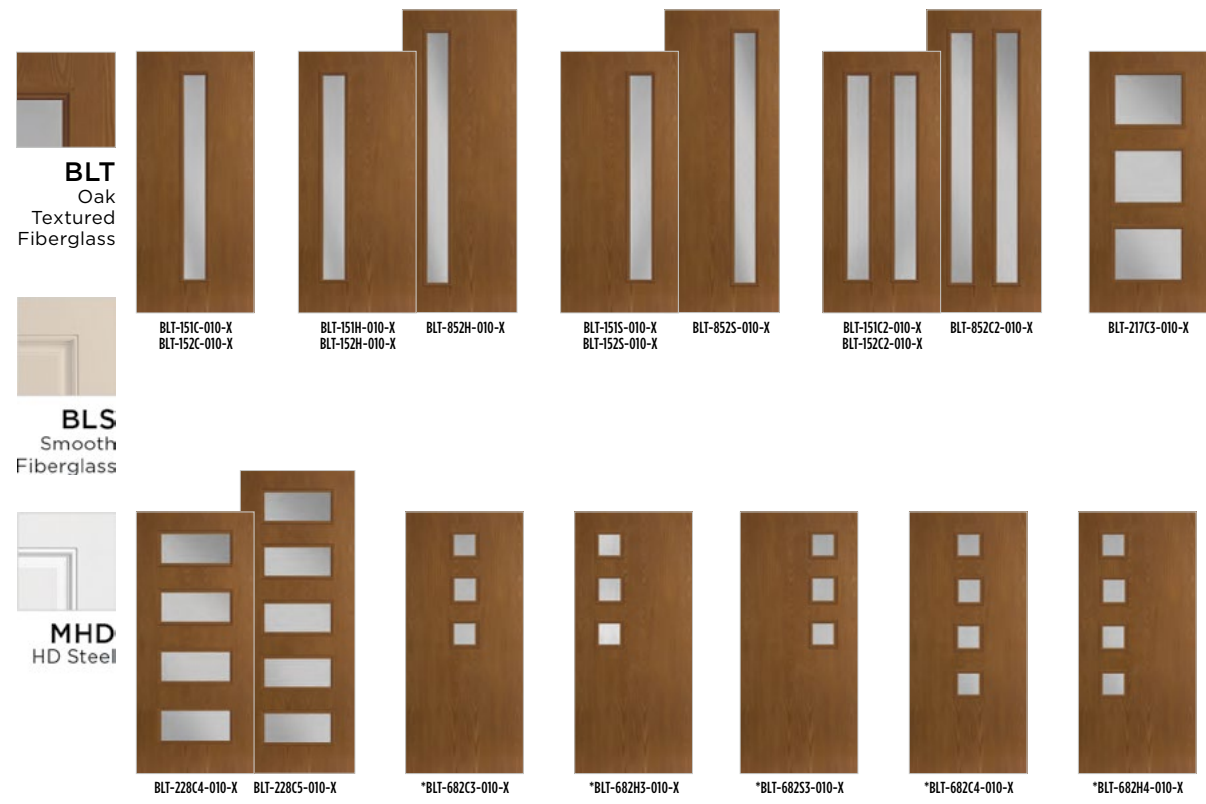

BELLEVILLE. OAK TEXTURED FIBERGLASS / SHOWN WITH CLEAR GLASS

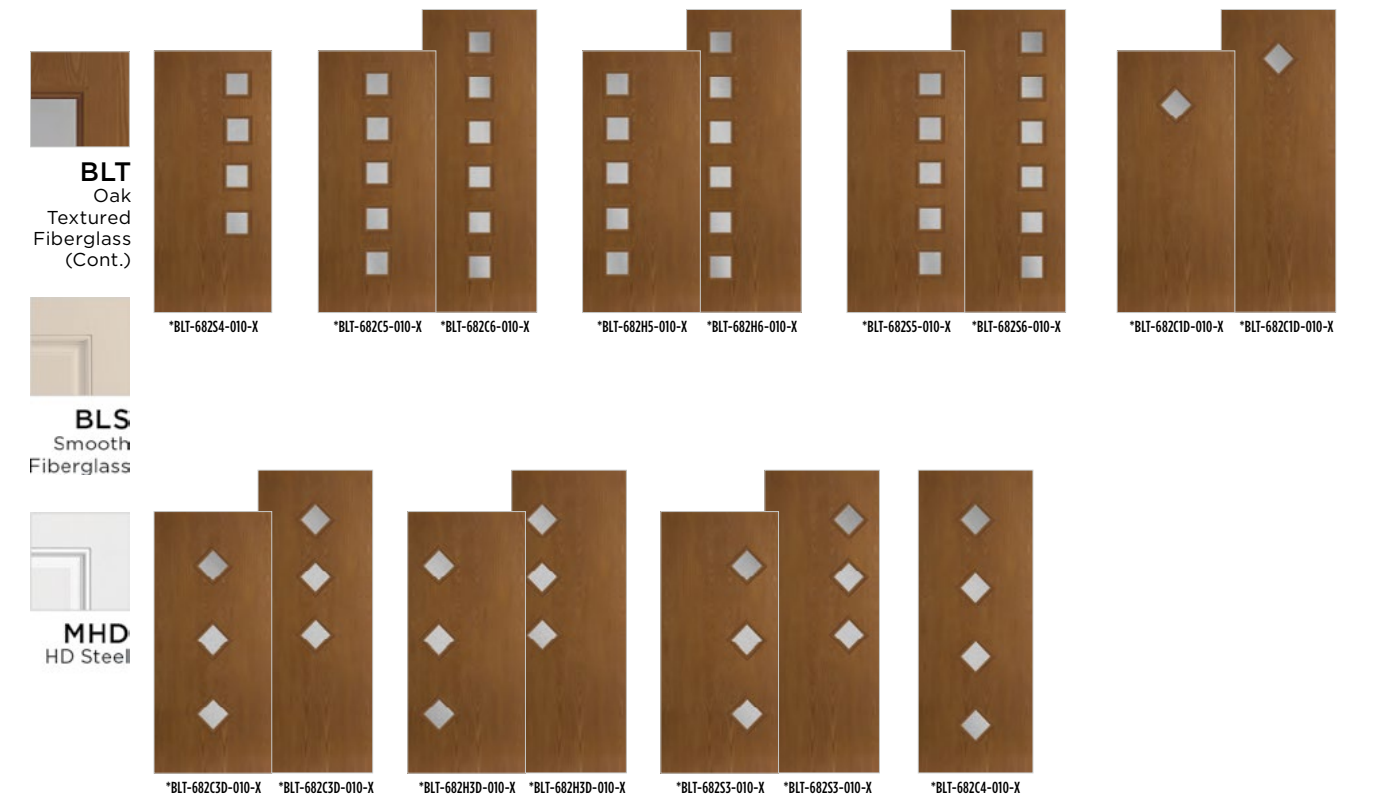

GLASS OPTIONS:



	151H-010-X	152H-010-X	151C-010-X	152C-010-X	151S-010-X	152S-010-X	151C2-010-X	152C2-010-X	217C3-010-X	228C4-010-X	682H3-010-X	682S3-010-X	682C3-010-X	682H4-010-X	682S4-010-X	682C4-010-X	682H5-010-X
Clear	151H-010-X	152H-010-X	151C-010-X	152C-010-X	151S-010-X	152S-010-X	151C2-010-X	152C2-010-X	217C3-010-X	228C4-010-X	682H3-010-X	682S3-010-X	682C3-010-X	682H4-010-X	682S4-010-X	682C4-010-X	682H5-010-X
Chord	151H-115-X	152H-115-X	151C-115-X	152C-115-X	151S-115-X	152S-115-X	151C2-115-X	152C2-115-X	217C3-115-X	228C4-115-X	682H3-115-X	682S3-115-X	682C3-115-X	682H4-115-X	682S4-115-X	682C4-115-X	682H5-115-X
Cross Reed	151H-118-X	152H-118-X	151C-118-X	152C-118-X	151S-118-X	152S-118-X	151C2-118-X	152C2-118-X	217C3-118-X	228C4-118-X	682H3-118-X	682S3-118-X	682C3-118-X	682H4-118-X	682S4-118-X	682C4-118-X	682H5-118-X
Double Water	151H-113-X	152H-113-X	151C-113-X	152C-113-X	151S-113-X	152S-113-X	151C2-113-X	152C2-113-X	217C3-113-X	228C4-113-X	682H3-113-X	682S3-113-X	682C3-113-X	682H4-113-X	682S4-113-X	682C4-113-X	682H5-113-X
Pearl	151H-116-X	152H-116-X	151C-116-X	152C-116-X	151S-116-X	152S-116-X	151C2-116-X	152C2-116-X	217C3-116-X	228C4-116-X	682H3-116-X	682S3-116-X	682C3-116-X	682H4-116-X	682S4-116-X	682C4-116-X	682H5-116-X
Pearl.	151H-140-X	152H-140-X	151C-140-X	152C-140-X	151S-140-X	152S-140-X	151C2-140-X	152C2-140-X	217C3-140-X	228C4-140-X	682H3-140-X	682S3-140-X	682C3-140-X	682H4-140-X	682S4-140-X	682C4-140-X	682H5-140-X
Quill.	151H-119-X	152H-119-X	151C-119-X	152C-119-X	151S-119-X	152S-119-X	151C2-119-X	152C2-119-X	217C3-119-X	228C4-119-X	682H3-119-X	682S3-119-X	682C3-119-X	682H4-119-X	682S4-119-X	682C4-119-X	682H5-119-X
BLT	•	•	•	•	•	•	•	•	•	•	•	•	•	•	•	•	•
BLS	•	•	•	•	•	•	•	•	•	•	•	•	•	•	•	•	•
MHD	•	•	•	•	•	•	•	•	•	•	•	•	•	•	•	•	•
SHD	•	•	•	•	•	•	•	•	•	•	•	•	•	•	•	•	•

	682S5-010-X	682C5-010-X	682C1D-010-X	682C3D-010-X	682H3D-010-X	682S3D-010-X	228C5-010-X	682C1D-010-X	682C3D-010-X	682H3D-010-X	682S3D-010-X	682C4D-010-X	682H6-010-X	682S6-010-X	682C6-010-X	852H-010-X	852S-010-X	852C2-010-X
Clear	682S5-010-X	682C5-010-X	682C1D-010-X	682C3D-010-X	682H3D-010-X	682S3D-010-X	228C5-010-X	682C1D-010-X	682C3D-010-X	682H3D-010-X	682S3D-010-X	682C4D-010-X	682H6-010-X	682S6-010-X	682C6-010-X	852H-010-X	852S-010-X	852C2-010-X
Chord	682S5-115-X	682C5-115-X	682C1D-115-X	682C3D-115-X	682H3D-115-X	682S3D-115-X	228C5-115-X	682C1D-115-X	682C3D-115-X	682H3D-115-X	682S3D-115-X	682C4D-115-X	682H6-115-X	682S6-115-X	682C6-115-X	852H-115-X	852S-115-X	852C2-115-X
Cross Reed	682S5-118-X	682C5-118-X	682C1D-118-X	682C3D-118-X	682H3D-118-X	682S3D-118-X	228C5-118-X	682C1D-118-X	682C3D-118-X	682H3D-118-X	682S3D-118-X	682C4D-118-X	682H6-118-X	682S6-118-X	682C6-118-X	852H-118-X	852S-118-X	852C2-118-X
Double Water	682S5-113-X	682C5-113-X	682C1D-113-X	682C3D-113-X	682H3D-113-X	682S3D-113-X	228C5-113-X	682C1D-113-X	682C3D-113-X	682H3D-113-X	682S3D-113-X	682C4D-113-X	682H6-113-X	682S6-113-X	682C6-113-X	852H-113-X	852S-113-X	852C2-113-X
Pearl	682S5-116-X	682C5-116-X	682C1D-116-X	682C3D-116-X	682H3D-116-X	682S3D-116-X	228C5-116-X	682C1D-116-X	682C3D-116-X	682H3D-116-X	682S3D-116-X	682C4D-116-X	682H6-116-X	682S6-116-X	682C6-116-X	852H-116-X	852S-116-X	852C2-116-X
Pearl.	682S5-140-X	682C5-140-X	682C1D-140-X	682C3D-140-X	682H3D-140-X	682S3D-140-X	228C5-140-X	682C1D-140-X	682C3D-140-X	682H3D-140-X	682S3D-140-X	682C4D-140-X	682H6-140-X	682S6-140-X	682C6-140-X	852H-140-X	852S-140-X	852C2-140-X
Quill.	682S5-119-X	682C5-119-X	682C1D-119-X	682C3D-119-X	682H3D-119-X	682S3D-119-X	228C5-119-X	682C1D-119-X	682C3D-119-X	682H3D-119-X	682S3D-119-X	682C4D-119-X	682H6-119-X	682S6-119-X	682C6-119-X	852H-119-X	852S-119-X	852C2-119-X
BLT	•	•	•	•	•	•	•	•	•	•	•	•	•	•	•	•	•	•
BLS	•	•	•	•	•	•	•	•	•	•	•	•	•	•	•	•	•	•
MHD	•	•	•	•	•	•	•	•	•	•	•	•	•	•	•	•	•	•
SHD	•	•	•	•	•	•	•	•	•	•	•	•	•	•	•	•	•	•

Please specify door height when ordering. / *Belleville. Oak textured Modern door lite frames come unfinished
When ordering Modern doors, please indicate orientation Hinge side (H), Strike side (S), or Center (C).

Availability is subject to change. Please consult your River City Millwork Rep. for details.

Be sure to include the 3 letter prefix to your door code based on the type of door skin you want.



Masonite HD 2 Panel Square Doors
White Steel Front Door with Two Sidelites in Modern Home

DURABLE
AUTHENTIC
VERSATILE



For all Fiberglass and Steel panels see door guide below.

	6'8"	X	2	2ST	2RO	2P	3	3E	3C	4NE	6	8	8'0"	X	2ST	2RO	2P	6	
BMT						•					•	•							•
BFT																			
BLT	•													•					•
MHD	•	•	•	•	•	•	•	•	•	•	•	•	•	•	•	•	•	•	•
BLS	•		•		•						•		•	•					•

Be sure to include the 3 letter prefix to your door code based on the type of door skin you want.

Door Styles Defined



MODERN STYLE

Clean lines, minimal decoration and purposeful materials

Elevate your home by adding a sleek focal point

Symmetric Panel Designs

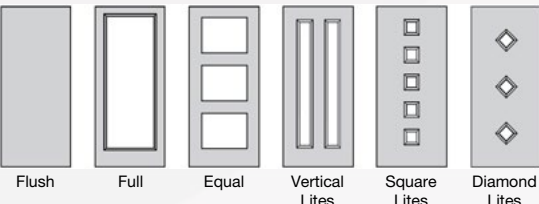

CRAFTSMAN STYLE

Character, authenticity and artisan details that reflect heritage and quality

Welcome guests with a unique handcrafted look

Simple and Geometric Panel Designs

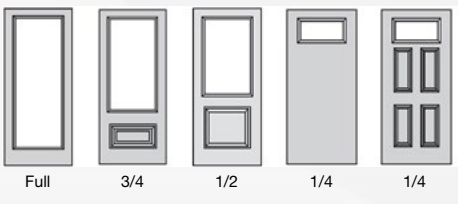

CLASSIC STYLE

Well-balanced elegance inspired by historic details

Create a grand entrance with doors that serve as architectural statements

Symmetric and Decorative Panel Designs

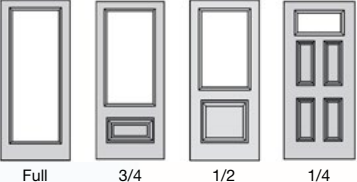

TRANSITIONAL STYLE

A versatile mix of modern and traditional elements

Minimize details for a simple, yet sophisticated feel

Symmetric and Decorative Panel Designs

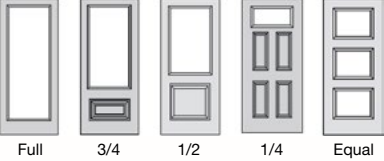

338 - AB
ANTIQUE BLACK



PRIVACY RATING 1 — 9 — 10
Least Obscure — Most Obscure

Clear Beveled Glass
Tempered Nagara Glass (Inside Facing)
Granite Glass
Antique Black Caming
Tempered Water Glass

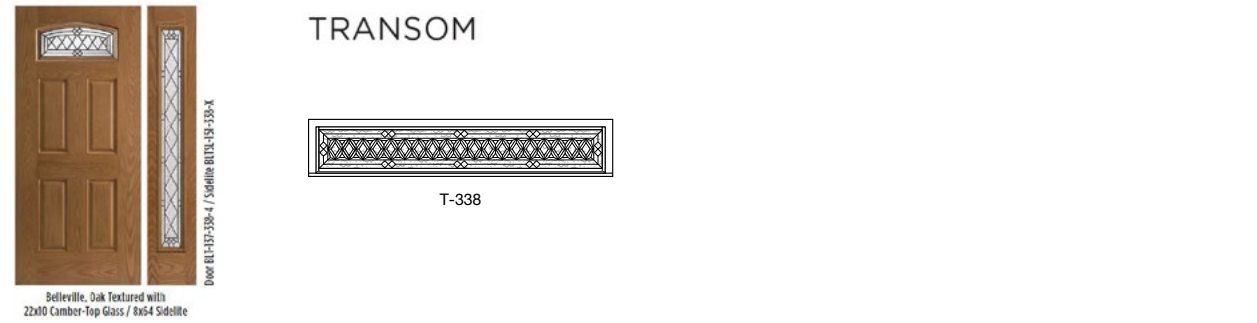
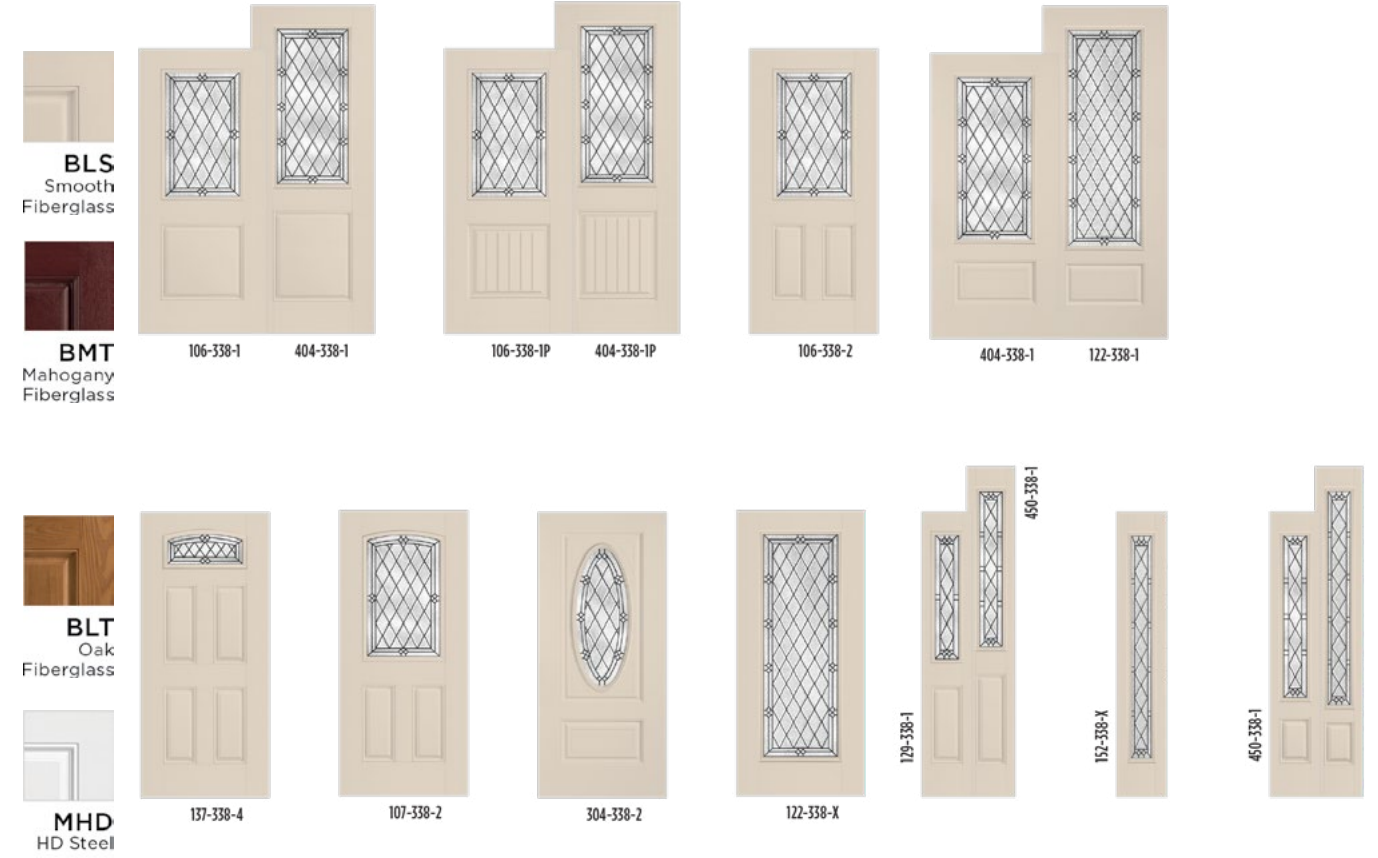

6'8"												
	106-1	106-1P	106-2	107-1	107-1P	107-2	122-X	137-4	304-2	304-3	404-1	404-2
AB	106-338-1	106-338-1P	106-338-2	107-338-1	107-338-1P	107-338-2	122-338-X	137-338-4	304-338-2	304-338-3	404-338-1	404-338-2
BMT		
BLT					
BLS
MHD

6'8"					8'0"							
	129-1	151-X	152-X	450-1		122-1	122-2	404-1	404-1P	404-2	151-1	450-1
AB	129-338-1	151-338-X	152-338-X	450-338-1	122-338-1	122-338-2	404-338-1	404-338-1P	404-338-2	151-338-1	450-338-1	
BMT
BLT
BLS
MHD
SHD

Availability is subject to change. Please consult your River City Millwork Rep. for details.

Be sure to include the 3 letter prefix to your door code based on the type of door skin you want.

Chelsea Glass

341 - AB
ANTIQUE BLACK

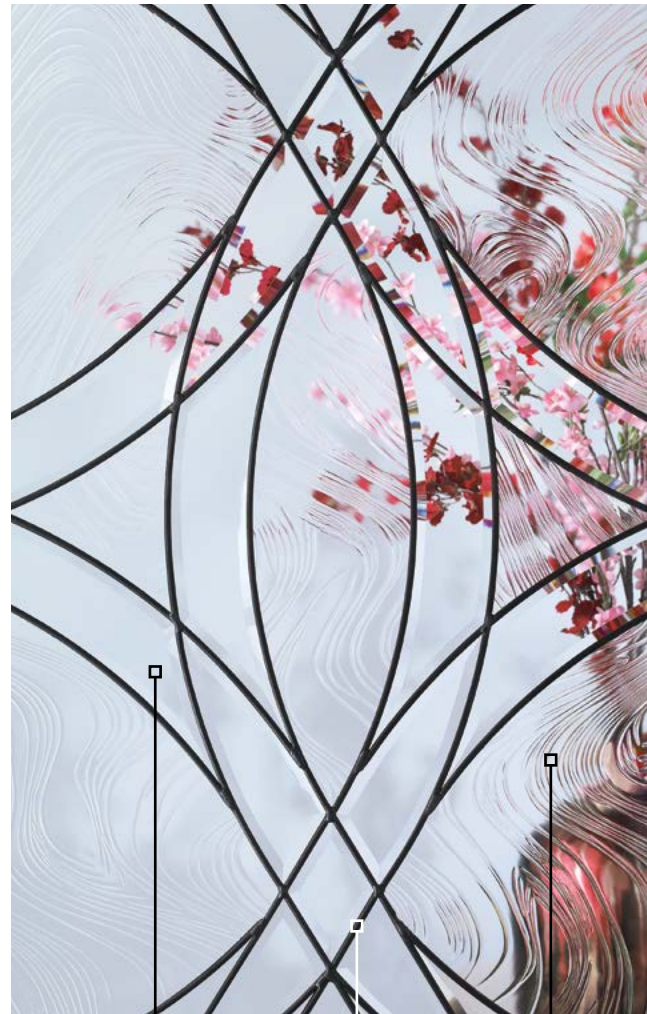
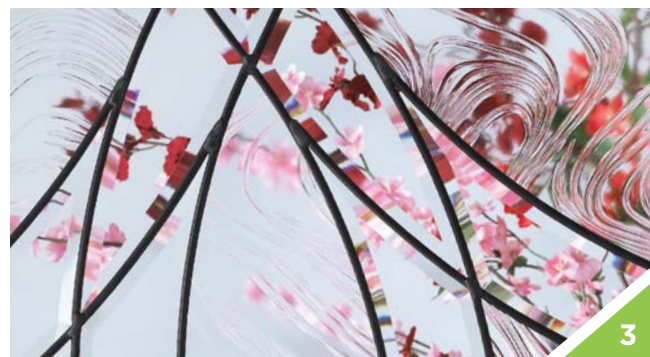

PRIVACY RATING 1 3 10
Least Most
Obscure Obscure

	6'8"						8'0"								
	122-X	404-1	404-2	151-X	152-X	450-1	122-1	122-2	404-1	404-1P	404-2	810-X	151-1	450-1	852-X
AB	122-341-X	404-341-1	404-341-2	151-341-X	152-341-X	450-341-1	122-341-1	122-341-2	404-341-1	404-341-1P	404-341-2	810-341-X	151-341-1	450-341-1	852-341-X
BMT	•	•			•	•						•	•	•	•
BLT	•				•							•	•	•	•
BLS	•	•			•	•	•		•	•	•	•	•	•	•
MHD	•	•	•		•	•		•			•	•	•	•	•
SHD	•	•	•		•	•		•			•	•	•	•	•

Availability is subject to change. Please consult your River City Millwork Rep. for details.

Chelsea Glass

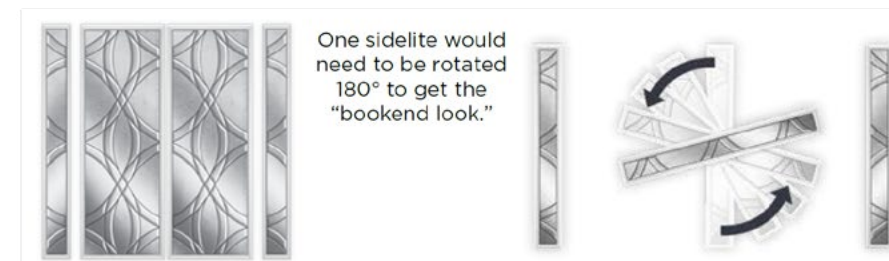

Be sure to include the 3 letter prefix to your door code based on the type of door skin you want.

815-965-9439 | rivercitymillwork.com

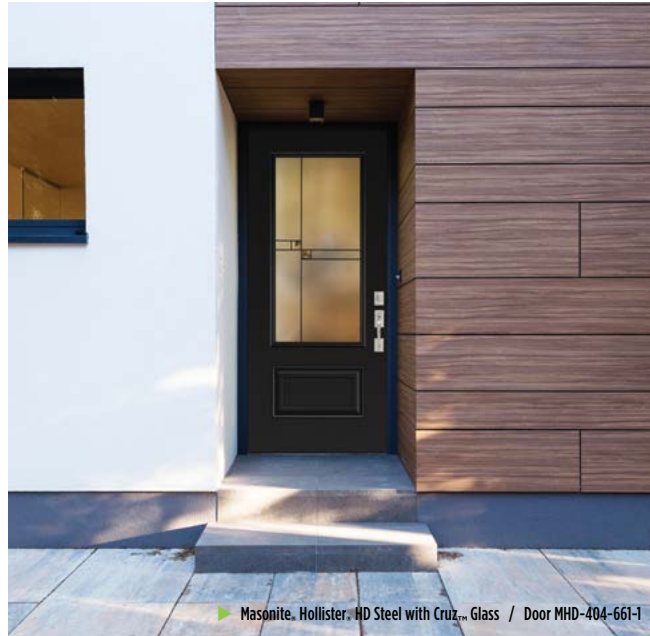

PRIVACY RATING 1 Least Obscure 8 10 Most Obscure

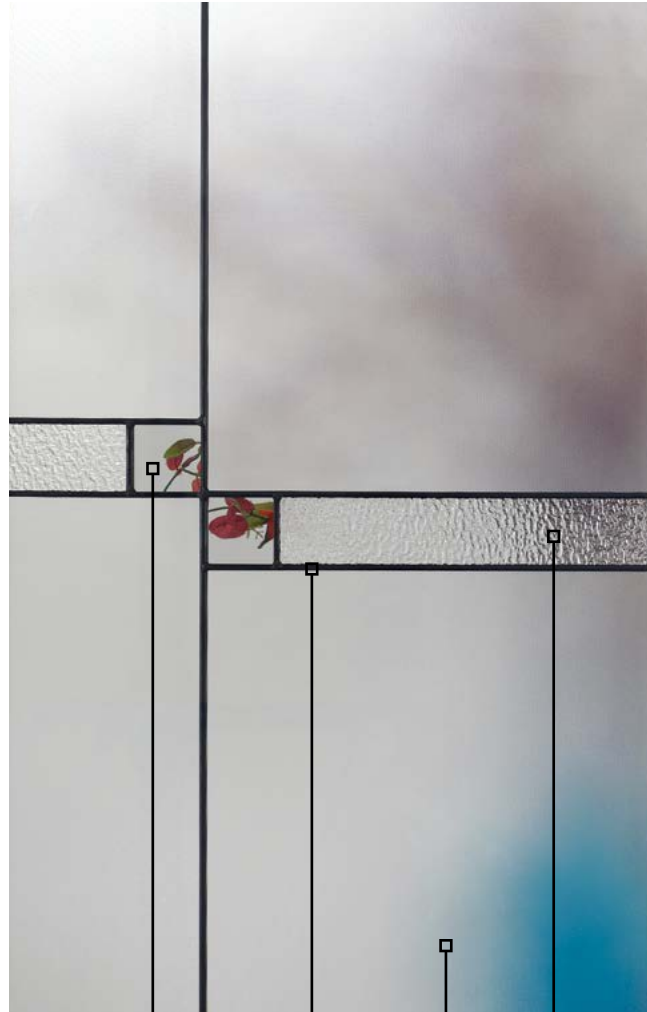

6'8"	Door Models										
	106-1	106-1P	106-2	122-X	228-4	404-1	404-2	129-1	151-X	152-X	450-1
AB	106-661-1	106-661-1P	106-661-2	122-661-X	228-661-4	404-661-1	404-661-2	129-661-1	151-661-X	152-661-X	450-661-1
BMT		•	•	•	•	•		•		•	•
BLT			•	•	•			•		•	
BLS	•	•	•	•	•	•		•		•	
MHD	•	•	•	•	•	•	•	•		•	•
SHD	•	•	•	•	•	•	•	•		•	•

8'0"	Door Models						
	122-1	122-2	404-1	404-1P	404-2	151-1	450-1
AB	122-661-1	122-661-2	404-661-1	404-661-1P	404-661-2	151-661-1	450-661-1
BMT					•	•	•
BLT			•		•	•	•
BLS	•			•	•		•
MHD		•	•		•	•	•
SHD		•			•	•	•

364 - AB
ANTIQUE BLACK

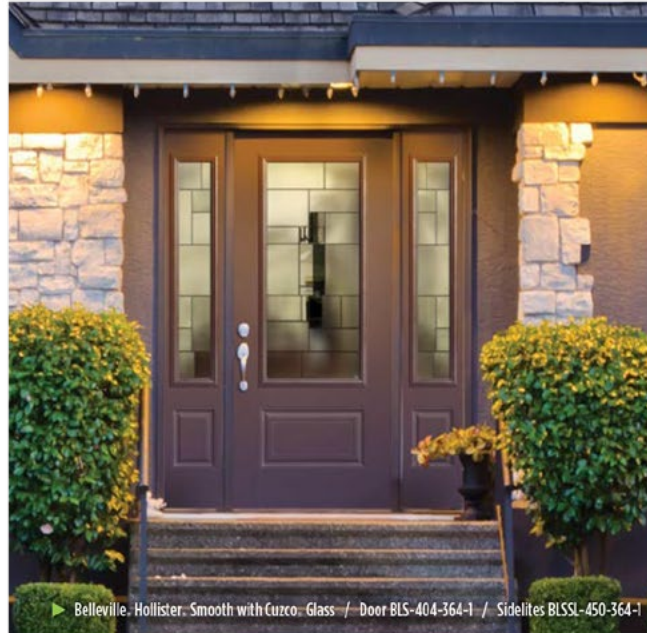

Belleville, Hollister, Smooth with Cuzco Glass / Door BLS-404-364-1 / Sidelites BLSL-450-364-1



PRIVACY RATING 1 Least Obscure — 7 Most Obscure

- Mistlite Glass
- Antique Black Caming
- Seedy Glass
- Dark Gray Beveled Glass
- Clear Beveled Glass
- Dark Gray Glass
- Pear Glass

6'8"									
	106-1	106-1P	106-2	122-X	404-1	404-2	151-X	152-X	450-1
AB	106-364-1	106-364-1P	106-364-2	122-364-X	404-364-1	404-364-2	151-364-X	152-364-X	450-364-1
BMT		•	•	•	•		•	•	•
BLT			•	•			•	•	•
BLS	•	•	•	•	•		•	•	•
MHD	•	•	•	•	•		•	•	•
SHD	•	•	•	•	•	•	•	•	•

Availability is subject to change. Please consult your River City Millwork Rep. for details.



8'0"							
	122-1	122-2	404-1	404-1P	404-2	151-1	450-1
AB	122-364-1	122-364-2	404-364-1	404-364-1P	404-364-2	151-338-1	450-364-1
BMT					•	•	•
BLT					•	•	•
BLS	•		•	•	•	•	•
MHD		•			•	•	•
SHD		•			•	•	•

Be sure to include the 3 letter prefix to your door code based on the type of door skin you want.

327 - AB
ANTIQUE BLACK



PRIVACY RATING 1 — 5 — 10
Least Obscure — Most Obscure

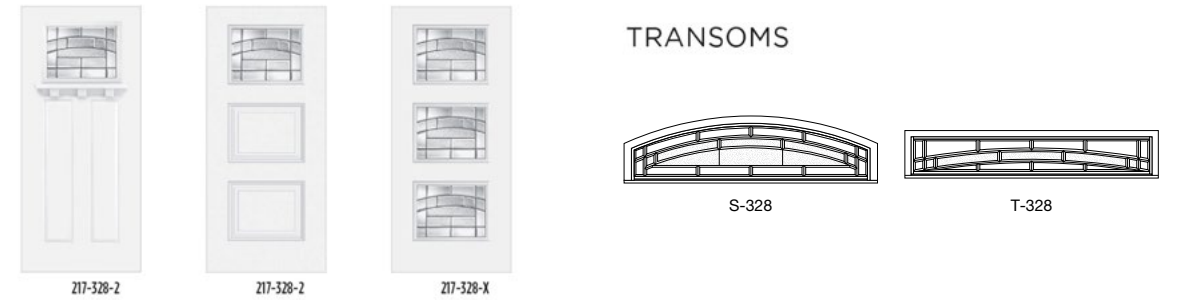
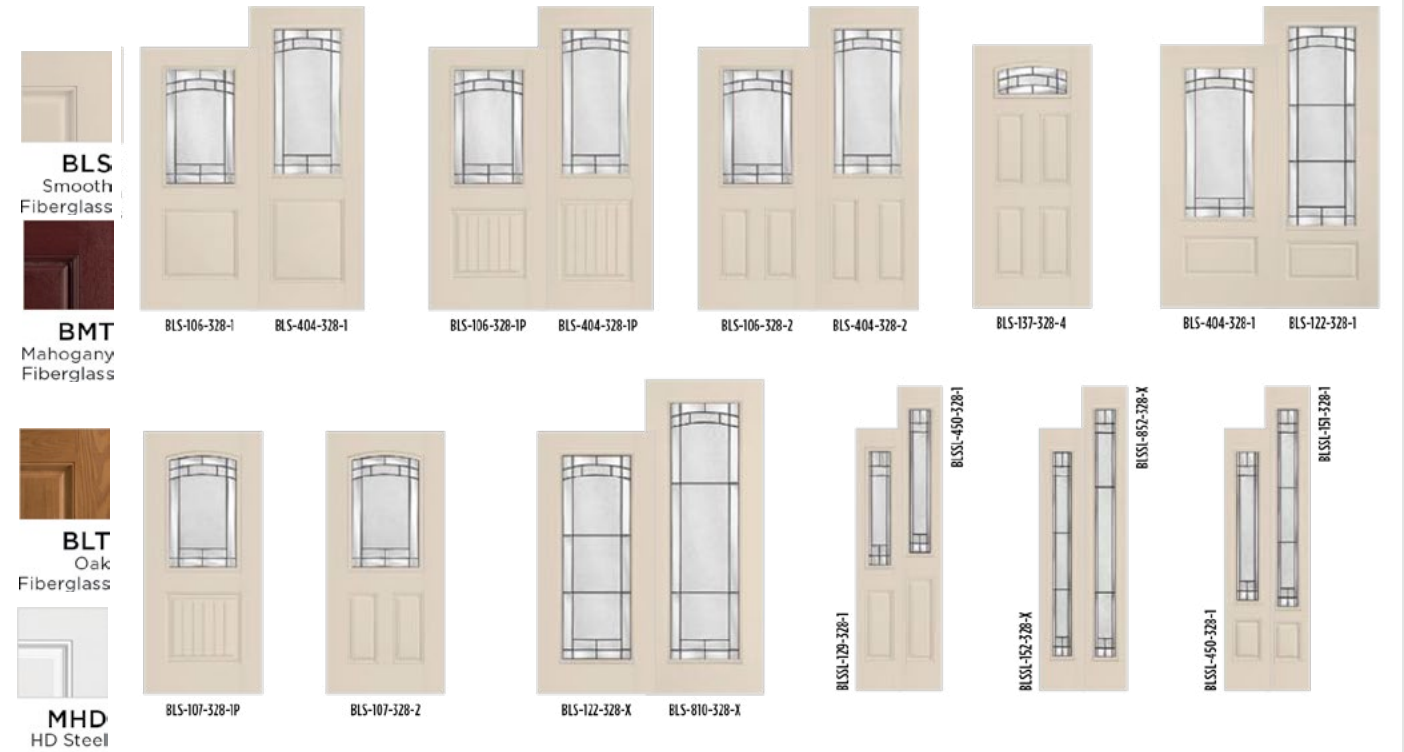

6'8"													
	P 106-327-1	106-327-1P	106-327-2	107-328-1	107-328-1P	107-328-2	122-328-X	137-328-4	217-328-2C	217-328-2	217-328-X	404-327-1	404-327-2
AB	106-328-1	106-328-1P	106-328-2	107-328-1	107-328-1P	107-328-2	122-328-X	137-328-4	217-328-2C	217-328-2	217-328-X	404-328-1	404-328-2
BMT		•	•		•		•					•	
BLT	•		•			•	•	•					•
BLS	•	•	•	•	•	•	•	•				•	•
MHD	•	•	•	•	•	•	•	•	•	•	•	•	•
SHD	•	•	•	•	•	•	•	•	•	•	•	•	•

6'8"						8'0"									
	P 129-327-1			450-327-1			122-328-1	122-328-2	404-327-1	404-327-1P	404-327-2				450-328-1
AB	129-328-1	151-328-X	152-328-X	450-328-1	617-328-1	122-328-1	122-328-2	404-328-1	404-328-1P	404-328-2		810-364-X	151-328-1	450-328-1	852-364-X
BMT	•		•	•							•	•	•	•	•
BLT	•		•							•	•	•	•	•	•
BLS	•		•	•		•		•	•	•	•	•	•	•	•
MHD	•		•	•	•	•	•	•	•	•	•	•	•	•	•
SHD	•		•	•	•	•	•	•	•	•	•	•	•	•	•

Availability is subject to change. Please consult your River City Millwork Rep. for details.

Be sure to include the 3 letter prefix to your door code based on the type of door skin you want.



PRIVACY RATING 1 — 5 — 10
Least Obscure — Most Obscure

6'8"	Door Models											
	106-1	106-1P	106-2	122-X	217-2C	217-2	217-X	228-4	404-1	404-2	151-X	152-X
P	106-627-1	106-627-1P	106-627-2	122-627-X	217-627-2C	217-627-2	217-627-X	228-627-4	404-627-1	404-627-2	151-627-X	152-627-X
BMT		•	•	•				•	•			•
BLT			•	•				•				•
BLS	•	•	•	•				•	•			•
MHD	•	•	•	•	•	•	•	•	•	•		•
SHD	•	•	•	•	•	•	•	•	•	•		•

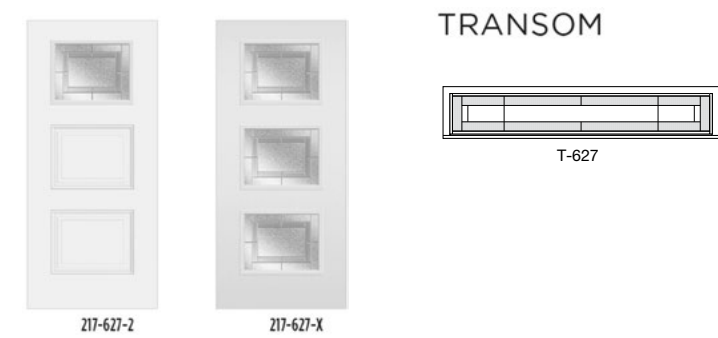

8'0"	Door Models					
	122-1	122-2	404-1	404-1P	404-2	151-1
P	122-627-1	122-627-2	404-627-1	404-627-1P	404-627-2	151-627-1
BMT					•	•
BLT					•	
BLS	•		•	•	•	•
MHD		•	•		•	•
SHD		•			•	•

312 - AB
ANTIQUE BLACK



PRIVACY RATING 1 — 4 — 10
Least Obscure — Most Obscure

Pear Glass
Gray Water Glass
Seedy Glass
Antique Black Caming



6'8"	106-1	106-1P	106-2	217-2C	217-2	217-X	228-4	404-1	404-2	129-1	151-X	152-X	450-1
AB	106-312-1	106-312-1P	106-312-2	217-312-2C	217-312-2	217-312-X	228-312-4	404-312-1	404-312-2	129-312-1	151-312-X	152-312-X	450-312-1
BMT		•	•				•	•		•		•	•
BLT			•							•		•	•
BLS	•	•	•				•	•		•		•	•
MHD	•	•	•	•	•	•	•	•	•	•		•	•
SHD	•	•	•	•	•	•	•	•	•	•		•	•

8'0"	404-1	404-1P	404-2	151-1	450-1
AB	404-312-1	404-312-1P	404-312-2	151-312-1	450-312-1
BMT			•	•	•
BLT			•	•	•
BLS	•	•	•	•	•
MHD	•		•	•	•
SHD			•	•	•

Georgian® Glass

515 - / 517 - P
BRASS CAMING / PLATINUM CAMING (SHOWN)



PRIVACY RATING 1 3 10
Least Obscure Most Obscure



Georgian® Glass

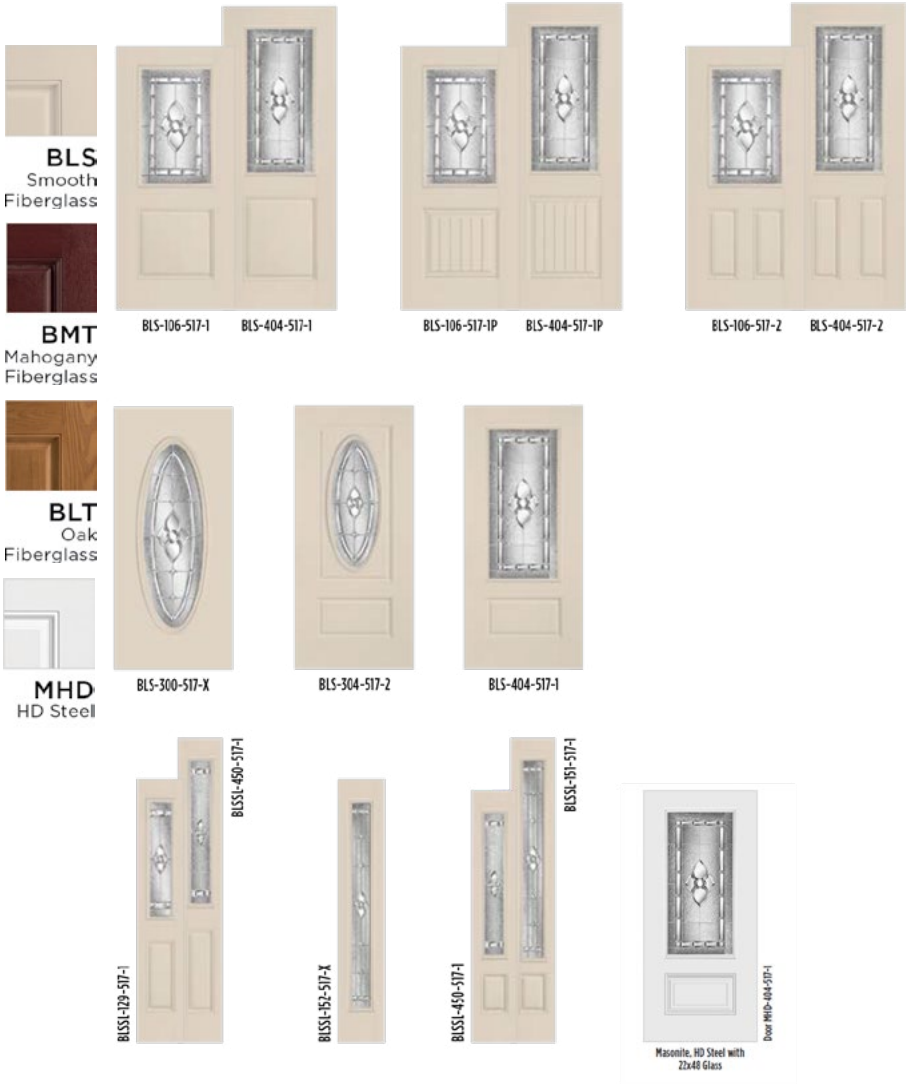

6'8"								
	B 106-515-1	106-515-1P	106-515-2	300-517-X	304-515-2	304-515-3	404-515-1	404-515-2
P	106-517-1	106-517-1P	106-517-2	304-517-2	304-517-3	404-517-1	404-517-2	
BMT		•	•		•		•	
BLT			•					
BLS	•	•	•	•	•		•	
MHD	•	•	•	•		•	•	•
SHD	•	•	•	•		•	•	•

6'8"					8'0"					
	B 129-515-1		152-515-X	450-515-1		404-515-1	404-515-1P	404-515-2		450-515-1
P	129-517-1	151-517-X	152-517-X	450-517-1	404-517-1	404-517-1P	404-517-2		151-517-1	450-517-1
BMT	•		•	•				•	•	•
BLT	•		•					•		•
BLS	•		•			•	•	•	•	•
MHD	•		•	•		•		•	•	•
SHD	•		•	•				•	•	•

Availability is subject to change. Please consult your River City Millwork Rep. for details.

Be sure to include the 3 letter prefix to your door code based on the type of door skin you want.

Iron Springs® Glass

918 - WR
WROUGHT IRON



Belleville® Smooth with Iron Springs® Glass and Wrought Iron Frame / Door BLS-122-918-X



PRIVACY RATING 1 — 9 — 10
Least Obscure — Most Obscure

Tempered Pear Glass (Inside Facing)
Wrought Iron

Iron Springs® Glass

BLS Smooth Fiberglass
BMT Mahogany Fiberglass
BLT Oak Fiberglass
MHD HD Steel

Door BLS-106-918-1P, BMT-106-918-2, BMT-404-918-2, BMT-122-918-X, BMT-404-918-1, BMT-122-918-1, BMTS-151-918-1, BMTS-852-918-X
BLT-106-918-1, BLT-404-918-1, BLT-106-918-2, BLT-404-918-2, BLT-122-918-X, BLT-404-918-2, BLTS-151-918-1, BLTS-852-918-X
Belleville, Smooth with 22x64 Glass, Door BLS-106-918-1, Belleville, HD Steel with 22x48 Glass, Door MHD-404-918-2, 8' Belleville, Smooth with 22x64 Glass / 6x54 SideLite, Door BLS-102-918-1 / 151/852-BLS-852-918-1

Masonite offers a full design configuration for Kordella. Please specify left or right when ordering, as different part numbers are required.

6'8"	6'8" Options							8'0" Options								
	106-1	106-1P	106-2	122-X	404-1	404-2	151-X	152-X	122-1	122-2	404-1	404-1P	404-2	810-X	151-1	852-X
WR	106-918-1	106-918-1P	106-918-2	122-918-X	404-918-1	404-918-2	151-918-X	152-918-X	122-918-1	122-918-2	404-918-1	404-918-1P	404-918-2	810-918-X	151-918-1	852-918-X
BMT		•	•	•	•			•					•	•	•	•
BLT			•	•		•		•					•	•	•	•
BLS	•	•	•	•	•	•		•			•	•	•	•	•	•
MHD	•	•	•	•	•	•		•		•			•	•	•	•
SHD	•	•	•	•	•	•		•		•			•	•	•	•

6'8"	6'8" Options							8'0" Options						
	106-1	106-1P	106-2	122-X	404-1	404-2	151-X	122-1	404-1	404-1P	404-2	151-1	852-X	
WR	106-918-1	106-918-1P	106-918-2	122-918-X	404-918-1	404-918-2	151-918-X	122-918-1	404-918-1	404-918-1P	404-918-2	151-918-1	852-918-X	
BMT								•						
BLT	•								•					
BLS	•	•	•	•	•	•		•	•	•	•	•	•	

Kordella® Glass

686 - AB
ANTIQUE BLACK

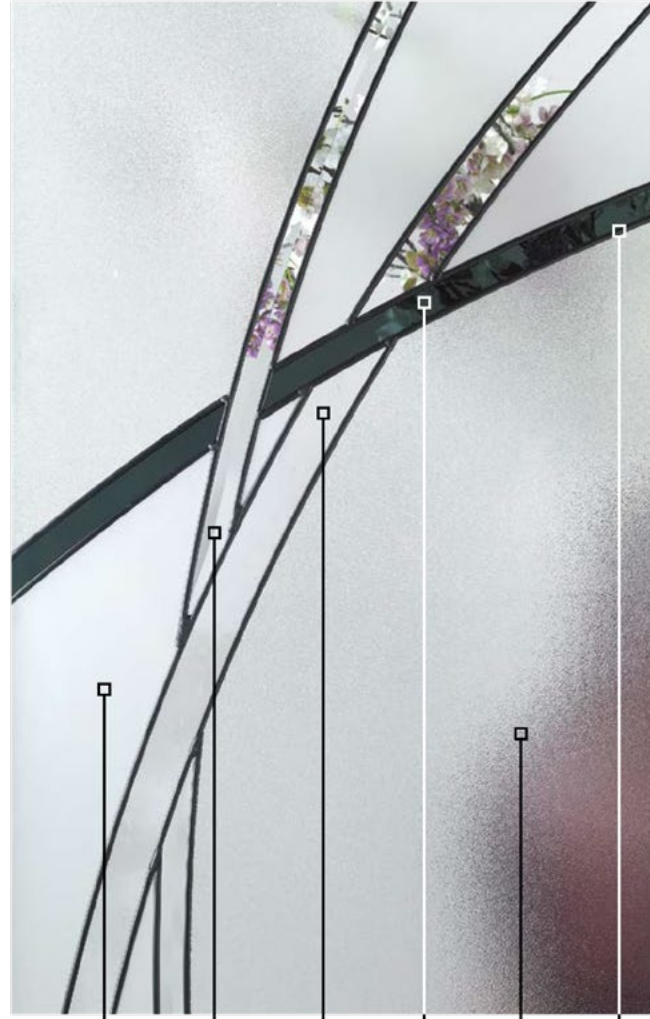

PRIVACY RATING 1 — 8 — 10
Least Obscure — Most Obscure

White Etched Glass
Clear Beveled Glass
Seed Glass
Dark Gray Glass
Pear Glass
Antique Black Caming

6'8"	Glass Pattern								
	106-1	106-1P	106-2	122-X	404-1	404-2	151-X	152-X	450-1
AB	106-686-1	106-686-1P	106-686-2	122-686-X	404-686-1	404-686-2	151-686-X	152-686-X	450-686-1
BMT		•	•	•	•		•	•	•
BLT			•	•			•	•	•
BLS	•	•	•	•	•		•	•	•
MHD	•	•	•	•	•		•	•	•
SHD	•	•	•	•	•		•	•	•

Availability is subject to change. Please consult your River City Millwork Rep. for details.

Kordella® Glass

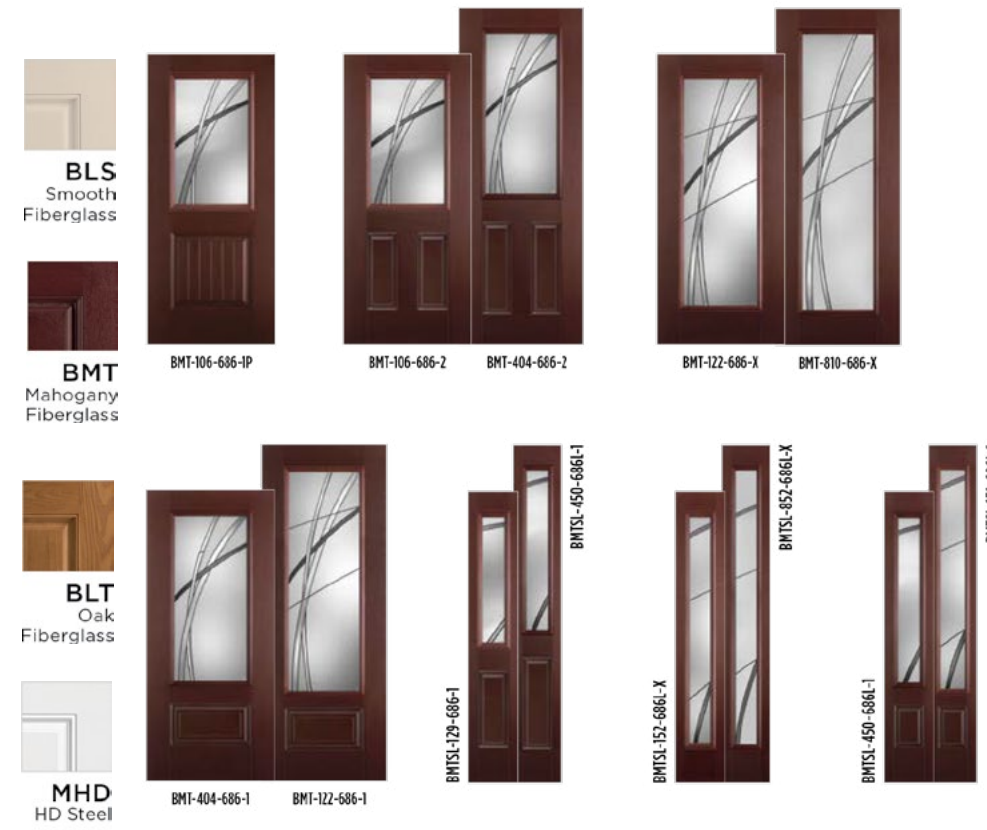

Masonite offers a full design configuration for Kordella. Please specify left or right when ordering, as different part numbers are required.

8'0"	Glass Pattern								
	122-1	122-2	404-1	404-1P	404-2	810-X	151-1	450-1	852-X
AB	122-686-1	122-686-2	404-686-1	404-686-1P	404-686-2	810-686-X	151-686-1	450-686-1	852-686-X
BMT	•					•	•	•	•
BLT					•	•	•	•	•
BLS	•		•	•	•	•	•	•	•
MHD		•	•		•	•	•	•	•
SHD		•			•	•	•	•	•

Be sure to include the 3 letter prefix to your door code based on the type of door skin you want.

331 - AB
ANTIQUE BLACK



PRIVACY RATING 1 — 4 — 10
Least Obscure — Most Obscure

Granite Glass
Antique Black Caming
Grey Water Glass
Seedy Glass
Clear Water Glass

6'8"	Door Styles													
	106-1	106-1P	106-2	217-2C	217-2	217-X	228-4	404-1	404-2	129-1	151-X	152-X	450-1	617-1
AB	106-331-1	106-331-1P	106-331-2	217-331-2C	217-331-2	217-331-X	228-331-4	404-331-1	404-331-2	129-331-1	151-331-X	152-331-X	450-331-1	617-331-1
BMT		•	•				•	•		•		•	•	
BLT			•				•			•		•	•	
BLS	•	•	•				•	•		•		•	•	
MHD	•	•	•	•	•	•	•	•	•	•	•	•	•	•
SHD	•	•	•	•	•	•	•	•	•	•	•	•	•	•

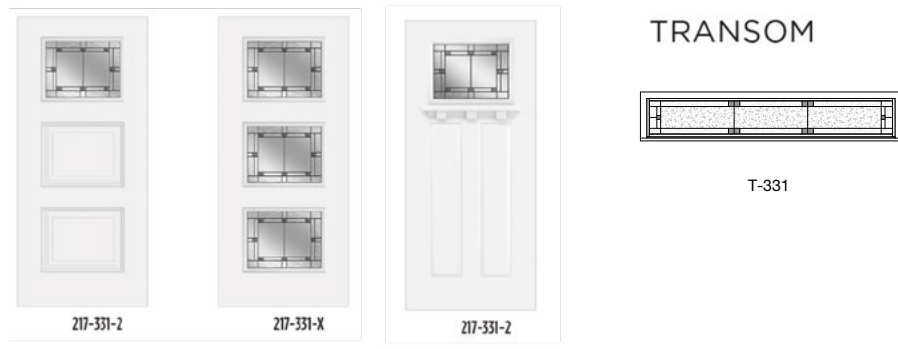

8'0"	Door Styles				
	404-1	404-1P	404-2	151-1	450-1
AB	404-331-1	404-331-1P	404-331-2	151-331-1	450-331-1
BMT			•	•	•
BLT			•	•	•
BLS	•	•	•	•	•
MHD	•		•	•	•
SHD			•	•	•

366 - AB
ANTIQUE BLACK



Masonite, HD Steel 3P Equal with Naples Glass / Door MHD-217-366-X / SideLite MHD5L-152-366-X



PRIVACY RATING 1 — 6 — 10
Least Obscure — Most Obscure

Clear Beveled Glass
Narrow Reed Glass
Antique Black Caming
Granite Glass

6'8"											
	106-1	106-1P	106-2	122-X	203-7	217-2C	217-2	217-X	228-4	404-1	404-2
AB	106-366-1	106-366-1P	106-366-2	122-366-X	203-366-7	217-366-2C	217-366-2	217-366-X	228-366-4	404-366-1	404-366-2
BMT		•	•	•	•				•	•	
BLT			•	•					•		
BLS	•	•	•	•					•	•	
MHD	•	•	•	•	•	•	•	•	•	•	•
SHD	•	•	•	•	•	•	•	•	•	•	•

BLS
Smooth
Fiberglass

BMT
Mahogany
Fiberglass

BLT
Oak
Fiberglass

MHD
HD Steel

BLS-106-366-1 BLS-404-366-1 BLS-106-366-1P BLS-404-366-1P BLS-106-366-2 BLS-404-366-2 BLS-404-366-1 BLS-122-366-1

BLS-122-366-X BLS-810-366-X BLS-128-366-4 BLS5L-129-366-1 BLS5L-450-366-1 BLS5L-450-366-X BLS5L-450-366-1 BLS5L-151-366-1

217-366-2 217-366-2 217-366-X 617-366-1

TRANSOM
T-366

6'8"														
	129-1	151-X	152-X	450-1	617-1	122-1	122-2	404-1	404-1P	404-2	810-X	151-1	450-1	852-X
AB	129-366-1	151-366-X	152-366-X	450-366-1	617-366-1	122-366-1	122-366-2	404-366-1	404-366-1P	404-366-2	810-366-X	151-366-1	450-366-1	852-366-X
BMT	•		•	•						•	•	•	•	•
BLT	•		•							•	•		•	•
BLS	•		•	•		•		•	•	•	•	•	•	•
MHD	•		•	•	•	•	•	•	•	•	•	•	•	•
SHD	•		•	•	•	•	•	•	•	•	•	•	•	•

725 - P
PLATINUM (SHOWN)



Belleville, Oak Textured with Panama Glass / Door BLT-106-725-2



PRIVACY RATING 1 — 4 — 10
Least Obscure — Most Obscure

Granite Glass
Clear Beveled Glass
Aqua Glass
Platinum Caming

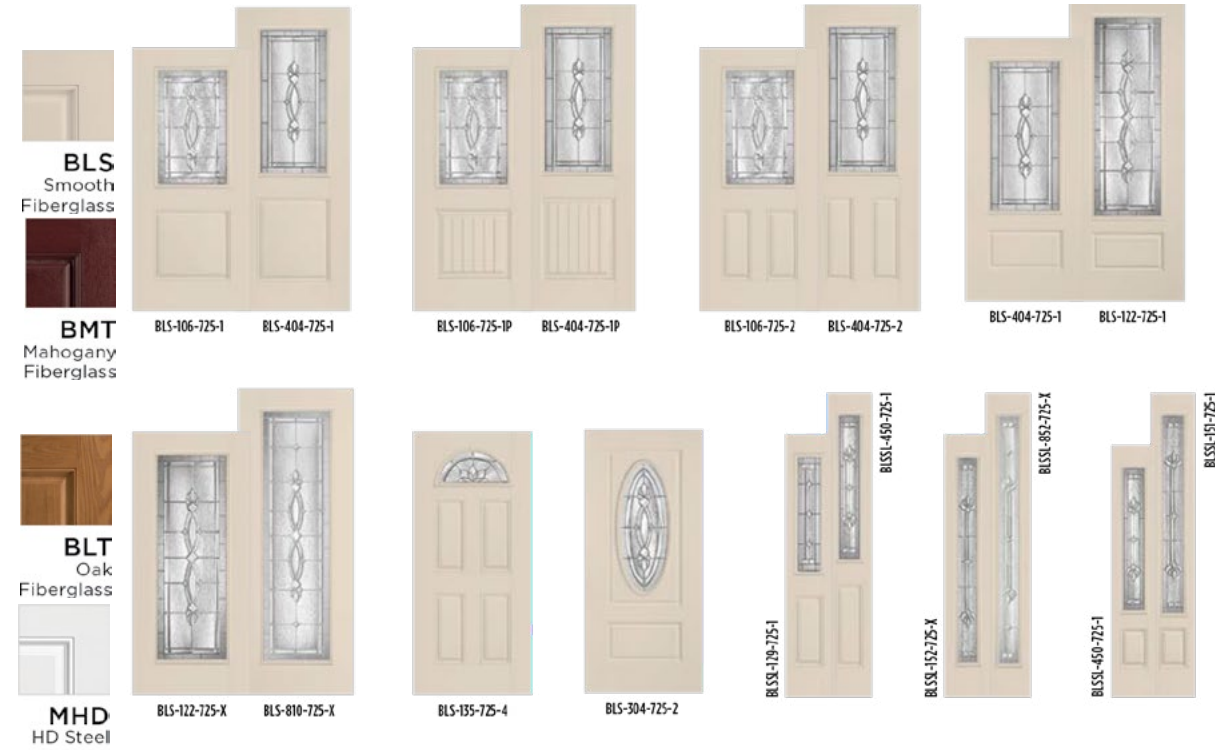

TRANSOMS

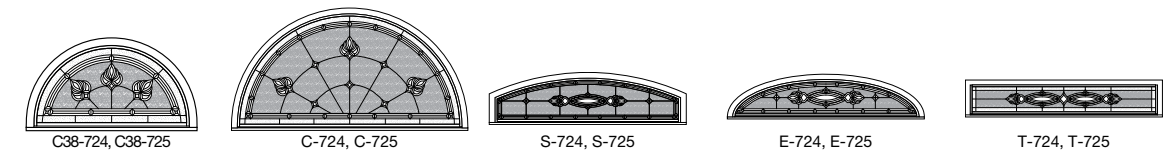

6'8"													
	106-725-1	106-725-1P	106-725-2	122-725-X	135-725-4	203-725-7	304-725-2	304-725-3	404-725-1	404-725-2	151-725-X	152-725-X	450-725-1
P	•	•	•	•	•	•	•	•	•	•	•	•	•
BMT	•	•	•	•	•	•	•	•	•	•	•	•	•
BLT	•	•	•	•	•	•	•	•	•	•	•	•	•
BLS	•	•	•	•	•	•	•	•	•	•	•	•	•
MHD	•	•	•	•	•	•	•	•	•	•	•	•	•
SHD	•	•	•	•	•	•	•	•	•	•	•	•	•

8'0"									
	122-725-1	122-725-2	404-725-1	404-725-1P	404-725-2	810-725-X	151-725-1	450-725-1	852-725-X
P	•	•	•	•	•	•	•	•	•
BMT	•	•	•	•	•	•	•	•	•
BLT	•	•	•	•	•	•	•	•	•
BLS	•	•	•	•	•	•	•	•	•
MHD	•	•	•	•	•	•	•	•	•
SHD	•	•	•	•	•	•	•	•	•

Avenue Glass

339 - AB
ANTIQUE BLACK (SHOWN)



PRIVACY RATING 1 — 5 — 10
Least Obscure — Most Obscure

Granite Glass
Pearl Glass
Aqua Glass
Dark Grey Glass

NEW FOR MID-SUMMER 2022

Glass Series Availability																
Glass Name	Glass Code	Caming	Privacy Rating	106 22" x 36"	122 22" x 64"	217 22" x 17"	217 22" x 17"	228 22" x 10"	228 22" x 10"	404 22" x 48"	151 8" x 64"	152 7" x 64"	129 8" x 36"	404 22" x 48"	450 8" x 48"	T Rectangular Transom 138 164 174
Avenue		AB	9	•		•	•			•	•	•	•	•	•	

BLS Smooth Fiberglass
 BMT Mahogany Fiberglass
 BLT Oak Fiberglass
 MHD HD Steel

Availability is subject to change. Please consult your River City Millwork Rep. for details.

Brooklyn Glass

974 - WR
WROUGHT IRON (SHOWN)

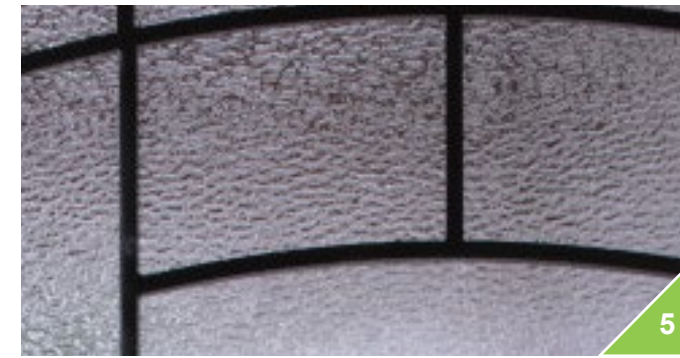

PRIVACY RATING 1 — 5 — 10
Least Obscure — Most Obscure

Tempered Granite Glass
Wrought Iron

NEW FOR MID-SUMMER 2022

Glass Series Availability																
Glass Name	Glass Code	Caming	Privacy Rating	106 22" x 36"	122 22" x 64"	217 22" x 17"	217 22" x 17"	228 22" x 10"	228 22" x 10"	404 22" x 48"	151 8" x 64"	152 7" x 64"	129 8" x 36"	404 22" x 48"	450 8" x 48"	T Rectangular Transom 138 164 174
Brooklyn		T	9	•	•					•	•	•		•	•	

BLS Smooth Fiberglass
 BMT Mahogany Fiberglass
 BLT Oak Fiberglass
 MHD HD Steel

Be sure to include the 3 letter prefix to your door code based on the type of door skin you want.

Sequence Glass

162- AB / 161 - P
ANTIQUE BLACK (SHOWN) / PLATINUM



PRIVACY RATING 1 Least Obscure — 9 Most Obscure

Clear Beveled Granite Beveled Glass Antique Black

NEW FOR MID-SUMMER 2022

Glass Series Availability				106	122	217	217	228	228	404	151	152	129	404	450	T
Glass Name	Glass Code	Caming	Privacy Rating	22" x 36"	22" x 64"	22" x 17"	22" x 17"	22" x 10"	22" x 10"	22" x 48"	8" x 64"	7" x 64"	8" x 36"	22" x 48"	8" x 48"	Rectangular Transom
Sequence		P AB	9	•	•	•	AB •	AB •	AB •	•	•	•	•	•	•	



Star Glass

845 - AB / 845 - P
ANTIQUE BLACK (SHOWN) / PLATINUM



PRIVACY RATING 1 Least Obscure — 7 Most Obscure

Clear Beveled Clear Beveled Glass Glue Chip Glass

NEW FOR MID-SUMMER 2022

Glass Series Availability				106	122	217	217	228	228	404	151	152	129	404	450	T
Glass Name	Glass Code	Caming	Privacy Rating	22" x 36"	22" x 64"	22" x 17"	22" x 17"	22" x 10"	22" x 10"	22" x 48"	8" x 64"	7" x 64"	8" x 36"	22" x 48"	8" x 48"	Rectangular Transom
Star	846	P AB	7	•	AB •					AB •						



Availability is subject to change. Please consult your River City Millwork Rep. for details.

Be sure to include the 3 letter prefix to your door code based on the type of door skin you want.

Textured Glass



Cross Reed 118 / T

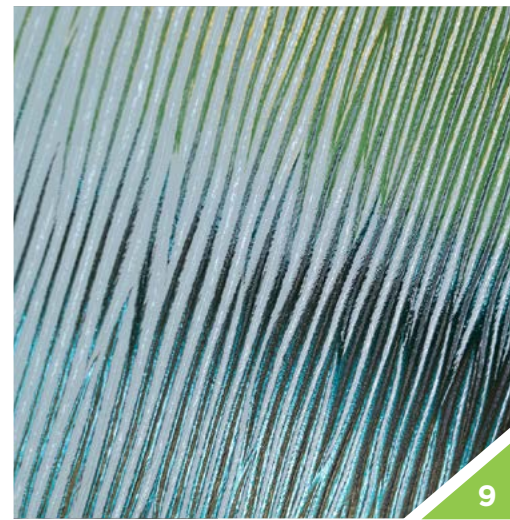

Chord 115 / T



Double Water 113 / T

PRIVACY RATING 1 — 9 — 10
Least Obscure — Most Obscure



Pear 116 / T



Quill 119 / T



Pearl 140 / T

Textured Glass



	6'8"					8'0"								
	129-1	151-X	152-X	450-1	617-1	122-1	122-2	404-1	404-1P	404-2	810-X	151-1	450-1	852-X
T	129-113-1	151-113-X	152-113-X	450-113-1	617-113-1	122-113-1	122-113-2	404-113-1	404-113-1P	404-113-2	810-113-X	151-113-1	450-113-1	852-113-X
T	129-115-1	151-115-X	152-115-X	450-115-1	617-115-1	122-115-1	122-115-2	404-115-1	404-115-1P	404-115-2	810-115-X	151-115-1	450-115-1	852-115-X
T	129-116-1	151-116-X	152-116-X	450-116-1	617-116-1	122-116-1	122-116-2	404-116-1	404-116-1P	404-116-2	810-116-X	151-116-1	450-116-1	852-116-X
T	129-118-1	151-118-X	152-118-X	450-118-1	617-118-1	122-118-1	122-118-2	404-118-1	404-118-1P	404-118-2	810-118-X	151-118-1	450-118-1	852-118-X
T	129-119-1	151-119-X	152-119-X	450-119-1	617-119-1	122-119-1	122-119-2	404-119-1	404-119-1P	404-119-2	810-119-X	151-119-1	450-119-1	852-119-X
T	129-140-1	151-140-X	152-140-X	450-140-1	617-140-1	122-140-1	122-140-2	404-140-1	404-140-1P	404-140-2	810-140-X	151-140-1	450-140-1	852-140-X
BMT
BLT
BLS
MHD
SHD

	6'8"									
	106-1	106-1P	106-2	122-X	217-2C	217-2	217-X	228-4	404-1	404-2
T	106-113-1	106-113-1P	106-113-2	122-113-X	217-113-2C	217-113-2	217-113-X	228-113-4	404-113-1	404-113-2
T	106-115-1	106-115-1P	106-115-2	122-115-X	217-115-2C	217-115-2	217-115-X	228-115-4	404-115-1	404-115-2
T	106-116-1	106-116-1P	106-116-2	122-116-X	217-116-2C	217-116-2	217-116-X	228-116-4	404-116-1	404-116-2
T	106-118-1	106-118-1P	106-118-2	122-118-X	217-118-2C	217-118-2	217-118-X	228-118-4	404-118-1	404-118-2
T	106-119-1	106-119-1P	106-119-2	122-119-X	217-119-2C	217-119-2	217-119-X	228-119-4	404-119-1	404-119-2
T	106-140-1	106-140-1P	106-140-2	122-140-X	217-140-2C	217-140-2	217-140-X	228-140-4	404-140-1	404-140-2
BMT
BLT
BLS
MHD
SHD

SDL

Simulated Divided Lites

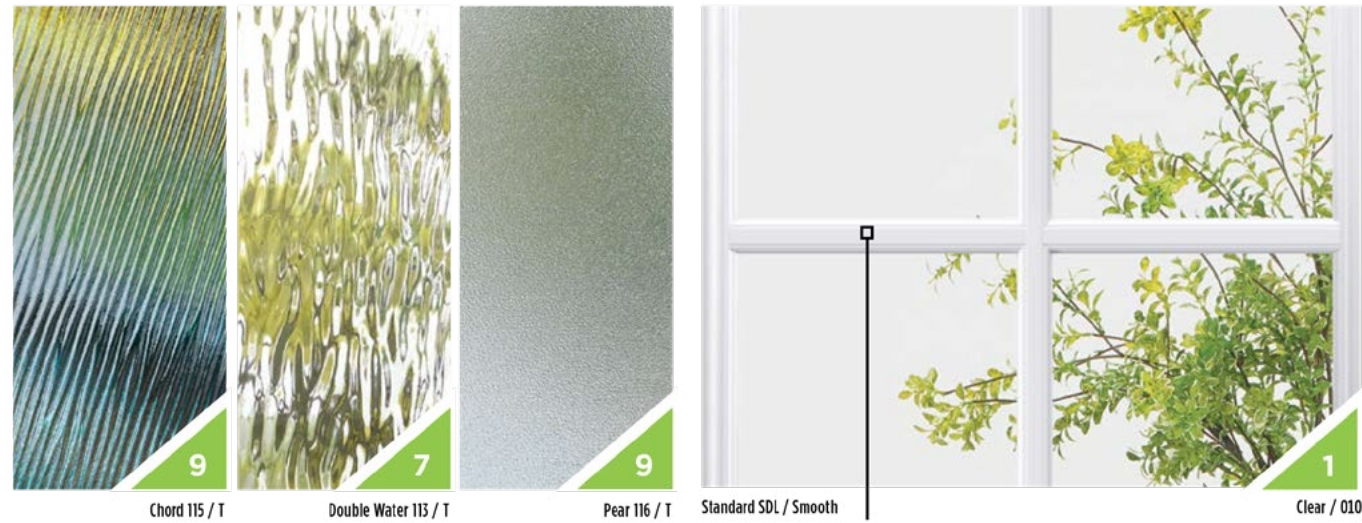

Chord 115 / T

Double Water 113 / T

Pear 116 / T

Standard SDL / Smooth

Clear / 010



Pearl. 140 / T

Quill. 119 / T

Standard SDL / Textured

Clear / 010

PRIVACY RATING 1 — 9 — 10
 Least Obscure — Most Obscure



Door MHD-122-010-506-X

Masonite, HD Steel with 22x64 Glass and 6-Lite Applied SDL Bars



Door BLS-122-010-504-X

Belleville, Smooth with 22x64 Glass and 4-Lite Applied SDL Bars



Door BLT-404-010-506-2 / Sidelite BLT9-450-010-503-1

Belleville, Oak Textured with 22x48 Glass / 8x48 Sidelite and 6-Lite Applied SDL Bars

SDL Simulated Divided Lites

6'8"																	
BMT	
BLT		
BLS
MHD
SHD	
MUS		

6'8"																	
BMT			
BLT				
BLS
MHD
SHD
MUS

6'8"														
BMT
BLT			
BLS	
MHD	
SHD	
MUS			.	.										

8'0"																	
BMT			.			.			.								
BLT			.			.			.								
BLS
MHD
SHD			
MUS			

Availability is subject to change. Please consult your River City Millwork Rep. for details.

Be sure to include the 3 letter prefix to your door code based on the type of door skin you want.

SDL Simulated Divided Lites

Internal & External Grids

8'0"																
	122-510-1	122-510-2	122-512-1	122-512-2	122-515-1	122-515-2	810-504-X	810-506-X	810-508-X	810-509-X	810-510-X	810-512-X	810-515-X	810-518-X	820-504-X	820-506-X
BMT																
BLT																
BLS	•		•		•		•	•	•	•	•	•	•	•	•	•
MHD		•		•		•	•	•	•	•	•	•	•	•	•	•
SHD		•		•		•	•	•	•	•	•	•	•	•	•	•
MUS																

8'0"																
	820-508-X	820-509-X	820-510-X	820-512-X	820-515-X	820-518-X	151-503-1	151-504-1	151-505-1	450-502-1	450-503-1	450-504-1	852-503-X	852-504-X	852-505-X	852-506-X
BMT																
BLT	•	•	•	•	•	•	•	•	•	•	•	•	•	•	•	•
BLS	•	•	•	•	•	•	•	•	•	•	•	•	•	•	•	•
MHD	•	•	•	•	•	•	•	•	•	•	•	•	•	•	•	•
SHD	•	•	•	•	•	•	•	•	•	•	•	•	•	•	•	•
MUS																

PRAIRIE - SIMULATED DIVIDED LITES

6'8"								8'0"							
	120-509P-X	122-509P-X	404-509P-1	404-509P-2	151-506P-X	152-506P-X	450-506P-1		404-509P-1	404-509P-1P	404-509P-2	122-509P-1	122-509P-2	810-509P-X	820-509P-X
BMT		•	•				•							•	
BLT	•	•					•	•						•	•
BLS	•	•	•				•	•	•	•	•	•	•	•	•
MHD	•	•	•	•			•	•				•	•	•	•
SHD	•	•	•	•			•	•				•	•	•	•
MUS	•	•					•								

8'0"			
	151-506P-1	450-506P-1	852-506P-X
BMT	•	•	•
BLT	•	•	•
BLS	•	•	•
MHD	•	•	•
SHD	•	•	•

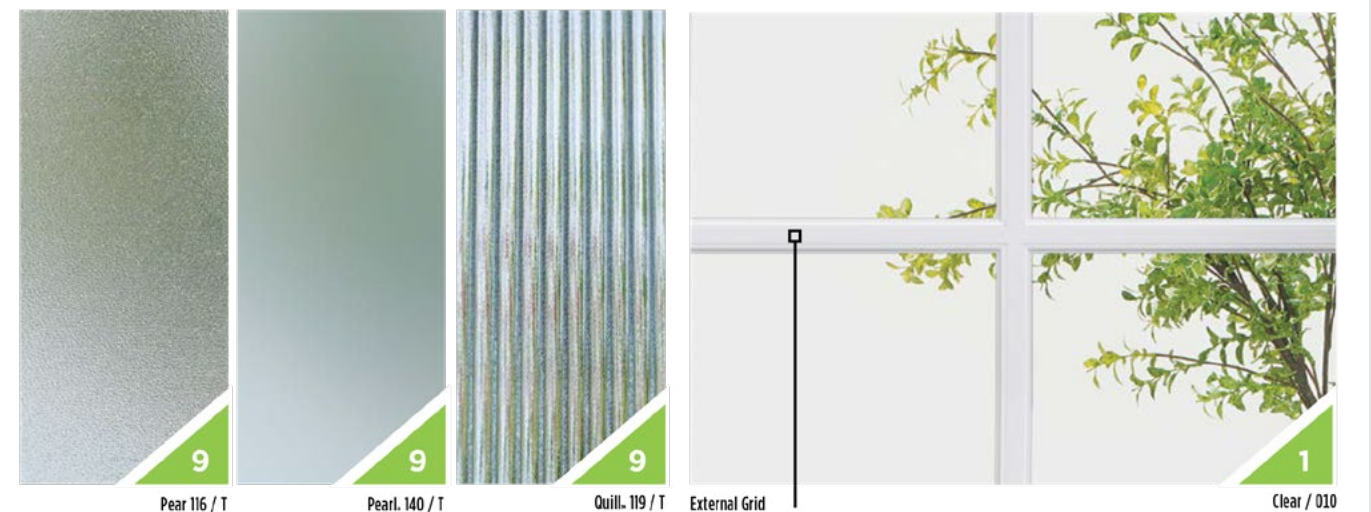
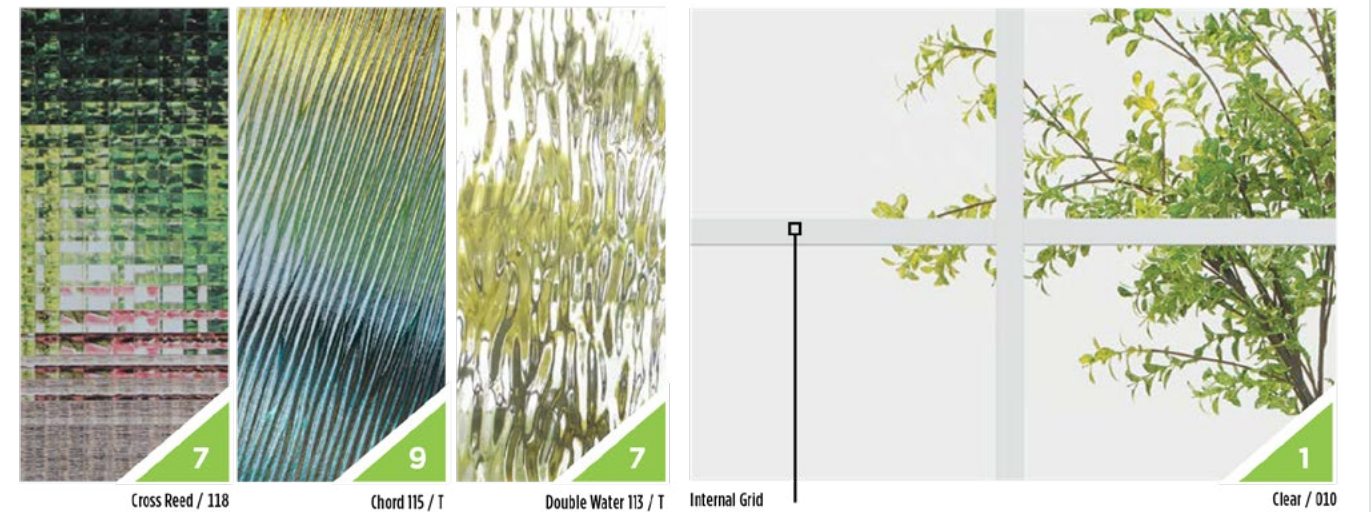

INTERNAL GRID TYPES (specify grid type when ordering)
 Not all grid styles are available in all lite sizes. Please call for availability.

PRIVACY RATING 1 (Least Obscure) — 9 — 10 (Most Obscure)



Availability is subject to change. Please consult your River City Millwork Rep. for details.

Be sure to include the 3 letter prefix to your door code based on the type of door skin you want.

Two-Tone Internal Grids

Committed to delivering the latest trend insights and design ideas, Masonite offers two-tone internal grids. Explore the possibilities with our panel door collection and add an undeniable sense of elegance to any home.



Availability is subject to change. Please consult your River City Millwork Rep. for details.

Two-Tone Internal Grids

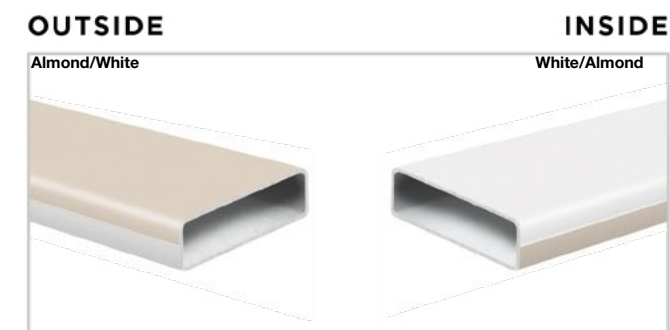

Be sure to include the 3 letter prefix to your door code based on the type of door skin you want.

- ▶ Available in 5/8" and 7/8" flatbar widths
- ▶ All rectangular glass sizes (except 6x8 and 8x8) are available with new, two-tone internal grids
- ▶ Designed to compliment three of the most popular window exteriors in the industry

6'8"														
	106-041-1	106-041-1P	106-041-2	106-091-1	106-091-1P	106-091-2	114-101-X	120-081-X	120-101-X	120-151-X	122-081-X	122-151-X	135-051-4	160-091-2
BMT		•	•		•	•		•	•		•	•		
BFT														
BLT			•			•	•	•	•	•	•	•	•	•
BLS	•	•	•	•	•	•	•	•	•	•	•	•	•	•
MHD	•	•	•	•	•	•	•	•	•	•	•	•	•	•
SHD		•	•		•	•	•	•	•	•	•	•	•	•
MUS			•			•	•	•	•	•	•	•		•

6'8"												
	106-03C-2	106-04C-2	120-03C-X	122-03C-X	120-04C-X	122-04C-X	404-03C-2	404-04C-2	129-03C-1	151-03C-X	152-03C-X	450-03C-1
BMT	•	•	•	•	•	•			•		•	•
BFT												
BLT	•	•	•	•	•	•			•		•	•
BLS	•	•	•	•	•	•			•		•	•
MHD	•	•	•	•	•	•	•	•	•		•	•
SHD	•	•	•	•	•	•	•	•	•		•	•
MUS	•	•	•	•	•	•						

6'8"																
	217-021-2C	217-031-2C	217-041-2C	217-061-2C	228-061-4	404-041-1	404-041-2	404-061-1	404-061-2	404-081-1	404-081-2	404-121-1	404-121-2	129-021-1	129-031-1	151-041-X
BMT					•	•		•		•				•	•	•
BFT																
BLT					•		•		•	•		•	•	•	•	•
BLS					•		•	•	•	•	•	•	•	•	•	•
MHD	•	•	•	•	•	•	•	•	•	•	•	•	•	•	•	•
SHD	•	•	•	•	•	•	•	•	•	•	•	•	•	•	•	•
MUS																

8'0"					
	810-03C-X	810-04C-X	820-03C-X	820-04C-X	852-03C-X
BMT	•	•			•
BFT					
BLT	•	•	•	•	•
BLS	•	•	•	•	•
MHD	•	•	•	•	•
SHD	•	•	•	•	•
MUS					

6'8"									8'0"					
	151-051-X	152-041-X	152-051-X	155-051-X	450-021-1	450-031-1	450-041-1	617-021-1		810-121-X	810-181-X	820-121-X	820-181-X	852-061-X
BMT		•	•		•	•	•			•	•			•
BFT														
BLT		•	•							•	•	•	•	•
BLS		•	•	•	•	•	•			•	•	•	•	•
MHD		•	•	•	•	•	•	•		•	•	•	•	•
SHD		•	•	•	•	•	•	•		•	•	•	•	•
MUS														

PRAIRIE INTERNAL GRID INSERTS

6'8"												
	106-09P-1	106-09P-1P	106-09P-2	106-09P-3	120-09P-X	122-09P-X	160-09P-2	404-09P-1	404-09P-2	151-06P-X	152-06P-X	450-06P-1
BMT	•	•	•			•		•		•	•	•
BFT												
BLT			•		•	•	•				•	•
BLS	•	•	•		•	•	•	•			•	•
MHD	•	•	•		•	•	•	•	•		•	•
SHD		•	•		•	•	•	•	•		•	•
MUS			•		•	•	•					

External Grids

6'8"								
	106-09E-1	106-09E-1P	106-09E-2	106-09E-3	120-10E-X	122-10E-X	120-15E-X	122-15E-X
BMT								
BFT								
BLT								
BLS	•	•	•		•	•	•	•
MHD	•	•	•		•	•	•	•
SHD		•	•		•	•	•	•
MUS					•	•	•	•

6'8"							
	135-05E-4	160-09E-2	217-03E-2C	217-06E-2C	129-03E-1	152-05E-X	617-02E-1
BMT							
BFT							
BLT							
BLS	•	•			•	•	
MHD	•	•	•	•	•	•	•
SHD	•	•	•	•	•	•	•
MUS		•			•	•	

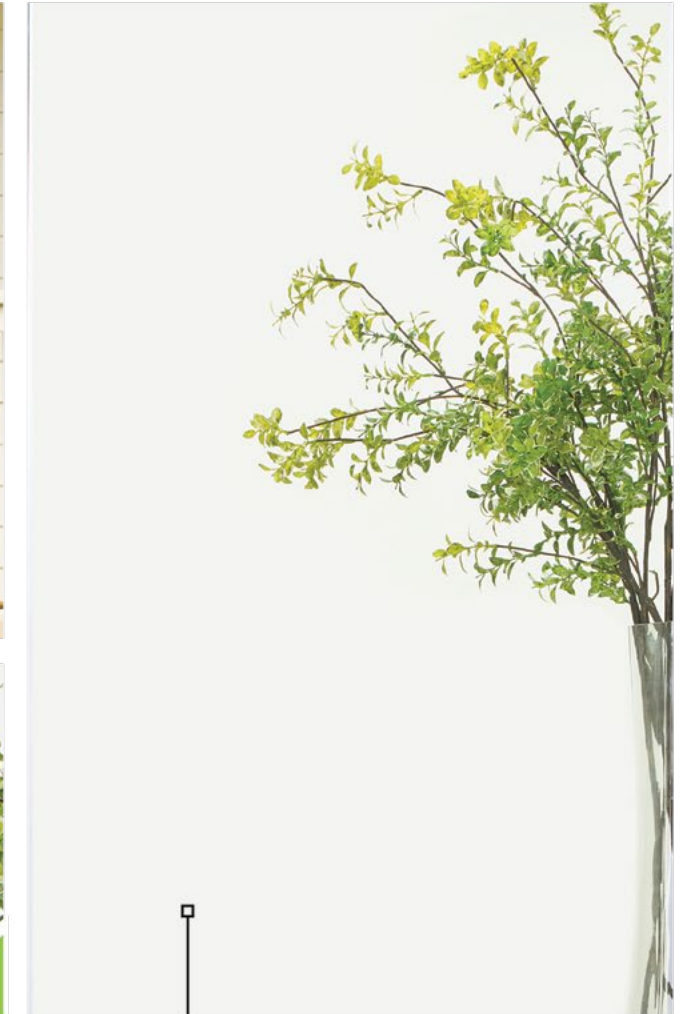
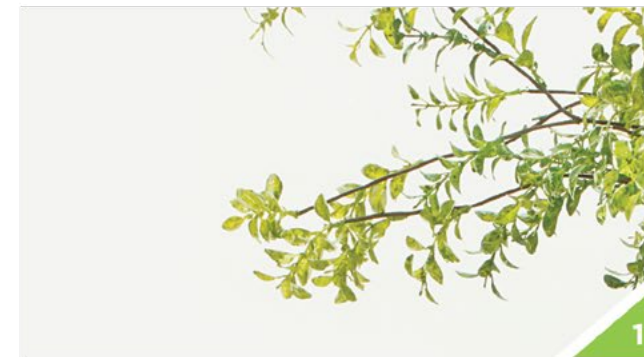

PRIVACY RATING 1 10
Least Obscure Most Obscure

Clear Glass



Availability is subject to change. Please consult your River City Millwork Rep. for details.

Be sure to include the 3 letter prefix to your door code based on the type of door skin you want.

Clear Glass

010 - C
CLEAR GLASS

Clear Glass

Clear Glass

68"														
BMT		*	*		*				*	*				
BLT			*			*		*	*	*	*	*		
BLS	*	*	*			*		*	*	*	*	*	*	
MHD	*	*	*	*	*	*		*	*	*	*	*	*	*
SHD	*	*	*	*	*	*		*	*	*	*	*	*	*
MUS			*				*	*	*	*	*			

68"																
BMT					*		*			*	*	*	*	*	*	*
BLT			*				*		*	*	*	*	*	*		
BLS			*	*	*		*		*	*	*	*	*	*	*	*
MHD	*	*	*	*			*		*	*	*	*	*	*	*	*
SHD	*	*	*	*			*	*	*	*	*	*	*	*	*	*
MUS			*	*				*								

80"									
BMT					*	*	*	*	*
BLT					*	*	*	*	*
BLS	*		*	*	*	*	*	*	*
MHD	*	*	*	*	*	*	*	*	*
SHD	*	*	*	*	*	*	*	*	*
MUS									

†Shown with optional dentil shelf. MHD doors are available with wood-edge or steel-edge construction. MUS doors are wood-edge only. Wood-edge sidelites are utilized on all MUS and MHD door units. All BFT and BLT doors shown are available with matching almond frames. All BMT doors shown are available with matching mahogany frames.



BLS
Smooth
Fiberglass



BMT
Mahogany
Fiberglass



BLT
Oak
Fiberglass



MHD
HD Steel



Mini Blinds & Vents



Masonite, HD Steel with Clear Vent Lite / Door MHD-V106-121-2



Centurion, Frame Aluminum/PVC



White Mini Blinds

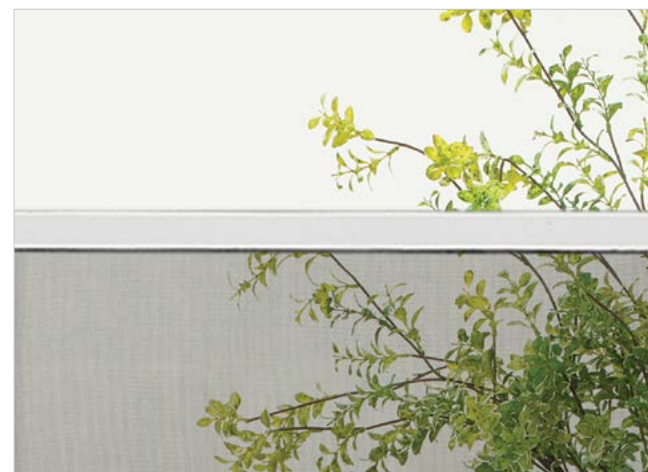

Tan Mini Blinds

Vent Lites

Imagine a blind you don't have to dust or clean. Our blinds are built into efficient sealed units protected with tempered glass. A single touch easily opens/closes blinds for privacy and light exposure.

- ▶ All sizes feature raise, lower and tilt functionality
- ▶ Security channels provide full privacy preventing light gaps when closed (no side or bottom gaps)
- ▶ Frame fits tight to glass—no large gaps
- ▶ Spacer bars not visible in sightline of frame
- ▶ Smoother, easier and more versatile dual mechanism operation
- ▶ 80" sidelite
- ▶ Tan slat mini blinds
- ▶ LE option for ENERGY STAR compliance
- ▶ HVHZ Hurricane impact-rated mini blinds now available



Belleville, Oak Textured with 22x48 Glass and Mini Blinds / Door BLS-B104-01R-2
 Sta-Tru, HD Steel with 20x64 Glass / 7x64 Sidelite and Mini Blinds / Door SHD-B121-01R-X
 Belleville, Smooth with 22x36 Glass and Mini Blinds / Door BLS-B104-01R-1
 Masonite, HD Steel with 22x36 Glass and Vent / Door MHD-V106-01R-2

Availability is subject to change. Please consult your River City Millwork Rep. for details.

Mini Blinds & Vents

MINI BLINDS / RAISE, LOWER AND TILT

6'8"										8'0"			
	B106-01RL-2	B120-01RL-X	B122-01RL-X	B160-01RL-2	B404-01RL-2	B129-01RL-1	B151-01RL-X	B152-01RL-X	B450-01RL-1		B810-01RL-X	B820-01RL-X	B852-01RL-X
BMT													
BLT	•	•	•	•		•	•	•	•		•	•	•
BLS	•	•	•	•		•	•	•	•		•	•	•
MHD	•	•	•	•	•	•	•	•	•		•	•	•
SHD	•	•	•	•	•	•	•	•	•		•	•	•
MUS	•	•	•	•		•	•						

IMPACT-RATED MINI BLINDS / RAISE, LOWER AND TILT

6'8"									
	B106-01RLM-1	B106-01RLM-1P	B106-01RLM-2	B114-01RLM-X	B120-01RLM-X	B122-01RLM-X	B129-01RLM-1	B151-01RLM-X	B152-01RLM-X
SGM		•	•		•	•	•	•	•
SGS	•	•	•	•	•	•	•	•	•
MHD	•	•	•	•	•	•	•	•	•

8'0"								
	B122-01RLM-1	B122-01RLM-2	B810-01RLM-X	B814-01RLM-X	B820-01RLM-X	B151-01RLM-1	B450-01RLM-1	B852-01RLM-X
SGM	•		•		•	•	•	•
SGS	•	•	•	•	•	•	•	•
MHD	•	•	•	•	•	•	•	•

VENTING INSERTS

6'8"										
	V106-010-2	V106-121-2	V160-010-2	V160-121-2	V120-010-X	V120-181-X	V122-010-X	V122-181-X	V404-010-2	V404-121-2
BMT										
BLT										
BLS	•	•	•	•	•	•	•	•	•	•
MHD	•	•	•	•	•	•	•	•	•	•
SHD	•	•	•	•	•	•	•	•	•	•
MUS	•	•	•	•	•	•	•	•	•	•

Be sure to include the 3 letter prefix to your door code based on the type of door skin you want.

ADDITIONAL
OFFERINGS

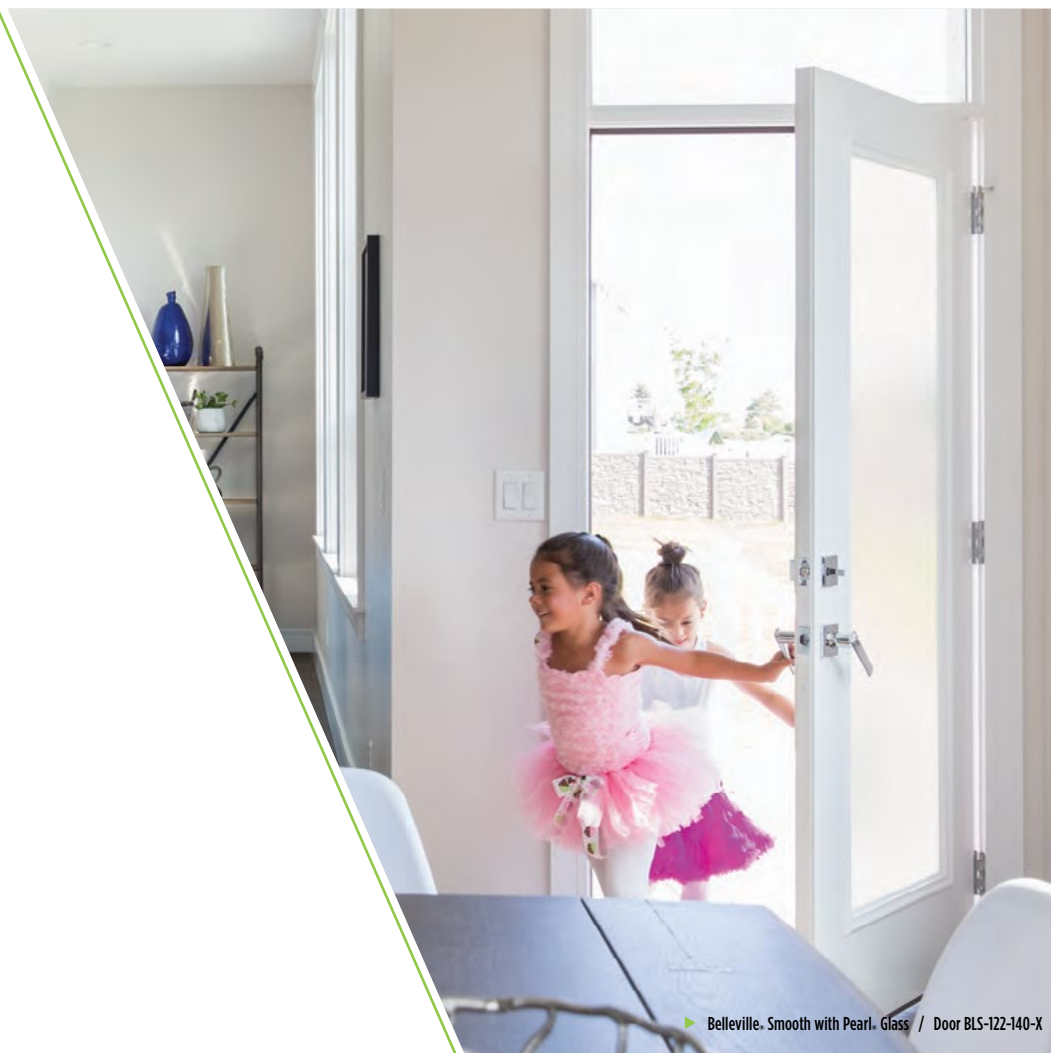



► Belleville. Smooth with Pearl. Glass / Door BLS-122-140-X



Special Order Only





Introducing the first-ever* powered and fully integrated smart door.



 **Fully Integrated Power**
Connected to your home's power supply, so it's always on.

 **1 Battery Backup****
Even if your power goes out, your door stays on.

 **M-Pwr Smartphone App** 
Control lights, check if the door is open or closed, customize your settings and more.

 **2 LED Welcome Lighting**
Programmable, motion-sensing lights show you the way.

 **3 Ring Video Doorbell** 
Monitor your front door from anywhere with a seamless, built-in Ring Video Doorbell.

 **4 Yale® Smart Lock** 
Lock and unlock your door from anywhere with your phone.

 **5 Door State Sensor**
A sensor lets you know if your door is opened or closed.

 **6 Premium Fiberglass Door**
High-quality, long-lasting construction stands up to wind and water.

 **7 Endless Style Options**
Select a door that suits your home with a range of colors and glass styles.



*M-Pwr is the first residential exterior door to integrate power, lights and a video doorbell into the door system. Patent pending.
**Battery backup device lasts up to 24 hours per full charge.

EXPLORE NEW HEIGHTS

SMOOTH STEEL DOORS

Introducing two 8ft additions to our Smooth Steel Collection! The simple and clean designs of the 1-Panel Flat Shaker and 2-Panel Flat Shaker make the perfect, modern solution for large openings. No matter the project type, these 8ft doors are built to perform and backed by a Limited Lifetime Warranty.



90 MINUTES
FIRE RATED



GRADE 40
SECURITY RATING



IN-STOCK

8'0"
TALL
DOORS

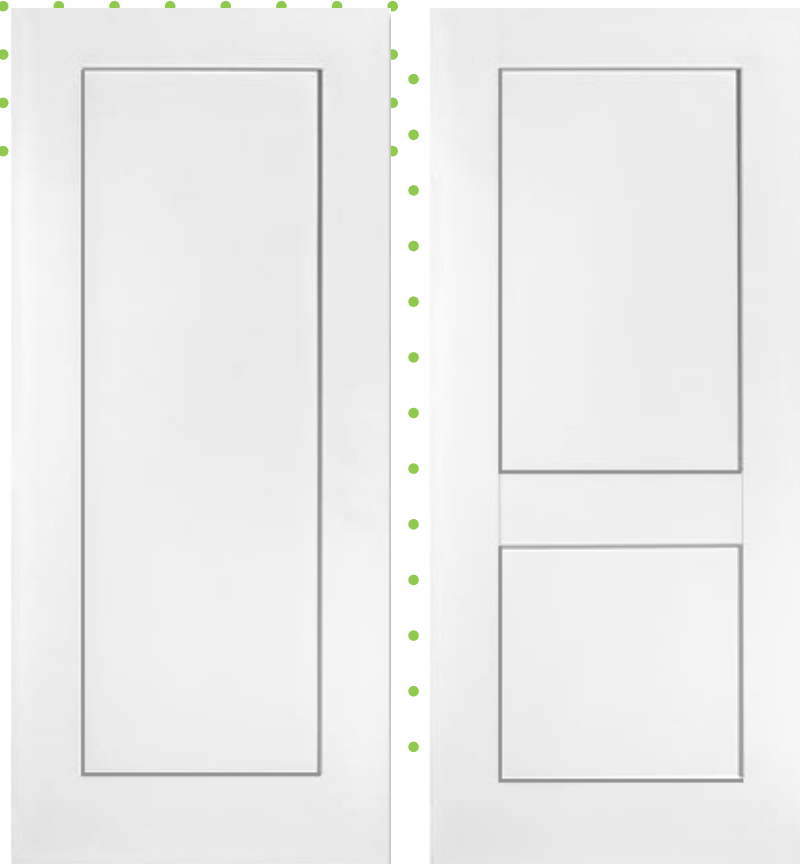

1-PANEL SHAKER
TA30801FP

W 3'0" H 8'0"

2-PANEL SHAKER
TA30802FP

W 3'0" H 8'0"

SEE OUR E-CATALOG FOR PRICING

- Baked-on polyester primer accepts exterior grade latex paint
- Constructed out of 22-gauge hot-dip galvanized steel that resists corrosion
- 20-gauge hinge reinforcements and steel edge
- Polyurethane foam inner core provides superior insulation
- Limited Lifetime Warranty

80

Steel Flat Panel Doors

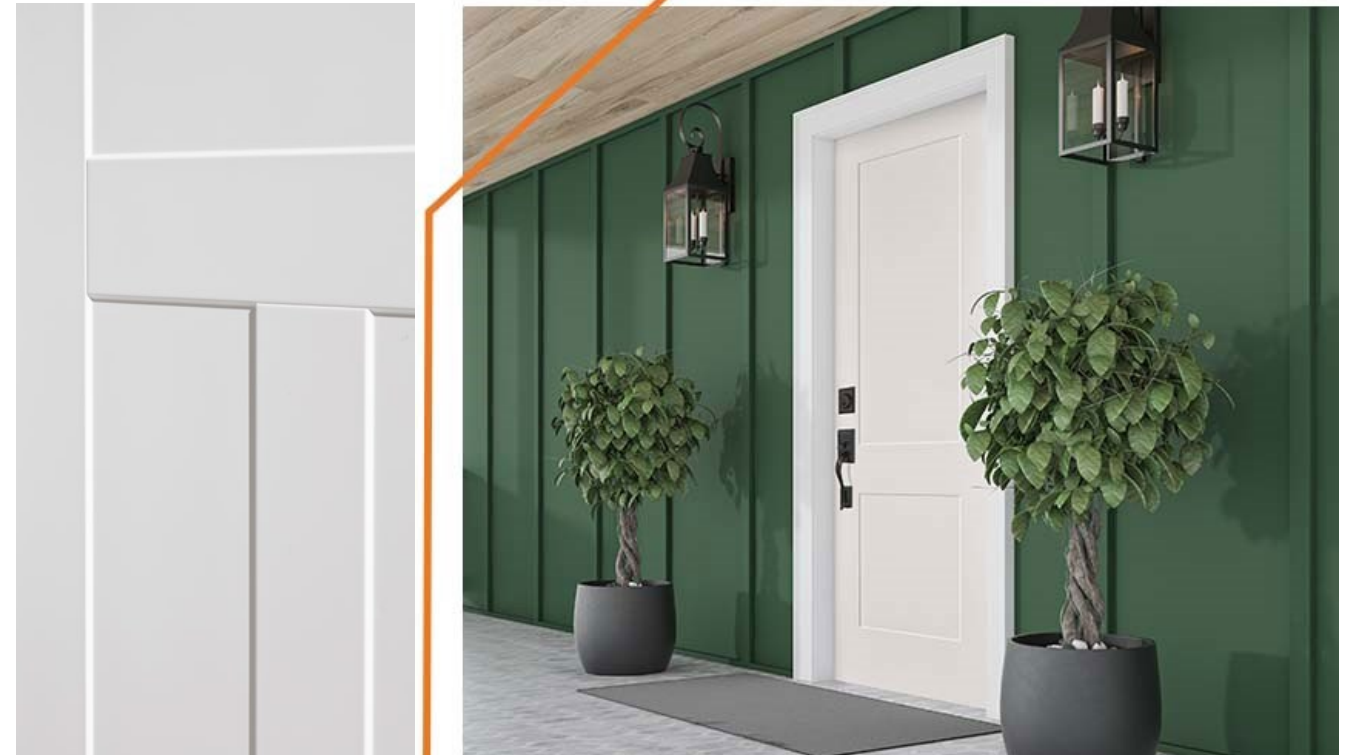

Panel Flat Shaker now in an 8 foot option! These doors will bring beauty and security to any multi-family, single-family, or commercial project.



1-PANEL SHAKER
TA30681P

AVAILABLE IN

H 6'8" 7'0" 8'0"

W 2'8" 2'10" 3'0"



2-PANEL SHAKER
TA30682FP

AVAILABLE IN

H 6'8" 7'0" 8'0"

W 2'8" 2'10" 3'0"



3-PANEL SHAKER
TA30683FP

AVAILABLE IN

H 6'8" 7'0"

W 2'8" 2'10" 3'0"



THE ULTIMATE ADJUSTABLE KERFED STEEL DOOR FRAME

Fast-Frame's advanced design adds a new dimension of flexibility and durability to Masonite's steel entry door line. Developed and manufactured exclusively for Masonite by Timely, Fast-Frame features a full 1" of adjustability to accommodate almost any variation in wall construction. This easy-to-install, user-friendly, kerfed steel door frame system is applicable to a full range of residential and commercial applications with wood or steel stud construction. Timely's expertise in innovating and manufacturing steel door frame components is second to none. Fast-Frame is engineered to meet the most stringent code requirements including structural, impact and 90-minute fire ratings.

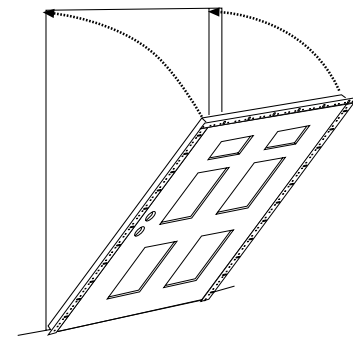

Outer Adjustable Closure

20-Gauge Steel
2 Uprights – 1 Header

TA-1 Adjustable T-Strike

1/4" of adjustment allows for ease of field installations for proper door closure.

Closure Span Adjustment Chart

Wall Sizes	A
4-1/2" – 5-1/2" = 1-7/8"	
5-1/2" – 6-1/2" = 2-7/8"	
6-1/2" – 7-1/2" = 3-7/8"	

Wider sizes are available upon request.

Weatherstripping

Schlegel foam-filled compression (QEBD500)
90-minute fire rating

Primed White Galvanized Steel

Galvanized 20-gauge steel provides superior corrosion resistance, matches our Masonite HD bright white doors, and is an ideal surface for painting.

Standard Inswing Sill

Thermally broken – 5-5/8" width. Optional extenders for larger wall sizes.
Note: Not for use on outswing applications.

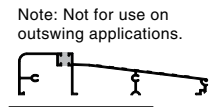

Handicap (ADA) Sill

Double Slope 4-9/16" & 6-9/16" width

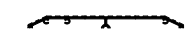

Tile Face Sill

4-1/4" & 6-1/4" width
Note: Not for use on outswing applications.

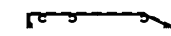

Bumper Outswing Sill

4-9/16" width

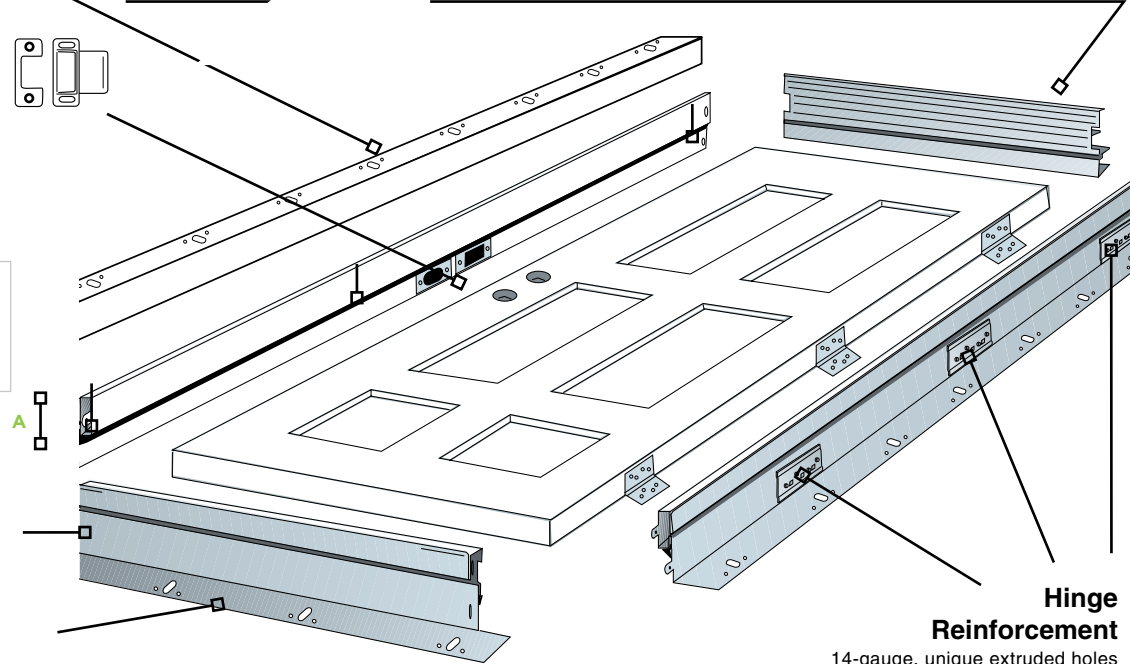

Hinge Reinforcement
14-gauge, unique extruded holes provide the strength of a 12-gauge hinge reinforcement.

CASING OPTIONS



Wood trim and brickmould can be easily applied to Fast-Frame using nails or trim head screws without the need for custom millwork.

FAST-FRAME CASINGS

TA-8 Standard Steel Casing

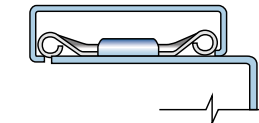

TA-30 Colonial Steel Casing

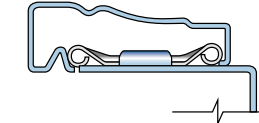

- TA-8 casings enhance any commercial or residential setting
- It is recommended that TA-18 retainer clips be used for both casings
- TA-30 casings add a special warmth for assisted living, motels, hotels, offices, apartments and homes

APPLICATIONS

- Multi-Family
- Assisted Living
- Motel/Hotel
- House to Garage
- Garage to Exterior

- Double door width is with a 'Z' astragal. If using a 5/8" astragal then add 9/16" to the width
- All dimensions shown are for doors with standard inswing sill. Deduct 13/16" for bumper outswing or handicap compliant sill
- Add 4" to height for 7'0" height
- Add 16" to height for 8'0" height
- Premdor spec slabs add 1/4" to height

FIRE LABELS

Up to 90-Minute Fire Ratings available in single and double* configurations

*A 'Z' astragal and flush bolt are required for double fire ratings (sold separately)



CLOSURE TEST

In a 90-minute application, the door will close and latch from 18" if the following Fast-Frame components are used:

- QEBD500 Foam-Filled Compression Weatherstripping
- Factory Sweep
- Adjustable T-Strike
- Factory Supplied Sills
- Self-Closing Hinges

STRUCTURAL PERFORMANCE AND IMPACT RATING

Design pressure ratings are available for compliance with national, state and local wind load and/or missile requirements. This product was tested for structural and impact performance in accordance with TAS 201, 202 and 203. Product approval is available under the Florida Department of Community Affairs (FL10357). Please note: Structural and impact performance requires use of a hurricane grade 5/8" T-astragal for double doors.

DOOR SELECTION

Fast-Frame is available in either right- or left-hand inswing or outswing and is for use with any Masonite steel entry door.

FAST-FRAME ROUGH OPENINGS		
PREHUNG DOOR SIZES		
	Nominal Door Size	Rough Opening Size (Wood Stud)
	W x H	W x H
Single Door	2'0" x 6'8"	25-1/4" x 81-5/8"
	2'6" x 6'8"	31-1/4" x 81-5/8"
	2'8" x 6'8"	33-1/4" x 81-5/8"
	2'10" x 6'8"	35-1/4" x 81-5/8"
	3'0" x 6'8"	37-1/4" x 81-5/8"
Double Door	4'0" x 6'8"	49-1/4" x 81-5/8"
	5'0" x 6'8"	61-1/4" x 81-5/8"
	5'4" x 6'8"	65-1/4" x 81-5/8"
	5'8" x 6'8"	69-1/4" x 81-5/8"
	6'0" x 6'8"	73-1/4" x 81-5/8"

*Z astragals only available in 6'8" and 8'0" heights.

MASONITE GLASS

More Light. More Comfort. Less Energy.

As the leader in both innovation and trend, Masonite has invested in new state-of-the-art, automated, high-speed warm-edge spacer assembly lines that put Masonite Glass at the forefront of the door lite industry.

Warm-edge flexible spacers have been shown to have up to nine times the life expectancy of traditional metal insulating glass systems available on the market today. They expand and contract and always return to their original shape, protecting against stress cracks that can lead to seal failure.

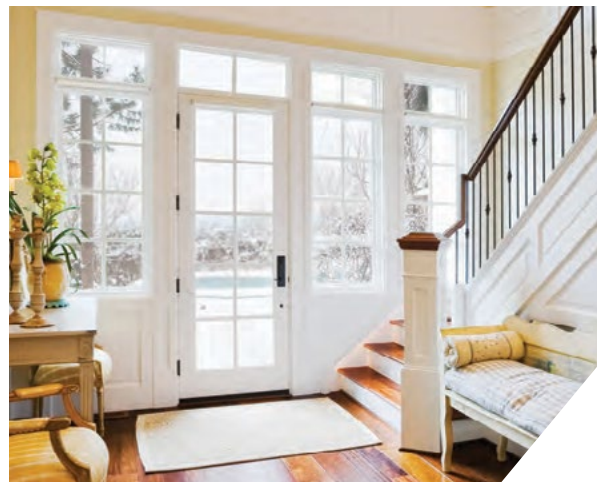

WARM-EDGE FLEXIBLE SPACERS
= LESS SEAL FAILURES

Warm-Edge Flexible Spacer
Flexible spacers can move as glass bows inward or outward, resulting in a reduction of seal failures when compared to metal spacers.

VS.

FULL-METAL SPACERS

Full-Metal Spacer
Metal spacers are rigid and seal stress can result in seal failure.

SPACER SYSTEM	CONDENSATION RESISTANCE	EDGE OF GLASS TEMPERATURE	EFFECTIVE THERMAL CONDUCTIVITY	TOTAL IGU FACTOR
Warm-Edge Flexible Spacer	43.9	38.1°F / 3.39°C	0.182 W/m•C	0.265
Stainless Steel U-Channel / Butyl	38	35.1°F / 1.72°C	0.333 W/m•C	0.269
Stainless Box / PIB Primary Sealant	36	33.6°F / 0.89°C	0.365 W/m•C	0.271
Tin U-Channel / Butyl	27.3	29.5°F / -1.39°C	0.806 W/m•C	0.278
Aluminum Spacer / Silicone	19.6	23.7°F / -4.61°C	1.623 W/m•C	0.296

Simulations were completed using WINDOW 7.4 / THERM 7.4 as per NFRC 200-2014. Outside temperature 0°F, inside temperature 70°F.

PERFORMANCE BENEFITS OVER OTHER SPACERS

CLEARER VIEWING

Warm-Edge Flexible Spacers
All-foam design dramatically reduces interior condensation, delivering a clear view

Less-Metal Spacer
Mid-performance spacer systems that still contain metal improve condensation resistance.

Full-Metal Spacer
With conventional metal spacers, condensation is a fact of life.

SOUND REDUCING

Improved sound absorption over traditional metal spacers; warm-edge flexible spacers help keep in keeping the decibels down

LONGER LASTING

Warm-Edge Flexible Spacers
Warm-edge flexible spacers feature a unique no-metal composite-laminating technology that provides superior durability and thermal performance in insulating glass units

Weeks in P-1 Durability Testing

■ Traditional Metal Spacer
■ Warm-Edge Flexible Spacer

ENERGY SAVING

The thermal performance of a window plays a major role in household energy conservation. A high-performance window system will keep your energy costs low by reducing heat loss in the winter and heat gain in the summer

UP TO +14.4°F/8.0°C warmer temperature at the edge of the glass
(vs. aluminum spacer / silicone)

38.1°F/3.39°C
Warm-Edge Flexible Spacers

35.1°F/1.72°C
Stainless Steel U-Channel / Butyl

33.6°F/0.89°C
Stainless Box / PIB Primary Sealant

29.5°F/-1.39°C
Tin U-Channel / Butyl

23.7°F/-4.61°C
Aluminum Spacer / Silicone

Exterior Millwork



COLUMNS

FIBERGLASS COLUMNS

Our fiberglass columns are rot-proof, weather-proof, insect proof, and highly durable. HB&G has the options for your style and budget.

ALUMINUM COLUMNS

The aluminum column collection is coated with a baked-on enamel finish to provide low maintenance, easy cleaning, and a beautiful white uniform finish.

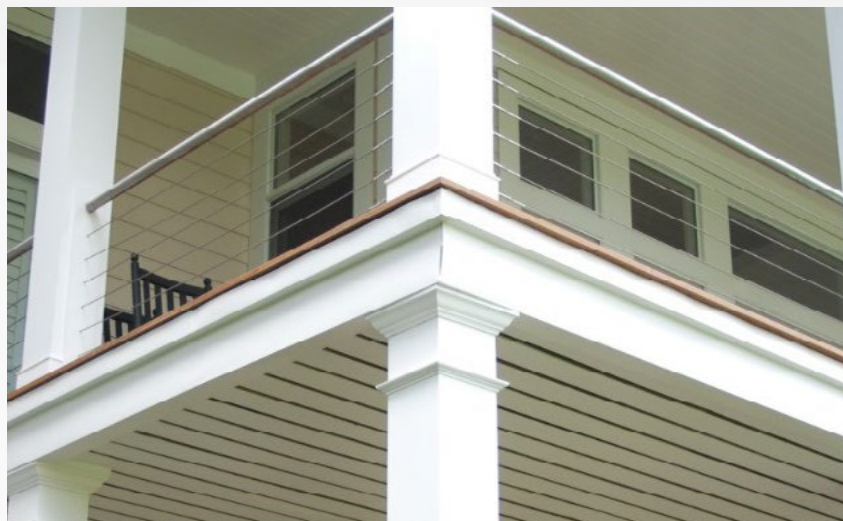

PVC COLUMN WRAPS

PVC column wraps are made from cellular PVC, which offers the advantages of being unaffected by moisture and insects but has the thickness, ease of use, and workability of wood.

PERMASNAP™

A quick and easy solution to wrap existing wood or metal porch columns and come with three different trim option.



PORCH RAILINGS & BALUSTRADE

PORCH RAILINGS

Easy to install, this worry-free railing system will be a beautiful, low maintenance addition to your porch or deck for generations to come.

BALUSTRADE SYSTEMS

These low-maintenance features are made by moulding high-density urethane around structural elements in order to provide exceptional beauty, durability, and quality. Choose from three rail sizes and several baluster profiles.

Exterior Millwork

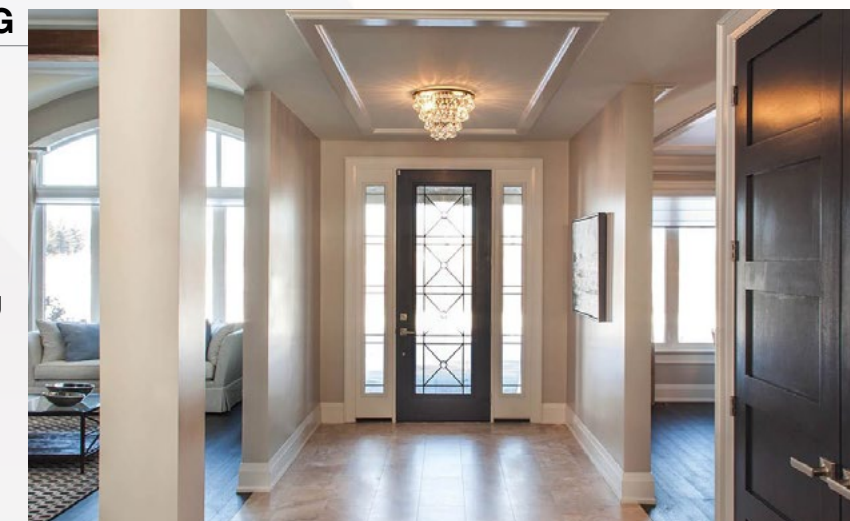

CASING, TRIM, & MOULDING

We offer a variety of styles of door trim including Craftsman, traditional and contemporary in various species.

PRODUCTS LINE:

- Architrave
- Base
- Base Cap
- Baseboards
- Brick Mould
- Casing
- Crown
- Crown Cap
- Chair rails
- Flexible Moulding
- Panel Mould
- Mouldings & Trim
- Rosettes
- Round
- Stool
- Stop

ARCHITECTURAL ACCENTS

From ceiling medallions to porch post brackets, our wide variety of millwork accessories to create the right look.

ACCENTS

- Brackets
- Corbels
- Corner Blocks
- Medallions
- Shelf Blocks
- Ceiling Panels
- Lamp Post



ALUMINUM CLADDING

Aluminum cladding creates a protective layer on the exterior of the product and works on any manufacturing entry door system.

FEATURES & BENEFITS

- Heavy-duty extruded aluminum
- No chipping, no cracking, no peeling
- Mull covers
- Jamb Extenders
- Flexible or rigid nail fin
- No exposed fasteners



Door Handing Chart

FOR MASONITE ENTRY & PATIO DOORS

INSWING		OUTSWING	
LEFT HAND Doors pictured above assume you are standing on the outside of the building.	RIGHT HAND Doors pictured above assume you are standing on the outside of the building.	RIGHT HAND Doors pictured above assume you are standing on the outside of the building.	LEFT HAND Doors pictured above assume you are standing on the outside of the building.
SINGLE DOOR			
Exterior Left-Hand Inswing	Exterior Right-Hand Inswing	Exterior Right-Hand Outswing	Exterior Left-Hand Outswing
SINGLE DOOR WITH LEFT-HAND SIDELITE			
Exterior Left-Hand Hinge Side	Exterior Right-Hand Lock Side	Exterior Right-Hand Hinge Side	Exterior Left-Hand Lock Side
SINGLE DOOR WITH RIGHT-HAND SIDELITE			
Exterior Left-Hand Lock Side	Exterior Right-Hand Hinge Side	Exterior Right-Hand Lock Side	Exterior Left-Hand Hinge Side
SINGLE DOOR WITH DOUBLE SIDELITES			
Exterior Left-Hand Inswing	Exterior Right-Hand Inswing	Exterior Right-Hand Outswing	Exterior Left-Hand Outswing
FRENCH DOUBLE DOORS			
Exterior Left-Hand Inswing	Exterior Right-Hand Inswing	Exterior Right-Hand Outswing	Exterior Left-Hand Outswing
FRENCH DOUBLE DOORS WITH DOUBLE SIDELITES			
Exterior Left-Hand Inswing	Exterior Right-Hand Inswing	Exterior Right-Hand Outswing	Exterior Left-Hand Outswing
CENTER-SWING DOUBLE DOORS*			
Exterior Left-Hand Inswing	Exterior Right-Hand Inswing	Exterior Right-Hand Outswing	Exterior Left-Hand Outswing
TRIPLE FRENCH DOORS*			
Exterior Left-Hand Inswing	Exterior Right-Hand Inswing	Exterior Right-Hand Outswing	Exterior Left-Hand Outswing
CENTER-SWING TRIPLE DOORS*			
Exterior Left-Hand Inswing	Exterior Right-Hand Inswing	Exterior Right-Hand Outswing	Exterior Left-Hand Outswing

Complete list of handing options available at Masonite.com

DOOR HANDLING AND SWING

HANDING - SINGLE DOOR

When the door opens toward you and the knob is on the left hand side, it is a LEFT HAND DOOR. When the knob is on the right, it is a RIGHT HAND DOOR.

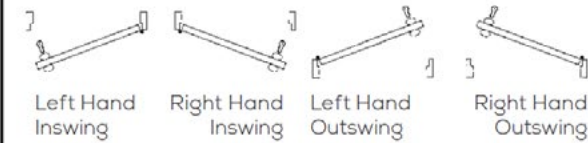

HANDING - DOUBLE DOOR

When the door opens toward you and the knob is on the left hand side, it is a LEFT HAND DOOR. When the knob is on the right, it is a RIGHT HAND DOOR.

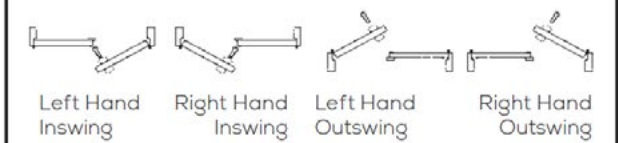

ROUGH OPENING CHART

Order This Size Door	New Construction - To Fit This Rough Opening Width							
	Single Door Only	Single Door with One 12" Sidelite	Single Door with Two 12" Sidelites	Single Door with One 14" Sidelite	Single Door with Two 14" Sidelites	Double Doors Only	Double Door with Two 12" Sidelites	Double Door with Two 14" Sidelites
32" Single	34"	47-1/2"	61"	49-1/2"	65"			
34" Single	36"	49-1/2"	63"	51-1/2"	67"			
36" Single	38"	51-1/2"	65"	53-1/2"	69"			
64" Double						66-1/2"	93-1/2"	97-1/2"
72" Double						74-1/2"	101-1/2"	105-1/2"

Note: All doors are 80" high (nominal) and require an 82-1/2" high rough opening for inswing unit.

1. For brick-to-brick measurement ADD 2" to numbers above and 3/4" to height.
2. For jamb-to-jamb measurement SUBTRACT 1/2" from the R.O. numbers above.
3. For outswing brick-to-brick measurement ADD 2-1/2" from the numbers above and 1" TO HEIGHT.
4. Handicap R.O. height is 81-1/2"
5. Outswing R.O. height is 81-3/4"
6. 7'0" inswing R.O. height is 86-1/2"
7. 8'0" inswing R.O. height is 98-1/2"

Call for rough openings for prehung units with Elliptical transoms.

Fiberglass Availability

SELECTION & STYLE

Modern Door

	Vertical Lite	Vertical Lite	Vertical Lite	2 Vertical Lites	3 Equal Lites	4 Equal Lites	3 Square Lites	3 Square Lites	3 Square Lites	4 Square Lites
Door Material	BLT/BLS MHD/SHD	BLT/BLS MHD/SHD	BLT/BLS MHD/SHD	BLT/BLS MHD/SHD	BLT/BLS MHD/SHD	BLT/BLS MHD/SHD	BLT/BLS MHD/SHD	BLT/BLS MHD/SHD	BLT/BLS MHD/SHD	BLT/BLS MHD/SHD
6'8" Widths	2'6", 2'8", 2'10", 3'0"	2'6", 2'8", 2'10", 3'0"	2'6", 2'8", 2'10", 3'0"	2'8", 2'10", 3'0"	2'8", 2'10", 3'0"	2'8", 2'10", 3'0"	2'6", 2'8", 2'10", 3'0"	2'6", 2'8", 2'10", 3'0"	2'6", 2'8", 2'10", 3'0"	2'6", 2'8", 2'10", 3'0"
Glass Sizes	151/152	151/152	151/152	151/152	217	228	682	682	682	682
Textured Glass	•	•	•	•	•	•	•	•	•	•
Clear Glass	•	•	•	•	•	•	•	•	•	•

	4 Square Lites	4 Square Lites	5 Square Lites	5 Square Lites	5 Square Lites	Diamond Lite	3 Diamond Lites	3 Diamond Lites	3 Diamond Lites
Door Material	BLT/BLS MHD/SHD	BLT/BLS MHD/SHD	BLT/BLS MHD/SHD	BLT/BLS MHD/SHD	BLT/BLS MHD/SHD	BLT/BLS MHD/SHD	BLT/BLS MHD/SHD	BLT/BLS MHD/SHD	BLT/BLS MHD/SHD
6'8" Widths	2'6", 2'8", 2'10", 3'0"	2'6", 2'8", 2'10", 3'0"	2'6", 2'8", 2'10", 3'0"	2'6", 2'8", 2'10", 3'0"	2'6", 2'8", 2'10", 3'0"	2'6", 2'8", 2'10", 3'0"	3'0"	2'6", 2'8", 2'10", 3'0"	3'0"
Glass Sizes	682	682	682	682	682	682	682	682	682
Textured Glass	•	•	•	•	•	•	•	•	•
Clear Glass	•	•	•	•	•	•	•	•	•

	5 Equal Lites	Diamond Lite	3 Diamond Lites	3 Diamond Lites	3 Diamond Lites	4 Diamond Lites	6 Square Lites	6 Square Lites	6 Square Lites	Vertical Lite	Vertical Lite	2 Vertical Lites
Door Material	BLT/BLS MHD/SHD	BLT/BLS MHD/SHD	BLT/BLS MHD/SHD	BLT/BLS MHD/SHD	BLT/BLS MHD/SHD	BLT/BLS MHD/SHD	BLT/BLS MHD/SHD	BLT/BLS MHD/SHD	BLT/BLS MHD/SHD	BLT/BLS MHD/SHD	BLT/BLS MHD/SHD	BLT/BLS MHD/SHD
8'0" Widths	2'8", 2'10", 3'0"	2'6", 2'8", 2'10", 3'0"	2'6", 2'8", 2'10", 3'0"	2'6", 2'8", 2'10", 3'0"	2'6", 2'8", 2'10", 3'0"	2'6", 2'8", 2'10", 3'0"	2'6", 2'8", 2'10", 3'0"	2'6", 2'8", 2'10", 3'0"	2'6", 2'8", 2'10", 3'0"	2'6", 2'8", 2'10", 3'0"	2'6", 2'8", 2'10", 3'0"	2'8", 2'10", 3'0"
Glass Sizes	228	682	682	682	682	682	682	682	682	852	852	852
Textured Glass	•	•	•	•	•	•	•	•	•	•	•	•
Clear Glass	•	•	•	•	•	•	•	•	•	•	•	•

Material

BLS	Belleville. Smooth	MHD	Masonite. HD Steel
BLT	Belleville. Oak Textured	SHD	Sta-Tru. HD Steel

Fiberglass Availability

SELECTION & STYLE

VistaGrande® Textured Flush-Glazed

	120	122	426	926	152	450
Door Material	VFT	VFT	VFT	VFT	VFT	VFT
6'8" Widths	2'6"	2'8", 2'10"	3'0"	3'0"	10", 10", 12"	10", 12"
Glass Sizes	120	122	426	926	152	450
Textured Glass	•	•	•	•	•	•
Clear Glass	•	•	•	•	•	•
Mini Blinds	•	•	•	•	•	•

	810	820	826	926	151	852
Door Material	VFT	VFT	VFT	VFT	VFT	VFT
8'0" Widths	2'8", 2'10"	2'6"	3'0"	3'0"	10", 10", 12"	10", 12"
Glass Sizes	810	820	826	926	151	852
Textured Glass	•	•	•	•	•	•
Clear Glass	•	•	•	•	•	•
Mini Blinds	•	•	•	•	•	•

VistaGrande® Smooth Flush-Glazed

	120	122	426	926	152	450	810	820	826	926	151	852
Door Material	VSG	VSG	VSG	VSG	VSG	VSG	VSG	VSG	VSG	VSG	VSG	VSG
6'8" Widths	2'6"	2'8", 2'10"	3'0"	3'0"	10", 10", 12"	10", 12"						
8'0" Widths							2'8", 2'10"	2'6"	3'0"	3'0"	10", 10", 12"	10", 12"
Glass Sizes	120	122	426	926	152	450	810	820	826	926	151	852
Textured Glass	•	•	•	•	•	•	•	•	•	•	•	•
Clear Glass	•	•	•	•	•	•	•	•	•	•	•	•
Mini Blinds	•	•	•	•	•	•	•	•	•	•	•	•

Material

VFT	VistaGrande. Textured Flush-Glazed	VSG	VistaGrande. Smooth Flush-Glazed
-----	------------------------------------	-----	----------------------------------



Fiberglass Availability

SELECTION & STYLE

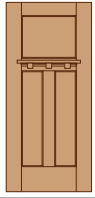
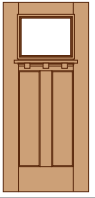
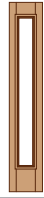
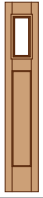
Heritage Series® Winslow® Fir Textured

					
	Craftsman 3P	Craftsman 2P	Sidelite w/ Full Glass		Craftsman Sidelite
Door Material	HFT	HFT	HFT		HFT
6'8" Widths	2'8", 2'10", 3'0"	2'8", 2'10", 3'0"	1'0", 1'2"		1'0", 1'2"
Dentil Shelf	option shown	option shown			
SDL Kit		optional	optional		optional
Glass Sizes		217	6'8" 151	8'0" 852	617
Marco. 331		•	•	•	•
Frontier. 312		•	•	•	•
Element. 328		•	•	•	•
Naples. 366		•	•	•	•
Focus. 627		•	•	•	•
Clear Glass 010		•	•	•	•
Textured Glass		•	•	•	•

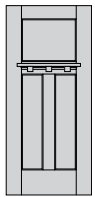
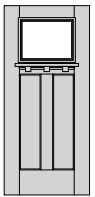
Heritage Series® Winslow® Smooth

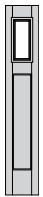
					
	Craftsman 3P	Craftsman 2P	Sidelite w/ Full Glass		Craftsman Sidelite
Door Material	HGS	HGS	HGS		HGS
6'8" Widths	2'8", 2'10", 3'0"	2'8", 2'10", 3'0"	1'0", 1'2"		1'0", 1'2"
8'0" Widths	2'8", 2'10", 3'0"	2'8", 2'10", 3'0"	1'0", 1'2"		1'0", 1'2"
Dentil Shelf	option shown	option shown			
SDL Kit		optional	optional		optional
Glass Sizes		217	6'8" 151	8'0" 852	617
Marco. 331		•	•	•	•
Frontier. 312		•	•	•	•
Element. 328		•	•	•	•
Naples. 366		•	•	•	•
Focus. 627		•	•	•	•
Clear Glass 010		•	•	•	•
Textured Glass		•	•	•	•





Material

HFT	Winslow. Fir Textured	HGS	Winslow. Smooth
-----	-----------------------	-----	-----------------



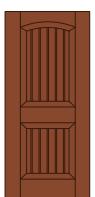

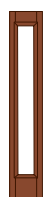
Fiberglass Availability

SELECTION & STYLE





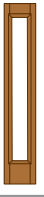

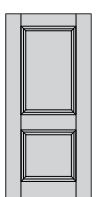

Belleville® Mahogany Textured

							
	Hollister. 2P	Cheyenne. 2P Plank	6P	8P Parliament	Sidelite w/ Full Glass	Sidelite w/ 1/2 Glass	Sidelite w/ 3/4 Glass
Door Material	BMT	BMT	BMT	BMT	BMT	BMT	BMT
6'8" Widths	2'8", 2'10", 3'0"	2'8", 2'10", 3'0"	2'8", 2'10", 3'0"	2'10", 3'0"	1'0", 1'2"	1'0", 1'2"	1'0", 1'2"
8'0" Widths			2'8", 2'10", 3'0", 3'6"		1'0", 1'2"	1'0", 1'2"	
Glass Sizes	122, 304, 404	106, 107	106, 122, 228, 404, 810	203	151, 152, 852	129, 450	151, 450

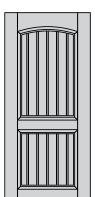
Belleville® Oak Textured

					
	Flush	4P Blank-Top	6P	Sidelite w/ Full Glass	Sidelite w/ 1/2 Glass
Door Material	BLT	BLT	BLT	BLT	BLT
6'8" Widths	2'0", 2'6", 2'8", 2'10", 3'0"	2'8", 2'10", 3'0"	2'6", 2'8", 2'10", 3'0"	1'0", 1'2"	1'0", 1'2"
7'0" Widths	2'0", 2'6", 2'8", 2'10", 3'0"		2'8", 2'10", 3'0"	1'0", 1'2"	
8'0" Widths	2'6", 2'8", 2'10", 3'0"		2'8", 2'10", 3'0"	1'0", 1'2"	1'0", 1'2"
Glass Sizes	114, 120, 122, 810, 820	106, 107, 135, 137, 228	106, 120, 122, 160, 228, 404, 810	151, 152, 852	129, 450

Belleville® Smooth



									
	Flush	2P Square	2P Hollister	Cheyenne. 2P Plank	4P Blank-Top	6P	SL w/ Full Glass	SL w/ 3/4 Glass	SL w/ 1/2 Glass
Door Material	BLS	BLS	BLS	BLS	BLS	BLS	BLS	BLS	BLS
6'8" Widths	2'0", 2'6", 2'8", 2'10", 3'0"	2'8", 2'10", 3'0"	2'8", 2'10", 3'0"	2'8", 2'10", 3'0"	2'8", 2'10", 3'0"	2'6", 2'8", 2'10", 3'0"	1'0", 1'0", 1'2"	1'0", 1'2"	1'0", 1'2"
7'0" Widths	2'0", 2'6", 2'8", 2'10", 3'0"					2'8", 2'10", 3'0"	1'0", 1'2"		
8'0" Widths	2'0", 2'6", 2'8", 2'10", 3'0"	2'8", 2'10", 3'0"	2'8", 2'10", 3'0"	2'8", 2'10", 3'0"		2'6", 2'8", 2'10", 3'0"	1'0", 1'2"	1'0", 1'2"	1'0", 1'2"
Glass Sizes	114, 120, 122, 300, 810, 820	106, 404	122, 304, 404	106, 107, 404	106, 107, 135, 137, 228	106, 120, 122, 160, 228, 404, 682, 810	151, 152, 155, 852	151, 450	129, 450

Material

BMT	Belleville. Mahogany Textured	BLS	Belleville. Smooth
BLT	Belleville. Oak Textured		

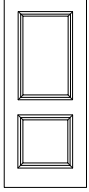
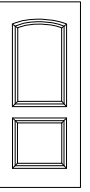
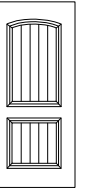
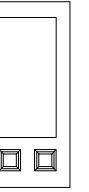

† Features narrow panel layout.

Masonite® HD Steel Door Series

						
	Flush	2P Square	2P Roman	2P Plank Camber-Top	2P w/ 23 X 65 C/O	Hollister. 2P
Door Material	MHD	MHD	MHD	MHD	MHD	MHD
6'8" Widths	2'0", 2'6", 2'8", 2'10", 3'0", 3'6"	2'8", 2'10", 3'0"	2'8", 2'10", 3'0"	2'8", 2'10", 3'0"		2'8", 2'10", 3'0"
7'0" Widths	2'0", 2'6", 2'8", 2'10", 3'0"	3'0"		3'0"		3'0"
8'0" Widths	2'0", 2'6", 2'8", 2'10", 3'0"	2'8", 2'10", 3'0"			2'8", 2'10", 3'0"	
Glass Sizes	114, 120, 122, 300, 810, 820	106, 404	106, 107	106, 107	122	404

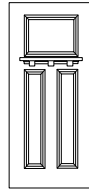
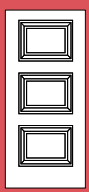
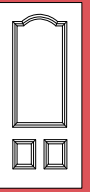
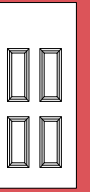
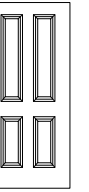
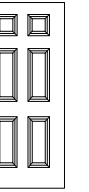
Note: To be discontinued Jan 2023

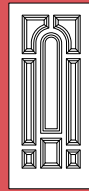
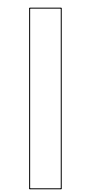
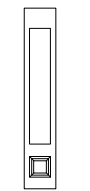
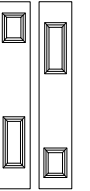
						
	Craftsman 3P	3P Equal	3P Arch-Top	4P Blank-Top	4P New England	6P
Door Material	MHD	MHD	MHD	MHD	MHD	MHD
6'8" Widths	2'8", 2'10", 3'0"	2'8", 2'10", 3'0"	2'8", 2'10", 3'0"	2'6", 2'8", 2'10", 3'0"	2'8", 2'10", 3'0"	2'6", 2'8", 2'10", 3'0"
7'0" Widths		3'0"		2'6", 2'8", 2'10", 3'0"		2'6", 2'8", 2'10", 3'0"
8'0" Widths						2'8", 2'10", 3'0"
Glass Sizes	217	217	304, 404	106, 107, 135, 137, 228	106	106, 120, 122, 160, 228, 404, 680, 810

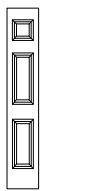



						
	8P Parliament	Flush SL	1P SL w/ 9 X 65 C/O	2P Universal SL	Craftsman & Hollister. SL	3P SL
Door Material	MHD	MHD	MHD	MHD	MHD	MHD
6'8" Widths	2'8", 2'10", 3'0"	10", 1'0", 1'2"	1'0", 1'2"	1'0", 1'2"	1'0", 1'2"	
7'0" Widths		1'0", 1'2"				1'0", 1'2"
8'0" Widths		10", 1'0", 1'2"	1'0", 1'2"			1'0", 1'2"
Glass Sizes	203	151, 152, 155, 852	151	129, 450, 680	617, 450	450, 680, 852



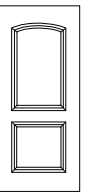
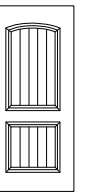
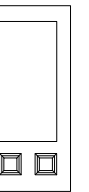

† Features narrow panel layout.

Material

MHD	Masonite. HD Steel	MUS	Masonite. Utility Steel
SHD	Sta-Tru. HD Steel		

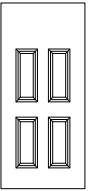
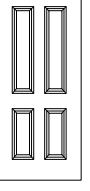
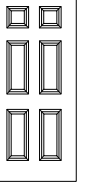
STA-TRU® HD Steel Door Series

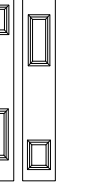
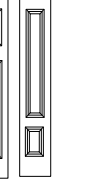
								
	Flush	2P Roman	2P Plank Camber-Top	2P W/ 23 X 65 C/O	Hollister. ST 2P	Craftsman 3P	3P Equal	3P Arch-Top
Door Material	SHD	SHD	SHD	SHD	SHD	SHD	SHD	SHD
6'8" Widths	2'0", 2'6", 2'8", 2'10", 3'0"	2'8", 2'10", 3'0"	2'8", 2'10", 3'0"		2'8", 2'10", 3'0"	2'8", 2'10", 3'0"	2'8", 2'10", 3'0"	2'8", 2'10", 3'0"
7'0" Widths	2'0", 2'6", 2'8", 2'10", 3'0"		3'0"		3'0"		3'0"	
8'0" Widths	2'6", 2'8", 2'10", 3'0"			2'8", 2'10", 3'0"				
Glass Sizes	114, 120, 122, 300, 810, 820	106, 107	106, 107	122	404	217	217	304, 404

								
	4P Blank-Top	4P New England	6P	8P Parliament	Flush SL	2P Universal SL	Craftsman & Hollister. SL	3P SL
Door Material	SHD	SHD	SHD	SHD	SHD	SHD	SHD	SHD
6'8" Widths	2'8", 2'10", 3'0"	2'8", 2'10", 3'0"	2'6", 2'8", 2'10", 3'0"	2'8", 2'10", 3'0"	10", 1'0", 1'2"	1'0", 1'2"	1'0", 1'2"	
7'0" Widths	2'6", 2'8", 2'10", 3'0"		2'6", 2'8", 2'10", 3'0"		10", 1'0", 1'2"			1'0", 1'2"
8'0" Widths			2'8", 2'10", 3'0"		10", 1'0", 1'2"			1'0", 1'2"
Glass Sizes	106, 107, 135, 137, 228	106	106, 120, 122, 160, 228, 404, 680, 810	203	151, 152, 155, 852	129, 450, 680	617, 450	450, 680, 852

Masonite® Utility Steel Door Series

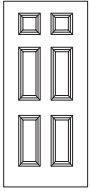
		
	Flush	6P
Door Material	MUS	MUS
6'8" Widths	2'0", 2'6", 2'8", 2'10", 3'0"	2'6", 2'8", 2'10", 3'0"
Glass Sizes	114, 120, 122, 300	106, 120, 122, 160, 228, 680

Fire-Rated / ADA / STC

COMPLIANT EXTERIOR DOORS

Fire-Rated / ADA

EXTERIOR DOOR OFFERING

MASONITE FIRE-RATED



Masonite, HD Steel Door / Door MHD-6

- ▶ Whether or not codes require fire-rated entry, enjoy the peace of mind that comes with knowing your home is more protected
- ▶ Masonite offers 20- and 90-minute fire-rated doors with the same on-trend architectural characteristics of our steel portfolio
- ▶ Masonite runs extensive testing at the R&D center to ensure the most stringent fire-rated building codes are met

†† 20- or 90-minute fire-rating must be specified when ordering.

MASONITE ADA



VistaGrande, Smooth Flush-Glazed Door with Clear Glass / Doors VSG-810-010-X

- ▶ Masonite is proud to offer several door designs with 10" bottom rails
- ▶ Complying with ADA (American Disabilities Act) standards, the offerings are available in a number of steel and fiberglass designs to suit many styles of architecture
- ▶ Masonite is continually creating new and innovative products that make every home more valuable and more enjoyable

Doors indicated as ADA eligible must be installed with ADA thresholds and ADA compliant hardware.

		WIDTHS		
		2/8	2/10	3/0
	Winslow® Fir Textured & Smooth			
	HFT - Craftsman 3P			
	6/8	🔥	🔥 ADA	🔥 ADA
	HGS - Craftsman 3P			
	6/8	🔥	🔥 ADA	🔥 ADA
	8/0	🔥	🔥 ADA	🔥 ADA

		WIDTHS		
		2/8	2/10	3/0
	Belleville® Mahogany Textured			
	BMT - Cheyenne, 2P plank			
	6/8	🔥	🔥	🔥
	BMT - 6P			
	6/8	🔥	🔥	🔥
	8/0	🔥	🔥	🔥

		WIDTHS				
		2/0	2/6	2/8	2/10	3/0
	Belleville® Oak Textured					
	BLT - Flush					
	6/8	🔥	🔥	🔥	🔥 ADA	🔥 ADA
	7/0	🔥	🔥	🔥	🔥 ADA	🔥 ADA
	8/0	🔥	🔥	🔥	🔥 ADA	🔥 ADA
	BLT - 6P					
	6/8			🔥	🔥 ADA	🔥 ADA
	7/0			🔥	🔥 ADA	🔥 ADA
	8/0			🔥	🔥	🔥

		WIDTHS				
		2/0	2/6	2/8	2/10	3/0
	Belleville® Smooth					
	BLS - Flush					
	6/8	🔥	🔥	🔥	🔥 ADA	🔥 ADA
	7/0	🔥	🔥	🔥	🔥 ADA	🔥 ADA
	8/0	🔥	🔥	🔥	🔥 ADA	🔥 ADA
	BLS - 2P Square					
	6/8			🔥	🔥	🔥 ADA
	8/0			🔥	🔥	🔥 ADA
	BLS - Cheyenne, 2p Plank					
	6/8			🔥	🔥	🔥
	8/0			🔥	🔥	🔥
	BLS - 6P					
	6/8			🔥	🔥 ADA	🔥 ADA
	7/0			🔥	🔥 ADA	🔥 ADA
	8/0			🔥	🔥	🔥

🔥 - Available as 20-Minute Fire-Rated / ADA - ADA eligible door / Please specify Fire-Rating or ADA when ordering. ADA bottom panel may not line up with sidelites. / 20-Minute positive pressure Category B with hose steam

Fire-Rated / ADA

EXTERIOR DOOR OFFERING

	Masonite® HD Steel	WIDTHS				
		2/0	2/6	2/8	2/10	3/0
	MHD - Flush					
	6/8	🔥	🔥	🔥	🔥 ADA	🔥 ADA
	7/0	🔥	🔥	🔥	🔥 ADA	🔥 ADA
	MHD - 2P Square					
	6/8	🔥	🔥	🔥	🔥 ADA*	🔥 ADA*
	7/0					🔥
	MHD - 2P Roman					
	6/8	🔥	🔥	🔥	🔥 ADA	🔥 ADA
	MHD - 2P Plank Camber-Top					
	6/8	🔥	🔥	🔥	🔥 ADA	🔥 ADA
	7/0					🔥
	MHD - Hollister. 2P					
	6/8	🔥	🔥	🔥	🔥	🔥
	7/0					🔥
	MHD - Craftsman 3P					
	6/8	🔥	🔥	🔥	🔥 ADA	🔥 ADA
	MHD - 3P Equal					
	6/8	🔥	🔥	🔥	🔥 ADA	🔥 ADA
	7/0					🔥
	MHD - 3P Arch-Top					
	6/8	🔥	🔥	🔥	🔥	🔥
	MHD - 4P Blank-Top					
	6/8				ADA	ADA
	MHD - 4P New England					
	6/8	🔥	🔥		🔥 ADA	🔥 ADA
	MHD - 6P					
	6/8	🔥	🔥	🔥	🔥 ADA	🔥 ADA
	7/0	🔥	🔥	🔥	🔥	🔥
	MHD - 8P Parliament					
	6/8	🔥	🔥	🔥	🔥	🔥

🔥 - Available as 20 or 90-Minute Fire-Rated / ADA - ADA eligible door (Steel-edge only, Prem spec only) / Please specify Fire-Rating or ADA when ordering / ADA bottom panel may not line up with sidelites. / Wood-Edge is 20-Minute only in 6/8 and 7/0 heights, Steel-Edge is 90-Minute in 6/8, 7/0 and 8/0 heights, Masonite® HD or Sta-Tru® HD and opaque only. / 20-Minute positive pressure Category B with hose steam 90-Minute positive pressure Category B / *MHD-2P Square - ADA eligible door (Steel-edge, Masonite spec with 9-1/4" bottom rail)

Fire-Rated / ADA

EXTERIOR DOOR OFFERING

	STA-TRU® HD Steel	WIDTHS				
		2/0	2/6	2/8	2/10	3/0
	SHD - Flush					
	6/8	🔥	🔥	🔥	🔥 ADA	🔥 ADA
	7/0	🔥	🔥	🔥	🔥 ADA	🔥 ADA
	SHD - 2P Roman					
	6/8	🔥	🔥	🔥	🔥 ADA	🔥 ADA
	SHD - 2P Plank Camber-Top					
	6/8	🔥	🔥	🔥	🔥 ADA	🔥 ADA
	7/0					🔥
	SHD - Hollister. 2P					
	6/8	🔥	🔥	🔥	🔥	🔥
	7/0					🔥
	SHD - Craftsman 3P					
	6/8	🔥	🔥	🔥	🔥 ADA	🔥 ADA
	SHD - 3P Equal					
	6/8	🔥	🔥	🔥	🔥 ADA	🔥 ADA
	7/0					🔥
	SHD - 3P Arch-Top					
	6/8	🔥	🔥	🔥	🔥	🔥
	SHD - 4P Blank-Top					
	6/8				ADA	ADA
	SHD - 4P New England					
	6/8				🔥 ADA	🔥 ADA
	SHD - 6P					
	6/8	🔥	🔥	🔥	🔥 ADA	🔥 ADA
	7/0	🔥	🔥	🔥	🔥	🔥
	SHD - 8P Parliament					
	6/8	🔥	🔥	🔥	🔥	🔥

🔥 - Available as 20 or 90-Minute Fire-Rated / ADA - ADA eligible door (Steel-edge only, Prem spec only) / Please specify Fire-Rating or ADA when ordering / ADA bottom panel may not line up with sidelites. / Wood-Edge is 20-Minute only in 6/8 and 7/0 heights, Steel-Edge is 90-Minute in 6/8, 7/0 and 8/0 heights, Masonite. HD or Sta-Tru. HD and opaque only. / 20-Minute positive pressure Category B with hose steam 90-Minute positive pressure Category B / *MHD-2P Square - ADA eligible door (Steel-edge, Masonite spec with 9-1/4" bottom rail)



RIVERCITYMILLWORK.COM

CONTACT US

Phone : 815-965-9439

Toll Free: 800-892-9297

Fax: 815-965-2678

Email: orders@rivercitymillwork.com

Address: 200 Quaker Road. Rockford, IL 61104

JULY 2022

Proudly Distributed By

**RIVER CITY
MILLWORK**