



# 21 / 22

Product selector | Guide de sélection de produit

# Your One-Stop-Shop Solution

## Votre solution tout-en-un

### **PB** Particleboard Panneaux de particules

**TAFIPAN®**

certified/certifié  
EPA TSCA Title VI

p. 4

**VOLO®**

certified/certifié  
ULEF

p. 4

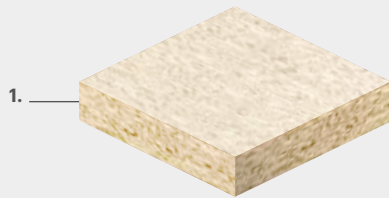

1. Tafisa® particleboard  
Panneau de particules Tafisa®

### **TFL** Thermally Fused Laminate Panneaux décoratifs

**PRÉLUDE®**  
SÉRIE • SERIES

p. 18

**SOMMET®**  
SÉRIE • SERIES

p. 12

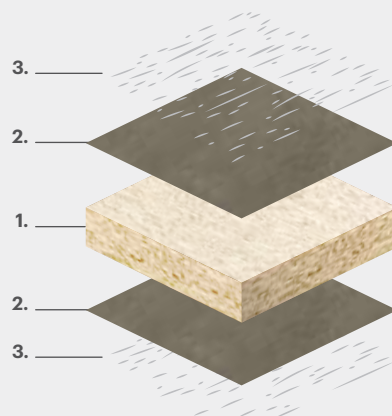

1. Tafisa® particleboard  
Panneau de particules Tafisa®
2. Tafisa® decorative paper  
Papier décoratif Tafisa®
3. Tafisa® All-Over Prélude texture  
Texture universelle Prélude  
de Tafisa®

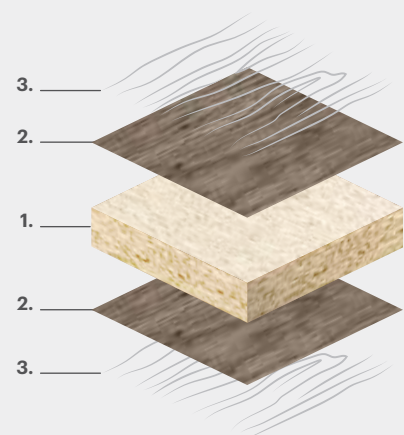

1. Tafisa® particleboard  
Panneau de particules Tafisa®
2. Tafisa® decorative paper  
Papier décoratif Tafisa®
3. Embossed and In-Register  
Sommet texture (EIR)  
Texture Sommet à embossage  
synchronisé (EIR)

\$

At Tafisa®, you'll find the inspiration and products you need to design truly unique, fashion-forward spaces that stand the test of time. Choose from our Lummia, Sommet and Prélude lines—all backed by our outstanding quality and service.

Chez Tafisa®, vous trouverez l'inspiration et les produits dont vous avez besoin pour concevoir des espaces uniques qui traverseront les années avec style et élégance. Choisissez parmi nos séries Lummia, Sommet et Prélude, toutes dotées d'une qualité et d'un service remarquables.

**SURFORMA® HPL** High Pressure Laminate  
Feuilles de stratifié

**LUMMIA™** Superior coating technology  
Technologie de laquage supérieure

**PRÉLUDE®**  
SÉRIE • SERIES

p. 18

**SOMMET®**  
SÉRIE • SERIES

p. 12

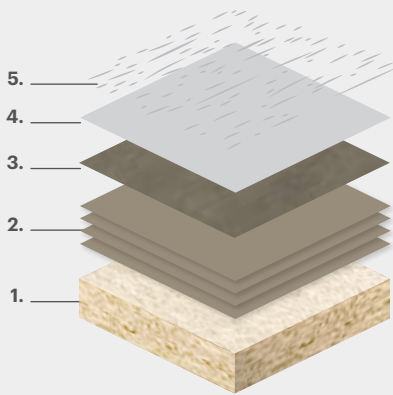

**PERFECT MATT  
MAT ABSOLU**

p. 8

**HIGH GLOSS  
LUSTRE TOTAL**

p. 10

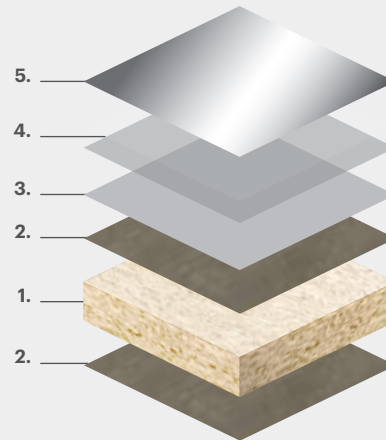

Two-step process / Procédé en deux étapes

\$\$

- |   |                         |
|---|-------------------------|
| 1. Tafisa® particleboard<br>Panneau de particules Tafisa®   | <b>Step 1 / Étape 1</b> |
| 2. Kraft paper<br>Papiers kraft   | <b>Step 2 / Étape 2</b> |
| 3. Tafisa® decorative paper<br>Papier décoratif Tafisa®   |                         |
| 4. Wear layer protection<br>Couche protectrice contre l'usure   |                         |
| 5. Tafisa® All-Over (Prélude) or EIR (Sommet) texture<br>Texture universelle (Prélude) ou EIR (Sommet) de Tafisa® |                         |

\$\$\$

- |   |
|---|
| 1. Tafisa® particleboard<br>Panneau de particules Tafisa®                                   |
| 2. Tafisa® decorative paper<br>Papier décoratif Tafisa®                                     |
| 3. Functional coating layer<br>Couche fonctionnelle   |
| 4. Protective base coats<br>Couches de base protectrices                                    |
| 5. Top coat (Perfect Matt OR High Gloss)<br>Couche de finition (Mat Absolu OU Lustre Total) |

**Complementary Products**

We offer a complete range of durable, high-quality products to meet all your project needs, from dream to delivery.

**Produits complémentaires**

Nous offrons une gamme complète de produits polyvalents répondant à tous vos besoins, de la conception à la livraison.



## TFL or/ou LUMMIA

### Decorative Panels

Ideal for furniture, bathroom and kitchen furnishings, doors of all kinds, storage systems, wall/ceiling cladding, etc. Perfect for residential and commercial furniture. Recommended for vertical and horizontal applications with **moderate impact and moderate use**.

### Panneaux décoratifs

Parfaits pour le mobilier, l'ameublement de salle de bain et de cuisine, les portes en tous genres, les modules de rangement, l'habillage mural/plafond, etc. Nos panneaux sont un choix idéal pour tous vos projets, autant commerciaux que résidentiels. Recommandés pour toutes les applications verticales et pour les applications horizontales exigeant une **résistance modérée à l'usure et aux chocs**.

## HPL

### High Pressure Laminate

These include countertops, tables, furniture, bathroom and kitchen furnishings, doors of all kinds, storage system, wall/ceiling cladding, etc. Ideal for residential and commercial furniture. Recommended for vertical and horizontal applications requiring **high impact and high wear resistance**.

### Feuilles de stratifié

Parfaits pour les comptoirs, les tables, le mobilier, l'ameublement de salle de bain et de cuisine, les portes de tous genres, les modules de rangement, l'habillage mural/plafond, etc. Nos feuilles de stratifié sont un choix idéal pour tous vos projets, autant commerciaux que résidentiels. Recommandées pour les applications verticales et horizontales exigeant une **grande résistance à l'usure et aux chocs**.

**Surforma®**, our proprietary HPL sheets**Different,  
Yet the Same**

**Tafisa® has developed the best matched TFL-HPL program in the industry. A total game-changer!**

Our HPL is manufactured by Tafisa®'s sister company—SURFORMA by Sonae Industria—offering a complete, harmonized line of HPL to our TFL Prélude and Sommet Embossed-in-Register (EIR) Series. Enjoy one-stop shopping for our TFL, HPL & PB with matching complementary products (like edgebandings and mouldings) throughout our distribution network.

- Made from the same textured plates and decor papers
- Vertical-Grade Postformable (VGP/PF) 0.80 mm (0.031")
- All Sommet Series colours and several Prélude colours are available with FSC® Mix
- Certified Class III / C for flame spread and smoke development
- Meet or exceed all NEMA LD3 standard requirements
- Antimicrobial properties
- Available in 9 Tafisa® textures
- NSF Certified

**HPL**  
SURFORMA®

**TFL**

**Surforma®**, nos feuilles de stratifié maison**Différentes  
et pareilles à la fois**

**Tafisa® a mis au point le meilleur programme d'agencement de panneaux décoratifs (TFL) et de stratifiés (HPL) de l'industrie. C'est une véritable révolution !**

Notre HPL est fabriqué par la société soeur de Tafisa®, SURFORMA par Sonae Industria. C'est une gamme complète de stratifiés (HPL) qui permet un agencement parfait avec les panneaux décoratifs de la série Prélude et de la série Sommet à embossage synchronisé (EIR). Une solution tout-en-un pour les panneaux décoratifs, les stratifiés et les panneaux de particules bruts, de même que pour les gammes de produits complémentaires, comme les bandes de chant et moulures, offerts dans notre réseau de distribution.

- Fabrication à partir des mêmes plaques de textures et papiers décoratifs
- Grade vertical postformable (VGP/PF) 0,80 mm (0,031")
- Tous les coloris de la série Sommet ainsi que plusieurs de la série Prélude sont offerts avec la certification FSC® Mixte
- Certifié Classe III / C pour la propagation de flamme et développement de fumée
- Satisfaction ou dépassement de toutes les exigences de la norme NEMA LD3
- Propriétés antimicrobiennes
- Gamme offerte dans 9 textures Tafisa®
- Certifié NSF

# Creating Healthy Spaces Créer des espaces sains



TAFIPAN® and EVOLO™ panels meet or exceed all third-party certifications and are widely recognized within the industry for their preservation of healthy living spaces.

*Les panneaux TAFIPAN® et EVOLO™ satisfont ou surpassent les exigences de toutes les normes de certifications accordées par des tierces parties et sont reconnus dans l'industrie pour leur capacité à préserver des espaces de vie sains.*

## TAFIPAN®

Can contribute up to / Peut contribuer jusqu'à :



Controlled Formaldehyde Emissions of less than:  
Émissions contrôlées de formaldéhyde inférieures à :

< 0.09 ppm

## EVOLO™

Can contribute up to / Peut contribuer jusqu'à :



Controlled Formaldehyde Emissions of less than:  
Émissions contrôlées de formaldéhyde inférieures à :

< 0.05 ppm

### Third-party certifications / Certifications par des tierces parties



HPL Only  
HPL Seulement



# Green to the Core

## La fibre verte

At Tafisa®, we're fully committed to meeting our wood-supply needs without compromising the environment for future generations. So, naturally, after the construction of our wood-recycling facility, aptly named Rewood™, we soon began using wood materials recycled from the construction and demolition sector in the composition of our panel products. Today, the use of recycled wood throughout our production process is fully integrated for the good of all.

Chez Tafisa®, nous sommes totalement engagés à maintenir un approvisionnement en bois constant et renouvelable sans compromettre l'environnement que nous léguerons aux générations futures. Dans cette perspective, nos installations Rewood<sup>MC</sup> nous ont permis d'intégrer des fibres de bois provenant de matériaux recyclés des secteurs de la construction et de la démolition urbaine, et ce, pour le bien de tous.

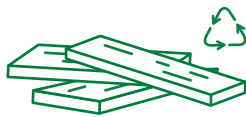
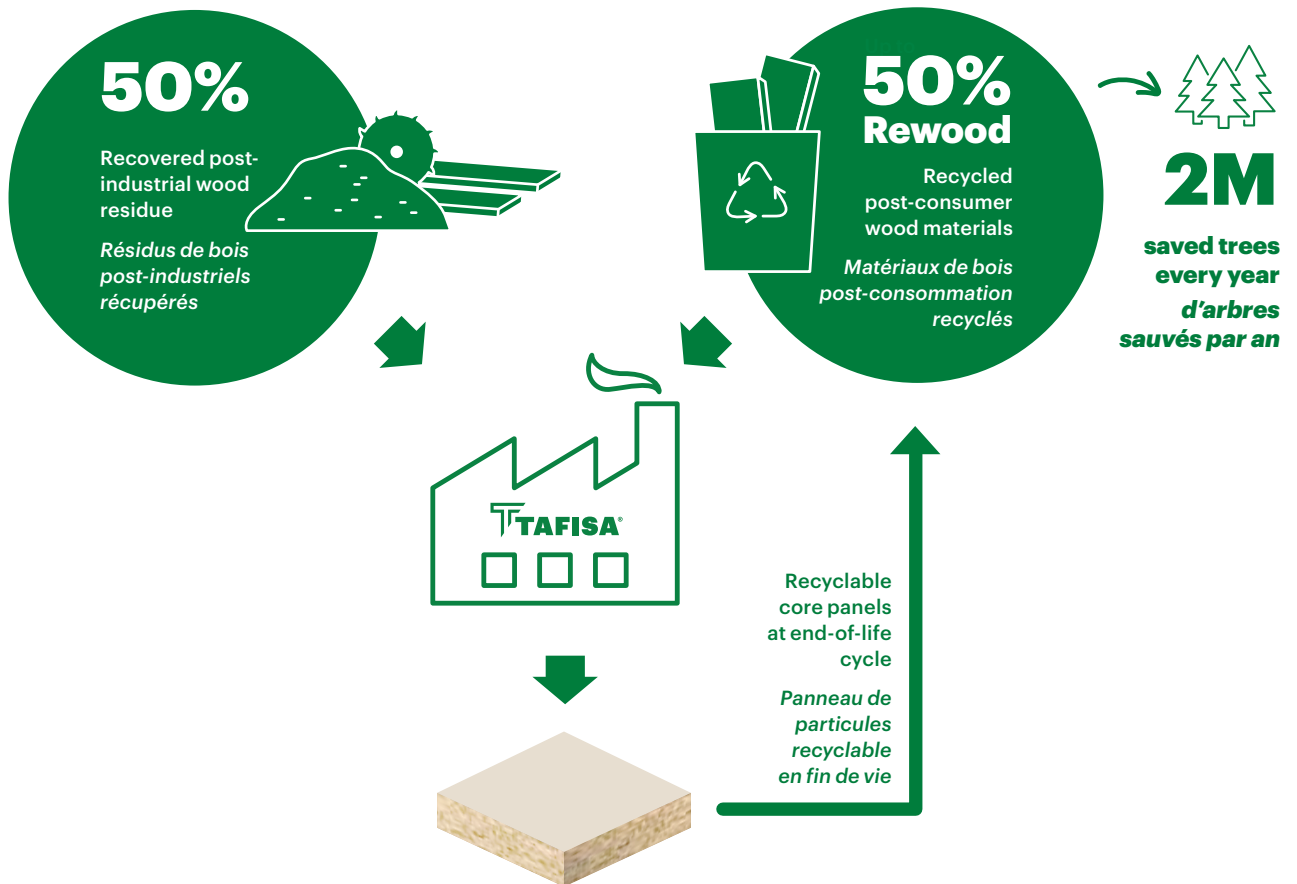

**244 000 t.**

recycled post-consumer wood yearly  
de bois recyclés post-consommation par an

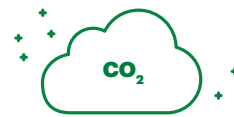

**700 000 t.**

carbon stored in our panels yearly  
de carbone stocké dans nos panneaux par an

# LUMMIA<sup>TM/MC</sup>

TECHNOLOGIE • TECHNOLOGY

new  
nouveau

## Brilliant by Nature

## Allumée de nature

Offered in High Gloss or Perfect Matt finishes, Lummia lacquered panels are the ideal choice to meet the needs of today's design professionals and consumers.

What's more, their outstanding machinability, remarkable resistance to scratches and fingerprints and vast range of colours make them ideal for virtually any application.

*Offerts en finis Lustre Total ou Mat Absolu, les panneaux laqués Lummia répondent plus que jamais aux besoins des professionnels et des consommateurs. De plus, leur excellente usinabilité, leur résistance remarquable aux rayures et aux traces de doigts et le vaste choix de couleurs proposées conviennent à une multitude d'applications.*





Outstanding  
anti-fingerprinting  
*Résistance exceptionnelle  
aux traces de doigts*



Highly scratch resistant  
*Résistant aux rayures*



Exceptional machinability  
*Usinabilité exceptionnelle*



Easy maintenance  
*Facilité d'entretien*



UV light resistant  
*Résistant à la lumière UV*



Heat resistant  
*Résistant à la chaleur*



Superior coating technology  
on 1 or 2 side(s)  
*Technologie supérieure de  
laquage sur 1 ou 2 côté(s)*



Impressive depth effect  
*Impression de profondeur  
saisissante*



Smooth, velvety touch  
*Doux au toucher*



Dimensional stability  
*Stabilité dimensionnelle*



Increasing adhesion with time  
*Adhésion accrue avec le temps*



Assorted mouldings  
*Moulures assorties*

# LUMMIA<sup>TM/MC</sup>

## PERFECT MATT

Solid Colours

## MAT ABSOLU

Couleurs unies



Carte Blanche | *Carte Blanche*

PM115

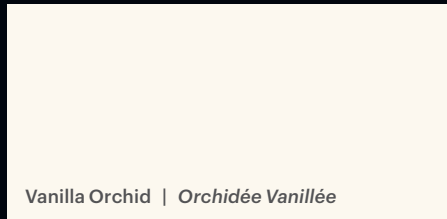

Vanilla Orchid | *Orchidée Vanillée*

PM100

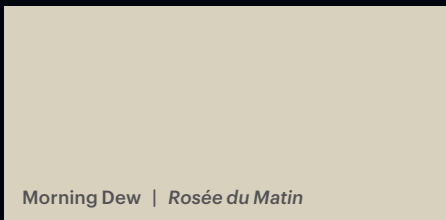

Morning Dew | *Rosée du Matin*

PM763

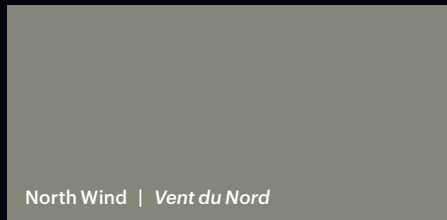

North Wind | *Vent du Nord*

PM771

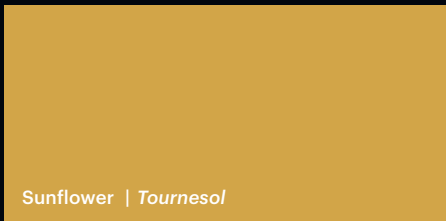

Sunflower | *Tournesol*

PM774

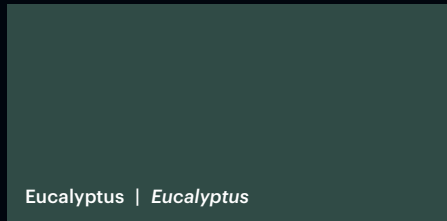

Eucalyptus | *Eucalyptus*

PM773

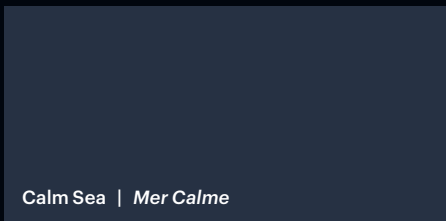

Calm Sea | *Mer Calme*

PM772

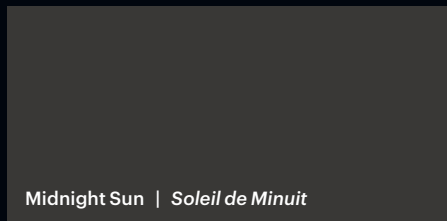

Midnight Sun | *Soleil de Minuit*

PM765

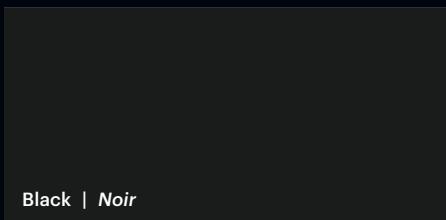

Black | *Noir*

PM203



**PERFECT MATT**

**Metal and Concrete**

**MAT ABSOLU**

**Métal et béton**

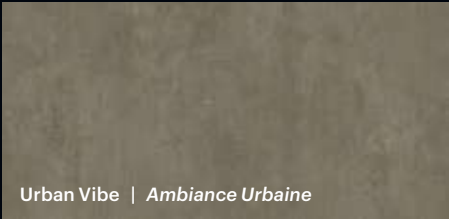

Urban Vibe | *Ambiance Urbaine*

**PM832**

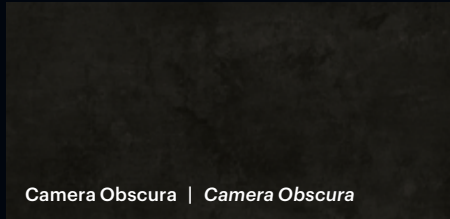

Camera Obscura | *Camera Obscura*

**PM835**



**PM765**

Midnight Sun  
*Soleil de Minuit*

To see the pattern repeat of each colour, and complementary products available, visit [tafisa.ca](https://www.tafisa.ca)

*Pour voir la répétition du motif de chacun des coloris et pour les produits complémentaires offerts, visitez [tafisa.ca](https://www.tafisa.ca)*

# LUMMIA<sup>TM/MC</sup>

**HIGH GLOSS**

**LUSTRE TOTAL**

**Solid Colours**

**Couleurs unies**

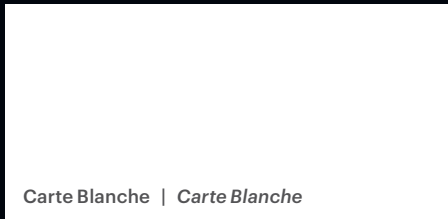

Carte Blanche | *Carte Blanche*

**HG115**

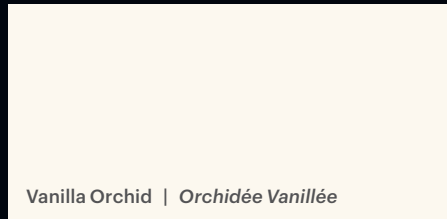

Vanilla Orchid | *Orchidée Vanillée*

**HG100**

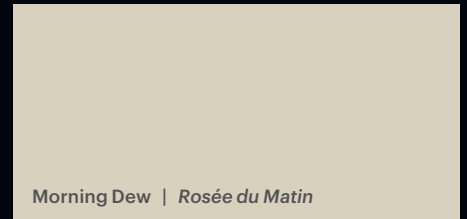

Morning Dew | *Rosée du Matin*

**HG763**

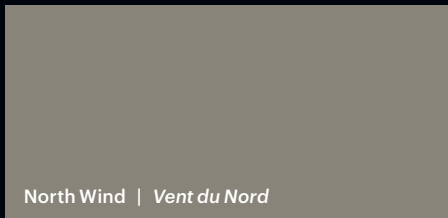

North Wind | *Vent du Nord*

**HG771**

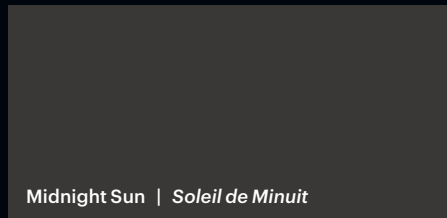

Midnight Sun | *Soleil de Minuit*

**HG765**

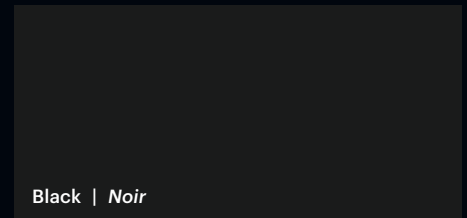

Black | *Noir*

**HG203**



**HG100**

Vanilla Orchid  
*Orchidée Vanillée*

**HIGH GLOSS LUSTRE TOTAL**

**Metals**

**Métaux**

**HG834**

Iron Horse  
*Cheval de Fer*

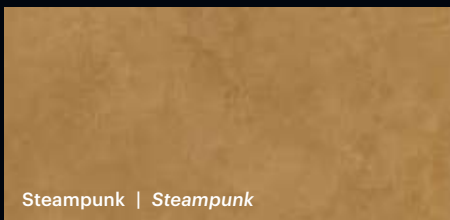

Steampunk | *Steampunk*

**HG833**



Iron Horse | *Cheval de Fer*

**HG834**

To see the pattern repeat of each colour, and complementary products available, visit [tafisa.ca](http://tafisa.ca)

*Pour voir la répétition du motif de chacun des coloris et pour les produits complémentaires offerts, visitez [tafisa.ca](http://tafisa.ca)*

# SOMMET®

SÉRIE • SERIES

**M2032(B)**

Treasure Trove  
Trésor Caché

**The True  
Touch of  
Wood™**

**La vraie  
nature  
du bois<sup>MC</sup>**

With the Sommet® line from Tafisa®, reality is at last a true reflection of nature. Choose from a wide range of products designed to evoke the look, feel and essence of wood to enhance any living or working space. Sommet, the peak of warmth and comfort.

*Grâce à la gamme Sommet® de Tafisa®, la réalité devient enfin le reflet véritable de la nature. Quel que soit l'espace de vie ou de travail à mettre en valeur, faites votre choix parmi une vaste sélection de produits conçus pour évoquer l'aspect, le ressenti et l'essence du bois.*

# FERIA<sup>TM</sup><sub>MC</sub>

FERIA<sup>TM</sup> appeals to the senses with warm colours and a feeling that evokes movement and rhythm, while capturing the essence of hickory, a trusted wood known for its lightness and durability.

*FERIA<sup>MC</sup> stimule les sens avec originalité en s'imprégnant de l'essence du caryer (hickory), un bois fiable reconnu pour sa légèreté et sa durabilité.*

# BRAVA<sup>TM</sup><sub>MC</sub>

Inspired by teak, a noble and timeless wood, BRAVA<sup>TM</sup> creates a lasting impression with its rich cathedral motifs—a striking look and feel designed to stand the test of time.

*Inspiré du teck, un bois noble qui a traversé les époques, BRAVA<sup>MC</sup> crée une impression mémorable par la richesse des motifs de ses cathédrales.*

# VIVA<sup>TM</sup><sub>MC</sub>

Designed from a rare wood rich in character, VIVA<sup>TM</sup> comes with a unique butternut texture and woodgrain structure offering elegance and refinement.

*La texture et la structure du bois uniques de VIVA<sup>MC</sup> révèlent noblesse et élégance. Conçue à partir du noyer cendré (butternut), une essence de bois rare et riche en caractère.*

## **2 formats, 1 singularly impeccable finish**

No matter which panel size you choose, they can all be combined because they feature the same pattern, texture and colour.

## **Deux formats, un seul fini impeccable**

*Peu importe le format de nos panneaux, ils peuvent être combinés car ils ont le même motif, la même texture et la même couleur.*



# SOMMET®

SÉRIE • SERIES

**Woodgrains**  
White

**Grains de bois**  
Blanc



**M2004(Y)**

Winter Fun!  
Bain de Neige!

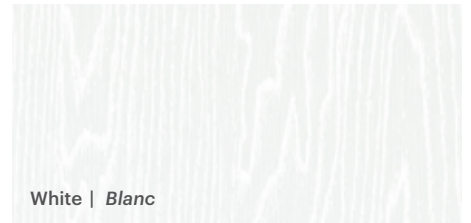

White | Blanc

TFL M175 (Y) | HPL T175 (VA)  
TFL M175 (B) | HPL T175 (BV)

**VIVA®**  
**BRAVA®**



Winter Fun! | Bain de Neige!

TFL M2004 (Y) | HPL T2004 (VA)

**VIVA®**



First Dance | Première Danse

TFL M2051 (F) | HPL T2051 (FE)

**FERIA®**



## Woodgrains

## Grains de bois

Grey  
Black

Gris  
Noir

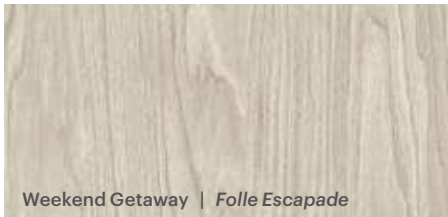

Weekend Getaway | *Folle Escapade*

TFL M2003 (Y) | HPL T2003 (VA) **VIVA**

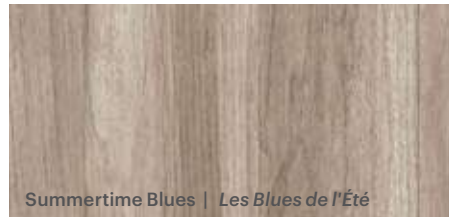

Summertime Blues | *Les Blues de l'Été*

TFL M2013 (Y) | HPL T2013 (VA) **VIVA**

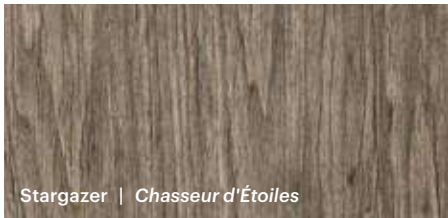

Stargazer | *Chasseur d'Étoiles*

TFL M2011 (Y) | HPL T2011 (VA) **VIVA**



Sunset Cruise | *Virée en Cabriolet*

TFL M2002 (Y) | HPL T2002 (VA) **VIVA**

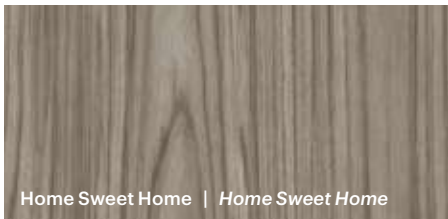

Home Sweet Home | *Home Sweet Home*

TFL M2034 (B) | HPL T2034 (BV) **BRAVA**



Black Tie | *Cravate Noire*

TFL M2035 (B) | HPL T2035 (BV) **BRAVA**



Tête-à-Tête | *Tête-à-Tête*

TFL M2001 (Y) | HPL T2001 (VA) **VIVA**



After-Hours | *After-Hours*

TFL M2010 (Y) | HPL T2010 (VA) **VIVA**



Night Owl | *Oiseau de Nuit*

TFL M2056 (F) | HPL T2056 (FE) **FERIA**

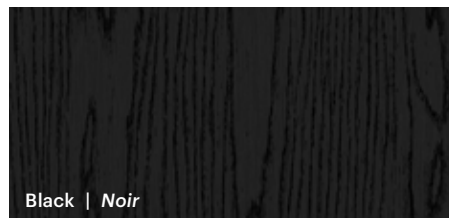

Black | *Noir*

TFL M203 (Y) | HPL T203 (VA) **VIVA**  
TFL M203 (B) | HPL T203 (BV) **BRAVA**

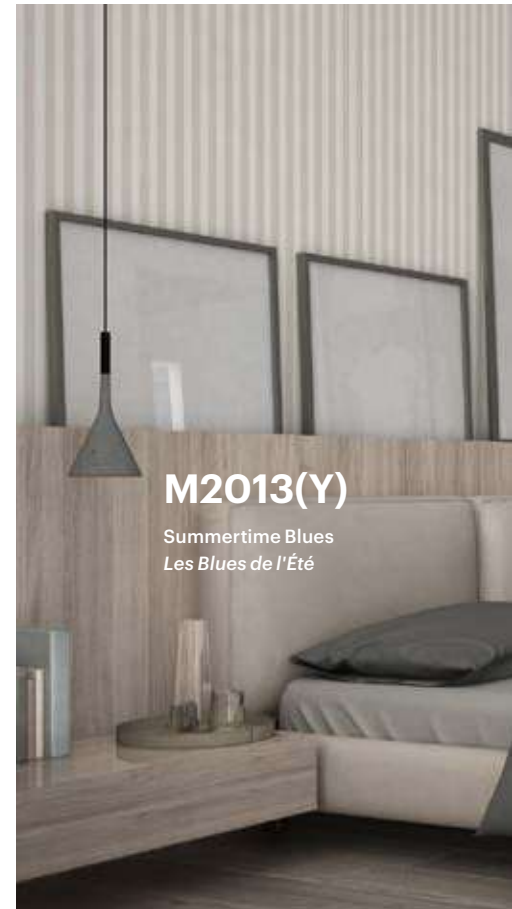

**M2013(Y)**

Summertime Blues  
*Les Blues de l'Été*

To see the pattern repeat of each colour, and complementary products available, visit [tafisa.ca](http://tafisa.ca)

Pour voir la répétition du motif de chacun des coloris et pour les produits complémentaires offerts, visitez [tafisa.ca](http://tafisa.ca)

# SOMMET®

SÉRIE • SERIES

**Woodgrains**  
Natural Blond

**Grains de bois**  
*Blond naturel*



**M2052(F)**

Golden Light  
*Heure Dorée*



Crème de la Crème | *Crème de la Crème*

TFL **M2031(B)** | HPL **T2031(BV)** **BRAVA®**



Casting at First Light | *Preneur de l'Aube*

TFL **M2007(Y)** | HPL **T2007(VA)** **VIVA®**

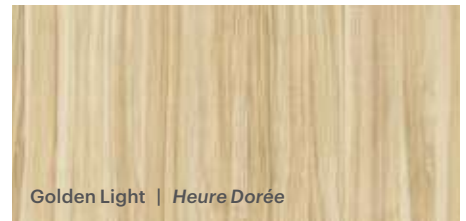

Golden Light | *Heure Dorée*

TFL **M2052(F)** | HPL **T2052(FE)** **FERIA®**

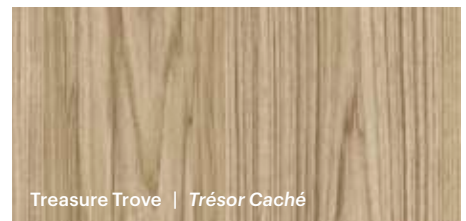

Treasure Trove | *Trésor Caché*

TFL **M2032(B)** | HPL **T2032(BV)** **BRAVA®**

## Woodgrains

Brown

## Grains de bois

Brun



New Wave | *Nouvelle Vague*

TFL **M2041 (B)** | HPL **T2041 (BV)**

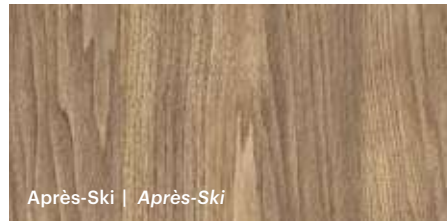

Après-Ski | *Après-Ski*

TFL **M2015 (Y)** | HPL **T2015 (VA)**

**VIVA**



Brass Band | *Fanfare de Cuivres*

TFL **M2053 (F)** | HPL **T2053 (FE)**

**FERIA**

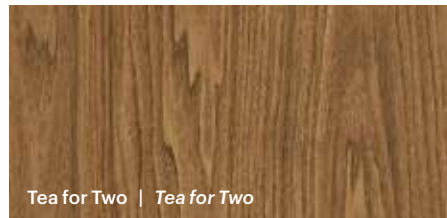

Tea for Two | *Tea for Two*

TFL **M2006 (Y)** | HPL **T2006 (VA)**

**VIVA**

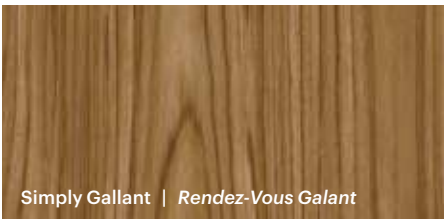

Simply Gallant | *Rendez-Vous Galant*

TFL **M2033 (B)** | HPL **T2033 (BV)**

**BRAVA**



Sugar on Ice | *Partie de Sucre*

TFL **M2014 (Y)** | HPL **T2014 (VA)**

**VIVA**



Sunday Stroll | *Promenade du Dimanche*

TFL **M2054 (F)** | HPL **T2054 (FE)**

**FERIA**

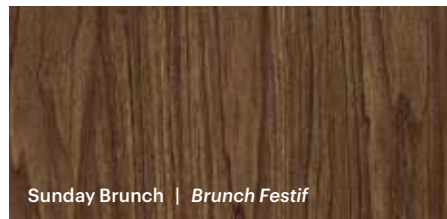

Sunday Brunch | *Brunch Festif*

TFL **M2005 (Y)** | HPL **T2005 (VA)**

**VIVA**

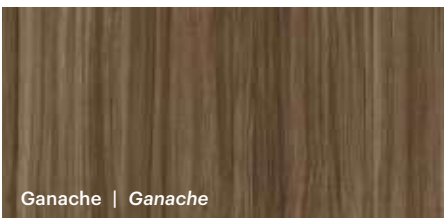

Ganache | *Ganache*

TFL **M2055 (F)** | HPL **T2055 (FE)**

**FERIA**



**M2005(Y)**

Sunday Brunch  
Brunch Festif

To see the pattern repeat of each colour, and complementary products available, visit [tafisa.ca](http://tafisa.ca)

Pour voir la répétition du motif de chacun des coloris et pour les produits complémentaires offerts, visitez [tafisa.ca](http://tafisa.ca)

# PRÉLUDE®

SÉRIE • SERIES

L540(A)

Summer Breeze  
Brise d'Été

**Imagine.  
Create.  
Combine.**  
**Imaginez.  
Créez.  
Agencez.**

If you can imagine it, you can create it with the complete collection of Prélude products, as varied and colourful as they are practical and durable. Choose from a wide variety of textures and colours and combine them to create a world all your own.

*Si vous pouvez l'imaginer, vous pouvez le créer grâce à la collection complète de produits Prélude, aussi variés et colorés que pratiques et durables. Faites votre choix parmi une large palette de textures et de coloris, et combinez-les afin de créer votre propre univers.*

## karisma

**karisma's** magnetism has made it a go-to industry staple. Its random mix of brush-stroked embossing and matte-infused accents give it a natural, authentic look.

*karisma exerce son pouvoir d'attraction et devient un incontournable de l'industrie. Son embossage au look brossé et aux porosités plus mates répartis de façon aléatoire lui confère son look naturel et authentique.*

new  
nouveau

## alto

**alto's** linear design mimics the look of reconstituted wood veneer. It features a striking fusion of matte and glossy accents woven throughout the pattern.

*alto imite l'aspect linéaire d'un plaquage de bois reconstitué. L'alternance de ses zones mates et lustrées amplifie une texture au relief accentué.*

## crystalite

An industry classic, **crystalite** features a simple, universal pattern. With high wear resistance, it's designed to stand the test of time.

*Classique dans l'industrie, crystalite affiche un motif simple et universel. Sa résistance à l'usure fait d'elle une texture à l'épreuve du temps.*

## smoothwood bois satiné

The **smoothwood** finish is reminiscent of hardwood cabinetry. Its soft, satin surface and gentle pores give this texture designer-approved finesse.

*La texture bois satiné évoque avec subtilité la finition des bois durs d'ébénisterie. Elle comporte une douce surface satinée et de très légers pores qui lui confèrent une finesse appréciée des connaisseurs.*

## isola

Soft to the touch, **isola** diffuses light like no other texture. Elegant and durable, it's a perfect complement to solid colours.

*isola est une texture douce au toucher qui diffuse la lumière comme pas une. Elle est élégante, durable et agrémentera parfaitement les couleurs unies.*

## urbania

**urbania** is inspired by the woodgrain pattern commonly found on quarter cut and rift cut veneers. With a clean linear look, this texture is modern yet timeless.

*urbania simule un motif de pores de bois qu'on retrouve habituellement sur du plaquage sur quartier et sur rive (rift). La linéarité de son motif rend cette texture à la fois moderne et intemporelle.*

# PRÉLUDE®

SÉRIE • SERIES

Woodgrains

Grains de bois

White

Blanc



**L565(R)**

Fogo Harbour  
Havre de Fogo



Latitude North | *Latitude Nord*

TFL L530 (A) | HPL T530 (AT)

**alto**

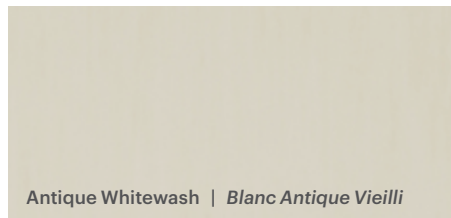

Antique Whitewash | *Blanc Antique Vieilli*

TFL L475 (C) | HPL T475 (CR)

**crystalite**

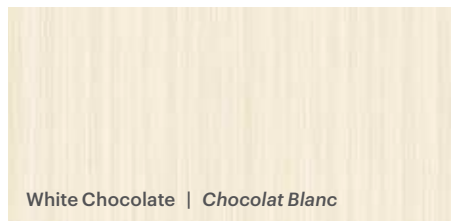

White Chocolate | *Chocolat Blanc*

TFL L492 (R) | HPL T492 (UR)

**urbania**

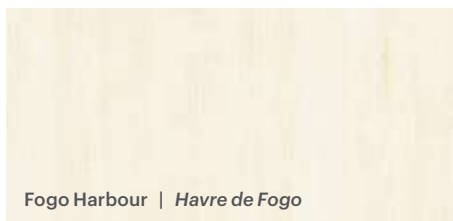

Fogo Harbour | *Havre de Fogo*

TFL L565 (R) | HPL T565 (UR)

**urbania**



Frost Flower | *Fleur de Givre*

TFL L823 (I) | HPL T823 (IS)

**isola**

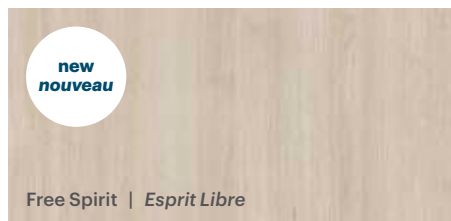

Free Spirit | *Esprit Libre*

TFL L580 (K) | HPL T580 (KA)

**karisma**



Niagara | *Niagara*

TFL L544 (A) | HPL T544 (AT)

**alto**

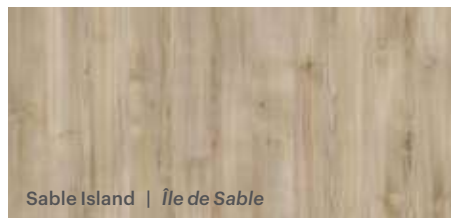

Sable Island | *Île de Sable*

TFL L562 (R) | HPL T562 (UR)

**urbania**

## Woodgrains and Concrete

Grey

## Grains de bois et béton

Gris



Force of Nature | *Force de la Nature*

TFL L830 (K) | HPL T830 (KA)

**karisma**

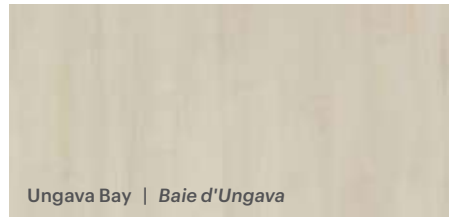

Ungava Bay | *Baie d'Ungava*

TFL L566 (R) | HPL T566 (UR)

**urbania**



River Rock | *Petit-Rocher*

TFL L538 (A) | HPL T538 (AT)

**alto**



Brushed Aluminum | *Aluminium Brossé*

TFL L474 (C) | HPL T474 (CR)

**crystalite**

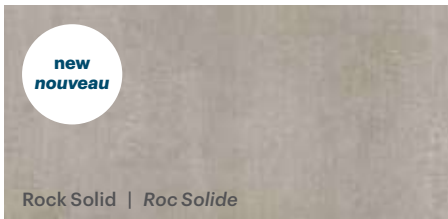

Rock Solid | *Roc Solide*

TFL L831 (K) | HPL T831 (KA)

**karisma**

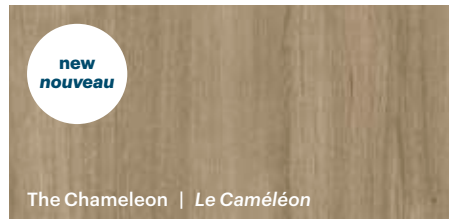

The Chameleon | *Le Caméléon*

TFL L584 (K) | HPL T584 (KA)

**karisma**

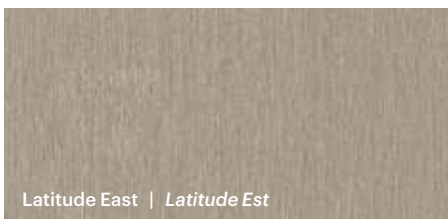

Latitude East | *Latitude Est*

TFL L533 (A) | HPL T533 (AT)

**alto**

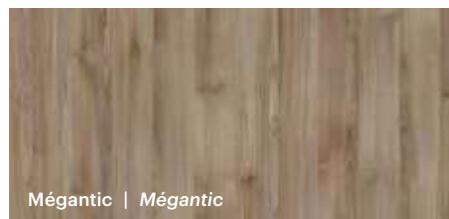

Mégantic | *Mégantic*

TFL L563 (R) | HPL T563 (UR)

**urbania**

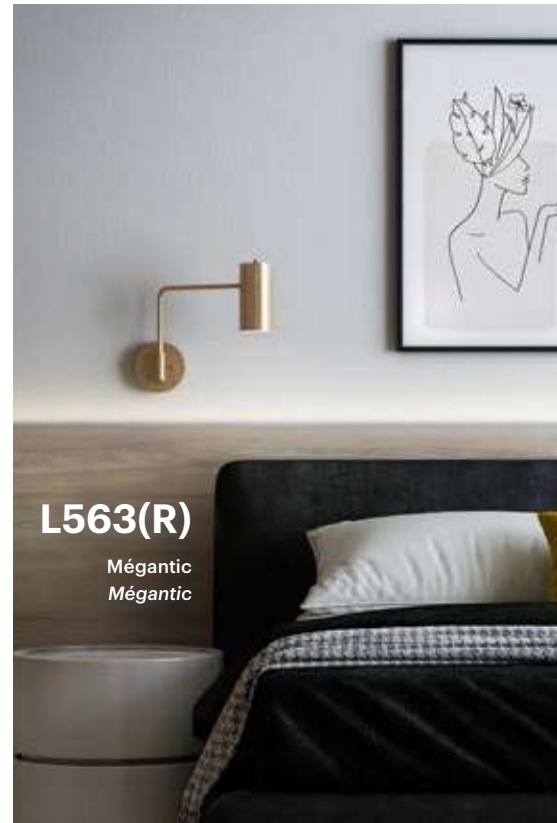

**L563(R)**

Mégantic  
Mégantic

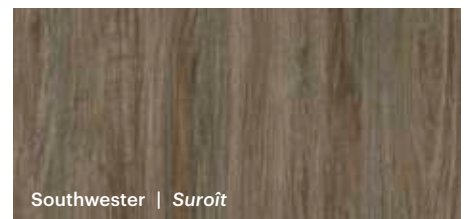

Southwester | *Suroît*

TFL L535 (A) | HPL T535 (AT)

**alto**



Breakwater | *Grande-Digue*

TFL L537 (A) | HPL T537 (AT)

**alto**



Urban Vibe | *Ambiance Urbaine*

TFL L832 (K) | HPL T832 (KA)

**karisma**

To see the pattern repeat of each colour, and complementary products available, visit [tafisa.ca](http://tafisa.ca)

Pour voir la répétition du motif de chacun des coloris et pour les produits complémentaires offerts, visitez [tafisa.ca](http://tafisa.ca)

# PRÉLUDE®

SÉRIE • SERIES

**Woodgrains**  
Natural Blond

**Grains de bois**  
*Blond naturel*



**L546(A)**

Mojave  
Mojave



Maritime Dune | *Dune Maritime*

TFL L555 (R) | HPL T555 (UR)

**urbania**



Summer Breeze | *Brise d'Été*

TFL L540 (A) | HPL T540 (AT)

**alto**



Northern Plain | *Plaine du Nord*

TFL L545 (R) | HPL T545 (UR)

**urbania**



Sheer Beauty | *Beauté Naturelle*

TFL L581 (K) | HPL T581 (KA)

**karisma**

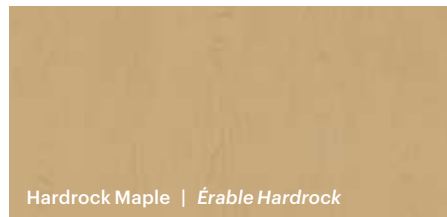

Hardrock Maple | *Érable Hardrock*

TFL L303 (C) | HPL T303 (CR)

**crystalite**



Mojave | *Mojave*

TFL L546 (A) | HPL T546 (AT)

**alto**

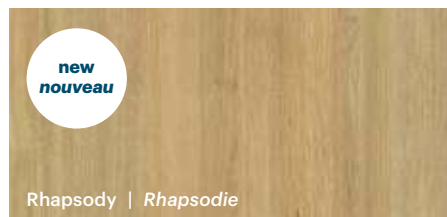

Rhapsody | *Rhapsodie*

TFL L585 (K) | HPL T585 (KA)

**karisma**

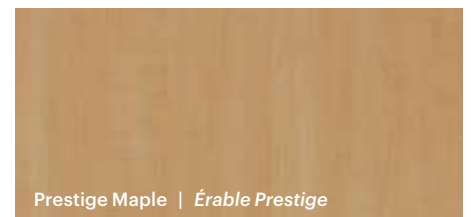

Prestige Maple | *Érable Prestige*

TFL L476 (C) | HPL T476 (CR)

**crystalite**



Secret | *Secret*

TFL L443 (C) | HPL T443 (CR)

**crystalite**



## Woodgrains

## Grains de bois

Light Brown

Brun pâle

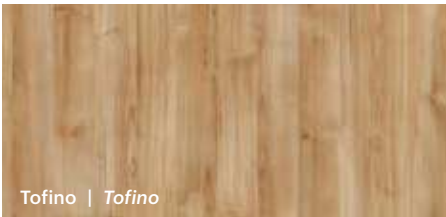

Tofino | *Tofino*

TFL L564 (R) | HPL T564 (UR)

**urbania**



Beach Memories | *Souvenirs de Plage*

TFL L491 (S) | HPL T491 (SN)

**smoothwood  
bois satiné**



Candlelight | *Lueur de Chandelle*

TFL L421 (C) | HPL T421 (CR)

**crystalite**

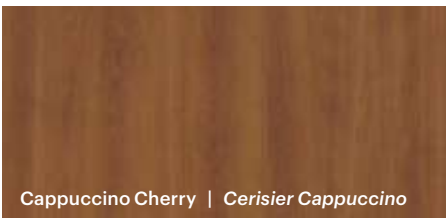

Cappuccino Cherry | *Cerisier Cappuccino*

TFL L458 (C) | HPL T458 (CR)

**crystalite**

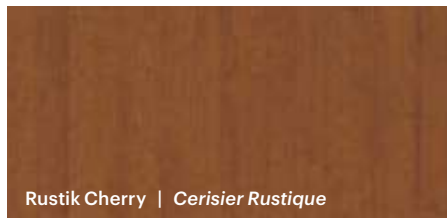

Rustik Cherry | *Cerisier Rustique*

TFL L521 (C) | HPL T521 (CR)

**crystalite**

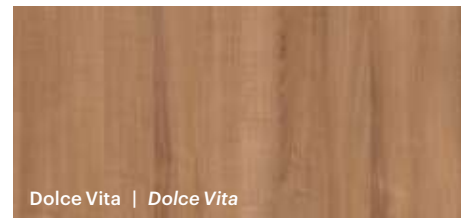

Dolce Vita | *Dolce Vita*

TFL L488 (S) | HPL T488 (SN)

**smoothwood  
bois satiné**

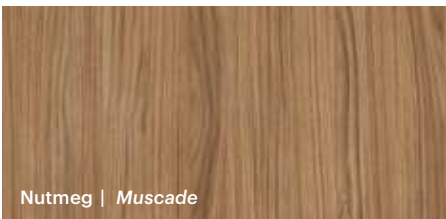

Nutmeg | *Muscade*

TFL L481 (S) | HPL T481 (SN)

**smoothwood  
bois satiné**



Laurentian Path | *Sentier Laurentien*

TFL L556 (R) | HPL T556 (UR)

**urbania**

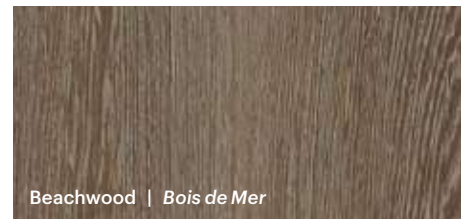

Beachwood | *Bois de Mer*

TFL L550 (A) | HPL T550 (AT)

**alto**

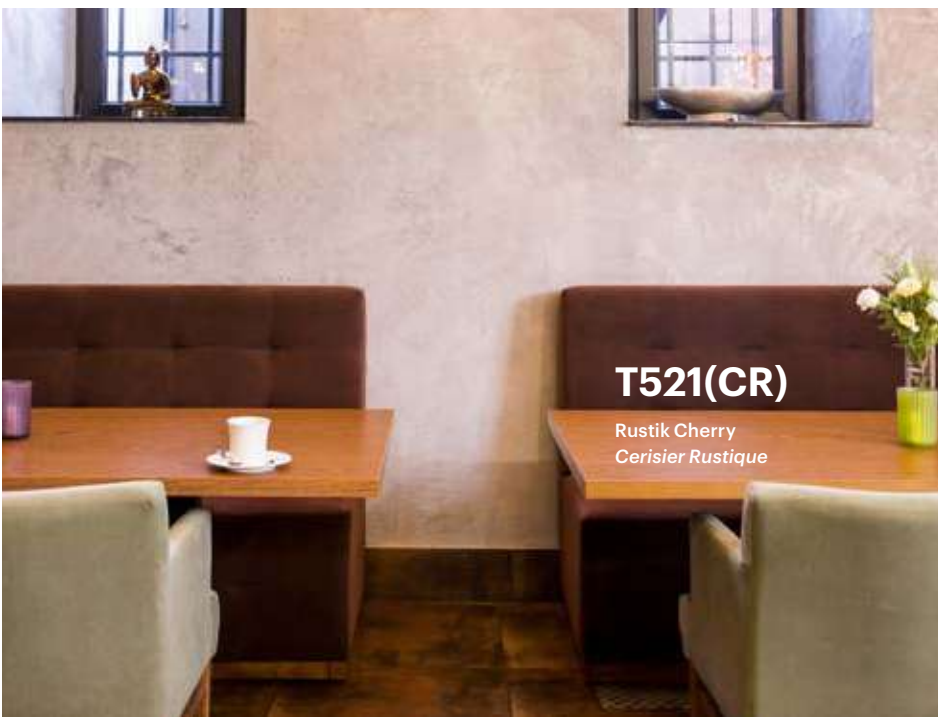

**T521(CR)**

Rustik Cherry  
*Cerisier Rustique*

To see the pattern repeat of each colour, and complementary products available, visit [tafisa.ca](http://tafisa.ca)

*Pour voir la répétition du motif de chacun des coloris et pour les produits complémentaires offerts, visitez [tafisa.ca](http://tafisa.ca)*

# PRÉLUDE®

SÉRIE • SERIES

**Woodgrains**  
Mid-Brown

**Grains de bois**  
Brun moyen

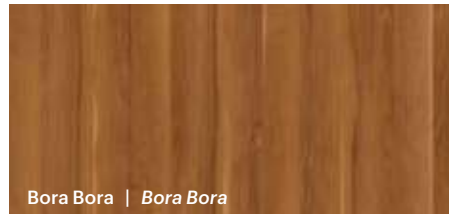
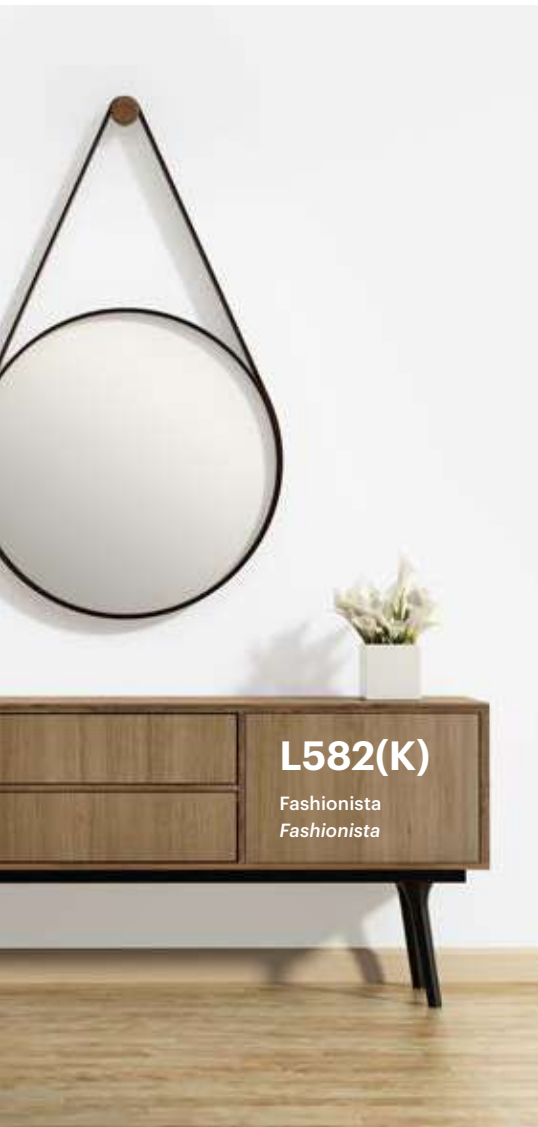

Bora Bora | *Bora Bora*  
TFL L497 (S) | HPL T497 (SN) **smoothwood**  
**bois satiné**

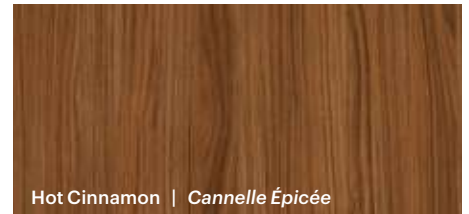

Hot Cinnamon | *Cannelle Épicée*  
TFL L480 (S) | HPL T480 (SN) **smoothwood**  
**bois satiné**

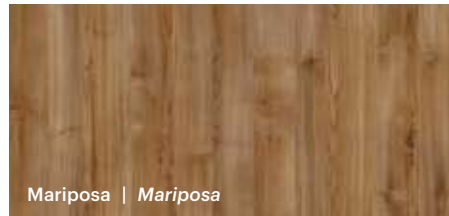

Mariposa | *Mariposa*  
TFL L568 (R) | HPL T568 (UR) **urbania**

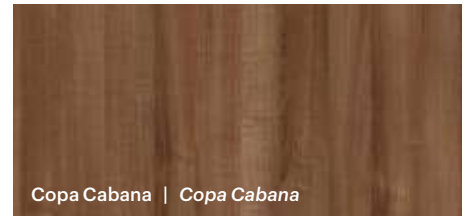

Copa Cabana | *Copa Cabana*  
TFL L489 (S) | HPL T489 (SN) **smoothwood**  
**bois satiné**



Rocky Mountain | *Montagne Rocheuse*  
TFL L557 (R) | HPL T557 (UR) **urbania**



Chalbi Clay | *Argile de Chalbi*  
TFL L570 (R) | HPL T570 (UR) **urbania**

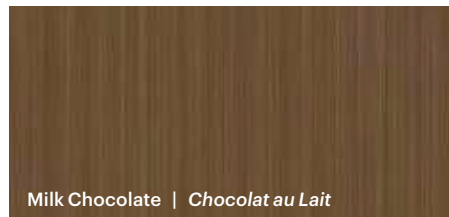

Milk Chocolate | *Chocolat au Lait*  
TFL L493 (R) | HPL T493 (UR) **urbania**

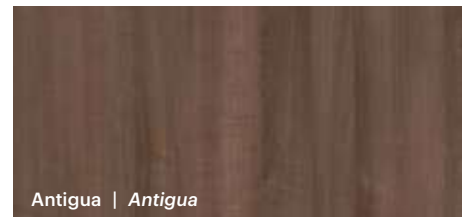

Antigua | *Antigua*  
TFL L498 (S) | HPL T498 (SN) **smoothwood**  
**bois satiné**



**new**  
**nouveau**  
Fashionista | *Fashionista*  
TFL L582 (K) | HPL T582 (KA) **karisma**

## Woodgrains

Red Brown

## Grains de bois

Brun rouge

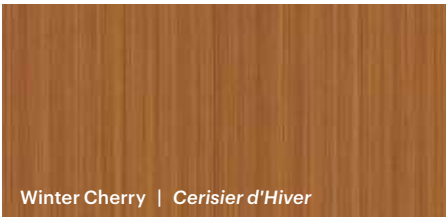

Winter Cherry | *Cerisier d'Hiver*

TFL L541(A) | HPL T541(AT)

**alto**



Summer Flame | *Flamme d'Été*

TFL L420(C) | HPL T420(CR)

**crystalite**

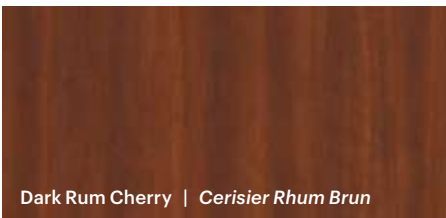

Dark Rum Cherry | *Cerisier Rhum Brun*

TFL L473(C) | HPL T473(CR)

**crystalite**



Cherry Blossom | *Cerisier en Fleurs*

TFL L449(C) | HPL T449(CR)

**crystalite**

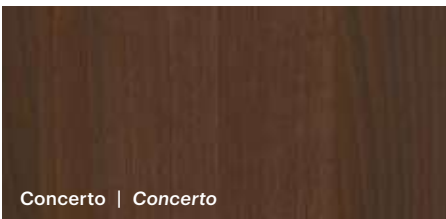

Concerto | *Concerto*

TFL L485(S) | HPL T485(SN)

**smoothwood  
bois satiné**

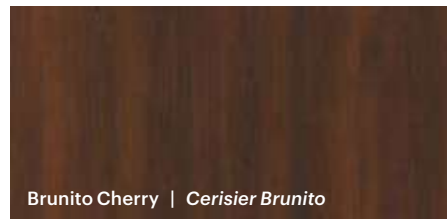

Brunito Cherry | *Cerisier Brunito*

TFL L807(C) | HPL T807(CR)

**crystalite**

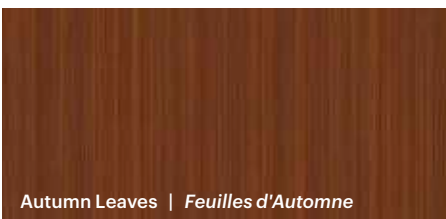

Autumn Leaves | *Feuilles d'Automne*

TFL L542(A) | HPL T542(AT)

**alto**

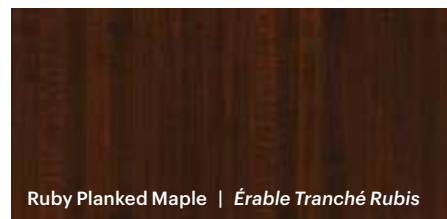

Ruby Planked Maple | *Érable Tranché Rubis*

TFL L478(C) | HPL T478(CR)

**crystalite**

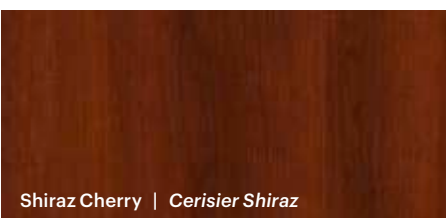

Shiraz Cherry | *Cerisier Shiraz*

TFL L472(C) | HPL T472(CR)

**crystalite**



**L807(C)**

Brunito Cherry  
*Cerisier Brunito*

To see the pattern repeat of each colour, and complementary products available, visit [tafisa.ca](http://tafisa.ca)

Pour voir la répétition du motif de chacun des coloris et pour les produits complémentaires offerts, visitez [tafisa.ca](http://tafisa.ca)

# PRÉLUDE®

SÉRIE • SERIES

## Woodgrains

Dark Brown

## Grains de bois

Brun foncé



**L583(K)**

First Class  
Première Classe

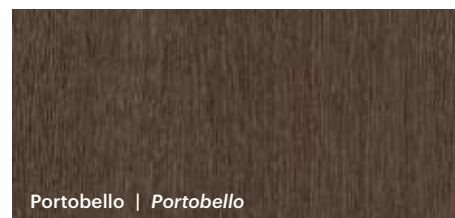

Portobello | *Portobello*

TFL L495 (R) | HPL T495 (UR)

**urbania**

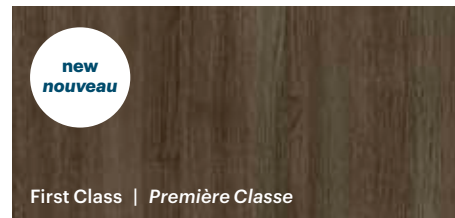

First Class | *Première Classe*

TFL L583 (K) | HPL T583 (KA)

**karisma**

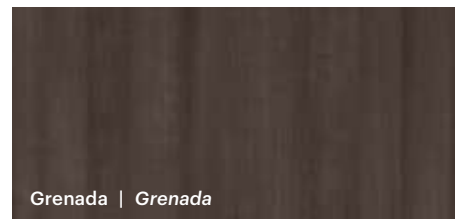

Grenada | *Grenada*

TFL L499 (S) | HPL T499 (SN)

**smoothwood  
bois satiné**



Spring Blossom | *Bourgeon du Printemps*

TFL L543 (A) | HPL T543 (AT)

**alto**

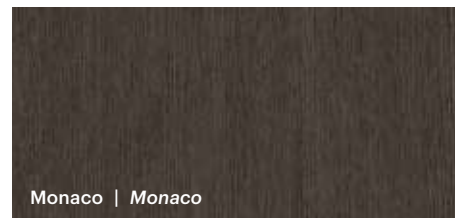

Monaco | *Monaco*

TFL L496 (R) | HPL T496 (UR)

**urbania**

**Woodgrains**    **Grains de bois**

Black

Noir



Karoo Ash | *Cendre de Karoo*

TFL L571 (R) | HPL T571 (UR)

**urbania**



Tuxedo | *Tuxedo*

TFL L477 (C) | HPL T477 (CR)

**crystalite**

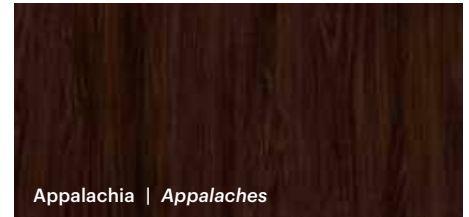

Appalachia | *Appalaches*

TFL L552 (A) | HPL T552 (AT)

**alto**

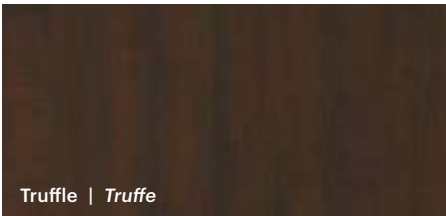

Truffle | *Truffe*

TFL L479 (C) | HPL T479 (CR)

**crystalite**

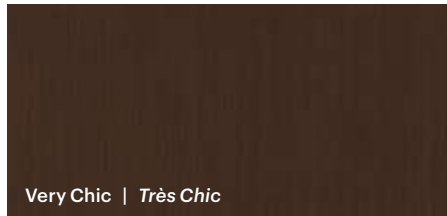

Very Chic | *Très Chic*

TFL L666 (C) | HPL T666 (CR)

**crystalite**

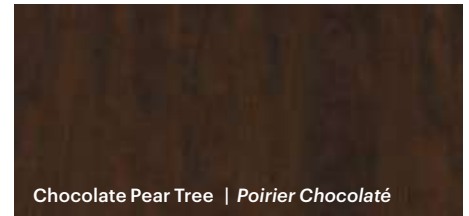

Chocolate Pear Tree | *Poirier Chocolaté*

TFL L444 (C) | HPL T444 (CR)

**crystalite**

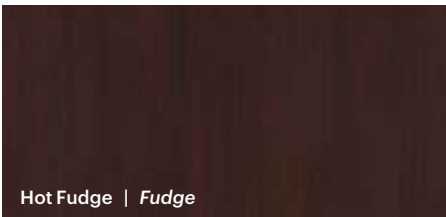

Hot Fudge | *Fudge*

TFL L469 (C) | HPL T469 (CR)

**crystalite**

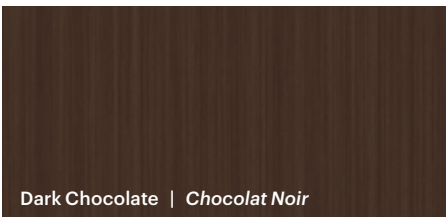

Dark Chocolate | *Chocolat Noir*

TFL L494 (R) | HPL T494 (UR)

**urbania**

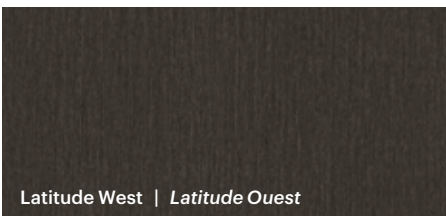

Latitude West | *Latitude Ouest*

TFL L532 (A) | HPL T532 (AT)

**alto**



To see the pattern repeat of each colour, and complementary products available, visit [tafisa.ca](http://tafisa.ca)

*Pour voir la répétition du motif de chacun des coloris et pour les produits complémentaires offerts, visitez [tafisa.ca](http://tafisa.ca)*

# PRÉLUDE®

SÉRIE • SERIES

## Solid Colours

Beige  
Taupe  
Slate

## Couleurs unies

Beige  
Taupe  
Ardoise



Morning Dew | *Rosée du Matin*

TFL L763 (I) | HPL T763 (IS)  
TFL L763 (C) | HPL T763 (CR)

**isola**  
**crystalite**



Daybreak | *Au Petit Matin*

TFL L764 (I) | HPL T764 (IS)  
TFL L764 (C) | HPL T764 (CR)

**isola**  
**crystalite**

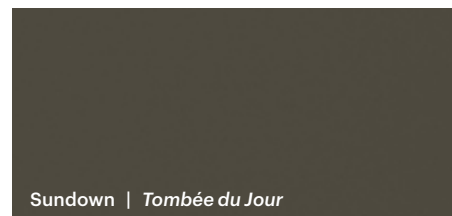

Sundown | *Tombée du Jour*

TFL L768 (I) | HPL T768 (IS)  
TFL L768 (C) | HPL T768 (CR)

**isola**  
**crystalite**

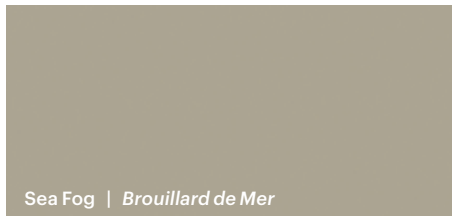

Sea Fog | *Brouillard de Mer*

TFL L769 (I) | HPL T769 (IS)

**isola**



Milky Way | *Voie Lactée*

TFL L767 (C) | HPL T767 (CR)

**crystalite**

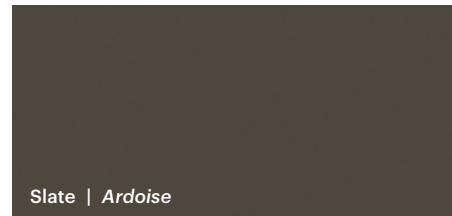

Slate | *Ardoise*

TFL L228 (I) | HPL T228 (IS)  
TFL L228 (C) | HPL T228 (CR)

**isola**  
**crystalite**



**L764(C)**

Daybreak  
*Au Petit Matin*

## Solid Colours

## Couleurs unies

Grey  
Blue  
Black

Gris  
Bleu  
Noir

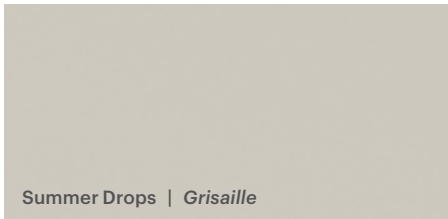

Summer Drops | *Grisaille*

TFL L202 (I)  
TFL L202 (C) | HPL T202 (CR)

**isola**  
**crystalite**

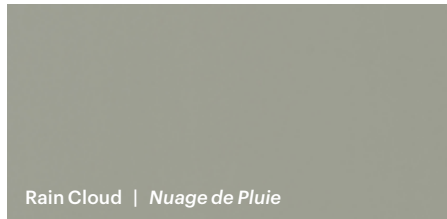

Rain Cloud | *Nuage de Pluie*

TFL L760 (C) | HPL T760 (CR)

**crystalite**



Shadows | *Pénombre*

TFL L201 (C)

**crystalite**

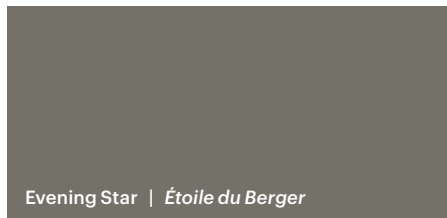

Evening Star | *Étoile du Berger*

TFL L770 (I) | HPL T770 (IS)

**isola**

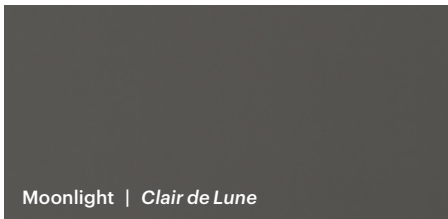

Moonlight | *Clair de Lune*

TFL L761 (C) | HPL T761 (CR)

**crystalite**

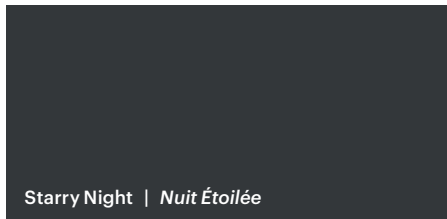

Starry Night | *Nuit Étoilée*

TFL L762 (I)  
TFL L762 (C) | HPL T762 (CR)

**isola**  
**crystalite**



Midnight Sun | *Soleil de Minuit*

TFL L765 (I) | HPL T765 (IS)

**isola**

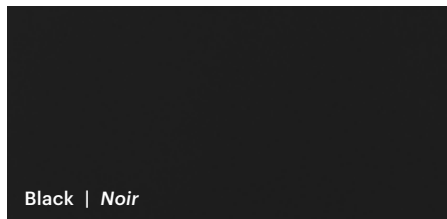

Black | *Noir*

TFL L203 (I)  
TFL L203 (C) | HPL T203 (CR)

**isola**  
**crystalite**

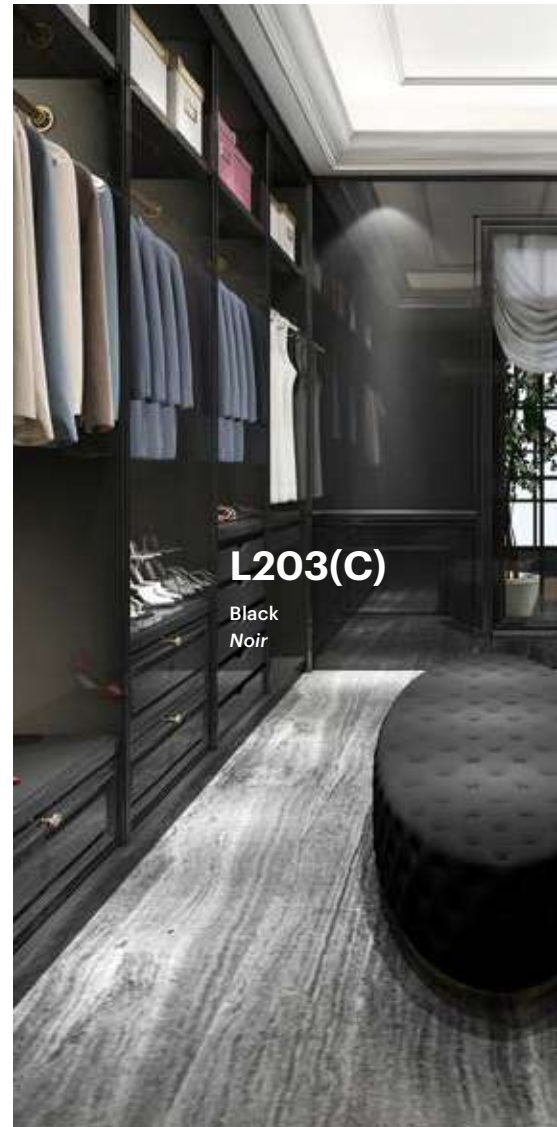

To see the pattern repeat of each colour, and complementary products available, visit [tafisa.ca](http://tafisa.ca)

*Pour voir la répétition du motif de chacun des coloris et pour les produits complémentaires offerts, visitez [tafisa.ca](http://tafisa.ca)*

# PRÉLUDE®

SÉRIE • SERIES

## Solid Colours

## Couleurs unies

White  
Ivory

Blanc  
Ivoire

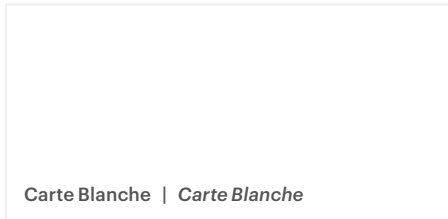

Carte Blanche | *Carte Blanche*

TFL L115 (I)

**isola**

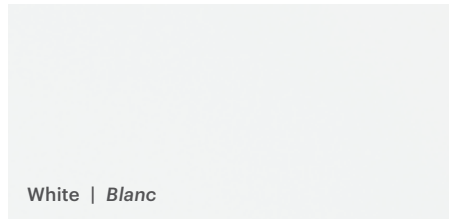

White | *Blanc*

TFL L175 (C) | HPL T175 (CR)

**crystalite**



Snowfall | *Bordée de Neige*

TFL L105 (I)

TFL L105 (C) | HPL T105 (CR)

**isola  
crystalite**



Vanilla Orchid | *Orchidée Vanillée*

TFL L100 (C)

**crystalite**



Glacier White | *Blanc Glacier*

TFL L191 (C)

**crystalite**



Classic White | *Blanc Classique*

TFL L178 (C)

**crystalite**

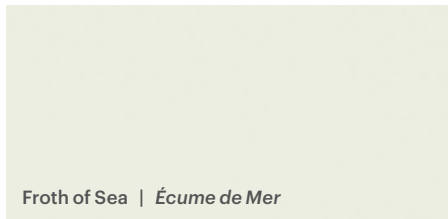

Froth of Sea | *Écume de Mer*

TFL L080 (C) | HPL T080 (CR)

**crystalite**

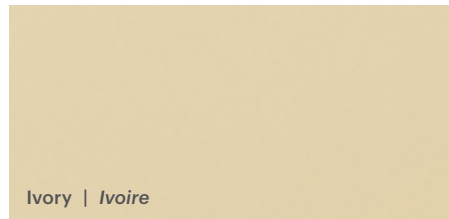

Ivory | *Ivoire*

TFL L204 (C) | HPL T204 (CR)

**crystalite**

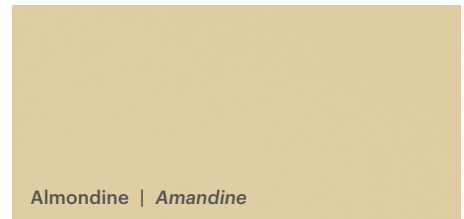

Almondine | *Amandine*

TFL L258 (C)

**crystalite**



L175(C)

White  
Blanc



Order your  
samples  
online!

Commandez  
vos échantillons  
en ligne!

**tafisa.ca**

To see the pattern repeat of each  
colour, and complementary  
products available, visit **tafisa.ca**

Pour voir la répétition du motif  
de chacun des coloris et pour  
les produits complémentaires  
offerts, visitez **tafisa.ca**



# The Finishing Touch

## Finir en beauté

Sourcing and matching TFL panels or HPL sheets to complementary products is key to producing design harmony. At Tafisa®, it's an integral part of our design and product development process. So, we're proud to offer you the most extensive complementary products program on the market.

L'approvisionnement en produits complémentaires appariés à nos panneaux TFL et nos feuilles de stratifié HPL SURFORMA est la clé pour concevoir des designs harmonieux. Chez Tafisa®, cette idée fait partie intégrante du processus de développement de produits. Nous sommes ainsi fiers de vous offrir la gamme de produits complémentaires la plus complète sur le marché.



### Edgebandings Bandes de chant

Edgebanding are narrow polyester, PVC or ABS strips that match the products used to cover edges for aesthetic and durability purposes.

Les bandes de chant sont d'étroites bandes de polyester, de vinyle (PVC) ou d'ABS agencées à nos produits utilisées pour recouvrir les chants des panneaux à des fins esthétiques et de durabilité.



### 3D Laminates Laminé 3D

3D Laminate, or rigid thermofoil (RTF), is a decorative surface that can be membrane-pressed or vacuum-formed to contour surfaces without requiring edge treatments. The finished product artfully replicates machined solid wood or other solid surfaces.

Le laminé 3D, aussi nommé thermoplastique rigide (RTF), est un revêtement utilisé dans une presse à membranes ou une machine à profiler pour former les surfaces sans nécessiter une finition des chants. Le produit fini donne l'impression d'un bois usiné ou d'autres surfaces solides.



### Door Mouldings Moules de portes

These mouldings are made from MDF profile wrapped with treated base paper. This type of moulding frames a central panel in order to create a cabinet door. The many profiles and colours available are perfectly matching Tafisa®'s TFL and HPL decorative panels.

Ces moules sont composées de MDF profilé enrobé de papier traité. Ce type de moules encadre un panneau central afin de créer une porte de cabinet. Les multiples profils et coloris offerts sont parfaitement appariés aux panneaux décoratifs TFL et HPL de Tafisa®.

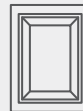

### 3D Laminate Doors Portes en laminé 3D

3D Laminate Cabinet Doors, consist of a routed one-piece MDF door with a vinyl film applied using heat and pressure. These films match Tafisa®'s TFL decors and SURFORMA HPL sheets. The 3D nature of this product comes from the ability of the vinyl film to form to the contours of the face and sides of the door or drawer front.

Les portes en laminé 3D sont faites d'une porte en MDF recouverte d'une pellicule de vinyle appliquée par pression et par chaleur. Ces pellicules s'harmonisent aux panneaux décoratifs TFL et feuilles de stratifié SURFORMA de Tafisa®. La nature tridimensionnelle de ce produit provient de la capacité de la pellicule de vinyle de se mouler à tout contour, portes ou tiroirs.

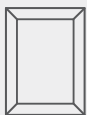

### 5-Piece And Slab Doors Portes Slab et 5 morceaux

Designed using four profile-wrapped pieces forming a frame around a central panel, these 5-piece doors offer a distinctive wood cabinet appearance, synonymous with durability, sophistication and quality, available in several styles, finishes and Tafisa® colours.

Composées de quatre pièces profilées formant un cadre autour d'un panneau central, les portes 5 morceaux procurent une apparence semblable à celle des armoires de bois, synonyme de durabilité, de raffinement et de qualité. Elles sont offertes dans plusieurs modèles, finis et coloris Tafisa®.



### Accessory Mouldings Moules accessoires

These mouldings are composed of profiled MDF coated with treated paper, perfect for decorative elements and generally added as a finish to a room's décor and furnishings. The numerous profiles and colours available are a perfect match to the Tafisa® TFL and HPL decorative panels.

Ces moules sont composées de MDF profilé enrobé de papier traité. Ce type de moules sert d'éléments décoratifs et est généralement ajouté comme finition à une pièce et son mobilier. Les multiples profils et coloris offerts sont parfaitement appariés aux panneaux décoratifs TFL et HPL de Tafisa®.



# Tafisa® Mouldings Program

## Programme de moulures Tafisa®

The new Tafisa® mouldings program offers short delivery time and low minimum order quantities, all for sale directly from Tafisa®.

Ce nouveau programme de moulures offre des délais de livraison réduits et de faibles quantités minimales par commande, le tout en vente directement chez Tafisa®.

### Available Colours | Couleurs offertes

**karisma**

580 (KA) | 581 (KA) | 582 (KA)  
583 (KA) | 584 (KA) | 585 (KA)

**LUMMIA™**  
PERFECT MATT  
MAT ABSOLU

PM100 | PM115 | PM203 | PM763  
PM765 | PM771 | PM772 | PM773  
PM774

Visit our website for information on our mouldings: [tafisa.ca](http://tafisa.ca)

Visitez notre site web pour plus d'informations sur nos moulures : [tafisa.ca](http://tafisa.ca)

### Door Mouldings | Moulures de portes Length / Longueur: 9'

#### Alpha

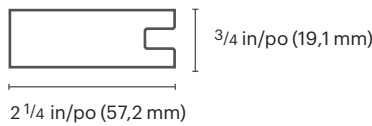

1/4" (6.35 mm)  
PB or/ou MDF  
center panel  
panneau du centre

#### Beta

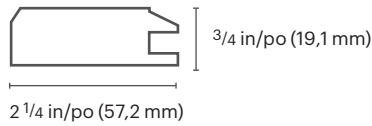

1/4" (6.35 mm)  
PB or/ou MDF  
center panel  
panneau du centre

#### Gamma

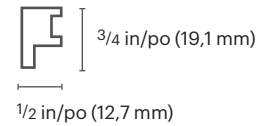

5/8" (15.88 mm)  
PB  
center panel  
panneau du centre

### Accessory Mouldings | Moulures accessoires Length / Longueur: 9'

#### Light Valance Cache Néon

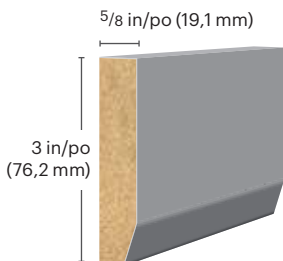

#### Crown Moulding Moulure de tête

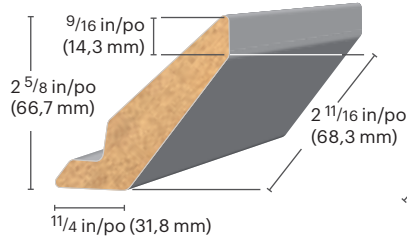

#### Ogee Ogee

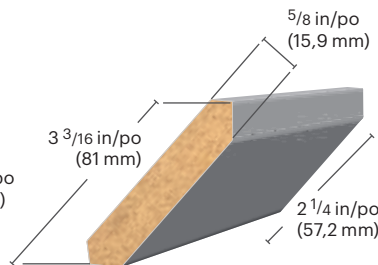

#### Batten Latte

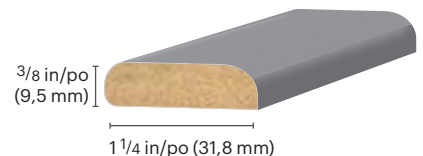



# Cleaning and Maintenance of our Products

## Nettoyage et entretien de nos produits



For general housekeeping, Tafisa® recommends the use of aerosol glass foam and a soft cloth or dry microfiber cloth. Never use cleaning products that contain wax, abrasives, strong acids or bases that can damage surfaces. Tafisa® decorative panels have a non-porous surface that doesn't promote bacterial growth.

For more information visit [tafisa.ca](https://www.tafisa.ca)

*Pour l'entretien ménager, Tafisa® recommande l'utilisation d'une mousse pour surfaces vitrées en aérosol et d'un chiffon doux ou tissu microfibre sec. N'utilisez en aucun cas des produits de nettoyage contenant de la cire, des abrasifs, des acides ou des bases fortes qui risqueraient d'endommager la surface.*

*Les panneaux décoratifs Tafisa® ont une surface non poreuse qui ne favorise pas la croissance bactérienne.*

For plus d'information, visitez [tafisa.ca](https://www.tafisa.ca)

### Tafisa® Products Distributors in Canada and the USA

### Distributeurs des produits Tafisa® au Canada et aux États-Unis



To find the  
nearest Tafisa®  
distributor,  
go to [tafisa.ca](https://www.tafisa.ca)

Pour trouver  
le distributeur  
Tafisa® le plus près,  
visitez [tafisa.ca](https://www.tafisa.ca)



L581(K)  
 Sheer Beauty  
 Beauté Naturelle



Proudly Distributed By

Specification Support By



Materials That Inspire

888-826-5528  
 844-365-6995  
[hardwoods-inc.com](http://hardwoods-inc.com)



Where Inspiration and Design Meet Supply

866-599-1433  
[designonesource.com](http://designonesource.com)