



QUALITY. STRENGTH. ELEGANCE.

It's ALWAYS been a way of life...

Contents

Perma-Loc® Uplift Solution.....	5
The PermaCast®Plus Column Collection.....	6
PermaCast®Plus RoughSawn®.....	8
PermaCast®Plus Square Columns.....	9
PermaCast®Plus Recessed Panel Columns.....	10
PermaCast®Plus Craftsman Columns.....	11
PermaCast®Plus Round Tapered Columns.....	12
PermaCast®Plus Fluted Round Columns.....	13
PermaCast®Plus Round No-Taper Columns.....	13
Perma Capitals and Bases.....	15
Decorative Capitals.....	16
Helpful Hints.....	17
PermaLite® Columns.....	18
Smart Columns.....	22
PermaSnap™ Column Wrap.....	23
PermaWrap™ PVC Columns.....	24
WoodGrain PVC Sell Sheet.....	25
PermaWrap™ Dimensions.....	26
Wood Columns.....	28
Capial and Base Options for Wood Columns.....	28
The PermaPost® Collection.....	30
Wood Porch Posts.....	32
The HB&G PermaRail® Plus Collection.....	33
Ballustrade Systems.....	37
Serenity Series Fiberglass Pergolas.....	42
Semi-Custom Pergola Options.....	43
Custom Solace® Series Fiberglass Pergolas.....	44
Understanding Pergola Dimensions.....	44
Mor-Shade for Pergolas.....	45
Outdoor Living Products.....	47
Architectural Services.....	48
Warranty.....	49

The traditional American front porch... it's where we welcome friends and family into our home. It's where we sit and enjoy their company. It's the place where we go to escape the stress of daily life and take the time to sit back, relax, and enjoy life.

The last thing you want to worry about is the work required to keep your porch beautiful, and that's where HB&G can offer you the solution of a lifetime.

HB&G offers a wide variety of porch and outdoor living products to help you create the design that best suits your way of life. Best of all, many of our products require little or no maintenance and come with a solid warranty.

The following pages include everything you need to know to build a beautiful, enduring structure that will improve the quality of your life.

— SINCE 1880 —



Building Code Compliance

HB&G has updated our product testing to comply with changes to the Building Codes (IBC/IRC) and to the Acceptance Criteria for Fiberglass Columns. The 2 major changes that impacted PermaCast®Plus and PermaLite® were:

- Eccentric Axial Loading - the new maximum allowable load values are based on eccentric (offset) axial load as opposed to concentric (centered) axial loading.
- Increased Safety Factor - the safety factor on the allowable load was increased from 2.5 times to 5 times

Eccentric loading of columns is not recommended by HB&G.

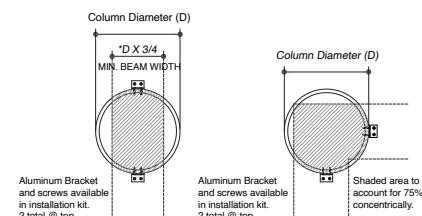

Acceptable Applications

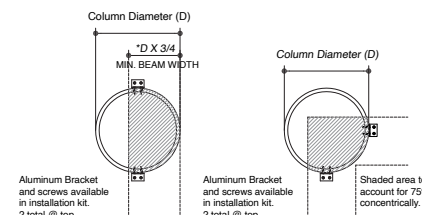

Unacceptable Applications

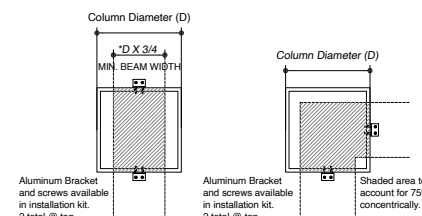

Acceptable Applications

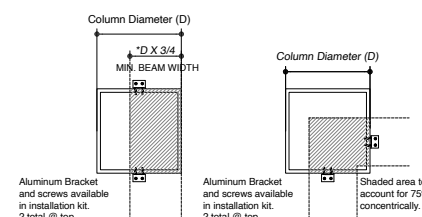

Unacceptable Applications

HB&G recommends following the installation instructions included with the product purchased. HB&G structural products conform to 2018 IBC/IRC.

Round Tapered PermaCast®Plus Plain and Fluted

Bottom Diameter	Eccentric Loading		
	Avg. Allowable Load (Lbs.)	Avg. Ultimate Load (Lbs.)	Concentric Load (Lbs.)
6"	4580	22900	8000
8"	4600	23000	10000
10"	4690	23450	14000
12"	4800	24000	18000
14"	7800	39000	20000
16"	8250	41250	20000
18"	10000	50000	20000
20"	10000	50000	20000
22"	10000	50000	20000
24"	10000	50000	20000
28"	10000	50000	20000
30"	10000	50000	20000

Square PermaCast®Plus Plain, Fluted, RoughSawn®, and Recessed Panel

6"	5100	25500	8000
8"	5150	25750	10000
10"	5640	28200	14000
12"	5900	29500	18000
14"	8500	42500	20000
16"	9500	47500	20000

Round No-Taper PermaCast®Plus Plain and Fluted

8"	4590	22950	10000
10"	4670	23350	14000
12"	4750	23750	18000
14"	7000	35000	20000
16"	7000	35000	20000
18"	7000	35000	20000
24"	9000	45000	20000

Craftsman Plain and RoughSawn® PermaCast®Plus

10" x 5.5" x 66"	9000	45000	10000
10" x 8" x 66"	9000	45000	10000
10.25" x 7.5" x 7'	7000	35000	10000
12" x 8" x 5'	8000	40000	14000
12" x 8" x 6'	8000	40000	14000
12" x 8" x 66"	8000	40000	14000
12" x 10" x 6'	8000	40000	14000
12" x 10" x 10'	8000	40000	14000
14" x 12" x 9'	8000	40000	14000
16" x 9" x 6'	9000	45000	14000
16" x 9" x 8'	9000	45000	14000
16" x 9" x 58"	9000	45000	14000
16" x 12" x 6'	9000	45000	14000
16" x 12" x 8'	9000	45000	14000

Square PermaLite® Panel

6"	3000	15000	5000
8"	3000	15000	6500
10"	3000	15000	7000

*Covered in accordance with ICC ESR-1361 / FL# 3102

Conforms with 2018 IBC/IRC

Note - Eccentric (off-center) loading has a 5 times safety factor.
- Eccentric (off-center) loading of columns is not covered by the warranty.

Round Wood Columns

6"	2000
8"	3200
10"	4200
12"	5100

PermaPost®

5" Colonial	1300
6" Colonial	5000
5" Square	5000
6" Chamfered	5000

Wood Porch Posts

4"	1000
5"	3000
6"	5800

*Concentric loading
Conforms with 2018 IBC/IRC

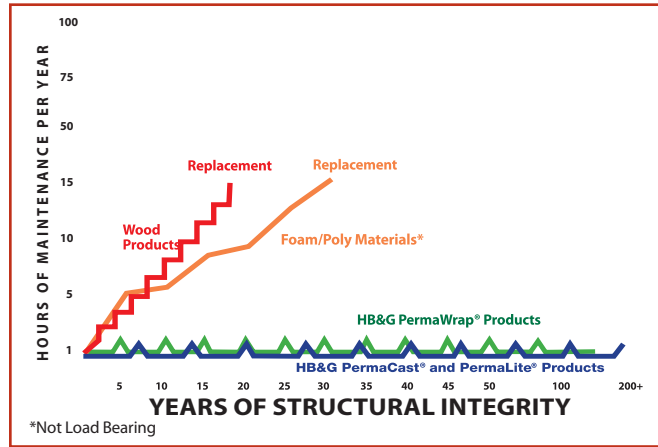

Selection

HB&G offers the widest selection of porch products available on the market. With a variety of sizes and styles, HB&G has the porch accessories to meet the needs of any project.

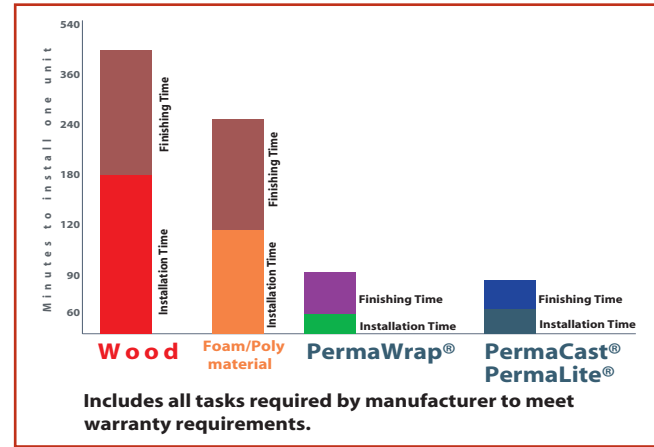

Ease of Use

Time is money. With HB&G products, not only do you save time on the installation, you'll also save a considerable amount of money maintaining your porch accessories over the lifetime of the product. Many of the HB&G products can be installed in 1/3 of the time of traditional wood products.



The PermaPorch® Package

It's an effective way to coordinate all of your porch accessories. At HB&G, you will find an entire line-up of products that are made to work together, creating a beautiful, seamless, and cost-effective addition to your home. Enjoy the lasting beauty of columns, posts railing and balustrade systems and much, much more, all from the company that is setting new standards in porch products and accessories.



Looking for an Uplift Solution?

Look no further than

Perma-Loc® from **HB&G**
BUILDING PRODUCTS

The HB&G Uplift Anchoring System

Our uplift anchoring system from HB&G® is versatile, easy to install and affordable. The code compliant hardware kits provide the function needed to protect column supported projecting roof lines from wind uplift forces, while solving for common coastal challenges for residential, commercial and municipal installations.

Perma-Loc® Features and Benefits:

- 4,200 lb strength galvanized aircraft cable combined with 316 stainless steel marine-grade attachment hardware for optimal uplift resistance. Exceeds the required capacity for 1,000 lb. uplift.
- Perma-Loc® eliminates the need to split a column, along with all of the labor and material costs associated with splitting and re-joining two column halves.
- All hardware is included for concrete substrate applications.
- Available in three sizes: up to 12', 16', and 20' lengths.
- Extremely cost effective and versatile application that covers the entire spectrum of HB&G load bearing products.
- Patented design accompanied by certified/stamped engineering documentation.
- Florida Department of Business and Professional - Regulation approved #37300.

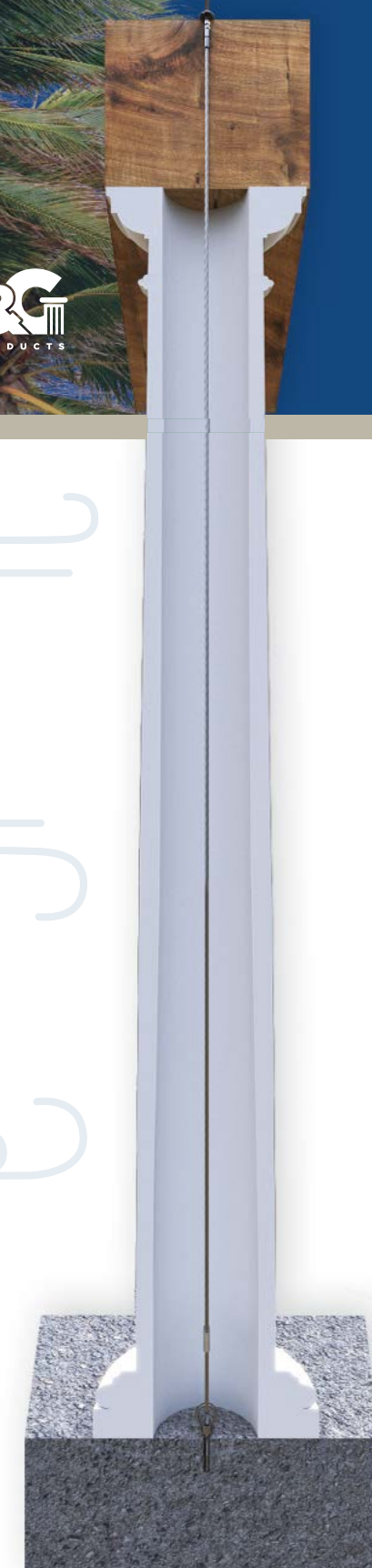

The PERMACast® Plus Column Collection

- Weather Proof.
- Insect Proof.
- Load Bearing.
- Low Maintenance.
- Ready to Prime and Paint.
- Limited Lifetime Warranty.*
- Custom Fluting Available.



24" Round PermaCast® Plus Columns with Roman Corinthian Capitals and Attic bases.

Architectural Accuracy

In the first century B.C., Vitruvius, a Roman architect and engineer, wrote what has become the most influential work on classic form. In it, he elaborates on the discovery by the ancient Greeks of entasis, a

*See Warranty

gradual tapering of the upper two-thirds of the round column which offsets the undesirable illusion from eye level that the column shaft grows larger as it ascends. HB&G round columns hold true to this classic form.

HB&G PermaCast® Plus Columns are available in round or square. The round columns are fluted or plain, with or without the classic tapering of the upper two-thirds of the column. Square columns are available in a variety of styles as well, including plain or fluted,

applied panel, recessed panel, or the Craftsman style column. Our capitals and bases are made from durable low maintenance materials; and, like the columns, they maintain architectural authenticity and historical accuracy.

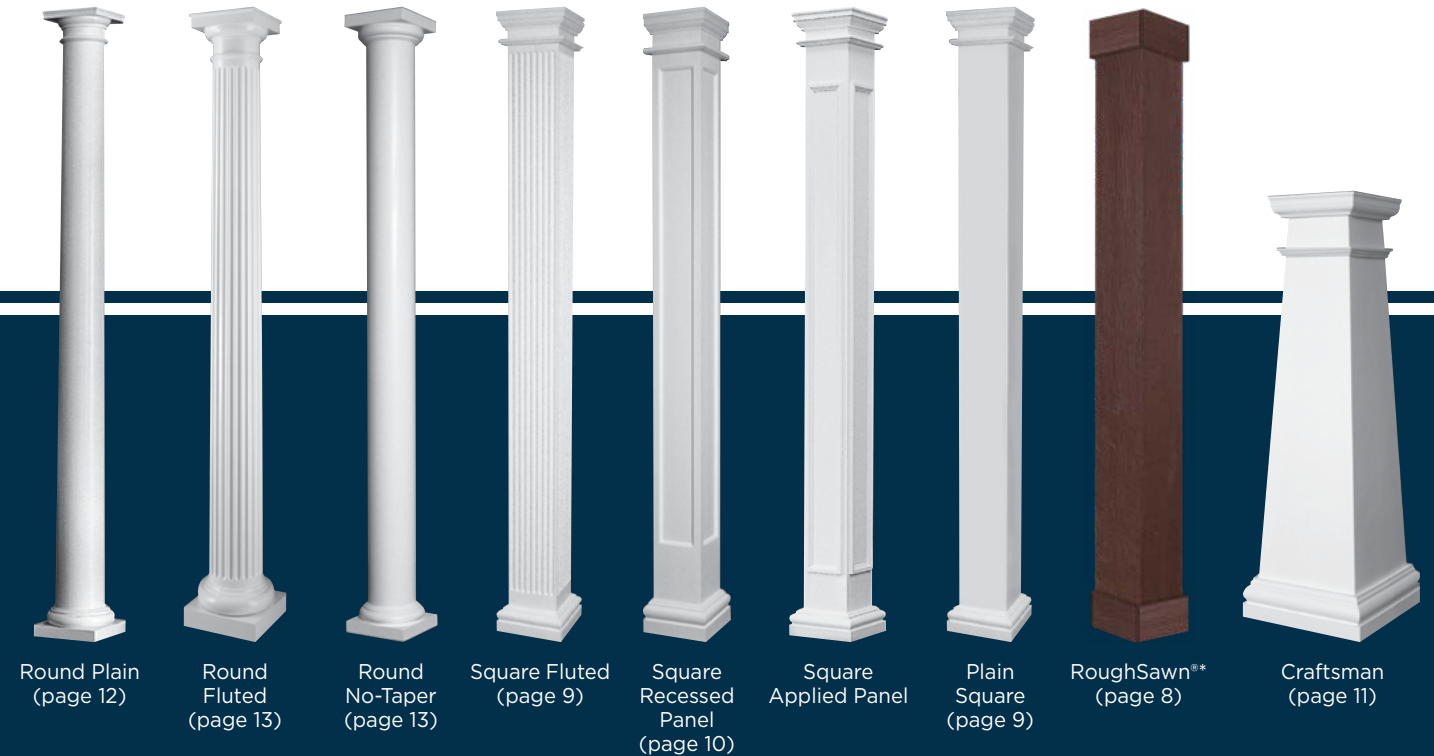

*Products shown have been finished for demonstration purposes. PermaCast® Plus and RoughSawn® Columns ship unfinished.

See pages 15 and 16 for cap and base dimensions.

PERMACast® Plus RoughSawn®

- Made of Structural Fiberglass.
- Will not Check, Twist, Split or Rot.
- Load Bearing.
- Can be Stained using a Solid Body Acrylic Stain or Painted.
- Weather and Insect Proof.
- Low Maintenance.
- Easy Installation.
- Limited Lifetime Warranty.*



The beauty of wood



Without the issues:

- Checking, splitting, twisting...

*See Warranty

**Products shown have been stained for demonstration purposes. RoughSawn® columns are shipped unfinished.

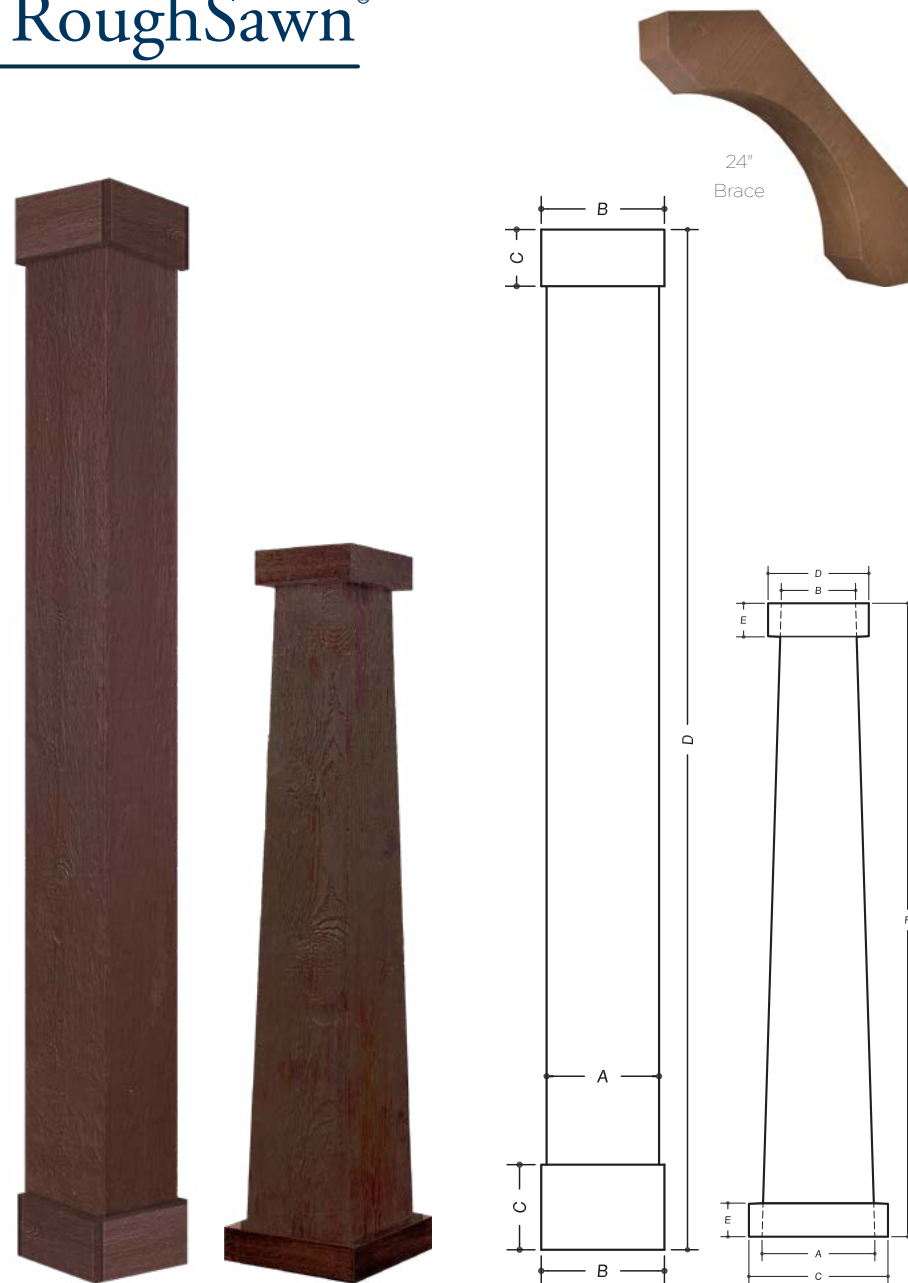

CRAFTSMAN ROUGHSAWN®

Size	A	B	C	D	E	F
10" x 6"	9 3/4"	5 3/4"	12 1/2"	8 7/8"	3 1/2"	66"
12" x 8"	11 3/4"	7 3/4"	14 1/2"	10 3/4"	3 1/2"	66"

SQUARE ROUGHSAWN®

Size	A	B	C
8"	7 3/4"	9 1/4"	8', 9', 10'
10"	9 3/4"	11 1/4"	8', 9', 10', 12'
12"	11 3/4"	13 1/4"	8', 9', 10', 12'

"C" is cap/base (2 sizes available / sold separately)

Trim sizes are available and can be used as both cap and base based on preference.

Square PERMACast® Plus Columns

SQUARE PERMACAST® PLUS

INSIDE DIMENSIONS

Inside dimensions may vary up to 1/4". Splitting a column will decrease inside dimension 1/8".

Column Size	Inside
6"	5 3/8"
8"	6 3/8"
10"	9"
12"	11"
14"	13"
16"	15"

*Inside is Round

PANEL MOULDING FOR SQUARE

PERMACAST® PLUS

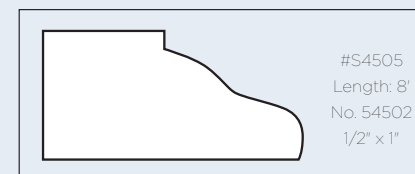

Plumb-Fit®

To make installation even easier our 6"-12" round and square poly Tuscan Cap and Base Sets with flashing cap come with the patented (Patent 9689674) Plumb-Fit® installation system included.

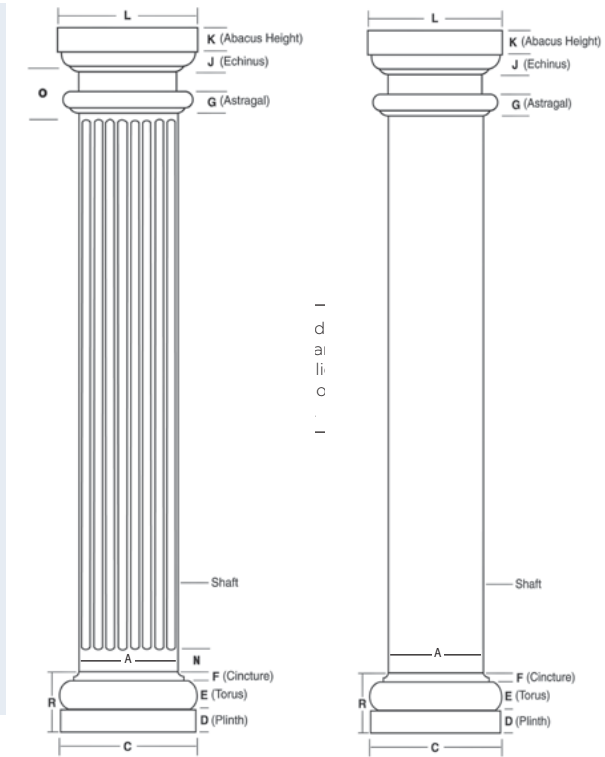

PermaCast® Plus Square Column shown fluted with Poly Tuscan Cap and Base.

PermaCast® Plus Square Column shown plain with Poly Tuscan Cap and Base.

SQUARE PERMACAST® PLUS COLUMN DIMENSIONS (IN INCHES)*

Column Size	A	C	D	E	F	G	J	K	L	N	O	R	Lengths Available (ft.)
6"	6"	9 1/8"	17 1/16"	1 5/16"	9/16"	1"	1 1/4"	1 3/8"	9 1/8"	N/A	N/A	3 5/16"	6, 8, 9, 10
8"	8"	11 1/8"	1 7/8"	1 3/4"	5/8"	1"	1 1/4"	1 1/2"	10 15/16"	5"	3 1/8"	4 1/4"	6, 8, 9, 10, 12
10"	10"	13 1/16"	2 3/8"	2 3/16"	3/4"	1"	1 1/4"	1 3/4"	12 3/4"	3 3/4"	4 1/8"	5 7/16"	51" 6, 8, 9, 10, 12, 14, 16
12"	12"	16 5/8"	2 13/16"	2 3/8"	7/8"	1"	1 7/8"	2 3/16"	16 5/8"	N/A	N/A	6 1/16"	8, 9, 10, 12, 14, 16, 18
14"	14"	19 3/8"	3 5/8"	2 7/8"	1 1/16"	1 1/8"	2 1/16"	2 1/2"	19 1/16"	N/A	N/A	7 9/16"	8, 10, 12, 14
16"	16"	22 1/8"	3 3/8"	3 3/8"	1 3/16"	1 1/8"	2 3/8"	2 3/4"	21 1/2"	N/A	N/A	8 7/16"	8, 10, 12, 14, 16, 18, 20

Fluted Square.

*There may be a variance of up to 1/4" in all dimensions.

• Split columns are not load bearing. • See page 16 for Decorative Capital dimensions.

Versatility of Square Columns

The design and versatility of an HB&G square column has enhanced its popularity with today's architects. The HB&G Square PermaCast® Plus column lineup includes plain, recessed panel, fluted, and Craftsman styles. An unlimited combination of styles can be achieved by various uses of the panel moulding, neck moulding, and caps and bases. Additionally, the plain square column is not tapered and can be cut to any height without affecting the fit of the caps and bases.



Recessed Panel PERMACast® Plus Columns

RECESSED PANEL INSIDE DIMENSION

Inside dimension may vary up to 1/4".

Column Size	Inside
8"	5 5/8"
10"	7 1/2"
12"	9 1/2"
14"	11"

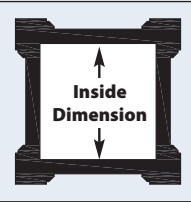

Recessed Panel columns must be primed with a quality bonding primer before finishing with a quality top coat of paint.

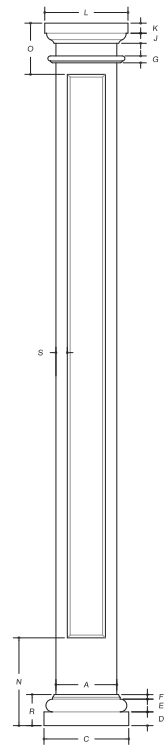

Neck mould is adjustable and can be applied anywhere on column.

Square Column with Poly Tuscan Cap and Base.

SQUARE RECESSED PANEL PERMACAST® PLUS COLUMN DIMENSIONS (IN INCHES)*

Column Size	A	C	D	E	F	G	J	K	L	N	O	R	S	Recess Depth	Lengths Available (ft.)
8"	8"	11 1/8"	1 1/8"	1 3/4"	5/8"	1"	1 3/8"	1 3/8"	10 15/16"	12"	7"	4 1/4"	1 1/2"	1/2"	8, 9, 10
10"	10"	2 13/16"	2 3/8"	2 5/16"	3/4"	1"	1 3/4"	1 3/4"	12 3/4"	14 1/2"	8 1/2"	5 7/16"	1 1/2"	1/2"	8, 9, 10
12"	12"	16 5/8"	2 13/16"	2 3/8"	7/8"	1"	2 3/16"	16 1/16"	16 1/16"	18"	10 1/2"	6 1/16"	2 1/4"	9/16"	8, 9, 10, 12, 14
14"	14"	19 3/8"	3 5/8"	2 7/8"	1 1/16"	1 1/8"	2 1/2"	19 1/16"	19 1/16"	21 1/2"	12 1/4"	7 9/16"	2 5/8"	1 1/16"	8, 10, 14

See page 16 for Decorative Capital dimensions.

*Recessed Panel columns are not split.

CRAFTSMAN PERMACAST® PLUS COLUMN

CRAFTSMAN INSIDE DIMENSION

Inside dimension may vary up to 1/4".
Splitting a column will decrease inside dimension 1/8".

Column Size	Top	Bottom
10" x 5 1/2"	4 1/2"	9"
10 1/4" x 7 1/2"	7"	9"
10" x 8"	7"	8 1/2"
12" x 8"	6 1/2"	11"
12" x 10"	9"	11"
14" x 12"	11"	13"
16" x 9"	8"	15"
16" x 9"	11"	15"

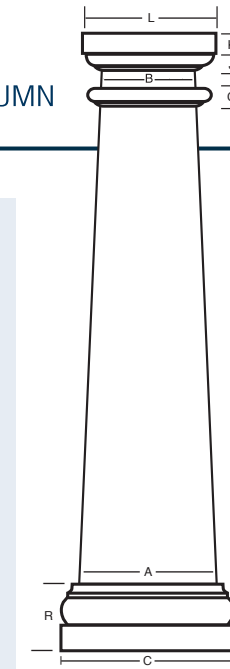
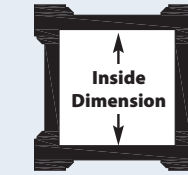

Neck mould is adjustable and can be applied anywhere on column.

CRAFTSMAN COLUMN DIMENSIONS (IN INCHES)

	A	B	C	D	E	F	G	J	K	L	R	Length
10" x 5 1/2"	10"	10"	13 5/8"	2 1/2"	2 1/2"	1"	1"	1 3/8"	1 3/8"	9 5/8"	5 7/8"	66"
10 1/4" x 7 1/2"	10 1/4"	10 1/4"	13 1/2"	2 3/8"	2 1/4"	3/4"	1"	1"	1"	10 1/4"	5 3/8"	7'
10" x 8"	9 1/2"	9 1/2"	12 3/4"	2 3/8"	2 1/8"	3/4"	1"	1"	1 3/8"	10 1/4"	5 1/4"	66"
12" x 8"	12"	12"	16 5/8"	2 1/2"	2 1/2"	1 1/16"	1"	1 1/4"	1 1/2"	10 15/16"	6 1/16"	5', 6'
12" x 10"	12"	12"	16 5/8"	2 1/2"	2 1/2"	1 1/16"	1"	1"	1 3/8"	12 3/4"	6 1/16"	6', 10'
*14" x 12"	14"	14"	18 3/4"	3 3/8"	3"	1"	1"	1 5/8"	2"	17 1/8"	7 3/8"	9'
16" x 9"	16"	16"	19 1/16"	2 1/2"	2 1/2"	1 1/16"	1"	1 3/8"	1 3/8"	13 1/4"	6 1/16"	6', 8', 58"
16" x 12"	15 1/4"	15 1/4"	21 1/2"	3 7/8"	3 3/16"	1 3/16"	1"	1 3/8"	2"	15 1/4"	8 3/8"	6', 8'

*Has 1/3" to 2/3" taper.

NOTE: Neck mould is not applied. Flashing and Installation Kit is not available for Craftsman Columns with Poly Tuscan cap and base sets.

• Split columns are not load bearing.

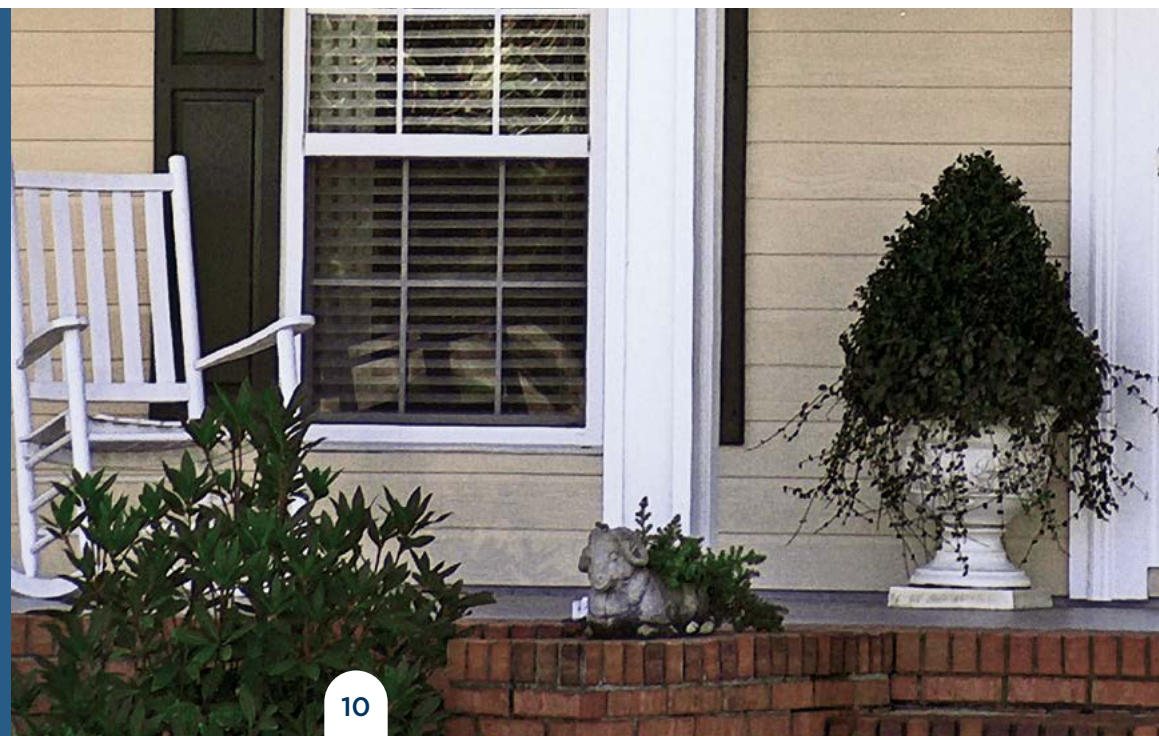

Round Tapered **PERMA**Cast® Plus Columns

ROUND PERMACAST® PLUS COLUMN DIMENSIONS (IN INCHES)*

Col. Size	A	B	C	D	E	F	G	J	K	L	O	N	R	T	Lengths Avail. (ft.)
6"	5 ⁵ / ₈ "	4 ³ / ₈ "	9"	1 ¹ / ₈ "	1 ¹ / ₄ "	5 ¹ / ₈ "	3 ¹ / ₄ "	1 ¹ / ₄ "	1 ³ / ₈ "	8"	1"	6 ¹ / ₄ "	3 ⁵ / ₈ "	4 ⁷ / ₈ "	4, 6, 8
8"	7 ³ / ₈ "	6 ¹ / ₄ "	10 ¹ / ₂ "	1 ³ / ₈ "	1 ³ / ₄ "	3 ³ / ₄ "	1 ³ / ₈ "	1 ¹ / ₂ "	1 ¹ / ₂ "	9 ¹ / ₄ "	1 ¹ / ₂ "	2 ¹ / ₄ "	4 ³ / ₈ "	4 ¹ / ₂ "	5, 6, 8, 9, 10
10"	9 ⁵ / ₈ "	8 ¹ / ₈ "	13 ¹ / ₈ "	2 ³ / ₈ "	2 ¹ / ₈ "	3 ¹ / ₄ "	1 ³ / ₈ "	1 ¹ / ₄ "	1 ¹ / ₄ "	11 ¹ / ₄ "	5 ⁵ / ₈ "	2 ¹ / ₄ "	5 ¹ / ₄ "	5"	6, 8, 9, 10, 12
12"	11 ⁵ / ₈ "	9 ³ / ₈ "	16 ¹ / ₂ "	2 ⁷ / ₈ "	2 ³ / ₈ "	7 ¹ / ₈ "	1 ³ / ₈ "	1 ³ / ₄ "	2 ¹ / ₄ "	13 ³ / ₄ "	3 ¹ / ₄ "	2 ⁵ / ₈ "	6 ¹ / ₈ "	5 ³ / ₄ "	6, 8, 9, 10, 12, 14, 16, 18
14"	13 ³ / ₈ "	11 ⁵ / ₈ "	19 ¹ / ₂ "	3 ³ / ₈ "	3 ³ / ₈ "	1 ¹ / ₈ "	1"	2"	2 ⁷ / ₈ "	17"	7 ¹ / ₈ "	2 ⁵ / ₈ "	7 ³ / ₄ "	7"	8, 9, 10, 12, 14, 16, 18
16"	15 ³ / ₄ "	13 ⁵ / ₈ "	22"	3 ³ / ₈ "	3 ³ / ₈ "	1 ¹ / ₈ "	1 ³ / ₈ "	2 ¹ / ₄ "	2 ⁵ / ₈ "	19 ⁵ / ₈ "	1"	3"	8 ³ / ₈ "	8"	8, 10, 12, 14, 16, 18, 20
18"	17 ¹ / ₂ "	15 ³ / ₈ "	24 ⁵ / ₈ "	4"	4"	1 ¹ / ₈ "	1 ¹ / ₈ "	2 ³ / ₄ "	3 ¹ / ₈ "	22 ³ / ₈ "	1 ¹ / ₂ "	10 ³ / ₄ "	9 ⁵ / ₈ "	8 ⁷ / ₈ "	8, 10, 12, 14, 16, 20, 22, 24, 26
20"	19 ¹ / ₂ "	17 ³ / ₈ "	27"	4 ³ / ₄ "	4 ¹ / ₂ "	2"	1 ¹ / ₈ "	2 ⁷ / ₈ "	3 ³ / ₈ "	24 ⁵ / ₈ "	1 ¹ / ₂ "	10 ³ / ₄ "	11 ¹ / ₄ "	9"	10, 12, 14, 16, 18, 20, 22, 24
22"	21 ⁵ / ₈ "	19 ¹ / ₄ "	30 ¹ / ₄ "	5"	5"	2"	1 ¹ / ₈ "	3"	3 ³ / ₄ "	27 ¹ / ₂ "	1 ¹ / ₂ "	10 ³ / ₄ "	12"	10 ¹ / ₄ "	16, 18, 20, 22, 24, 26
24"	23 ⁵ / ₈ "	21 ¹ / ₄ "	33 ¹ / ₂ "	6"	6 ¹ / ₄ "	6 ¹ / ₄ "	2"	3 ¹ / ₂ "	4"	30 ⁵ / ₈ "	1 ¹ / ₂ "	10 ³ / ₄ "	13 ¹ / ₂ "	11 ⁵ / ₈ "	12, 14, 16, 18, 20, 22, 24, 26, 28, 30
28"	28"	24 ¹ / ₈ "	38"	6 ³ / ₄ "	6 ¹ / ₂ "	2 ³ / ₄ "	2 ¹ / ₄ "	3 ¹ / ₄ "	4 ⁷ / ₈ "	33 ³ / ₈ "	1 ¹ / ₂ "	10 ³ / ₄ "	15 ¹ / ₂ "	11 ³ / ₄ "	20, 22, 24, 26, 28
30"	29 ⁵ / ₈ "	26 ¹ / ₂ "	41 ¹ / ₈ "	6 ¹ / ₂ "	5 ⁷ / ₈ "	2 ¹ / ₂ "	3"	4"	4 ⁵ / ₈ "	38 ¹ / ₄ "	1 ¹ / ₂ "	10 ³ / ₄ "	14 ⁷ / ₈ "	14 ³ / ₈ "	20, 22, 24, 26, 28, 30

*There may be a variance of up to 1/4" in all dimensions. Fluted columns available in all diameters. See page 14 for Parallel dimensions. See page 16 for Decorative Capital dimensions.

Standard Fluted Column (Fluted in mold)

Split columns are not load bearing.

Poly Tuscan Cap

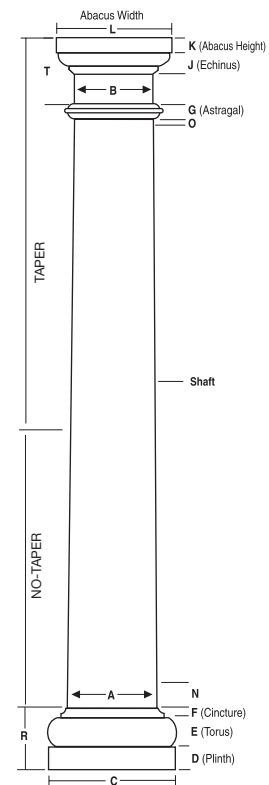

Poly Tuscan Base Plain Column.

Poly Tuscan Cap

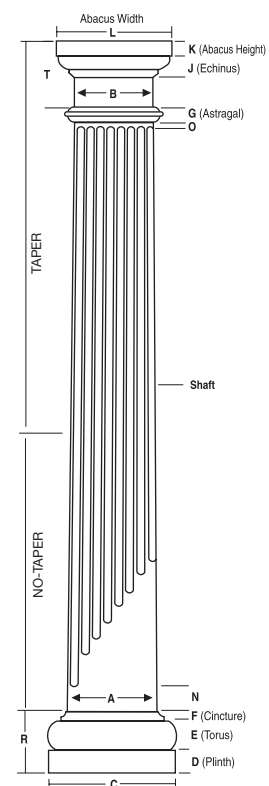

Poly Tuscan Base Fluted Column.

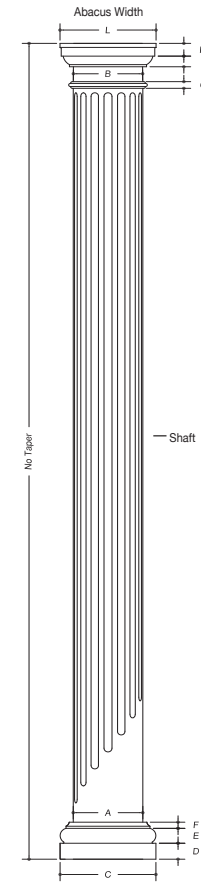

PermaCast® Plus No-Taper Column with Poly Tuscan Cap and Base.

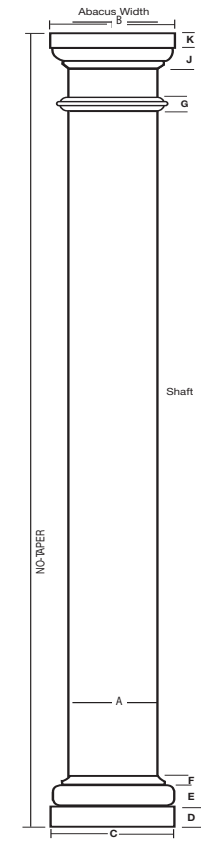

PermaCast® Plus Plain No-Taper Column with Poly Tuscan Cap and Base.

Fluted Round Tapered **PERMA**Cast® Plus Columns

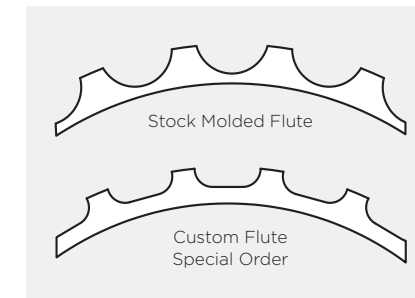

HB&G Offers Two Distinctive Types of Flutes.

Stock Molded Flute: Available in diameters of 8" x 8' - 16" x 10' columns (See price guide for specific lengths available.) The stock molded flute is part of the manufacturing process and cannot be altered.

Custom Flute: The custom flute is milled after the column is manufactured and can be modified to your specific length. All round PermaCast® Plus columns, 6" x 4' - 30" x 30', are available with an optional custom flute. (Call a customer service representative for pricing and lead times.) Adjusted Flutes available.

*Inside dimension may vary from "Stock" Flutes

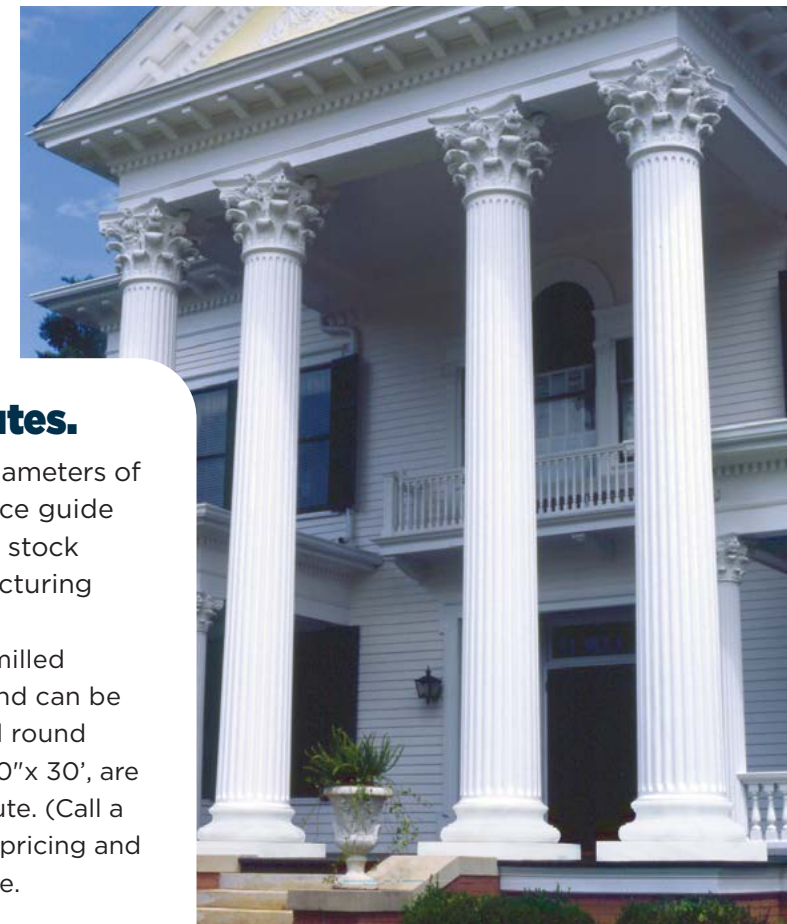

Plumb-Fit®

To make installation even easier our 6"-12" round and square poly Tuscan Cap and Base Sets with flashing cap come with the Plumb-Fit® patented (Patent 9689674) installation system included.



The HB&G Porch Installation Bracket includes the bracket and all required hardware. The bracket fits 20" - 30" Plain Round PermaCast® Plus Columns and will secure a 2nd story porch to our PermaCast® Plus Columns. Three brackets are required for each column.

ROUND PERMACAST® PLUS INSIDE DIMENSIONS

Inside dimension may vary up to 1/8". Splitting a column will decrease inside dimension 1/8".

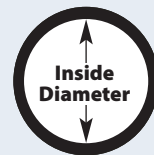

Column Size	Top I.D.	Bottom I.D.
6"	3 ⁷ / ₈ "	4 ⁷ / ₈ "
8"	3 ¹ / ₂ "	6 ⁷ / ₈ "
10"	7 ³ / ₈ "	8 ⁷ / ₈ "
12"	8 ⁵ / ₈ "	10 ⁷ / ₈ "
14"	10 ⁷ / ₈ "	12 ⁷ / ₈ "
16"	12 ⁷ / ₈ "	15"
18"	14 ¹ / ₂ "	16 ⁵ / ₈ "
20"	16 ⁵ / ₈ "	18 ⁵ / ₈ "
22"	18 ³ / ₈ "	20 ¹³ / ₁₆ "
24"	20"	22 ³ / ₈ "
28"	22 ⁷ / ₈ "	26 ³ / ₄ "
30"	25 ¹ / ₄ "	28 ³ / ₈ "

*Plain columns only

Round No-Taper Permacast® Plus Columns

ROUND NO-TAPER PERMACAST® PLUS COLUMN DIMENSIONS (IN INCHES)

Col. Size	A	B	C	D	E	F	G	J	K	L	Lengths Available. (ft.)
8"	7 ⁵ / ₈ "	7 ⁵ / ₈ "	10 ¹ / ₂ "	1 ⁷ / ₈ "	1 ³ / ₄ "	3 ¹ / ₄ "	3 ¹ / ₄ "	1 ¹ / ₄ "	1 ¹ / ₂ "	10 ⁵ / ₈ "	6, 8, 9, 10
10"	9 ⁵ / ₈ "	9 ⁵ / ₈ "	13 ¹ / ₈ "	2 ³ / ₈ "	2 ¹ / ₈ "	3 ¹ / ₄ "	3 ¹ / ₄ "	1 ¹ / ₄ "	2"	12 ³ / ₈ "	6, 8, 9, 10, 12
12"	11 ⁵ / ₈ "	11 ⁵ / ₈ "	16 ¹ / ₂ "	2 ³ / ₈ "	2 ³ / ₈ "	7 ¹ / ₈ "	3 ¹ / ₄ "	1 ¹ / ₄ "	2"	15 ¹ / ₈ "	6, 8, 9, 10, 12
14"	13 ⁵ / ₈ "	13 ⁵ / ₈ "	19 ¹ / ₂ "	3 ³ / ₈ "	3 ¹ / ₈ "	1 ¹ / ₈ "	1"	2 ¹ / ₄ "	3"	19 ¹ / ₈ "	6, 8, 9, 10, 12, 14
16"	15 ³ / ₄ "	15 ³ / ₄ "	22"	3 ³ / ₈ "	3 ¹ / ₂ "	1 ¹ / ₄ "	1"	2 ¹ / ₄ "	2 ³ / ₄ "	22"	6, 8, 9, 10, 12, 14, 16, 18, 20
18"	17 ¹ / ₂ "	17 ¹ / ₂ "	24 ⁵ / ₈ "	4"	4"	1 ⁵ / ₈ "	1 ³ / ₈ "	2 ³ / ₄ "	3 ¹ / ₈ "	24 ⁵ / ₈ "	6, 8, 9, 10, 12, 14, 16, 18, 20
24"	24"	24"	33 ¹ / ₂ "	5 ³ / ₄ "	5 ¹ / ₄ "	2 ³ / ₈ "	2 ¹ / ₈ "	3 ¹ / ₂ "	4 ¹ / ₈ "	33 ³ / ₈ "	8, 9, 10, 12, 14, 16, 20, 24, 26, 28, 30

Neck mould not included.

Flashing and Installation Kit not available with No-Taper Tuscan cap and base sets.

Split columns are not load bearing.

Neck Mould for No-Taper Column - Sold Separately.

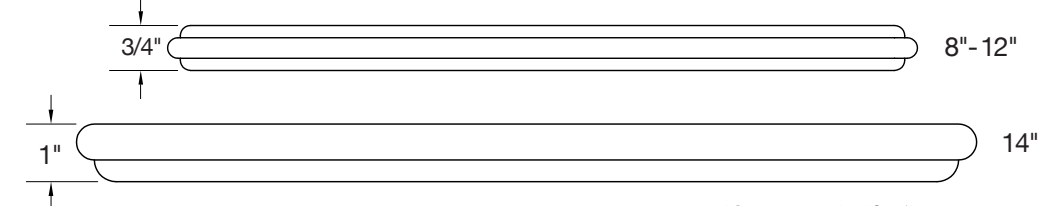

*Go up one size if splitting

HB&G's number one goal is finding ways that we can save you time and make your life easier.

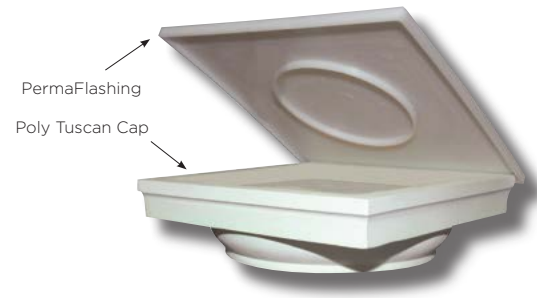

PermaCast® Plus PermaFlashing and Installation Kit

The PermaCast® flashing with Plumb-Fit® and installation kit is available in selected Tuscan cap and base sets.* This innovation will not only save time but will keep the elements out of the column and secure the top and bottom of the column.

*Not available in Tuscan cap and base sets for Craftsman, No-taper, PermaLite®, and Wood columns.

HB&G offers a split kit and a split kit with flange option with an improved adhesive.

These kits can be purchased separately.

Adhesive must be stored in a climate-controlled environment.

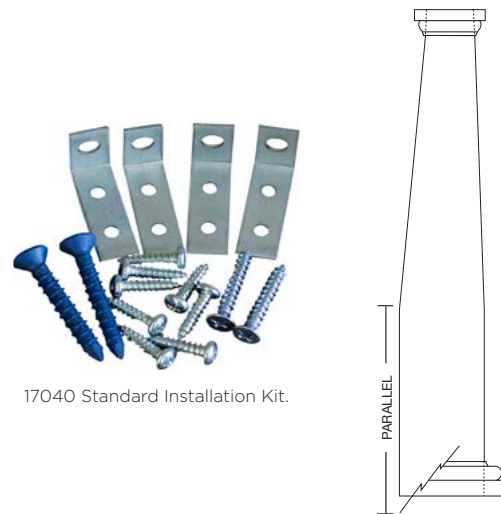

17040 Standard Installation Kit.

Entasis - Parallel Dimensions are used to specify where the column begins to taper. These dimensions use length from the bottom of the column shaft to the point where the taper begins. This is necessary to determine how much a column can be shortened before the base begins to fit loosely. Filler and caulking may be used to fill the gap between the base and shaft if it is necessary to shorten the column beyond the parallel dimension.

PARALLEL DIMENSIONS*

Column Size	Parallel Dim.	Column Size	Parallel Dim.
6 x 4	0"	18 x 18	60"
6 x 6	9"	18 x 20	84"
6 x 8	32"	18 x 22	49"
8 x 5	12"	18 x 24	73"
8 x 6	24"	18 x 26	97"
8 x 8	32"	20 x 10	0"
8 x 9	28"	20 x 12	0"
8 x 10	40"	20 x 14	0"
10 x 6	8"	20 x 16	4"
10 x 8	32"	20 x 18	28"
10 x 9	28"	20 x 20	52"
10 x 10	40"	20 x 22	76"
10 x 12	48"	20 x 24	100"
12 x 6	8"	22 x 16	45"
12 x 8	32"	22 x 18	69"
12 x 9	20"	22 x 20	93"
12 x 10	32"	22 x 22	53"
12 x 12	48"	22 x 24	77"
12 x 14	25"	22 x 26	101"
12 x 16	40"	24 x 12	21"
12 x 18	73"	24 x 14	45"
14 x 8	32"	24 x 16	69"
14 x 9	12"	24 x 18	93"
14 x 10	24"	24 x 20	75"
14 x 12	48"	24 x 22	99"
14 x 14	27"	24 x 24	123"
14 x 16	51"	24 x 26	77"
14 x 18	75"	24 x 28	101"
16 x 8	16"	24 x 30	125"
16 x 10	40"	28 x 20	20"
16 x 12	29"	28 x 22	44"
16 x 14	53"	28 x 24	68"
16 x 16	36"	28 x 26	92"
16 x 18	60"	28 x 28	116"
16 x 20	84"	30 x 20	92"
18 x 8	0"	30 x 22	116"
18 x 10	16"	30 x 24	140"
18 x 12	40"	30 x 26	75"
18 x 14	48"	30 x 28	99"
18 x 16	36"	30 x 30	123"

Column Size	Parallel Dimensions
6 x 4	5 3/8"
18 x 8	17 1/4"
20 x 10	18 1/16"
20 x 12	18 5/16"
20 x 14	19 1/4"

*For Tapered Round Columns

PERMA Capitals and Bases

Choosing the right cap and base for your columns is as important as the selection of the column itself. The right cap and base can define the style of the front porch and create an atmosphere that compliments your lifestyle. The cap and base options offered by HB&G are shown on page 7. Please refer to the following data that corresponds with your cap and base selection to ensure that you end up with the products that work best for you.

Capital and Base Options

Most capitals and bases for PermaCast® columns are made of polyurethane and are decorative. The shaft fits through the center of the capital and base and does not alter the height of the shaft. Decorative capitals for round PermaCast® Plus columns will add to the overall height of the column itself.

Attic Base

Attic Bases are used for a more ornate look and come in 1 or 2 pieces depending on their size.

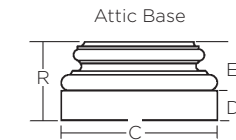

Crown Cap

Available for PermaCast® Plus Square shafts 6-12".

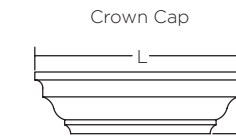

Colonial Cap and Base

Referred to as our low profile cap and base, the Colonial is designed specifically for use in applications where railing will be attached to the column. Available for PermaCast® Plus round and square shafts 6"-12".



Beveled Cap and Base

Designed to deliver a popular, more contemporary appearance, beveled caps and bases are available for PermaCast® Plus Square shafts 6-12".



PermaTuff® Base and Poly Cap

A durable hard shell base combined with a poly cap. Designed for high traffic applications. Available for PermaCast® Plus round shafts 8"-12".

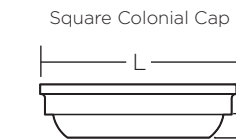

Tuscan Cap and Bases

The Tuscan style is standard and best compliments the PermaCast® Plus column. The Tuscan is available for all round and square shafts. For dimensions see pages 9-10, 12-13, and 16.

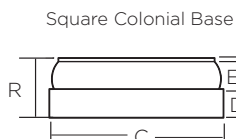

Decorative Capital

Five styles of decorative capitals are available for all round tapered and square shafts. Using a decorative capital with a round PermaCast® Plus shaft will add to the overall height of the column itself. Decorative capitals do not alter the height of the shaft when used on a square PermaCast® Plus Column.

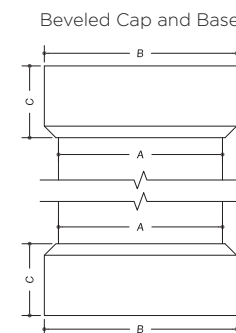

DIMENSIONS OF ATTIC BASE FOR ROUND AND SQUARE COLUMNS

Column Size	Round Attic				Column Size	Square Attic			
	C	DD	EE	R		C	DD	EE	R
6"	8 5/16"	1 3/8"	2 3/4"	4 1/8"	6"	8 7/16"	1 3/8"	2 7/8"	4 1/4"
8"	10 1/8"	1 7/8"	3 1/4"	5 1/8"	8"	11"	1 7/8"	3 1/4"	5 1/8"
10"	13"	2 1/2"	3 7/8"	6 3/8"	10"	13 5/8"	2 3/8"	4"	6 3/8"
12"	16 1/8"	3"	4 1/2"	7 1/2"	12"	17"	2 3/4"	4 1/2"	7 1/2"
14"	19 1/4"	3 3/8"	5 3/8"	8 3/4"	14"	N/A	N/A	N/A	N/A
16"	21 3/4"	4"	6 1/2"	10 1/2"	16"	22 1/4"	4"	6 5/8"	10 5/8"
18"	25"	4 3/8"	7 1/4"	11 5/8"	18"	N/A	N/A	N/A	N/A
20"	27 1/16"	4 7/8"	8 1/4"	13 3/8"	20"	N/A	N/A	N/A	N/A
22"	30 1/4"	5 3/8"	9 1/4"	14 5/8"	22"	N/A	N/A	N/A	N/A
24"	33 1/2"	6"	10 1/4"	16 1/4"	24"	N/A	N/A	N/A	N/A
28"	38"	6 3/4"	11 3/8"	18 1/8"	28"	N/A	N/A	N/A	N/A
30"	41 1/4"	6 1/2"	11 1/4"	17 3/4"	30"	N/A	N/A	N/A	N/A

CROWN CAP* FOR SQUARE COLUMN DIMENSIONS

Column Size	K	J	L
6"	1 9/16"	2 5/16"	11 1/4"
8"	1 9/16"	2 5/16"	13 1/4"
10"	1 9/16"	2 5/16"	15 1/4"
12"	1 9/16"	2 5/16"	17 1/4"

*Made from Polyurethane

COLONIAL ROUND CAP AND BASE DIMENSIONS*

Col. Size	C	D	E	F	J	K	L	R
6"	7 1/4"	1 3/8"	1 1/4"	1/4"	1"	1 1/4"	7"	2 7/8"
8"	9 1/8"	1 1/2"	1 5/16"	1/4"	1 1/16"	1 3/8"	9"	3"
10"	11 1/8"	1 1/2"	1 1/4"	1/4"	1 1/16"	1 3/8"	10 9/16"	3"
12"	13 1/8"	1 1/2"	1 1/4"	1/4"	1 1/16"	1 3/8"	12"	3"

*Low profile option.

COLONIAL SQUARE CAP AND BASE DIMENSIONS*

Col. Size	C	D	E	F	J	K	L	R
6"	8 1/4"	1 3/8"	1 5/16"	3/16"	1"	1 3/8"	8 1/4"	2 7/8"
8"	10 5/8"	1 1/4"	1 1/16"	7/16"	1 5/16"	1"	9 15/16"	2 3/4"
10"	12 5/8"	1 1/4"	1 5/16"	3/16"	1"	1 3/8"	12 5/8"	2 3/4"
12"	14 5/8"	1 1/4"	1"	1/2"	1"	1 3/8"	14 5/8"	2 3/4"

*Low profile option.

BEVELED CAP & BASE SET*

Size	A	B	C
6"	6"	8 1/4"	3 1/2"
8"	8"	10 1/4"	3 1/2"
10"	10"	12 1/4"	5 1/2"
12"	12"	14 1/4"	5 1/2"

*For Square PermaCast® Columns. See Installation Kit on page 14.

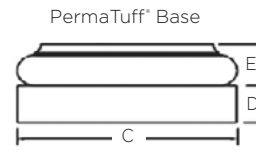
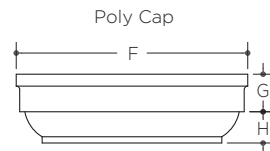
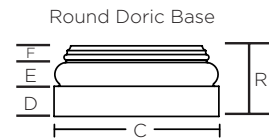
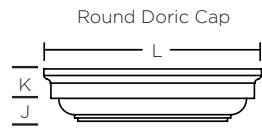

DORIC CAP AND BASE DIMENSIONS

Column Size	C	D	E	F	J	K	L	R
8"	10 1/8"	1 7/8"	1 5/8"	7/8"	1"	1 3/8"	10"	4 7/16"
10"	12 5/16"	2 3/8"	2 1/16"	1 1/8"	1 5/16"	1 11/16"	12 1/2"	5 9/16"
12"	15 1/2"	2 7/8"	2 1/2"	1 3/8"	1 9/16"	2"	15"	6 11/16"
14"	18"	3 5/16"	2 7/8"	1 9/16"	1 13/16"	2 3/8"	17 1/2"	7 13/16"
16"	20"	3 3/4"	3"	2 1/4"	1 15/16"	2 3/4"	20 1/2"	9"
18"	23 1/4"	4"	3 1/2"	2 1/2"	1 3/4"	3"	23 1/8"	10"

TUSCAN PERMATUFF® BASE AND POLY CAP DIMENSIONS

Column Size	C	D	E	F	G	H
8"	10 1/4"	1 7/8"	2 3/8"	9 1/4"	1 1/2"	1 1/4"
10"	12 7/8"	2 3/8"	2 7/8"	11 1/4"	1 3/4"	1 1/4"
12"	15 1/4"	2 3/4"	3 1/4"	13 3/4"	2 1/4"	1 3/4"

*Not Available Split

DECORATIVE CAPITAL DIMENSIONS FOR ROUND TAPERED AND SQUARE COLUMNS (IN INCHES)

Size of Column	6"		8"		10"		12"		14"		16"		18"		20"		22"		24"		28"		30"	
	Round	Square	Round	Square	Round	Square	Round	Square	Round	Square	Round	Square	Round	Square	Round	Square	Round	Square	Round	Square	Round	Square	Round	Square
Roman Ionic	Height		3 1/8"	3 1/8"	4 1/8"	4 1/8"	4"	4 7/8"	4 5/8"	6 1/4"	5 5/8"	6 3/4"	6 3/4"	5 5/8"	6 3/4"	6 3/4"	10 5/16"	11 3/8"	13 3/8"	13 3/8"				
	Abacus		10 1/8"	8 1/8"	11 1/16"	10 3/4"	14 3/4"	12 1/2"	16 7/8"	17 1/8"	19 3/16"	26"	25 1/4"	23 3/16"	26 3/8"									
	Projection	N/A	3 1/4"	3 3/8"	3"	4 1/8"	4 1/8"	5"	6 1/4"	7 7/8"	8"	8 1/2"	11 1/4"	11 1/4"	10"	9 7/8"					N/A	N/A		
	O/S to O/S		12 1/8"	10 1/2"	13 15/16"	13 3/16"	17 1/4"	16 1/2"	23 1/8"	22 9/16"	24 3/8"	32 1/8"	31 3/4"	31 3/4"	33"	34"								
Inside Dia.*			2 5/8"		4 1/2"		5"		11 1/4"		14"		15 1/2"		17"		19 1/4"		21 3/4"					
Greek Ionic	Height		5 1/2"	4 1/8"	6 1/4"	5 5/8"	6 3/4"	6 3/4"	9 1/4"	6 3/4"	10 3/8"	11"	10 5/16"	11 3/8"	13 3/8"	13 3/8"								19 1/4"
	Abacus		11"	7 15/16"	12 5/8"	10 11/16"	16"	14 3/8"	17 3/4"	15 1/8"	22 1/8"	26 15/16"	22 3/16"	25 1/4"	29"	29"								42 1/2"
	Projection	N/A	4 5/8"	3 3/8"	4 7/8"	5"	5 5/8"	7 1/2"	7 1/4"	6 1/2"	10 1/4"	10 3/4"	9 1/2"	11 1/4"	15 1/2"	15 1/2"					N/A			19 1/2"
	O/S to O/S		14 1/2"	11 7/8"	17 1/16"	14 15/16"	20 7/8"	20 11/16"	26 3/8"	20 11/16"	29 1/4"	36 3/16"	29 1/8"	31 3/4"	43 1/2"	43 1/2"								60 3/4"
Inside Dia.*			2 5/8"		4 1/2"		5"		11 1/4"		14"		15 1/2"		17"		19 1/4"		21 3/4"					26 1/2"
Temple of the Winds	Height		8 7/8"	8"	11 1/2"	10 11/16"	13 3/8"	11 5/8"	20 1/2"	16 1/4"	18 1/4"	21 15/16"	21 7/8"	23"	24 1/8"	27 7/8"								
	Abacus		12 1/8"	11 7/8"	15 1/2"	13 7/16"	21 13/16"	16 5/8"	25 3/4"	23 1/4"	26"	29 15/16"	28 3/8"	34 3/4"	35 1/4"	37 1/4"								
	Projection	N/A	4 3/8"	5 1/2"	5 1/8"	6"	8"	7"	9 7/8"	10 7/8"	11 1/8"	9 3/4"	12"	15 1/2"	14 7/8"	16 1/8"								
	O/S to O/S		12 1/8"	11 7/8"	15 1/2"	13 7/16"	21 13/16"	16 5/8"	25 3/4"	23 3/8"	26"	29 15/16"	28 3/8"	34 3/4"	35 1/4"	37 1/4"								
Inside Dia.*			2 5/8"		4 1/2"		5"		11 1/4"		14"		15 1/2"		17"		19 1/4"		21 3/4"					
Roman Corinthian	Height		10 3/4"	8 11/16"	13 11/16"	11 5/16"	17 3/4"	14 5/8"	20 1/8"	17 5/8"	23"	26 1/2"	26 1/16"	28 7/16"	31 7/8"	34 1/4"								
	Abacus		13 1/4"	12 1/16"	18"	14 5/8"	22 5/8"	18 7/8"	26 1/4"	22 13/16"	32 3/8"	37 1/2"	38 7/8"	41 5/8"	40 1/4"	45 1/4"								
	Projection	N/A	4 1/4"	4 3/4"	6"	6 1/4"	7 7/8"	8 1/4"	8 7/8"	8 7/8"	14 1/4"	13 3/8"	17 1/2"	16 3/4"	16"	17 1/2"								
	O/S to O/S		13 1/4"	12 1/16"	18"	14 5/8"	22 5/8"	18 7/8"	26 1/4"	22 13/16"	32"	37 1/2"	38 7/8"	41 5/8"	40 1/4"	45 1/4"								
Inside Dia.*			2 5/8"		4 1/2"		5"		11 1/4"		14"		15 1/2"		17"		19 1/4"		21 3/4"					
Scamozzi	Height		3 1/4"	3 3/8"	5"	4 3/8"	5 5/8"	5 1/8"	6 1/2"	5 3/4"	7 7/16"	8 15/16"	8 3/4"	8 5/8"	10 3/4"	11 1/2"	12 1/4"	15 1/4"						
	Abacus		11 1/4"	9 7/8"	16 3/16"	14 1/4"	17 7/8"	16 5/8"	20 7/8"	18 1/4"	23 3/4"	26"	28 5/8"	28 1/2"	32"	36"	38 1/4"	46 1/4"						
	Projection	N/A	3 3/8"	3 3/8"	5 1/8"	5 3/8"	5 1/8"	6"	5 1/4"	6 5/8"	8 3/4"	5 1/4"	10 1/4"	10 1/4"	10 1/8"	12 1/2"	13 3/4"	16 1/8"						
	O/S to O/S		11 3/8"	10"	16 3/16"	14 1/4"	18 1/16"	16 5/8"	20 7/8"	18 5/8"	23 3/4"	26"	28 5/8"	28 5/8"	32"	36"	38 1/2"	46 1/4"						
Inside Dia.*			2 5/8"		4 1/2"		5"		11 1/4"		14"		15 1/2"		17"		19 1/4"		21 3/4"					

*Inside Diameter.

• See page 7 for images.

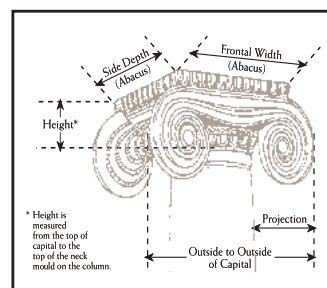

NOTE: Decorative Capitals are not designed to fit non-tapered columns.

Painting Instructions

Painting instructions for round and square PermaCast®Plus columns:

- Rinse and allow to dry completely.
- Prime with high quality exterior latex bonding primer or use an oil-based bonding primer in accordance with paint manufacturer's instructions. A light coat of primer should be applied and allowed to cure fully.
- Paint evenly with several light coats over column with a high quality exterior latex or oil-based paint in accordance with paint manufacturer's instructions.
- Do not paint PermaCast®Plus columns using dark colors (dark colors are considered any color that falls within the L value of 56 to 0). L is a measure of lightness of an object and ranges from 0 (black) to 100 (white).

Tips

- ✓ When ordering a decorative capital order the appropriate base for the column.
- ✓ Decorative capitals for square PermaCast®Plus slide over the shaft and do not use a plug. These decorative capitals will not add or subtract from the overall height.
- ✓ When installing a decorative capital on fluted, recessed panel, or square columns, the capital slides over the shaft. The taller capitals will cover the flutes and require additional caulking to finish.
- ✓ Verify exact opening measurement prior to ordering column length.
- ✓ When installing a PermaCast®Plus column, verify concentric loading of column. 100% of bottom must contact substrate and 75% of top must contact soffit.
- ✓ When attaching hand rails or corner iron to PermaCast®Plus columns, holes must be pre-drilled before applying screws.
- ✓ When ordering panel moulding for square PermaCast®Plus columns, make sure to order enough for four sides of the column.
- ✓ Split columns are left partially intact. Cut with masonry or carbide-tipped blade.
- ✓ All custom split columns, adjusted flutes, caps, and bases are nonrefundable.

Decorative Capitals for ROUND Tapered PermaCast®Plus Columns

Adding a load bearing decorative capital to a round PermaCast®Plus column will lengthen or shorten the overall height of the column depending on the height of the capital. Subtract the "T" dimension (from the column dimensions chart) and add the height of the decorative capital +/- 1/4" for overall column height.

8"-12" Load Bearing Capital

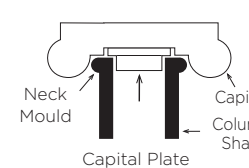

14"- 30" Non Load Bearing Capital with Separate Load bearing Plug

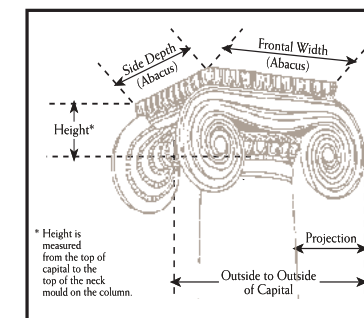
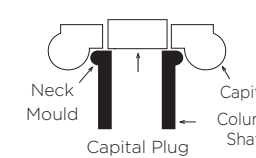

NOTE: Decorative Capitals are not designed to fit non-tapered columns.

Decorative Capitals for SQUARE PermaCast®Plus Columns

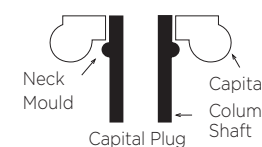

Adding a decorative capital to a square PermaCast® column DOES NOT change the length of the column shaft. The decorative capital simply slides over the shaft. Neck moulding can be applied or not.



PermaLite® Columns

- Weather Proof.
- Insect Proof.
- Load Bearing.
- Low Maintenance.
- Lightweight.
- Ready to Prime and Paint.
- Limited Lifetime Warranty.*

HB&G PermaLite® columns are cost effective solution that are load-bearing, extremely versatile, require very little routine maintenance and deliver all of the beauty of a column with just 1/3rd of the weight.



Top View Cut-Away

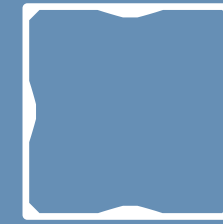

PermaLite® Plain



Square Tuscan Cap



Square Tuscan Base



PermaLite®
Square Plain

For Tuscan Cap and Base dimensions refer to page 21.



17040 Standard
Installation Kit
(Sold separately)



SQUARE PERMALITE® COLUMN DIMENSIONS (IN INCHES)

Column Size	A	C	D	E	F	G	J	K	L	P	Lengths Available (ft.)
6"	5½"	8½"	1½"	1¼"	½"	1¼"	⅞"	1⅛"	8"	N/A	6, 8, 9, 10
8"	7½"	10⅜"	1⅞"	1¾"	⅝"	1¼"	1"	1⅜"	10⅞"	3⅞"	6, 8, 9, 10, 12
8"*	7½"	10⅞"	1⅞"	1⅞"	⅝"	1¼"	1"	1⅜"	10¼"	3⅞"	6, 8, 9, 10, 12
10"	9½"	12⅞"	2½"	2⅞"	¾"	1¼"	1⅝"	1¾"	12¾"	4⅜"	6, 8, 9, 10, 12
10"*	9½"	13⅞"	3⅜"	2⅞"	¾"	1¼"	1¼"	1¾"	12¾"	4⅜"	6, 8, 9, 10, 12

- *SIM caps and bases. The remainder are poly caps and bases.
- Recessed panel available.
- Neck moulding is 4 pieces included with the cap and base.
- See drawings on page 20.
- NOTE: Tuscan cap dimensions are above.

NOTES: Neck mould is adjustable and is applied in the field. Factory split PermaLite® columns are not available. HB&G does not recommend splitting PermaLite® columns.



PermaLite® Square No-Taper Column shown with Tuscan Cap and Base.

SQUARE PERMALITE® INSIDE DIMENSION

Column Width	Inside
6"	4⅝"
8"	6⅝"
10"	8⅝"

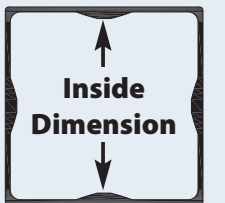

COLONIAL SQUARE CAP AND BASE FOR PERMALITE®

Column Size	C	D	E	F	J	K	L	R
6"	8⅞"	1¼"	1⅛"	⅞"	⅝"	1"	7⅞"	2¾"
8"	10⅞"	1¼"	1⅛"	⅞"	1⅝"	1"	9⅞"	2¾"
10"	12⅞"	1¼"	1⅛"	⅞"	1⅝"	1¼"	12⅞"	2¾"

- Neck moulding is 4 pieces included with the cap and base.
- See drawings on page 20.

BEVELED CAP & BASE SET

Size	A	B	C
6"	5½"	7⅞"	3½"
8"	7½"	7⅞"	3½"
10"	9½"	11⅝"	5½"

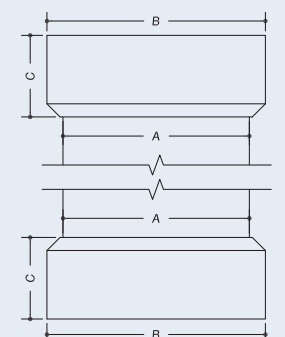

See Installation Kit on page 19.

SmartColumn®

A NEW SEAMLESS FIBERGLASS SLEEVE FOR PRESSURE TREATED WOOD POSTS*

Features

- Easy installation! Installs 3.5 times faster than a typical site-built column.
- Limited Lifetime Warranty for peace of mind.
- Superior aesthetics compared to a site-built column.
- SmartColumn® = The Smart Choice.

What you need to know:

- Structural post and installation brackets are not included.
- Order by rough opening size. The column shaft itself is designed to be 12" shorter than the rough opening.
- Capital and base attached to the column shaft conceal all hardware and post once installed.

PLAIN SQUARE SMART COLUMN DIMENSIONS (IN INCHES)

Column Size	A	B	C	D	E	F	G	H	I	Lengths Avail. (ft.)
6"	5½"	6¾"	2"	8"	⅛"	¼"	5⅙"	1¼"	⅜"	9, 9, 10
8"	7½"	8¾"	2"	8"	⅜"	¼"	7"	1¼"	⅜"	8, 9, 10
10"	9½"	10¾"	2"	8"	⅜"	¼"	9"	1¼"	⅜"	8, 9, 10

* SmartColumns® include SIM cap and base.

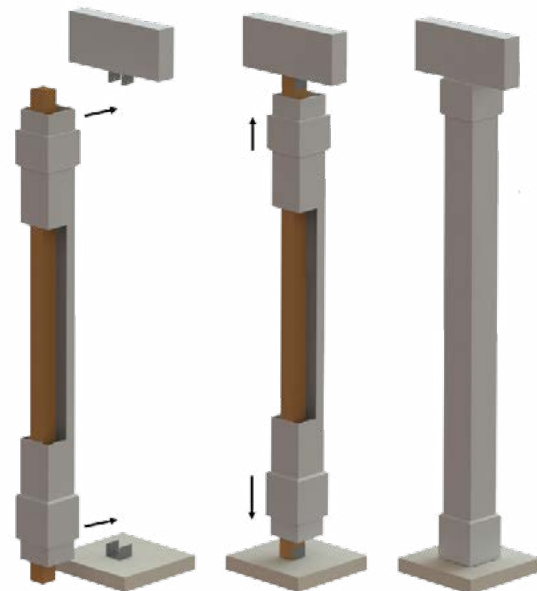

*Pressure treated post not included

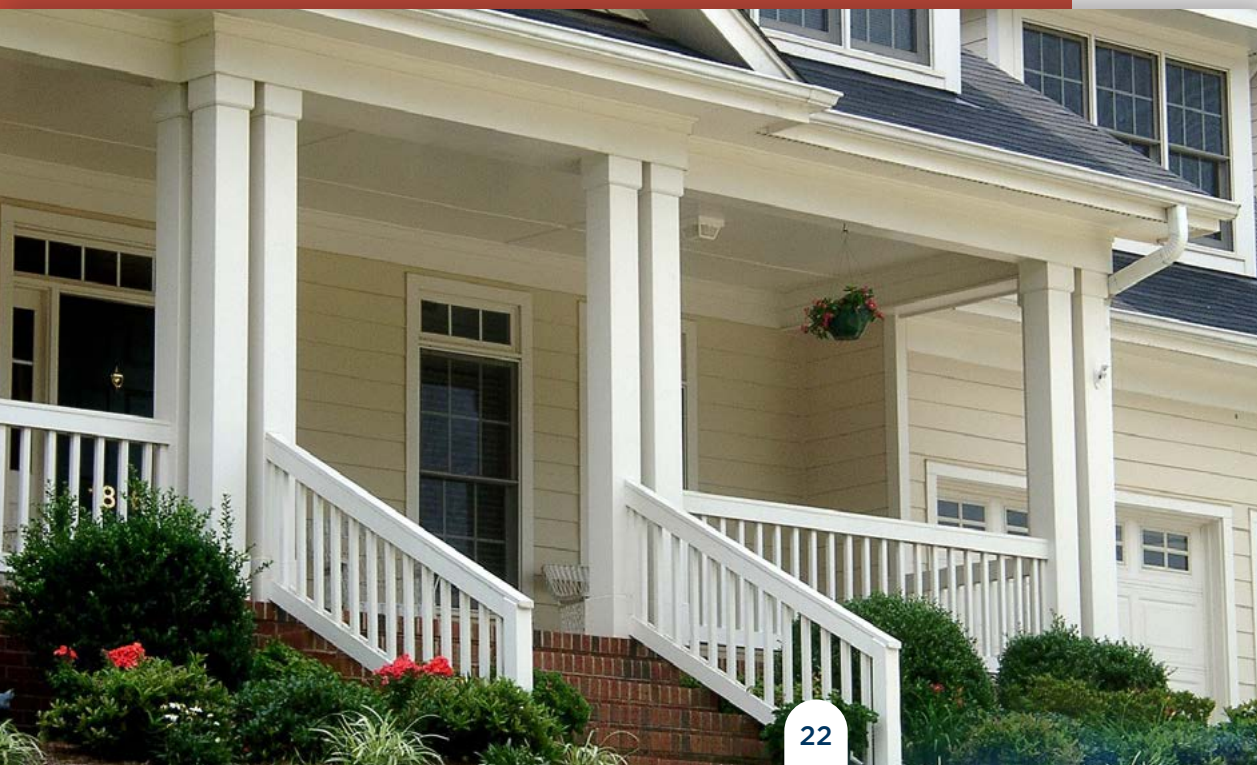
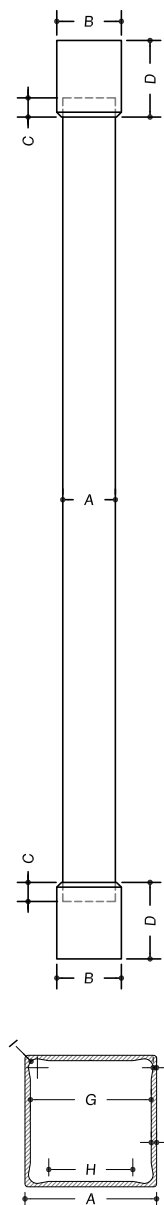

PermaSnap™ Column Wrap

- 25 Year Limited Warranty*
- Weather Proof
- Insect Proof
- Low Maintenance
- Made from PVC
- Easy Installation

Transform a treated post into a finished column in minutes with PermaSnap™. PermaSnap™ column wrap's special design permits easy installation by one person. It can also be used as a newel post wrap.

Bed Mould* Hampton Chesapeake



NOTE: Follow cPVC painting instructions on page 25.

- Adhesive not included.
- *See Warranty.



PermaSnap™ Column Wrap Technical Specifications

Product Description Will Fit	Outside	Column Wrap Dimension
4" x 4" x 8'- 6"	4¾" x 4¾"	4" x 4" Post
4" x 4" x 10'- 0"	4¾" x 4¾"	4" x 4" Post
6" x 6" x 8'- 6"	6¾" x 6¾"	6" x 6" Post
6" x 6" x 10'- 0"	6¾" x 6¾"	6" x 6" Post
8" x 8" x 8'- 6"	9½" x 9½"	8" x 8" Post
8" x 8" x 10'- 0"	9½" x 9½"	8" x 8" Post
10" x 10" x 8'- 6"	11½" x 11½"	10" x 10" Post
10" x 10" x 10'- 0"	11½" x 11½"	10" x 10" Post

*There may be a variance of up to ¼" in all dimensions.



PermaSnap™ Accessories Sizes Available

Bed Mould Trim Kit*	4, 6, 8 and 10"
Hampton Trim Kit	4, 6, 8 and 10"
Chesapeake Trim Kit	4, 6, 8 and 10"
Bed Mould XL	4, 6, 8 and 10"
Neck Mould	4, 6, 8 and 10"
Charleston Newel Cap	4"
Wilmington Newel Cap	4"
Ashbury Newel Cap	6"

*Bed Mould Trim Kit is needed for both ends
Note: Accessories sold separately.

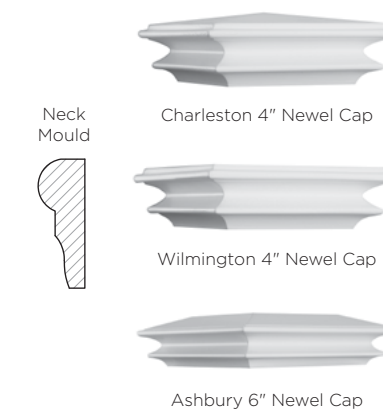



- 25 year limited warranty.*
- Custom styles available.
- Made from cellular PVC.
- Installation kit included.
- Interior and exterior use.
- Weather proof.
- Insect proof.
- Low maintenance.

Leading the industry in column innovation, HB&G PermaWrap® columns are made from cellular PVC which offers the advantages of being unaffected by moisture and insects but has the thickness, ease of use, and workability of wood. PermaWrap® columns are available in multiple sizes and styles – square or Craftsman – plain, fluted, raised panel, and recessed panel. With all of these options, you are certain to find just the right amount of detail for your specific project. Best of all, the PermaWrap® column comes with a 25-year HB&G warranty.

***See Warranty.**

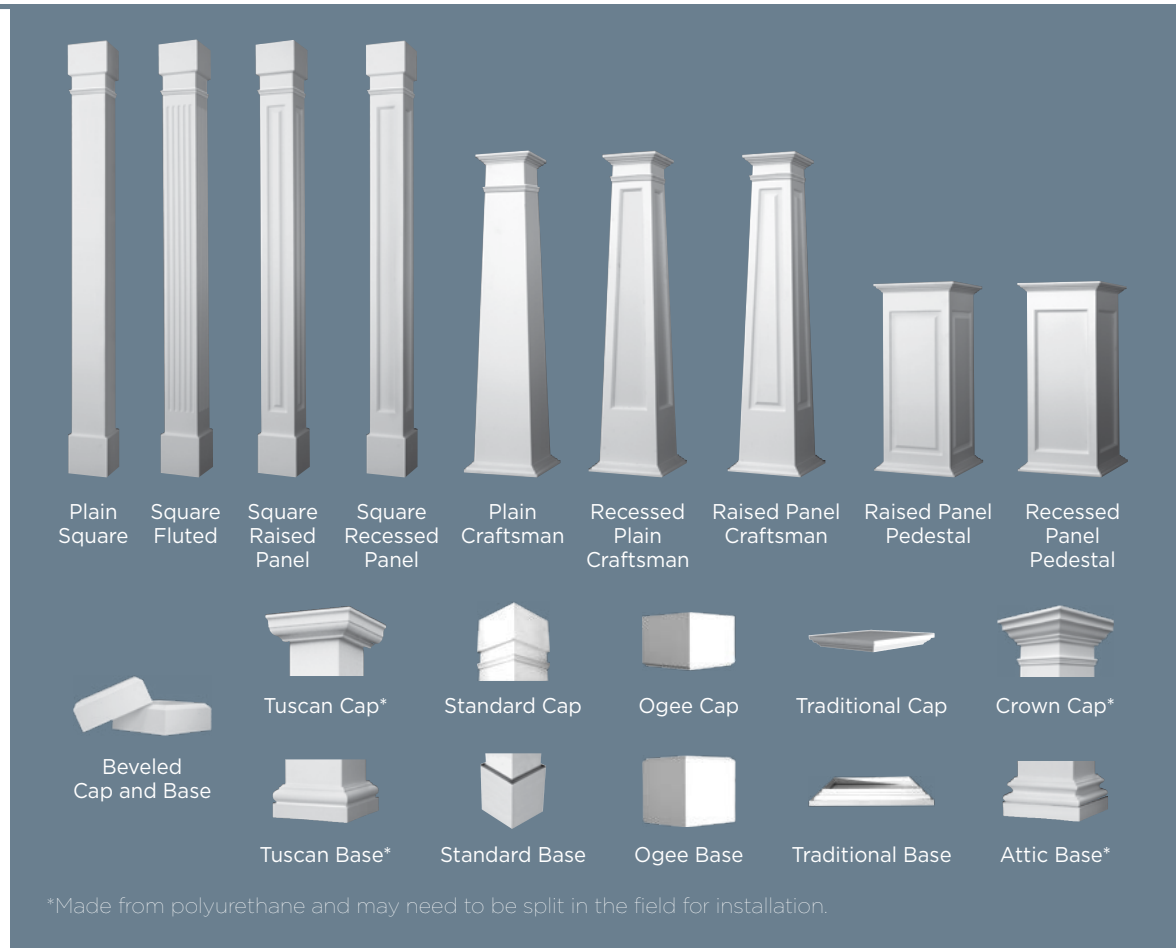

*Made from polyurethane and may need to be split in the field for installation.



**ALL THE GRAIN
AND NOTHING
TO MAINTAIN**



PVC Painting And Finishing

Caulk where required using Siroflex® brand Sealant and Adhesive provided by manufacturer. Putty any holes using acrylic putty or caulk. Lightly sand or scuff surface of column. Clean surface of column to remove any dirt or hand oil residue with light detergent and water, denatured alcohol, or window cleaner. Be sure to remove soap residue with clean water. Apply one coat of 100% acrylic exterior bonding primer and one or more finish coats of 100% acrylic exterior paint.

Do not paint columns using dark colors (dark colors are considered any color that falls within the L value of 56 to 0). L is a measure of lightness of an object and ranges from 0 (black) to 100 (white).



12" PermaWrap® Column

New **Woodgrain PVC PermaWrap** columns quickly transform a treated post into a decorative column in just minutes, eliminating the hassle of cutting other materials on the job site. **They're low maintenance, weather-proof and insect-proof and come with a Limited Lifetime Warranty.** Featuring a realistic embossed woodgrain pattern which resembles popular trim boards and cement siding on the market today, these products bring a simple solution to your building projects.

Item Description

8" x 9' RS PVC Plain Square

8" x 8' RS PVC Plain Square

8" x 10' RS PVC Plain Square

10" x 10' RS PVC Plain Square

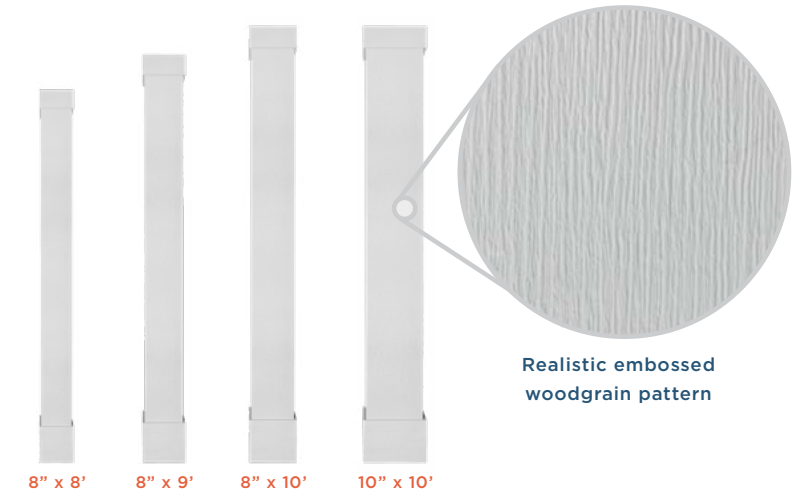

Realistic embossed woodgrain pattern



PLAIN PERMAWRAP® WITH STANDARD CAP & BASE DIMENSIONS (IN INCHES)

Col. Width	A	C	G	L	R	U	Lengths (ft.)
6"	5 7/8"	6 3/4"	1"	6 3/4"	12"	6"	6, 8, 9, 10, 12
8"	7 7/8"	8 3/4"	1"	8 3/4"	12"	6"	6, 8, 9, 10, 12
10"	9 7/8"	10 3/4"	1"	10 3/4"	12"	6"	6, 8, 9, 10, 12
12"	11 7/8"	12 3/4"	1"	12 3/4"	12"	6"	6, 8, 9, 10, 12

- Ogee cap and base available.
- Structural options available.
- Standard cap and base = 3/8" material.



Standard Cap Standard Base

AVAILABLE SIZES

Col. Width	Lengths (ft.)
6"	6, 8, 9, 10, 12
8"	6, 8, 9, 10, 12
10"	6, 8, 9, 10, 12
12"	6, 8, 9, 10, 12

INSIDE DIMENSIONS FOR VALUE 3/8" MAT

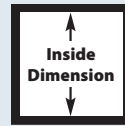

6"	5 1/8"
8"	7 1/8"
10"	9 1/8"
12"	11 1/8"

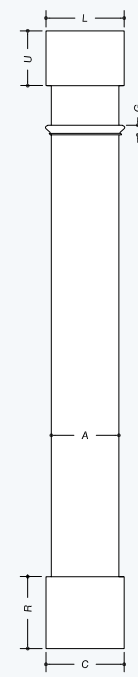

Plain Square

Standard Cap & Base



Plain Craftsman Recessed Panel Craftsman Raised Panel Craftsman

PERMAWRAP® PLAIN, RECESSED, AND RAISED PANEL CRAFTSMAN DIMENSIONS (IN INCHES)

Col. Width	A	B	C	G	L	N	O	S	R	U	Lengths
10" x 6"	9 7/8"	5 7/8"	12 7/8"	1 1/8"	8 7/8"	6"	6"	1 3/4"	2"	2"	48", 54", 60", 66", 72", 84", 96", 108", 120"
12" x 8"	11 7/8"	7 7/8"	14 7/8"	1 1/8"	10 7/8"	6"	6"	1 3/4"	2"	2"	48", 54", 60", 66", 72", 84", 96", 108", 120"
16" x 10"	15 7/8"	9 7/8"	18 7/8"	1 1/8"	12 7/8"	6"	6"	1 3/4"	2"	2"	48", 54", 60", 66", 72", 84", 96", 108", 120"
20" x 15"	19 7/8"	14 7/8"	22 7/8"	1 1/8"	17 7/8"	6"	6"	1 3/4"	2"	2"	48", 54", 60", 66", 72", 84", 96", 108", 120"
24" x 16"	23 7/8"	15 7/8"	26 7/8"	1 1/8"	18 7/8"	6"	6"	1 3/4"	2"	2"	48", 54", 60", 66", 72", 84", 96", 108", 120"

*Additional sizes are available from 5" to 24" wide and 2' to 20' in length.

PLAIN PANEL INSIDE DIMENSIONS

	Bottom	Top
10" x 6"	8 7/8"	4 7/8"
12" x 8"	10 7/8"	6 7/8"
16" x 10"	14 7/8"	8 7/8"
20" x 15"	18 7/8"	13 7/8"
24" x 16"	22 7/8"	14 7/8"

RECESSED PANEL INSIDE DIMENSIONS

	Bottom	Top
10" x 6"	7 7/8"	3 7/8"
12" x 8"	9 7/8"	5 7/8"
16" x 10"	13 7/8"	7 7/8"
20" x 15"	17 7/8"	12 7/8"
24" x 16"	21 7/8"	13 7/8"

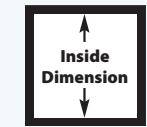

Inside Dimension

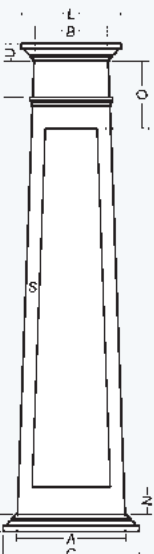

Traditional Cap and Base

AVAILABLE SIZES

10" x 6"	48", 54", 60", 66", 72", 84", 96", 108", 120"
12" x 8"	48", 54", 60", 66", 72", 84", 96", 108", 120"
16" x 10"	48", 54", 60", 66", 72", 84", 96", 108", 120"
20" x 15"	48", 54", 60", 66", 72", 84", 96", 108", 120"
24" x 16"	48", 54", 60", 66", 72", 84", 96", 108", 120"

PERMAWRAP® PLAIN, FLUTED, RECESSED PANEL, AND RAISED PANEL WITH OGEE CAP & BASE DIMENSIONS (IN INCHES)

Col. Width	A	C	G	L	N	O	S*	R	U	Lengths (ft.)
6"	5 7/8"	7 1/4"	1 1/8"	7 1/4"	6"	6"	1 3/4"	9"	7"	6, 8, 9, 10, 12
8"	7 7/8"	9 1/4"	1 1/8"	9 1/4"	6"	6"	1 3/4"	9"	7"	6, 8, 9, 10, 12
10"	9 7/8"	11 1/4"	1 1/8"	11 1/4"	6"	6"	1 3/4"	9"	7"	6, 8, 9, 10, 12
12"	11 7/8"	13 1/4"	1 1/8"	13 1/4"	6"	6"	1 3/4"	9"	7"	6, 8, 9, 10, 12

* Ogee cap and base = 3/8" material. Rail breaks are 7" long and designed to fit 36" or 42" rail heights. *S dimension for 6" raised panel is 1 1/4", 8" raised panel is 1 1/2". S dimension for fluted columns vary. Additional sizes are available.

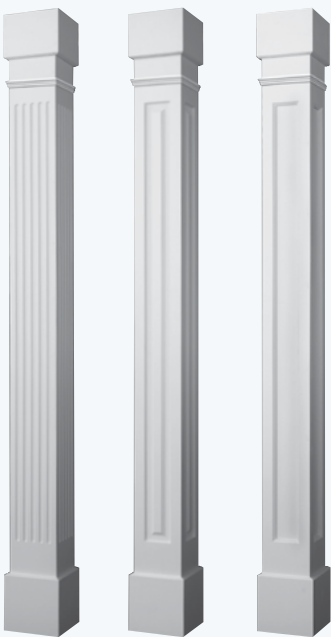

Square Fluted Square Raised Panel Square Recessed Panel



Ogee Cap Ogee Base

INSIDE DIMENSIONS* FOR PREMIUM

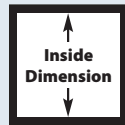

6"	4 1/8"
8"	6 1/8"
10"	8 1/8"
12"	10 1/8"

NUMBER OF FLUTES PER SIDE

6"	3
8"	5
10"	7
12"	8

AVAILABLE SIZES

Col. Width	Lengths (ft.)
6"	6, 8, 9, 10, 12
8"	6, 8, 9, 10, 12
10"	6, 8, 9, 10, 12
12"	6, 8, 9, 10, 12

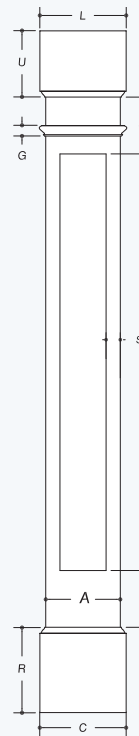

Ogee Cap & Base



PERMAWRAP® PEDESTAL DIMENSIONS (IN INCHES)

Col. Width	A	C	L	N	O	S	R	U	Lengths (ft.)
12"	11 7/8"	14 7/8"	14 7/8"	6"	6"	1 3/4"	2"	2"	40", 46"
16"	15 7/8"	18 7/8"	18 7/8"	6"	6"	1 3/4"	2"	2"	40", 46"
20"	19 7/8"	22 7/8"	22 7/8"	6"	6"	1 3/4"	2"	2"	40", 46"
24"	23 7/8"	26 7/8"	26 7/8"	6"	6"	1 3/4"	2"	2"	40", 46"

* Additional sizes are available.

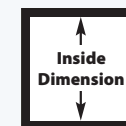

Inside Dimension



Traditional Cap Traditional Base

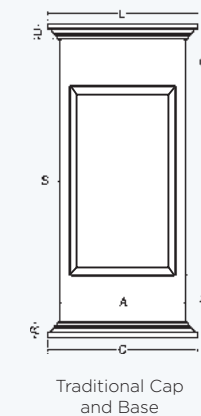

Traditional Cap and Base

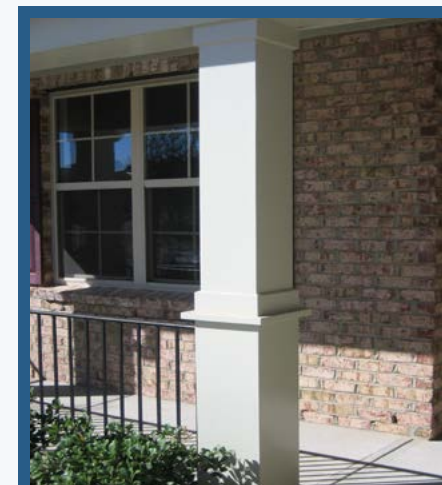

INSIDE DIMENSIONS*

12"	10 7/8"
16"	14 7/8"
20"	18 7/8"
24"	22 7/8"

*Plain

INSIDE DIMENSIONS*

12"	9 7/8"
16"	13 7/8"
20"	17 7/8"
24"	21 7/8"

*Recessed Panel



Raised Panel Pedestal Recessed Panel Pedestal

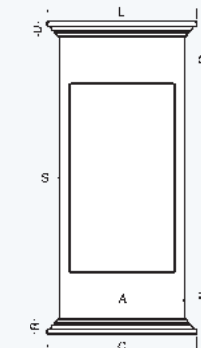

Traditional Cap and Base

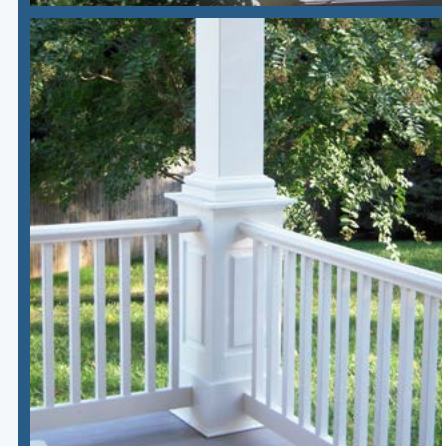

AVAILABLE SIZES*

12"	40", 46"
16"	40", 46"
20"	40", 46"
24"	40", 46"

Round Tapered Wood Columns

COLUMN DIMENSIONS WITH STANDARD CAP AND BASE (IN INCHES)

Column Size	A	B	C	D	E	F	G	J	K	L	O	N	R	T	Lengths Avail. (ft.)
6"	5 ⁵ / ₈ "	4 ³ / ₈ "	7 ¹ / ₄ "	1 ³ / ₈ "	1 ¹ / ₄ "	3 ¹ / ₈ "	1 ⁵ / ₁₆ "	1 ⁵ / ₁₆ "	1 ⁵ / ₁₆ "	7"	4 ¹ / ₂ "	8"	3 ³ / ₈ "	2"	8, 10
8"	7"	6 ¹ / ₄ "	9 ¹ / ₄ "	1 ¹ / ₂ "	1 ¹ / ₄ "	3 ³ / ₄ "	1 ⁵ / ₁₆ "	1 ¹ / ₄ "	1 ¹ / ₄ "	9 ⁷ / ₈ "	4 ¹ / ₂ "	8"	3 ¹ / ₄ "	2"	8, 10, 12
10"	9"	8 ¹ / ₄ "	11 ¹ / ₄ "	1 ¹ / ₂ "	1 ¹ / ₄ "	3 ³ / ₄ "	1 ⁵ / ₁₆ "	1 ¹ / ₄ "	1 ⁵ / ₁₆ "	10 ¹ / ₂ "	4 ¹ / ₂ "	8"	3 ¹ / ₄ "	2"	8, 10, 12
12"	11 ⁵ / ₈ "	9 ³ / ₈ "	13 ¹ / ₈ "	1 ³ / ₈ "	1 ¹ / ₄ "	7 ¹ / ₈ "	1 ⁵ / ₁₆ "	1 ³ / ₄ "	1 ³ / ₈ "	12"	4 ¹ / ₂ "	8"	3 ¹ / ₈ "	2"	8, 10, 12

Larger sizes available. Call for quote.

ROUND TAPERED WOOD INSIDE DIMENSIONS

Inside diameter may vary up to 1/4". Splitting a column will decrease inside dimension 1/8".

TOP I.D.	BOT I.D.	
6"	3"	3"
8"	4 ³ / ₄ "	4 ³ / ₄ "
10"	6 ³ / ₄ "	6 ³ / ₄ "
12"	7 ⁷ / ₈ "	7 ¹ / ₄ "

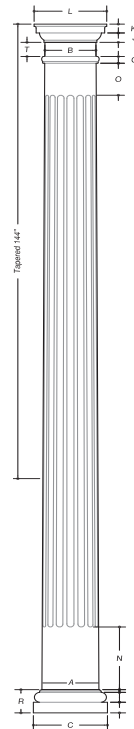

Capitals and Bases for Wood Columns

DECORATIVE CAPITAL DIMENSIONS FOR ROUND COLUMNS (IN INCHES)

Size of Column		8"	10"	12"
Roman Ionic	Height	3 ¹ / ₈ "	4"	4 ⁵ / ₈ "
	Abacus	8 ¹ / ₈ "	10 ³ / ₄ "	12 ¹ / ₂ "
	Projection	3 ³ / ₈ "	4 ¹ / ₈ "	5"
	O/S to O/S	10 ¹ / ₂ "	13 ³ / ₈ "	16 ¹ / ₂ "
Greek Ionic	Height	4 ¹ / ₈ "	5 ⁵ / ₈ "	6 ³ / ₈ "
	Abacus	7 ¹ / ₄ "	10 ¹ / ₁₆ "	14 ³ / ₈ "
	Projection	3 ⁵ / ₈ "	5"	7 ¹ / ₂ "
	O/S to O/S	11 ⁷ / ₈ "	14 ¹ / ₁₆ "	20 ¹ / ₁₆ "
Temple of the Winds	Height	8"	10 ³ / ₁₆ "	11 ⁵ / ₈ "
	Abacus	11 ¹ / ₈ "	13 ³ / ₁₆ "	16 ³ / ₁₆ "
	Projection	5 ¹ / ₂ "	6"	7"
	O/S to O/S	11 ⁷ / ₈ "	13 ³ / ₁₆ "	16 ³ / ₁₆ "
Roman Corinthian	Height	8 ¹ / ₁₆ "	11 ¹ / ₁₆ "	14 ⁵ / ₈ "
	Abacus	12 ¹ / ₁₆ "	14 ³ / ₈ "	18 ⁷ / ₈ "
	Projection	4 ¹ / ₄ "	6 ¹ / ₄ "	8 ¹ / ₄ "
	O/S to O/S	12 ¹ / ₁₆ "	14 ⁵ / ₈ "	18 ⁷ / ₈ "
Scamozzi	Height	3 ¹ / ₈ "	4 ¹ / ₈ "	5 ¹ / ₈ "
	Abacus	9 ⁷ / ₈ "	14 ¹ / ₄ "	16 ⁵ / ₈ "
	Projection	3 ³ / ₈ "	5 ³ / ₈ "	6"
	O/S to O/S	10"	14 ¹ / ₄ "	16 ⁵ / ₈ "

• 8"-12" Round Decorative Capitals are load bearing.

8" - 12" Load Bearing Decorative Capitals for ROUND Wood Columns

Adding a load bearing decorative capital to a round wood column will lengthen or shorten the overall height of the column depending on the height of the capital. Subtract the "T" dimension (from the column dimensions chart) and add the height of the decorative capital +/- 1/4" for overall column height.

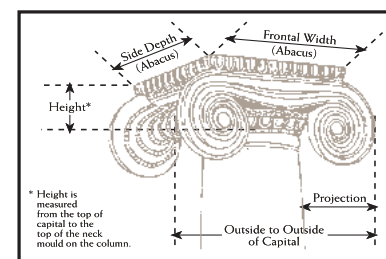
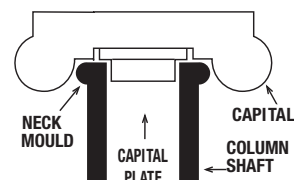

Capitals and bases for wood columns are load bearing. The shaft fits between the capital and base and alters the height of the shaft. Several options are offered for wood columns.

Decorative Capitals

Five styles of decorative capitals are available. Nothing makes a statement like wood columns with a decorative capital. 8"-12" decorative capitals for Round wood columns are load bearing. Using a decorative capital with a wood shaft will alter the height of the shaft.

Attic Base

Attic bases are used for a more ornate look and comes in two pieces. (In the chart, see DD for the plinth dimension and EE for the torus dimension).

Capital and Base Options

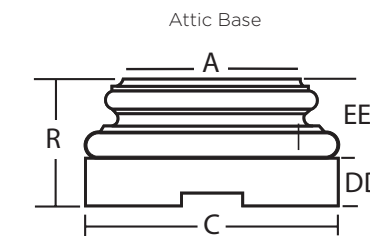

For columns 8" to 12" in diameter, bases, including plinth, are Polyurethane.

Column Size	Bottom DIA. (NET)	Round Base			
		A	C	DD	EE
8"	8 ¹ / ₈ "	10 ¹ / ₄ "	1 ⁷ / ₈ "	1 ⁷ / ₈ "	5 ¹ / ₈ "
10"	9 ⁵ / ₈ "	13"	2 ¹ / ₂ "	2 ¹ / ₂ "	6 ¹ / ₂ "
12"	11 ⁵ / ₈ "	16"	3"	3"	7 ¹ / ₂ "

Standard Poly Cap

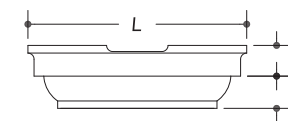

Standard Poly Base

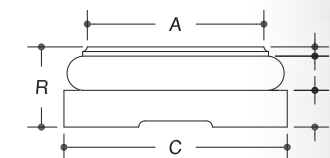

STANDARD POLY CAP DIMENSIONS

Size	J	K	L
6"	1 ⁵ / ₁₆ "	1 ⁵ / ₁₆ "	7"
18"	1 ¹ / ₄ "	1 ¹ / ₄ "	8 ⁷ / ₈ "
10"	1 ¹ / ₄ "	1 ⁵ / ₁₆ "	10 ¹ / ₂ "
12"	1 ³ / ₄ "	1 ³ / ₈ "	12"

STANDARD POLY BASE DIMENSIONS

Size	A	C	D	E	F	R
6"	5 ⁵ / ₈ "	7 ¹ / ₄ "	1 ³ / ₈ "	1 ¹ / ₄ "	9 ¹ / ₁₆ "	3 ³ / ₁₆ "
18"	7"	9 ¹ / ₄ "	1 ¹ / ₂ "	1 ¹ / ₄ "	3 ¹ / ₄ "	3 ¹ / ₄ "
10"	9"	11 ¹ / ₄ "	1 ¹ / ₂ "	1 ¹ / ₄ "	3 ¹ / ₄ "	3 ¹ / ₄ "
12"	11 ⁵ / ₈ "	13 ¹ / ₈ "	1 ³ / ₈ "	1 ¹ / ₄ "	7 ¹ / ₈ "	3 ¹ / ₈ "

CUSTOM SPLITTING OPTIONS



What You Need To Know

The height of a column includes capital and base (Ex. 8' = shaft 7', 6¹/₂" and capital and base total 8').

- Cap and base fit on top and bottom of column insulating the column from the elements.
- Split columns are not load bearing.
- Store columns in a dry, well-ventilated area.
- For exterior applications: Paint inside of column shaft with a nonfibrous asphaltum type roof coating. Application must reach minimum 48" up the inside bottom of the column shaft and must be painted.
- Wood columns require ventilation at the top and bottom.
- Failure to adhere to installation instructions voids the warranty.

The PermaPost® Collection

- Weather Proof.
 - Insect Proof.
 - Load Bearing.
 - Low Maintenance.
 - Pre-finished White.
 - Ready to Install.
 - 25 Year Limited Warranty.*
- *See Warranty

Chamfered PermaPost®.

The Square PermaPost® is made from low maintenance PVC and is pre-finished with a white capstock. HB&G's Colonial and Chamfered PermaPost® are made from a low maintenance polyethylene and are pre-finished white and should

not be painted. For a warm and inviting decorative look for your front porch, choose from either the 5" or 6" Colonial PermaPost®, the 5" Square PermaPost®, or the 6" Chamfered PermaPost®.

PermaPost® Perma Lamp Posts

- 5" or 6" Colonial PermaPost®
- 5" Square PermaPost®
- 6" Chamfered PermaPost®
- Colonial Lamp Post
- Chamfered Lamp Post

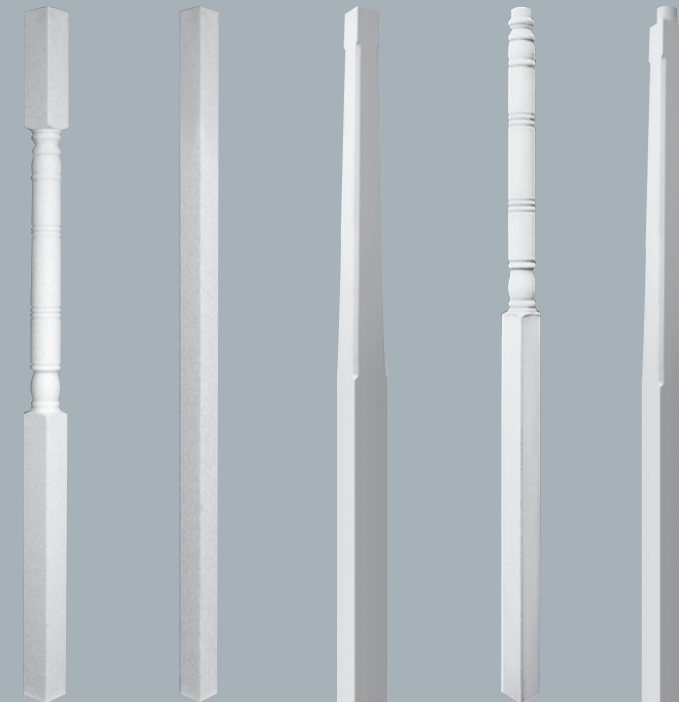

The Perma Lamp Post is an attractive way to light a drive or garden area. The pipe in the center is designed to allow a wire to be easily installed. The 2 7/8" pipe fits most outdoor lamp fixtures.

Post Size	Width	Turned Area	Base Height	Length (in feet)	Top Portion (Square Top)
Colonial Posts					
5" x 5"	4"	38 1/2"	41 1/2"	8"	16 1/4"
5" x 5"	4"	38 1/2"	45 1/4"	9"	24 1/2"
6" x 6"	5"	38 1/2"	41 1/2"	8"	16 1/4"
6" x 6"	5"	38 1/2"	45 1/4"	9"	24 1/2"
Square Posts					
5" x 5"	4 1/4"	N/A	N/A	8"	N/A
5" x 5"	4 1/4"	N/A	N/A	9"	N/A
5" x 5"	4 1/4"	N/A	N/A	10"	N/A
Chamfered Post					
6" x 6"	3 1/2" & 5 1/2"	N/A	46 1/4"	8"	4 1/2"
Colonial Lamp Post					
6" x 6"	3 1/2" & 5 1/2"	38"	51"	7 6/8"	N/A
Chamfered Lamp Post					
6" x 6"	3 1/2" & 5 1/2"	N/A	46 1/4"	8"	4 1/2"

Measurements in inches unless otherwise noted. There may be a variance of up to 1/4" in all dimensions.
*Loadbearing capacity is dependent on the concentric loading of the post.
Note: All sizes are nominal.

Colonial Post Two (2) post fasteners are shipped with each Colonial post.

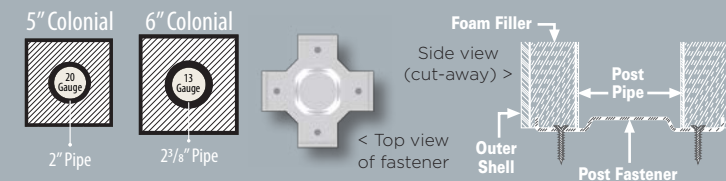

Square Post

Two (2) post fasteners are shipped with each Colonial post.

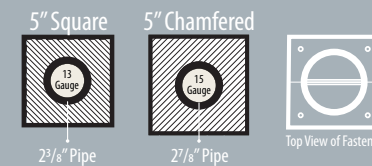

Optional Synthetic Post Fastening Kits

Each kit comes complete with skirt, brackets, and TapCon screws for wood or concrete substrates. Available for all Synthetic Post styles.

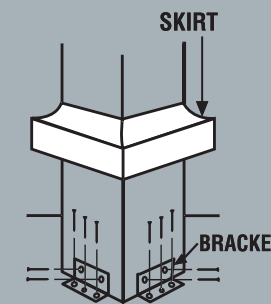

Porch-Loc®

- Adds wind uplift resistance.
- Porch-Loc® secures structural Colonial and Square PermaPost® to floor and beam/header.
- Easy installation.
- Durable skirts included.

Wind Uplift Resistant Installation Brackets

Size	Dimension
5" Colonial	4"
6" Colonial	5"
5" Square	4 1/4"

Skirts and hardware included

Porch-Loc® Installation Kit

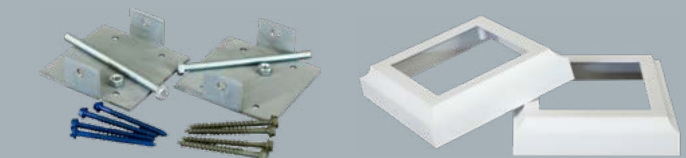

Description

Dimensions are nominal and may vary slightly.

- 5" Colonial PermaPosts and Perma Lamp Posts are net 4".
- 6" Colonial PermaPosts are net 5".
- Chamfered PermaPosts and Perma Lamp Posts are net 3½" (top) and 5½" (bottom).
- Square posts are net 4¼".
- Perma Lamp Posts can accommodate most outdoor lamp fixtures.

Fastening Systems

Colonial Post

Two (2) Post Fasteners are shipped with each colonial post.

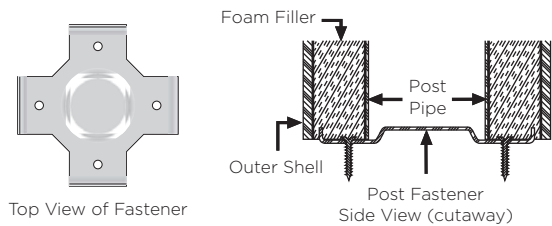

Square Post

Two (2) Post Fasteners are shipped inside each post.

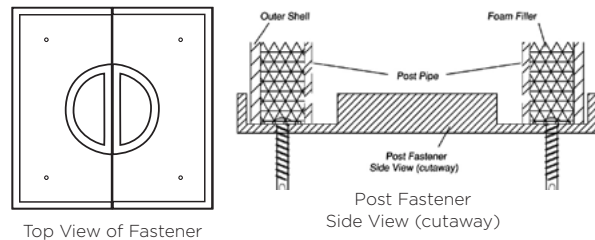

The HB&G PermaRail Plus® Collection

- Available in kits, components, and ready to install pre-built sections.
- Prefinished; no painting required.
- Compliant with IBC up to 10' and IRC up to 12' (CCRR-0262).
- Newel sleeve fits over a pressure treated 4 x 4 or newel support.
- Durable, low maintenance.
- Concealed hardware.
- Adjustable stair rail brackets.**
- Insect and weather proof.
- 10/25 Year Limited Warranty*.
- Rail Heights 36" and 42".
- Rail Lengths 6, 8, 10, and 12'.
- 1-1/4", and 1-1/2" Square, and Turned Balusters.

Savannah PermaRail Plus® Railing with Custom Decorative Panel

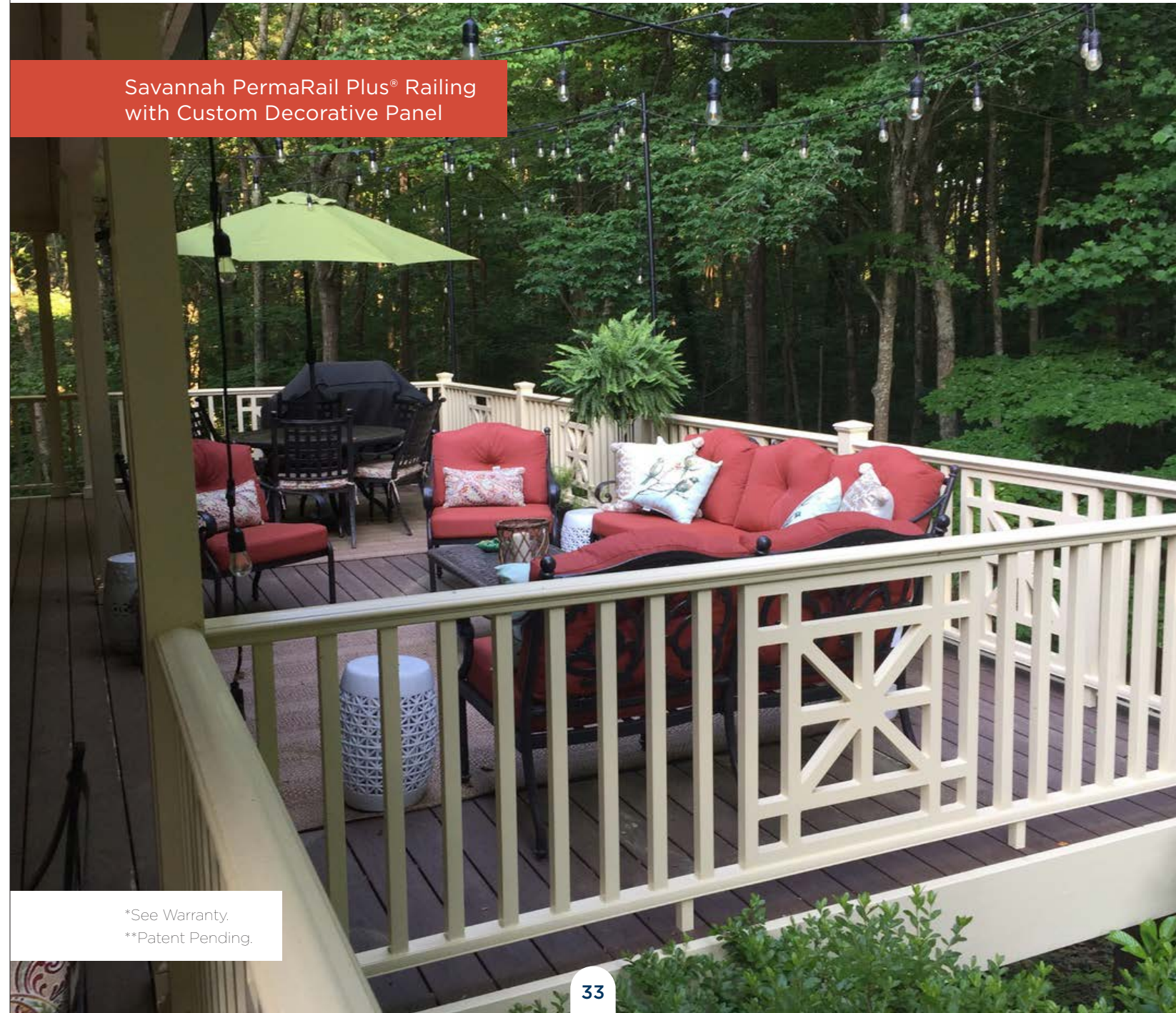

WOOD PORCH POSTS

Number 100 Turned Wood Post*

Our No. 100 turned wood posts are available in 4", 5", and 6" nominal sizes.

(Cross sections are 3¼", 4¼", and 5¼" net size.)

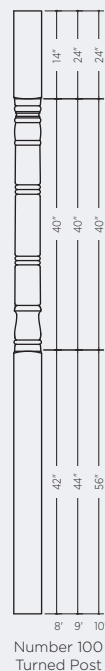

*Plinths should always be used with wood posts.

Aluminum Plinth for Wood Post

Wood posts must be installed with aluminum plinths or quick mount bracket to comply with warranty.

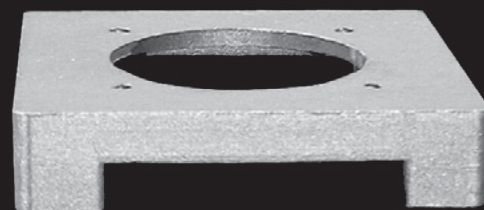

*See Warranty.
**Patent Pending.

The PermaRail Plus® railing system is a beautiful way to tie your whole porch look together. It is made up of several different components, allowing you the ability to create the designs that match your way of life.

Easy to install, this worry-free railing system will be a beautiful, low maintenance addition to your porch or deck for generations to come.

Savannah



Standard

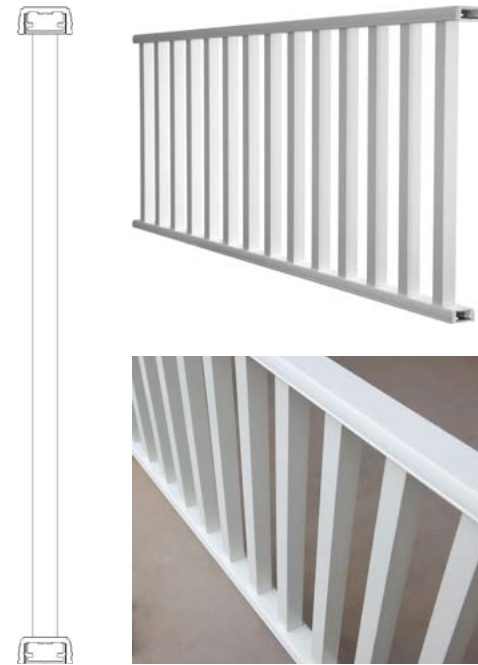

Belhaven



Newport



All rail sections are suitable for use with PermaCast®Plus columns, PermaRail Plus® newels, or PermaPost®.

*HB&G recommends checking all applicable building code requirements before the design and installation of PermaRail Plus®.

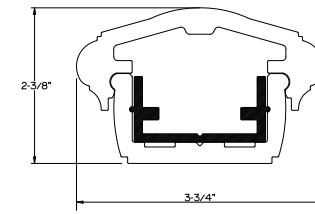

Savannah Top Rail.*

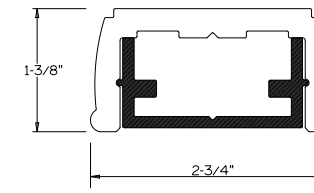

Standard Top Rail** and Standard Bottom Rail with Aluminum Stiffener. **Maximum 8' Length.

*With Aluminum Stiffener and Standard Bottom Rail.



Supplemental Aluminum Stiffener for Savannah, Newport, and Bellhaven for Rail Lengths over 8'.



Standard Aluminum Stiffener.

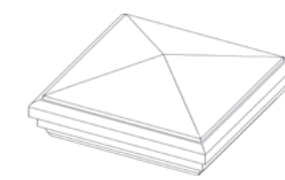

Newel Cap.

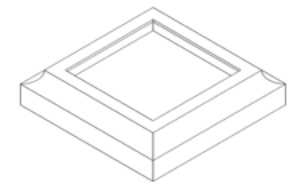

Newel Skirt.

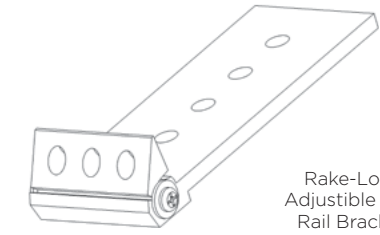

Rake-Loc™ Adjustable Stair Rail Bracket.

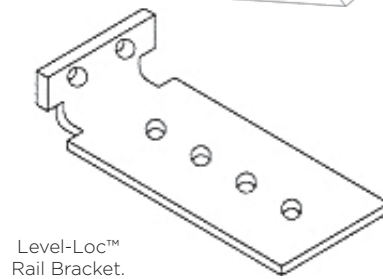

Level-Loc™ Rail Bracket.

Chesterfield Newel Support Kit



Chesterfield Newel

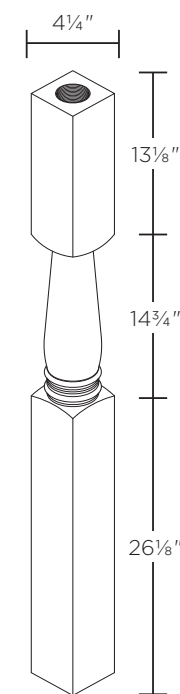

Newel-Loc™ Square Newel Post Mount System*

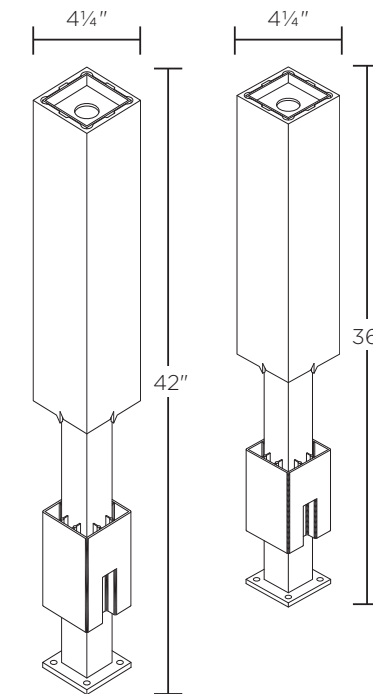

1-1/4" Square Baluster 30" and 36"



1-1/2" Square Baluster 30" and 36"



1-1/2" Turned Baluster 30" and 36"



Newel Sleeve 45" and 54"***

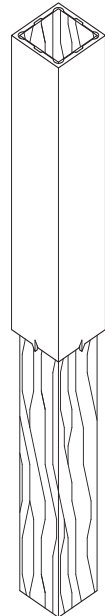

**Newel sleeves can be slid over an existing 4 x 4 or installed with the Newel Post Mount.

The top rail, bottom rail, and balusters are pre-finished white and are made from weather resistant cellular PVC. Turned Balusters are made from hollow rigid vinyl and cannot be painted.

*The 36" and 42" Newel Post Mount are designed for coastal conditions. NOTE: Newel-Loc™ and Newel Sleeve must be purchased separately.

Three Ways to Order the PermaRail Plus® Railing...

1. Do-it-yourself Kit

Everything needed to assemble and install is included.

- All standard level rail section components included in one box.
- Balusters and all installation hardware included.
- Decorative top rail and Rake-Loc™ stair bracket sold separately.
- How to Order:
- Choose Your Height: 36" 42"
- Choose your Length: 6', 8', 10', 12' 6', 8', 10'
- Choose Decorative Top Rail: Savannah.
- Note: Standard Rail System has a maximum length of 8'.
- Optional concealed adjustable stair rail brackets for 6' and 8' rail lengths.
- Kit Includes:
- Standard top and bottom rail.
- 1 ¼ balusters.
- Support block(s).
- Aluminum stiffeners.
- Level-Loc™ rail assembly fasteners and installation hardware.

2. Individual Components

- Build your Own Design.
- For complete rail system you will need the following:
- Note: Standard Rail System has a maximum length of 8'.
- Standard top and bottom rail.
- Decorative top rail (if not using the Standard Top Rail*).
- Aluminum stiffeners (2) - Supplemental stiffener for rail lengths over 8'.
- Square Balusters, 1 ¼ or 1 ½" Turned Balusters - 30" or 36" long.
- Support block(s).
- Level-Loc™ rail hardware kit.
- Baluster screw kit.

3. Pre-Built Sections

- Shipped factory assembled in standard lengths.
- Easy to install.
- Everything needed to install included.

• How to Order:

- Choose Your Height: 36" 42"
- Choose your Length: 6', 8', 10', 12' 6', 8', 10'
- Choose Decorative Top Rail: Savannah.
- Note: Standard Rail System has a maximum length of 8'.
- Optional Concealed Adjustable Rake-Loc™ stair rail brackets for 6' and 8' rail lengths.
- Onsite trimming and assembly completion required.

*HB&G recommends checking all building codes before the design and installation of your PermaRail Plus® railing.

Building Code Compliance

PermaRail Plus® has been tested to the appropriate standards and found to be build code compliant (CCRR-0262) as follows:

Decorative Top Rail System		Standard Top Rail System	
Level	Rake	Level	Rake
IRC	up to 12' up to 8'	IRC	up to 8' up to 8'
IBC	up to 10' up to 8'	IBC	up to 8' up to 8'

Review your application to ensure intended use complies with all applicable building codes.

Typical Assemblies

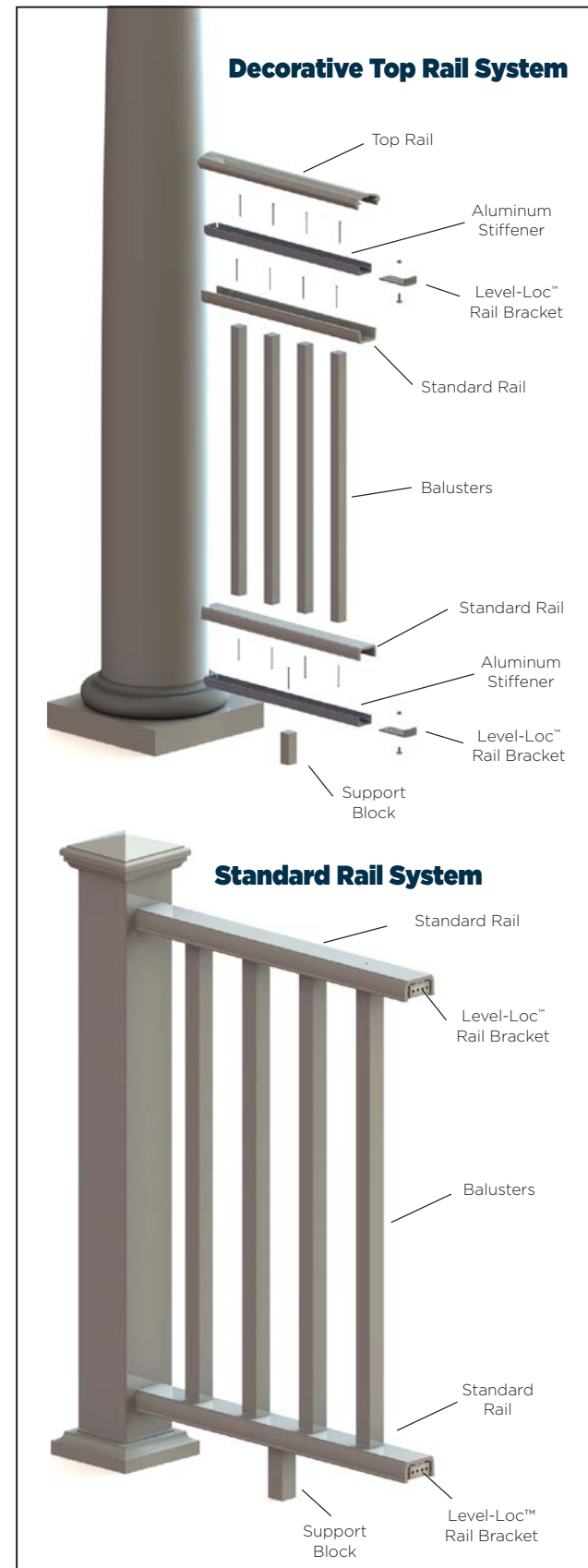

- Low Maintenance.
- Primed White.**
- Ready to Install and Paint.
- Easy Installation.
- 25 Year Limited Warranty.*



12" Round PermaCast® Plus Columns with Tuscan Cap and Base and 7" Balustrade System.

We have created a unique and elegant balustrade system that can make your home stand out from the rest. These low-maintenance features are made by molding high-density urethane around structural

elements in order to provide exceptional beauty, durability, and quality. Choose from three rail sizes and several baluster profiles. Curved balustrade systems are available in 10' sections.

*See Warranty.

**Additional priming may be required.

6" Balustrade System

7" Balustrade System

Sherwood

Square

Saffron

Shannon

Shelby

Panel Nwells and Corner Nwells

Poly moulding provided loose to be installed on job site. See page 9 for panel moulding styles.

Cap and Support

Rails

Calvert

Carrington

Panel Nwells and Corner Nwells

Poly moulding provided loose to be installed on job site. See page 9 for panel moulding styles.

Cap and Support

Rails

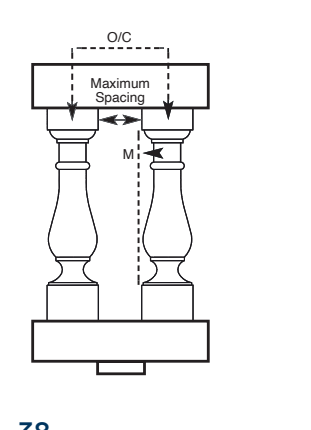
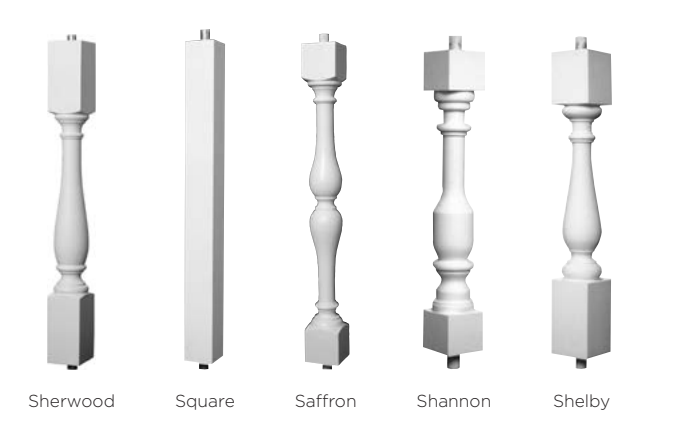

6"				
SKU	M	Maximum Spacing	O/C	
58031	3/4"	2 1/4"	5 1/4"	
58032	3/4"	2 1/4"	5 1/4"	
58036	3/4"	2 1/4"	5 1/4"	
58033	1"	2 1/8"	5 1/2"	
58034	1"	2 1/8"	5 1/2"	
58035	1"	2 1/8"	5 1/2"	
58037	1"	2"	5 1/2"	
58038	1"	2"	5 1/2"	
58029	0"	4"	7"	
58030	0"	4"	7"	
58061	1 1/16"	1 3/4"	5 1/4"	
58062	1 1/16"	1 3/4"	5 1/4"	
58063	1 1/16"	1 3/4"	5 1/4"	

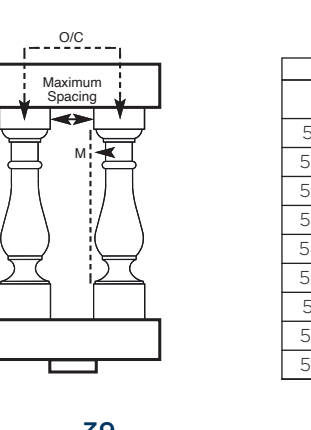
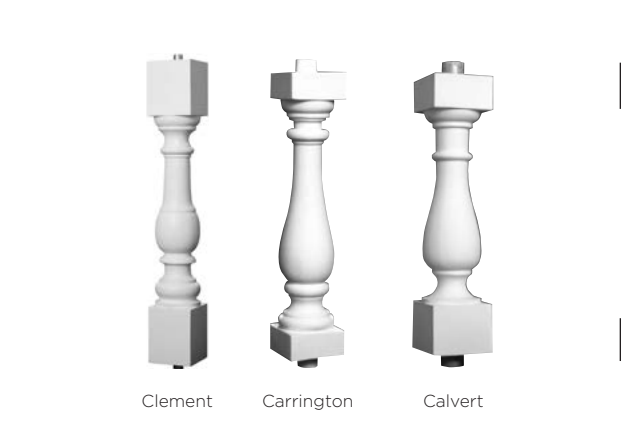

7"				
SKU	M	Maximum Spacing	O/C	
58041	1 1/4"	1 1/4"	6 1/2"	
58042	1 1/4"	1 1/4"	6 1/2"	
58045	1 1/4"	1 1/4"	6 1/2"	
58043	1 1/2"	3/4"	6"	
58044	1 1/2"	3/4"	6"	
58046	1 1/2"	3/4"	6"	
58091	1 5/16"	1 3/8"	6 5/8"	
58092	1 5/16"	1 3/8"	6 5/8"	
58093	1 5/16"	1 3/8"	6 5/8"	

12" Balustrade System

Mandeville

Manasses

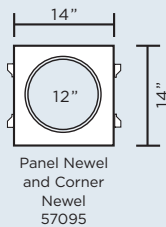
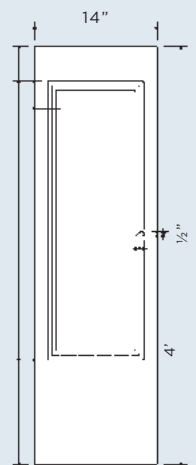
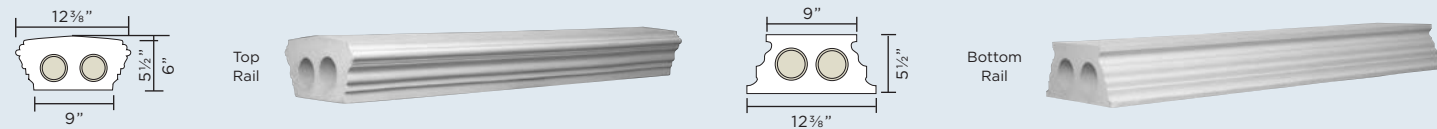
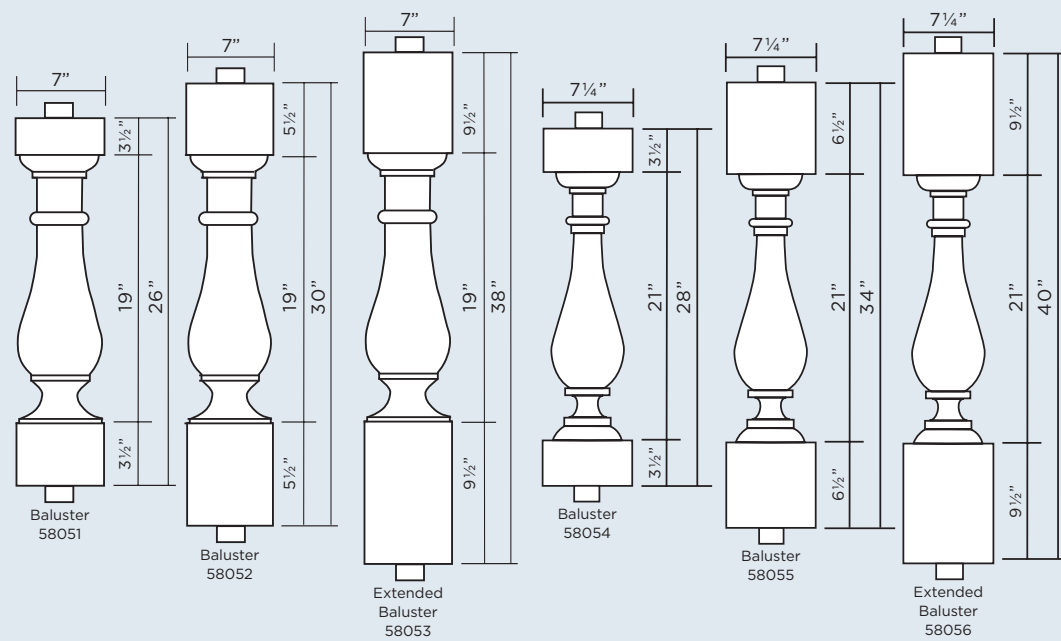

Plain Newel #57094

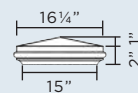

Pyramid Cap #57091

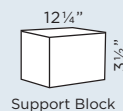

Support Block

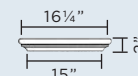

Flat Cap #57092



Ball Cap*
7" 63058
10" 57096
12" 57093
*Must be used with Flat Cap

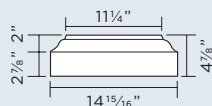

Classic Cap #57097

Poly moulding provided loose to be installed on job site. See page 9 for panel moulding styles.



Mandeville Manasses

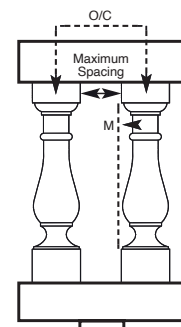

12"			
SKU	M	Maximum Spacing	O/C
58051	1 1/8"	3/16"	7 1/8"
58052	1 1/8"	3/16"	7 1/8"
58053	1 1/8"	3/16"	7 1/8"
58054	2 3/8"	0"	7 1/4"
58055	2 3/8"	0"	7 1/4"
58056	2 3/8"	0"	7 1/4"

Curved Balustrade System

- 6" and 7" Rail Styles.
- Low Maintenance.
- Primed White.
- Ready to install and paint.
- Easy Installation.
- 25 Year Warranty.*
- Available in 60"-108" radius.

HB&G Curved Balustrade System will add an elegant finishing touch to any house. Each top and bottom rail style is available in radius from 60" to 108" in 10' lengths. (See pages 38-40 for rail styles).



*See Warranty.

Must purchase balusters and newels separately.

Building Codes

HB&G recommends checking all local, state, and national building codes before the design and installation of your balustrade system.

HB&G is not responsible or liable for any balustrade system that does not meet the requirements of the governing building code in the location where the system is installed.

The space between the bottom rail and the substrate should not be less than 2".

Typical Assembly

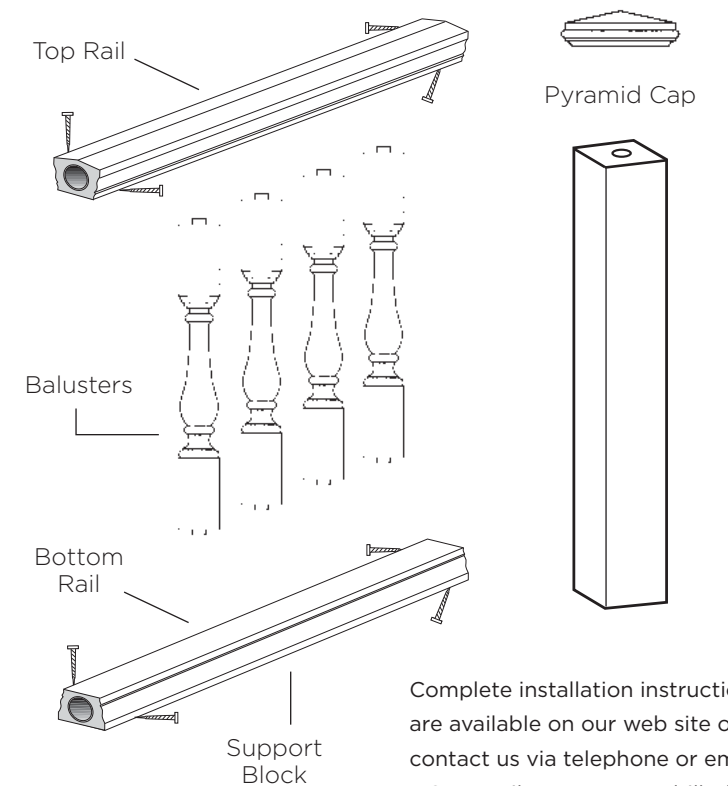

Complete installation instructions are available on our web site or contact us via telephone or email. NOTE: Rails are not pre-drilled.

Fiberglass Pergolas

- Wind load rated.
- Low maintenance.
- Ease of installation.
- Pre-finished with Benjamin Moore Command engineered coating
- Will not rot, check or twist.
- Hollow rafter can act as conduit for wiring.
- Stability.



Serenity® Series Fiberglass Pergolas

HB&G manufactures fiberglass pergola kits using pultrusion technology to produce the strongest yet lightest structures available with a Limited Lifetime Warranty. Our structural fiberglass components are strong, light weight, and provide a higher level of aesthetic quality than vinyl or wood pergolas. Our Serenity® pergola kits are manufactured white with Napa Tails and square or plain round tapered PermaCast columns without neck moulding. Optional wind-load/deck plates are available.

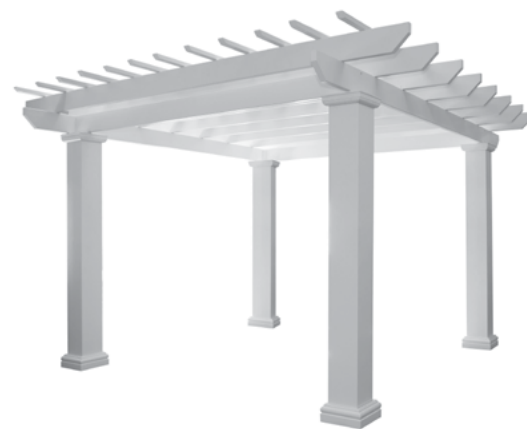

PERMALITE® NO-TAPER ROUND COLUMN PERGOLA KITS		
Overhead Size	Column Center Size	Column Size
Free Standing 12' x 12'	8' x 8'	8" x 8'
Free Standing 14' x 14'	10' x 10'	10" x 8'
Free Standing 16' x 16'	12' x 12'	10" x 8'
Standard Round Wind-Load/Deck Plate - 8"		
Standard Round Wind-Load/Deck Plate - 10"		
*Sold Separately, Deck Screws not included		

PERMALITE® SQUARE COLUMN PERGOLA KITS		
Overhead Size	Column Center Size	Column Size
Free Standing 12' x 12'	8' x 8'	8" x 8'
Free Standing 14' x 14'	10' x 10'	10" x 8'
Free Standing 16' x 16'	12' x 12'	10" x 8'
Standard Round Wind-Load/Deck Plate - 8"		
Standard Round Wind-Load/Deck Plate - 10"		
*Sold Separately, Deck Screws not included		

NOTE: Shade canopies sold separately
Serenity® fiberglass pergolas are single support rafter with header style.

Semi-Custom Options*

Make our Serenity® or Tranquility® pergolas your own by selecting from our semi-custom options.

Rafter Tail Options

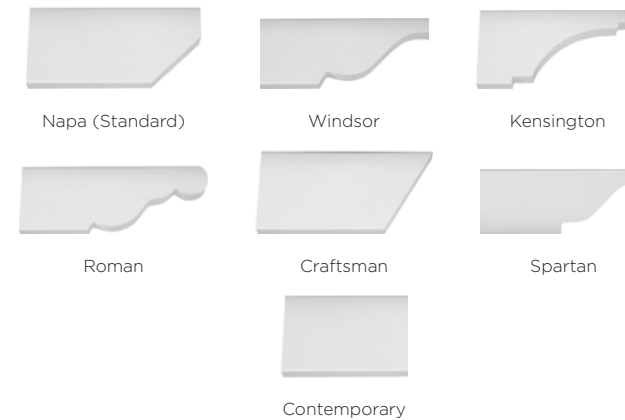

Color Options



*Adds a week to shipping time.

* Color may differ due to print settings. Call for more information.

Tranquility® Series Predesigned Fiberglass Pergolas

Available with choice of 10"x8' PermaCast® Round Tapered or 10"x8' PermaLite® Square Columns, prefinished with a White Benjamin Moore Command engineered coating, our exclusive Arbor-Loc® tie-down system, and Napa rafter tail.



FREESTANDING PERGOLA
OVERHEAD DIMENSIONS

12' x 12'	14' x 18'	18' x 12'	20' x 18'
12' x 14'	14' x 20'	18' x 14'	20' x 20'
12' x 16'	14' x 22'	18' x 16'	20' x 22'
12' x 18'	16' x 12'	18' x 18'	22' x 12'
12' x 22'	16' x 14'	18' x 22'	22' x 14'
14' x 12'	16' x 16'	20' x 12'	22' x 16'
14' x 14'	16' x 18'	20' x 14'	22' x 18'
14' x 16'	16' x 22'	20' x 16'	22' x 22'



ATTACHED PERGOLA
OVERHEAD DIMENSIONS

12' x 10'	14' x 14'	18' x 10'	20' x 16'
12' x 12'	14' x 16'	18' x 12'	20' x 18'
12' x 14'	14' x 20'	18' x 14'	20' x 20'
12' x 16'	16' x 10'	18' x 16'	22' x 10'
12' x 18'	16' x 12'	18' x 20'	22' x 12'
12' x 20'	16' x 14'	20' x 10'	22' x 14'
14' x 10'	16' x 16'	20' x 12'	22' x 16'
14' x 12'	16' x 20'	20' x 14'	22' x 20'

NOTE: Tranquility® predesigned fiberglass pergolas are double support rafter, no header style.

Custom Solace® Series Fiberglass Pergolas



Understanding Pergola Dimensions

Freestanding Pergolas

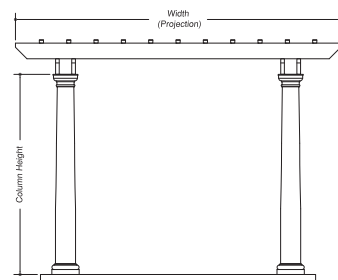
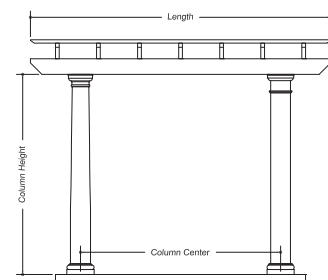

Front View
Beam / Structural rafters run the length of the pergola.

Side View
Rafters run the width (Projection) of the pergola.

Attached Pergolas

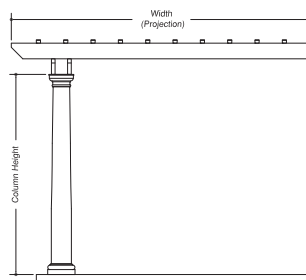
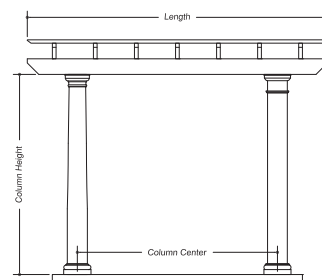

Front View
Ledger runs length of pergola.

Side View
Width (Projection) of the pergola top projects from the structure.

NOTE: Pergola sizes are described as length x width as shown in the examples above.

Canopy options for Structural Fiberglass Pergolas

HB&G offers two ways to increase the shade provided by your pergola: canopies and purlins. Each option is specifically designed to be an attractive accent to your pergola and create a shelter from the sun's rays.

The combination of an HB&G pergola and shade solution is the ultimate combination of beauty, function, and versatility to create your outdoor living room.

Solid color Canopies

Designed for ease of use, our exclusive canopy slides on a wired system that is ready to install out of the box. The unique modular design is easy to install, just like our fiberglass pergolas, to enhance your outdoor living experience. Designed to quickly lock individual canopy panels in place to provide shelter from the sun or remove panels as quickly when the sun goes down.



Canopy Solid Colors

**Color may differ slightly due to print settings.

Tweed, Silica, and Crest are available at a 20% upcharge. Please call for more information.



Oyster
721776



Beige
721790

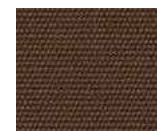

True Brown
721759



Marine Blue
721812



Ocean Blue
721813

Custom Purlins

Increase the number of purlin on the top of the pergola or change profiles to increase the amount of shade provided.

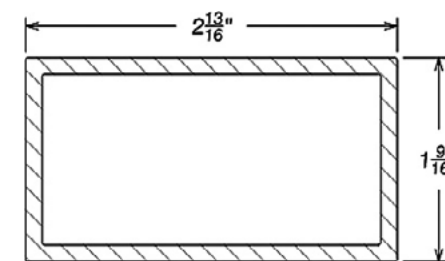



Outdoor Living Products

HB&G manufactures its outdoor living products with the same materials used in our high performance Fiberglass Pergolas. They are low maintenance, easy to install, and will not rot, check, or twist.

PRIVACY SCREENS

Add outdoor privacy with HB&G's Privacy Screens. Perfect for pool or dining areas or multi-family applications. Two standard sizes are available with Napa tails.

Size	Column
12' Privacy Screen	10" x 8' Square PermaLite®



ENTRY ARBOR

Formalize an entrance or dress up a garden area with HB&G's Entry Arbors. Two standard sizes are available.

Size	Column Center	Column
12' x 3' Arbor	8'	8" x 8' PermaCast® Round
12' x 3' Arbor	8'	8" x 8' PermaLite® Square

EYEBROW / TRELLIS

Designed to complement the architecture of your home. HB&G's Eyebrow/Trellises are available in three standard sizes with Napa tails.

Length		
11' Eyebrow	18' Eyebrow	20' Eyebrow



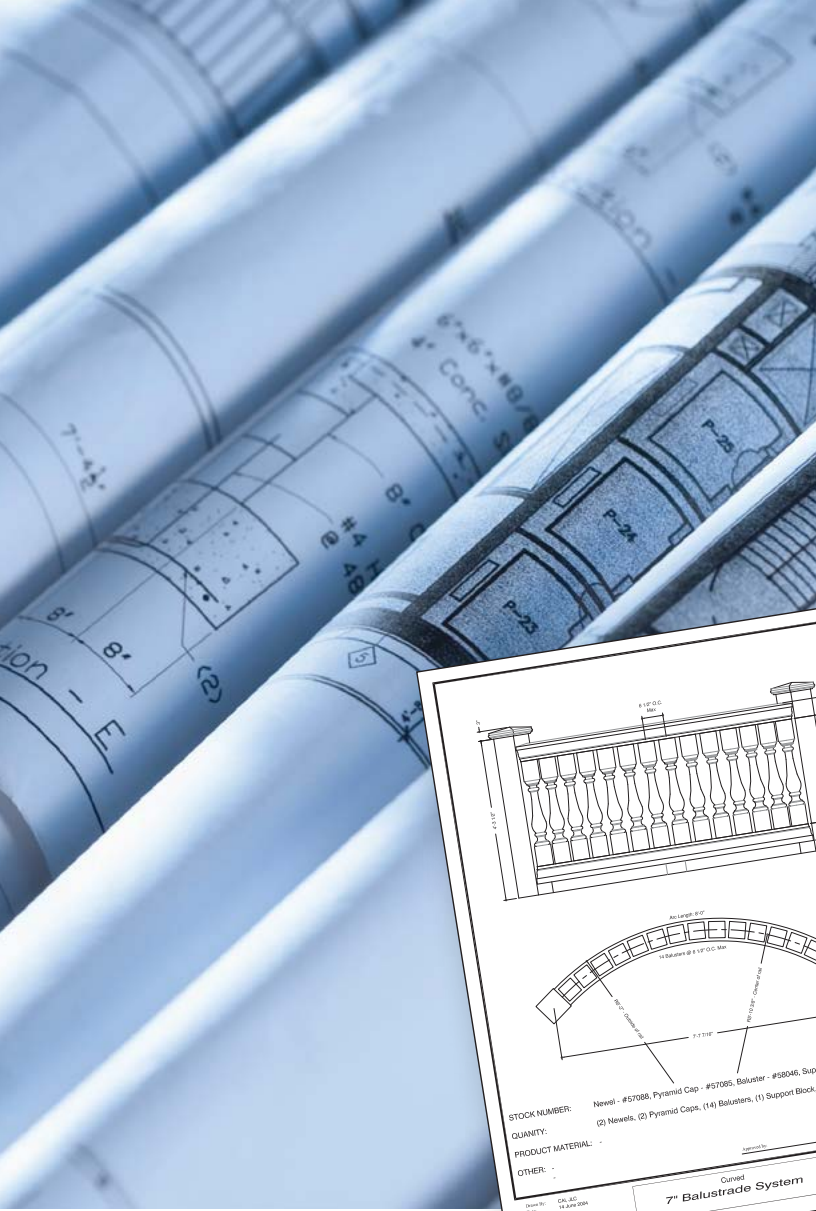

Drop Off For Take Off!

HB&G's program to help you with your take offs!

- Send your plans using one of these two methods:
 - Email your plans to hbgtakeoffs@hbgcompanies.com
 - Mail your plans to 1015 Brundige Blvd. Troy, AL 36081 Attn: Architectural Dept.
- Once we have your plans, we will provide a detailed product list and drawings for your project.

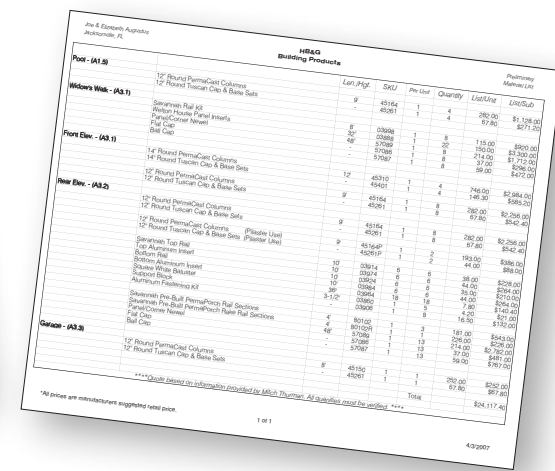
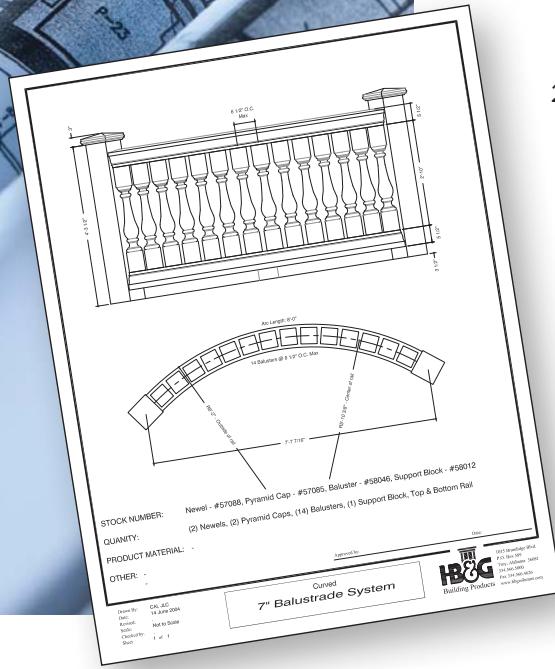

HB&G Continuing Education Course

HB&G offers a one hour continuing education course. This course can be conducted in person as a "lunch and learn" or taken online via our website. This course is AIA and AIBD certified.



Application Pros and Cons

Installation Time

Market Trends

New Urbanism Neighborhoods



HB&G Building Products Inc. Limited Product Warranties

Your Home or Commercial space says a lot about you, our Best-in-the-Industry Warranty says a lot about us!

HB&G Building Products Inc. warrants to the purchasers of our products to be free from defects in craftsmanship and materials as spelled out below:

Our Limited Product Warranty Terms:

- Warranties are exclusive to the person(s) who own and reside in the home the product is installed.
- Warranties also apply to the Homeowner who purchases a newly constructed residence on which the Product is installed directly from the builder.
- Warranties are not transferable.
- These Warranties are only applicable in the United States and Canada.

Our Warranty Claim Process:

- With photos and proof of purchase, claims are to be emailed to warranty@hbgcompanies.com.
- If HB&G determines, at its sole discretion, that a product has a manufacturing defect, the repair or replacement of those materials will be the sole remedies.

Limited Time Warranty Periods by Product:

Products	Single Family Residential	Multi Family Commercial
<ul style="list-style-type: none"> PermaCast®, PermaCast®Plus or PermaLite® SmartColumn® Columns, RoughSawn®. Fiberglass Pergola & Outdoor Living Products. 	Limited Lifetime	25 Years
<ul style="list-style-type: none"> PermaWrap® & PermaSnap™ Columns. PermaPost®, PermaRailPlus® & Balustrade/Railing/Ceilings. 	25 Years	10 Years
<ul style="list-style-type: none"> Polyurethane Brackets/Medallions. 	10 Years	10 Years
<ul style="list-style-type: none"> Mor-Shade® Canopy & Sail. 	5 Years	1 Year
<ul style="list-style-type: none"> Wood Columns. 	1 Year	1 Year

Our Limited Product Warranty Terms:

- Our products, when used under the conditions of normal use and are properly installed and maintained in conformance with all of HB&G installation instructions (see QR Code below) as well as all governing building codes.
- HB&G factory-finished products (Pergolas, PermaPost® and Railing) will be free of defects (will not peel, chip or crack) for a period of one year in normal use and are properly installed and maintained in conformance with HB&G installation instructions. This includes Normal weathering such as exposure to sunlight which may cause any finished surface to gradually fade, chalk or accumulate dirt, and/or other Acts of God.



HB&G installation instructions are on our website and are updated as needed, scan the QR code on the left to review the most current versions.

Limitations and conditions not covered:

- Non factory-applied finishes are not covered under this warranty. For claims original purchasers must look to the warranty of the paint or coating manufacturer for recourse.
- Defects in the foundation, wall or ceiling structure on which HB&G products are installed, which cause failure.
- Installation, delivery and labor costs are NOT covered under this warranty.
- HB&G does not warrant split columns sold direct or by distributors, builders, retailers, suppliers or anyone.



HB&G products are proudly made in Alabama.

Version: 112024A

A photograph of a porch with a wooden ceiling, white columns, and wicker furniture. The porch is covered with a dark wood deck. The ceiling is made of horizontal wooden planks. The columns are white with decorative capitals. The furniture consists of two wicker chairs with pink cushions and a matching wicker ottoman. The porch is attached to a house with white siding and a window with a green frame. The background shows a garden with pink flowers and a white fence.

MAKE A LASTING IMPRESSION.

HB&G products can be purchased from:

**RIVER CITY
MILLWORK**

815-965-9439 | www.rivercitymillwork.com