



Natural wood
Made to last

Product Guide



Sustainable Wood for Long Lasting Projects

Content

Decking	04
Kebony Deck Board	06
Boardwalk Decking	08
Cladding	10
Passive Rainscreen System	13
Kebony Clear Cladding	14
Kebony Character Cladding	16
Site Furnishings	18
Millwork	20
Design vs. Build	26
About Kebony	28
The Modification Process	32
Performance	34
Kebony vs. Ipé	36
Kebony vs. Thermally-Modified	38
How to Buy	42

Decking

Sourced from FSC®-Certified forests, our Kebony® Clear decking is engineered to handle the harshest of conditions. The rich brown color and clear grain are designed to impress, while hardwood-like durability and a 30-year warranty provide supreme peace of mind. Whether you maintain the original color or let Kebony Clear naturally patina, your project will amaze for decades to come.

Decking Products

- Kebony Deck Board
- Boardwalk Decking

Learn more at www.Kebony.us



ZILKER DECK

Austin, TX

Product: Kebony Deck Board with Step-Clip
for Kebony Fasteners (#2637, #2638)

Builder: FIA Homes

Photography: James Burniston

The Kebony Deck Board

The Only 4-in-1 Wood Decking Profile

The Kebony Deck Board is the most versatile wood decking profile on the market. We've engineered a profile that can be fastened in four different ways, making it easy to secure your surface decking according to your needs without added milling or lead time. Whether you want to fasten through the face of the board, plug, use hidden fasteners or the patented Step-Clip™ for Kebony system, the Kebony Deck Board is ready to go.

- 30-year, non-prorated warranty against rot
- 50-75 year expected life span as decking
- No maintenance required
- Evenly fades to silver-gray patina when left unfinished
- End-seal wax not needed or recommended

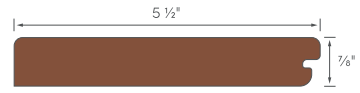
Profile	Product Number	Product Name	Actual Dimensions	Lengths
	#2637	5/4x6 Kebony Deck Board	7/8" x 5 1/2"	10', 12', 14', 16'
	#2638	5/4x6 Kebony Deck Board One-Sided Profile	7/8" x 5 1/2"	14'



Learn more at www.Kebony.us



Step-Clip® for Kebony

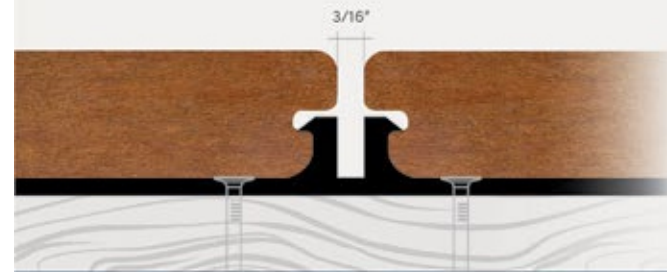

HIGHLIGHTS

- Fastest of the four install options
- Step-Clip® strip doubles as joist protection
- Automatic and consistent deck board spacing
- Easy board replacement

Step-Clip® Is A Registered Trademark Of Barrette Outdoor Living, Inc., Used With Permission By Kebony

Fastenator™ Hidden Fasteners

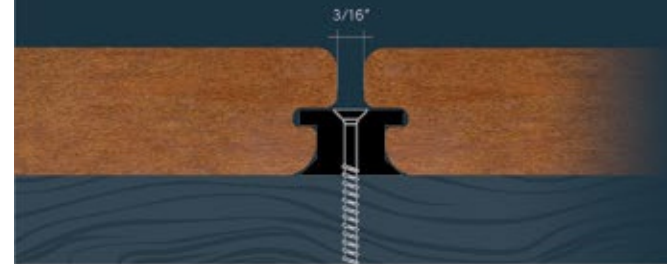

HIGHLIGHTS

- Automatic and consistent deck board spacing
- Works great for diagonal and herringbone deck patterns
- Ideal for resurfacing and/or out of square framing
- Stainless steel screws are pre-loaded in clip for quick and easy fastening

Pro Plug® System for Kebony

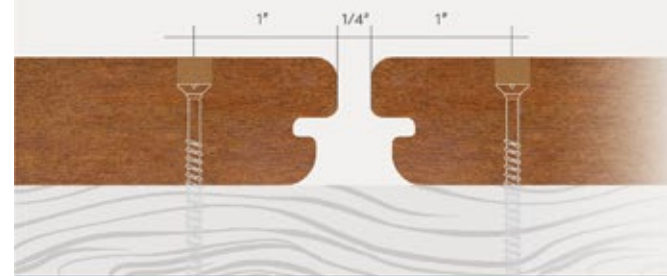

HIGHLIGHTS

- Hidden fasteners with face fastened strength
- Plugs made from actual Kebony face grain, so they perfectly match the surface
- Patented Pro Plug® Tool pre-drills and counterbores simultaneously for a perfect fit
- Kebony Kits include screws, plugs, glue nozzle and drill bit (Pro Plug® Tool and glue sold separately)

PRO TIP: Keep screws at least 1" from the end and edges of the boards.

Face Fastened

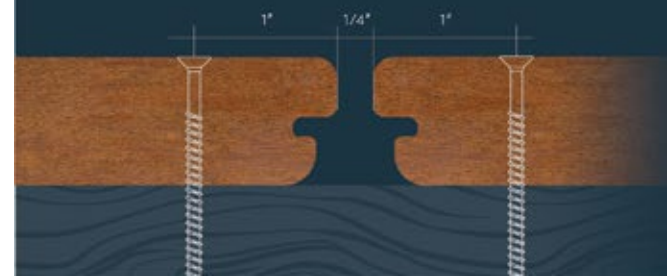

HIGHLIGHTS

- Ensures a secured board to the joist

PRO TIPS

- Pre-drill holes prior to fastening
- Use Stainless Steel Screws
- Keep screws at least 1" from the end and edges of the boards.
- Make sure screws are flush with top of the deck board to maintain a smooth and safe surface

Boardwalk Decking

Kebony Clear is perfect for high traffic areas like boardwalks and docks. With larger available dimensions and enhanced stability, choosing Kebony will ensure your project will withstand heavy use and retain beauty as it patinas to a silver-gray over time. Kebony's boardwalk product is the go-to for award-winning outdoor spaces across the country, including The Wharf in Washington D.C. and New York City's Hunter's Point South.

Profile	Product Number	Product Name	Actual Dimensions	Lengths
	#2522	2x6 Square S4S E2E	1 1/2" x 5 1/2"	10', 12', 14', 16'

Learn more at www.Kebony.us

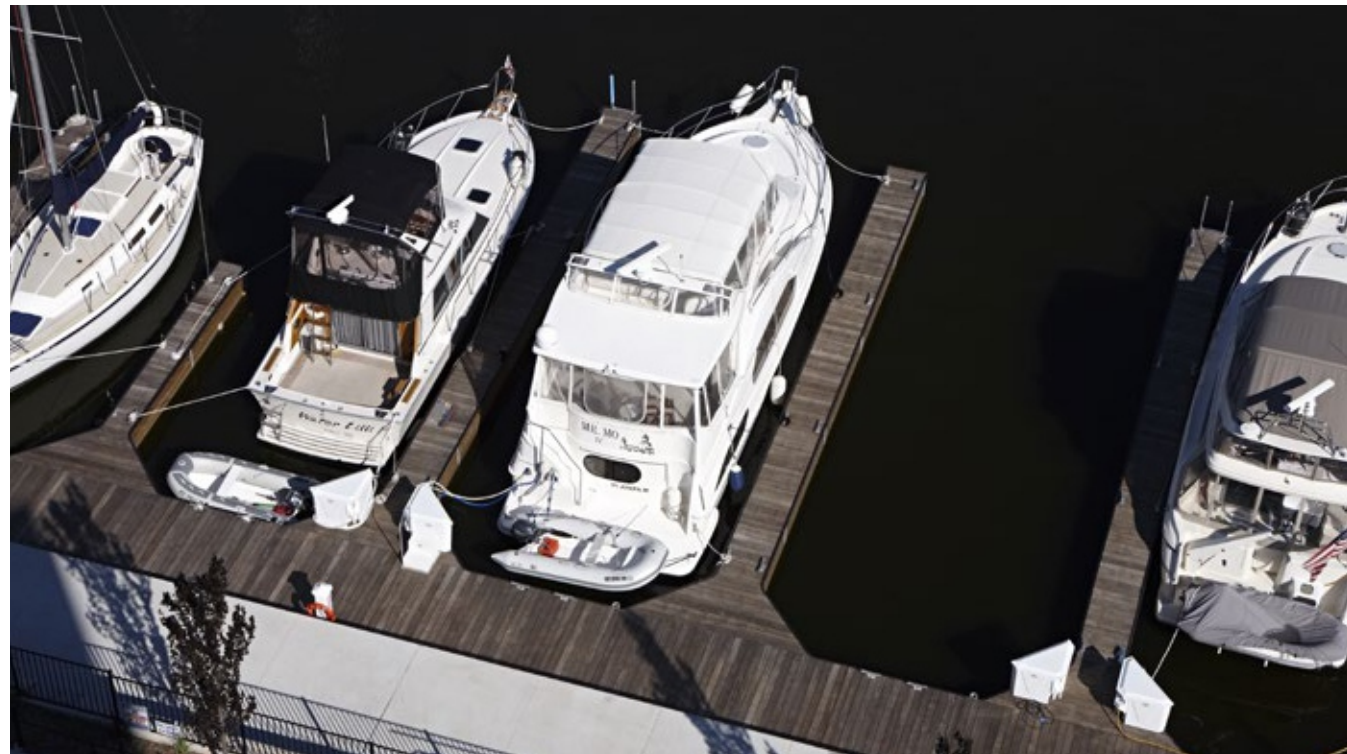

INN AT HARBOR SHORES MARINA

St. Joseph, MI

Product: 2x6 Clear Boardwalk

Design and Build: Edgewater Resources

Photography: David Trott of Blue Sky Photography, Inc.

Cladding

Kebony is leading the way in sustainable and long-lasting real wood cladding. Our award-winning cladding projects have solidified Kebony as the go-to for America's top architects. Kebony cladding is unmatched in beauty, durability, and sustainability.

Cladding Products

- Passive Rainscreen System
- Kebony Clear Cladding
- Kebony Character Cladding

Learn more at www.Kebony.us



WOOD SCREEN HOUSE
Nashville, TN
Product: 1x6 Clear T&G w/Nickel Gap (#KTGNG)
Architect: Michael Goorevich
Builder: Bryan Contractors
Photography: Kristian Alveo





THE BROKERY
 Phoenix, AZ
 Product: Kebony Clear Cladding
 Architect: Studio Ma
 Bill Timmerman

Passive Rainscreen System

The Passive Rainscreen System (PRS) goes beyond a traditional rainscreen to deliver maximum performance and aesthetics. A combination of marine-grade aluminum clips and perfectly matched Kebony Clear cladding, the PRS replaces common wood furring strips to create passive air flow between the cladding and sheathing. Its unique cladding profile creates a gap while providing increased protection from the elements, leading to a longer-lasting project all while hiding the fastener from view.

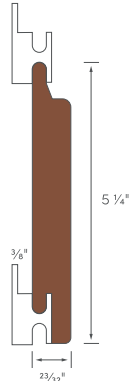
Passive Rainscreen System

<p>1x6 Clear Rainscreen Cladding (#KPRS1X6) Actual Dimensions: $2\frac{3}{32}'' \times 5\frac{1}{4}''$ Face: $4\frac{9}{16}''$ Gap: $\frac{1}{4}''$ Lengths: 10', 12', 14', 16'</p>	<p>Low-Profile Clip (#K975657LP) Rainscreen Gap: $\frac{3}{8}''$</p> 	<p>High-Profile Clip (#K975656HP) Rainscreen Gap: $\frac{3}{4}''$</p> 
-----------------------------------------------------------------------------------------------------------------------------------------------------------------------------------------------------------------------------------------------------------------------------------------------	------------------------------------------------------------------------------------------------------------------------------------------------------------------------------------------------------	-------------------------------------------------------------------------------------------------------------------------------------------------------------------------------------------------------

Learn more at www.Kebony.us



Passive Rainscreen cladding is special order, which may result in a longer lead time. Get more information and installation guides at www.kebony.us.



THE DOWER HOUSE

Sheffield, MA
 Product: Kebony Clear Cladding
 Architect: DHD Architecture PC
 Photography: Alan Tansey

Kebony Clear Cladding

Kebony Clear cladding is a perfect fit for residential and commercial siding applications. The uniform color will naturally patina over time like Brazilian Hardwoods, but without the instability and inconsistent color or grain. Our cladding also comes with a 30 warranty against rot, ensuring the beauty of your best projects for decades to come.

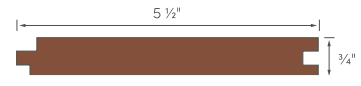
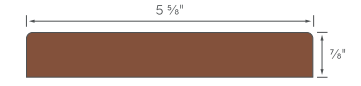
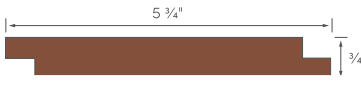
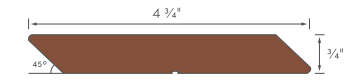
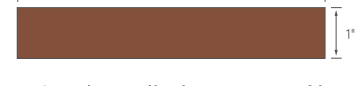
Profile	Product Number	Product Name	Face	Actual Dimensions	Lengths
	#KTGNG	1x6 T&G w/ Nickel Gap	5 1/4" Gap: 1/8"	3/4" x 5 1/2"	10', 12', 14', 16'
	#2226	5/4x6 Square S4S E2E	N/A	7/8" x 5 5/8"	10' 12', 14', 16'
	#K90XX514	1x6 90 Degree Shiplap	5 1/4"	3/4" x 5 3/4"	10', 12', 14', 16'
	#2436	1x6 Rhombus	N/A	3/4" x 4 3/4"	10', 12', 14', 16'
 Can be milled to any profile	#1935	1x6 Clear Rough Sawn	N/A	1" x 6"	10', 12', 14', 16'

Learn more at www.Kebony.us



All profiles are special order, which may result in a longer lead time. Get more information and installation guides at www.kebony.us.

Kebony Character Cladding

The knotty grain of Kebony Character cladding gives your project a rustic feel at a value-conscious price. Kebony Character goes through the same modification process and comes with the same 30-year warranty as Kebony Clear.





FULSHEAR MODERN RANCH ESTATE

Fulshear, TX

Product: 1x6 Character 90 Degree Shiplap (#2216)

Designer: David Wersebe

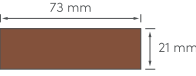
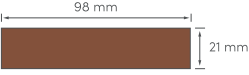
Photography: Kristian Alveo

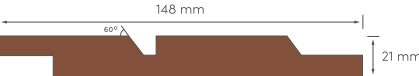
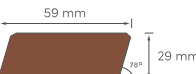
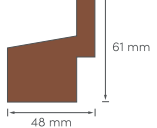
Profile	Product Number	Product Name	Actual Dimensions	Lengths
	#2335	1x3 Character Square	21 x 73 mm	3 m, 3.6 m, 4.2 m, 4.8 m
	#1407	1x4 Character Square	21 x 98 mm	3 m, 3.6 m, 4.2 m, 4.8 m
	#2336	1x5 Character Square	21 x 123 mm	3 m, 3.6 m, 4.2 m, 4.8 m
	#2338	1x8 Character Square	21 x 198 mm	3 m, 3.6 m, 4.2 m, 4.8 m
	#2216	1x6 Character 90 Degree Shiplap	21 x 148 mm	3 m, 3.6 m, 4.2 m, 4.8 m
	#2242	1x6 Character 60 Degree Shiplap w/Shadow	21 x 148 mm	3 m, 3.6 m, 4.2 m, 4.8 m
	#2168	70 Degree Rhombus	29 x 59 mm	3 m, 3.6 m, 4.2 m, 4.8 m
	#1217	Character Melsomslat	61 x 48 mm	3 m, 3.6 m, 4.2 m, 4.8 m

Learn more at www.Kebony.us



All profiles are special order, which may result in a longer lead time. Get more information and installation guides at www.kebony.us.

Kebony Site Furnishings

Kebony Site Furnishings merge the strength, stability, and sustainability of Kebony with modern fabrication design. We've partnered with trusted custom furniture makers to produce furnishings built to last. Whether choosing from our curated furniture line or seeking a custom design for your public space, Kebony Site Furnishings will make a natural statement.

Product Lines

- North Cape
- Custom Design

[Learn more at www.Kebony.us](http://www.Kebony.us)



INLAND EMPIRE HEALTH PLAN
Rancho Cucamonga, CA
Builder: Angeles Contractors
Manufacturer: DM Braun



North Cape

by Kebony

The most northern part of Norway, North Cape boasts a stunning cliffside view of the Northern Lights over the Arctic Sea. Marked by an iconic steel globe, we drew inspiration from the rugged beauty of North Cape coupled with the modern technology of Kebony. This collection is designed to blend beautifully with its surroundings, perfect for public areas or landmarks like its namesake.

North Cape Features

- Modern Design
- Steel Framed Construction
- Stainless Steel Screws
- Kebony Clear Grade Slats
- Powder Coating and Hot-Dipped Galvanized Options Available

■ Custom Design & Fabrication Also Available

Radius Bench

- Hot-Dipped Galvanized Steel Frame
- Anchor side-by-side to form full bench
- Create different patterns by reversing bench positions

Section

Length: 75 ¼"

Width: 24"

Height: 19"

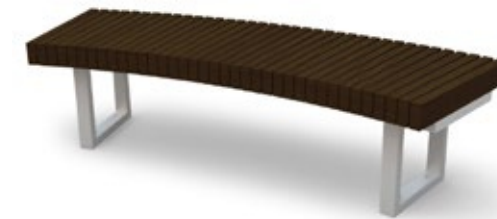

Full Bench (5 Sections)

Bench Length: 378 ½"

Length: 278 ⅝"

Depth: 113 ⅝"

Radius: 150°



Standard Bench (6' Bench)

- Sandblasted, Primed & Powder Coated
- Stainless Steel Anchor Feet
- Popular Powder Coating Colors



Length*: 60" - 84"

Width: 22 ½"

Height: 32 ⅜"

*lengths outside this range considered custom



Backless Bench

- Sandblasted, Primed & Powder Coated
- Stainless Steel Anchor Feet
- Popular Powder Coating Colors



Length*: 36" - 84"

Width: 19"

Height: 18 1/2"

*lengths outside this range considered custom



Picnic Table + Swivel Chairs

- Sandblasted, Primed & Powder Coated
- 2 1/2" Diameter Umbrella Hole w/ Umbrella Base
- Chairs mounted on swivel bases
- Stainless Steel Foot Spacers
- Stainless Steel Anchor Tabs
- Ships fully assembled and ready to anchor
- Popular Powder Coating Colors



Standard Table

Length: 88"

Width: 88"

Height: 34 1/4"

Table Size: 42" Square

Chair Height: 19 3/8"

Table Height: 30 1/4"



ADA Table

Length: 88"

Width: 64 3/4"

Height: 34 1/4"

Chair Height: 19 3/8"

Table Height: 30 1/4"



Swivel Chair

Seat: 3° tilt back

Seat Back: 100° angle

Memory Seat Swivel

Seat is 18" from Center

Picnic Table

- Sandblasted, Primed & Powder Coated
- Stainless Steel Anchor Feet
- Popular Powder Coating Colors



Table

Length: 72"

Width: 31"

Height: 30"

Standard Bench

Length: 72"

Width: 19"

Height: 18 1/2"

ADA Bench

Length: 36"

Width: 19"

Height: 18 1/2"



Receptacle

- Sandblasted, Primed & Powder Coated
- 32 Gallon Rigid Liner Included
- Detachable Aluminum Lid
- Available with a Recycle Symbol
- Stainless Steel Anchor Tabs
- Popular Powder Coating Colors



Diameter: 26 3/4"

Opening: 10"

Height: 34"



Millwork

Our Kebony Clear lumber has tremendous versatility compared to tropical hardwoods. Not only is our FSC®-Certified wood easy to work, it is dimensionally stable. The modification process changes the cell structure of the wood without harsh additives or glues to get in the way. For this reason, Kebony can handle heavy use on commercial benches, create stunningly intricate outdoor sculptures, or get milled down for wooden guitar picks and silverware handles.



THE HARLAND WEST HOLLYWOOD

West Hollywood, CA





Product: 2x3 Clear Beam (#2480)

Architect: Office Untitled & Marmol Radziner

Builder: Matt Construction

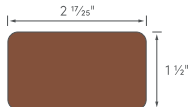
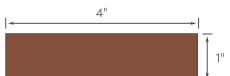
Developer: Faring & DM Development

Photography: Kristian Alveo

Profile	Product Number	Product Name	Actual Dimensions	Lengths
	#2480	2x3 Clear Beam S4S E4E	1 1/2" x 2 17/32"	10', 12', 14', 16'
	#2535	1x4 Rough Sawn	1" x 4"	10', 12', 14', 16'
	#1935	1x6 Rough Sawn	1" x 6"	10', 12', 14', 16'
	#2423	2x4 Rough Sawn	2" x 4"	10', 12', 14', 16'
	#1931	1x8 Rough Sawn	1" x 8"	10', 12', 14', 16'

Learn more at www.Kebony.us



All profiles are special order, which may result in a longer lead time. Get more information and installation guides at www.kebony.us.



Design vs Build

One Impressive Project. Two Unique Perspectives.

Presented by Kebony, Design vs. Build is a new video series concept that explores the differences in how the Architect/Designer and the Builder see a project as it moves from an idea to the construction phase and then a finished structure. Each episode will feature a different residential or commercial project with interviews from architects, designers, project managers, and more as they walk you through the project from their point of view.



View all episodes and more at www.designvsbuild.com



THE TELLY AWARDS

Gold Winner
2020 Online Series: Documentary

Gold Winner
2020 Branded Content: Video/
Cinematography

Silver Winner
2020 Online Series: Non-Scripted

W3 Gold Winner
Video Series for Web

Silver Winner
Best Use of Cinematography

The Fulshear House — Episode 101

Fulshear, TX



Watch the designer/developer, structural engineer and project manager walk us through this stunning project set in the midst of an expansive pecan orchard. From a forty-foot steel and glass bridge to cement trucks flipping over at 3am, see what it took to design, plan and build The Fulshear House.

Designer/Developer: David Wersbe
Project Manager: Santiago Macedo, Opaz LLC
Structural Engineer: Shannon Galway
Architect: Tammy Hodgeson

The Harland West Hollywood — Episode 102

West Hollywood, CA

Office Untitled is an up-and-coming LA firm quickly making a name for itself with the recent completion of a 37 unit ultra-luxurious condo project on the border of West Hollywood and Beverly Hills. The project is 115,000 square feet, has 4 floors plus a parking garage, 9 elevators and a bowling alley.

Architect: Office Untitled
Interior Architect: Marmol Radziner
Builder: MATT Construction
Developer: Faring. & DM Development



TheatreSquared — Episode 103

Fayetteville, AR



Tucked away in the rolling hills of Northwest Arkansas is a world-class theatre dedicated to creating in-house productions for an intimate and inclusive environment. When it came time to expand, they landed a once-in-a-lifetime grant from the Walton Family Foundation, giving them the opportunity to work with world-renowned architects and theatre designers to create the perfect space.

Theatre Design: Charcoal Blue
Architect: Marvel Architects
General Contractor: Baldwin & Shell
Millwork/Cladding: Delta Millworks

About Kebony

Natural wood made to last.

Headquartered in Oslo, Norway, Kebony is the leading global modified wood brand. Underpinned by proven and patented timber modification technologies, it produces an enhanced wood of superior quality that is both environmentally friendly and cost-effective.

From its production facilities located in Skien, Norway, and Flanders, Belgium, Kebony redefines standards in the timber industry and new possibilities for wood as a sustainable construction material. Kebony has sales and distribution across Europe spanning into North America and the rest of the world.

The company has received numerous awards and accolades for its environmentally friendly technology and innovation, including being named a World Economic Forum Technology Pioneer, repeated recognition as a Global Cleantech 100 company, and a 2019 Building, Design + Construction Top 101 Products Reader's Choice Winner.

Kebony Technology

Fully compliant with EU Timber Legislation, Kebony technology permanently transforms sustainable wood species such as pine into finished products with characteristics comparable to and, in some cases, better-performing than tropical hardwoods. This unique, patented technology is a process whereby sustainably sourced wood species are impregnated with furfuryl alcohol, which is derived from agricultural crop waste. With the addition of heat, the furfuryl polymer is permanently grafted into the wood cell wall, resulting in greatly improved durability and dimensional stability, making the wood strong and resistant to biological decay and harsh weather conditions. FSC®-certified, Kebony wood provides architects and specifiers with a product that is unrivalled in its performance, delivering aesthetic value and durability.

Kebony's mission

Through active innovation and forward thinking, we will continue to produce beautiful, long-lasting and environmentally friendly wood products. The company will promote and practice social responsibility to improve the environment in a way that builds a better future.

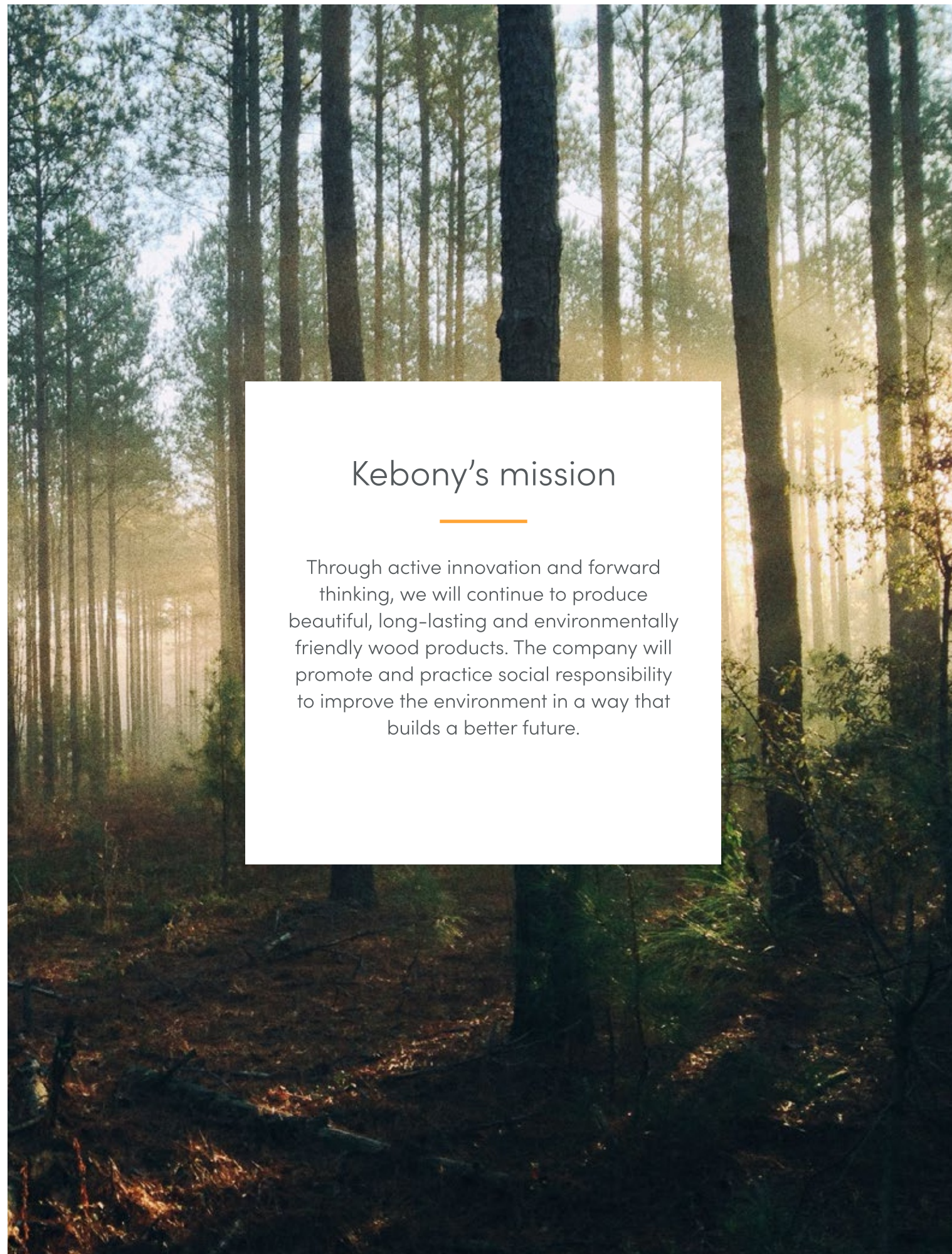



RAVENSDALE OUTDOOR OASIS

Seattle, WA

Product: 5/4x6 Clear S4S E2E (#2226)

Interior Designer: Triple Heart Design

Builder: McCarthy Custom Homes

Photography: Matthew Gallant

The Modification Process

Developed in Norway, Kebony is an environmentally friendly, patented process that enhances the properties of sustainable softwood with a bio-based liquid. The process permanently modifies the wood cell walls, giving Kebony premium hardwood characteristics and a rich brown color throughout in two basic steps.

Step 1: Impregnation

Impregnation is the process in which the wood is infused with furfuryl alcohol (FA) produced from a bio-based liquid to make it dimensionally stable.

Step 2: Curing and Drying

After impregnation, the wood is heated, also known as curing. The resulting polymer, which is now permanently locked into the wood cells, is stable and will not disintegrate or leach out of the wood.

Result: Kebony Wood

After modification, the wood cell walls are 50 percent thicker due to the stable, locked-in polymers. This permanent modification of the wood cell walls gives the final wood product outstanding stability, the maximum amount of hardness and a guaranteed long life. Kebony wood also provides a high level of safety as the wood does not splinter and contains no toxins or chemicals, as well as staying cooler in the summer.

Because Kebony permanently changes the wood's behaviors as compared to natural woods, there is no need to consistently maintain the surface for longevity; you can simply let the wood naturally gray like Ipé or other Brazilian hardwoods.

Steps

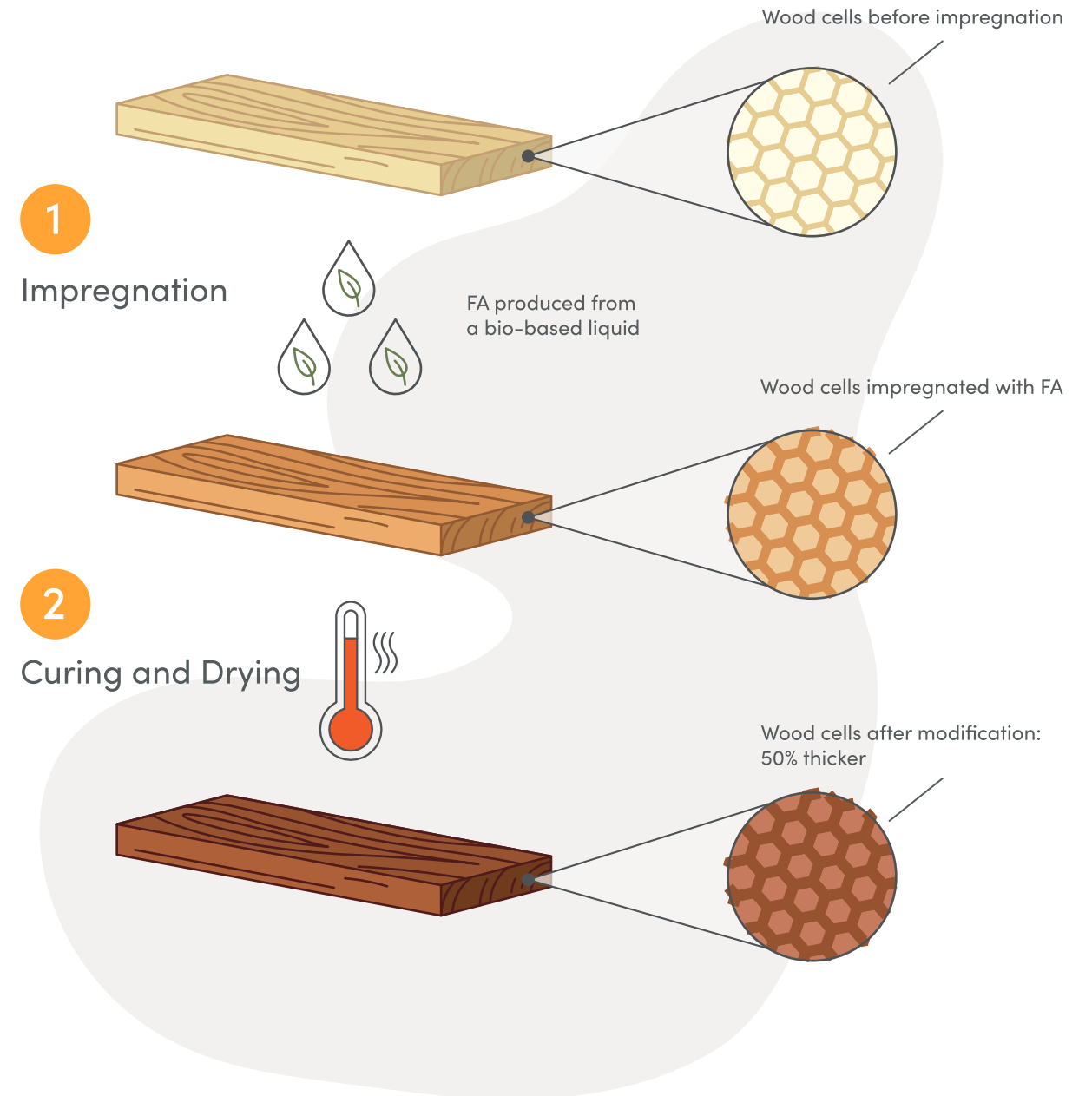

Stable, locked-in furan polymers in the wood cell walls give:
Outstanding stability • Maximum hardness • Guaranteed long life

Performance

Appearance

All Kebony woods have a deep brown color that will turn to a silver-gray patina over time. The speed of this graying process depends on the intensity of exposure to environmental elements like the sun and rain combined with the type of application.



Kebony Clear RAP products are produced from FSC®-certified Pinus Radiata, they have a clear front surface and are treated through the board. They can be further machined as any other hardwood.



Kebony Character products are produced from FSC®-certified Pinus Sylvestris and contain knots and untreated heartwood. They should not be further machined or split as untreated heartwood will be exposed. Kebony Character products can be cross-cut to length. Exposed end grain after cross-cutting must be treated with a wood preservative.



Durability, Hardness & Maximum Movement

Wood species	Durability 1=best EN 350	Hardness Janka (lbf)	Swelling Dry to wet in tangential direction (%)
Ipe	1	3510	6
Kebony Clear RAP	1	1618	4
Teak	1	1070	3 - 4
Thermo Ash	1 - 2	900	5
Kebony Character	1 - 2*	630	6
Thermo Pine	2	600	4
Western Red Cedar	2 - 3	350	5

*Heartwood

Kebony vs. Ipe

Whether you call it epay, ipe, or I.P.E. (the correct pronunciation is ee-pay, FYI), the Brazilian Hardwood known as Ipe is starting to come under fire; literally and figuratively. Between increased fires in the Amazon Basin and illegal harvesting, it's time to start looking for Alternatives for Ipe.

So, how does Kebony stack up against Ipe and other Brazilian hardwoods? We are going to look at 5 main characteristics.

Durability

Ipe has always been known for its strength, being branded as "Iron Wood" by some importers. There's no doubt Ipe is extremely durable, in terms of hardness, the Brazilian Hardwood is more than twice as hard as Kebony Clear on the Janka hardness test. Ipé is also touted as lasting 75-100 years; that's a long time!

How strong is too strong?

Kebony is not as hard as Ipe, but does it need to be? Kebony does come with a 30-year warranty and is still as hard as other Brazilian Hardwoods. Ipe's density makes it extremely hard to work with, so be prepared to pre-drill and buy extra carbide-tipped saw blades. The biggest advantage Kebony has over Ipe is in stability. Kebony's modification process makes it very resistant to warping, cupping and splintering, which is a common problem with any tropical hardwood that leads to added waste.

Winner: Ipe for density, Kebony for stability and warranty

Appearance

Kebony Clear and Ipe are very similar in appearance. Both have a rich brown color, and both will naturally fade to a nice light gray unless regularly oiled. Both products also have a clear and straight grain pattern. The difference in Kebony and Ipe is the consistency. Kebony has a very uniform color and grain pattern, where Ipé will have variations in color and grain. Ipé has varying grades as well, so know what you are getting before it arrives.

Winner: Kebony for its uniformity

Maintenance

Both products have nearly identical maintenance routines. If you would like Kebony or Ipe to patina to a silver/gray, then little to no maintenance is required. Just let nature run its course. If you would like to keep the lustrous brown color of either product, regularly use a UV inhibiting Hardwood Oil. With Ipe, the extreme density of the wood means the Hardwood Oil won't soak into the wood, so be sure to back wipe excess oil within 15 minutes of application. Kebony will require some back wiping, but the oil will also soak into the wood.

Winner: Tie

Environmental Impact

This area is where Kebony and Ipe differ the most. Kebony is sustainably harvested from FSC®-certified forests. Because Kebony uses responsibly managed lumber and eco-friendly chemicals, it is an incredible green product: perfect for gaining LEED points for a project. Ipe? Well, that all depends on the mill. Unless the importer visits the sawmills personally, it's hard to know whether or not your Ipe was illegally harvested. Even when the rainforest is properly managed, Ipe trees take 80-100 years to mature. One thing is certain: Ipe is not sustainable and the supply of Ipe in the Amazon will eventually run out in the distant future. Ipe could even end up on the CITES Appendix II List in the next several years, making it very hard to harvest.

Obvious Winner: Kebony

Value

A price comparison will vary depending on region. Generally speaking, 5/4x6 Kebony Clear decking is priced right in between 1x6 Ipe and 5/4x6 Ipe. The added benefit of Kebony is it comes in premium lengths like 12' and 16' at no additional charge, so you can get the best lengths for your project without paying extra. For most of the country, Ipé will have a 10-20% upcharge for 12', 16' and 20' lengths, and many retailers will steer you towards shorter or random lengths to keep your cost down. For exact numbers you can consult your local lumberyard.

Winner: Kebony for price consistency

The Verdict

It's time to rethink whether you REALLY need Ipe on your next project, because there is a clear-cut alternative: Kebony.

Kebony vs. Thermally-Modified

In the world of modified woods, there are many different versions. But not all modification processes are created equal, so how do you tell the difference? Here are 5 primary categories to help you distinguish between Kebony and thermally-modified wood products.

Modification Process

Kebyony uses a patented and proprietary modification process called furfurylation. Furfurylation uses a bio based liquid called furfuryl alcohol derived from agricultural plant waste. Furfuryl alcohol is injected into the sapwood cells and when combined with heat, permanently bonds together, resulting in a softwood being permanently transformed into the characteristics of a hardwood. Even though chemicals are used, the product is non-toxic both during and at the end of service. Kebony comes with a 30-yr warranty.

Thermal modification of wood is a chemical-free process where wood is heated in a kiln to temperatures between 180°C and 230°C. This also results in a permanent change of the wood cells creating improved durability and performance. Thermal modification is very common, many companies use a variation of this science. Most thermally-modified woods come with a 25-yr warranty at the most.

Winner: Since Kebony's process is thickening wood cells while thermal modification thins wood cell walls, increasing brittleness, the advantage goes to Kebony

Durability

Kebyony contains a permanently swollen and stable cell wall providing a long life span and a wood more similar in performance to tropical hardwoods. The furfurylation process produces resistance to microbial decay, increased dimensional stability, hardness, stiffness and a controlled moisture content. For these reasons, Kebony offers a 30-year warranty on Kebony products.

Thermally-modified woods bake out the wood sugars that are a food source to insects while controlling the wood's moisture content in order to produce a more stable product than the original species. Because of the removal of substances from the wood cells, thermally-modified woods are less desirable for heavy traffic areas like boardwalks or commercial decks. As a decking or site furnishing, it has the drawback of the cell walls being reduced in thickness and susceptible to cell collapse and it can be prone to wear in high foot traffic areas.

Winner: Kebony for enhanced durability as a decking product

Maintenance

Both products weather to a nice silver patina and do not require maintenance other than normal cleaning. Kebony wood will have a 30 year warranty where most thermally-modified pines will not

contain a warranty. Some thermally modified hardwoods have a warranty of 25 years depending on the manufacturer and wood species.

With both product types being natural wood, they can be cleaned with soap and water or with some light pressure washing. Either product can also hold stain or paint based on manufacturer specifications.

Winner: Tie, with Kebony having a slight edge because of a longer warranty

Environmental Impact

Kebyony is the ultimate alternative to the tropical hardwoods. Kebony uses FSC®-certified fast growth trees which only take 30 years to mature and gives them a total life cycle that will outlive many tropical hardwoods. The trees come from sustainably managed forests and are all FSC®-certified. In contrast, Ipé and other tropical hardwoods have a 100-yr maturity rate and are retrieved through rainforest deforestation or illegal logging practices. The Kebony modification process is also clean and non-toxic.

Thermal modification is practiced with a variety of wood species depending on the manufacturer, from non-FSC®-certified Pine and hardwoods like Ash. Pine is a fast-growth softwood, while Ash tends to have a longer growth cycle and less progressive reforestation plan, increasing the overall environmental impact. Slower growth trees work better for thermal modification since the wood cell walls are being thinned during the modification process.

Transportation and shipping is another thing to consider in terms of environmental impact. Kebony is produced in Norway and Belgium, thermally-modified products are produced in both the USA and internationally. A common misconception is shipping internationally significantly increases the carbon footprint of a product, but due to the a shipping vessels massive capacity shipping over water ends up being twice as fuel-efficient as a rail car and almost 10 times more efficient than semi-trucks.

Winner: Both are significantly more sustainable than tropical hardwoods, but since Kebony can utilize the fastest growing trees in the best climates in the world they have a definitive edge over thermal modification

Value

Value is typically dependent on use and goals of the project. The cost difference between Kebony and similar thermally-modified products vary greatly between manufacturers and based on region. Another factor that should be considered is total cost of ownership. If a project is designed to be long-lasting then you want to use a product designed to last as long as the other materials being utilized.

Winner: It depends on the project

Conclusion

We can't speak for all thermally-modified products, but typically furfurylated wood like Kebony creates a more durable product than thermal modification when using the same species and dimensions. We encourage you to do your own research and choose the product that best suits your specific needs.



DE VILLA TEGERNSEE
Tegernsee, Germany
Product: Kebony Clear Cladding & Decking
Photography: René Sievert



How to Buy

Whether you order through your local lumberyard or buy direct, Kebony products are available anywhere in the United States & Canada from our Regional Distribution Centers (RDC) and trusted partners.

Call Us: 855.230.5656

Email Us: info@kebonny.us



Offices
 St Clair, MI (Headquarters)
 Providence, RI
 Austin, TX
 Orange County, CA
 Seattle, WA

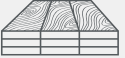

Regional Distribution Centers
 St Joe, IN
 Toronto, ON, Canada
 North Kingston, RI
 Baltimore, MD
 Atlanta, GA
 Austin, TX
 Long Beach, CA
 Oakland, CA
 Seattle, WA
 Calgary, AB, Canada

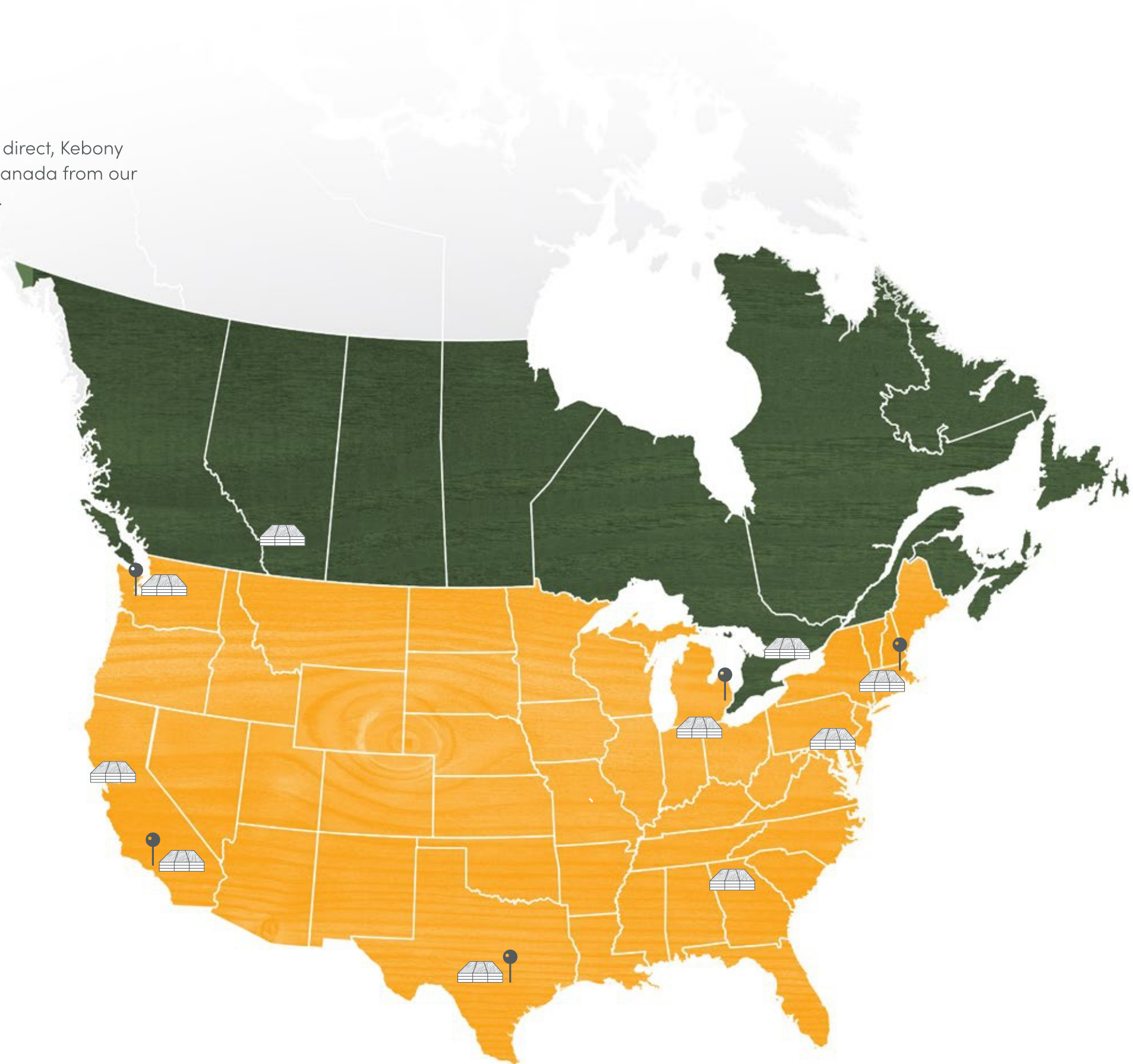



Natural wood
Made to last

Proudly Distributed by

HARDWOODS[®]
Materials That Inspire

888-826-5528
hardwoods-inc.com | www.hardwoods.online

Specification Support by

Design **one** **Source**[®]
Where Inspiration and Design Meet Supply

866-599-1433
designonesource.com