

# PRODUCT DATA SHEETS

**Simpson**<sup>®</sup>  
Door Company

Proudly Distributed By

**RIVER CITY  
MILLWORK**



- 02** Clear Edge Exterior Doors
- 03** Clear Edge Interior Doors
- 04** Full Lite Doors
- 05** Dog Doors For Your Simpson Door
- 06** Dutch Doors
- 07** Fire-Rated Doors
- 08** Flush Exterior Doors
- 09** French Doors With Internal Blinds
- 10** Impact-Rated Doors
- 11** Selecting The Right Door For The Exposure
- 12** Matching Millwork for Your Simpson Door
- 13** Monster Doors
- 14** Nantucket Collection
- 15** Panel and Groove Options
- 16** Pivot Door System
- 17** Plantation Louver Doors
- 18** Rustic Barn Doors
- 19** Factory Finish for Interior Barn Doors
- 20** Redi-Prime<sup>®</sup> Premium Flush Interior Doors
- 21** Redi-Prime<sup>®</sup> Interior Doors
- 22** Redi-Prime<sup>®</sup> Raised Panel Interior Doors
- 23** SDL vs. TDL For My Exterior Door
- 24** Shaker Sticking Profile
- 25** Sticking Profile Options
- 26** UltraBlock<sup>®</sup> Technology
- 27** Utility Doors For Tough Exposures
- 28** WaterBarrier<sup>®</sup> Technology

# Clear Edge® Exterior Doors

Scan for  
More Information



Simpson delivers cutting edge design with our innovation – Clear Edge® technology. These unique exterior doors are creatively crafted by extending the glass lites all the way to the edge of the door. This contemporary style provides a stunning visual impact that’s not boxed in by traditional thinking. See this unexpected, one-of-a-kind look for yourself.

- Choose from 14 standard designs
- 1/2" Solid Tempered Glass
- Available with optional UltraBlock® technology
- Doors can be made in any wood species and virtually any size
- Glass types available: clear and satin etch

## Clear Edge® Exterior Door Profile

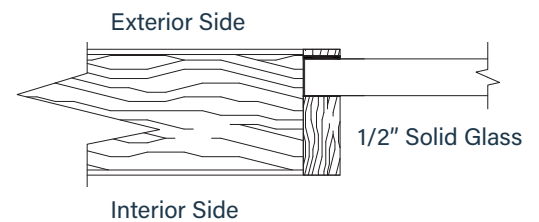

Designs Shown as Viewed from Exterior

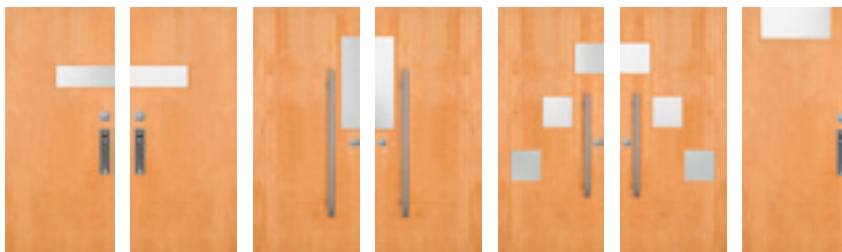

49941    49940    49943    49942    49945    49944    49980

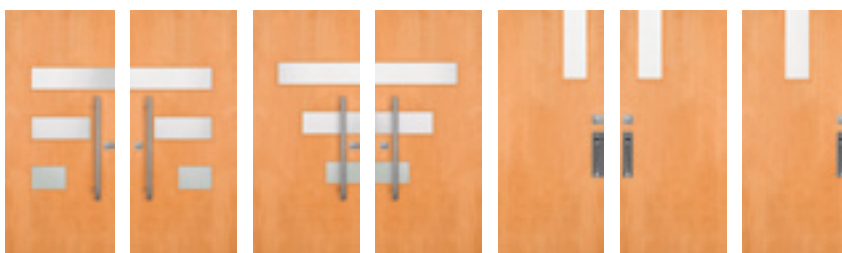

49947    49946    49949    49948    49982    49983    49981



Proudly Distributed By

**RIVER CITY  
MILLWORK**

**Simpson®**  
Door Company

# Clear Edge® Interior Doors

Scan for  
More Information



Take your interior doors to the next level with Clear Edge® French doors. A stunning visual impact featuring glass the full height of the door which can allow full view of an adjacent space, in an unexpected, beautiful design.

- Choose from 3 standard designs or create your own personalized design
- 1-3/4" thick with 3/8" solid glass
- Available with shaker sticking
- Doors can be made in any wood species
- Glass types available: clear, satin etch, grey, bronze, rain

## Clear Edge® Profile

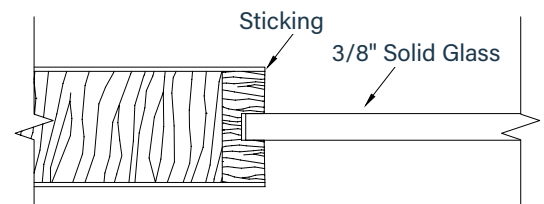

## Glass Options



49930

49931

49932



Clear

Gray

Satin Etch

Bronze



Rain

Proudly Distributed By

**RIVER CITY  
MILLWORK**

**Simpson®**  
Door Company

# Full Lite Doors

Scan for  
More Information



Meet your exact design requirements with full lite doors. Some door types restrict you to standard sizes, both for the overall door size and components within the door. When you order from Simpson, you can request the exact design, size, shape and component sizes to meet the needs of your project.

One example is our full-lite doors that feature 3/4" thick insulated glass. These can be ordered in any size with any wood species and dozens of glass types. In addition, choose from a variety of profiles and specify the size of your components. The most requested component sizes for these doors are shown at right and are the default for each door design.

You don't have to compromise design to get the door you need. Get exactly the door you want. Select Simpson.

- Available in any wood species and with dozens of glass types
- Select from the popular ovolo or shaker sticking profiles or any other custom profile
- Select the exact size you need for your project, up to 12 feet tall, 5-1/2 feet wide and 2-1/4" thick
- Upgrade your door with UltraBlock® technology (5-year warranty) or WaterBarrier® technology (5-year warranty with no building overhang requirement)

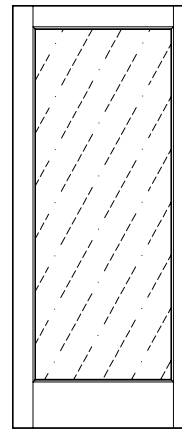

**7001**  
Traditional Layout  
(4-1/2" Wide Stiles)

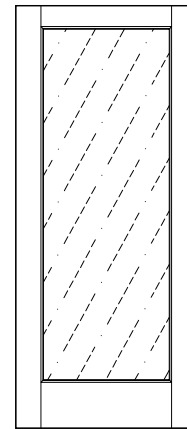

**7002**  
Accommodates  
Heavier Hardware  
(5-1/2" Wide Stiles)

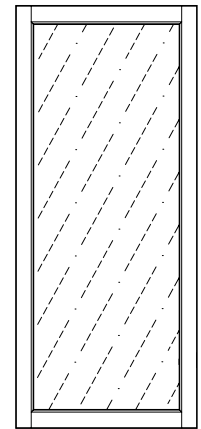

**7003**  
Contemporary  
Layout  
(3-1/2" Wide Stiles &  
3-1/2" Tall Rails)

## Profile Options

Ovolo Sticking (Standard)

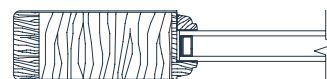

Shaker Sticking (Option)



Proudly Distributed By

**RIVER CITY  
MILLWORK**

**Simpson®**  
Door Company

# Dog Doors for Your Simpson Door



Simpson® is combining two of our great loves, the love for our home and our pets, with the introduction of its dog door collection. Simpson can offer dog doors in a variety of existing Simpson door designs and is featuring both the 49971 and 7008 designs as its standard dog door designs.

## High Quality Dog Door Using the Best Components

- Heavy-duty aluminum frames and high-performance springs.
- Door made with shatter-resistant K9 composite saloon-style panels that do not require vinyl replacement flaps. Each panel includes high-density industrial weatherseal, keeping the AC and heat inside your home.
- Every dog door comes standard with lock, key, and 20-gauge steel security plate.

## Dog Door Pre-Installed in Your Simpson Door at the Factory

- Let Simpson take the hassle out of the dog door install.
- All internal wood components sealed at the Simpson factory.
- Full Simpson door warranty ONLY if Simpson installs the dog door.

## Options to Fit Your Home and Your Dog

- **Medium (Up to 40 pounds)**
  - Opening for Dog: 9" wide x 12" tall
  - Overall Dog Door Size: 13-3/4" wide x 15-1/4" tall
  - Installed: 5" from bottom of door
- **Large (Up to 100 pounds)**
  - Opening for Dog: 11-3/4" wide x 16" tall
  - Overall Dog Door Size: 16-1/2" wide x 19-1/4" tall
  - Installed: 10" from bottom of door
- **X-Large (Up to 220 pounds)**
  - Opening for Dog: 15-3/4" wide x 23-5/8" tall
  - Overall Dog Door Size: 20-1/2" wide x 26-3/4" tall
  - Installed: 12-3/8" from bottom of door
- **Choose from 3 finishes:**
  - White
  - Silver
  - Bronze

Proudly Distributed By

**RIVER CITY  
MILLWORK**

**Simpson®**  
Door Company

# Dutch Doors

Scan for  
More Information



Nothing says classic Americana like a Dutch door. Dutch doors are a practical way to connect indoor and outdoor space, giving you the perfect solution for your application and climate. Simpson can turn almost any door into a Dutch door allowing for ultimate customization in making your space special.

- Most door styles can be dutched, as long as it has solid wood across the area to be cut, like a flush door or a door with an intermediate rail.
- Choose a door design that fits your architecture. Dutch doors are a fit for both traditional and contemporary styles.
- Dutch doors can be constructed in a few ways (see right). Choose the type that works best for your application.



## Dutch Door Profile

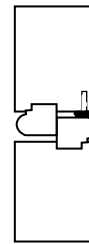

**Dutch & Rabbet with Dado**  
*For Exterior Doors*

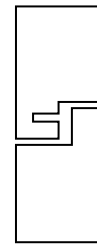

**Dutch & Rabbet with Kerf**  
*For Exterior Doors*

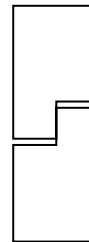

**Dutch & Rabbet**  
*For Exterior & Interior Doors*



**Dutch Square**  
*For Interior Doors*

Proudly Distributed By

**RIVER CITY  
MILLWORK**

**Simpson**<sup>®</sup>  
Door Company

# Fire-Rated Doors

Scan for  
More Information

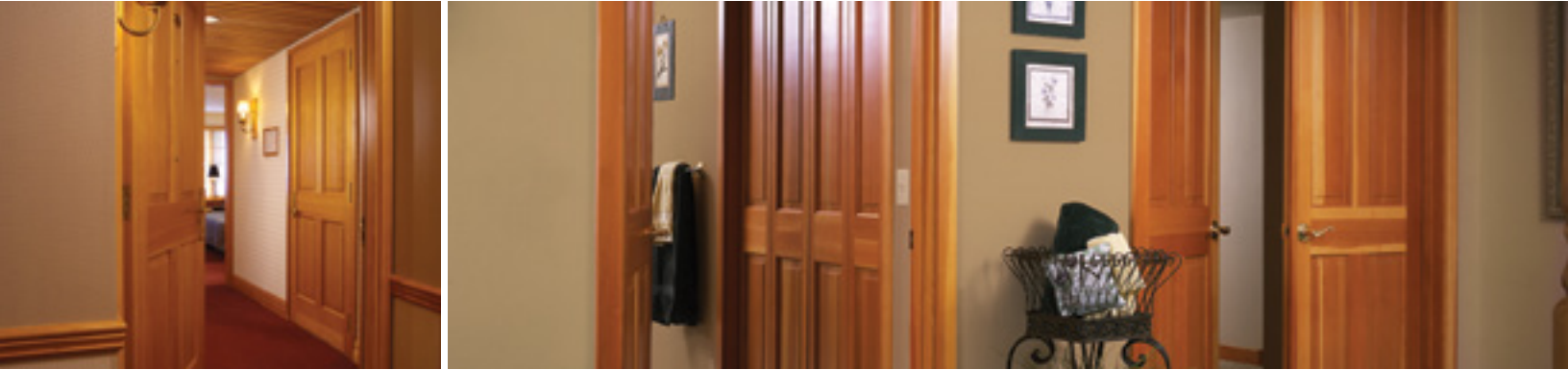

Simpson offers a variety of choices for fire-rated doors, including 20-minute fire-rated wood doors and MDF doors with fire ratings up to 90-minute. And since Simpson fire-rated doors have been designed to match other interior doors, your entire house package will blend seamlessly.

## 20-MINUTE WOOD FIRE-RATED DOORS

Simpson 20-minute fire-rated doors comply with major code requirements for the 20-minute fire safety classification. This classification covers most residential requirements and can also meet commercial requirements for 20-minutes.

- Fire door designs complement Simpson interior door designs for architectural consistency throughout your home
- Nearly unlimited design flexibility
- Choose from six profiles – ovolo, shaker, square step, bevel, ogee or quarter round
- Two panel types available – 3/4" flat or 1-7/16" double hip-raised
- Order in any size up to 3'6" wide and 8'0" tall
- Choose from virtually any wood species
- Excellent finishing characteristics
- Select decorative options to meet your design needs:
  - » Arched rail components
  - » V-groove raised panels

## Fire-Rated Profiles

### Raised Panel Fire Doors

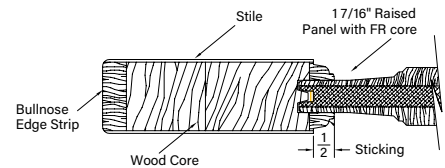

### Flat Panel Fire Doors

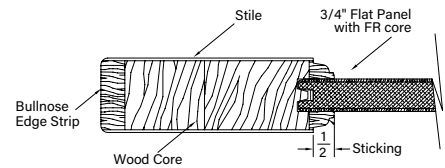

### Shaker Flat Panel Fire Doors

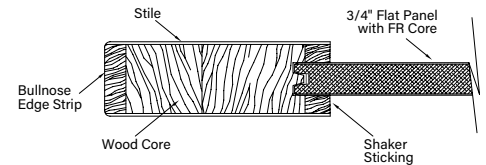

9266 RP  
*Shown in Poplar*



9360 SHAKER FP  
*Shown in Cherry*

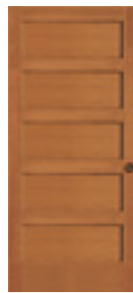

9255 FP  
*Shown in Douglas Fir*



49220  
*Shown in Walnut*

Proudly Distributed By

**RIVER CITY  
MILLWORK**

**Simpson®**  
Door Company

# Contemporary Flush Exterior Doors

Scan for  
More Information

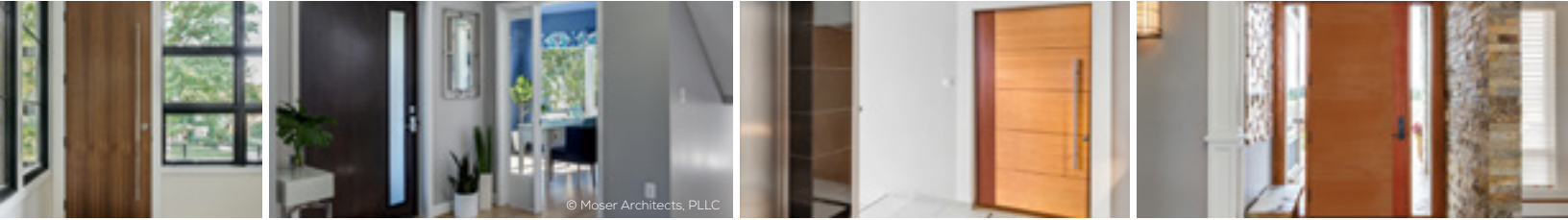

**49900**  
Shown in  
cherry



**49904**  
Shown in  
maple



**49955**  
Shown in sapele  
mahogany and  
Douglas fir



**49908**  
Shown in  
Douglas fir



**49920**  
Shown in  
Douglas fir  
and sapele  
mahogany



**49923**  
Shown in  
walnut and  
cherry

## Door Profiles

Raised L. Moulding (Standard)

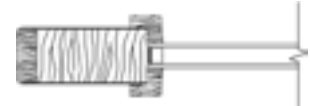

Shaker Flush (Optional)

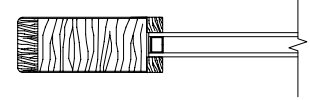

## Personalize your flush door.

- Make your flush door any size, height, width, or thickness.
- Order the windows' size, shape and placement to your exact specifications.
- Choose from dozens of wood species, all with slip-matched veneers on the door's face.
- Combine different woods or orient veneers to your design requirement.
- Add grooves to your door to create an entirely different feel.

## Engineered for long-lasting performance.

- Stave core made with finger-jointed Douglas fir creates incredible strength and stability.
- Core material and stiles-and-rails held in place by dado joint around entire door.
- Stiles-and-rails dowel-pinned at all joints.
- All component surfaces are coated with glue, not just select parts of the door.
- Select optional UltraBlock® technology for the bottom of stile components, which replaces exposed end grain with composite and upgrades the door's warranty to 5 years.
- Optional WaterBarrier® technology incorporates a medium density overlay over the exterior surface of the door. So get the look and wood you want on the inside with the protection you need on the outside. 5-year warranty with no overhang requirement.

## Cutaway View

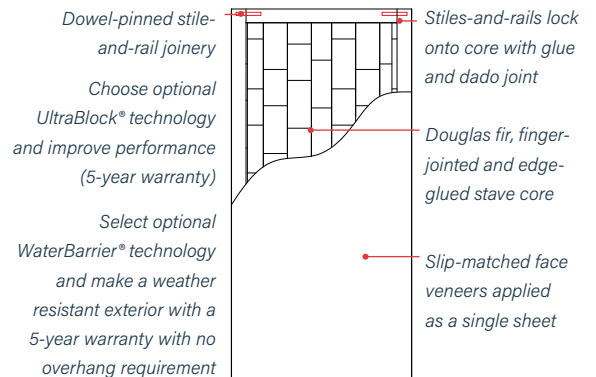

## V-Groove Cutaway View

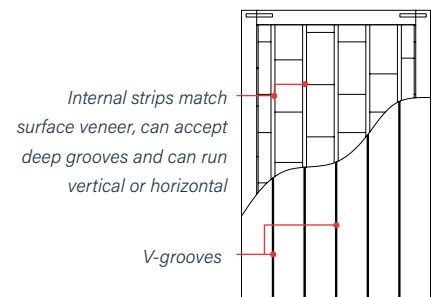

Proudly Distributed By

**RIVER CITY  
MILLWORK**

**Simpson®**  
Door Company



# French Doors With Internal Blinds

Scan for  
More Information



*Simple finger-touch  
operating mechanism*

Simpson design #7102 French door with internal blinds lets you control the view and privacy at the touch of a finger. The easy operation allows you to tilt the blinds open or closed, plus you can raise or lower the blind. And since the blinds are protected on both sides by glass, they never collect dust or become damaged. No more cords to pull and no more blinds banging against the door each time you open it. Just perfect control and a beautiful appearance.

## Specifications for Door Design 7102

- Available in any wood species
- Comes standard with UltraBlock® technology – 5-year warranty
- Available with WaterBarrier® technology – 5-year warranty with no overhang requirement
- Glass unit is 1" thick and comes standard with Low-E
- Available Sizes
  - » Thickness: 1-3/4"
  - » Width: 2'2", 2'4", 2'6", 2'8", 2'10", 3'0", 3'2", 3'4", 3'6"
  - » Heights: 6'8", 7'0", 8'0" (8'0" height features 1-7/16" raised panel as standard or 3/4" flat panel option)

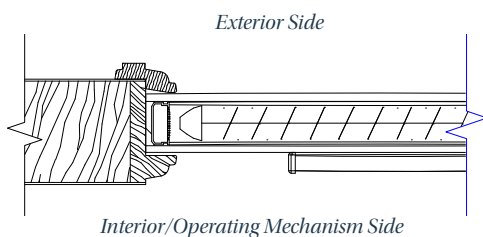

Exterior View with  
Closed Blind

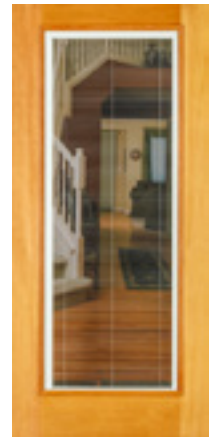

Exterior View with  
Blinds Tilted

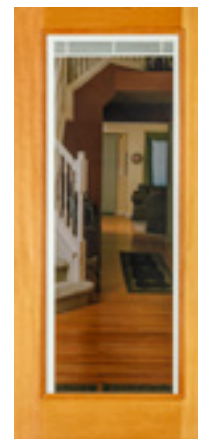

Exterior View with  
Blinds Fully Open

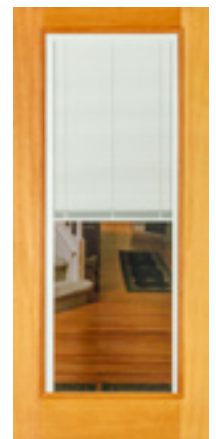

Exterior View with  
Blinds Open Half Way

Proudly Distributed By

**RIVER CITY  
MILLWORK**

**Simpson®**  
Door Company

# Impact-Rated Doors



Simpson now offers hundreds of impact-rated exterior doors, suitable for coastal applications that require it. Please note: these doors do not have HVHZ approval at this time.

**Specifications:**

- Labeled Prehung Units available both assembled and knocked down (KD)
- Impact-rated slabs available for specialty prehangs
- Choose any design from Simpson’s exterior door offering
- Available in any wood type
- Impact-rated IG used with many textures available, including turtle glass
- Profiles available: ovolo, shaker, bevel
- Panel types: available in any profile/raise
- All doors offered 2-1/4” thick
- Inswing Single Doors
  - » Max Unit or Slab-Only Size, All-Panel Doors: 3’6” x 9’0”
  - » Max Unit or Slab-Only Size, Doors with Glass: 3’6” x 9’0”
- Outswing Single Doors
  - » Max Unit Size (All doors): 4’0” x 10’0”
  - » Max Slab-Only Size: 4’0” x 10’0”
- Inswing Double Doors (Square Top Only)
  - » Max Unit Size: 7’0” x 9’0”
- Outswing Double Doors
  - » Max Unit Size, Square Top Doors: 8’0” x 10’0”
  - » Max Unit Size, Arch and Radius Top Doors: 7’0” x 10’0”
- Sidelights and Transoms
  - » Can be added to any single or double door unit
  - » Arched and elliptical transoms available
  - » Max Sidelight Size: 3’0” x 8’0”
  - » Max Transom Size: 6’0” x 3’0”
- Multi-Point Locks\*
  - » Required for all impact-rated doors
  - » Choose from Hoppe 9000 or Endura Trillanium brands
  - » Single door units = 3-point (Tongue top, tongue bottom, deadbolt)
  - » Double Door Units = 5-point (Tongue top, tongue bottom, shootbolts head and sill, deadbolt for active door. Tongue top, tongue bottom for inactive door)
- Sills
  - » All units provided with composite adjustable sill (standard) or solid wood sill (option)

## NAMI

NAMI certified and approved for all coastal areas from Maine to Texas (except HVHZ)



Florida Code Report,  
#FL9668, #FL23102,  
#FL39328, #FL39330

Proudly Distributed By



# Selecting The Right Door For The Exposure

Scan for  
More Information



## Know Your Overhang

When it comes to high-performance exterior wood doors, Simpson has you covered. And when you are selecting an exterior door, make sure you are selecting the right type of door for that door's exposure to the elements.

### Yes, My Door Has Adequate Overhang- So I Can Select Any Design

See drawing at right for what is considered an adequate overhang. If your door opening has this type of protection or more, you can select any type of Simpson exterior door and in any wood type. And when your door has UltraBlock® Technology, it will also feature a 5-year warranty.

### No, My Door Does Not Have Adequate Overhang-I Should Select Either Nantucket Collection™ Doors or doors with WaterBarrier® Technology

If your door does not have an adequate overhang, Simpson has options for you. Select either the WaterBarrier technology upgrade for any exterior door or select a door from the Nantucket Collection. These offerings are engineered and built to withstand the weather and provide a full warranty in any type of exposure. Doors with WaterBarrier technology carry a 5-year warranty and Nantucket Collection doors carry a 10-year warranty, all with no overhang required.



$$X \geq 1/2 Y$$

Figure 1: where X is the length of the overhang required and Y is the distance from the bottom of the door to the base of the overhang.

## Options For Doors Without An Adequate Overhang

### Nantucket Collection™

#### Standard Joinery

##### Solid Two-Piece Mortised Rail

(Available in Western Hemlock, Douglas Fir, Sapele Mahogany or Nootka Cypress)

##### Solid Two-Piece Mortised Stile

(Available in Western Hemlock, Douglas Fir, Sapele Mahogany or Nootka Cypress)



### WaterBarrier® Technology

Water-resistant glazing bead and SDL bars on exterior side. Wood bars on interior side.

Primed Medium Density Overlay for flat surfaces

Innerbond® double hip-raised panels have a water-resistant primer

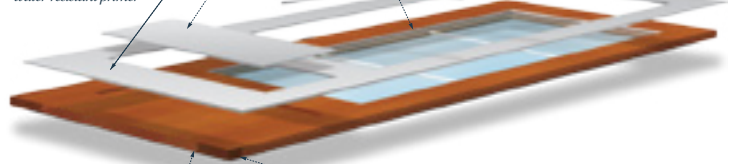

#### Weather Seal™ Process

Entire stile-and-rail joints coated and bonded to decrease the possibility of water infiltration

#### UltraBlock® Technology

Composite block material finger-jointed into the bottom of the stiles

#### Optional Joinery

##### Solid Two-Piece Mortised Rail

(Available in Western Hemlock, Douglas Fir, Sapele Mahogany or Nootka Cypress)

##### Solid Two-Piece Mortised Stile

(Available in Western Hemlock, Douglas Fir, Sapele Mahogany or Nootka Cypress)

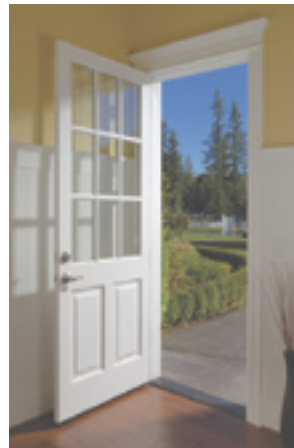

Proudly Distributed By

**RIVER CITY  
MILLWORK**

**Simpson®**  
Door Company

# Matching Millwork for Your Simpson Door

Scan for  
More Information



A Simpson door looks good no matter where you put it or what jamb you put it with. But wouldn't it look better if it had a matching Simpson jamb, casing, astragals and mull posts? Contact your Simpson door supplier to order your Simpson millwork, available in virtually any profile, size and wood species. And quote Simpson millwork today by visiting Simpson EZQ.

- Order matching Simpson millwork with your Simpson door.
- Choose from a wide selection of jambs, casing, astragals and mull posts.
- Available in virtually any size, including for unusual retro or new home projects.
- Choose jambs for doors 2-1/4", 1-3/4" or 1-3/8" thick.
- Available in any wood species including unusual hardwoods, ensuring a perfect match to your door.
- Arch, round and other shapes available, ensuring a perfect match to your arch or round top door.

## Frames and Jambs



**10000  
DOUBLE RABBET**

1-1/4" x 4-9/16"  
1-1/4" x 5-1/4"  
1-1/4" x 6-9/16"  
Also available for  
2-1/4" thick doors



**10001  
SINGLE RABBET**

1-1/4" x 4-9/16"  
1-1/4" x 5-1/4"  
1-1/4" x 6-9/16"  
Also available for  
2-1/4" thick doors



**10002  
SINGLE RABBET KERFED**

1-1/4" x 4-9/16"  
1-1/4" x 5-1/4"  
1-1/4" x 6-9/16"  
Also available for 2-1/4"  
thick doors

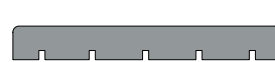

**10003  
FLAT JAMB**

11/16" x 4-9/16"  
11/16" x 5-1/4"  
11/16" x 6-9/16"

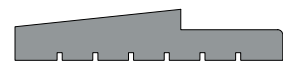

**10004  
TRANSOM SILL**

1-1/4" x 6-9/16"

## Brickmould and Casings



**10020**  
1-1/4" x 2"



**10021**  
11/16" x 3-1/4"



**10022**  
9/16" x 3-1/4"



**10023**  
1" x 5-1/4"



**10024**  
11/16" x 2-1/4"



**10025**  
11/16" x 3-1/2"



**10026**  
11/16" x 3-1/4"

Proudly Distributed By

**RIVER CITY  
MILLWORK**

**Simpson®**  
Door Company



## Supersize Any Simpson Design to an Extra Large Monster Door®

Simpson has taken door personalization to new heights with its Monster Doors®. Any Simpson design can be made at any size, which could be a perfect fit for a special space in the home.

- Available up to 10 feet tall and 8 feet wide (Confirm the max available size for your specific design with your Simpson Authorized Dealer)
- Each door engineered for best stability and performance
- Perfect for doors on barn track or with pivot hardware
- There are no design restrictions when working with Simpson on your door projects



**Monster Door® 49801**

*Shown in red oak with factory finish (weathered with gray finish)*



**Monster Door® 7404**

*Shown in hemlock with white laminate glass*



**Monster Door® 49853**

*Shown in knotty alder with factory finish (weathered with gray finish)*

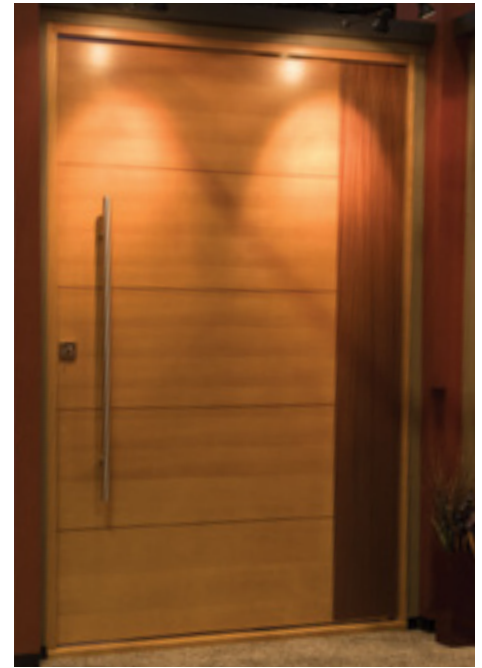

**Monster Door® 49920**

*Shown in Douglas fir and sapele with custom inlays*

*PLEASE NOTE. All Monster Doors include Simpson's standard warranty. That warranty does not cover warp on a door over 3'6" x 8'0".*

Proudly Distributed By

**RIVER CITY  
MILLWORK**

**Simpson®**  
Door Company



## Unbeatable Construction

- Mortise-and-tenon joinery with face-driven pins
- Two-piece laminated stile-and-rail construction
- Divided lite doors made with SDL construction
- Design pressure ratings of DP50 (additional hardware may be required in some applications)

## Wood Species Options

- Available in Western Hemlock, Douglas Fir, Sapele Mahogany and Nootka Cypress
- Hardwood tenon and matching species face pins

## Design Options

- Thickness - 1-3/4" or 2-1/4"
- Sticking Profiles - Shaker or Ovolo
- Panel Options - 1-7/16" Innerbond® double hip-raised panel or 3/4" flat panel
- Nantucket Collection doors come standard with a face pin with an option for no face pin

## Extended Warranty

- 10-year warranty on all Nantucket Collection doors
- No building overhang required. Refer to "High Exposure" finishing recommendations for best performance.

## Available Wood Species



WESTERN HEMLOCK



DOUGLAS FIR



SAPELE MAHOGANY



NOOTKA CYPRESS

## Profile Options

Ovolo with 1/16" Innerbond®  
Double Hip-Raised Panel (RP)

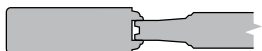

Ovolo with 3/4" Flat Panel (FP)

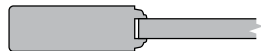

Shaker with 3/4" Flat Panel (FP)

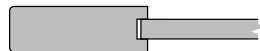

Ovolo SDL Construction



Shaker SDL Construction

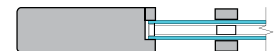

## Standard Joinery

### Solid Two-Piece Mortised Rail

(Available in Western Hemlock, Douglas Fir, Sapele Mahogany or Nootka Cypress)

### Solid Two-Piece Mortised Stile

(Available in Western Hemlock, Douglas Fir, Sapele Mahogany or Nootka Cypress)

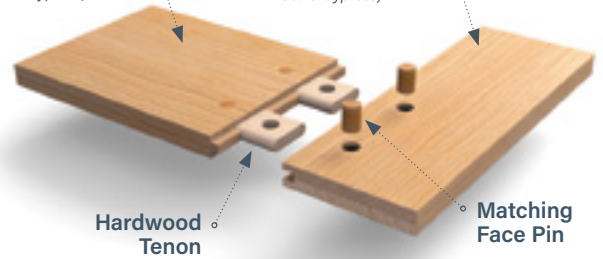

## Optional Joinery

### Solid Two-Piece Mortised Rail

(Available in Western Hemlock, Douglas Fir, Sapele Mahogany or Nootka Cypress)

### Solid Two-Piece Mortised Stile

(Available in Western Hemlock, Douglas Fir, Sapele Mahogany or Nootka Cypress)



# Panel and Groove Options

Simpson can make any door with any sticking profile and panel option your customer can dream up. The following panel profiles and groove options are available to you when quoting on Simpson EZQ. If you require a different panel profile for your project, provide those requirements to your Simpson supplier for a custom quote.

## Panel Options



1-7/16" Innerbond®  
DHRP



1-7/16" Innerbond®  
Scoop SHRP



1-7/16" Caprice  
DHRP



1-3/4" Innerbond®  
DHRP



1-5/16" Panel with  
Bevel Raised Edge



1-5/16" SHRP

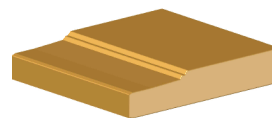

1-1/16" DHRP One Side,  
Flat Panel One Side

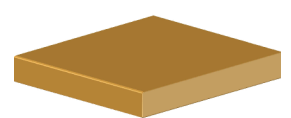

3/4" Flat Panel

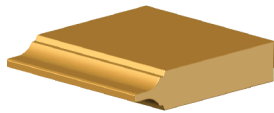

1-1/4" Innerbond®  
DHRP

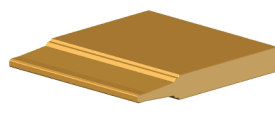

3/4" DHRP

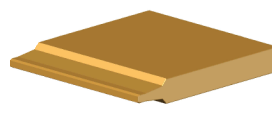

3/4" SHRP



3/4" Scoop SHRP



9/16" SHRP

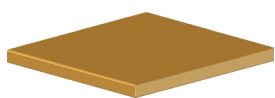

3/8" Flat Panel

## Groove Options



V (1/4")  
*Most Commonly Requested*



Large Beaded (3/4")



Square Beaded (7/16")



Standard Beaded (5/16")  
*Standard on Bungalow Series® Doors*



Round Over (1/8")



Square (1/8")  
*Standard on Artist Collection® Doors*



Square V (1/2")  
*Standard on Barn Doors*



Double V (1/2")



Big Square (1/4")

Proudly Distributed By

**RIVER CITY  
MILLWORK**

**Simpson®**  
Door Company

# PIVOT DOOR SYSTEM



## NEW PRODUCT — NOW AVAILABLE

### UNMATCHED VISUAL IMPACT

- Make a statement with a Monster XL-size door for the entry or special space in the home.
- Select from sizes 3'6" to 5'0" in width and heights up to 10'0". All exterior pivot doors are 2-1/4" thick and interior pivot doors can be 1-3/4" or 2-1/4".
- Door rotates around a pivot hinge as an inswing door unit.
- Can be combined with virtually any door design for architectural consistency in your project.

### PERFORMANCE & SECURITY

- Multipoint locking system assures door stays straight and secure, backed by a warranty against warp.\* Multipoint enacts with a key or thumb turn.
- Unique party latch system keeps door closed without handle operation. You can use door pulls on each side for a clean and contemporary look.
- Sealing system ensures energy efficiency for exterior doors:
  - Weatherstrip on each side of door
  - Top of door sealed with double brush system
  - Bottom of door sealed with brush system
- Your choice of low-profile sill:
  - ADA aluminum sill in mill or bronze finish with UltraBlock® substrate
  - Wood sills offered in sapele mahogany and red oak
  - No sill option for interior doors

### NO HASSLE INSTALLATION

- Install in a new or existing opening, supported by how-to installation videos.
- All hinge and locking mechanisms are located within the door itself. Threshold and header plates are installed in the frame. Nothing to be placed into the subfloor or header.
- Low-profile hinge plate to be installed in floor for interior applications.
- Final speed and latching adjustments done easily after door is operational with included installation toolkit.

### EASY, ADJUSTABLE OPERATION

- Monster XL-size pivot doors easily open and close with the touch of a finger.
- Adjustments included for door operating speed, soft close/latch and safety/damper capabilities.
- Operation can be customized to the homeowner.



Proudly Distributed By

**RIVER CITY  
MILLWORK**

[www.rivercitymillwork.com/warranties](http://www.rivercitymillwork.com/warranties)



# Plantation Louver Doors

Scan for  
More Information



- Wide 2-1/4" Louver slats for a classic look
- 5 standard door designs or create your own custom design
- Available in a variety of wood types and in any size
- Choose from 1-3/8" or 1-3/4" thickness

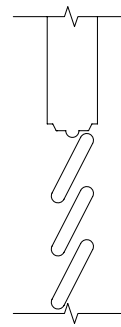

**STANDARD VENTED LOUVER**  
Available in 1-3/8" and 1-3/4"

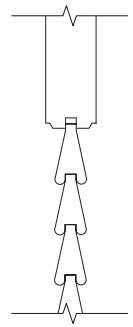

**OPTIONAL CHEVRON NON-VENTED LOUVER**  
Available in 1-3/4" only

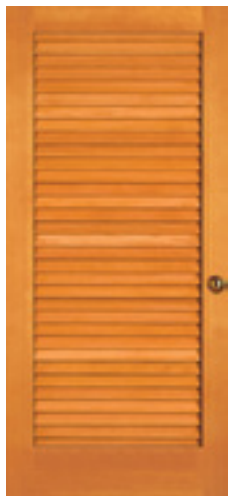
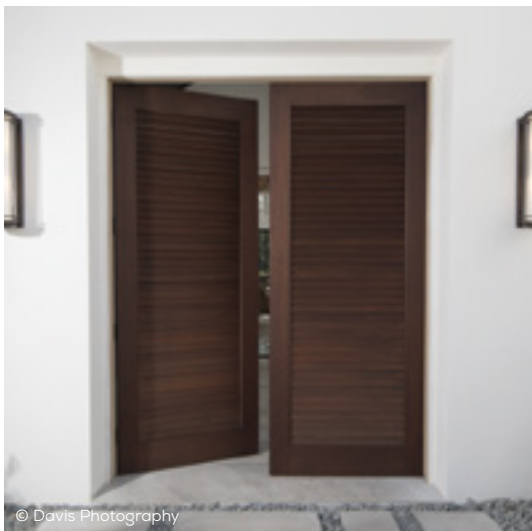

1290  
shown in Douglas Fir



1292  
shown in Sapele Mahogany

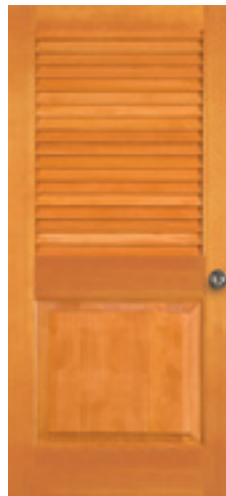

1291  
Louver over panel  
shown in Douglas Fir

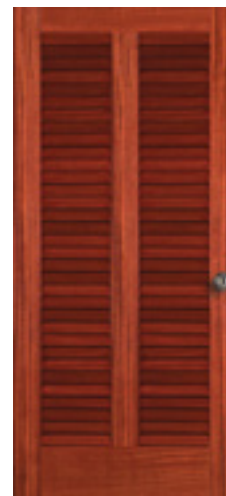

1294  
shown in Sapele Mahogany



1293  
shown in Douglas Fir

Proudly Distributed By

**RIVER CITY  
MILLWORK**

**Simpson®**  
Door Company

# Rustic Barn Doors

Scan for  
More Information



Create a natural showpiece in your home with the honest, raw beauty of a rustic interior barn door from Simpson. These distressed doors provide warmth and character for that distinctive rustic feel.

## Achieve a Rustic Barn Door One of Two Ways:

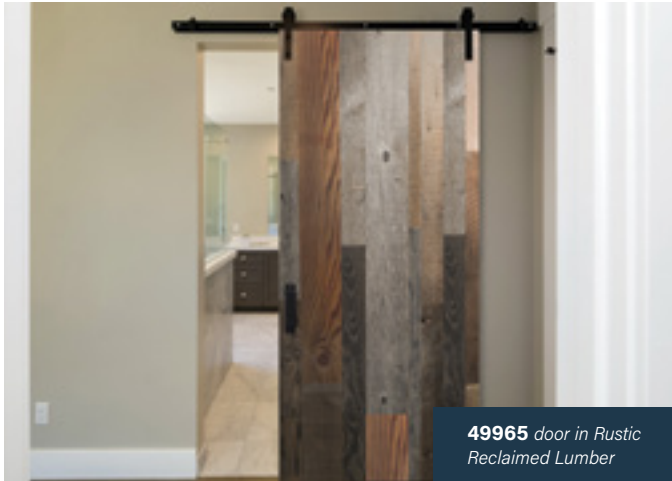

**49965** door in Rustic Reclaimed Lumber



**80812** door in Knotty Alder

### Option 1:

#### A Door Using Reclaimed Lumber

- Using salvaged wood from an existing structure, our craftsmen will band saw the lumber, smooth any rough edges and apply to the face of a door.
- 10-year interior door warranty

### Option 2:

#### Add a "Weathered With Gray" Factory Finish

- Start with any Simpson barn door and add a "weathered with gray" factory-finish. It immediately gives it an aged look and looks best when paired with a door made of knotty alder.
- 10-year interior door warranty



**49965**

**49966**



**80801**

Knotty Alder with factory finish

**80815**

Knotty Alder with factory finish

Proudly Distributed By

**RIVER CITY  
MILLWORK**

**Simpson®**  
Door Company

# Factory Finish for Interior Barn Doors

Scan for  
More Information



Give your interior barn doors that finishing touch by adding a pop of color. It's the timeless look of a barn door, but with a contemporary, colorful twist.

Choose from 6 standard paint colors or select a custom color by providing a Sherwin Williams color number. Or create the "off an old barn" look by selecting one of the weathered options.

## Paint Options



**SW 9176**  
Dress Blues



**SW 6258**  
Tricorn Black



**SW 6258**  
Ellie Gray

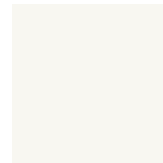

**SW 7757**  
High Reflective White



**SW 6869**  
Stop Red



**SW 6959**  
Blue Chip



**49812**  
Shown in Dress Blues



**49812**  
Shown in Tricorn Black



**49812**  
Shown in Ellie Gray



**49812**  
Shown in Knotty Alder Weathered with Gray Finish



**49812**  
Shown in High Reflective White



**49812**  
Shown in Stop Red



**49812**  
Shown in Blue Chip



**49812**  
Shown in Knotty Alder With Clear Coat Finish



## Weathered Options

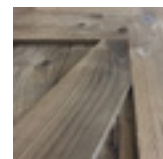

**Weathered**  
With Gray Finish



**Weathered**  
No Finish

Proudly Distributed By

**RIVER CITY  
MILLWORK**

**Simpson®**  
Door Company

# Redi-Prime® Premium Flush Interior Doors

Scan for  
More Information



Simpson Redi-Prime® is one of today's most recognized brands for painted interior doors. And new to the Redi-Prime product line is Premium Flush Interior Doors. These doors feature a 1/4" MDF veneer over a wood stile, rail and lattice core substrate, ensuring structural support with less mass than a solid core flush door. These doors will fit perfectly in both new contemporary construction and mid/mod remodels. Get your premium flush doors either in local inventory or through Simpson's Redi-Ship® Program.

## SPECIFICATIONS

- Available in the most requested interior door widths in both 6'8" and 8'0" height
- 1/4" thick MDF veneer over wood stile, rail and wood lattice core
- Grooves are 9/16" wide and 1/16" deep for a dramatic appearance
- Wide internal stiles to satisfy your hardware requirements
- Factory double-primed and sanded
- 10-year warranty
- For a full list of available designs and sizes, visit [simpsondoor.com/rediship](http://simpsondoor.com/rediship)

**Groove Detail** 9/16" wide x 1/16" deep

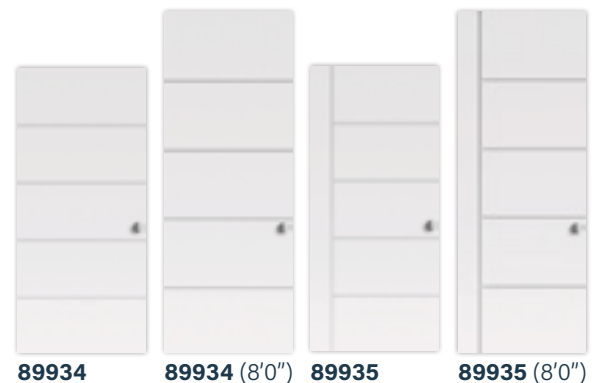
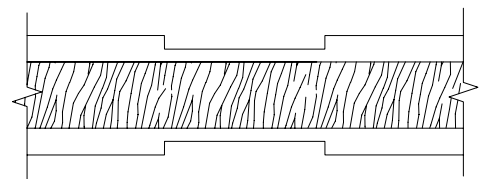

Proudly Distributed By

**RIVER CITY  
MILLWORK**

**Simpson®**  
Door Company

# Redi-Prime® Interior Doors

Scan for  
More Information

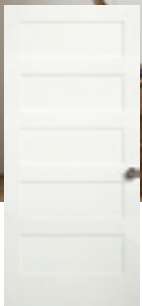

**Shaker Flat Panel**  
8755



**Shaker French**  
8733



**Ovolo Flat Panel**  
8020



**Ovolo Raised Panel**  
80465 with  
V-groove Option



**Ovolo French**  
8001



**Barn-Style**  
89812

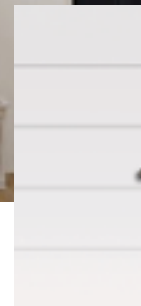

**Premium Flush**  
89934

**Simpson Redi-Prime® is one of today's most recognized brands for painted interior doors.** The method of construction and internal components are the same as Simpson wood doors. And when combined with MDF veneers on stile and rail surfaces, solid MDF panels and an impeccable priming process, the result is an architecturally-beautiful, long-lasting interior painted door. Choose from a variety of panel and French designs, all available either in local inventory or through Simpson's Redi-Ship® Program.

- Proven value compared to other painted interior doors
- Engineered stiles and rails with 1/8" thick MDF veneer over finger-jointed wood core
- Solid MDF panels
- Factory double-primed and sanded
- Available in all widths to meet your interior door needs

- Choose from 6'8", 7'0" and 8'0" heights
- Special sizes, designs and shapes can be manufactured to complete your house pack
- Flat Panel Doors – 3/8" thick flat panel with either shaker or ovolo sticking profile, and matching 20-minute fire-rated doors available
- Premium Flush Doors – 1/4" thick veneer over lattice wood core with 9/16" wide x 1/16" deep square grooves
- French doors – dozens of glass types available with either ovolo or shaker quirk sticking
- All designs available 1-3/8" thick with a growing inventory of 1-3/4" thick doors
- 10-year warranty

For a full list of available designs and sizes, visit [simpsondoor.com/rediship](http://simpsondoor.com/rediship).

Proudly Distributed By

**RIVER CITY  
MILLWORK**

**Simpson®**  
Door Company

# Redi-Prime® Raised Panel Interior Doors

Scan for  
More Information



**Simpson Redi-Prime® is one of today's most recognized brands for painted interior doors.** The method of construction and internal components are the same as Simpson wood doors. And when combined with MDF veneers on stile and rail surfaces, solid MDF panels and an impeccable priming process, the result is an architecturally-beautiful, long-lasting interior painted door.

Redi-Prime is also a proven value when compared to solid moulded skin interior doors. Choose from a variety of panel and French designs, all available either in local inventory or through Simpson's Redi-Ship® Program.

## RAISED PANEL DOOR SPECIFICATIONS

- In stock in all interior doors widths, in both 6'8" and 8'0" heights
- Special sizes, designs and shapes can be manufactured to complete your house pack
- Engineered stiles and rails with 1/8" thick MDF veneer over finger-jointed wood core
- Solid, 3/4" thick double hip-raised MDF panels with v-groove option
- Factory double-primed and sanded
- 10-year warranty
- For a full list of available designs and sizes in stock, and to view the entire Redi-Prime product line, visit [simpsondoor.com/rediship](http://simpsondoor.com/rediship)



**8082** Raised Panel  
**8043 Bifold** Raised Panel  
**80465** Raised Panel shown with V-Groove option  
**8045 Bifold** Raised Panel



**8082 (8'0")** Raised Panel shown with V-Groove option  
**80465 (8'0")** Raised Panel  
**8055 (8'0")** Raised Panel  
**8055** Raised Panel

## Redi-Prime Raised Panel Profiles

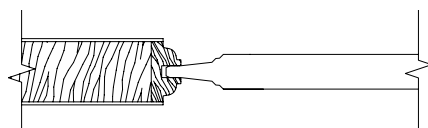

Standard Construction

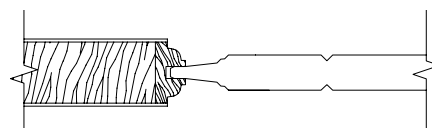

V-Groove Option

Proudly Distributed By

**RIVER CITY  
MILLWORK**

**Simpson®**  
Door Company

# SDL vs. TDL For My Exterior Door - How Do I Choose?

Scan for More Information



Simpson has been manufacturing divided lite doors for over a century and provides two basic construction types for exterior doors: Simulated Divided Lite (SDL) and True Divided Lite (TDL). When used with clear glass, it is virtually impossible for a homeowner to tell the difference. So what is the difference, and why should it matter when you order a Simpson door? Check out the reasons below.



## SIMULATED DIVIDED LITE (SDL)

Features a single glass unit with bars applied to the glass surface.

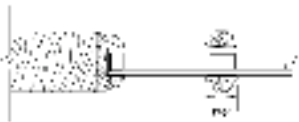

SDL WITH IG IN OVOLO PROFILE

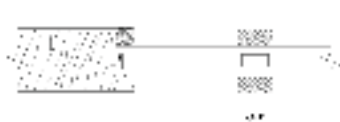

SDL WITH IG IN SHAKER PROFILE

## TRUE DIVIDED LITE (TDL)

Features multiple glass units divided by muntin bars.



TDL WITH IG IN OVOLO PROFILE



TDL WITH IG IN SHAKER PROFILE

✓	<b>Simpson Recommends</b>	
7/8"	<b>Standard Bar Width</b>	1-3/8" (Ovolo), 1-5/8" (Shaker)
✓ 1-3/8", 1-1/8"	<b>Optional Bar Widths</b>	N/A
✓ In 1 spot	<b>Tempered Glass Etching/Bug</b>	On each piece of glass
✓ One side of the door and only on the perimeter glass bead	<b>Nail Holes to Be Filled by Finisher</b>	One side of the door with multiple on each bar
✓	<b>Smooth to Semi-Smooth Surface Textures</b>	✓
Triple-Glazed between two pieces of clear glass, no shadow spacer	<b>Heavy Surface Textures</b>	Available
✓	<b>More Energy Efficient</b>	

FOR MORE INFORMATION, VISIT [SIMPSONDOOR.COM/DIVIDEDLITE](http://SIMPSONDOOR.COM/DIVIDEDLITE)

Proudly Distributed By

**RIVER CITY  
MILLWORK**

**Simpson®**  
Door Company

# Shaker Sticking Profile for 1<sup>3</sup>/<sub>4</sub>" Thick Doors with 3/4" IG



Shaker (square) sticking is one of the most popular door profiles today. The clean lines and classic look fit a number of architectural styles from Craftsman to Contemporary. In some environments, door professionals have been wary of installing a door with shaker sticking in an exterior application for fear of water pooling on the sticking surface. Simpson's solution is shaker sticking, with a gently sloped Waterfall® profile.

This profile allows water to cascade off the sticking and away from the door. And since the slope is moderate, it is hardly visible, resulting in a door that looks as good as it performs.

This profile comes standard on all 1<sup>3</sup>/<sub>4</sub>" thick doors that feature 3/4" insulated glass (IG). All other doors with shaker sticking will continue to use the Simpson standard square-shaped shaker sticking.

When prepping any type of shaker sticking for finishing, it is recommended that the edge of the sticking be eased slightly with sandpaper, to better encourage water runoff. For full care & finishing instructions, visit [simpsondoor.com/care-finishing/](http://simpsondoor.com/care-finishing/).

## SHAKER STICKING SPECIFICATIONS:

- Used on loose bead side of door
- Solid sticking side of door is true shaker (square profile)
- **Standard shaker sticking profile for doors 1 3/4" thick with 3/4" IG, which includes:**
  - All exterior doors with design numbers 6000 and higher
  - 4900 series door 1 3/4" thick with 3/4" IG

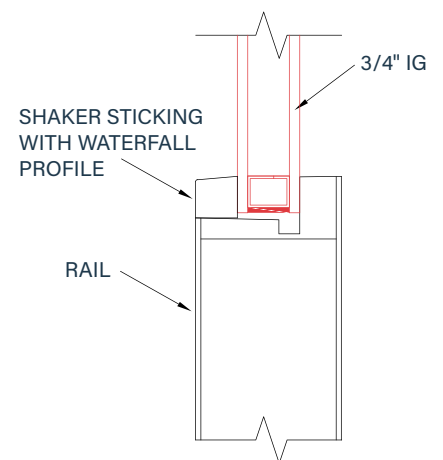
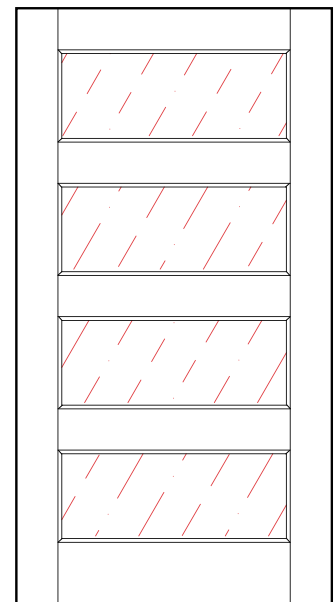

Proudly Distributed By

**RIVER CITY  
MILLWORK**

**Simpson®**  
Door Company



# Sticking Profile Options

Simpson can make any door with any sticking profile and panel option that your customer can dream up. The following sticking profiles are available to you when quoting on Simpson EZQ. If you require a different sticking profile for your project, provide those requirements to your Simpson supplier for a custom quote.



Ovolo Sticking



Shaker Sticking



Square Step Sticking



Bevel Sticking



Ogee Sticking



Quarter Round Sticking



Proudly Distributed By

**RIVER CITY  
MILLWORK**

**Simpson**<sup>®</sup>  
Door Company

# UltraBlock® Technology

Scan for  
More Information



A long time favorite of Simpson's most discriminating customers, UltraBlock® technology integrates a composite block into the bottom of the stiles, where water infiltration can occur. Our exclusive Weather Seal™ process provides additional protection against moisture penetrating the bottom of the door. It's our answer to the galoshes you splashed around in as a kid.

## PROVEN PROTECTION FOR YOUR DOOR

- Composite block material finger-jointed into the bottom of the stiles eliminates water infiltration
- Minimizes the possibility of stile and rail separation
- Eliminates bottom rail and lower stile decay
- Reduces buckling and swelling of bottom rail and lower stile components
- Improves warp resistance
- 5-year warranty
- Already a standard on most Simpson entry doors

## FLEXIBLE DESIGN OPTIONS

- UltraBlock can be used in any door 1¾" and 2¼" thick
- Protect all of your exterior doors including entry, side and patio
- Can be used in combination with any type of wood

## ULTRABLOCK COMES STANDARD ON DOORS FROM THE FOLLOWING SIMPSON ENTRY DOOR PRODUCT LINES:

- Mastermark® Collection
- Craftsman Collection
- Bungalow Series®
- Builder's Advantage Series®
- Selects Series
- Exterior Barn Doors



Proudly Distributed By

**RIVER CITY  
MILLWORK**

**Simpson®**  
Door Company

# Utility Doors For Tough Exposures

Scan for  
More Information



- Beautiful solution for back doors and side doors where there is no overhang protection
- Choose any design in any wood species to match interior millwork
- Protected with WaterBarrier® technology on the outside — 5-year warranty

## PROVEN TRACK RECORD OF PERFORMANCE

- The overlay in WaterBarrier technology is commonly used for street signs and concrete forms
- Minimizes the possibility of stile-and-rail separation
- Excellent durability and resists moisture absorption
- 5-year warranty, no overhang required

## FLEXIBLE DESIGN OPTIONS

- Can be ordered in virtually any door design for a variety of exterior applications, including entry, side and patio doors
- Available for use with any wood species
- Overlay has thermoset acrylic latex primer topcoat, resulting in superior paint application

All doors with WaterBarrier come standard with UltraBlock® technology and Weather Seal™ process at stile-and-rail joints.

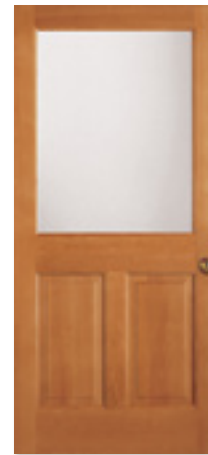

37944 WB INTERIOR



7044 WB EXTERIOR

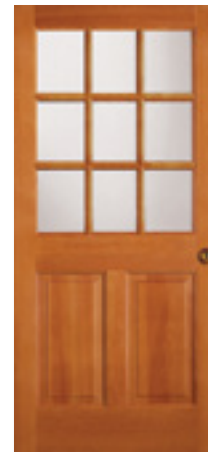

37944 WB INTERIOR

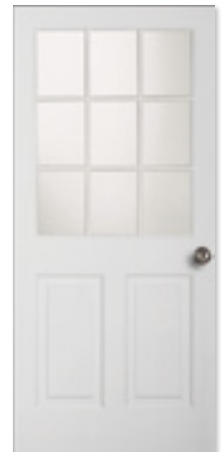

37944 WB EXTERIOR

## WATERBARRIER® TECHNOLOGY

*PVC glazing bead and SDL bars on exterior side. Wood bars on interior side.*

*Primed Medium Density Overlay for flat surfaces*

*Innerbond® double hip-raised panels have a water-resistant primer*

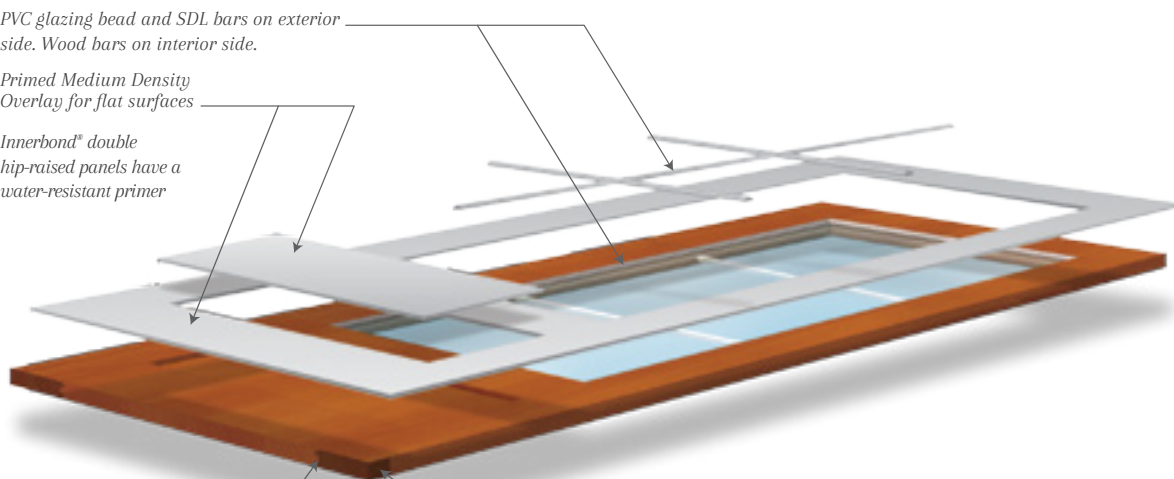

### WEATHER SEAL™ PROCESS

*Entire stile-and-rail joints coated and bonded to decrease the possibility of water infiltration*

### ULTRABLOCK® TECHNOLOGY

*Composite block material finger-jointed into the bottom of the stiles*

Proudly Distributed By

**RIVER CITY  
MILLWORK**

**Simpson**  
Door Company

# WaterBarrier® Technology

Scan for  
More Information



WaterBarrier® combines a medium density overlay (MDO) over the exterior surface of the door with water-resistant glazing beads and bars for an exterior that's not only resistant to moisture, but provides a beautiful surface for paint. And when combined with any wood species on the inside, you can match your interior woodwork and keep the warmth and natural beauty that wood provides.

## PROVEN TRACK RECORD OF PERFORMANCE

- The overlay in WaterBarrier technology is commonly used for street signs and concrete forms
- Minimizes the possibility of stile-and-rail separation
- Excellent durability and resists moisture absorption
- 5-year warranty, no overhang required

## FLEXIBLE DESIGN OPTIONS

- Can be ordered in virtually any door design for a variety of exterior applications, including entry, side and patio doors
- Available for use with any wood species
- Overlay has thermoset acrylic latex primer topcoat, resulting in superior paint application

All doors with WaterBarrier come standard with UltraBlock® technology and our Weather Seal™ process at stile and rail joints.

**STANDARD OVOLO PROFILE WITH WATERBARRIER® TECHNOLOGY**

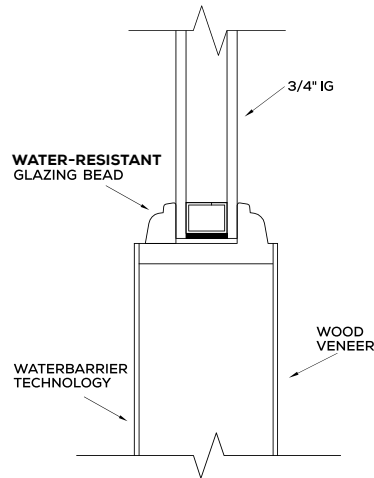

**OPTIONAL SHAKER PROFILE WITH WATERBARRIER® TECHNOLOGY**

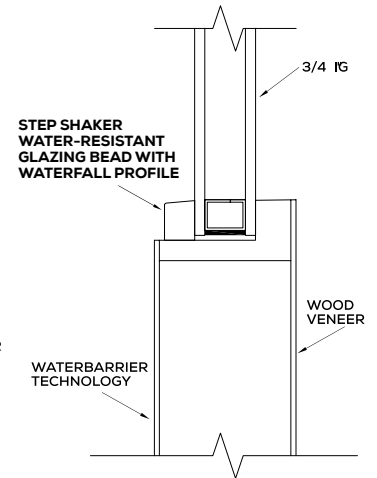

**STANDARD OVOLO BAR PROFILE**

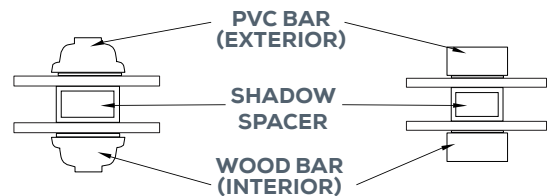

**OPTIONAL SHAKER BAR PROFILE**



## WATERBARRIER® TECHNOLOGY

PVC glazing bead and SDL bars on exterior side. Wood bars on interior side.

Primed Medium Density Overlay for flat surfaces

Innerbond® double hip-raised panels have a water-resistant primer

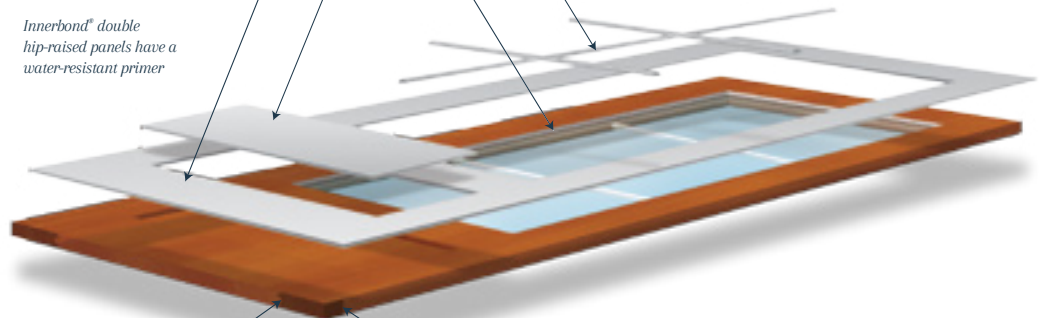

**WEATHER SEAL™ PROCESS**

Entire stile-and-rail joints coated and bonded to decrease the possibility of water infiltration

**ULTRABLOCK® TECHNOLOGY**

Composite block material finger-jointed into the bottom of the stiles

Proudly Distributed By

**RIVER CITY  
MILLWORK**

**Simpson®**  
Door Company